

Aspire 5349, 5749 & 5749Z

# SERVICEGUIDE

The Acer logo is located at the bottom right of the page. It consists of the word "acer" in a white, lowercase, italicized sans-serif font. A thin white curved line is visible above the logo, extending across the width of the page.

*acer*

## Revision History

Refer to the table below for the updates made to this service guide.

Date	Chapter	Updates

Service guide files and updates are available on the ACER/CSD Website. For more information, go to <http://csd.acer.com.tw>. The information in this guide is subject to change without notice.

## Copyright

Copyright © 2011 by Acer Incorporated. All rights reserved. No part of this publication may be reproduced, transmitted, transcribed, stored in a retrieval system, or translated into any language or computer language, in any form or by any means, electronic, mechanical, magnetic, optical, chemical, manual or otherwise, without the prior written permission of Acer Incorporated.

## Disclaimer

The information in this guide is subject to change without notice.

There are no representations or warranties, either expressed or implied, with respect to the contents hereof and specifically disclaims any warranties of merchantability or fitness for any particular purpose. The software described in this manual is sold or licensed "as is". Should the programs prove defective following their purchase, the buyer (not the manufacturer, distributor, or its dealer) assumes the entire cost of all necessary servicing, repair, and any incidental or consequential damages resulting from any defect in the software.

## Conventions

The following conventions are used in this manual:

### ⚠ **WARNING:**

Indicates a potential for personal injury.

### ⚠ **CAUTION:**

Indicates a potential loss of data or damage to equipment.

### + **IMPORTANT:**

Indicates information that is important to know for the proper completion of a procedure, choice of an option, or completing a task.

The following typographical conventions are used in this document:

- Book titles, directory names, file names, path names, and program/process names are shown in *italics*.

Example:

*the DRS5 User's Guide*

*/usr/local/bin/fd*

*the /TPH15spool\_M program*

- Computer output (text that represents information displayed on a computer screen, such as menus, prompts, responses to input, and error messages) are shown in constant width.

Example:

```
[01] The server has been stopped
```

- User input (text that represents information entered by a computer user, such as command names, option letters, and words) are shown in constant width bold.

Variables contained within user input are shown in angle brackets (< >).

Example:

At the prompt, type run **<file name> -m**

- Keyboard keys are shown in ***bold italics***.

Example:

After entering data, press ***Enter***.

# General Information

---

This service guide provides all technical information relating to the basic configuration for Acer's global product offering. To better fit local market requirements and enhance product competitiveness, the regional office may have decided to extend the functionality of a machine (such as add-on cards, modems, or extra memory capabilities). These localized features are not covered in this generic service guide. In such cases, contact the regional offices or the responsible personnel/channel to provide further technical details.

When ordering FRU parts: Check the most up-to-date information available on the Website. If, for whatever reason, a part number change is made, it may not be noted in this printed service guide.

Acer-authorized Service Providers: The Acer office may have a different part number code than those given in the FRU list in this service guide. A list must be provided by the regional Acer office to order FRU parts for repair and service of customer machines.

# CHAPTER 1

## Hardware Specifications

---

<b>Features</b> . . . . .	<b>1-5</b>
Operating System . . . . .	1-5
Platform . . . . .	1-5
System Memory . . . . .	1-5
Display . . . . .	1-5
Audio Subsystem . . . . .	1-5
Graphics . . . . .	1-6
Storage Subsystem . . . . .	1-6
Optical Media Drive . . . . .	1-6
Privacy Control . . . . .	1-6
Webcam . . . . .	1-6
Wireless and networking . . . . .	1-7
Dimension and Weight . . . . .	1-7
Power Adapter and Battery . . . . .	1-7
Input and Controls . . . . .	1-8
I/O Ports . . . . .	1-8
Optional Items . . . . .	1-8
Warranty . . . . .	1-8
Eco-compliance . . . . .	1-8
Environment . . . . .	1-9
Software . . . . .	1-10
<b>Notebook Tour</b> . . . . .	<b>1-11</b>
Touchpad Basics . . . . .	1-18
Using the Keyboard . . . . .	1-19
Windows Keys . . . . .	1-20
Hotkeys . . . . .	1-21
Using the communication key* . . . . .	1-22
<b>Specification Tables</b> . . . . .	<b>1-24</b>
Computer specifications . . . . .	1-24
Processor . . . . .	1-25
Processor Specifications . . . . .	1-26
CPU Fan True Value Table (TJ100-CPU) . . . . .	1-26
CPU Fan True Value Table (TJ85-CPU) . . . . .	1-27
System Memory . . . . .	1-27
Memory Combinations . . . . .	1-28
Video Interface . . . . .	1-28
BIOS . . . . .	1-28
LAN Interface . . . . .	1-29
Keyboard . . . . .	1-29
Hard Disk Drive (AVL components) . . . . .	1-30
LED 15.6" . . . . .	1-31
LCD Inverter (not available with this model) . . . . .	1-31

Display Supported Resolution (LCD Supported Resolution)	1-32
Display Supported Resolution (GPU Supported Resolution)	1-32
Mini Card	1-34
3G Card (not available in this model)	1-34
Audio Codec and Amplifier	1-35
Audio Interface	1-36
Battery	1-36
VRAM	1-37
USB Port	1-37
AC Adapter	1-37
System Power Management	1-38
Card Reader	1-38
System LED Indicator	1-39
System DMA Specification	1-39
System Interrupt Specification	1-40
System I/O Address Map	1-44
System I/O Address Map (Continued)	1-45

## CHAPTER 2

### System Utilities

---

<b>BIOS Setup Utility</b>	<b>2-3</b>
Navigating the BIOS Utility	2-3
<b>BIOS</b>	<b>2-4</b>
Information	2-4
Main	2-6
Advanced	2-8
Security	2-9
Power	2-13
Boot	2-14
Exit	2-15
<b>BIOS Flash Utilities</b>	<b>2-16</b>
DOS Flash Utility	2-17
WinFlash Utility	2-18
<b>Clearing BIOS Passwords</b>	<b>2-19</b>
Removing BIOS Passwords	2-20
Removing Insyde HDD Password	2-22
<b>Miscellaneous Tools</b>	<b>2-23</b>

Using DMITools. . . . .	2-23
Using STUUIID . . . . .	2-26
Using the LAN MAC EEPROM Utility. . . . .	2-27
Crisis Disk Recovery . . . . .	2-28

## **CHAPTER 3**

### **Machine Maintenance Procedures**

<b>Introduction . . . . .</b>	<b>3-5</b>
<b>General Information . . . . .</b>	<b>3-5</b>
<b>Recommended Equipment . . . . .</b>	<b>3-5</b>
<b>Maintenance Flowchart . . . . .</b>	<b>3-6</b>
<b>Getting Started. . . . .</b>	<b>3-7</b>
Battery Pack Removal. . . . .	3-8
Battery Pack Installation . . . . .	3-8
Dummy Card Removal . . . . .	3-9
Dummy Card Installation. . . . .	3-9
Keyboard Removal . . . . .	3-10
Keyboard Installation. . . . .	3-11
UpperCase Screws and FFC Removal . . . . .	3-12
UpperCase Screws and FFC Installation. . . . .	3-12
ODD (Optical Disk Drive) Module Removal . . . . .	3-13
ODD Module Installation. . . . .	3-14
Base Cover Removal . . . . .	3-15
Base Cover Installation. . . . .	3-15
USB Module Removal. . . . .	3-16
USB Module Installation . . . . .	3-17
HDD (Hard Disk Drive) Removal . . . . .	3-18
Hard Disk Drive Installation. . . . .	3-19
RTC (Real Time Clock) Battery Removal . . . . .	3-20
RTC Battery Installation . . . . .	3-20
WLAN (Wireless Local Area Network) Module Removal . . . . .	3-21
WLAN Module Installation . . . . .	3-23
Bluetooth Module Removal. . . . .	3-24
Bluetooth Module Installation . . . . .	3-25
Thermal Module Removal . . . . .	3-26
Thermal Module Installation . . . . .	3-27
Mainboard Removal. . . . .	3-29
Mainboard Installation . . . . .	3-30
CPU (Central Processing Unit) Removal . . . . .	3-31
CPU Installation . . . . .	3-32
PCH (Platform Controller Hub) Removal. . . . .	3-33

PCH Installation . . . . .	3-34
DIMM (Dual In-line Memory Module) Removal . . . . .	3-35
DIMM Installation. . . . .	3-36
Power Board Removal . . . . .	3-37
Power Board Installation . . . . .	3-38
DC-in Jack Removal . . . . .	3-39
DC-in Jack Installation . . . . .	3-40
Speakers Removal. . . . .	3-41
Speakers Installation . . . . .	3-41
LCD (Liquid Crystal Display) Module Removal . . . . .	3-42
LCD Module Installation . . . . .	3-43
LCD Bezel Removal. . . . .	3-44
LCD Bezel Installation . . . . .	3-45
Camera Module Removal. . . . .	3-46
Camera Module Installation . . . . .	3-47
LCD Panel Removal. . . . .	3-48
LCD Panel Installation . . . . .	3-49
LCD Hinge Removal . . . . .	3-50
LCD Hinge Installation . . . . .	3-50
LVDS Cable Removal . . . . .	3-51
LVDS Cable Installation . . . . .	3-52

## CHAPTER 4

### Troubleshooting

---

<b>Introduction . . . . .</b>	<b>4-3</b>
<b>General Information . . . . .</b>	<b>4-3</b>
Power On Issues . . . . .	4-4
No Display Issues. . . . .	4-5
LCD Failure . . . . .	4-8
Keyboard Failure . . . . .	4-9
Touchpad Failure . . . . .	4-10
Internal Speaker Failure. . . . .	4-11
Microphone Failure . . . . .	4-13
USB Failure . . . . .	4-14
Other Functions Failure . . . . .	4-15
<b>Intermittent Problems . . . . .</b>	<b>4-16</b>



<b>Undetermined Problems</b> .....	<b>4-16</b>
<b>Post Codes</b> .....	<b>4-17</b>

## **CHAPTER 5**

### **Jumper and Connector Locations**

<b>Mainboard Jumper and Connector Locations</b> .....	<b>5-3</b>
<b>Clearing Password Check and BIOS Recovery</b> .....	<b>5-5</b>
Clearing Password Check .....	5-5
Clear CMOS Jumper .....	5-6
BIOS Recovery by Crisis Disk .....	5-6

## **CHAPTER 6**

### **FRU (Field Replaceable Unit) List**

<b>Exploded Diagrams</b> .....	<b>6-4</b>
<b>FRU List</b> .....	<b>6-7</b>
<b>Screw List</b> .....	<b>6-16</b>

## **CHAPTER 7**

### **Model Definition and Configuration**

<b>Aspire 5349</b> .....	<b>7-1</b>
<b>Aspire 5749Z</b> .....	<b>7-3</b>
<b>Aspire 5749</b> .....	<b>7-5</b>

## **CHAPTER 8**

### **Test Compatible Components**

<b>Microsoft® Windows® 7 Environment Test</b> .....	<b>8-4</b>
---	------------

## **CHAPTER 9**

### **Online Support Information**

<b>Introduction</b> .....	<b>9-3</b>
---------------------------	------------



# CHAPTER 1

## Hardware Specifications

---

<b>Features</b> . . . . .	<b>1-5</b>
Operating System . . . . .	1-5
Platform . . . . .	1-5
System Memory . . . . .	1-5
Display . . . . .	1-5
Audio Subsystem . . . . .	1-5
Graphics . . . . .	1-6
Storage Subsystem . . . . .	1-6
Optical Media Drive . . . . .	1-6
Privacy Control . . . . .	1-6
Webcam . . . . .	1-6
Wireless and networking . . . . .	1-7
Dimension and Weight . . . . .	1-7
Power Adapter and Battery . . . . .	1-7
Input and Controls . . . . .	1-8
I/O Ports . . . . .	1-8
Optional Items . . . . .	1-8
Warranty . . . . .	1-8
Eco-compliance . . . . .	1-8
Environment . . . . .	1-9
Software . . . . .	1-10
<b>Notebook Tour</b> . . . . .	<b>1-11</b>
Touchpad Basics . . . . .	1-18
Using the Keyboard . . . . .	1-19
Windows Keys . . . . .	1-20
Hotkeys . . . . .	1-21
Using the communication key* . . . . .	1-22
<b>Specification Tables</b> . . . . .	<b>1-24</b>
Computer specifications . . . . .	1-24
Processor . . . . .	1-25
Processor Specifications . . . . .	1-26
CPU Fan True Value Table (TJ100-CPU) . . . . .	1-26
CPU Fan True Value Table (TJ85-CPU) . . . . .	1-27
System Memory . . . . .	1-27
Memory Combinations . . . . .	1-28
Video Interface . . . . .	1-28
BIOS . . . . .	1-28
LAN Interface . . . . .	1-29
Keyboard . . . . .	1-29
Hard Disk Drive (AVL components) . . . . .	1-30
LED 15.6" . . . . .	1-31
LCD Inverter (not available with this model) . . . . .	1-31
Display Supported Resolution (LCD Supported Resolution) . . . . .	1-32
Display Supported Resolution (GPU Supported Resolution) . . . . .	1-32
Mini Card . . . . .	1-34
3G Card (not available in this model) . . . . .	1-34
Audio Codec and Amplifier . . . . .	1-35
Audio Interface . . . . .	1-36

Battery . . . . .	1-36
VRAM. . . . .	1-37
USB Port. . . . .	1-37
AC Adapter . . . . .	1-37
System Power Management . . . . .	1-38
Card Reader. . . . .	1-38
System LED Indicator . . . . .	1-39
System DMA Specification . . . . .	1-39
System Interrupt Specification . . . . .	1-40
System I/O Address Map . . . . .	1-44
System I/O Address Map (Continued) . . . . .	1-45



# Hardware Specifications and Configurations

---

## Features

---

Below is a summary of the computer's features:

### Operating System

- Genuine Windows® 7 Home Basic 64-bit
- Genuine Windows® 7 Home Premium 64-bit

### Platform

#### **Aspire 5349**

- Intel® Celeron® processor B710/B800 (1 MB/2 MB L3 cache, 1.6 GHz/1.5 GHz, DDR3 1333 MHz, 35 W), supporting Intel® 64 architecture, Intel® Smart Cache
- Mobile Intel® HM65 Express Chipset

#### **Aspire 5749**

- Intel® Core™ i3-2310M/i3-2330M/i3-2350M processor (3 MB L3 cache, 2.10/2.20/2.30 GHz, DDR3 1333 MHz, 35 W), supporting Intel® 64 architecture, Intel® Smart Cache
- Mobile Intel® HM65 Express Chipset

#### **Aspire 5749Z**

- Intel® Pentium® processor B940/B950/B960 (2 MB L3 cache, 2/2.10/2.20 GHz, DDR3 1333 MHz, 35 W), supporting Intel® 64 architecture, Intel® Smart Cache
- Mobile Intel® HM65 Express Chipset

### System Memory

- Dual-channel DDR3 SDRAM support:
  - Up to 4 GB of DDR3 system memory, upgradable to 8 GB using two soDIMM modules

### Display

- 15.6" HD 1366 x 768 resolution, high-brightness (200-nit) Acer CineCrystal™ LED-backlit TFT LCD
- Mercury-free, environment-friendly
- 16:9 aspect ratio

### Audio Subsystem

- High-definition audio support

- Two built-in stereo speakers
- MS-Sound compatible
- Built-in microphone

## Graphics

Intel® HD Graphics with 128 MB of dedicated system memory, supporting Microsoft® DirectX® 10.1

- Dual independent display support
- 16.7 million colors
- External resolution / refresh rates:6
  - VGA port up to 2048 x 1536: 75 Hz
  - HDMI® port up to 1920 x 1080: 60 Hz
- MPEG-2/DVD decoding
- WMV9 (VC-1) and H.264 (AVC) decoding
- HDMI® (High-Definition Multimedia Interface) with HDCP (High-bandwidth Digital Content Protection) support

## Storage Subsystem

Hard disk drive:

- 250/320/500/640/750 GB or larger

2-in-1 card reader:

- Supports Secure Digital™ (SD) Card and MultiMediaCard™ (MMC)

## Optical Media Drive

8X DVD-Super Multi double-layer drive:

- Read: 24X CD-ROM, 24X CD-R, 24X CD-RW, 8X DVD-ROM, 8X DVD-R, 8X DVD+R, 6X DVD-ROM DL, 6X DVD-R DL, 6X DVD+R DL, 6X DVD-RW, 6X DVD+RW, 5X DVD-RAM
- Write: 24X CD-R, 16X CD-RW, 8X DVD-R, 8X DVD+R, 4X DVD-R DL, 4X DVD+R DL, 6X DVD-RW, 8X DVD+RW, 5X DVD-RAM

## Privacy Control

- BIOS user, supervisor, HDD passwords
- Kensington lock slot

## Webcam

Acer Video Conference, featuring:

- Acer Crystal Eye webcam



## Wireless and networking

### WLAN:

- Acer InviLink™ Nplify™ 802.11b/g/n Wi-Fi CERTIFIED™
- Supporting Acer SignalUp™ wireless technology

### WPAN:

- Bluetooth® 3.0+HS
- Bluetooth® 2.0/2.1+EDR

### LAN:

- Fast Ethernet, Wake-on-LAN ready

## Dimension and Weight

### Dimensions:

- 381 (W) x 253 (D) x 29.6/34.7 (H) mm (15 x 9.96 x 1.17/1.37 inches)

### Weight:

- 2.4 kg (5.29 lbs.)<sup>10</sup> with 6-cell battery pack

## Power Adapter and Battery

ACPI 3.0 CPU power management standard: supports Standby and Hibernation power-saving modes

### Power adapter:

- 3-pin 65 W AC adapter:
  - 95 (W) x 50 (D) x 25.4 (H) mm (3.74 x 1.96 x 1 inches)
  - 216 g (0.47 lbs.)<sup>10</sup> with 180 cm DC cable

### Battery:

- 48.8 Wh 4400 mAh 6-cell Li-ion standard battery pack
- Battery life: 4 hours
- ENERGY STAR®

## Input and Controls

### Keyboard

- 103-/104-/107-key Acer FineTip keyboard with independent standard numeric keypad, international language support

### Touchpad

- Multi-gesture touchpad, supporting two-finger scroll, pinch, rotate, flip

### Media keys

- Media control keys (printed on keyboard): play/pause, stop, previous, next, volume up, volume down

## I/O Ports

- 2-in-1 card reader (SD™, MMC)
- Three USB 2.0 ports
- External display (VGA) port
- Headphone/speaker jack
- Microphone-in jack
- Ethernet (RJ-45) port
- DC-in jack for AC adapter
- HDMI® port with HDCP support

## Optional Items

- 1/2/4 GB DDR3 soDIMM module
- 6-cell Li-ion battery pack
- 3-pin 65W AC adapter

## Warranty

- One-year International Travelers Warranty (ITW)

## Eco-compliance

- Energy Star
- WEE
- RoHS
- Mercury free

## Environment

- Temperature:
  - Operating: 41 F to 95 F (5 C to 35 C)
  - Non-operating: -4 F to 149 F (-20 C to 65 C)
- Humidity (non-condensing):
  - Operating: 20% to 80%
  - Non-operating: 20% to 80%

# Software

## Productivity

- Acer Backup Manager
- Acer ePower Management
- Acer eRecovery Management
- Adobe® Flash® Player 10.1
- Adobe® Reader® 9.1
- AUPEO! (US only)
- Bing™ Bar
- Kobo™ (Canada only)
- Microsoft® Office Starter 2010: Includes limited-functionality Microsoft® Word and Excel with advertising; no PowerPoint or Outlook. Buy Office 2010 to use the full-featured software.
- New York Times Reader (US only)
- NOOK for PC (US only)
- Norton™ Online Backup
- Windows Live™ Essentials

## Security

- McAfee® Internet Security Suite Trial
- MyWinLocker® (except China, Hong Kong)

## Multimedia

- Acer clear.fi
- NTI Media Maker™

## Gaming

- Oberon GameZone (except US, Canada, China, Hong Kong, Korea)
- WildTangent® (US, Canada only)

## Communication and ISP

- Acer Crystal Eye
- Microsoft® Silverlight™
- Skype™

## Web links and utilities

- Acer Accessory Store (Belgium, France, Germany, Italy, Netherlands, Spain, Sweden, UK only)
- Acer Identity Card
- Acer Registration
- Acer Updater
- eBay® shortcut 2009 (Canada, France, Germany, Italy, Mexico, Spain, UK, US only)
- Netflix shortcut (US only)

# Notebook Tour





**Figure 1-1. Top ViewTop View**

**Table 1-1. Top View**

#	Icon	Item	Description
1		Integrated webcam	Web camera for video communication (configuration may vary by model).
2		Display screen	Also called Liquid-Crystal Display (LCD), displays computer output (configuration may vary by model).
3		Power button	Turns the computer on and off.
4		Keyboard	For entering data into your computer.
5		Touchpad	Touch-sensitive pointing device which functions like a computer mouse.
6		Click buttons (left and right)	The left and right buttons function like the left and right mouse buttons.
7		Microphone	Internal microphone for sound recording.

**Table 1-1. Top View**

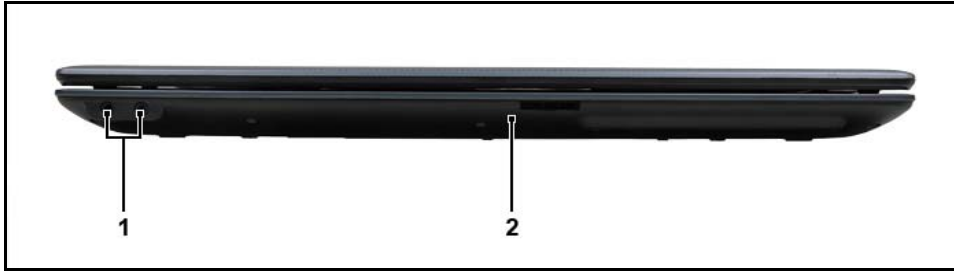

#	Icon	Item	Description
8		Power indicator	Indicates the computer's power status.
		Battery indicator	Indicates the computer's battery status. <b>1. Charging:</b> The light shows amber when the battery is charging. <b>2. Fully charged:</b> The light shows blue when in AC mode.
9		Palmrest	Comfortable support area for your hands when you use the computer.
10		Speaker	Delivers audio output

**Note:** Color option may depend on the model.



**Figure 1-2. Closed Front View**

**Table 1-2. Closed Front View**

#	Icon	Item	Description
1		Microphone jack	Accepts inputs from external microphones.
		Headphone/ speaker/line-out jack	Connects to audio line-out devices (e.g., speakers, headphones).
		2-in-1 card reader	Accepts Secure Digital (SD), MultiMediaCard (MMC). <b>Note:</b> Push to remove/install the card. Only one card can operate at any given time.

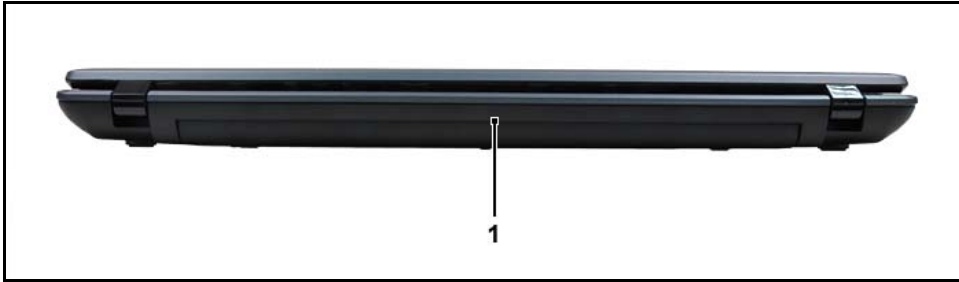

---

**Figure 1-3. Rear View**

**Table 1-3. Rear View**

#	Icon	Item	Description
1		Battery bay	Houses the computer's battery pack.



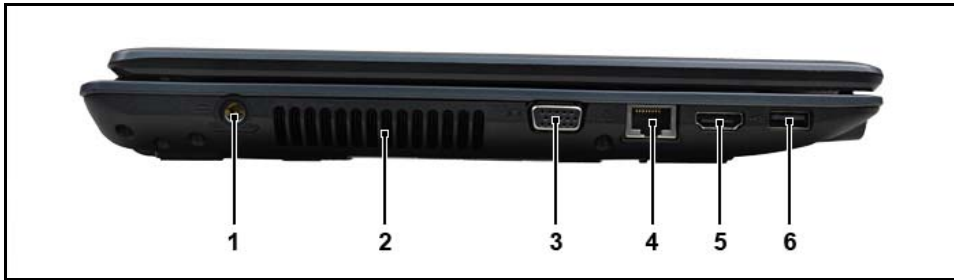

**Note:** Your computer may be equipped with a different battery to the one in the picture.

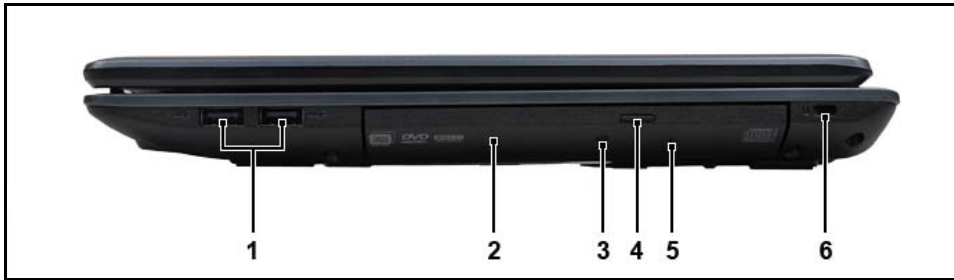



**Figure 1-4. Left View**



**Table 1-4. Left View**

#	Icon	Item	Description
1		DC-in jack	Connects to an AC adapter.
2		Ventilation slots	Enable the computer to stay cool, even after prolonged use.
3		External display (VGA) port	Connects to a display device (e.g., external monitor, LCD projector).
4		Ethernet (RJ-45) port	Connects to an Ethernet 10/100 based network.
5		HDMI port	Supports high-definition digital video connections.
6		USB 2.0 port	Connects to USB 2.0 devices (e.g., USB mouse, USB camera).



**Figure 1-5. Right View**

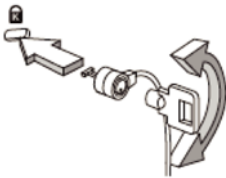

**Table 1-5. Right View**

#	Icon	Item	Description
1		USB 2.0 ports	Connect to USB 2.0 devices (e.g., USB mouse, USB camera).
2		Optical drive	Internal optical drive; accepts CDs or DVDs.
3		Optical disk access indicator	Lights up when the optical drive is active.
4		Optical drive eject button	Ejects the optical disk from the drive.
5		Emergency eject hole	Ejects the optical drive tray when the computer is turned off. Note: Insert a paper clip to the emergency eject hole to eject the optical drive tray when the computer is off.
6		Kensington lock slot 	Connects to a Kensington-compatible computer security lock.



**Figure 1-6. Base View**

**Table 1-6. Base View**

#	Icon	Item	Description
1		Battery bay	Houses the computer's battery pack.
2		Battery lock	Locks the battery in position.
3		Ventilation slots	Enable the computer to stay cool, even after prolonged use. <b>Note:</b> Do not cover or obstruct the opening of the fan.
4		Battery release latch	Releases the battery for removal.

# Touchpad Basics

---

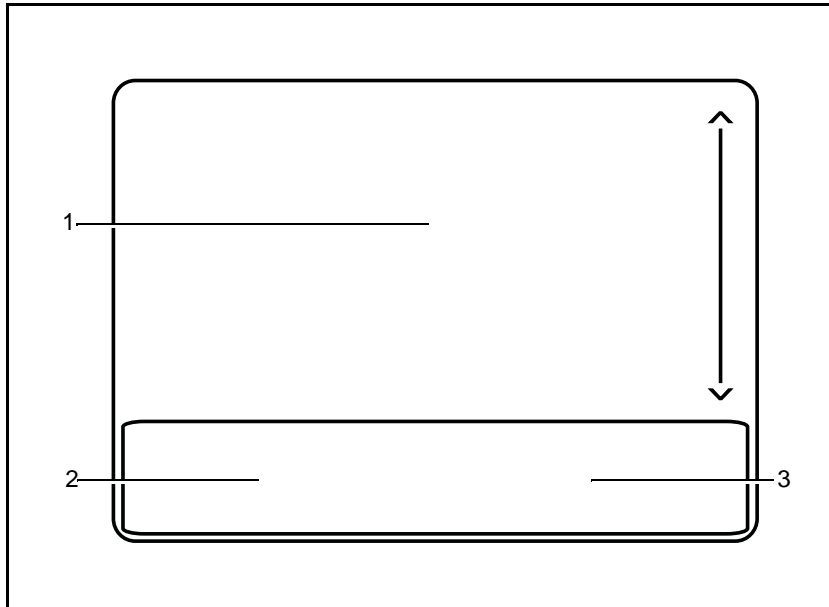

**Figure 1-7. Touchpad**

- Move your finger across the Touchpad (1) to move the cursor.
- Press the left (2) and right (3) buttons located beneath the Touchpad to perform selection and execution functions. These two buttons are the equivalent of the left and right buttons on a mouse. Tapping on the Touchpad is the same as clicking the left button.

Function	Main Touchpad (1)	Left Button (2)	Right Button (3)
Execute	Tap twice (at the same speed as double-clicking a mouse button).	Quickly click twice.	
Select	Tap once.	Click once.	
Drag	Tap twice (at the same speed as double-clicking a mouse button); rest your finger on the Touchpad on the second tap and drag the cursor.	Click and hold, then use finger on the Touchpad to drag the cursor.	
Access context menu			Click once.

**⇒ NOTE:**

When using the Touchpad, keep it - and fingers - dry and clean. The Touchpad is sensitive to finger movement; hence, the lighter the touch, the better the response. Tapping too hard will not increase the Touchpad's responsiveness.

# Using the Keyboard

---

The computer has a close-to-full-sized keyboard and an embedded numeric keypad, separate cursor, lock, function and special keys.



---

**Figure 1-8. Keyboard Lock Keys**

## Lock Keys



The keyboard has three lock keys which can be toggled on and off.















Lock key	Description
Caps Lock	When Caps Lock is on, all alphabetic characters typed are in uppercase.
Num Lock	When Num Lock is on, the numeric keypad is activated.
Scroll Lock <Fn> + <F12>	When Scroll Lock is on, the screen moves one line up or down when the up or down arrow keys are pressed respectively. Scroll Lock does not work with some applications.

# Windows Keys

---

The keyboard has two keys that perform Windows-specific functions.

-  Windows Logo key
-  Application key

Key	Description
Windows Logo key	<p>Pressed alone, this key has the same effect as clicking on the Windows Start button; it launches the Start menu. It can also be used with other keys to provide a variety of functions.</p> <p><b>Functions supported by Windows XP, Windows Vista, and Windows 7:</b></p> <p>&lt;  &gt;: Open or close the Start menu</p> <p>&lt;  &gt; + &lt;R&gt;: Open the Run dialog box</p> <p>&lt;  &gt; + &lt;M&gt;: Minimizes all windows</p> <p>&lt;SHIFT&gt; + &lt;  &gt; + M: Undo minimize all windows</p> <p>&lt;  &gt; + &lt;F1&gt;: Show the help window</p> <p>&lt;  &gt; + &lt;E&gt;: Open Windows Explorer</p> <p>&lt;  &gt; + &lt;F&gt;: Search for a file or folder</p> <p>&lt;  &gt; + &lt;D&gt;: Show the desktop</p> <p>&lt;CTRL&gt; + &lt;  &gt; + &lt;F&gt;: Search for computers (if you are on a network)</p> <p>&lt;  &gt; + &lt;L&gt;: Lock your computer (if you are connected to a network domain), or switch users (if you're not connected to a network domain)</p> <p>&lt;CTRL&gt; + &lt;  &gt; + &lt;TAB&gt;: Moves focus from Start menu, to the Quick Launch toolbar, to the system tray (use RIGHT ARROW or LEFT ARROW to move focus to items on the Quick Launch toolbar and the system tray)</p> <p>&lt;  &gt; + &lt;TAB&gt;: Cycle through programs on the taskbar</p> <p>&lt;  &gt; + &lt;BREAK&gt;: Display the System Properties dialog box</p> <p><b>Functions supported by Windows XP:</b></p> <p>&lt;  &gt; + &lt;BREAK&gt;: Show the System Properties dialog box</p> <p>&lt;  &gt; + &lt;U&gt;: Open Ease of Access Center</p>
Application key	This key has the same effect as clicking the right mouse button; it opens the application's context menu.

# Hotkeys



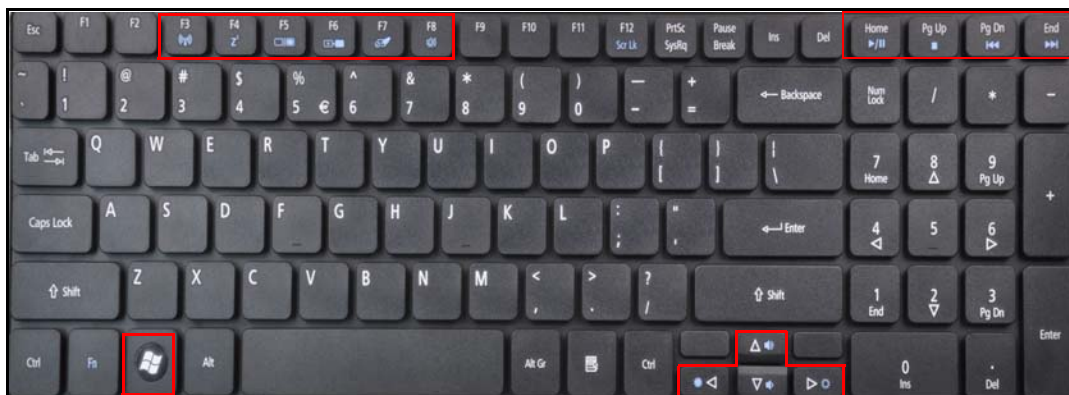



The computer employs hotkeys or key combinations to access most of the computer's controls like screen brightness and volume output.



**Figure 1-9. Keyboard Hotkeys**

To activate hotkeys, press and hold the <Fn> key before pressing the other key in the hockey combination.

Hot key	Icon	Function	Description
<Fn> + <F3>		Communication	Enables/disables the computer's communication devices. (Communication devices may vary by configuration.)
<Fn> + <F4>		Sleep	Puts the computer in Sleep mode.
<Fn> + <F5>		Display toggle	Switches display output between the display screen, external monitor (if connected) and both.
<Fn> + <F6>		Display off	Turns the display screen backlight off to save power. Press any key to return.
<Fn> + <F7>		Touchpad toggle	Turns the touchpad on and off.
<Fn> + <F8>		Speaker toggle	Turns the speakers on and off.
<Fn> + <▷>		Brightness up	Increases the screen brightness.
<Fn> + <◁>		Brightness down	Decreases the screen brightness.

Hot key	Icon	Function	Description
<Fn> + <△ >		Volume up	Increases the sound volume.
<Fn> + <▽ >		Volume down	Decreases the sound volume.
<Fn> + <Home>		Play/Pause	Play or pause a selected media file.
<Fn> + <Pg Up>		Stop	Stop playing the selected media file.
<Fn> + <Pg Dn>		Previous	Return to the previous media file.
<Fn> + <End>		Next	Jump to the next media file.

## Using the communication key\*

Here you can enable and disable the various wireless connectivity devices on your computer.

Press <Fn> + <F3> to bring up the Launch Manager window panel.

A red toggle indicates the device is off. Click On to enable Wi-Fi/Bluetooth connection. Click Off to disable connection.

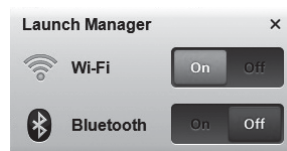

\* Communication devices may vary by model.



# System Block Diagram

## BLOCK DIAGRAM

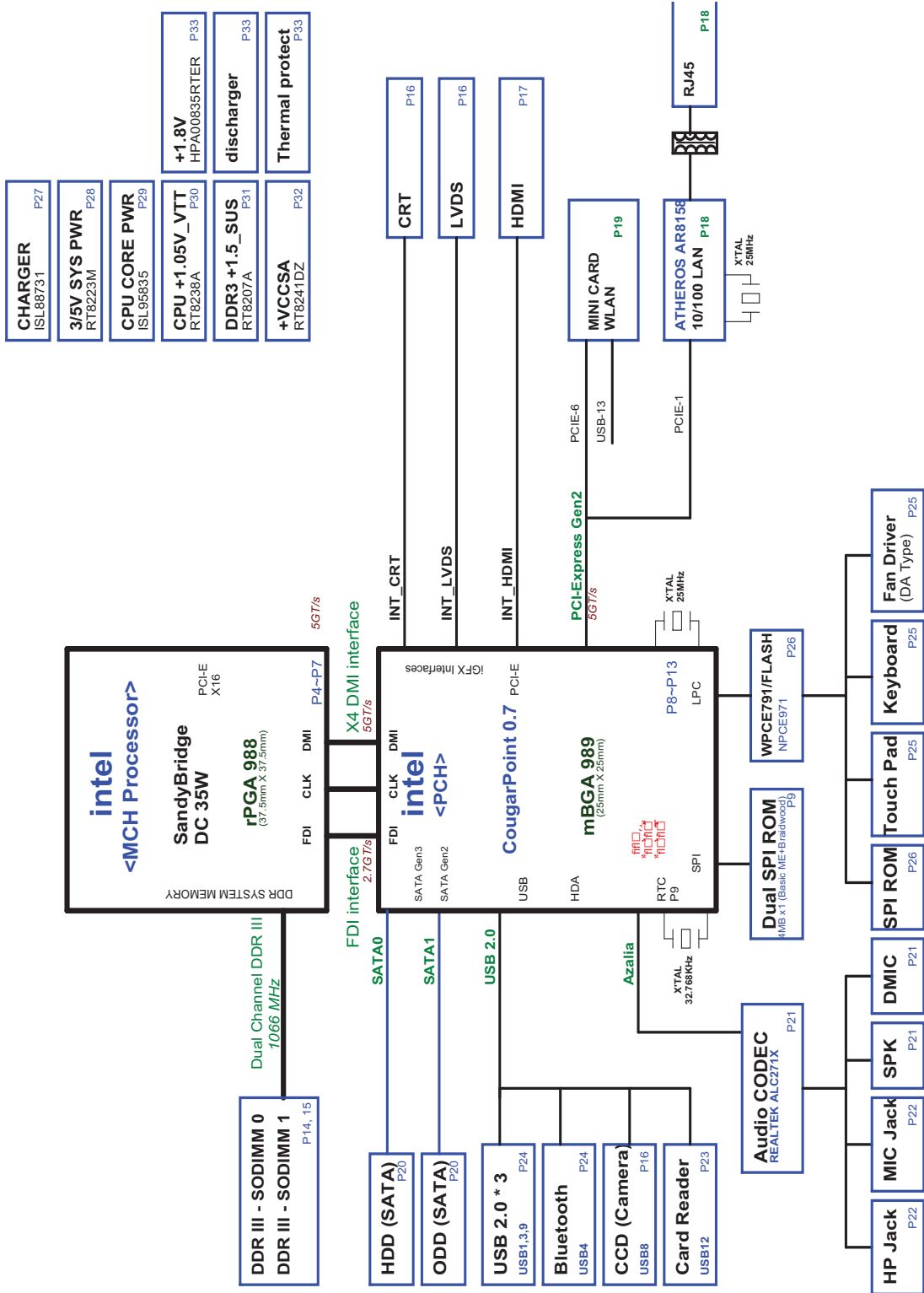

Figure 1-10. System Block Diagram

# Specification Tables

## Computer specifications

Item	Metric	Imperial
Dimensions		
Length	381 mm	15 in
Width	253 mm	9.96 in
Height (front to rear)	29.6/34.7 mm	1.17/1.37 in
Weight (equipped with optical drive, flash drive, and battery)	2.4 kg with 6-cell battery	5.29 lbs with 6-cell battery
Input power		
Operating voltage	19V	
Operating current	3.42A	
Temperature		
Operating (not writing to optical disc)	5°C to 35°C	41°F to 95°F
Operating (writing to optical disc)	5°C to 40°C	41°F to 104°F
Nonoperating	-20°C to 65°C	-4°F to 149°F
Relative humidity		
Operating	20% to 80%	
Nonoperating	20% to 80%	
Maximum altitude (unpressurized)		
Operating	-15 to 3,048m	-50 to 10,000ft
Nonoperating	-15 to 12,192m	-50 to 40,000ft
Shock		
Operating	105G, 2 ms, half-sine	
Nonoperating	220 G, 2 ms, half-sine	
Random vibration		
Operating	0.6G/5-500HZ/30min per axis	
Nonoperating	1.5G/5-500HZ/30 min per axis	
<b>⇒ NOTE:</b> Applicable product safety standards specify thermal limits for plastic surfaces. The computer operates well within this range of temperatures.		

## System Board Major Chips

Item	Specification
Core logic	Intel® Ibex-Peak
VGA	Integrated
LAN	Atheros AR8158L - Mega LAN solution. S5 Wake on LAN.
USB 2.0	USB2.0 embedded in PCH
Super I/O controller	embedded
Bluetooth	Bluetooth 2.1 with EDR/BT3.0 supported
Wireless	Atheros HB125, Realtek RTL8188CE
PCMCIA	N/A
Audio codec	Realtek ALC271X
Card reader	2-in-1 Card Reader (SD/MMC)
eSata	N/A

## Processor

Item	Specification
CPU type	Intel® Sandy Bridge series
CPU package	989 pins-rPGA socket
Core Logic	Intel® Ibex-Peak
Chipset	Mobile Intel® HM65 Express Chipset

## Processor Specifications

Item	CPU Speed (GHz)	Cores/Threads	Bus Speed (FSB/DMI/QBI)	Mfg Tech (nm)	Cache Size	Package	Voltage
Core i3-2310M	2.10	4	5 GT/s	32	3MB L3	BGA1023	1.05V~1.1V
Core i3-2330M	2.20	4	5 GT/s	32	3MB L3	BGA1023	1.05V~1.1V
Core i3-2350M	2.30	4	5 GT/s	32	3MB L3	BGA1023	1.05V~1.1V
Pentium B940	2	2	5 GT/s	32	2MB L3	rPGA988B	1.05V~1.1V
Pentium B950	2.10	2	5 GT/s	32	2MB L3	rPGA988B	1.05V~1.1V
Pentium B960	2.20	2	5 GT/s	32	2MB L3	rPGA988B	1.05V~1.1V
Celeron B710	1.6	1	5 GT/s	32	1MB L3	rPGA988B	1.05V~1.1V
Celeron B800	1.5	2	5 GT/s	32	2MB L3	rPGA988B	1.05V~1.1V

## CPU Fan True Value Table (TJ100-CPU)

Fan On (°C)	Fan Off (°C)	Fan Speed (RPM)
45	40	3150
58	52	3500
70	64	3850
80	75	4200
92	85	N/A

- Throttling 50%: On =98C ; Off=95C
- OS Shut down: 100C
- H/W Shut down : 100C

### CPU Fan True Value Table (TJ85-CPU)

Fan On (°C)	Fan Off (°C)	Fan Speed (RPM)
45	40	3150
58	52	3500
70	64	3850
78	74	4200
82	80	N/A
<ul style="list-style-type: none"><li>• Throttling 50%: On =83C ; Off=81C</li><li>• OS Shut down: 85C</li><li>• H/W Shut down : 85C</li></ul>		

### System Memory

Item	Specification
Memory controller	Built in at CPU
Memory size	DDR3 1066MHz 1 GB, 2 GB, 4 GB
DIMM socket number	2 socket
Supports memory size per socket	4 GB
Supports maximum memory size	8 GB
Supports DIMM type	SDRAM memory interface design
Supports DIMM Speed	800/1066/1333 SDRAM
Support DIMM voltage	1.5V
Supports DIMM package	Standard 204P

## Memory Combinations

Slot 1 (MB)	Slot 2 (MB)	Total Memory (MB)
0	1024	1024
1024	0	1024
1024	1024	2048
0	2048	2048
2048	0	2048
2048	2048	4096
0	4096	4096
4096	0	4096
4096	4096	8192

## Video Interface

Item	Specification
Chipset	NB Chipset Intel CS BD82HM65 B3 Huron River
Package	25 mm x 25 mm FCBGA (Mobile Only)
Interface	Intel® Flexible Display Interconnect (FDI)
Compatibility	Fully compliant with the electrical specifications ANSI/TIA/EIA-644
Sampling rate	Fixed frequency 2.7 GT/s data rate

## BIOS

Item	Specification
BIOS vendor	Insyde
BIOS Version	2.0
BIOS ROM type	EC, ME/BIOS
BIOS ROM size	128K/4MB
Features	<ul style="list-style-type: none"><li>• Insyde code base</li><li>• Flash ROM 4 MB</li><li>• Support ISIPP</li></ul>

## LAN Interface

Item	Specification
LAN Chipset	Atheros AR8158-BL1A-RL
LAN connector type	RJ45
LAN connector location	RJ45 at the left side
Features	Supports 10/100/1000

## Keyboard

Item	Specification
Type	Acer FineTip keyboard
Total number of keypads	103-/104-/107-key
Windows logo key	Yes
Internal & external keyboard work simultaneously	Plug USB keyboard to the USB port directly: Yes
Features	<ul style="list-style-type: none"><li>• Phantom key auto detect</li><li>• Overlay numeric keypad</li><li>• Supports independent pgdn/pgup/pgup/home/end keys</li><li>• Supports reverse T cursor keys</li><li>• Factory configurable different languages by OEM customer</li></ul>

## Hard Disk Drive (AVL components)

Item	Specification				
Vendor & Model Name	Toshiba MK2559GSXP WD WD2500BPVT-22JJ5T0 HGST HTS543225A7 A384 Seagate ST250LT003/9 YG14C-188	Toshiba MK3259GSXP WD WD3200BPVT-22JJ5T0 HGST HTS543232A7 A384 Seagate ST320LT020	Toshiba MK5059GSXP WD WD 5000BPVT-22 HXZT3 HGST HTS547550A9 E384 Seagate ST9500325AS	Toshiba MK6459GSXP WD WD6400BPVT-22HXZT3 HGST HTS547564A9 E384 Seagate ST9640423AS ST9640320AS	Toshiba MK7559GSXP WD WD750BPVT-22HXZT3 HGST HTS547575A9 E384 Seagate ST9750423AS
Capacity (GB)	250	320	500	640	750
Bytes per sector	4k				
Data heads	2	2	3/4	4	4
Drive Format					
Disks	1	1	2	2	2
Spindle speed (RPM)	5400				
Performance Specifications					
Buffer size	8MB				
Interface	SATA				
Fast data transfer rate (Gbits / sec, max)	3.0				
Media data transfer rate (Mbytes/sec max)	953, 1044	994, 1044,	872, 1175	1144, 838, 1305, 1175	996, 1130, 1363
DC Power Requirements					
Voltage tolerance	5V ±5%				



**LED 15.6"**

<b>Item</b>	<b>Specification</b>
Vendor & Model name	AUO B156XW02 SAMSUNG LTN156AT02-A11 SAMSUNG LTN156AT24-A01 LPL P156WH2-TLEA LPL LP156WH4-TLA1 CMO N156B6-L0B
Screen Diagonal (mm)	396
Active Area (mm)	222.72 X128.28 344.232 X 193.536
Display resolution (pixels)	1366 X 768
Pixel Pitch (mm)	0.252 X 0.252
Typical White Luminance (cd/m <sup>2</sup> ) also called Brightness	220 typ. (5 points average) 190 min. (5 points average)
Contrast Ratio	500 typ
Response Time (Optical Rise Time/Fall Time) msec	8 typ /16Max
Typical Power Consumption (watt)	2.816 max. (Include Logic and Blu power)
Weight (without inverter)	450 max.
Physical Size (mm)	359 (L) x 210 (W) x 5.5 (D)
Electrical Interface	1 channel LVDS
Viewing Angle (degree) Horizontal (Right) CR = 10 (Left) Vertical (Upper) CR = 10 (Lower)	40 min / 45 typ 40 min / 45 typ 10 min / 15 typ 30 min / 35 typ

**LCD Inverter (not available with this model)**

<b>Item</b>	<b>Specification</b>
Vendor & Model name	
Brightness conditions	
Input voltage (v)	
Input current (mA)	
Output voltage (V, RMS)	
Output current (mA, RMS)	
Output voltage frequency (KHz)	

### Display Supported Resolution (LCD Supported Resolution)

Resolution	16 bits	32 bits	Intel
1280x720p/60Hz 16:9	Yes	Yes	Yes
1366x768p/60Hz 16:9	Yes	Yes	Yes

### Graphics Controller

Item	Specification
VGA Chip	Integrated graphics; Intel HD Graphics 3000
Supports	<ul style="list-style-type: none"> <li>• For SKUs with graphics, carries display traffic from the GPU in the processor to the legacy display connectors in the PCH.</li> <li>• DisplayPort standard.</li> <li>• Two independent links - one for each display pipe.</li> <li>• Four unidirectional downstream differential transmitter pairs: <ul style="list-style-type: none"> <li>■ Scalable down to 3X, 2X, or 1X based on actual display bandwidth requirements</li> <li>■ Fixed frequency 2.7 GT/s data rate</li> </ul> </li> <li>• Two sideband signals for Display synchronization: <ul style="list-style-type: none"> <li>■ FDI_FSYNC and FDI_LSYNC (Frame and Line Synchronization)</li> </ul> </li> <li>• One Interrupt signal used for various interrupts from the PCH: <ul style="list-style-type: none"> <li>■ FDI_INT signal shared by both Intel FDI Links</li> </ul> </li> <li>• PCH supports end-to-end lane reversal across both links</li> <li>• Common 100-MHz reference clock is sent to both processor and PCH</li> </ul>

### Display Supported Resolution (GPU Supported Resolution)

Resolution	16 bits	32 bits	Intel
800x600p/60Hz	Yes	Yes	Yes
1024x600p/60Hz	Yes	Yes	Yes
1280x600p/60Hz	Yes	Yes	Yes
1280x720p/60Hz	Yes	Yes	Yes
1280x768p/60Hz	Yes	Yes	Yes
1360x768p/60Hz	Yes	Yes	Yes
1366x768p/60Hz	Yes	Yes	Yes

## Bluetooth Interface

Item	Specifications			
Chipset	Atheros BU22	Broadcom BCM 20702	Broadcom BCM 2070	Atheros BU12
Data through put	TX 1.2Mbits/sec, RX 1.2Mbits/sec			
Protocol	3.0 + EDR	3.0 + EDR	3.0 + EDR	3.0 + EDR
Interface	USB 2.0			
Connector type	6 pin connector	6 pin connector	6 pin JST SM06B-XSRK-ETB	6 pin narrow pitch connector
Supported protocol	3.0	3.0	3.0	3.0

## Bluetooth Module

Item	Specifications
Controller	Atheros BU22
Feature	<ul style="list-style-type: none"> <li>• Single-chip Bluetooth v4.0 solution</li> <li>• USB 2.0 full-speed device interface, supporting Device Firmware Upgrade (DFU)</li> <li>• I<sup>2</sup>C or SPI interface, supporting external EEPROM and serial flash devices</li> <li>• 1.2V linear voltage regulator (LDO)</li> <li>• Integrated 32-bit CPU with 128 KByte data RAM and 512 KByte program ROM</li> <li>• On-chip low power oscillator</li> <li>• On-chip one-time programmable (OTP) memory</li> <li>• Standard USB HCI interface</li> </ul>
Controller	Broadcom BCM 20702
Feature	<ul style="list-style-type: none"> <li>• Bluetooth 4.0 + EDR compliant</li> <li>• Programmable output power control</li> <li>• Supports mobile and PC applications</li> <li>• Point-to-multipoint operation</li> <li>• USB 2.0 compliant interface</li> <li>• Etched PCB antenna</li> <li>• Ultra-low power consumption</li> </ul>
Controller	Broadcom BCM 2070

Item	Specifications
Features	<ul style="list-style-type: none"> <li>• Bluetooth 3.0 compliant</li> <li>• Point-to-multipoint operation</li> <li>• External USB interface for data</li> <li>• Onboard antenna and SMA RF connector</li> <li>• Coexistence support</li> </ul>
Controller	Atheros BU12
Features	<ul style="list-style-type: none"> <li>• Single-chip Bluetooth v2.1/3.0+EDR integrated solution</li> <li>• USB 2.0 full-speed device interface, supporting Device Firmware Upgrade (DFU)</li> <li>• SPI interface supports external serial flash devices</li> <li>• Two on-chip 1.2V linear voltage regulators</li> <li>• Integrated 32-bit CPU with 32KB data RAM and 256KB program RAM</li> <li>• On-board PLL</li> <li>• On-chip low power oscillator (LPO)</li> <li>• Standard USB HCI interface</li> </ul>

### Camera

Item	Specification		
Vendor & Model	Liteon 0.3MB LT7675AL	Suyin 0.3MB SY_7675_AL	Chicony 0.3MB CH_7675_AL
Type	CMOS image sensor with VGA	CMOS image sensor OV7675	CMOS image sensor with VGA

### Mini Card

Item	Specification
Number supported	1
Features	1 mini card slot (for WLAN or WLAN/WiMax)

### 3G Card (not available in this model)

Item	Specification
Features	

## Audio Codec and Amplifier

Item	Specification
Audio Controller	Realtek ALC271X
Features	<ul style="list-style-type: none"> <li>• Meets WLP (Windows Logo Program) requirements for Windows XP, Vista and Windows 7</li> <li>• 98dB Signal-to-Noise Ratio (A-weighting) for DAC output</li> <li>• 90dB Signal-to-Noise Ratio (A-weighting) for ADC output</li> <li>• 4-channel DAC supports 16/20/24-bit PCM format for independent two stereo channel or 2.1 audio playback</li> <li>• 4-channel ADC supports 16/20/24-bit PCM format for independent two stereo channel audio inputs</li> <li>• All DACs support 44.1k/48k/96k/192kHz sample rate</li> <li>• All ADCs support 44.1k/48k/96k/192kHz sample rate</li> <li>• S/PDIF-OUT support 16/20/24-bit format and 44.1/48/88.2/96/192kHz rate</li> <li>• Supports MONO line level output</li> <li>• Supports external PCBEEP input and built-in digital BEEP generator</li> <li>• Software selectable 2.5V/3.2V VREFOUT as bias voltage for analog microphone input</li> <li>• Programmable +12/+24/+36dB boost gain for analog microphone input</li> <li>• Supports stereo digital microphone input</li> <li>• Programmable boost gain and volume control for digital microphone input</li> <li>• Built-in headphone amplifiers for port-C (LINE1) and port-I (HP OUT)</li> <li>• Headphone amplifier for port-I does not require DC blocking capacitors</li> <li>• Two jack detection pins each designed to detect up to 4 jacks, and S/PDIF-OUT jack detection is supported</li> <li>• EAPD (External Amplifier Power Down) is supported</li> <li>• Supports Anti-pop mode when analog power AVDD is on and digital power is off</li> <li>• Power support: 3.3V digital core power; 1.5V~3.3V digital IO power for HDA link; 3.0V~5.5V analog power; 4.5V~5.5V power stage voltage</li> <li>• Enhanced power management features for normal operation and standby mode</li> <li>• Stereo Bridge-Tied Load Class-D amplifier at port-D has 2Watt (rms)/4 Ohms per channel output</li> <li>• Short circuit and thermal overload protection for Class-D amplifier</li> <li>• Class D amplifier has high pass filter with programmable Cut-Off frequency (10Hz~900Hz) to prevent low frequency signal damage speaker</li> <li>• Class D amplifier output with slew rate and spread spectrum control to improve EMI performance</li> <li>• Independent left and right channel of output power limiter (25%~100% power range) to protect speaker</li> </ul>

Item	Specification
	<ul style="list-style-type: none"> <li>• Intel low power ECR compliant: supports power status control, jack detection, and wake-up event in D3 mode</li> <li>• Built in a 5V-to-4.5V linear regulator with 60db PSRR to power analog circuitry</li> <li>• 48-pin QFN 'Green' package</li> </ul>

### Audio Interface

Item	Specification
Audio Controller	Realtek ALC271X
Audio onboard or optional	On board
Mono or Stereo	Mono
Resolution	Support 16/24bit PCM
Compatibility	HD audio Interface
Sampling rate	Sample rate up to 192Khz resolution VSR (Variable Sampling Rate)
Internal microphone	Yes
Internal speaker/quantity	Yes/(1.2W speakers x2)

### Wireless Module 802.11b/g/n

Item	Specification				
Chipset	Atheros HB95	Atheros HGB125	Broadcom 4313	Intel Crane Peak	Realtek RTL8188CE
Data throughput	11-54 Mbps, up to 300 Mbps for Draft-N	11-54 Mbps, up to 300 Mbps for Draft-N	11-54 Mbps, up to 300 Mbps for Draft-N	11-54 Mbps, up to 300 Mbps for Draft-N	11-54 Mbps, up to 300 Mbps for Draft-N
Protocol	b, g, n	b, g, n	b, g, n	b, g, n	a, g, n
Interface	PCI-E	PCI-E	PCI-E	PCI-E	PCI-E

### Battery

Item	Specification
Vendor & Model name	Sanyo AS10D31, Sony AS10D41, Panasonic AS10D51, Samsung AS10D61, Simplo AS10D, LGC AS10D
Battery Type	Lithium-Ion
Pack capacity	4400mAh
Number of battery cell	6
Package configuration	MSOP-8L, MSOP-8S

## VRAM

Item	Specification
Chipset	N/A (Shared memory only)
Memory size	N/A
Interface	N/A

## USB Port

Item	Specification
USB compliance level	Universal Serial Bus 2.0
EHCI	2
Number of USB port(s)	3
Location	1 left side, 2 right side
Output Current	1.05V

## AC Adapter

Item	Specification
Input rating	100-240V~1.7A(1,7A) 50-60Hz
Maximum input AC current	1.7 Amps
Inrush current	264 Vac (Cold/Hot start) No damage; meet fuse and bridge diode $I^2t$ de-rating.
Efficiency	Meets EPA 2.0 level V requirement. The adapter efficiency shall be more than 87%, that is the average value of 25%, 50%, 75% and 100% load with both 115Vac/60Hz and 230Vac/50Hz input voltage condition.

## System Power Management

Item	Specification
Mech. Off (G3)	All devices in the system are turned off completely.
Soft Off (G2/S5)	OS initiated shutdown. All devices in the system are turned off completely.
Working (G0/S0)	Individual devices such as the CPU and hard disc may be power managed in this state.
Suspend to RAM (S3)	<ul style="list-style-type: none"> <li>• CPU set power down</li> <li>• VGA Suspend</li> <li>• Audio Power Down</li> <li>• Hard Disk Power Down</li> <li>• Super I/O Low Power mode</li> </ul>
Save to Disk (S4)	Also called Hibernation Mode. System saves all system states and data onto the disc prior to power off the whole system.

## Card Reader

Item	Specification
Chipset	AU6435A51-GDL-GR
Package	LQFP
Maximum supported size	16G
Features	<ul style="list-style-type: none"> <li>• Fully compatible with USB2.0 High Speed and backward compatible with USB1.1 specifications</li> <li>• Supports multiple flash card interfaces, including SD/MMC.</li> <li>• Supports single LUN</li> <li>• 48-pin LQFP lead-free/Halogen-free/RoHS compliant package is available.</li> <li>• Complies with USB Device Class Definition for Mass Storage and Bulk-Transport V1.0</li> <li>• Complies with Secure Digital Card (SD) specification up to ver. 3.0(SDXC)</li> <li>• Support UHS (SRD-50/DDR-50) operation mode.</li> <li>• Complies with MultiMedia Card (MMC) specification up to ver. 4.4 and supports 8-bit data bus.</li> <li>• Complies with Memory Stick (MS) specification up to ver. 1.43</li> <li>• Complies with Memory Stick PRO (MS_Pro) specification up to ver. 1.05</li> <li>• Complies with Memory Stick PRO-HG (MS PRO-HG) specification up to ver. 1.03 and supports 8-bit data bus.</li> <li>• Complies with Memory Stick Interface Guideline for PC peripheral devices with Memory Stick Slot ver. 1.16-00</li> <li>• Complies with xD-Picture Card (xD) specification up to ver. 1.2</li> </ul>



## System LED Indicator

Item	Specification
Lock	<ul style="list-style-type: none"><li>• Caps Lock on = Blue</li></ul>
System state	<ul style="list-style-type: none"><li>• Blue color on: System on</li><li>• Blue color and amber color off: System off</li><li>• Amber color on: S3</li></ul>
HDD access state	N/A
Wireless state	Wifi on = Amber
Power button backlight	<ul style="list-style-type: none"><li>• Blue color solid on: System on</li><li>• Blue color off: System off</li></ul>
Battery state	<ul style="list-style-type: none"><li>• Full charging = Blue</li><li>• Battery charging = Amber</li></ul>

## System DMA Specification

Legacy Mode	Power Management
DMA0	N/A
DMA1	N/A
DMA2	N/A
DMA3	N/A
DMA4	Direct memory access controller
DMA5	N/A
DMA6	N/A
DMA7	N/A
*ExpressCard controller can use DMA 1, 2, or 5.	

## System Interrupt Specification

Hardware IRQ	System Function
IRQ00	System timer
IRQ01	Standard PS/2 Keyboard
IRQ07	Intel(R) 6 Series/C200 Series Chipset Family SMBus Controller - 1C22
IRQ08	System CMOS/real-time clock
IRQ12	Synaptics PS/2 Port Touchpad
IRQ13	Numeric data processor
IRQ16	<ul style="list-style-type: none"> <li>• Atheros AR8152/8158 PCI-E Fast Ethernet Controller (NDIS 6.20)</li> <li>• Intel(R) 6 Series/C200 Series Chipset Family USB Enhanced Host Controller - 1C2D</li> <li>• Intel(R) 6 Series/C200 Series Chipset Family PCI Express Root Port 6 - 1C1A</li> <li>• Intel(R) Management Engine Interface</li> </ul>
IRQ17	Intel(R) 6 Series/C200 Series Chipset Family PCI Express Root Port 1 - 1C10
IRQ19	Intel(R) Mobile Express Chipset SATA AHCI Controller
IRQ22	High Definition Audio Controller
IRQ23	Intel(R) 6 Series/C200 Series Chipset Family USB Enhanced Host Controller - 1C26
IRQ81	Microsoft ACPI-Compliant System
IRQ82	Microsoft ACPI-Compliant System
IRQ83	Microsoft ACPI-Compliant System
IRQ84	Microsoft ACPI-Compliant System
IRQ85	Microsoft ACPI-Compliant System
IRQ86	Microsoft ACPI-Compliant System
IRQ87	Microsoft ACPI-Compliant System
IRQ88	Microsoft ACPI-Compliant System
IRQ89	Microsoft ACPI-Compliant System
IRQ90	Microsoft ACPI-Compliant System
IRQ91	Microsoft ACPI-Compliant System
IRQ92	Microsoft ACPI-Compliant System
IRQ93	Microsoft ACPI-Compliant System
IRQ94	Microsoft ACPI-Compliant System
IRQ95	Microsoft ACPI-Compliant System

Hardware IRQ	System Function
IRQ96	Microsoft ACPI-Compliant System
IRQ97	Microsoft ACPI-Compliant System
IRQ98	Microsoft ACPI-Compliant System
IRQ99	Microsoft ACPI-Compliant System
IRQ100	Microsoft ACPI-Compliant System
IRQ101	Microsoft ACPI-Compliant System
IRQ102	Microsoft ACPI-Compliant System
IRQ103	Microsoft ACPI-Compliant System
IRQ104	Microsoft ACPI-Compliant System
IRQ105	Microsoft ACPI-Compliant System
IRQ106	Microsoft ACPI-Compliant System
IRQ107	Microsoft ACPI-Compliant System
IRQ108	Microsoft ACPI-Compliant System
IRQ109	Microsoft ACPI-Compliant System
IRQ110	Microsoft ACPI-Compliant System
IRQ111	Microsoft ACPI-Compliant System
IRQ112	Microsoft ACPI-Compliant System
IRQ113	Microsoft ACPI-Compliant System
IRQ114	Microsoft ACPI-Compliant System
IRQ115	Microsoft ACPI-Compliant System
IRQ116	Microsoft ACPI-Compliant System
IRQ117	Microsoft ACPI-Compliant System
IRQ118	Microsoft ACPI-Compliant System
IRQ119	Microsoft ACPI-Compliant System
IRQ120	Microsoft ACPI-Compliant System
IRQ121	Microsoft ACPI-Compliant System
IRQ122	Microsoft ACPI-Compliant System
IRQ123	Microsoft ACPI-Compliant System
IRQ124	Microsoft ACPI-Compliant System
IRQ125	Microsoft ACPI-Compliant System
IRQ126	Microsoft ACPI-Compliant System
IRQ127	Microsoft ACPI-Compliant System
IRQ128	Microsoft ACPI-Compliant System

Hardware IRQ	System Function
IRQ129	Microsoft ACPI-Compliant System
IRQ130	Microsoft ACPI-Compliant System
IRQ131	Microsoft ACPI-Compliant System
IRQ132	Microsoft ACPI-Compliant System
IRQ133	Microsoft ACPI-Compliant System
IRQ134	Microsoft ACPI-Compliant System
IRQ135	Microsoft ACPI-Compliant System
IRQ136	Microsoft ACPI-Compliant System
IRQ137	Microsoft ACPI-Compliant System
IRQ138	Microsoft ACPI-Compliant System
IRQ139	Microsoft ACPI-Compliant System
IRQ140	Microsoft ACPI-Compliant System
IRQ141	Microsoft ACPI-Compliant System
IRQ142	Microsoft ACPI-Compliant System
IRQ143	Microsoft ACPI-Compliant System
IRQ144	Microsoft ACPI-Compliant System
IRQ145	Microsoft ACPI-Compliant System
IRQ146	Microsoft ACPI-Compliant System
IRQ147	Microsoft ACPI-Compliant System
IRQ148	Microsoft ACPI-Compliant System
IRQ149	Microsoft ACPI-Compliant System
IRQ150	Microsoft ACPI-Compliant System
IRQ151	Microsoft ACPI-Compliant System
IRQ152	Microsoft ACPI-Compliant System
IRQ153	Microsoft ACPI-Compliant System
IRQ154	Microsoft ACPI-Compliant System
IRQ155	Microsoft ACPI-Compliant System
IRQ156	Microsoft ACPI-Compliant System
IRQ157	Microsoft ACPI-Compliant System
IRQ158	Microsoft ACPI-Compliant System
IRQ159	Microsoft ACPI-Compliant System
IRQ160	Microsoft ACPI-Compliant System
IRQ161	Microsoft ACPI-Compliant System

Hardware IRQ	System Function
IRQ162	Microsoft ACPI-Compliant System
IRQ163	Microsoft ACPI-Compliant System
IRQ164	Microsoft ACPI-Compliant System
IRQ165	Microsoft ACPI-Compliant System
IRQ166	Microsoft ACPI-Compliant System
IRQ167	Microsoft ACPI-Compliant System
IRQ168	Microsoft ACPI-Compliant System
IRQ169	Microsoft ACPI-Compliant System
IRQ170	Microsoft ACPI-Compliant System
IRQ171	Microsoft ACPI-Compliant System
IRQ172	Microsoft ACPI-Compliant System
IRQ173	Microsoft ACPI-Compliant System
IRQ174	Microsoft ACPI-Compliant System
IRQ175	Microsoft ACPI-Compliant System
IRQ176	Microsoft ACPI-Compliant System
IRQ177	Microsoft ACPI-Compliant System
IRQ178	Microsoft ACPI-Compliant System
IRQ179	Microsoft ACPI-Compliant System
IRQ180	Microsoft ACPI-Compliant System
IRQ181	Microsoft ACPI-Compliant System
IRQ182	Microsoft ACPI-Compliant System
IRQ183	Microsoft ACPI-Compliant System
IRQ184	Microsoft ACPI-Compliant System
IRQ185	Microsoft ACPI-Compliant System
IRQ186	Microsoft ACPI-Compliant System
IRQ187	Microsoft ACPI-Compliant System
IRQ188	Microsoft ACPI-Compliant System
IRQ189	Microsoft ACPI-Compliant System
IRQ190	Microsoft ACPI-Compliant System
IRQ-2	Intel(R) Centrino(R) Wireless-N100
IRQ-3	Intel(R) HD Graphics Family

## System I/O Address Map

I/O address (hex)	System Function (shipping configuration)
0000 - 001F	Direct memory access controller
0000 - 0CF7	PCI bus
0020 - 0021	Programmable interrupt controller
0024 - 0025	Programmable interrupt controller
0028 - 0029	Programmable interrupt controller
002C - 002D	Programmable interrupt controller
002E - 002F	Motherboard resources
0030 - 0031	Programmable interrupt controller
0034 - 0035	Programmable interrupt controller
0038 - 0039	Programmable interrupt controller
003C - 003D	Programmable interrupt controller
0040 - 0043	System timer
004E - 004F	Motherboard resources
0050 - 0053	System timer
0060 - 0060	Standard PS/2 Keyboard
0061 - 0061	Motherboard resources
0062 - 0062	Microsoft ACPI-Compliant Embedded
0063 - 0063	Motherboard resources
0064 - 0064	Standard PS/2 Keyboard
0065 - 0065	Motherboard resources
0066 - 0066	Microsoft ACPI-Compliant Embedded
0067 - 0067	Motherboard resources
0070 - 0070	Motherboard resources
0070 - 0077	System CMOS/real time clock
0080 - 0080	Motherboard resources
0081 - 0091	Direct memory access controller
0092 - 0092	Motherboard resources
0093 - 009F	Direct memory access controller
00A0 - 00A1	Programmable interrupt controller
00A4 - 00A5	Programmable interrupt controller
00A8 - 00A9	Programmable interrupt controller
00AC - 00AD	Programmable interrupt controller

## System I/O Address Map (Continued)

I/O address (hex)	System Function (shipping configuration)
00B0 - 00B1	Programmable interrupt controller
00B2 - 00B3	Motherboard resources
00B4 - 00B5	Programmable interrupt controller
00B8 - 00B9	Programmable interrupt controller
00BC - 00BD	Programmable interrupt controller
00C0 - 00DF	Direct memory access controller
00F0 - 00F0	Numeric data processor
03B0 - 03BB	Intel(R) HD Graphics Family
03C0 - 03DF	Intel(R) HD Graphics Family
0400 - 0453	Motherboard resources
0454 - 0457	Motherboard resources
0458 - 047F	Motherboard resources
04D0 - 04D1	Programmable interrupt controller
0500 - 057F	Motherboard resources
0680 - 069F	Motherboard resources
0D00 - FFFF	PCI bus
1000 - 100F	Motherboard resources
1010 - 1013	Motherboard resources
164E -164F	Motherboard resources
2000 - 2FFF	Intel(R) 6 Series/C200 Series Chipset Family PCI Express Root Port 6 - 1C1A
3000 - 307F	Atheros AR8152/8158 PCI-E Fast Ethernet Controller (NDIS 6.20)
3000 - 3FFF	Intel(R) 6 Series/C200 Series Chipset Family PCI Express Root Port 1 - 1C10
4000 - 403F	Intel(R) HD Graphics Family
4040 - 405F	Intel(R) 6 Series/C200 Series Chipset Family SMBus Controller - 1C22
4060 - 407F	Intel(R) Mobile Express Chipset SATA AHCI Controller
4080 - 4087	Intel(R) Mobile Express Chipset SATA AHCI Controller
4088 - 408F	Intel(R) Mobile Express Chipset SATA AHCI Controller
4049 - 4093	Intel(R) Mobile Express Chipset SATA AHCI Controller
4094 - 4097	Intel(R) Mobile Express Chipset SATA AHCI Controller
FFFF - FFFF	Motherboard resources





# CHAPTER 2

## System Utilities

---

<b>BIOS Setup Utility</b> . . . . .	<b>2-3</b>
Navigating the BIOS Utility . . . . .	2-3
<b>BIOS</b> . . . . .	<b>2-4</b>
Information . . . . .	2-4
Main . . . . .	2-6
Advanced . . . . .	2-8
Security . . . . .	2-9
Power . . . . .	2-13
Boot . . . . .	2-14
Exit . . . . .	2-15
<b>BIOS Flash Utilities</b> . . . . .	<b>2-16</b>
DOS Flash Utility . . . . .	2-17
WinFlash Utility . . . . .	2-18
<b>Clearing BIOS Passwords</b> . . . . .	<b>2-19</b>
Removing BIOS Passwords . . . . .	2-20
Removing Insyde HDD Password . . . . .	2-22
<b>Miscellaneous Tools</b> . . . . .	<b>2-23</b>
Using DMITools . . . . .	2-23
Using STUUIID . . . . .	2-26
Using the LAN MAC EEPROM Utility . . . . .	2-27
Crisis Disk Recovery . . . . .	2-28

# System Utilities

---

## BIOS Setup Utility

---

This utility is a hardware configuration program built into a computer's BIOS (Basic Input/Output System).

The utility is pre-configured and optimized so most users do not need to run it. If configuration problems occur, the setup utility may need to be run. Refer to *Chapter 4, Troubleshooting* when a problem arises.

To activate the utility, press **F2** during POST (power-on self-test) when prompted at the bottom of screen.

The default parameter of `F12 Boot Menu` is set to `Disabled`. To change the boot device without entering *BIOS Setup Utility*, set the parameter to `Enabled`.

To change the boot device without entering the BIOS SETUP, press **F12** during POST to enter the multi-boot menu.

## Navigating the BIOS Utility

---

Six menu options are:

- Information
- Main
- Security
- Boot
- Exit

To navigate through the following:

- Menu - use the left and right arrow keys
- Item - use the up and down arrow keys
- Change parameter value - press **F5** or **F6**.
- Exit - Press **Esc**
- Load default settings - press **F9**. Press **F10** to save changes and exit BIOS Setup Utility

### ⇒ NOTE:

Parameter values can be changed if enclosed in square brackets open the DIMM door open the DIMM door[ ]. Navigation keys appear at the bottom of the screen. Read parameter help carefully when making changes to parameter values. Parameter help is found in the Item Specific Help area of the screen.

### ⇒ NOTE:

System information is subject to specific models.

# BIOS

The following is a description of the tabs found on the InsydeH20 *BIOS Setup Utility* screen:

⇒ **NOTE:**

The screens provided are for reference only. Actual values may differ by model.

## Information

The Information tab shows a summary of computer hardware information.

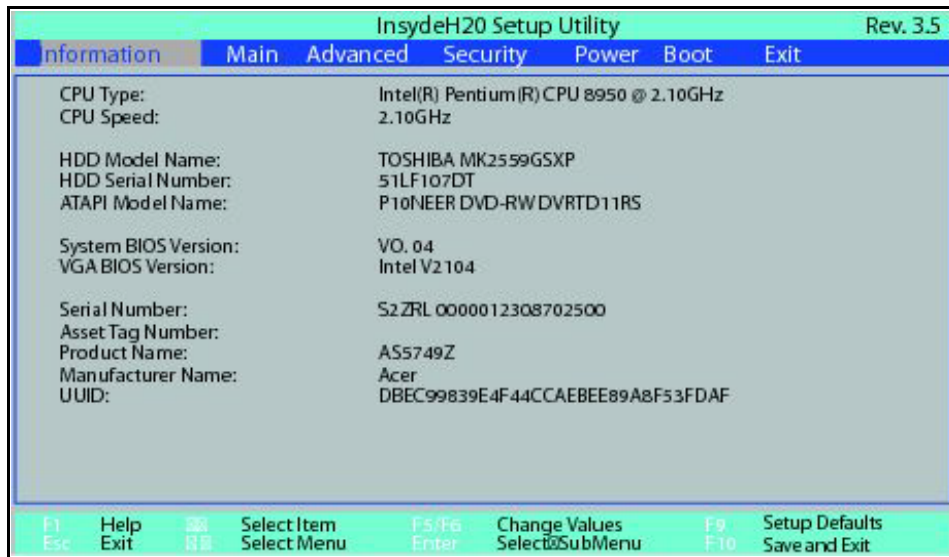

**Figure 2-1. BIOS Information**

Table 2-1 describes the parameters shown in Figure 2-1

**Table 2-1. BIOS Information**

Parameter	Description
CPU Type	CPU (central processing unit) type and speed of system
CPU Speed	Speed of the CPU
HDD Model Name	Model name of HDD (hard disk drive) installed on primary IDE master
HDD Serial Number	Serial number of HDD installed on primary IDE master
ATAPI Model Name	Model name of ATAPI (Advanced Technology Attachment with Packet Interface)
System BIOS Version	System BIOS version
VGA BIOS Version	VGA (video graphics array) firmware version of system

**Table 2-1. BIOS Information (Continued)**

<b>Parameter</b>	<b>Description</b>
Serial Number	Serial number of unit
Asset Tag Number	Asset tag number of system
Product Name	Product name of the system
Manufacturer Name	Manufacturer of system
UUID	Universally Unique Identifier

# Main

The Main tab allows the user to set system time and date, enable or disable boot option and enable or disable recovery.

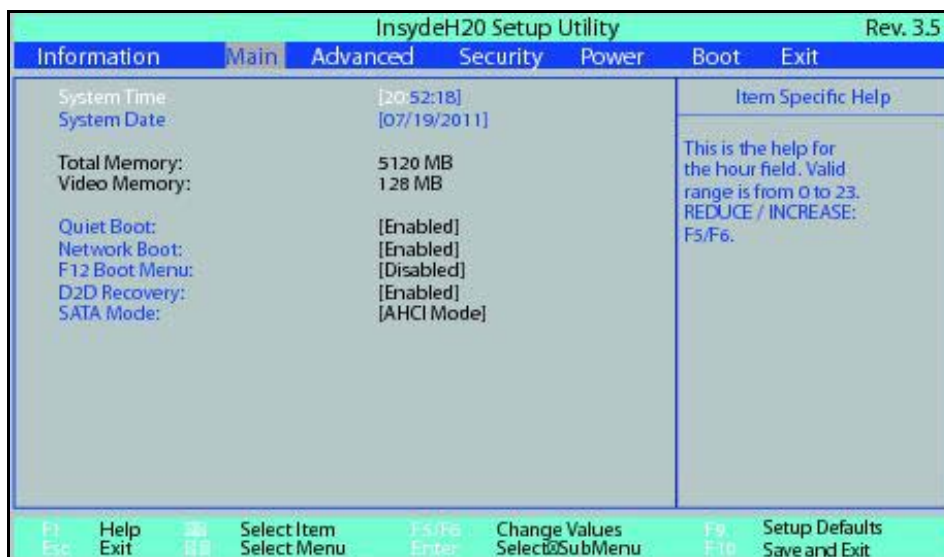

**Figure 2-2. BIOS Main**

Table 2-2 describes the parameters shown in Figure 2-2.

**Table 2-2. BIOS Main**

Parameter	Description	Format/Option
System Time	BIOS system time in 24-hour format	Format: HH:MM:SS (hour:minute:second)
System Date	BIOS system date	Format MM/DD/YYYY (month/day/year)
Total Memory	Total memory available	N/A
Video Memory	Available memory for video	N/A
Quiet Boot	Shows OEM (original equipment manufacturer) screen during system boot instead of traditional POST screen	Option: Enabled or Disabled
Network Boot	Option to boot system from LAN (local area network)	Option: Enabled or Disabled
F12 Boot Menu	Option to use boot menu during POST	Option: Enabled or Disabled
D2D Recovery	Option to use D2D Recovery function	Option: Enabled or Disabled

**Table 2-2. BIOS Main (Continued)**

<b>Parameter</b>	<b>Description</b>	<b>Format/Option</b>
SATA Mode	Option to set SATA controller mode	Option: AHCI or IDE

# Advanced

---

The Advanced tab shows the configuration of system settings, including:

- Boot configuration
- Peripheral configuration
- IDE configuration
- Thermal configuration
- Video configuration
- Chipset configuration
- ACPI table/feature control
- PCI express configuration
- Extended ICC

Use - and ` keys to select an item.

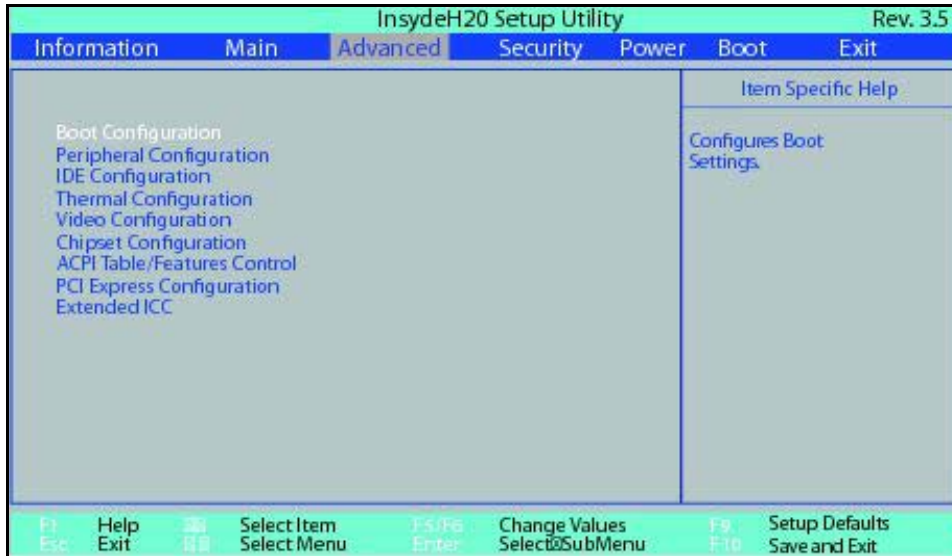
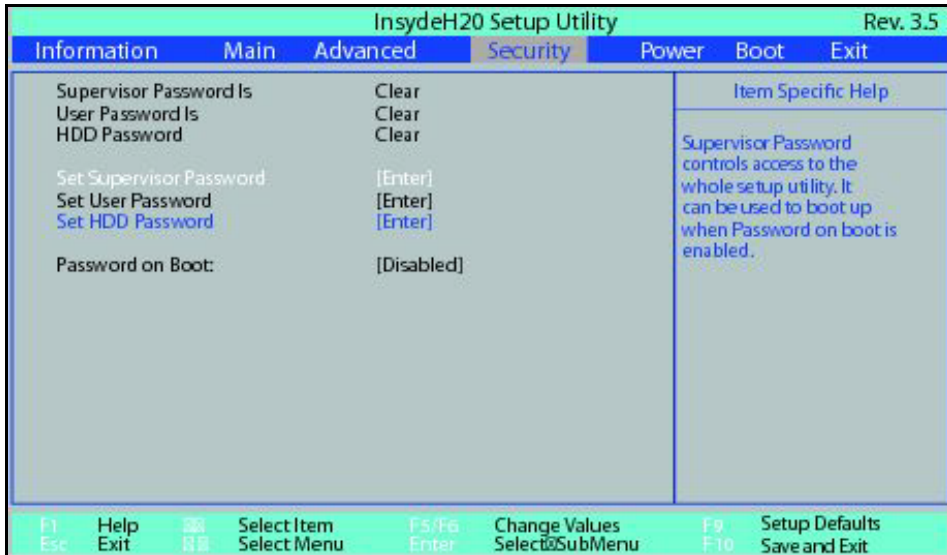

**Figure 2-3. BIOS Advanced**



# Security

The Security tab shows parameters that safeguard and protect the computer from unauthorized use.



**Figure 2-4. BIOS Security**

Table 2-3 describes the parameters shown in Figure 2-4.

**Table 2-3. BIOS Security**

Parameter	Description	Option
Supervisor Password Is	Supervisor password setting	Clear or Set
User Password Is	User password setting	Clear or Set
HDD Password Is	HDD password setting	Clear or Set
Set Supervisor Password	Option to set supervisor password	N/A
Set User Password	Option to set user password	N/A
Set HDD Password	Option to set HDD password	N/A
Password on Boot	Shows if password is required during system boot  <b>⚠ CAUTION:</b> If Power-on-Password authentication is enabled, the BIOS password can only be cleared by initiating the Crisis Disk Recovery procedure. Refer to <a href="#">Crisis Disk Recovery</a> .	Disabled or Enabled

⇒ **NOTE:**

When prompted to enter password, three attempts are allowed before system halts. Resetting BIOS password may require computer be returned to dealer.

## Setting a Password

Perform the following to set user or supervisor passwords:

1. Use the ↑ and ↓ keys to highlight the `Set Supervisor Password` parameter and press **Enter**. The `Set Supervisor Password` dialog box appears.

⇒ **NOTE:**

To change an existing password, refer to [Changing a Password](#).



**Figure 2-5. Set Supervisor Password**

2. Type a new password in the `Enter New Password` field. Passwords are not case sensitive and the length must not exceed 12 alphanumeric characters (A-Z, a-z, 0-9). Retype the password in the `Confirm New Password` field.

+ **IMPORTANT:**

Use care when typing a password. Characters do not appear on the screen.

3. Press **Enter**. After setting the password, the computer sets the `User Password` parameter to `Set`.

⇒ **NOTE:**

Password on Boot must be set to `Enabled` to activate password feature.

4. Press **F10** to save changes and exit *BIOS Setup Utility*.

## Removing a Password

Perform the following:

1. Use the ↑ and ↓ keys to highlight `Set Supervisor Password` and press **Enter**. The `Set Supervisor Password` dialog box appears:



**Figure 2-6. Set Supervisor Password**

2. Type current password in Enter Current Password field and press **Enter**.
3. Press **Enter** twice without typing anything in Enter New Password and Confirm New Password fields. Computer will set Supervisor Password parameter to Clear.
4. Press **F10** to save changes and exit the *BIOS Setup Utility*.

## Changing a Password

1. Use the ↑ and ↓ keys to highlight Set Supervisor Password and press **Enter**. The Set Supervisor Password dialog box appears.



**Figure 2-7. Set Supervisor Password**

2. Type current password in Enter Current Password field and press **Enter**.
3. Type new password in Enter New Password field. Retype new password in Confirm New Password field.
4. Press **Enter**. Computer sets Supervisor Password parameter to Set.

⇒ **NOTE:**

Password on Boot must be set to Enabled to activate the password feature.

5. Press **F10** to save changes and exit *BIOS Setup Utility*.

If the verification is OK, the screen will show as follows.



**Figure 2-8. Setup Notice**

The password setting is complete after the user presses **Enter**.

If the password entered does not match the current password, the screen shows the Setup Warning dialog. (Figure 2-9)

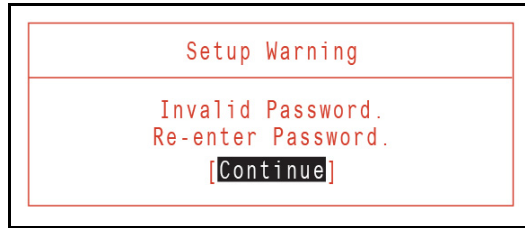

---

**Figure 2-9. Setup Warning: Invalid Password**

If new password and confirm new password strings do not match, the Setup Warning dialog appears (Figure 2-10).



---

**Figure 2-10. Setup Warning: Passwords Do Not Match**

# Power

The power tab allows you to change the various power settings.

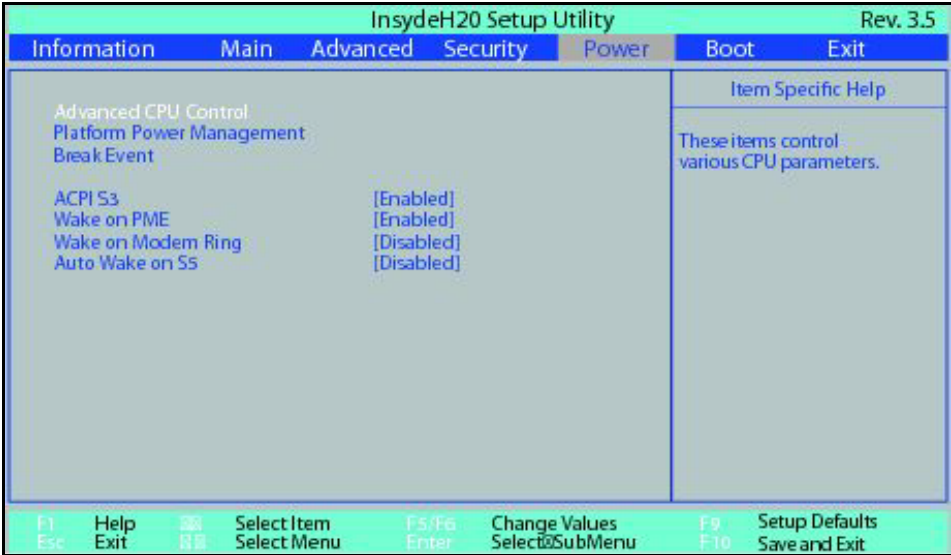

**Figure 2-11. BIOS Power**

Table 2-4 describes the parameters shown in Figure 2-11.

**Table 2-4. BIOS Power**

Parameter	Description
Advanced CPU Control	Set CPU parameters
Platform Power Management	Shows power settings
Break Event	Shows break events

# Boot

---

The Boot tab allows changes to the order of boot devices used to load the operating system. Bootable devices include the:

- USB diskette drives
- Onboard hard disk drive
- DVD drive in the module bay

Use ↑ and ↓ keys to select a device and press **F5** or **F6** to change the value.

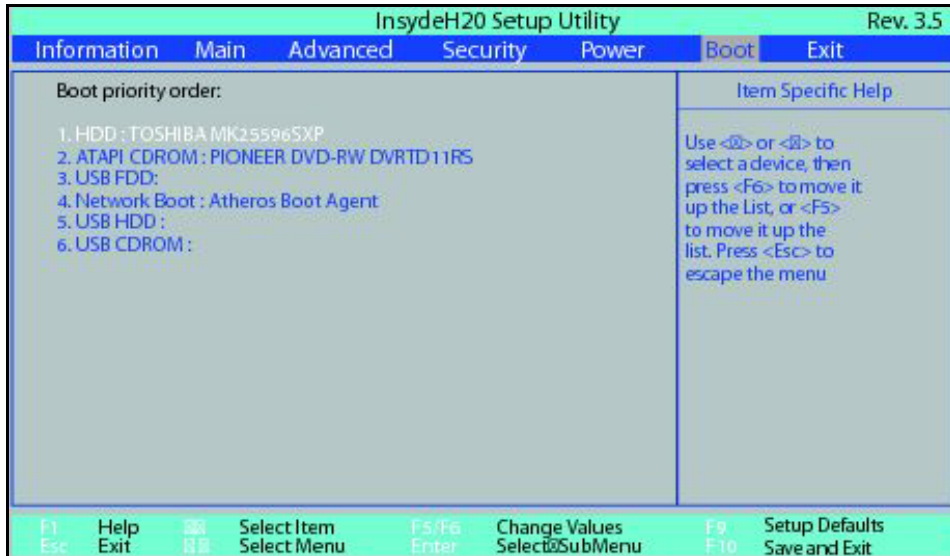

---

**Figure 2-12. BIOS Boot**

# Exit

---

The Exit tab allows users to save or discard changes and quit the *BIOS Setup Utility*.



**Figure 2-13. BIOS Exit**

Table 2-5 describes the parameters in Figure 2-13.

**Table 2-5. Exit Parameters**

Parameter	Description
Exit Saving Changes	Exit BIOS utility and save setup item changes to system.
Exit Discarding Changes	Exit BIOS utility without saving setup item changes to system.
Load Setup Defaults	Load default values for all setup items.
Discard Changes	Load previous values of all setup items.
Save Changes	Save setup item changes without exiting BIOS utility.

# BIOS Flash Utilities

---

BIOS Flash memory updates are required for the following conditions:

- New versions of system programs
- New features or options
- Restore a BIOS when it becomes corrupted.

Use the Flash utility to update the system BIOS Flash ROM.

⇒ **NOTE:**

If a Crisis Recovery Disc is not available, create one before Flash utility is used.

⇒ **NOTE:**

Do not install memory related drivers (XMS, EMS, DPML) when Flash is used.

⇒ **NOTE:**

Use AC adaptor power supply when running Flash utility. If battery pack does not contain power to finish loading BIOS Flash, do not boot system.

Perform the following to run Flash.

1. Prepare a bootable USB HDD.
2. Copy **ZQR\_101.exe** to bootable USB HDD.
3. Boot system from bootable USB HDD.

⇒ **NOTE:**

Flash utility has auto execution function.



# DOS Flash Utility

---

Perform the following to use the *DOS Flash Utility*:

1. Press **F2** during boot to enter Setup Menu.
2. Select Boot Menu to modify boot priority order.

Example: If using USB HDD to Update BIOS, move USB HDD to position 1.

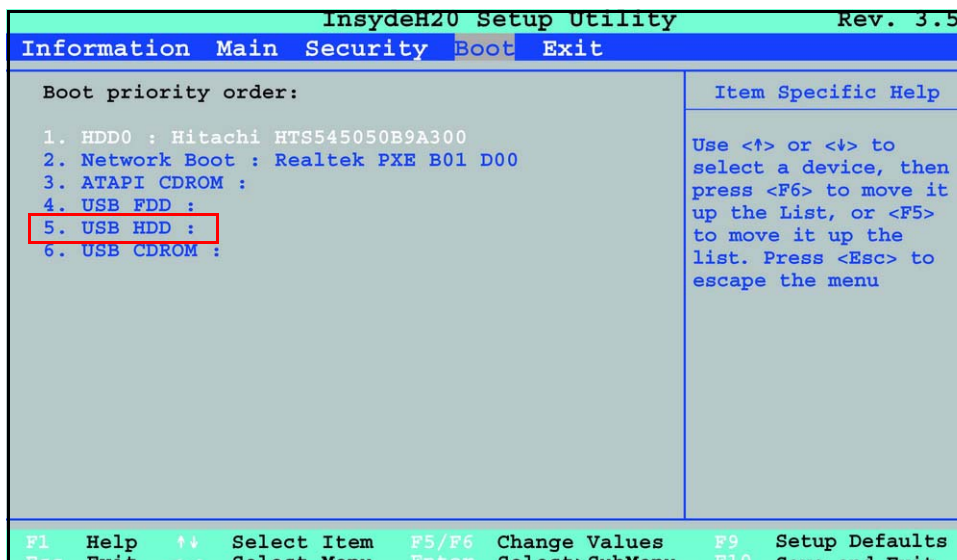
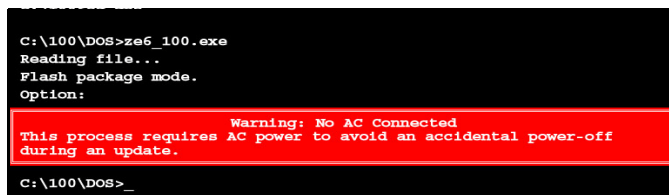

**Figure 2-14. BIOS Boot**

3. Copy **zQR\_101.exe** to a bootable USB HDD.
4. Insert the USB HDD and reboot computer.
5. Execute **zQR\_101.exe** to update BIOS. Flash process begins as shown in Figure 2-15.
6. Flash is complete when the message, *Flash Programming Complete* is shown. System will restart automatically when finished.

⇒ **NOTE:**

If AC power is not connected, the following message is shown (Figure 2-15). Plug in the AC power to continue.



**Figure 2-15. AC Power Warning**

# WinFlash Utility

---

Perform the following to use the WinFlash Utility:

1. Double-click WinFlash executable (ZQR\_101W.exe).
2. Click **OK** to begin update. A progress screen is shown. (Figure 2-16)



Figure 2-16. InsydeFlash

# Clearing BIOS Passwords

---

**⚠ CAUTION:**

If Power-on Password authentication is enabled, the BIOS password can only be cleared by initiating the Crisis Disk Recovery procedure or flashing the BIOS. See [Crisis Disk Recovery](#).

This section provides details about removing HDD/BIOS passwords.

Clear the BIOS Password as follows:

**⇒ NOTE:**

If the BIOC password is incorrectly entered three times, an error is generated. (Figure 2-17)

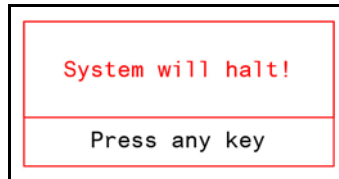

---

**Figure 2-17. Password Error Status**

To reset the BIOS password, perform the following:

1. Press any key to exit the menu.
2. In DOS mode, execute `ClearSubPw.exe`.

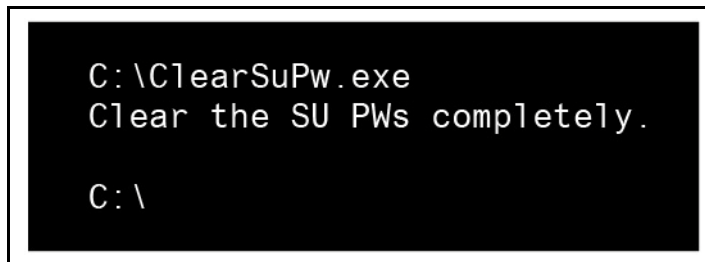

---

**Figure 2-18. Clear BIOS Password**

# Removing BIOS Passwords

---

(Hardware method) To clear User or Supervisor passwords, remove lower cover and use a metal instrument to short the CMOS jumper.

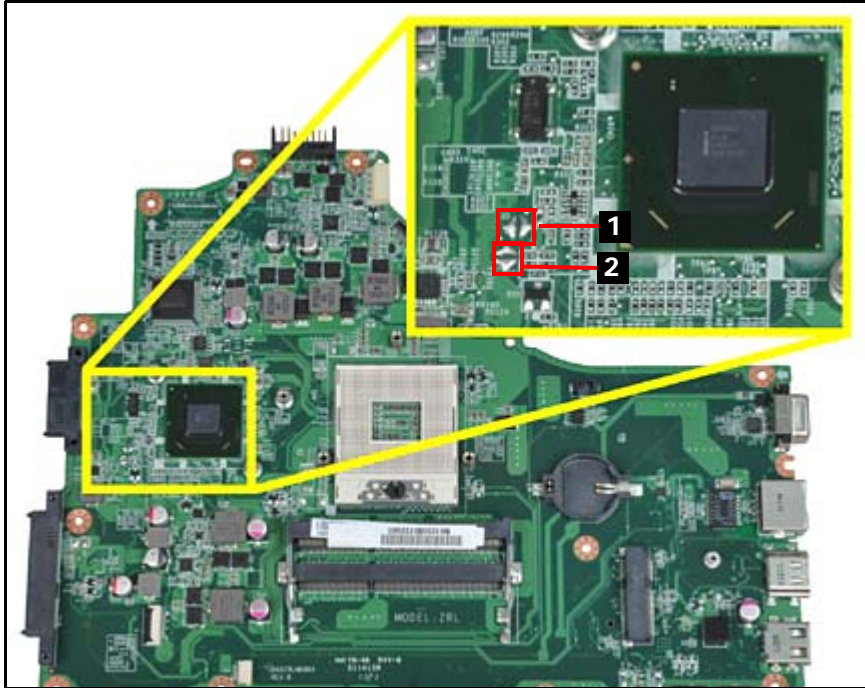

---

**Figure 2-19. CMOS Jumper**

**Table 2-6. CMOS Jumper**

Item	Description
1	Clear CMOS Jumper
2	Clear CMOS Jumper

(Software method) If wrong supervisor password is entered three times, the message System will halt! is displayed on screen.

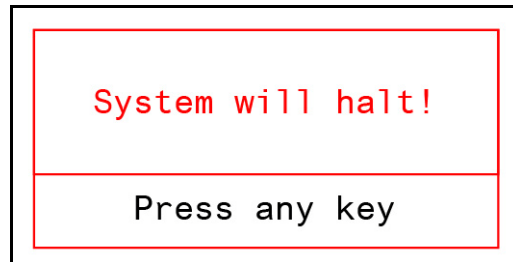

---

**Figure 2-20. Supervisor Password Error**

If user is unable to obtain correct password then it must be removed. There are two methods to do this.

### Method 1:

If BIOS menu item `Power on Password` is set to `Enabled`, then Crisis Recovery disc must be used.

### Method 2:

If BIOS menu item `Power on Password` is set to `Disabled`.

1. Boot to DOS and execute `ClearSuPw.exe`. (Figure 2-21)

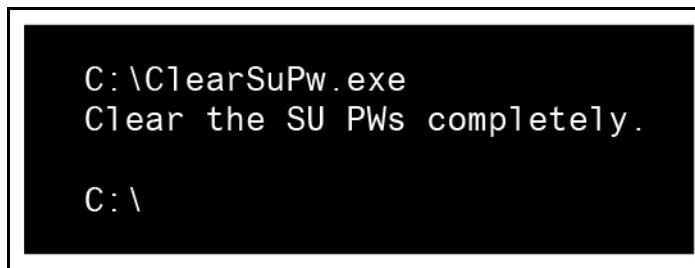
A screenshot of a DOS command prompt window with a black background and white text. The text shows the command 'C:\ClearSuPw.exe' being entered, followed by the message 'Clear the SU Pws completely.' and the prompt 'C:\' on a new line.

```
C:\ClearSuPw.exe
Clear the SU Pws completely.

C:\
```

---

**Figure 2-21. Clear Supervisor Password Utility**

2. When message `Clear the SU Pws completely` is displayed, supervisor password has been removed.

## Removing Insyde HDD Password

---

Clear the BIOS Password as follows:

To reset the BIOS password, perform the following:

1. When the user keys in the wrong password three times, the system reports the error code:

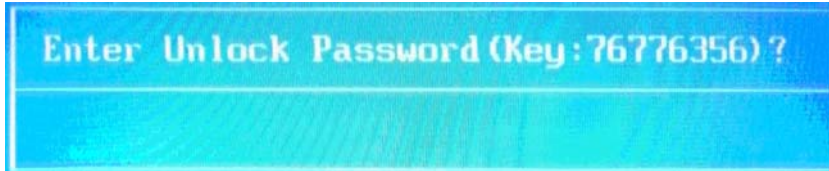

---

**Figure 2-22. Unlock Password Prompt**

2. In DOS mode, execute `UnlockHD.exe XXXXX` (where XXXX is the Unlock password error code; example here is 76776356). The `exe` will generate an unlock password (example here is 69654998).

```
F:\>unlockhd 76776356
Password : 69654998
F:\>_
```

---

**Figure 2-23. UnlockHD.exe**

3. The `exe` will generate a unlock password. Enter this password at the prompt.

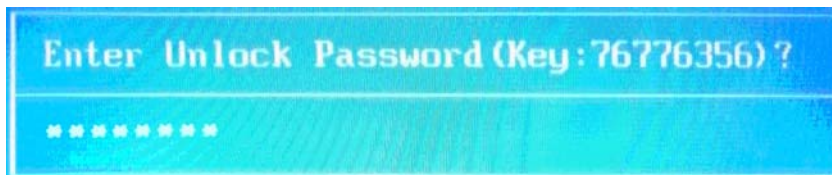

---

**Figure 2-24. Enter Unlock Password**

# Miscellaneous Tools

---

## Using DMITools

---

The DMI (Desktop Management Interface) Tool copies BIOS information to EEPROM (Electrically Erasable Programmable Read-Only Memory). Used in the DMI pool for hardware management.

When the BIOS shows **Verifying DMI pool data**, it is checking that the table correlates with the hardware before sending information to the operating system (Windows, etc.).

To update the DMI Pool, perform the following:

1. Boot to DOS.
2. Execute `qdm1301.exe`. To execute a specific function, select the associated menu number.

```
=====
!!!  WARNING  !!!
This utility can be used by service people only!
The incorrect value may cause service problem!

Copyright 2004 Quanta Computer Inc.,
Version: 3.00a

=====

If you want to use SPACE character in your string,
please use '^' to replace it.

=====

Please selstc function:
1: AssetTag
2: Product Name
3: Serial Number
4: 1394 GUID Number
0: Exit
===>_
```

---

Figure 2-25. DMI Tools Main Menu Screen

3. Press **1** to modify the asset tag key.

```
=====
If you want to use SPACE character in your string,
please use '^' to replace it.
=====

Please selct function:
1: AssetTag
2: Product Name
3: Serial Number
4: 1394 GUID Number
0: Exit
===>1
!!! Tha Max length is 32 characters !!!
           1           2           3
      ---5---0---5---0---5---0---
AssetTag is :12345678901234567890123456789012
```

---

**Figure 2-26. Asset Tag Menu Item**

4. Press **2** to modify the product number key.

```
=====
If you want to use SPACE character in your string,
please use '^' to replace it.
=====

Please selct function:
1: AssetTag
2: Product Name
3: Serial Number
4: 1394 GUID Number
0: Exit
===>2
!!! Tha Max length is 15 characters !!!
           1
      ---5---0---5
Product Name is :Aspire^ 5349
```

---

**Figure 2-27. Product Name Menu Item**



5. Press **3** to modify serial number key.

```
=====
If you want to use SPACE character in your string,
please use '^' to replace it.
=====

Please selstc function:
1: AssetTag
2: Product Name
3: Serial Number
4: 1394 GUID Number
0: Exit
===>3
!!! Tha Max length is 22 characters !!!
                1      2
            ----5----0----5----0--
Serial Number is :1234567890123456789012_
```

---

**Figure 2-28. Serial Number Menu Item**

6. Press **4** to modify the 1394 GUID number key.

```
=====
If you want to use SPACE character in your string,
please use '^' to replace it.
=====

Please selstc function:
1: AssetTag
2: Product Name
3: Serial Number
4: 1394 GUID Number
0: Exit
===>4
!!! Tha Max length is 8 characters !!!
                ----5--8
1394 GUID Number is :12345678_
```

---

**Figure 2-29. 1394 GUID Number Menu Item**

7. Press **0** to exit.

- At the command prompt, type **VEEPROM** to write any changes in the data to the EEPROM.

```
C: \>VEEPROM_
```

Figure 2-30. VEEPROM Command Prompt

⇒ **NOTE:**

When using any of the write options, restart the system to make the new DMI data effective.

## Using STUUID

To use **STUUID**, perform the following:

- Copy **stuuid20.exe** to a bootable USB drive.
- Boot to DOS.
- Execute **stuuid20 q**.
- Execute **stuuid20 s x YY** where **X** is the PCI bus and **YY** is the device ID.

```
C:\>
C:\>stuuid20 q
System LAN -
  Bas: 2; Device: 0: Function: 0; Device ID: 8168h; Vender: Unknown (10ECh)
Return 0
C:\>stuuid20 s 2 00
This PCI LAN device is not in list - use Int15 interface to get MAC address!
MAC Address = 60 EB 69 B8 BB 41
New EEPROM UUID data -
C0: 20 31 03 77 E3 28 E8 11 - B2 57 68 EB 69 B8 BB 41
Return 0
C:\>
```

Figure 2-31. STUUID

## Using the LAN MAC EEPROM Utility

---

Perform the following steps to write MAC (Media Access Control) information to EEPROM:

Use **LAN.BAT** utility to write MAC values to EEPROM under DOS mode.

1. Get into a MS-DOS prompt and enter *ipconfig /all* to get 'MAC address' (MAC address is the 16 digit number given as Physical Address).
2. Run the *LAN.BAT* file.
3. Enter the 'MAC address' to write MAC values. Flash process begins as shown as follow:

```
Enter the MAC ID - Samle: 001636XXXXXX(____): 00269E230844
Please waiting for EEPROM data filling .....
Please waiting for EEPROM data comparing .....
.....
Current MAC ID of ESN EEPROM : 00269E230844
Compare ACER & OEM S/N of ESN EEPROM : PASS
```

4. Flash is completed when the message, *Compare ACER & OEM S/N of ESN EEPROM: PASS*, is shown.
5. At the command prompt, run **VEEPROM.EXE** to write any changes in the data to the EEPROM.
6. Reboot the system when the process has completed.

## Crisis Disk Recovery

---

1. Plug in the USB flash disk.
2. Select the **Fast Format** option and click **Start**. Then click **Next**.
3. Click **Format** and then **Exit** to complete the operation.
4. Copy the *ZQR.fd* file to the USB flash disk root directory and rename to *BIOS.fd*.

⇒ **NOTE:**

Do not place any other \*.fd files to the USB flash disk root directory.

5. Plug in the USB Flash Disk without AC plug.
6. Press **Fn + Esc** keys and hold them down until the power led turns off (about 1-2 seconds).
7. Press **Power** button and the system will enter crisis mode to flash the BIOS.

# CHAPTER 3

## Machine Maintenance Procedures

---

<b>Introduction</b> . . . . .	<b>3-5</b>
<b>General Information</b> . . . . .	<b>3-5</b>
<b>Recommended Equipment</b> . . . . .	<b>3-5</b>
<b>Maintenance Flowchart</b> . . . . .	<b>3-6</b>
<b>Getting Started.</b> . . . . .	<b>3-7</b>
Battery Pack Removal. . . . .	3-8
Battery Pack Installation . . . . .	3-8
Dummy Card Removal . . . . .	3-9
Dummy Card Installation . . . . .	3-9
Keyboard Removal . . . . .	3-10
Keyboard Installation. . . . .	3-11
UpperCase Screws and FFC Removal . . . . .	3-12
UpperCase Screws and FFC Installation. . . . .	3-12
ODD (Optical Disk Drive) Module Removal . . . . .	3-13
ODD Module Installation . . . . .	3-14
Base Cover Removal . . . . .	3-15
Base Cover Installation. . . . .	3-15
USB Module Removal. . . . .	3-16
USB Module Installation . . . . .	3-17
HDD (Hard Disk Drive) Removal . . . . .	3-18
Hard Disk Drive Installation . . . . .	3-19
RTC (Real Time Clock) Battery Removal . . . . .	3-20
RTC Battery Installation . . . . .	3-20
WLAN (Wireless Local Area Network) Module Removal . . . . .	3-21
WLAN Module Installation . . . . .	3-23
Bluetooth Module Removal. . . . .	3-24
Bluetooth Module Installation . . . . .	3-25
Thermal Module Removal . . . . .	3-26
Thermal Module Installation . . . . .	3-27
Mainboard Removal. . . . .	3-29
Mainboard Installation . . . . .	3-30
CPU (Central Processing Unit) Removal . . . . .	3-31
CPU Installation . . . . .	3-32
PCH (Platform Controller Hub) Removal. . . . .	3-33
PCH Installation . . . . .	3-34
DIMM (Dual In-line Memory Module) Removal . . . . .	3-35
DIMM Installation. . . . .	3-36
Power Board Removal . . . . .	3-37
Power Board Installation . . . . .	3-38
DC-in Jack Removal . . . . .	3-39
DC-in Jack Installation . . . . .	3-40
Speakers Removal. . . . .	3-41
Speakers Installation . . . . .	3-41
LCD (Liquid Crystal Display) Module Removal . . . . .	3-42

LCD Module Installation .....	3-43
LCD Bezel Removal .....	3-44
LCD Bezel Installation .....	3-45
Camera Module Removal .....	3-46
Camera Module Installation .....	3-47
LCD Panel Removal .....	3-48
LCD Panel Installation .....	3-49
LCD Hinge Removal .....	3-50
LCD Hinge Installation .....	3-50
LVDS Cable Removal .....	3-51
LVDS Cable Installation .....	3-52





# Machine Maintenance Procedures

---

## Introduction

---

This chapter contains general information about the computer, a list of tools needed to do the required maintenance and step by step procedures on how to remove and install components from the computer.

## General Information

---

The product previews seen in the following procedures may not represent the final product color or configuration. Cable paths and positioning may also differ from the actual model. During the removal and installation of components, make sure all available cable channels and clips are used and that the cables are installed in the same position.

All prerequisites must be completed prior to starting maintenance.

## Recommended Equipment

---

The following equipment are recommended to do the following maintenance procedures:

- Wrist grounding strap and conductive mat
- Flat screwdriver
- Philips screwdriver
- Plastic tweezers
- Flat plastic pry

**Table 3-1. Screw List**

Size	Quantity	Acer Part No.
M2.5*6.0	24	MM25060IL69
M2.5*3.5	6	MM25035ICI4
M2.0*3.0	18	MS20030ILX1
M2.5*4.0	6	MM25040IL60
M2.0*5.0	4	MS20050I028
M3.0*3.5	2	MS30035I354

# Maintenance Flowchart

The flowchart in Figure 3-1 shows a graphic representation of the module removal and installation sequences. It shows information on what components may need to be removed and installed during servicing.

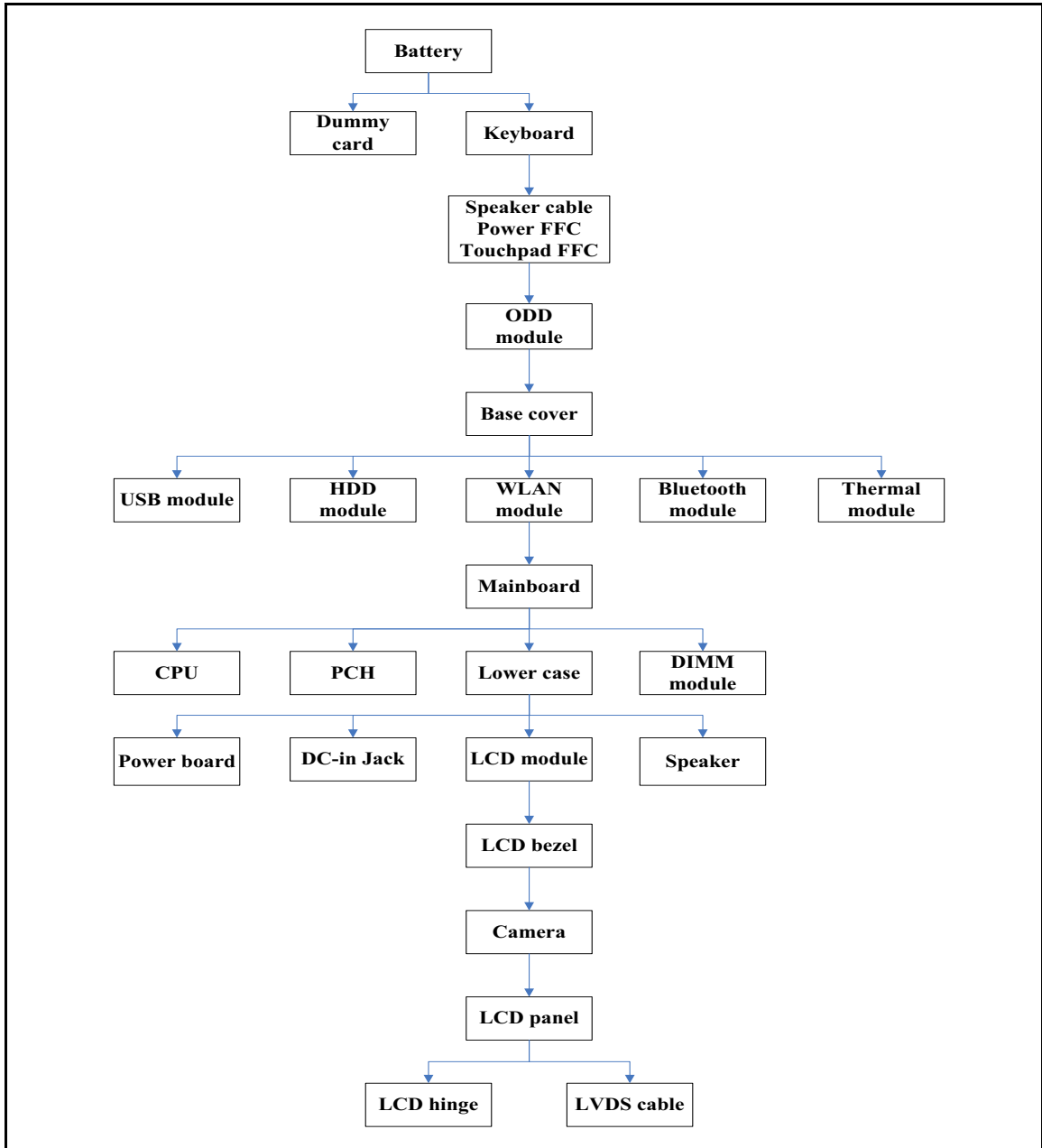

Figure 3-1. Maintenance Flow

# Getting Started

---

Flowchart [Figure 3-1](#) identifies sections for the removal and install sequence. Follow the order of the sequence to avoid damage to any of the hardware components.

Do the following prior to starting any maintenance procedures:

1. Remove power (A) from the system and peripherals.
2. Remove all cables from system.



---

**Figure 3-2. AC Adapter Outlet**

3. Put system on a stable work surface.

# Battery Pack Removal

---

1. Place computer on flat surface, battery side up.
2. Push battery lock/unlock latch (A) to unlock position (Figure 3-3).
3. Push and hold battery release latch (B) to release position (Figure 3-3).
4. Lift battery pack (C) from battery bay (Figure 3-3).

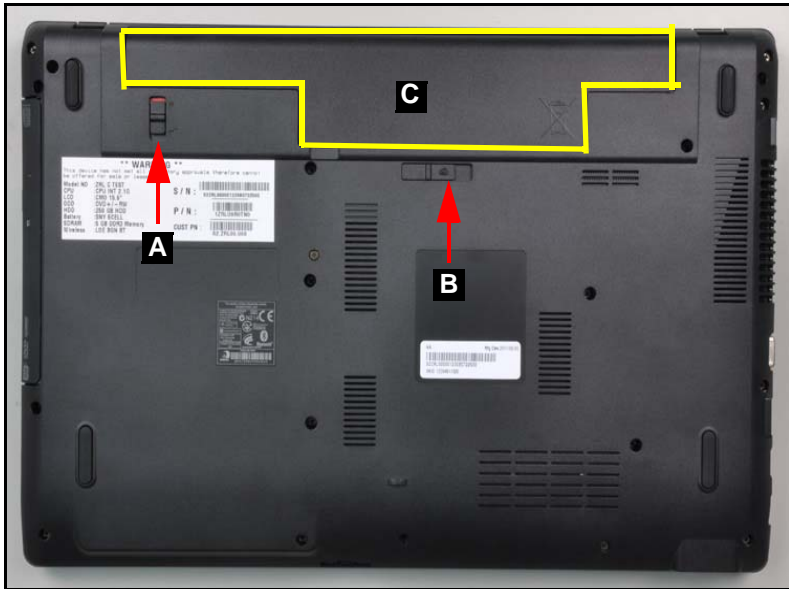

---

**Figure 3-3. Battery**

+ **IMPORTANT:**

Follow local regulations for battery (C) disposal (Figure 3-3).

# Battery Pack Installation

---

1. Hold latch (B) in release position and install battery (C) (Figure 3-3).
2. Lock battery lock/unlock latch (A) (Figure 3-3).

## Dummy Card Removal

---

1. Push the dummy card (A) in to release it from the spring latch (Figure 3-4).
2. Remove the dummy card (A) (Figure 3-4).

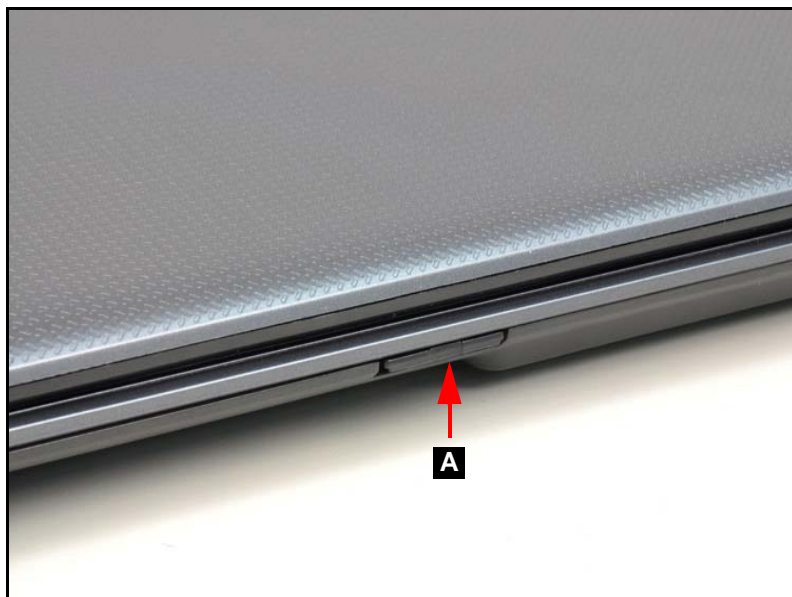

---

**Figure 3-4. Dummy Card**

## Dummy Card Installation

---

1. Insert the dummy card (A) (Figure 3-4).
2. Push the card until the spring latch locks.

# Keyboard Removal

---

## Prerequisite:

### Battery Pack Removal

1. Release six (6) latches from the keyboard (Figure 3-5).



**Figure 3-5. Keyboard Latches**

2. Turn the keyboard over so that the keys are face down on the upper case (C) (Figure 3-6).
3. Disconnect the keyboard FPC (A) from the mainboard connector (B) (Figure 3-6).

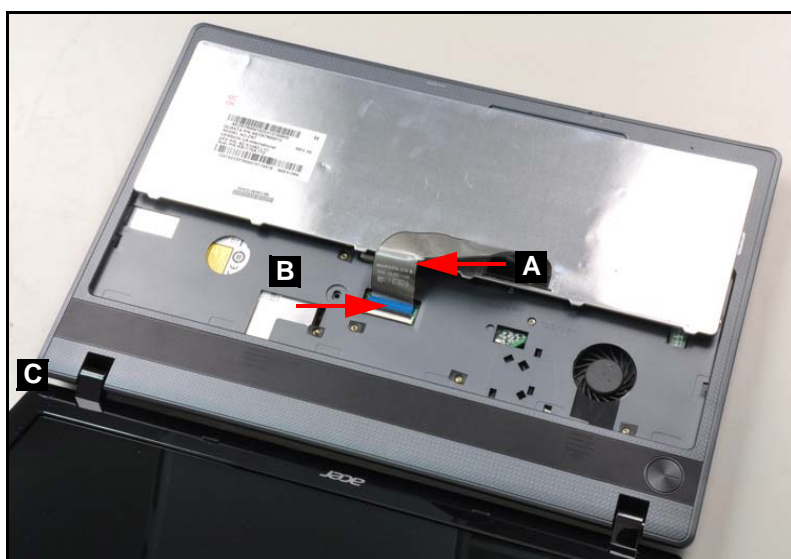

**Figure 3-6. Keyboard FPC**

**⚠ CAUTION:**

Keyboard FPC (Flexible Printed Circuit) can be damaged if removed while the mainboard connector is locked.

## Keyboard Installation

---

1. Put the keyboard face down on the upper case (C). Refer to [Figure 3-6](#).
2. Connect the keyboard FPC (A) to the mainboard connector (B). Refer to [Figure 3-6](#).
3. Turn the keyboard over and align the keyboard with the indentation in the upper cover.
4. Press down to secure the latches on the upper cover. Refer to [Figure 3-5](#).
5. Install the battery.

## UpperCase Screws and FFC Removal

---

### Prerequisite:

#### Keyboard Removal

1. Disconnect the touchpad cable (A), speaker cable (B) and power cable (C) (Figure 3-7).

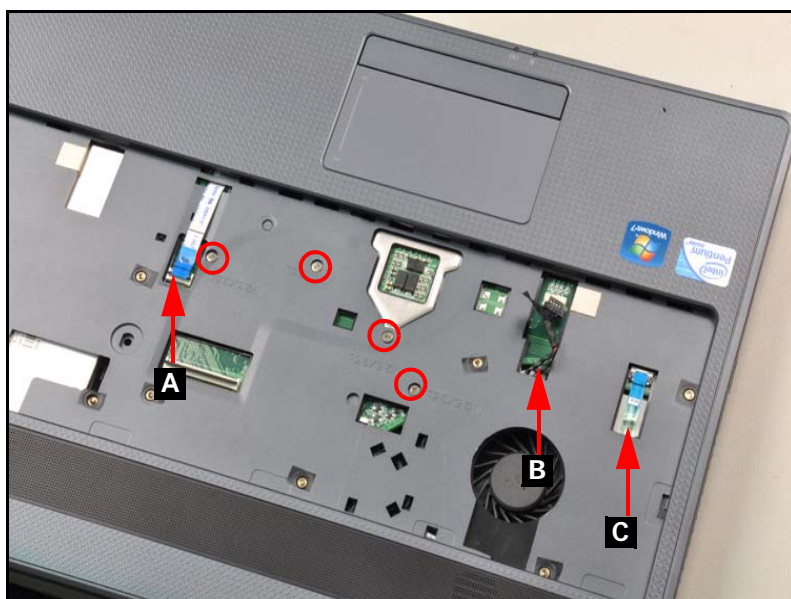

**Figure 3-7. Base Cover Screw Removal**

2. Remove the four (4) screws from the upper case (Figure 3-7).

## UpperCase Screws and FFC Installation

---

3. Secure the four (4) screws. Refer to [Figure 3-7](#).
4. Connect the touchpad cable, speaker cable and the power cable.
5. Install the keyboard.

ID	Size	Quantity	Screw Type
Red Call out	M2.5*3.5	4	



# ODD (Optical Disk Drive) Module Removal

---

## Prerequisite:

### Battery Pack Removal

1. Remove one (1) screw (A) from lower cover (Figure 3-8).

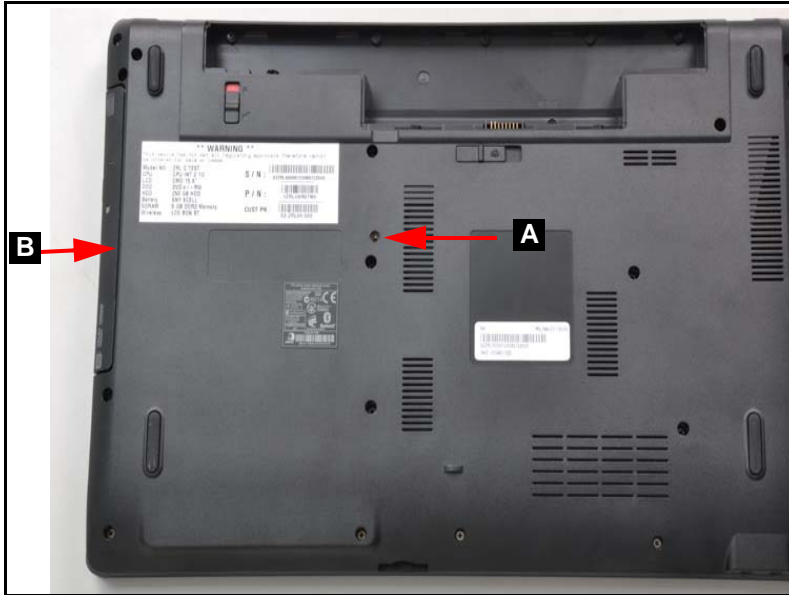

**Figure 3-8. ODD Module in Lower Cover**

2. Remove ODD module from ODD bay (B) (Figure 3-8).
3. Remove ODD bezel (C) from ODD module (Figure 3-9).



**Figure 3-9. ODD bezel Removal**

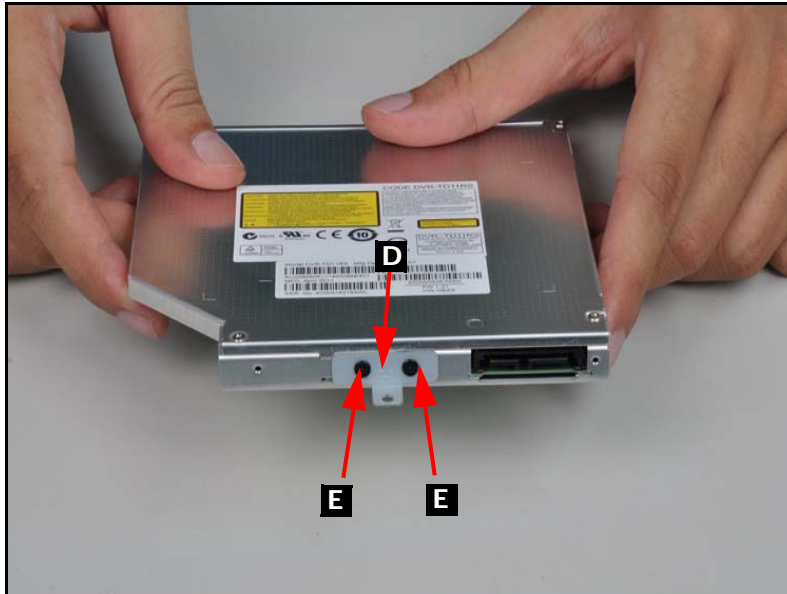

4. Remove two (2) screws (E) from ODD module (Figure 3-10).
5. Remove ODD bracket (D) from ODD module (Figure 3-10).



**Figure 3-10. ODD bracket Removal**

## ODD Module Installation

1. Install the ODD bracket (D) to the ODD module. Refer to [Figure 3-10](#).
2. Secure two (2) screws. Refer to [Figure 3-10](#).
3. Install the ODD bezel to the module and press down to secure it. Refer to [Figure 3-9](#).
4. Place the ODD module into the ODD bay. Refer to [Figure 3-8](#).
5. Install and secure one (1) screw to the base cover.
6. Install the battery.

ID	Size	Quantity	Screw Type
A	M2.5*6.0	1	
E	M2.0*3.0	2	

# Base Cover Removal

---

## Prerequisite:

### ODD (Optical Disk Drive) Module Removal

1. Remove twentythree (23) screws from the lower case (Figure 3-11).

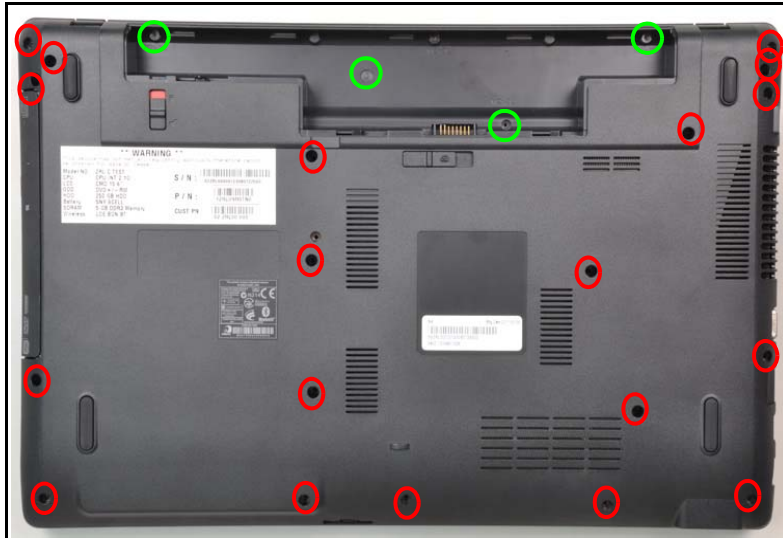

2. Remove the base cover.



---

**Figure 3-11. Outside Screws**

# Base Cover Installation

---

1. Install the base cover and press downward until the tab engages.
2. Secure twenty three (23) screws. Refer to [Figure 3-11](#).
3. Install the ODD.

ID	Size	Quantity	Screw Type
Red Call out	M2.5*6.0	19	
Green Call out	M2.0*3.0	4	

# USB Module Removal

---

## Prerequisite:

### Base Cover Removal

1. Disconnect USB module FFC (A) from USB module connector (B) (Figure 3-12).
2. Disconnect and remove USB module FFC (A) from mainboard connector (C)(Figure 3-12).

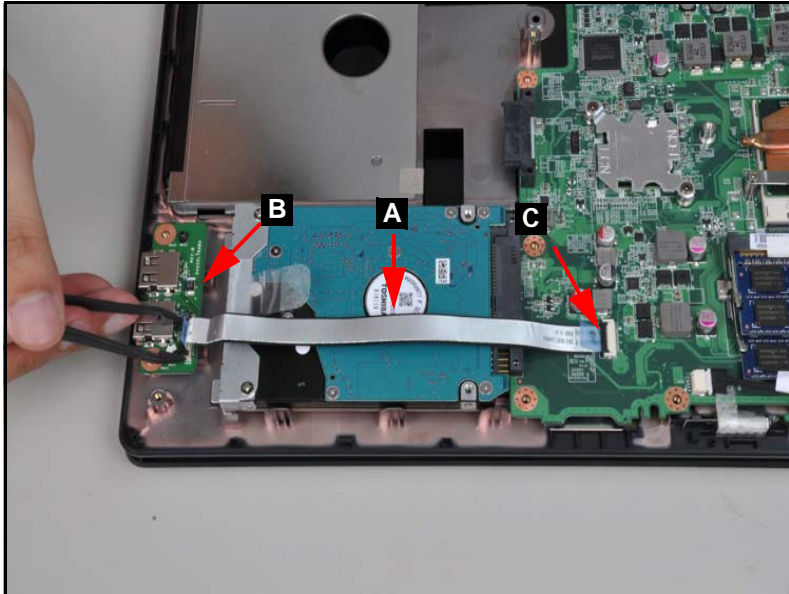

---

Figure 3-12. USB module

3. Remove screw (D) from lower cover (Figure 3-13)

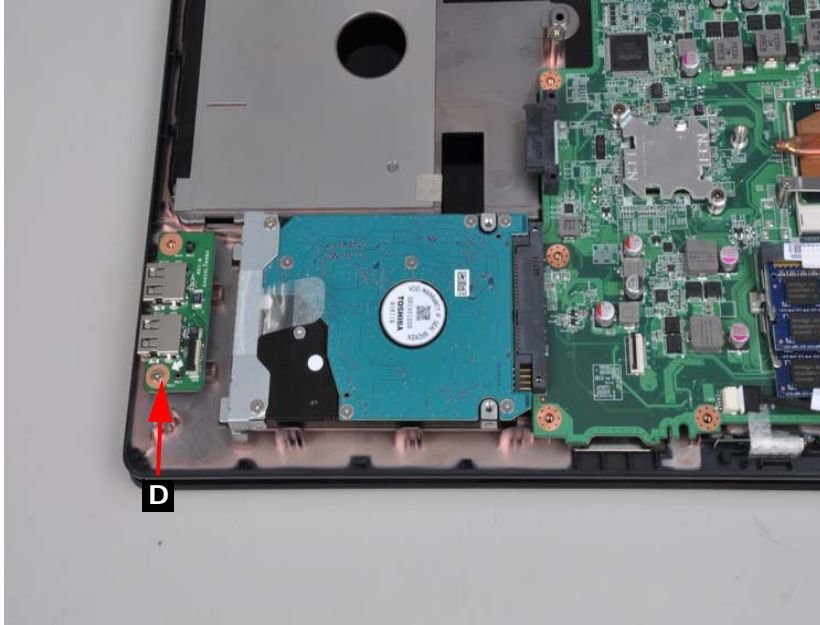

**Figure 3-13. USB screw**

4. Remove USB module from lower case.

## USB Module Installation

1. Install USB module on lower cover.
2. Install and secure screw (D) to lower cover (Figure 3-13).
3. Connect USB module FFC (A) to module connector (B) (Figure 3-12).
4. Connect USB module FFC (A) to mainboard connector (C) (Figure 3-12).
5. Install the base cover.

ID	Size	Quantity	Screw Type
D	M2.5*3.5	1	

# HDD (Hard Disk Drive) Removal

---

## Prerequisite:

### [USB Module Removal](#)

1. Using the pull-tab, slide the HDD module in the direction of the arrow to disconnect the interface. (Figure 3-14).



---

**Figure 3-14. HDD Location**

2. Remove the HDD module as shown in Figure 3-15.

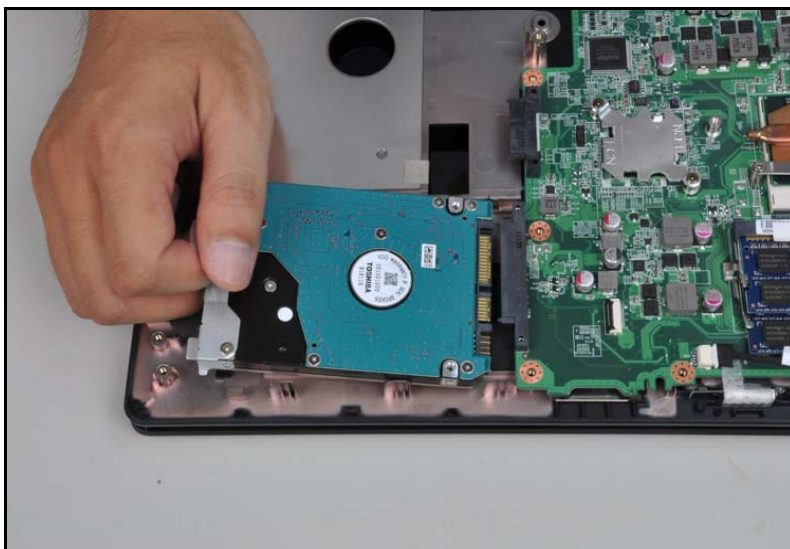

---

**Figure 3-15. HDD Removal**

- Remove four (4) screws (A) from HDD bracket (B) Figure 3-15.

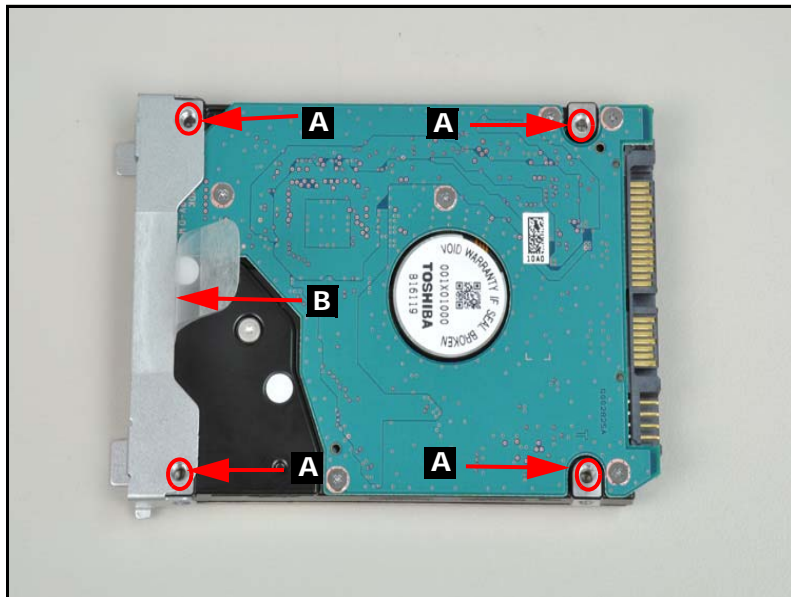

**Figure 3-16. HDD Module**

- Remove HDD bracket (D) from HDD module.

## Hard Disk Drive Installation

- Put HDD brackets ont HDD module (Figure 3-16).
- Instal four (4) screws (C) and secure HDD brackets (D) to HDD module (Figure 3-16).
- Install the hard drive into the hard drive compartment. (Figure 3-15).
- Install the USB module.

ID	Size	Quantity	Screw Type
C	M3*3.5	4	



# RTC (Real Time Clock) Battery Removal

---

## Prerequisite:

[Base Cover Removal](#)

1. Lift the RTC battery away from the mainboard ([Figure 3-18](#)).

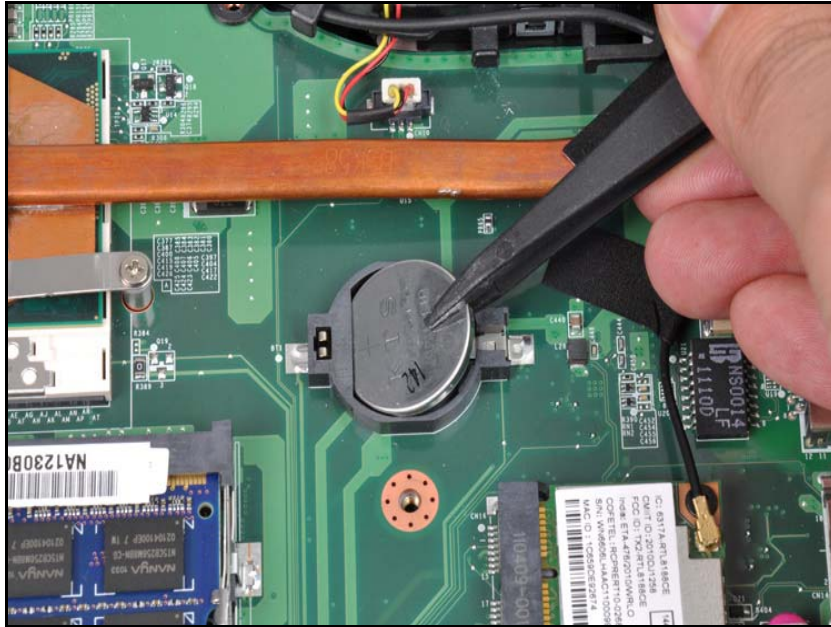

---

**Figure 3-17. RTC battery**

+ **IMPORTANT:**

Follow local regulations for battery (C) disposal ([Figure 3-17](#)).

## RTC Battery Installation

---

1. Place the RTC battery into the mainboard connector. Refer to [Figure 3-18](#).
2. Install the base cover.



# WLAN (Wireless Local Area Network) Module Removal

---

## Prerequisite:

### [Base Cover Removal](#)

1. Find the WLAN module (B) ([Figure 3-18](#)).
2. Disconnect antenna cables (A) from module ([Figure 3-18](#)).

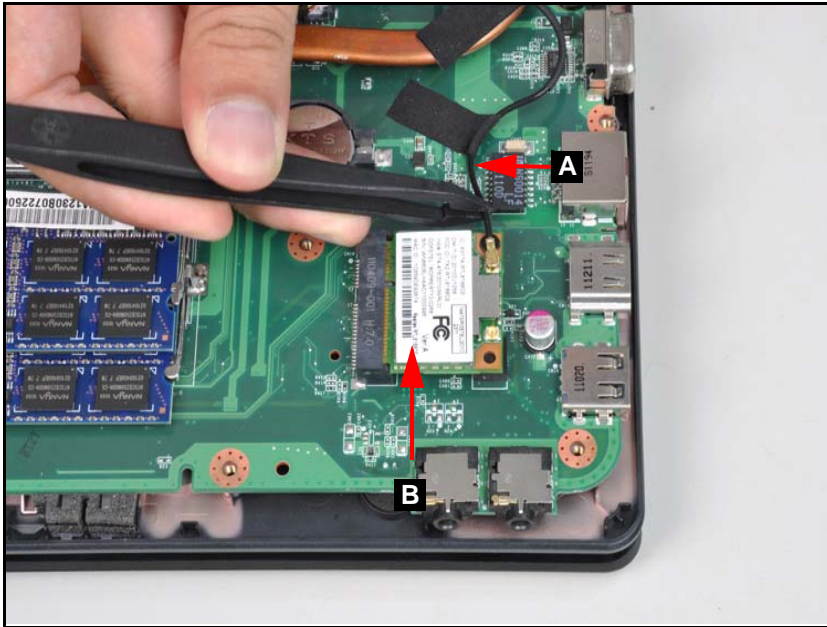

---

**Figure 3-18. WLAN Module**

3. Remove one (1) screw (C) from the mainboard. Refer to [Figure 3-19](#).

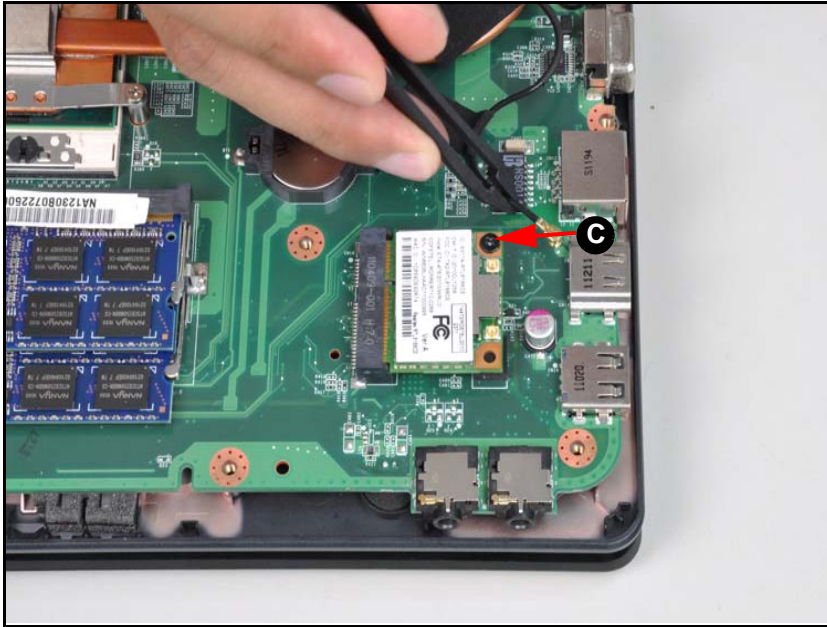

**Figure 3-19. WLAN Module**

4. Disconnect antenna cables (D) from module (Figure 3-20).

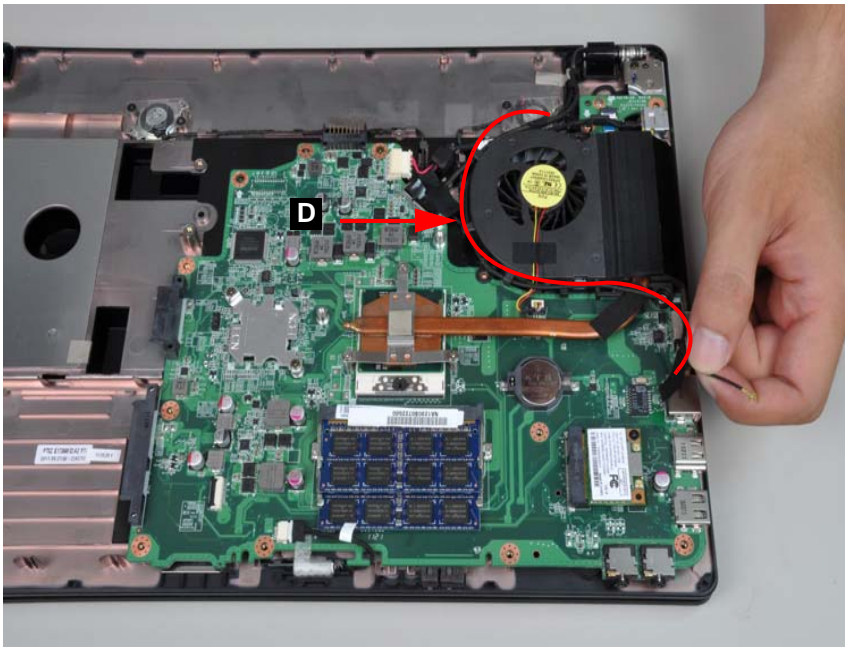

**Figure 3-20. WLAN Module**

5. Remove the WLAN module from the mainboard connector (E). Refer to Figure 3-21.

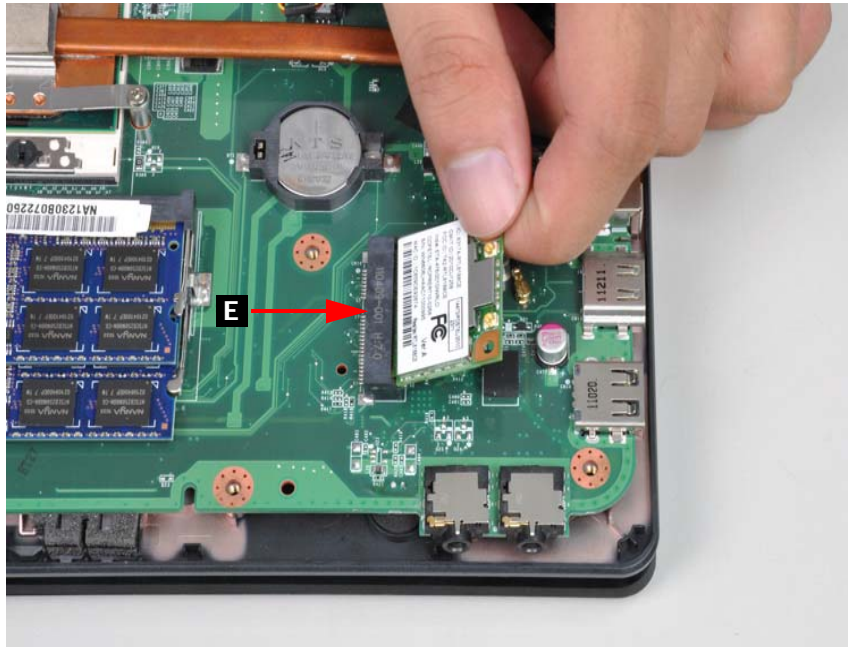

**Figure 3-21. WLAN Module**

## WLAN Module Installation

1. Place the WLAN module into the mainboard connector (E). Refer to [Figure 3-21](#).
2. Secure the antennas to the cable guides on the thermal module. Refer to [Figure 3-20](#).
3. Install and secure one (1) screw (C) to mainboard. Refer to [Figure 3-19](#).
4. Install the antenna cables on WLAN module. Refer to [Figure 3-18](#).
5. Install the base cover.

ID	Size	Quantity	Screw Type
C	M2.0*3.0 NI	1	

# Bluetooth Module Removal

---

## Prerequisite:

### Base Cover Removal

1. Find the Bluetooth Module on the lower case (A) (Figure 3-22).
2. Disconnect the Bluetooth cable (B) from the mainboard connector (C).

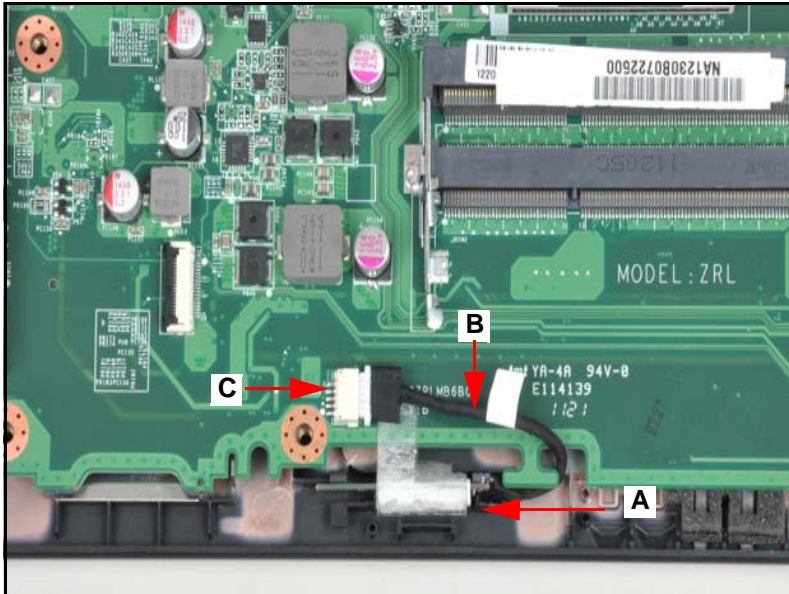

**Figure 3-22. Bluetooth Module**

3. Remove the mylar tape (D) (Figure 3-23).

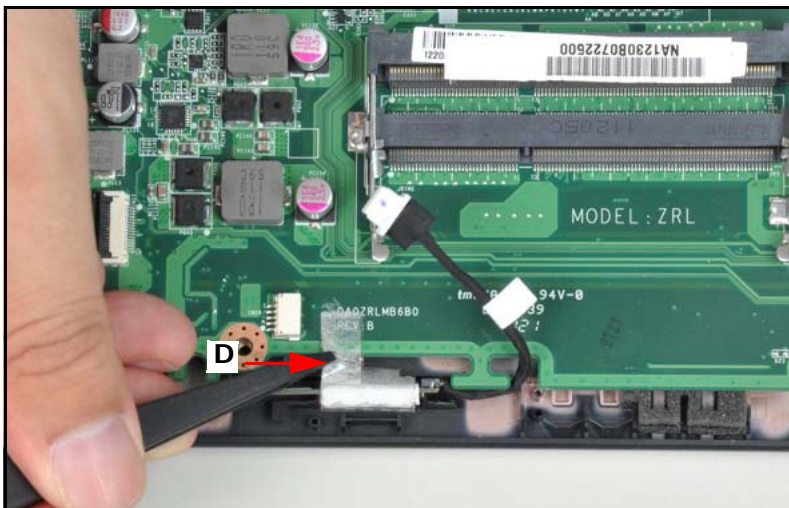

**Figure 3-23. Bluetooth Module**

4. Remove the Bluetooth Module from the lower case.
5. Disconnect the bluetooth cable (B) from the bluetooth module (E) (Figure 3-24).

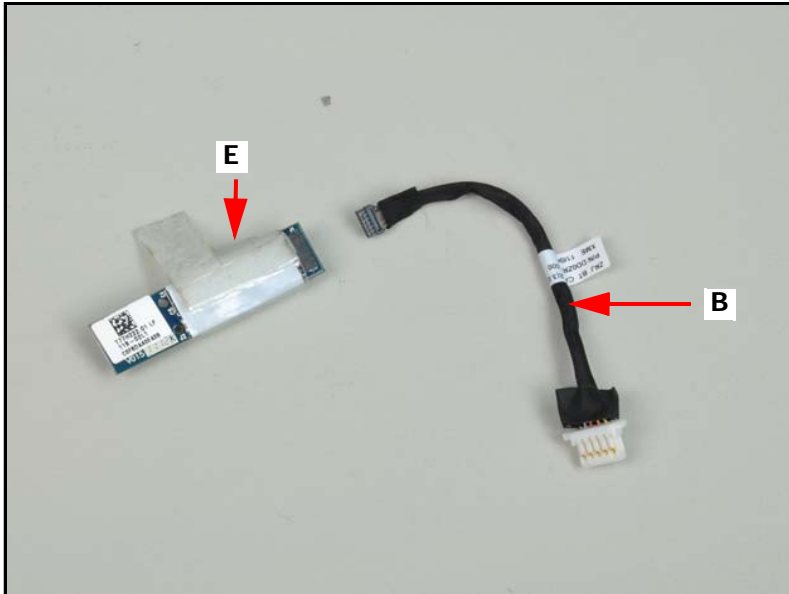

---

**Figure 3-24. Bluetooth Module**

## Bluetooth Module Installation

---

1. Connect the Bluetooth cable (B) to the bluetooth module (Figure 3-23).
2. Connect the Bluetooth cable (B) to the mainboard connector (C) (Figure 3-22).
3. Install the base cover.



# Thermal Module Removal

---

## Prerequisite:

[Base Cover Removal](#)

1. Disconnect the thermal fan cable (A) from the mainboard connector (B) ([Figure 3-25](#)).
2. Remove four (4) screws from the thermal module ([Figure 3-25](#)).

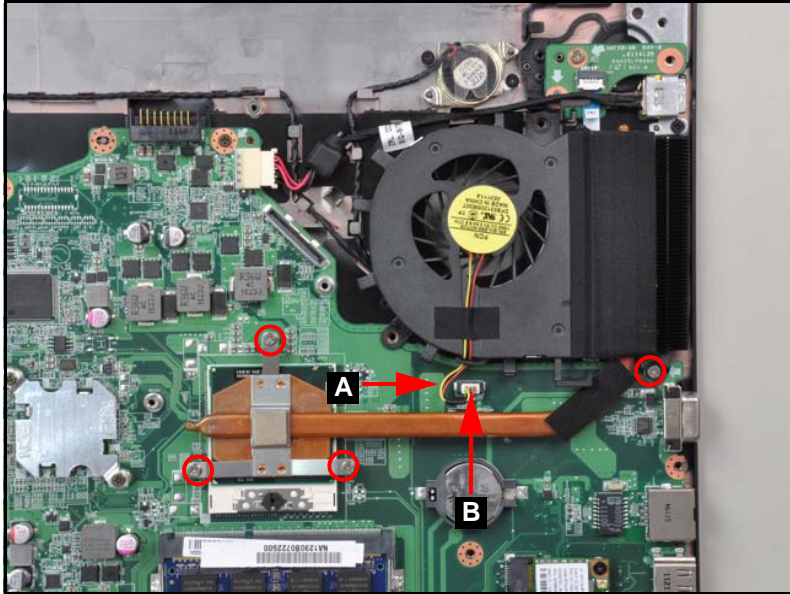

---

**Figure 3-25. Thermal Module**

3. Remove the thermal module from the mainboard as shown in Figure 3-26.

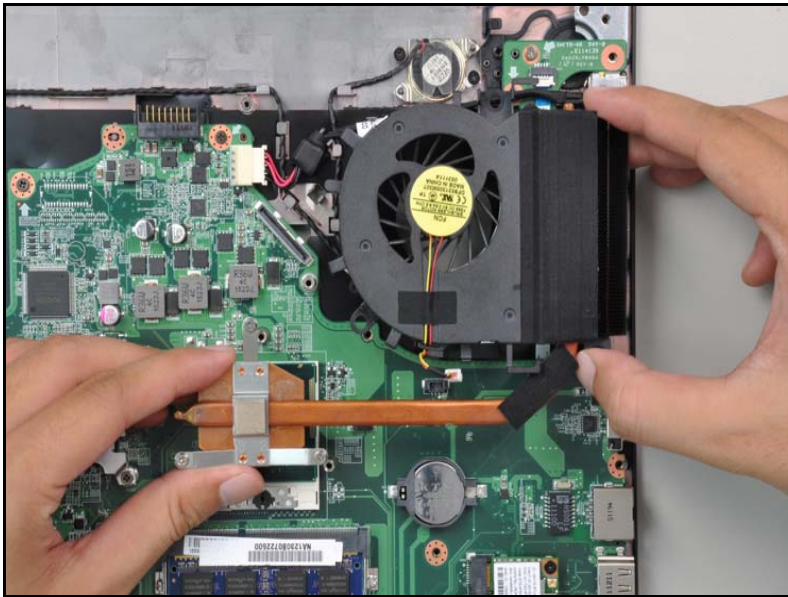

**Figure 3-26. Thermal Module Removal**

## Thermal Module Installation

**+ IMPORTANT:**

Apply approved thermal grease and ensure all heat pads are in position before replacing module.

**⚠ CAUTION:**

Use caution when applying thermal grease. Thermal grease may cause damage to the mainboard.

The following thermal grease types are approved for use:

- Silmore GP50
- Honeywell
- Jet Motor 7762

The following thermal pads are approved for use:

- Eapus XR-PE
1. Remove all traces of thermal grease from CPU using a lint-free cloth or cotton swab and Isopropyl Alcohol, Acetone, or other approved cleaning agent.
  2. Apply small amount of thermal grease to center of CPU.

**⇒ NOTE:**

Force used during installation of thermal module is sufficient to spread grease evenly over CPU top.

3. Install and secure four (4) non-captive screws to mainboard. (Figure 3-25).
4. Connect thermal module cable (A) to mainboard connector (B). (Figure 3-25).
5. Install the base cover.

ID	Size	Quantity	Screw Type
Red Call out	M2.5*3.5	4	



# Mainboard Removal

---

## Prerequisite:

### [Bluetooth Module Removal](#)

1. Find the mainboard on the lower case (Figure 3-27).

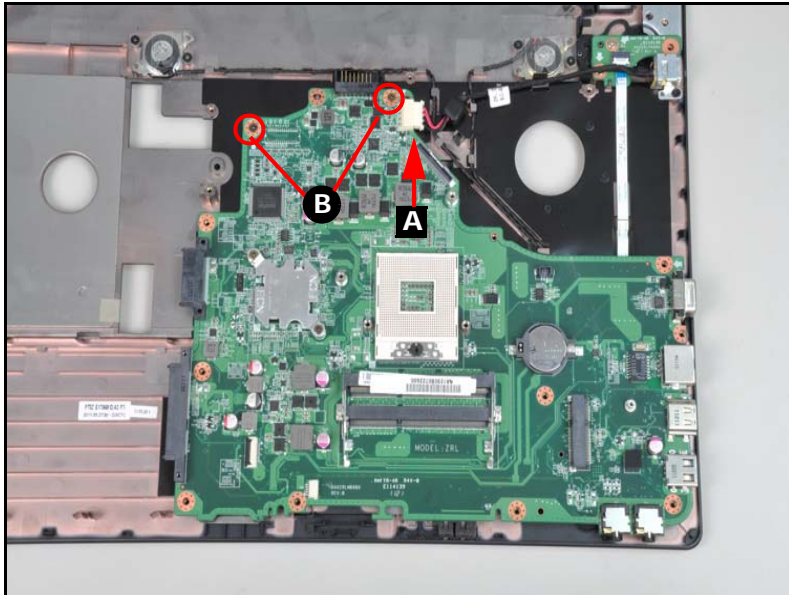
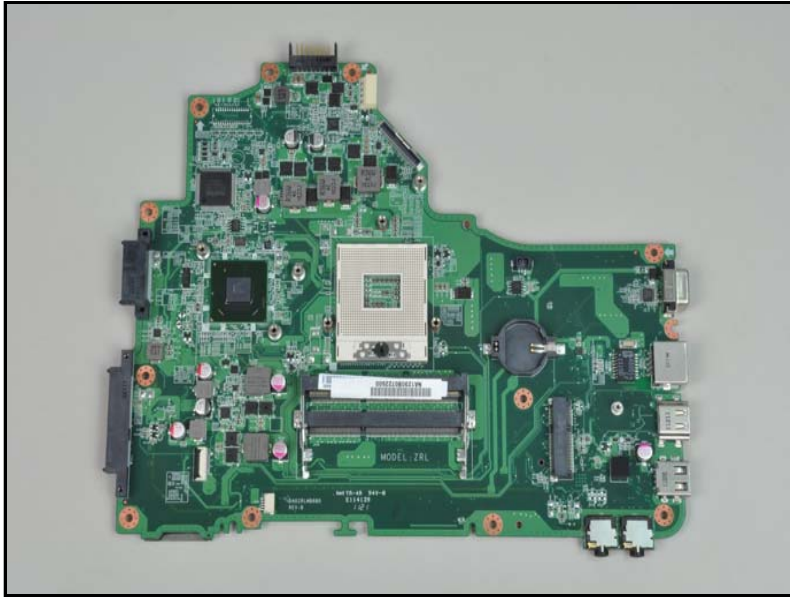

**Figure 3-27. Mainboard Location**

2. Disconnect the speaker cable from the mainboard connector (A) (Figure 3-27).
3. Remove two (2) screws (B) from the mainboard (Figure 3-27).
4. Remove the mainboard by lifting it from the lower case.

### **⚠ CAUTION:**

Make sure all cables are moved away from the device to avoid damage during removal.



**Figure 3-28. Mainboard**

+ **IMPORTANT:**

The mainboard is shown in the above image. Please follow local regulations for disposal.

## Mainboard Installation

1. Place the mainboard onto the lower case ([Figure 3-27](#)).
2. Install and secure two (2) screws (B) to the mainboard ([Figure 3-27](#)).
3. Connect the speaker cable to the mainboard connector (A) ([Figure 3-27](#)).
4. Install the Bluetooth module.

ID	Size	Quantity	Screw Type
B	M2.5*3.5	2	

# CPU (Central Processing Unit) Removal

---

## Prerequisite:

[Mainboard Removal](#)

1. Using a slotted screw driver, rotate the CPU camlock (A) 180° counter-clockwise (Figure 3-29).

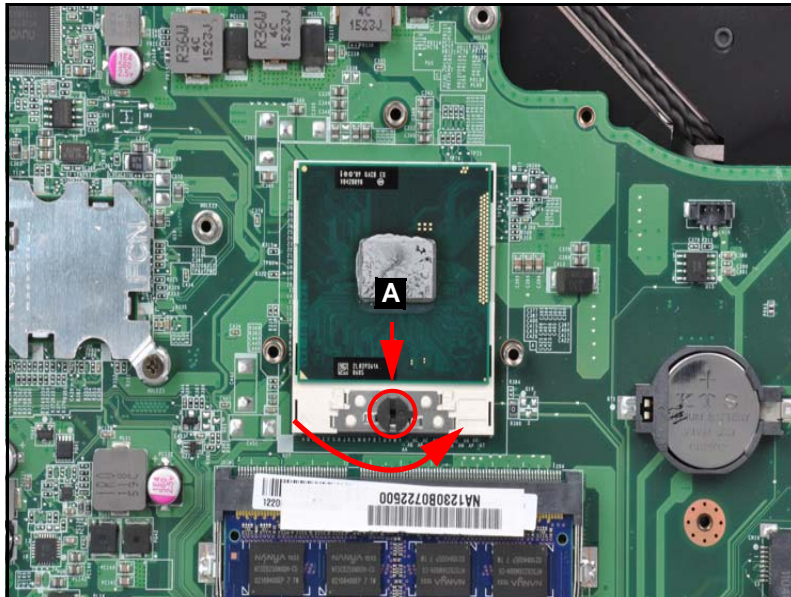

---

**Figure 3-29. CPU Removal**

2. Carefully lift the CPU clear of the socket (Figure 3-30).

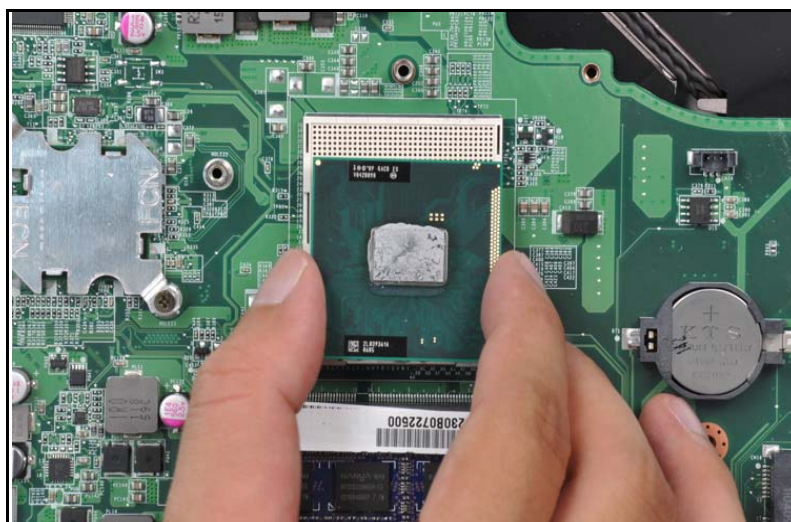

---

**Figure 3-30. CPU Removal**

**IMPORTANT:** Place the CPU on a clean, dry surface when it is not installed.

## CPU Installation

---

1. Place the CPU into the CPU socket ([Figure 3-29](#)).
2. Using a slotted screw driver, rotate the CPU locking screw 180° clockwise to secure it in the package.
3. Install the mainboard.

ID	Size	Quantity	Screw Type
A	M2.5*3.5	1	

# PCH (Platform Controller Hub) Removal

---

## Prerequisite:

### [Mainboard Removal](#)

1. Find the PCH (A). Refer to Figure 3-31.
2. Remove the two (2) screws from the mainboard (Figure 3-31).

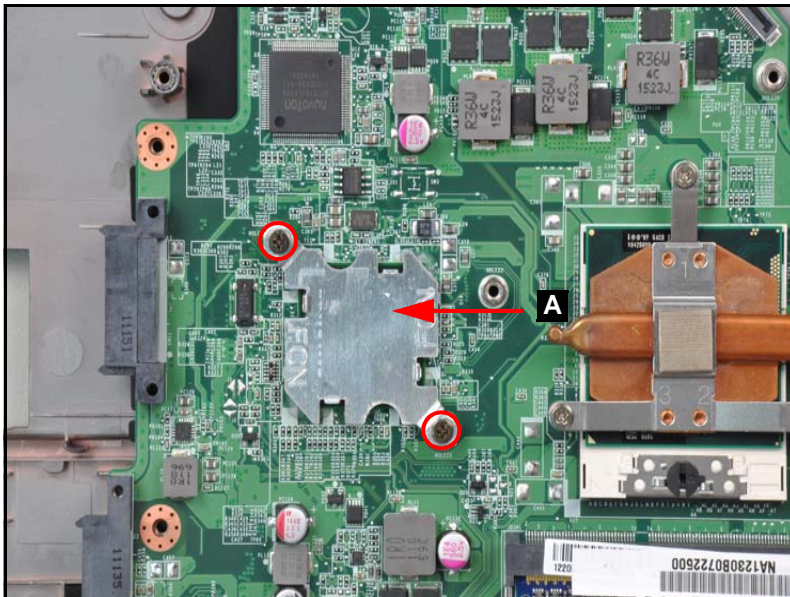

---

**Figure 3-31. PCH screws Removal**

3. Remove the PCH by lifting it from the mainboard (Figure 3-32).

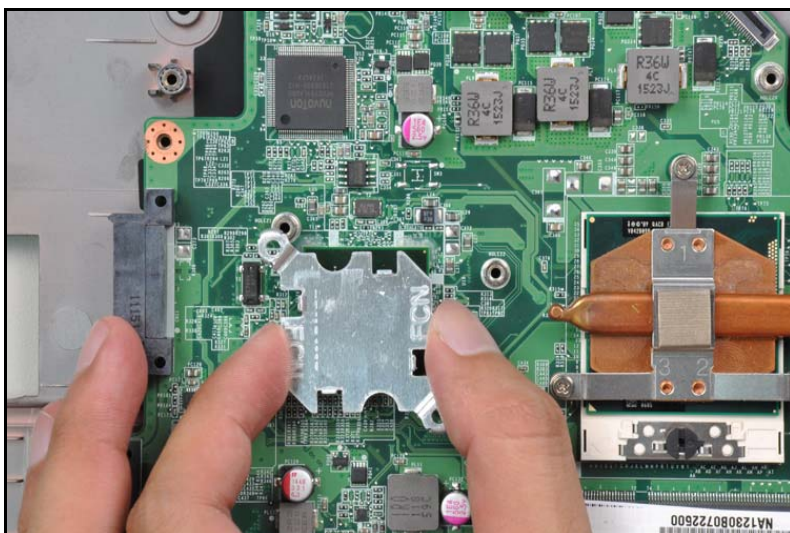

---

**Figure 3-32. PCH Removal**



# PCH Installation

---

- 1. Place the PCH onto the mainboard ([Figure 3-32](#)).
- 2. Install and secure two (2) screws to the mainboard ([Figure 3-31](#)).
- 3. Install the mainboard.

ID	Size	Quantity	Screw Type
Red Call out	M2.5*3.5	2	

# DIMM (Dual In-line Memory Module) Removal

---

## Prerequisite:

[Mainboard Removal](#)

1. Push out the release latches on both sides of the DIMM socket to release the DIMM module (Figure 3-33).

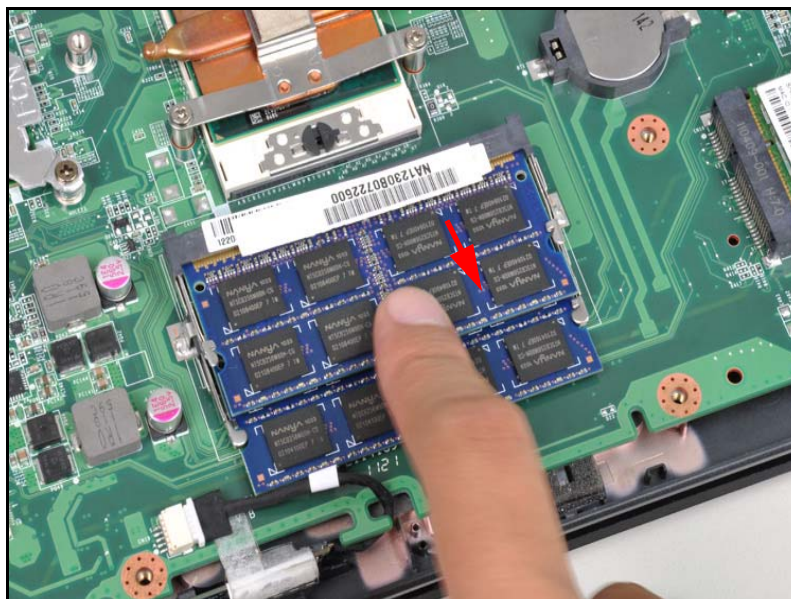

---

**Figure 3-33. DIMM Removal**

2. Remove the DIMM module (Figure 3-34).

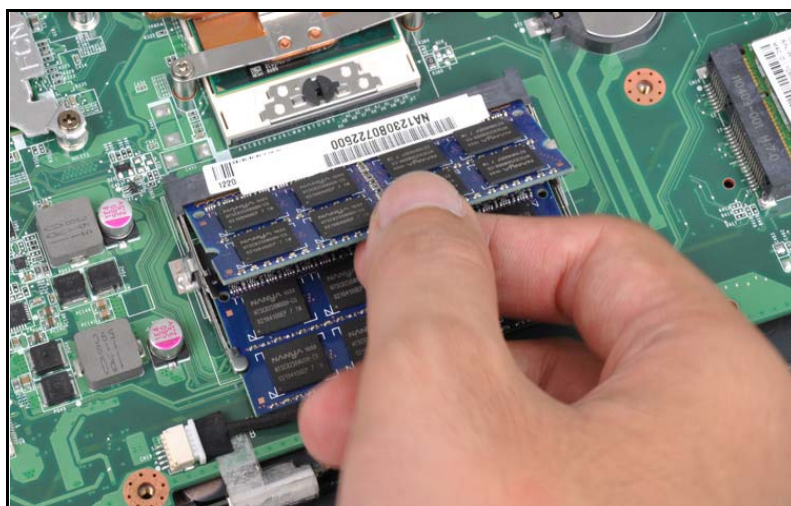

---

**Figure 3-34. DIMM Removal**

3. Repeat steps for the second DIMM module if present (Figure 3-34).

## DIMM Installation

---

1. Connect the DIMM to the mainboard connector (B). Refer to [Figure 3-34](#).
2. Push down on the DIMM until the module clips (A) lock into position. Refer to [Figure 3-34](#).
3. Install the mainboard.



## Power Board Removal

---

### Prerequisite:

[Mainboard Removal](#)

1. Remove the two (2) screws from the power board ([Figure 3-35](#)).

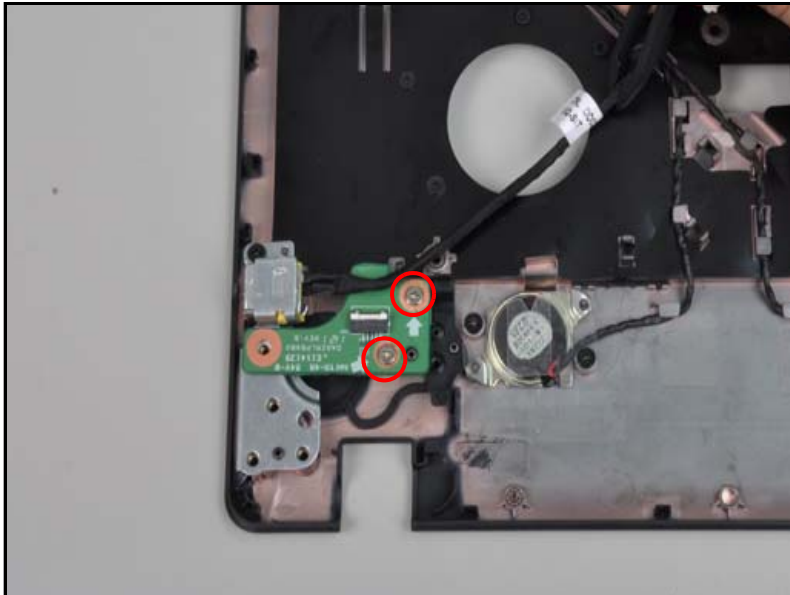

---

**Figure 3-35. Power board screws removal**

2. Remove the power board by lifting it from the lower case ([Figure 3-36](#)).

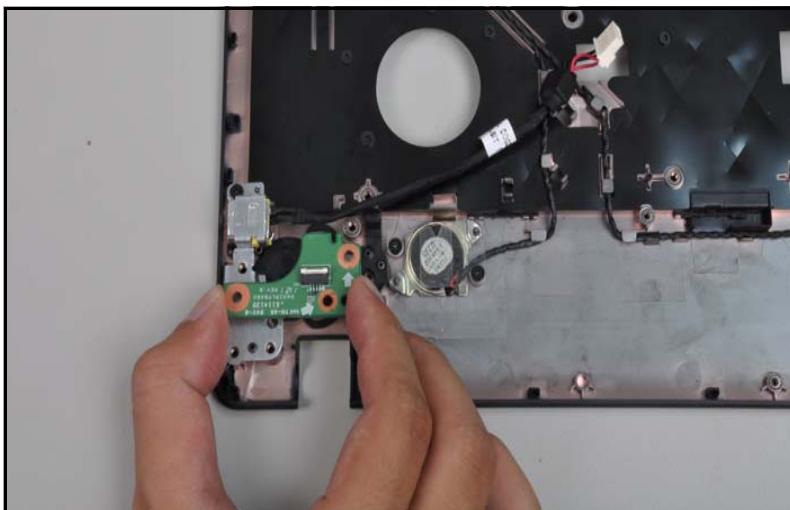

---

**Figure 3-36. Power board removal**

# Power Board Installation

---

- 1. Place the power board onto the lower case and press down to secure it. Refer to Figure 3-36.
- 2. Install and secure two (2) screws to the power board. Refer to Figure 3-35
- 3. Install the mainboard.

ID	Size	Quantity	Screw Type
Red Call out	M2.5*3.5	2	

## DC-in Jack Removal

---

### Prerequisite:

[Mainboard Removal](#)

1. Remove the DC-in jack by lifting upwards from the lower case ([Figure 3-37](#)).

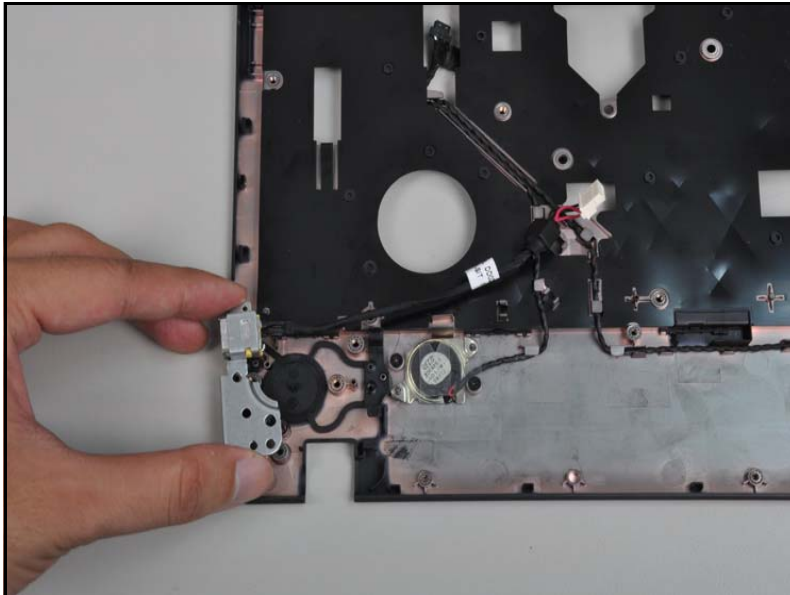

---

**Figure 3-37. DC-in jack removal**

2. Remove the bracket from the DC-in jack ([Figure 3-38](#)).

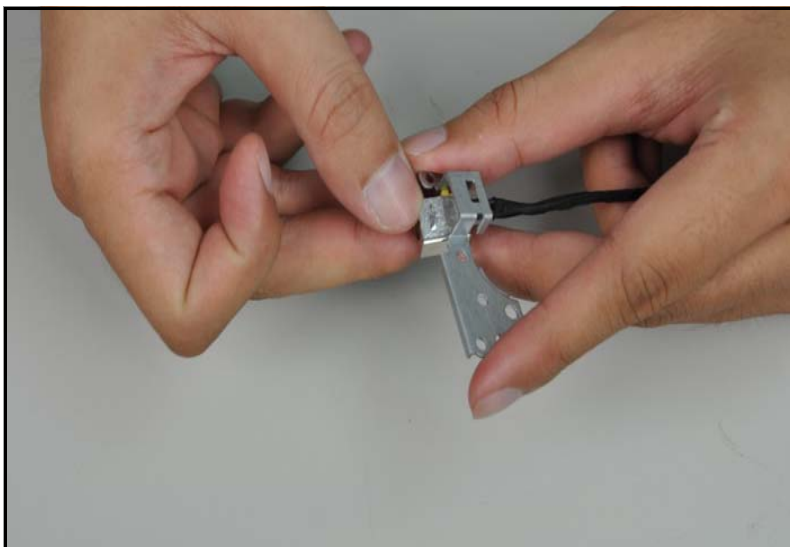

---

**Figure 3-38. DC-in jack bracket removal**

## DC-in Jack Installation

---

1. Place the bracket on the DC-in jack. Refer to Figure 3-38
2. Place the DC-in jack onto the lower case and press down to secure it. Refer to Figure 3-37.
3. Install the mainboard.

## Speakers Removal

---

### Prerequisite:

[Mainboard Removal](#)

1. Remove the speakers by lifting upwards from the lower case ([Figure 3-39](#)).

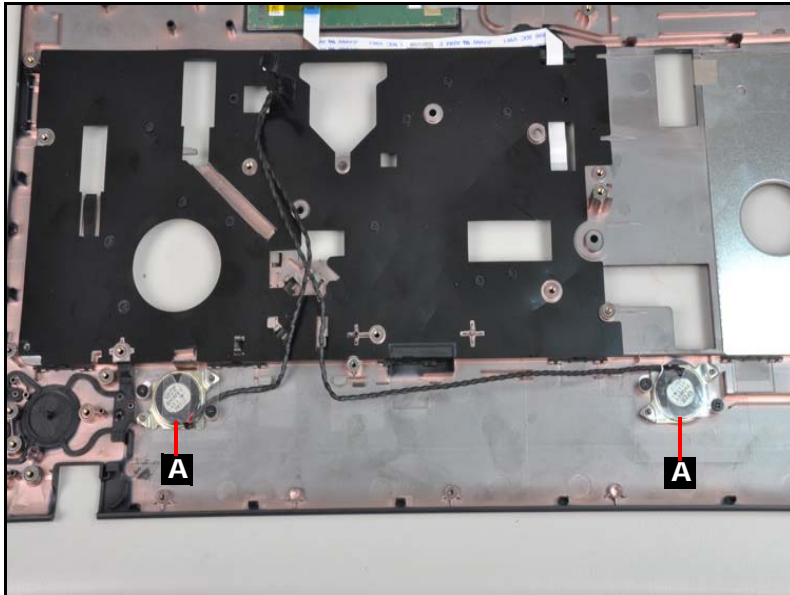

---

**Figure 3-39. Speakers**

## Speakers Installation

---

1. Place the speakers onto the lower case and press down to secure it. Refer to [Figure 3-39](#).
2. Install the mainboard.

# LCD (Liquid Crystal Display) Module Removal

---

## Prerequisite:

[Base Cover Removal](#)

1. Remove the two (2) screws (A) from the LCD hinges (Figure 3-40).

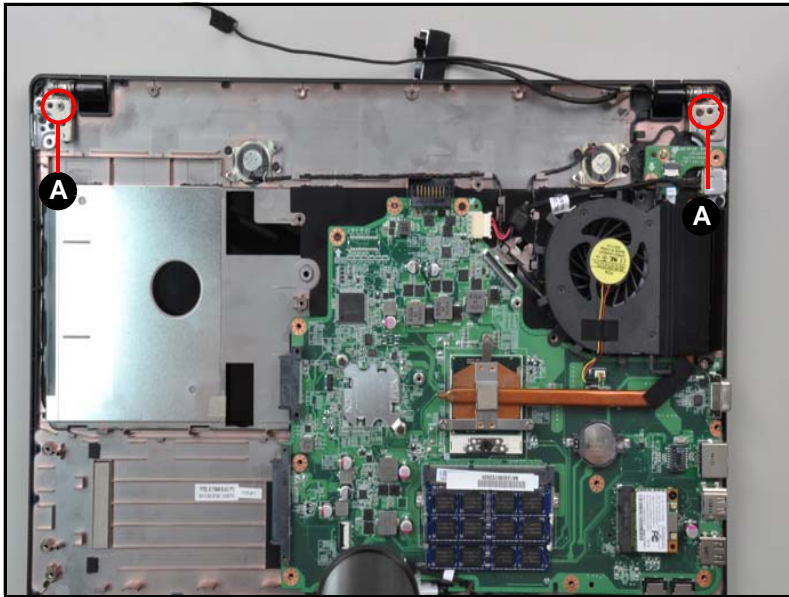

---

**Figure 3-40. LCD Hinge Screws**

2. Lift the lower case upward from the LCD module (Figure 3-41).

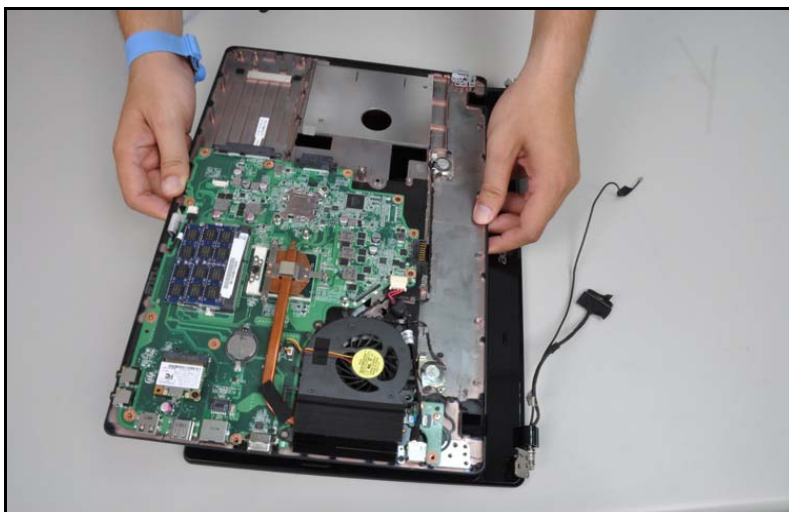

---

**Figure 3-41. LCD Module Removal**

**⚠ CAUTION:**

Make sure all cables are moved away from the device to avoid damage during removal.

## LCD Module Installation

---

1. Align the LCD hinges with the hinge guides on the lower case.
2. Install and secure two(2) screws (A). Refer to [Figure 3-40](#).
3. Install the base cover.

ID	Size	Quantity	Screw Type
A	M2.5*3.5	2	

## LCD Bezel Removal

---

### Prerequisite:

[LCD Module Removal](#)

1. Remove two (2) screws from the LCD module (Figure 3-42).



---

**Figure 3-42. LCD Bezel Screws**

2. Pry the bezel upwards at the base of the LCD module releasing it from the latches (Figure 3-43).



---

**Figure 3-43. LCD Bezel**



3. Continue along the sides of the bezel until all the latches have been released (Figure 3-44).



**Figure 3-44. LCD Bezel Removal**

4. Lift the bezel from LCD module.

## LCD Bezel Installation

1. Put LCD bezel on the LCD module. Refer to [Figure 3-44](#).
2. Press along the edges of the LCD bezel to secure the latches on the LCD module.
3. Install and secure two (2) screws to the LCD bezel. Refer to [Figure 3-42](#).
4. Install the LCD module.

ID	Size	Quantity	Screw Type
Red Call out	M2.5*6.0	2	

## Camera Module Removal

---

### Prerequisite:

[LCD Bezel Removal](#)

1. Lift the camera module from the LCD cover (Figure 3-45).

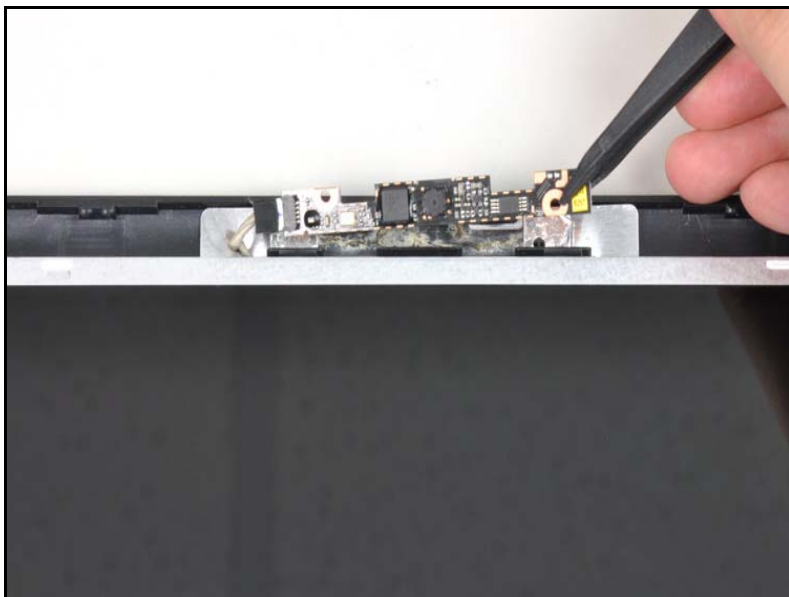

---

**Figure 3-45. Camera Module Removal**

2. Disconnect the cable as shown (Figure 3-46).

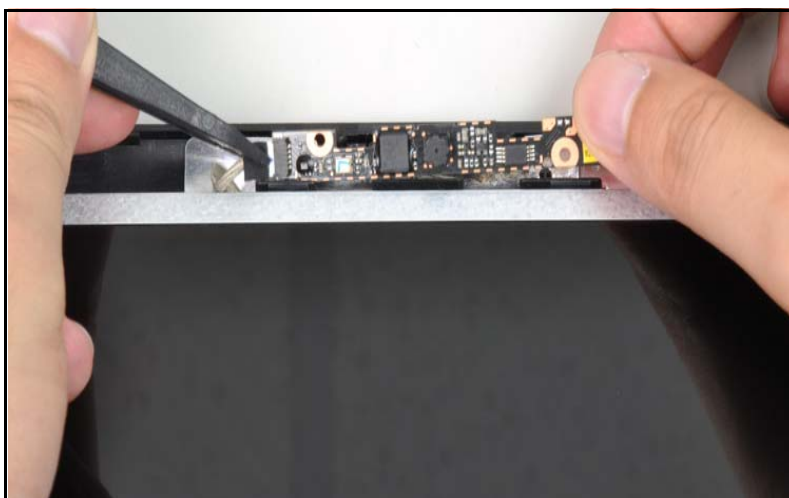

---

**Figure 3-46. Camera Module Removal**

3. Remove the camera module from the LCD cover.

## Camera Module Installation

---

1. Connect the camera cable. Refer to Figure 3-46.
2. Place the camera module on the LCD module. Refer to [Figure 3-45](#).
3. Install the LCD bezel.

## LCD Panel Removal

---

### Prerequisite:

[LCD Bezel Removal](#)

1. Remove the LCD cable (A) (Figure 3-47).

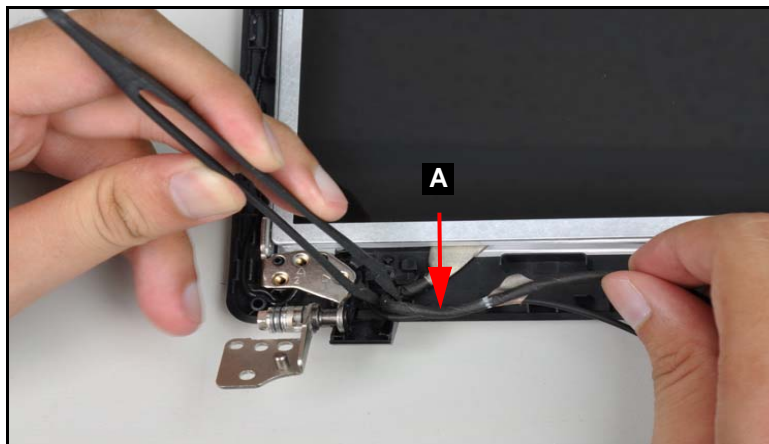

---

**Figure 3-47. Camera Disconnect**

2. Remove the four (4) screws (Figure 3-48).



---

**Figure 3-48. LCD Panel Screws**

3. Remove the LCD panel from the LCD cover.

# LCD Panel Installation

---

- 1. Place the LCD panel on the LCD cover. Refer to [Figure 3-48](#).
- 2. Install and secure four (4) screws to the LCD panel. Refer to [Figure 3-48](#).
- 3. Connect the camera cable (A) to the camera connector (B). Refer to [Figure 3-47](#).
- 4. Install the LCD bezel.

ID	Size	Quantity	Screw Type
Red Call out	M2.0*3.0 NI	4	

# LCD Hinge Removal

---

**Prerequisite:**

[LCD Panel Removal](#)

1. Remove the three (3) screws on each side of the hinge (Figure 3-49).

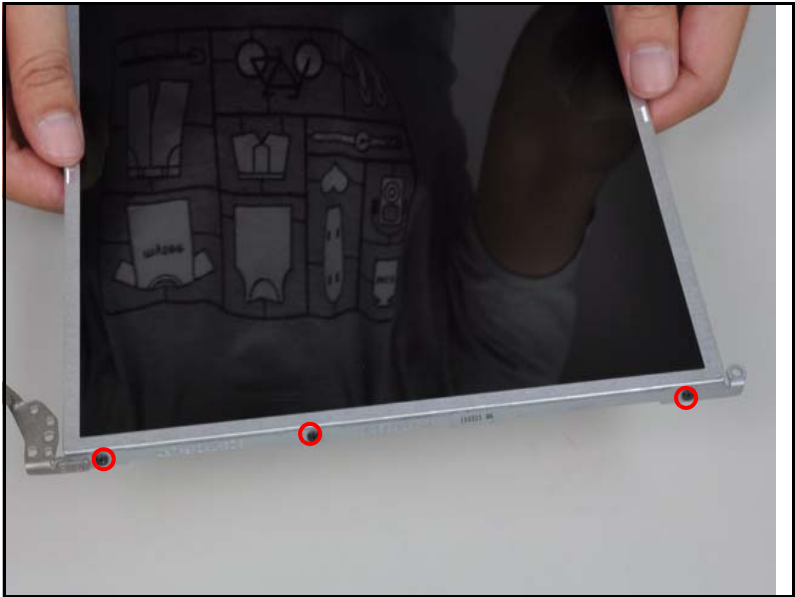

---

**Figure 3-49. LCD Hinges**

2. Remove LCD hinges from the LCD module.

# LCD Hinge Installation

---

1. Place the LCD hinges on the LCD module (Figure 3-49).
2. Install and secure the six (6) screws to the LCD hinges (Figure 3-49).
3. Install the LCD panel.

ID	Size	Quantity	Screw Type
Red Call out	M2.5*4.0	6	

# LVDS Cable Removal

---

## Prerequisite:

[LCD Panel Removal](#)

1. Remove the top mylar (A) and the adhesives on the rear of the LCD panel (Figure 3-50).



---

**Figure 3-50. LVDS Cable**

2. Remove the bottom mylar and disconnect the LVDS cable from the LCD panel connector (B) (Figure 3-51).

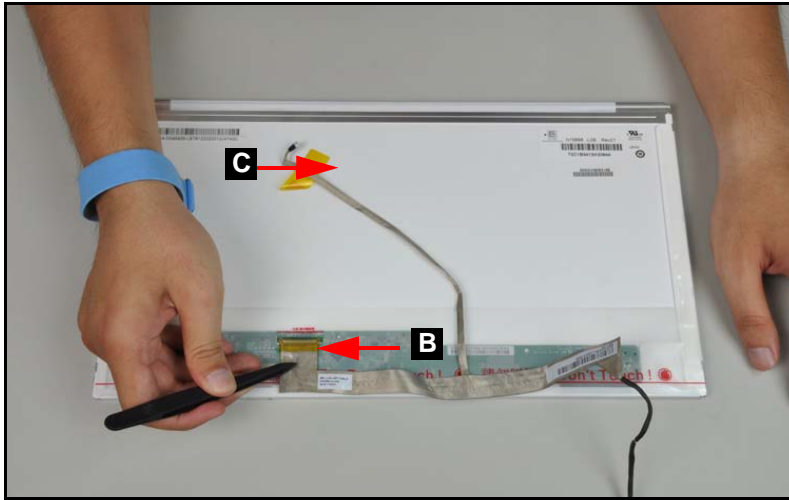

**Figure 3-51. LVDS Cable Connector**

## LVDS Cable Installation

1. Place the LVDS cable into the LCD panel connector (B) and secure the bottom mylar tape (C) (Figure 3-51).
2. Place the LVDS cable (A) on the rear of the LCD panel. Refer to [Figure 3-50](#).
3. Install the LCD panel.



# CHAPTER 4

## Troubleshooting

---

<b>Introduction</b> .....	<b>4-3</b>
<b>General Information</b> .....	<b>4-3</b>
Power On Issues .....	4-4
No Display Issues .....	4-5
LCD Failure .....	4-8
Keyboard Failure .....	4-9
Touchpad Failure .....	4-10
Internal Speaker Failure .....	4-11
Microphone Failure .....	4-13
USB Failure .....	4-14
Other Functions Failure .....	4-15
<b>Intermittent Problems</b> .....	<b>4-16</b>
<b>Undetermined Problems</b> .....	<b>4-16</b>
<b>Post Codes</b> .....	<b>4-17</b>

# Troubleshooting

---

## Introduction

---

This chapter contains information about troubleshooting common problems associated with the notebook.

## General Information

---

The following procedures are a guide for troubleshooting computer problems. The step by step procedures are designed to be performed as described.

**⇒ NOTE:**

The diagnostic tests are intended for Acer products only. Non-Acer products, prototype cards, or modified options can give false errors and invalid system responses.

1. Obtain as much detailed information as possible about the problem.
2. If possible, verify the symptoms by re-creating the failure through diagnostic tests or repeating the operation that led to the problem.
3. Use Table 4-1 with the verified symptom to determine the solution.

**Table 4-1. Common Problems**

Symptoms (Verified)
<a href="#">Power On Issues</a>
<a href="#">No Display Issues</a>
<a href="#">LCD Failure</a>
<a href="#">Keyboard Failure</a>
<a href="#">Touchpad Failure</a>
<a href="#">Internal Speaker Failure</a>
<a href="#">Microphone Failure</a>
<a href="#">USB Failure</a>
<a href="#">Other Functions Failure</a>
<a href="#">Intermittent Problems</a>
<a href="#">Undetermined Problems</a>

4. If the Issue is still not resolved, refer to [Online Support Information](#).

**⇒ NOTE:**

Do not replace non-defective FRU parts.

## Power On Issues

---

If the system does not power on, perform the following:

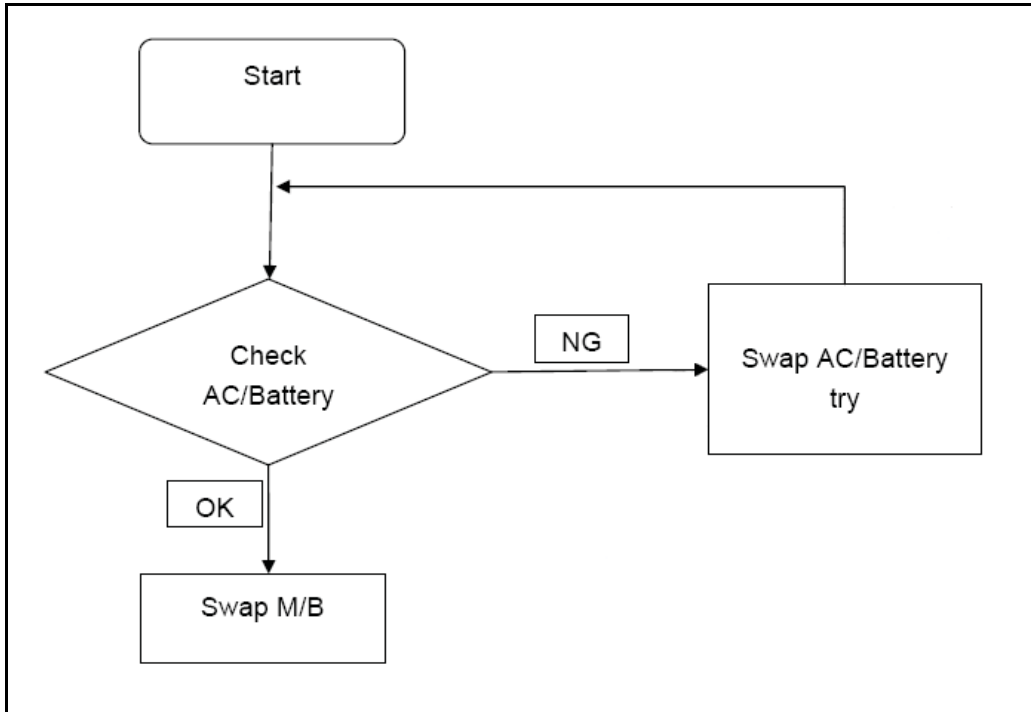

---

**Figure 4-1. Power On Issue**

### Computer Shuts Down Intermittently

If the system powers off at intervals, perform the following.

1. Make sure the power cable is properly connected to the computer and the electrical outlet.
2. Remove all extension cables between the computer and the outlet.
3. Remove all surge protectors between the computer and the electrical outlet. Plug the computer directly into a known serviceable electrical outlet.
4. Disconnect the power and open the casing to check the thermal unit and fan airways are free of obstructions.
5. Remove all external and non-essential hardware connected to the computer that are not necessary to boot the computer to the failure point.
6. Remove any recently installed software.
7. If the Issue is still not resolved, refer to [Online Support Information](#).

# No Display Issues

If the Display does not work, perform the following:

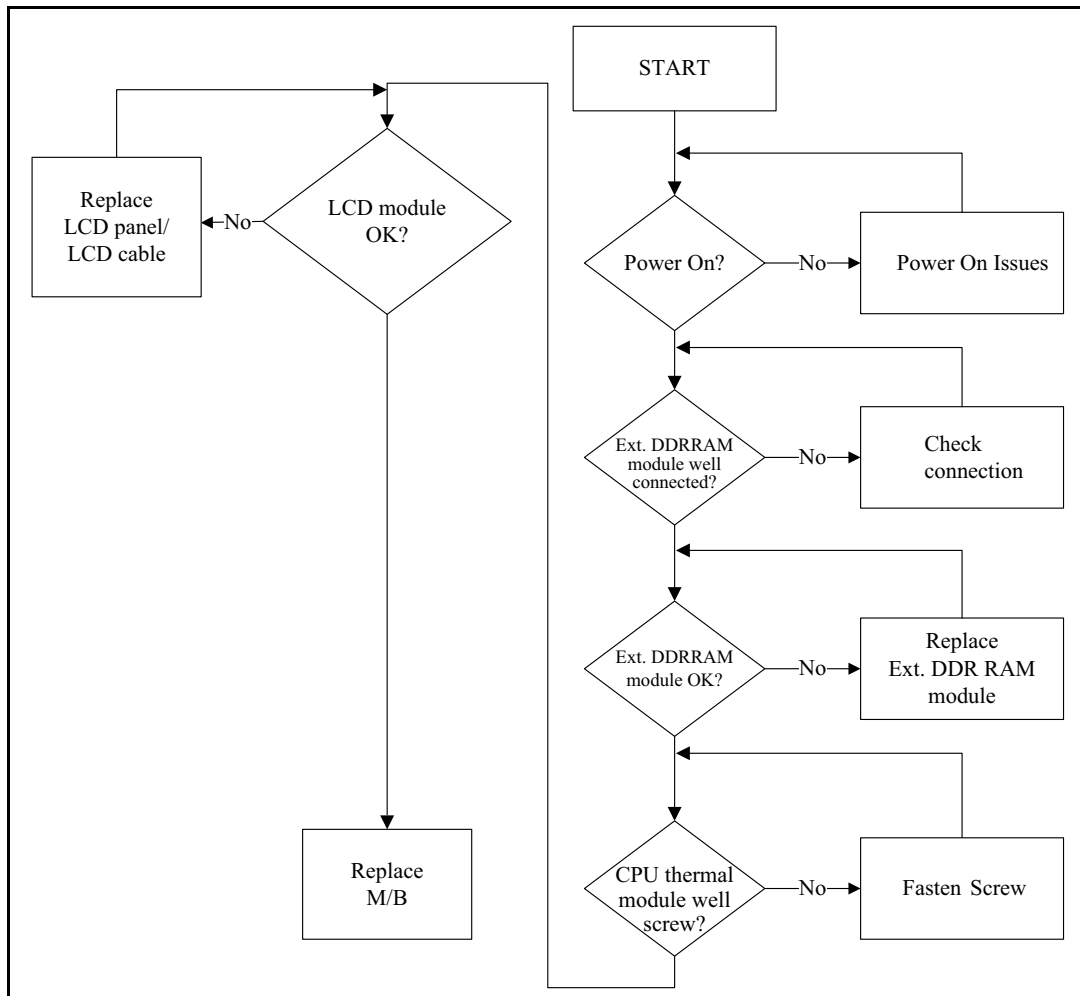

**Figure 4-2. No Display Issue**

## No POST or Video

If the POST or video does not appear, perform the following:

1. Make sure that internal display is selected. Switching between internal and external by pressing **Fn+F5**. Reference product pages for specific model procedures.
2. Make sure the computer has power by checking for one of the following:
  - Fans start up
  - Status LEDs illuminate

If no power, refer to [Power On Issues](#).

3. Drain stored power by removing the power cable and battery. Hold the power button for 10 seconds.

4. Connect the power and reboot the computer.
5. Connect an external monitor to the computer and switch between the internal display and the external display by pressing **Fn+F5**.
6. If the POST or video appears on the external display only, refer to [LCD Failure](#).
7. Disconnect power and all external devices including port replicators or docking stations. Remove any memory cards and CD/DVD discs.
8. Start the computer. If the computer boots correctly, add the devices one by one until the failure point is discovered.
9. Reseat the memory modules.
10. Remove the drives (refer to [Maintenance Flowchart](#)).
11. If the Issue is still not resolved, refer to [Online Support Information](#).

## Abnormal Video

If the video appears abnormal, perform the following:

1. Boot the computer.
  - If permanent vertical/horizontal lines or dark spots appear in the same location, the LCD is faulty and should be replaced. Refer to Disassembly Process.
  - If extensive pixel damage is present (different colored spots in the same locations on the screen), the LCD is faulty and should be replaced. Refer to [Maintenance Flowchart](#).

### ⇒ NOTE:

Make sure that the computer is not running on battery alone as this may reduce display brightness.

2. Adjust the brightness to its highest level. Refer to the User Manual for instructions on adjusting the settings. If the display is too dim at the highest brightness setting, the LCD is faulty and should be replaced. Refer to *Disassembly Process*.
3. Check the display resolution is correctly configured:
  - Minimize or close all Windows.
  - If display size is only abnormal in an application, check the view settings and control/mouse wheel zoom feature in the application.
  - If desktop display resolution is not normal, right-click on the desktop and select *Personalize Display Settings*.
  - Click and drag the Resolution slider to the desired resolution.
  - Click **Apply** and check the display. Readjust if necessary.
4. Roll back the video driver to the previous version if updated.
5. Remove and reinstall the video driver.
6. Check the Device Manager to determine that:
  - The device is properly installed. There are no red Xs or yellow exclamation marks
  - There are no device conflicts
  - No hardware is listed under *Other Devices*
7. If the Issue is still not resolved, refer to [Online Support Information](#).
8. Run the *Windows Memory Diagnostic* from the operating system DVD and follow the on-screen prompts.

9. If the issue is still not resolved, refer to [Online Support Information](#).

# LCD Failure

---

If the LCD fails, perform the following:

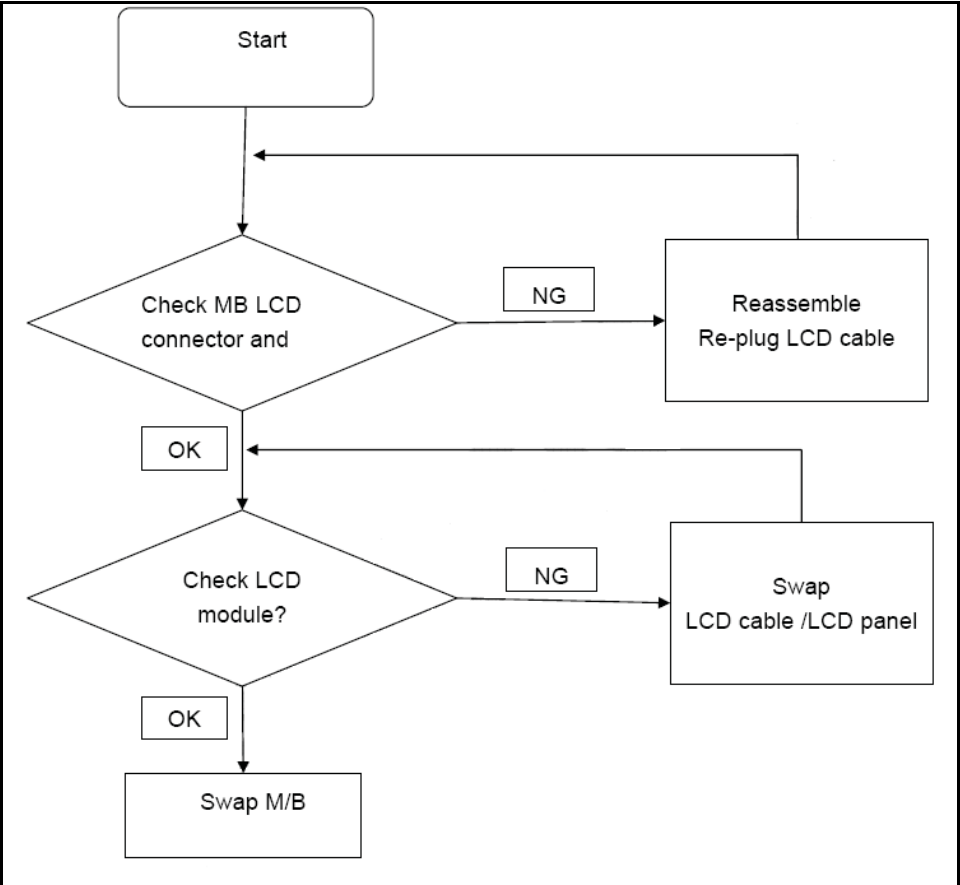

---

**Figure 4-3. LCD Failure**



# Keyboard Failure

---

If the Keyboard fails, perform the following:

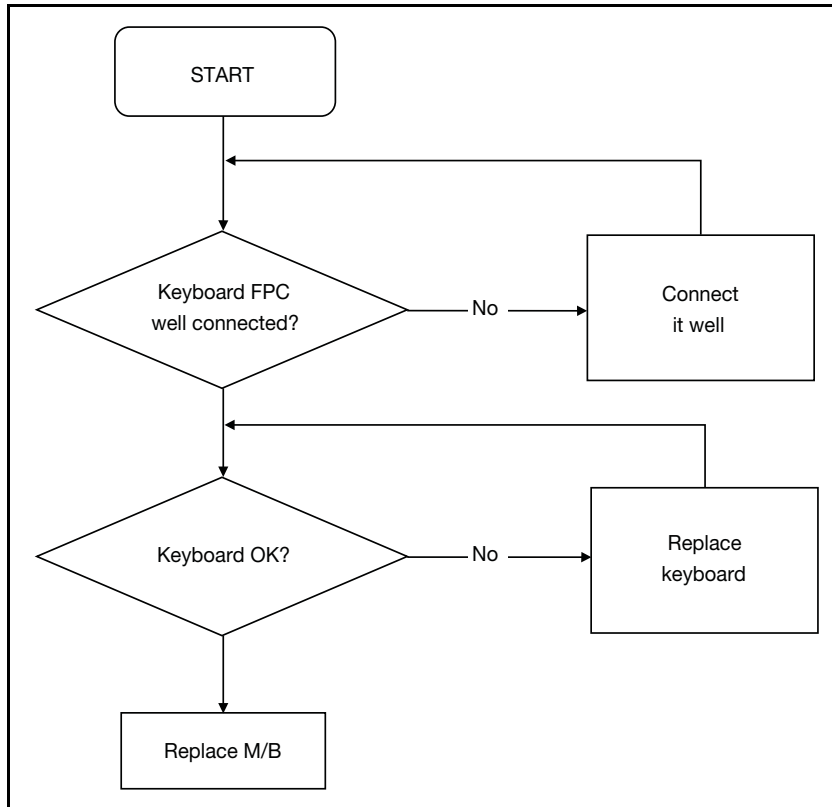

---

**Figure 4-4. Keyboard Failure**

# Touchpad Failure

---

If the Touchpad fails, perform the following:

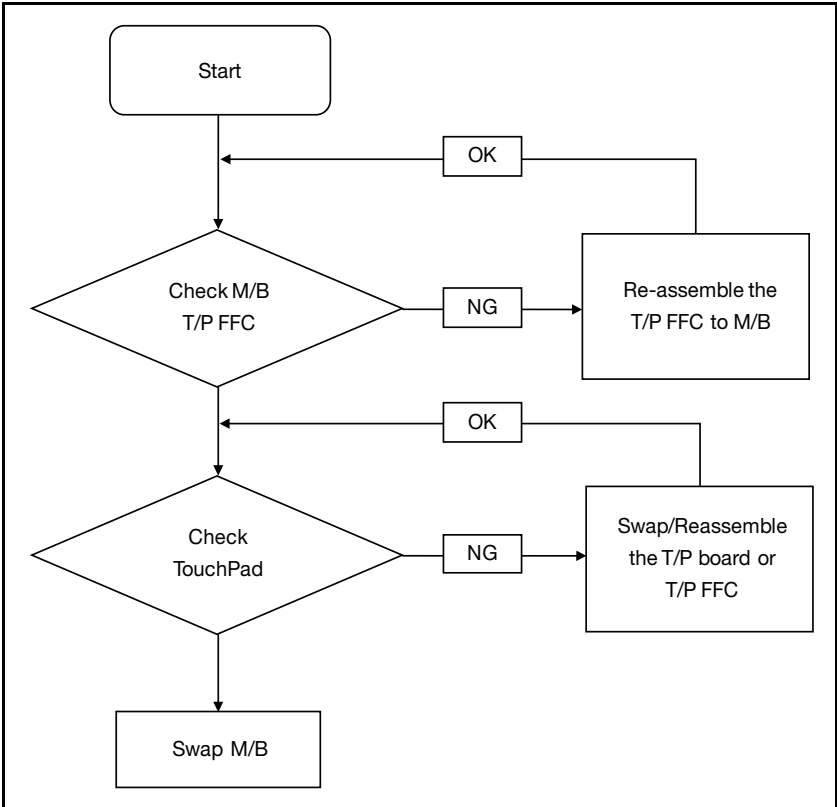

---

**Figure 4-5. Touchpad Failure**

# Internal Speaker Failure

---

If internal Speakers fail, perform the following:

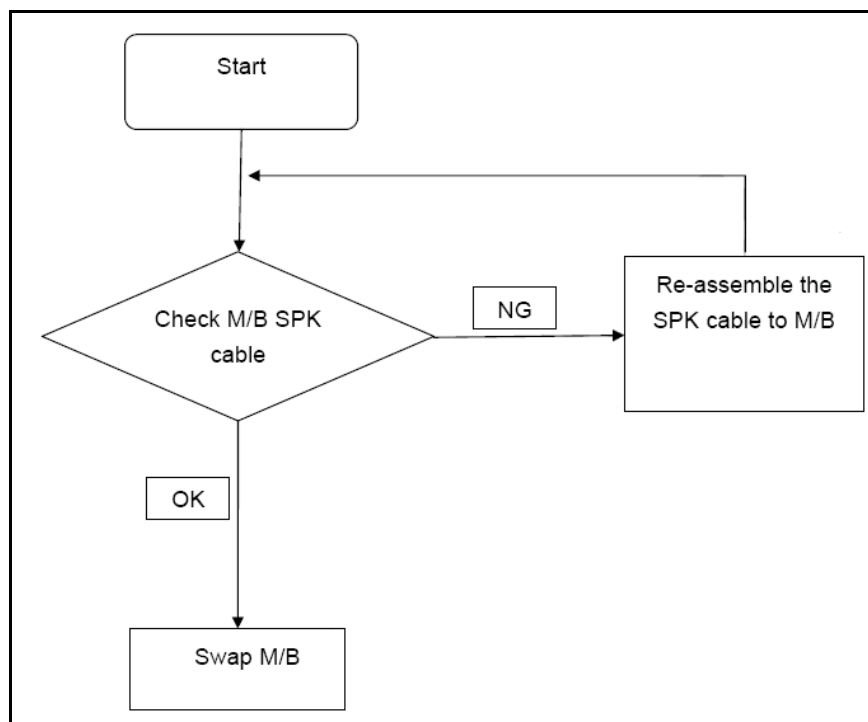

---

**Figure 4-6. Internal Speaker Failure**

## Sound Problems

Perform the following, one at a time.

1. Boot the computer.
2. Navigate to **Start** → **Control Panel** → **System and Maintenance** → **System** → **Device Manager**. Check the Device Manager to determine that:
  - The device is properly installed
  - There are no red Xs or yellow exclamation marks
  - There are no device conflicts
  - No hardware is listed under Other Devices
3. If updated recently, roll back the audio driver to the previous version.
4. Remove and reinstall the audio driver.
5. Make sure that all volume controls are set mid range:
  - Click the volume icon on the taskbar
  - Drag the slider to 50. Confirm that the volume is not muted.
  - Click Mixer to verify that other audio applications are set to 50 and not muted.
6. Navigate to **Start** → **Control Panel** → **Hardware and Sound** → **Sound**. Confirm

that Speakers are selected as the default audio device (green check mark).

⇒ **NOTE:**

If Speakers does not show, right-click on the Playback tab and select **Show Disabled Devices** (clear by default).

7. Select Speakers and click **Configure** to start Speaker Setup. Follow the on-screen prompts to configure the speakers.
8. Remove any recently installed hardware or software.
9. Restore system and file settings from a known good date using System Restore.
10. If the issue is remains, repeat step 9, selecting an earlier time and date.
11. Reinstall the operating system.
12. If the issue is still not resolved, refer to [Online Support Information](#).

# Microphone Failure

---

If internal or external Microphones fail, perform the following:

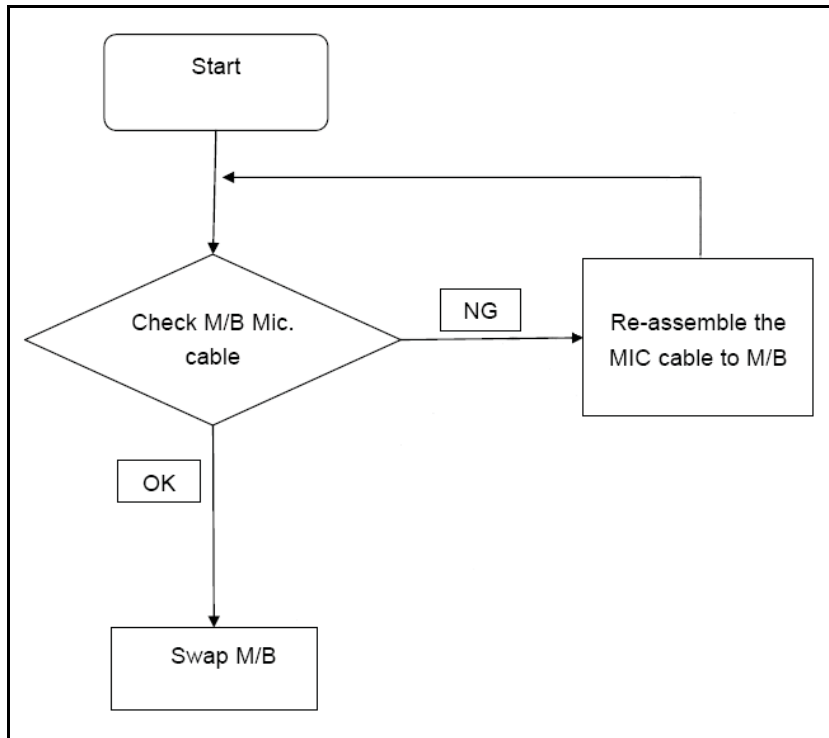

---

**Figure 4-7. Microphone Failure**

1. Check that the microphone is enabled. Navigate to **Start**→ **Control Panel**→ **Hardware and Sound**→ **Sound** and select the Recording tab.
2. Right click on the Recording tab and select Show Disabled Devices (clear by default). The microphone appears on the Recording tab.
3. Right click on the microphone and select **Enable**.
4. Select the microphone then click **Properties**. Select the **Levels** tab.
5. Increase the volume to the maximum setting and click **OK**.
6. Test the microphone hardware:
  - Select the microphone and click **Configure**.
  - Select **Set up microphone**.
  - Select the microphone type from the list and click **Next**.
  - Follow the on-screen prompts to complete the test.
7. If the Issue is still not resolved, refer to [Online Support Information](#).

# USB Failure

---

If the USB fails, perform the following:

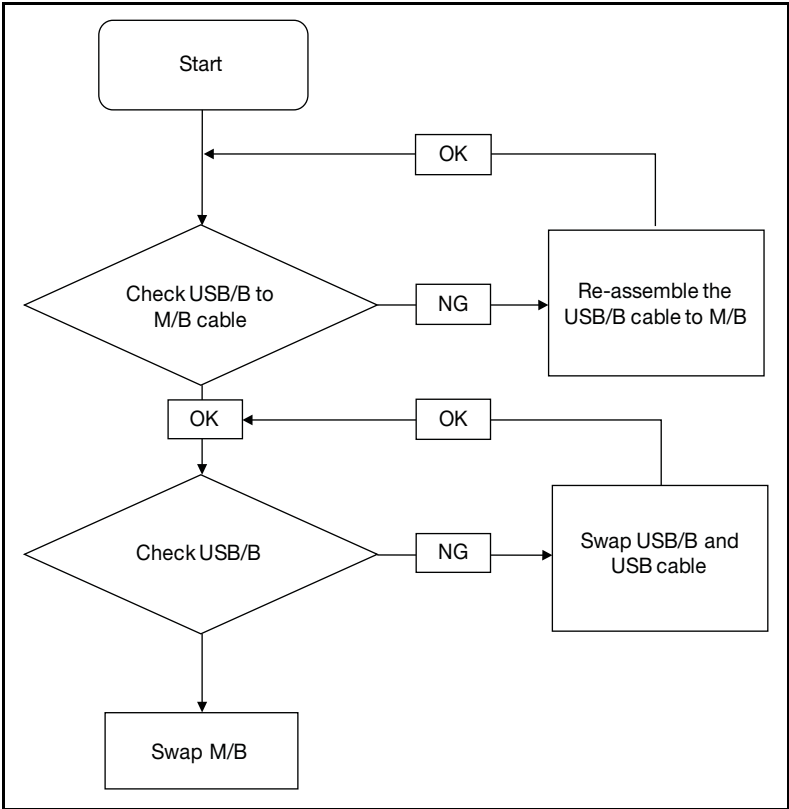

---

**Figure 4-8. USB Failure**

## Other Functions Failure

---

1. Check if drives are functioning correctly.
2. Check if external modules are functioning correctly.
3. Change mainboard to check if current one is defective.

## Intermittent Problems

---

Intermittent system hang problems can be caused by a variety of reasons that have nothing to do with a hardware defect, such as: cosmic radiation, electrostatic discharge, or software errors. FRU replacement should be considered only when a recurring problem exists.

When analyzing an intermittent problem, perform the following:

1. Run the advanced diagnostic test for the system board in loop mode at least 10 times.
2. If no error is detected, do not replace any FRU.
3. If an error is detected, replace the FRU. Rerun the test to verify that there are no more errors.

## Undetermined Problems

---

The diagnostic problems do not identify which adapter or device failed, which installed devices are incorrect, whether a short circuit is suspected, or whether the system is inoperative.

Perform the following procedures to isolate the failing FRU (do not isolate non-defective FRU).

**⇒ NOTE:**

Verify that all attached devices are supported by the computer.

**⇒ NOTE:**

Verify that the power supply being used at the time of the failure is operating correctly. (Refer to [Power On Issues](#)).

1. Remove power from the computer.
2. Visually check components for damage. If any problems are found, replace the FRU.
3. Remove or disconnect all of the following devices:
  - Non-Acer devices
  - Printer, mouse, and other external devices
  - Battery pack
  - Hard disk drive
  - DIMM
  - CD-ROM/Diskette drive Module
  - PC Cards
4. Apply power to the computer.
5. Determine if the problem has changed.
6. If the problem does not recur, connect the removed devices one at a time until failing FRU is found.
7. If the problem remains, replace the following FRUs:
  - System board
  - LCD assembly



# Post Codes

The following are the InsydeH2O™ Functionality POST code tables. The components of the POST code table includes: SEC phase, PEI phase, DXE phase, BDS phase, CSM functions, S3 functions and ACPI functions.

**Table 4-2. POST Code Range**

Phase	POST Code Range
SEC	0x01 - 0x0F
PEI	0x70 - 0x9F
DXE	0x40 - 0x6F
BDS	0x10 - 0x3F
SMM	0xA0 - 0xBF
S3	0xC0 - 0xCF
ASL	0x51 – 0x55 0xE1 – 0xE4
PostBDS	0xF9 – 0xFE
InsydeH2ODDT™ Reserve	0xD0 – 0xD7
OEM Reserve	0xE8 – 0xEB
Reserved	0xD8 – 0xE0 0xE5 – 0xE7 0xEC – 0xF8

**Table 4-3. SEC Phase POST Code Table**

Functionality Name (Include PostCode.h)	Phase	PostCode	Description
SEC_SYSTEM_POWER_ON	SEC	01	CPU power on and switch to Protected mode
SEC_BEFORE_MICROCODE_PATCH	SEC	02	Patching CPU microcode
SEC_AFTER_MICROCODE_PATCH	SEC	03	Setup Cache as RAM
SEC_ACCESS_CSR*	SEC	04	PCIE MMIO Base Address initial
SEC_GENERIC_MSRRINIT*	SEC	05	CPU Generic MSR initialization
SEC_CPU_SPEEDCFG*	SEC	06	Setup CPU speed
SEC_SETUP_CAR_OK	SEC	07	Cache as RAM test
SEC_FORCE_MAX_RATIO*	SEC	08	Tune CPU frequency ratio to maximum level

**Table 4-3. (Continued)SEC Phase POST Code Table**

Functionality Name (Include\ PostCode.h)	Phase	PostCode	Description
SEC_GO_TO_SECSTARTUP	SEC	09	Setup BIOS ROM cache
SEC_GO_TO_PEICORE	SEC	0A	Enter Boot Firmware Volume
* 3rd party relate functions – Platform dependence.			

**Table 4-4. PEI Phase POST Code Table**

Functionality Name (Include\ PostCode.h)	Phase	Post Code	Description
PEI_SIO_INIT	PEI	70	Super I/O Initialization
PEI_CPU_REG_INIT	PEI	71	CPU Early Initialization
PEI_CPU_AP_INIT*	PEI	72	Multi-processor Early Initial
PEI_CPU_HT_RESET*	PEI	73	HyperTransport Initialization
PEI_PCIE_MMIO_INIT	PEI	74	PCIE MMIO BAR Initialization
PEI_NB_REG_INIT	PEI	75	North Bridge Early Initialization
PEI_SB_REG_INIT	PEI	76	South Bridge Early Initialization
PEI_PCIE_TRAINING*	PEI	77	PCIE Training
PEI_TPM_INIT	PEI	78	TPM Initialization
PEI_SMBUS_INIT	PEI	79	SMBUS Early Initialization
PEI_PROGRAM_CLOCK_GEN	PEI	7A	Clock Generator Initialization
PEI_IGD_EARLY_INITIAL *	PEI	7B	Internal Graphic device early Initialization
PEI_HECI_INIT*	PEI	7C	HECI Initialization
PEI_WATCHDOG_INIT*	PEI	7D	Watchdog timer Initialization
PEI_MEMORY_INIT	PEI	7E	Memory Initial for Normal boot.
PEI_MEMORY_INIT_FOR_CRISIS	PEI	7F	Memory Initial for Crisis Recovery
PEI_MEMORY_INSTALL	PEI	80	Simple Memory test
PEI_TXTPEI*	PEI	81	TXT function early Initialization
PEI_SWITCH_STACK	PEI	82	Start to use Memory
PEI_MEMORY_CALLBACK	PEI	83	Set cache for physical memory
PEI_ENTER_RECOVERY_MODE	PEI	84	Recovery device Initialization
PEI_RECOVERY_MEDIA_FOUND	PEI	85	Found Recovery image
PEI_RECOVERY_MEDIA_NOT_FOUND	PEI	86	Recovery image not found

**Table 4-4. (Continued)PEI Phase POST Code Table**

Functionality Name (Include\ PostCode.h)	Phase	Post Code	Description
PEI_RECOVERY_LOAD_FILE_DONE	PEI	87	Load Recovery Image completed
PEI_RECOVERY_START_FLASH	PEI	88	Start Flash BIOS with Recovery image
PEI_ENTER_DXEIPL	PEI	89	Loading BIOS image to RAM
PEI_FINDING_DXE_CORE	PEI	8A	Loading DXE core
PEI_GO_TO_DXE_CORE	PEI	8B	Enter DXE core
* 3rd party relate functions – Platform dependence.			

**Table 4-5. DXE Phase POST Code Table**

Functionality Name (Include\ PostCode.h)	Phase	Post Code	Description
DXE_TCGDXE*	DXE	40	TPM initial in DXE
DXE_SB_SPI_INIT*	DXE	41	South bridge SPI initialization
DXE_CF9_RESET*	DXE	42	Setup Reset service
DXE_SB_SERIAL_GPIO_INIT*	DXE	43	South bridge Serial GPIO initialization
DXE_SMMACCESS*	DXE	44	Setup SMM ACCE SS service
DXE_NB_INIT	DXE	45	North bridge Middle initialization
DXE_SIO_INIT*	DXE	46	Super I/O DXE initialization
DXE_LEGACY_REGION*	DXE	47	Setup Legacy Region service
DXE_SB_INIT*	DXE	48	South Bridge Middle initialization
DXE_IDENTIFY_FLASH_DEVICE*	DXE	49	Identify Flash device
DXE_FTW_INIT	DXE	4A	Fault Tolerant Write verification
DXE_VARIABLE_INIT	DXE	4B	Variable Service initialization
DXE_VARIABLE_INIT_FAIL	DXE	4C	Fail to initial Variable Service
DXE_MTC_INIT	DXE	4D	MTC Initial
DXE_CPU_INIT	DXE	4E	CPU Middle Initialization
DXE_MP_CPU_INIT	DXE	4F	Multi-processor Middle Initialization
DXE_SMBUS_INIT	DXE	50	SMBUS Driver Initialization
DXE_SMART_TIMER_INIT	DXE	51	8259 Initialization

**Table 4-5. (Continued)DXE Phase POST Code Table**

Functionality Name (Include\ PostCode.h)	Phase	Post Code	Description
DXE_PCRTC_INIT	DXE	52	RTC Initialization
DXE_SATA_INIT*	DXE	53	SATA Controller early Initialization
DXE_SMM_CONTROLLER_INIT*	DXE	54	Setup SMM Control service
DXE_LEGACY_INTERRUPT*	DXE	55	Setup Legacy Interrupt service
DXE_RELOCATE_SMBASE	DXE	56	Relocate SMM BASE
DXE_FIRST_SMI	DXE	57	SMI test
DXE_VTD_INIT*	DXE	58	VTD Initial
DXE_BEFORE_CSM16_INIT	DXE	59	Legacy BIOS Initialization
DXE_AFTER_CSM16_INIT	DXE	5A	Legacy interrupt function Initialization
DXE_LOAD_ACPI_TABLE	DXE	5B	ACPI Table Initialization
DXE_SB_DISPATCH*	DXE	5C	Setup SB SMM Dispatcher service
DXE_SB_IOTRAP_INIT*	DXE	5D	Setup SB IOTRAP Service
DXE_SUBCLASS_DRIVER*	DXE	5E	Build AMT Table
DXE_PPM_INIT*	DXE	5F	PPM Initialization
DXE_HECIDRV_INIT*	DXE	60	HECIDRV Initialization
* 3rd party relate functions – Platform dependence.			

**Table 4-6. BDS Phase POST Code Table**

Functionality Name (Include\ PostCode.h)	Phase	Post Code	Description
BDS_ENTER_BDS	BDS	10	Enter BDS entry
BDS_INSTALL_HOTKEY	BDS	11	Install Hotkey service
BDS_ASF_INIT*	BDS	12	ASF Initialization
BDS_PCI_ENUMERATION_START	BDS	13	PCI enumeration
BDS_BEFORE_PCIIO_INSTALL	BDS	14	PCI resource assign complete
BDS_PCI_ENUMERATION_END	BDS	15	PCI enumeration complete
BDS_CONNECT_CONSOLE_IN	BDS	16	Keyboard Controller, Keyboard and Mouse initialization
BDS_CONNECT_CONSOLE_OUT	BDS	17	Video device initialization

**Table 4-6. (Continued)BDS Phase POST Code Table**

Functionality Name (Include\ PostCode.h)	Phase	Post Code	Description
BDS_CONNECT_STD_ERR	BDS	18	Error report device initialization
BDS_CONNECT_USB_HC	BDS	19	USB host controller initialization
BDS_CONNECT_USB_BUS	BDS	1A	USB BUS driver initialization
BDS_CONNECT_USB_DEVICE	BDS	1B	USB device driver initialization
BDS_NO_CONSOLE_ACTION	BDS	1C	Console device initial fail
BDS_DISPLAY_LOGO_SYSTEM_INFO	BDS	1D	Display logo or system information
BDS_START_IDE_CONTROLLER	BDS	1E	IDE controller initialization
BDS_START_SATA_CONTROLLER	BDS	1F	SATA controller initialization
BDS_START_ISA_ACPI_CONTROLLER	BDS	20	SIO controller initialization
BDS_START_ISA_BUS	BDS	21	ISA BUS driver initialization
BDS_START_ISA_FDD	BDS	22	Floppy device initialization
BDS_START_ISA_SEIRAL	BDS	23	Serial device initialization
BDS_START_IDE_BUS	BDS	24	IDE device initialization
BDS_START_AHCI_BUS	BDS	25	AHCI device initialization
BDS_CONNECT_LEGACY_ROM	BDS	26	Dispatch option ROMs
BDS_ENUMERATE_ALL_BOOT_OPTION	BDS	27	Get boot device information
BDS_END_OF_BOOT_SELECTION	BDS	28	End of boot selection
BDS_ENTER_SETUP	BDS	29	Enter Setup Menu
BDS_ENTER_BOOT_MANAGER	BDS	2A	Enter Boot manager
BDS_BOOT_DEVICE_SELECT	BDS	2B	Try to boot system to OS
BDS_EFI64_SHADOW_ALL_LEGACY_ROM	BDS	2C	Shadow Misc Option ROM
BDS_ACPI_S3SAVE	BDS	2D	Save S3 resume required data in RAM
BDS_READY_TO_BOOT_EVENT	BDS	2E	Last Chipset initial before boot to OS
BDS_GO_LEGACY_BOOT	BDS	2F	Start to boot Legacy OS
BDS_GO_UEFI_BOOT	BDS	30	Start to boot UEFI OS
BDS_LEGACY16_PREPARE_TO_BOOT	BDS	31	Prepare to Boot to Legacy OS
BDS_EXIT_BOOT_SERVICES*	BDS	32	Send END of POST Message to ME via HECI

**Table 4-6. (Continued)BDS Phase POST Code Table**

Functionality Name (Include\ PostCode.h)	Phase	Post Code	Description
BDS_LEGACY_BOOT_EVENT	BDS	33	Last Chipset initial before boot to Legacy OS.
BDS_ENTER_LEGACY_16_BOOT	BDS	34	Ready to Boot Legacy OS.
BDS_RECOVERY_START_FLASH	BDS	35	Fast Recovery Start Flash.
* 3rd party relate functions – Platform dependence.			

**Table 4-7. PostBDS Functions POST Code Table**

Functionality Name (Include\ PostCode.h)	Phase	Post Code	Description
POST_BDS_NO_BOOT_DEVICE	PostBDS	F9	No Boot Device
POST_BDS_START_IMAGE	PostBDS	FB	UEFI Boot Start Image
POST_BDS_ENTER_INT19	PostBDS	FD	Legacy 16 boot entry
POST_BDS_JUMP_BOOT_SECTOR	PostBDS	FE	Try to boot with INT 19

**Table 4-8. S3 Functions POST Code Table**

Functionality Name (Include\PostCode.h)	Phase	PostCode	Description
S3_RESTORE_MEMORY_CONTROLLER	PEI	C0	Memory initial for S3 resume
S3_INSTALL_S3_MEMORY	PEI	C1	Get S3 resume required data from memory
S3_SWITCH_STACK	PEI	C2	Start to use memory during S3 resume
S3_MEMORY_CALLBACK	PEI	C3	Set cashe for physical memory during S3 resume
S3_ENTER_S3_RESUME_PEIM	PEI	C4	Start to restore system configuration
S3_BEFORE_ACPI_BOOT_SCRIPT	PEI	C5	Restore system configuration stage 1
S3_BEFORE_RUNTIME_BOOT_SCRIPT	PEI	C6	Restore system configuration stage 2
S3_BEFORE_RELOCATE_SMM_BASE	PEI	C7	Relocate SMM BASE during S3 resume
S3_BEFORE_MP_INIT	PEI	C8	Multi-processor initial during S3 resume
S3_BEFORE_RESTORE_ACPI_CALLBACK	PEI	C9	Start to restore system configuration in SMM

**Table 4-8. (Continued)S3 Functions POST Code Table**

Functionality Name (Include\PostCode.h)	Phase	PostCode	Description
S3_AFTER_RESTORE_ACPI_CALLBACK	PEI	CA	Restore system configuration in SMM complete
S3_GO_TO_FACS_WAKING_VECTOR	PEI	CB	Back to OS

**Table 4-9. ACPI Functions POST Code Table**

Functionality Name (Include\PostCode.h)	Phase	Post Code	Description
ASL_ENTER_S1	ASL	51	Prepare to enter S1
ASL_ENTER_S3	ASL	53	Prepare to enter S3
ASL_ENTER_S4	ASL	54	Prepare to enter S4
ASL_ENTER_S5	ASL	55	Prepare to enter S5
ASL_WAKEUP_S1	ASL	E1	System wake up from S1
ASL_WAKEUP_S3	ASL	E3	System wake up from S3
ASL_WAKEUP_S4	ASL	E4	System wake up from S4

**Table 4-10. SMM Functions POST Code Table**

Functionality Name (Include PostCode.h)	Phase	Post Code	Description
SMM_IDENTIFY_FLASH_DEVICE	SMM	0xA0	Identify Flash device in SMM
SMM_SMM_PLATFORM_INIT	SMM	0xA2	SMM service initial
SMM_ACPI_ENABLE_START	SMM	0xA6	OS call ACPI enable function
SMM_ACPI_ENABLE_END	SMM	0xA7	ACPI enable function complete
SMM_S1_SLEEP_CALLBACK	SMM	0xA1	Enter S1
SMM_S3_SLEEP_CALLBACK	SMM	0xA3	Enter S3
SMM_S4_SLEEP_CALLBACK	SMM	0xA4	Enter S4
SMM_S5_SLEEP_CALLBACK	SMM	0xA5	Enter S5
SMM_ACPI_DISABLE_START	SMM	0xA8	OS call ACPI disable function
SMM_ACPI_DISABLE_END	SMM	0xA9	ACPI disable function complete

**Table 4-11. InsydeH2ODDT Debugger POST Code Table**

Functionality Name (Include\PostCode.h)	PostCode	Description
Used by Insyde debugger	0x0D	Waiting for device connect

**Table 4-11. InsydeH2ODDT Debugger POST Code Table**

<b>Functionality Name (Include\PostCode.h)</b>	<b>PostCode</b>	<b>Description</b>
Used by Insyde debugger	0xD0	Waiting for device connect
Used by Insyde debugger	0xD1	InsydeH2ODDT Ready
Used by Insyde debugger	0xD2	EHCI not found
Used by Insyde debugger	0xD3	Debug port connect low speed device
Used by Insyde debugger	0xD4	DDT Cable become low speed device
Used by Insyde debugger	0xD5	DDT Cable Transmission Error (Get descriptor fail)
Used by Insyde debugger	0xD6	DDT Cable Transmission Error (Set Debug mode fail)
Used by Insyde debugger	0xD7	DDT Cable Transmission Error (Set address fail)



# CHAPTER 5

## Jumper and Connector Locations

---

**Mainboard Jumper and Connector Locations . . . . . 5-3**  
**Clearing Password Check and BIOS Recovery . . . . . 5-5**  
    Clearing Password Check . . . . . 5-5  
    Clear CMOS Jumper . . . . . 5-6  
    BIOS Recovery by Crisis Disk . . . . . 5-6

# Jumper and Connector Locations

## Mainboard Jumper and Connector Locations

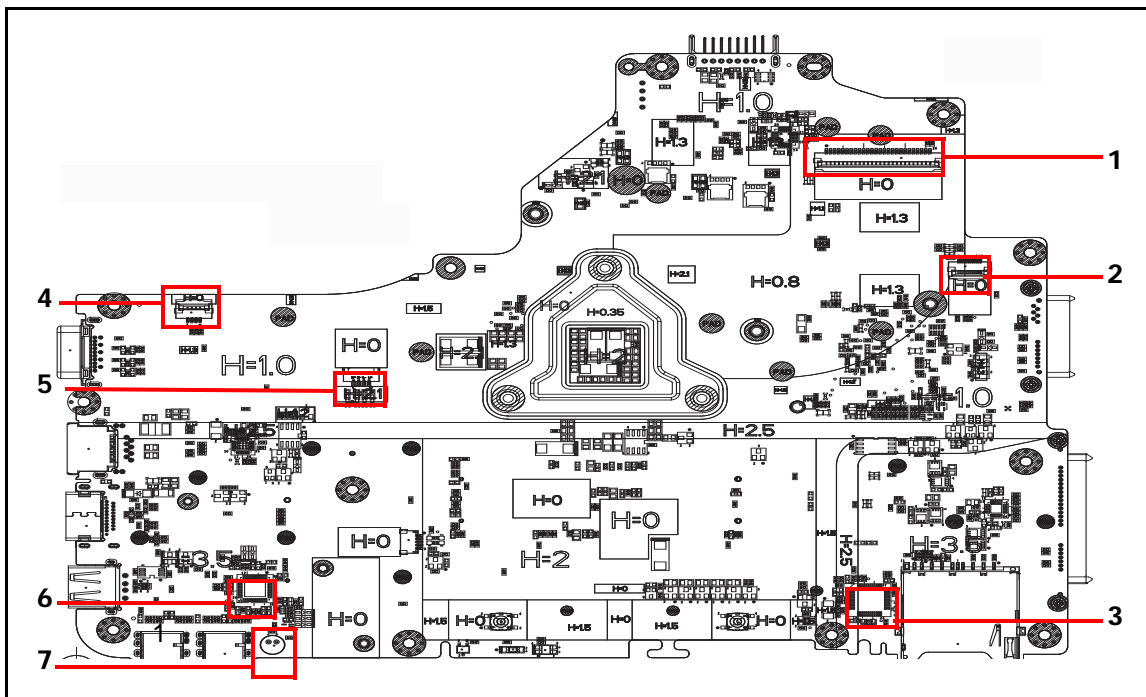
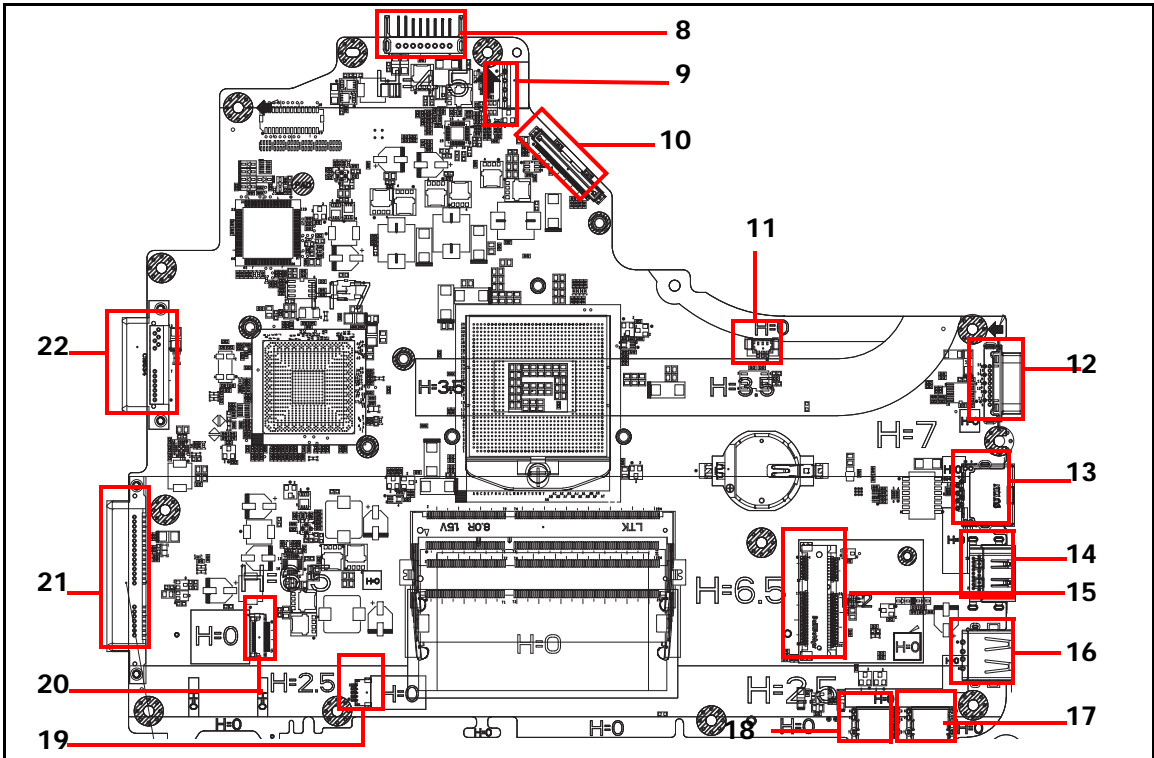

Figure 5-1. Mainboard Top

Table 5-1. Mainboard Top

Item	Description	Item	Description
1	Keyboard Connector	5	Speaker Connector
2	Touchpad Connector	6	CODEC Connector
3	Card Reader Connector	7	Microphone Connector
4	Power Board Connector		



**Figure 5-2. Mainboard Bottom**

**Table 5-2. Mainboard Bottom**

Item	Description	Item	Description
8	Battery Connector	16	USB Connector
9	DC Connector	17	Microphone Connector
10	LVDS Connector	18	Headphone Connector
11	Fan Connector	19	Bluetooth Connector
12	CRT Connector	20	USB Connector
13	LAN Connector	21	HDD Connector
14	HDMI Connector	22	ODD Connector
15	MINI Card Connector		

# Clearing Password Check and BIOS Recovery

---

This section provides users with the standard operating procedures of clearing password and BIOS recovery for the Aspire 5349/5749/5749Z. The machine provides one Hardware Open Gap on main board for clearing password check, and one hot key for enabling BIOS Recovery.

## Clearing Password Check

---

### ⇒ NOTE:

The following procedure is only for clearing BIOS Password (Supervisor Password and User Password).

### Steps for Clearing BIOS Password Check

If users set BIOS Password (Supervisor Password and/or User Password) for a security reason, BIOS will ask the password during systems POST or when systems enter to BIOS Setup menu. However, once it is necessary to bypass the password check, users need to short the HW Gap to clear the password by the following steps:

1. Remove power from the system.
2. Remove battery.
3. Remove lower cover.
4. Disconnect the RTC battery
5. Locate the CMOS jumper.
6. Use an electric conductivity tool to short the two points of the CMOS jumper.
7. Plug in AC, keeping the CMOS jumper shorted.
8. Press *Power Button* until BIOS POST is finished, then remove the conductivity tool from the CMOS jumper.
9. Restart the system. Press **F2** to enter BIOS Setup menu.
10. If there is no Password request, BIOS Password is cleared.
11. If a password is requested, repeat Steps 1 through 9.

# Clear CMOS Jumper

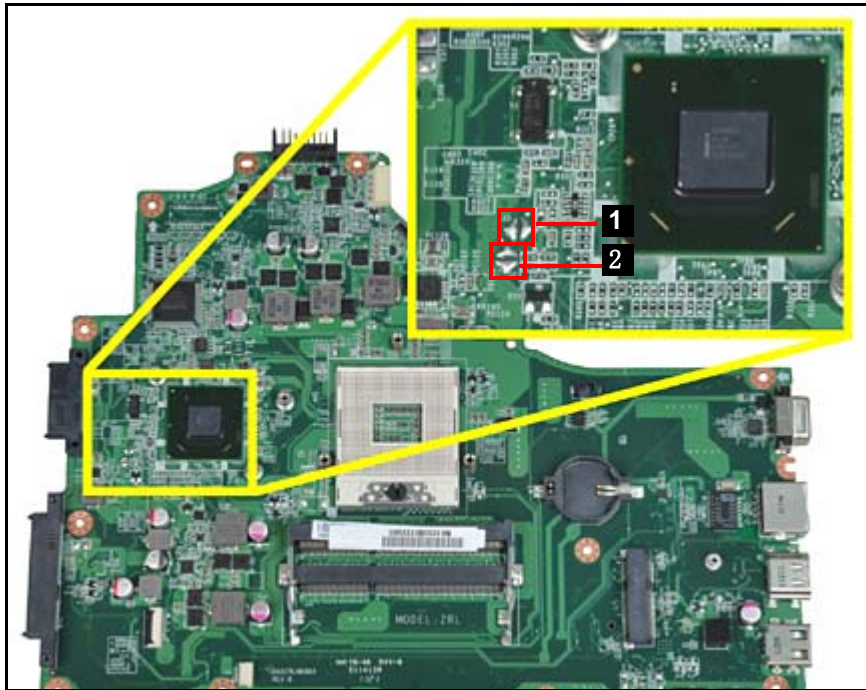

Figure 5-3. CMOS Jumper

Table 5-3. CMOS Jumper

Item	Description
1	Clear CMOS Jumper
2	Clear CMOS Jumper

## BIOS Recovery by Crisis Disk

### BIOS Recovery Boot Block

BIOS Recovery Boot Block is a special block of BIOS. It is used to boot up the system with minimum BIOS initialization. Users can enable this feature to restore the BIOS firmware to a successful one once the previous BIOS flashing process failed.

### BIOS Recovery Hot Key

The system provides a function hot key, **<Fn+Esc>**, for enable BIOS Recovery process when system is powered on during BIOS POST. To use this function, it is strongly recommended to have the AC adapter and Battery present. If this function is enabled, the system will force the BIOS to enter a special BIOS block, called Boot Block.

## Steps for BIOS Recovery from USB Storage

### ⇒ NOTE:

Prior to performing the recovery, prepare a Crisis USB key. The Crisis USB key is created by executing the Crisis Disk program on another system with Windows 7 OS.

To Create a Crisis USB key, perform the following:

1. Format the USB storage disk using the Fast Format option.
2. Save ROM file (file name: **ZQR\_EC.bin/BIOS\_ME.bin**) to the root directory of USB storage. Make sure that there is no other BIOS file saved in the same directory.
3. Plug USB storage into USB port.
4. Press <Fn + ESC> button then plug in AC power.
5. The Power button flashes once.
6. Press **Power** button to initiate system CRISIS mode.
7. When CRISIS is complete, the system auto restarts with a workable BIOS.
8. Update the latest version BIOS for this machine by regular BIOS flashing process.





# CHAPTER 6

## FRU (Field Replaceable Unit) List

---

<b>Exploded Diagrams</b> .....	<b>6-4</b>
<b>FRU List</b> .....	<b>6-7</b>
<b>Screw List</b> .....	<b>6-16</b>

# FRU (Field Replaceable Unit) List

---

This chapter provides users with a FRU (Field Replaceable Unit) listing in global configurations for the Aspire 5349/5749/5749Z. Refer to this chapter whenever ordering for parts to repair or for RMA (Return Merchandise Authorization).

**⇒ NOTE:**

WHEN ORDERING FRU PARTS, check the most up-to-date information available on the regional web or channel. Part number changes will not be noted on the printed Service Guide. For ACER AUTHORIZED SERVICE PROVIDERS, the Acer office may have a DIFFERENT part number code from those given in the FRU list of this printed Service Guide. Users MUST use the local FRU list provided by the regional Acer office to order FRU parts for repair and service of customer machines.

**⇒ NOTE:**

To scrap or to return the defective parts, users should follow the local government ordinance or regulations on how to dispose it properly, or follow the rules set by the regional Acer office on how to return it.

# Exploded Diagrams

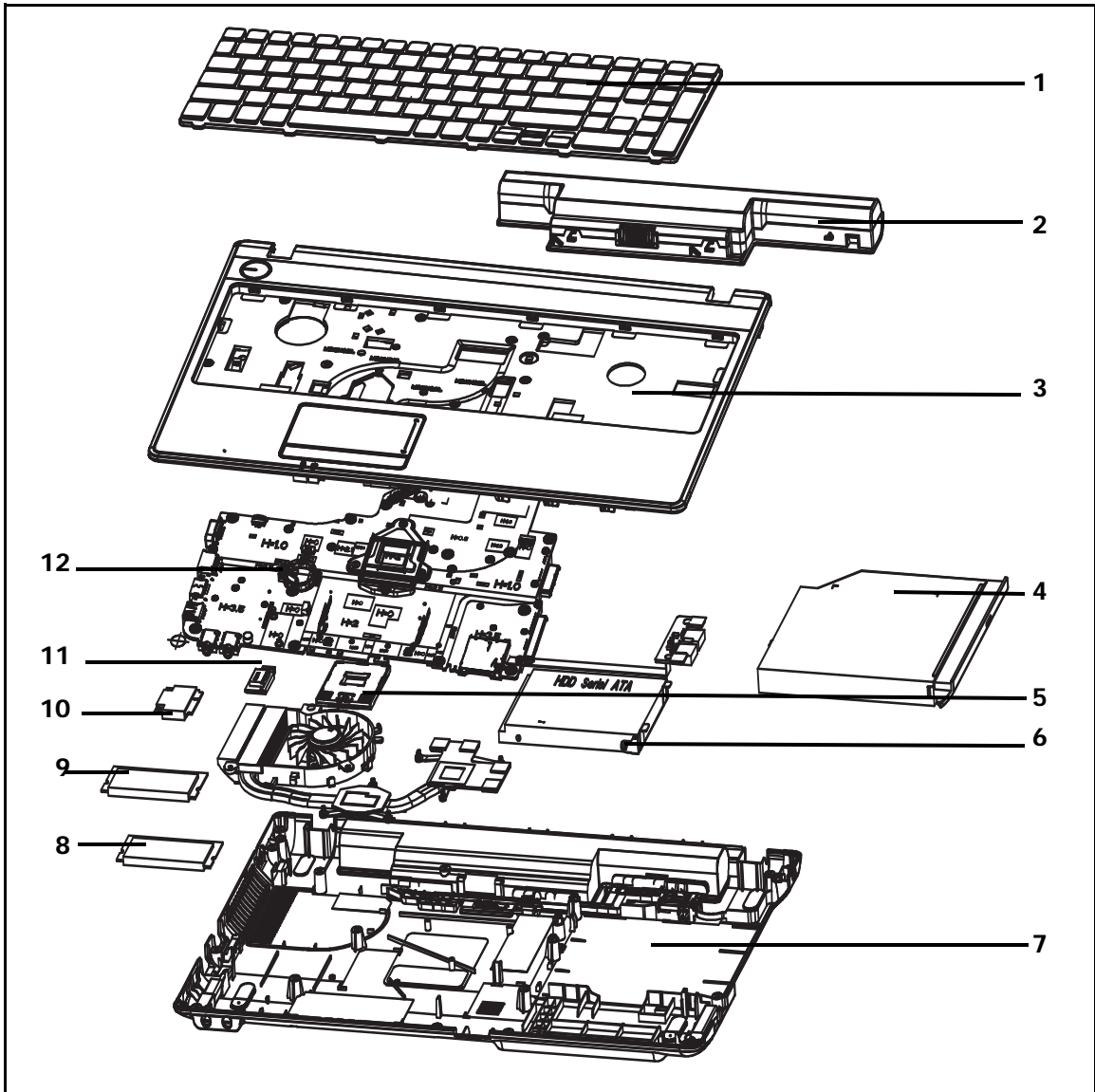

Figure 6-1. Upper & Lower Cover Exploded Diagram

Table 6-1. Upper & Lower Cover Exploded Diagram

No.	Description	Acer Part No.
1	Keyboard	AEZR7R00010
2	Battery	AHA63222483
3	Upper Case	2HZRLTATN00
4	ODD Module	24ZRLCDTN10
5	CPU	AJ0QACBUG03

**Table 6-1. Upper & Lower Cover Exploded Diagram**

<b>No.</b>	<b>Description</b>	<b>Acer Part No.</b>
6	HDD Module	23ZRLHDTN20
7	Base Cover	2IZRLBATN00
8	RAM (1GB)	ATR31ABMF33
9	RAM (4GB)	ATR34AAMF04
10	WLAN	3WZRLWLTN00
11	Bluetooth	3XZRLBTTN00
12	Mainboard	20ZRLBU0000

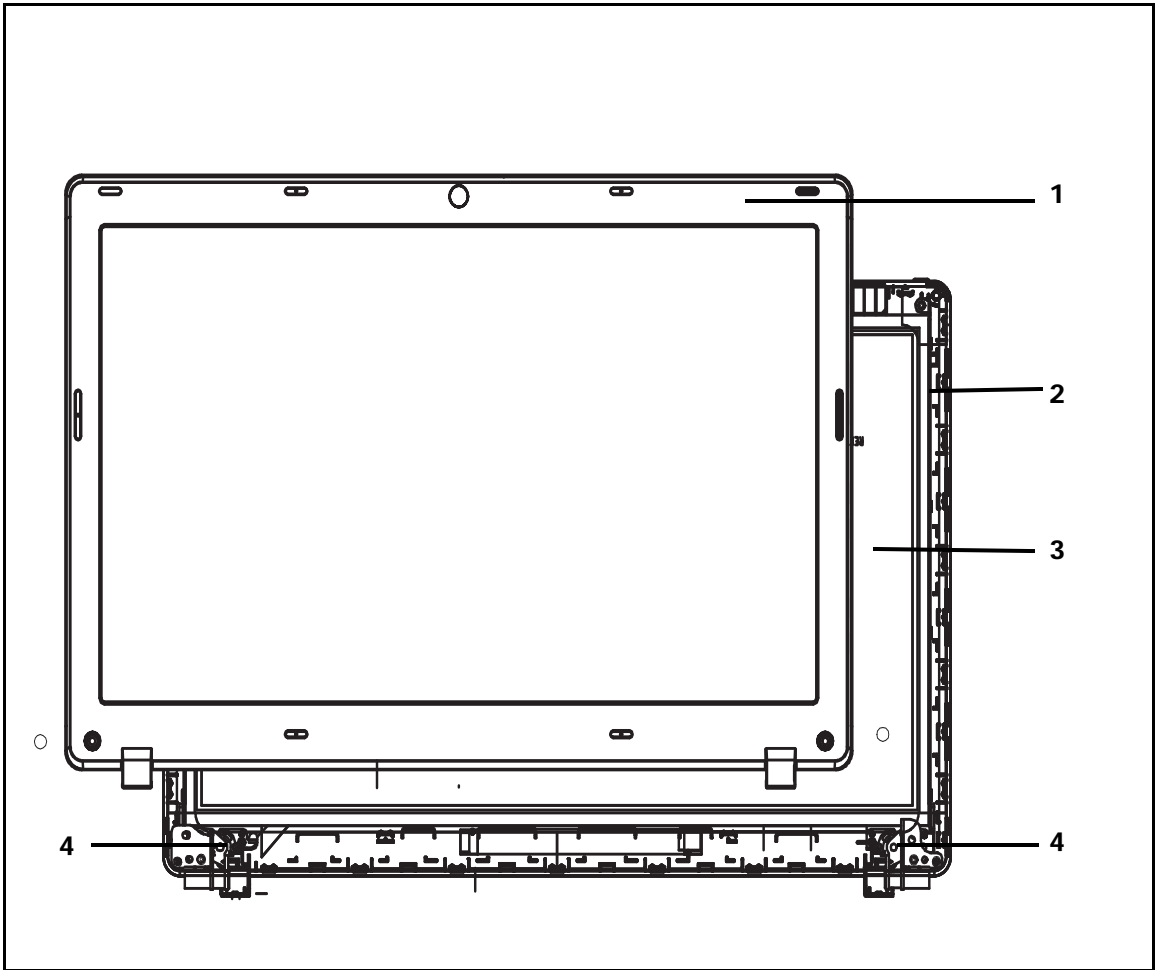

**Figure 6-2. LCD Assembly Exploded Diagram**

**Table 6-2. LCD Assembly Exploded Diagram**





No.	Description	Acer Part No.
1	LCD Bracket (Right) LCD Bezel	3EZRLBTDN00
2	LCD Cover	3DZRLLCDN00
3	LED Panel	AA0156B6033
4	LCD Hinge	FBZRD005010

# FRU List

Table 6-3. FRU List

Category	Description	Acer Part No.
<b>ADAPTER</b>		
	Adapter DELTA 65W 19V 1.7x5.5x11 Yellow ADP-65VH BA, LV5, Low profile LED LF	AP.06501.033
	Adapter LITE-ON 65W 19V 1.7x5.5x11 Yellow PA-1650-69AW, LV5, Low profile LED LF	AP.06503.029
	Adapter Chicony Power 65W 19V 1.7x5.5x11 Yellow CPA09-A065N1, LV5, low profile LED LF	AP.0650A.017
<b>BATTERY</b>		
	Battery SANYO AS10D Li-Ion 3S2P SANYO 6 cell 4400mAh Main COMMON new IC BQ8055	BT.00603.124
	Battery SONY AS10D Li-Ion 3S2P SONY 6 cell 4400mAh Main COMMON ID:AS10D41	BT.00604.049
	Battery PANASONIC AS10D51, for new IC max1787 Li-Ion 3S2P PANASONIC 6 cell 4400mAh Main COMMON	BT.00605.072
	Battery SAMSUNG AS10D Li-Ion 3S2P SAMSUNG 6 cell 4400mAh Main COMMON ID:AS10D61	BT.00606.008
	Battery SIMPLO AS10D Li-Ion 3S2P PANASONIC 6 cell 4400mAh Main COMMON ID:AS10D71	BT.00607.125
	Battery SIMPLO AS10D Li-Ion 3S2P LGC 6 cell 4400mAh Main COMMON ID:AS10D73	BT.00607.126
	Battery SIMPLO AS10D Li-Ion 3S2P SAMSUNG 6 cell 4400mAh Main COMMON ID:AS10D75	BT.00607.127
	Battery LGC AS10D Li-Ion 3S2P LGC 6 cell 4400mAh Main COMMON ID:AS10D81	BT.0060G.001
<b>BOARD</b>		
	Foxconn Atheros BU22 BT4.0 Foxconn Atheros BU22	BH.21100.017
	Foxconn Braodcom 20702 BT4.0	BH.21100.018
	Foxconn Bluetooth BRM 2070 (T77H114.01) BT 3.0	BH.21100.010
	Foxconn Bluetooth ATH BU12	BH.21100.011
	Foxconn Bluetooth BRM 2070 (T77H114.01)	BH.21100.007
	Foxconn Bluetooth ATH BU_12	BH.21100.012

**Table 6-3. FRU List**

Category	Description	Acer Part No.
	Lan Intel WLAN 100BN.HMWWG Crane Peak 1x1 BGN	KI.CNH01.002
	Liteon Wireless LAN Atheros HB125 1x1 BGN	NI.23600.086
	liteon WLAN 802.11 B/G/N WN6606LH-AA	NI.23600.088
	Foxconn Wirelss LAN Broadcom 4313 1x1 BGN (HM) T77H194.00	NI.23600.076
	Foxconn Wirelss LAN Atheros HB95 1x1 BGN (HM) T77H121.01	NI.23600.068
	Foxconn Wirelss LAN Atheros HB125 1x1 BGN	NI.23600.085
	Foxconn Wirelss LAN Broadcom 4313 IPA 1x1 BGN	NI.23600.090
	ZRL POWER/B ASSY	55.RR907.001
	ZRL USB BOARD ASSY	55.RR907.002
	TOUCH PAD	56.R6Z07.001
<b>CABLE</b>		
	PWR CORD V442S311612100(1M,3P,125V)US BK	27.A50V7.001
	PWR CORD 5-KBB0237(1.0M,3P,125V,7A)US	27.S0207.001
	PWR CORD PRC 3P 1M 250V BLK K0A0646-079 (CCC) - unapproved	27.A03V7.006
	PWR CORD D646B301612(1M,3P,250V)CHINA BK(CCC)	27.TATV7.005
	PWR CORD V4K5B3(1M,3P,250V16A)EUR+KOR BK	27.A99V7.002
	PWR CORD 5-KBB0232(1.0M,3P,250V,2.5A)EUR	27.A99V7.004





**Table 6-3. FRU List**

Category	Description	Acer Part No.
	CABLE - FFC USB	50.NCE07.003
	CABLE - FFC TP	50.NCE07.001
<b>CASE/COVER/BRACKET ASSEMBLY</b>		
	LOWER CASE	60.RR907.003
	DUMMY CARD	42.TVM07.002
	ODD BEZEL - SUPER MULTI	42.NCE07.001
	ODD BRACKET	33.PUM07.001
	HDD BRACKET	33.NCE07.001
	LCD BRACKET W/ HINGE - L	33.NCE07.002
	LCD BRACKET W/ HINGE - R	33.NCE07.003

**Table 6-3. FRU List**

Category	Description	Acer Part No.
<b>CCD</b>		
	Liteon CAMERA 10P2SF005 (0.3M)LOE	AM.21400.078
<b>CPU/PROCESSOR</b>		
	CPU Intel Core i3 i3-2310M PGA 2.1G 35W 2/4-QS	KC.23101.DMP
	CPU Intel Core i3 i3-2330M PGA 2.2G 35W 2/4-QS	KC.23301.DMP
	CPU Intel Core i3 i3-2350M PGA 2.3G 35W 2/4-QS	KC.23501.DMP
	CPU Intel Pentium Dual-Core B940 PGA 2.0G 35W DDR3-1333-QS	KC.94001.DPB
	CPU Intel Pentium Dual-Core B950 PGA 2.1G 35W DDR3-1333-QS	KC.95001.DPB
	CPU Intel Core i3 i3-2310M PGA 2.1G 35W 2/4-DC	KC.23101.DMP
	CPU Intel Core i3 i3-2330M PGA 2.2G 35W 2/4-MP	KC.23301.DMP
	CPU Intel Core i3 i3-2350M PGA 2.3G 35W 2/4-MP	KC.23501.DMP
	CPU Intel Pentium Dual-Core B940 PGA 2.0G 35W DDR3-1333 -MP	KC.94001.DPB
	CPU Intel Pentium Dual-Core B950 PGA 2.1G 35W DDR3-1333 -MP	KC.95001.DPB
	CPU Intel Celeron B710 PGA 1.6G 35W DDR3-1333, 1/1-QS	KC.71001.CMB
	CPU Intel Celeron B800 PGA 1.5G 35W DDR3-1333-QS	KC.80001.CMB
<b>DVD RW DRIVE</b>		
	ZQ5 DVD+/-RW/RAM F/W:1.00 S.P	KU.00807.075

**Table 6-3. FRU List**

Category	Description	Acer Part No.
	ODD PANASONIC Super-Multi DRIVE 12.7mm Tray DL 8X UJ8B0 LF W/O bezel SATA (HF + ZP) Foxconn Yentai Facotry	KU.00807.078
	ODD PANASONIC Super-Multi DRIVE 12.7mm Tray DL 8X UJ8B0AW LF+HF W/O bezel SATA (Win7)	KU.00807.079
	ODD HLDS Super-Multi DRIVE 12.7mm Tray DL 8X GT32N (R5-2) LF W/O bezel SATA with Renesas solution + PCC LD (HF + Windows 7)	KU.0080D.055
	ODD HLDS Super-Multi DRIVE 12.7mm Tray DL 8X GT34N LF W/O bezel SATA Zero Power Supported, PCC LD (HF + Windows 7)	KU.0080D.057
	ODD PLDS Super-Multi DRIVE 12.7mm Tray DL 8X DS-8A5SH LF+HF W/O bezel SATA With TI + Rohm Solution (HF + Windows 7)	KU.0080F.014
	ODD PIONEER Super-Multi DRIVE 12.7mm Tray DL 8X DVR-TD11RS LF W/O bezel 1.01 SATA HF + ZP (HME OPU)	KU.00805.051
<b>HDD/HARD DISK DRIVE</b>		
	HDD SEAGATE 2.5" 5400rpm 500GB ST9500325AS,9HH134-189, Wyatt with new pcb SATA 8MB LF F/W:0001SDM1	KH.50001.017
	HDD SEAGATE 2.5" 5400rpm 250GB ST250LT003/9YG14C-188, Sapta 15 320G/P SATA 8MB LF+HF F/W:0001SDM1	KH.25001.020
	HDD SEAGATE 2.5" 5400rpm 320GB ST320LT020 /9YG142-188, Sapta 15,320G/P SATA 8MB LF+HF F/W:0001SDM1	KH.32001.021
	HDD TOSHIBA 2.5" 5400rpm 250GB MK2559GSXP,Capricorn 3BS, 4K drive, 375G/P SATA 8MB LF+HF F/W:GN003J 4K drive	KH.25004.006
	HDD TOSHIBA 2.5" 5400rpm 320GB MK3259GSXP, Capricorn 3BS, 375G/P, 4K drive SATA 8MB LF+HF F/W:GN003J 4K	KH.32004.005
	HDD TOSHIBA 2.5" 5400rpm 500GB MK5059GSXP, Capricron 3BS, 375G/P SATA 8MB LF+HF F/W:GN003J 4K	KH.50004.003
	HDD TOSHIBA 2.5" 5400rpm 640GB MK6459GSXP, Capricron 3BS, 375G/P SATA 8MB LF+HF F/W:GN003J 4K	KH.64004.003
	HDD WD 2.5" 5400rpm 7500GB WD750BPVT-22HXZT3, ML375M-AF2, 375G/P, 4K drive SATA 8MB LF+HF F/W:01.01A01	KH.75008.011

**Table 6-3. FRU List**

Category	Description	Acer Part No.
	HDD TOSHIBA 2.5" 5400rpm 750GB MK7559GSX, 375G/P, Capricorn BS, 4K drive SATA 8MB LF+HF F/W:GNDD3J	KH.75004.001
	HDD WD 2.5" 5400rpm 250GB WD2500BPVT-22JJ5T0, ML320S-AF2, 320G/P, 4K drive SATA 8MB LF+HF F/W:01.01A01	KH.25008.030
	HDD WD 2.5" 5400rpm 320GB WD3200BPVT-22JJ5T0, ML320S-AF2, 320G/P, 4K drive SATA 8MB LF+HF F/W:01.01A01	KH.32008.024
	HDD WD 2.5" 5400rpm 500GB WD5000BPVT-22HXZT3, ML375M-AF2, 375G/P, 4K drive SATA 8MB LF+HF F/W:01.01A01	KH.50008.024
	HTS543225A7A384 for Eagle-B7 250GB	KH.25007.020
	HDD HGST 2.5" 5400rpm 320GB HTS543232A7A384,0J11523, Eagle B7, 320G/P SATA LF+HF F/W:A60W	KH.32007.013
	HDD HGST 2.5" 5400rpm 500GB HTS547550A9E384, Jet B,375G/P SATA 8MB LF+HF F/W:DA3872	KH.50007.013
	HDD HGST 2.5" 5400rpm 640GB HTS547564A9E384,Jet B, 375G/P, 0J20012 SATA 8MB LF+HF F/W:DA3872	KH.64007.003
	HDD HGST 2.5" 5400rpm 750GB HTS547575A9E384, 0J20013, Jet B, 375G/P SATA 8MB LF F/W:DA3872	KH.75007.004
	HDD WD 2.5" 5400rpm 640GB WD6400BPVT-22HXZT3, ML375M-AF2, 375G/P, 4K drive SATA 8MB LF+HF F/W:01.01A01	KH.64008.006
	HDD SEAGATE 2.5" 5400rpm 640GB Desaru, ST9640423AS,9ZW144-188, 375G/P, 4K drive SATA 8MB LF+HF F/W:0001SDM1	KH.64001.005
HDD SEAGATE 2.5" 5400rpm 750GB ST9750423AS,9ZW14G-188, Desaru5, 375G/P. SATA 8MB LF+HF F/W:0001SDM1	KH.75001.011	
<b>HEATSINK</b>		
	THERMAL MODULE 35W - UMA	60.RR907.008





**Table 6-3. FRU List**

Category	Description	Acer Part No.
	PCH HEAT SINK	60.PUM07.006
<b>KEYBOARD</b>		
	Keyboard ACER AC7T_A10B AC7T Internal 17 Standard 103KS Black US International Texture	KB.I170A.143
	K/B(UI)ZR7(AEZR7R00,3B)JMO	KB.I170A.143
	Keyboard ACER AC7T_A10B AC7T Internal 17 Standard 104KS Black UK Texture	KB.I170A.143
	K/B(UK)ZR7(AEZR7E00,3D)JMO	KB.I170A.171
<b>LCD</b>		
	LED LCD AUO 15.6"W WXGA Glare B156XW02 V6 LF 200nit 8ms 400:1	LK.15605.019
	LED LCD SAMSUNG 15.6"W WXGA Glare LTN156AT02-A11 LF 220nit 8ms 500:1	LK.15606.012
	LED LCD SAMSUNG 15.6"W WXGA Glare LTN156AT24-A01 LF 220nit 8ms 500:1	LK.15606.013
	LED LCD LPL 15.6"W WXGA Glare LP156WH2-TLEA LF 220nit 16ms 500:1 (color engine)	LK.15608.011
	LED LCD LPL 15.6"W WXGA Glare LP156WH4-TLA1 LF 220nit 16ms 500:1	LK.15608.015
	LED LCD CMO 15.6"W WXGA Glare N156B6-LOB LF 220nit 8ms 650:1	LK.1560D.010
	LED LCD AUO 15.6"W WXGA Glare B156XW02 V6 LF 200nit 8ms 400:1	LK.15605.019
<b>MAINBOARD</b>		
	ZRL MB ASSY(UMA,HR,DC)W/O CPU	MB.RR706.001
	ZRL MB(UMA,HR,DC,SURGE)W/O CPU	MB.D1206.001

**Table 6-3. FRU List**

Category	Description	Acer Part No.
<b>MEMORY</b>		
	Memory NANYA SO-DIMM DDRIII 1333 1GB NT1GC64BH4B0PS-CG LF 128*16 0.055um	KN.1GB03.034
	Memory KINGSTON SO-DIMM DDRIII 1333 1GB ACR128X64D3S1333C9 LF 128*8 0.065um	KN.1GB07.004
	Memory UNIFOSA SO-DIMM DDRIII 1333 1GB GU672203EP0200 LF 128*8 0.065um	KN.1GB0H.017
	Memory NANYA SO-DIMM DDRIII 1333 2GB NT2GC64B8HC0NS-CG LF 128*8 0.065um	KN.2GB03.017
	Memory KINGSTON SO-DIMM DDRIII 1333 2GB ACR256X64D3S13C9G LF+HF	KN.2GB07.006
	Memory ELPIDA SO-DIMM DDRIII 1333 2GB EBJ20UF8BCS0-DJ-F LF 256*8 46nm	KN.2GB09.010
	Memory SAMSUNG SO-DIMM DDRIII 1333 2GB M471B5773DH0-CH9 LF 256*8	KN.2GB0B.030
	Memory HYNIX SO-DIMM DDRIII 1333 2GB HMT325S6BFR8C-H9 LF 256*8 46nm	KN.2GB0G.018
	Memory NANYA SO-DIMM DDRIII 1333 4GB NT4GC64B8HB0NS-CG LF 256*8 0.055um	KN.4GB03.005
	Memory KINGSTON SO-DIMM DDRIII 1333 4GB ACR512X64D3S13C9G LF+HF	KN.4GB07.001
	Memory ELPIDA SO-DIMM DDRIII 1333 4GB EBJ41UF8BCS0-DJ-F LF 256*8 46nm	KN.4GB09.002
	Memory SAMSUNG SO-DIMM DDRIII 1333 4GB M471B5273DH0-CH9 LF 256*8 35nm	KN.4GB0B.015
	Memory HYNIX SO-DIMM DDRIII 1333 4GB HMT351S6BFR8C-H9 LF 256*8 46nm	KN.4GB0G.004
<b>MISCELLANEOUS</b>		
	BASE FOOT RUBBER FRONT	47.NCE07.003

**Table 6-3. FRU List**

Category	Description	Acer Part No.
	BASE FOOT RUBBER REAR	47.NCE07.004
<b>MYLAR</b>		
	COVER LOGO MYLAR	40.RR907.002
	ZRD BASE SUB ASSY JE S.P	60.NCE07.002
	TP PROTECT MYLAR	47.R6Z07.004
	LCD SCREW MYLAR	47.R6Z07.003
<b>SPEAKER</b>		
	SPEAKER	23.RR907.001

# Screw List

---

**Table 6-4. Screw List**

CATEGORY	Description	Acer Part No.
	SCREW M3*0.5+3.5I	86.TDY07.003
	SCREW M2.5*6-I(BNI)(NYLOK)	86.A08V7.004
	SCREW M2.5X4-I-NYLOK K	86.T23V7.009
	SCREW M2.5*6-I(BNI)(NYLOK)	86.A08V7.004
	SCREW M2.0*3.0-I(BKAG)(NYLOK IRON	86.ARE07.002



# CHAPTER 7

## Model Definition and Configuration



<b>Aspire 5349</b> .....	<b>7-3</b>
<b>Aspire 5749Z</b> .....	<b>7-5</b>
<b>Aspire 5749</b> .....	<b>7-7</b>

# Model Definition and Configuration

## Aspire 5349

**Table 7-1. RO, Description**

Model	RO	Country	Acer Part No	Description
AS5349-B802 G50Mikk	TWN	GCTWN	LX.RR902.008	AS5349-B802G50Mikk W7HP64ASTW1 MC UMACKk_3 1*2G/500/BT/6L2.2/2R/CB_GN_ 0.3C_AN_TC41SP1
AS5349-B802 G50Mikk	AAP	Korea	LX.RR902.007	AS5349-B802G50Mikk W7HP64KASKR1 MC UMACKk_3 1*2G/500/6L2.2/2R/CB_GN_0.3 C_outer_AN_KO11SP1
AS5349-B802 G50Mikk	AAP	Korea	LX.RR90C.001	AS5349-B802G50Mikk LinpusMGAKR1 UMACKk_3 1*2G/500_L/6L2.2/2R/CB_GN_0. 3C_outer_AN_KO21
AS5349-B802 G25Mikk	PA	USA	LX.RR902.004	AS5349-B802G25Mikk W7HP64ASUS1 MC UMACKk_3 1*2G/250/6L2.2/2R/CB_GN_0.3 C_AN_FRB9SP1
AS5349-B802 G32Mikk	EMEA	Russia	LX.RR908.003	AS5349-B802G32Mikk W7ST32RUASRU1 MC UMACKk_3 1*2G/320/6L2.2/2R/CB_GN_0.3 C_AN_RU11SP1
AS5349-B802 G32Mikk	EMEA	Greece	LX.RR902.006	AS5349-B802G32Mikk W7HP64ASGR1 MC UMACKk_3 1*2G/320/6L2.2/2R/CB_GN_0.3 C_AN_EL32SP1
AS5349-B803 G50Mikk	EMEA	Greece	LX.RR902.005	AS5349-B803G50Mikk W7HP64ASGR1 MC UMACKk_3 2G+1G/500_L/6L2.2/2R/CB_GN_ 0.3C_AN_EL32SP1
AS5349-B802 G32Mikk	EMEA	Middle East	LX.RR908.002	AS5349-B802G32Mikk EM W7ST32EMASME1 MC UMACKk_3 1*2G/320/BT/6L2.2/2R/CB_GN_ 0.3C_AN_ARA1SP1

**Table 7-1. RO, Description (Continued)**

<b>Model</b>	<b>RO</b>	<b>Country</b>	<b>Acer Part No</b>	<b>Description</b>
AS5349-B802 G32Mikk	EMEA	Middle East	LX.RR908.001	AS5349-B802G32Mikk EM W7ST32EMASME1 MC UMACKk_3 1*2G/320/6L2.2/2R/CB_GN_0.3 C_AN_ARA1SP1
AS5349-B804 G50Mikk	EMEA	Germany	LX.RR902.003	AS5349-B804G50Mikk W7HP64ASDE1 MC UMACKk_3 1*4G/500_L/6L2.2/2R/CB_GN_0. 3C_AN_DE11SP1
AS5349-B802 G25Mikk	AAP	Japan	LX.RR902.002	AS5349-B802G25Mikk W7HP64AJP1 MC UMACKk_3 1*2G/250/BT/6L2.2/2R/CB_GN_ 0.3C_outer_AN_JA11SP1_BT82 2
AS5349-B802 G32Mikk	AAP	Japan	LX.RR902.001	AS5349-B802G32Mikk W7HP64AJP1 MC UMACKk_3 1*2G/320/BT/6L2.2/2R/CB_GN_ 0.3C_outer_AN_JA11SP1_BT82 3

# Aspire 5749Z

**Table 1-2. RO, Description**

Model	RO	Country	Acer Part No	Description
AS5749Z-B95 3G32Mikk	EMEA	Russia	LX.RR801.002	AS5749Z-B953G32Mikk W7HB64RUASRU1 MC UMACKk_3 2G+1G/320/6L2.2/2R/CB_GN_0. 3C_AN_RU11SP1
AS5749Z-B95 4G32Mikk	EMEA	Serbia/Bosnia- Herzegovina	LX.RR801.001	AS5749Z-B954G32Mikk W7HB64ERASBA1 MC UMACKk_3 1*4G/320/BT/6L2.2/2R/CB_GN_ 0.3C_AN_A151SP1
AS5749Z-B95 4G32Mikk	EMEA	Serbia/Bosnia- Herzegovina	LX.RR802.011	AS5749Z-B954G32Mikk W7HP64ASBA1 MC UMACKk_3 1*4G/320/BT/6L2.2/2R/CB_GN_ 0.3C_AN_A151SP1
AS5749Z-B94 4G32Mikk	EMEA	Serbia/Bosnia- Herzegovina	LX.RR802.010	AS5749Z-B944G32Mikk W7HP64ASBA1 MC UMACKk_3 1*4G/320/BT/6L2.2/2R/CB_GN_ 0.3C_AN_A151SP1
AS5749Z-B95 4G32Mikk	AAP	Japan	LX.RR802.009	AS5749Z-B954G32Mikk W7HP64AJP1 MC UMACKk_3 2*2G/320/6L2.2/2R/CB_GN_0.3 C_outer_AN_JA11SP1SP1
AS5749Z-B95 2G32Mikk	AAP	Japan	LX.RR802.008	AS5749Z-B952G32Mikk W7HP64AJP1 MC UMACKk_3 1*2G/320/6L2.2/2R/CB_GN_0.3 C_outer_AN_JA11SP1SP1
AS5749Z-B95 2G32Mikk	AAP	Japan	LX.RR802.007	AS5749Z-B952G32Mikk W7HP64AP2JP1 MC UMACKk_3 1*2G/320/6L2.2/2R/CB_GN_0.3 C_outer_AN_JA11SP1SP1
AS5749Z-B95 4G32Mikk	AAP	Japan	LX.RR802.006	AS5749Z-B954G32Mikk W7HP64AP2JP1 MC UMACKk_3 2*2G/320/6L2.2/2R/CB_GN_0.3 C_outer_AN_JA11SP1SP1
AS5749Z-B95 2G50Mikk	TWN	GCTWN	LX.RR802.005	AS5749Z-B952G50Mikk W7HP64ASTW1 MC UMACKk_3 1*2G/500/BT/6L2.2/2R/CB_GN_ 0.3C_AN_TC41SP1

**Table 1-2. RO, Description (Continued)**

<b>Model</b>	<b>RO</b>	<b>Country</b>	<b>Acer Part No</b>	<b>Description</b>
AS5749Z-B94 2G25Mikk	AAP	Japan	LX.RR802.004	AS5749Z-B942G25Mikk W7HP64AJP1 MC UMACKk_3 1*2G/250/BT/6L2.2/2R/CB_GN_ 0.3C_outer_AN_JA11SP1_CA92 5
AS5749Z-B94 2G32Mikk	AAP	Japan	LX.RR802.003	AS5749Z-B942G32Mikk W7HP64AJP1 MC UMACKk_3 1*2G/320/BT/6L2.2/2R/CB_GN_ 0.3C_outer_AN_JA11SP1_CA92 3
AS5749Z-B94 2G50Mikk	TWN	GCTWN	LX.RR802.002	AS5749Z-B942G50Mikk W7HP64ASTW1 MC UMACKk_3 1*2G/500/BT/6L2.2/2R/CB_GN_ 0.3C_AN_TC41SP1

# Aspire 5749

**Table 1-3. RO, Description**

Model	RO	Country	Acer Part No	Description
AS5749-2333 G32Mikk	EMEA	Russia	LX.RR701.002	AS5749-2333G32Mikk W7HB64RUASRU1 MC UMACKk_3 2G+1G/320/6L2.2/2R/CB_GN_0. 3C_AN_RU11SP1
AS5749-2334 G50Mikk	EMEA	Spain	LX.RR702.002	AS5749-2334G50Mikk W7HP64ASES1 MC UMACKk_3 2*2G/500_L/6L2.2/2R/CB_GN_0. 3C_AN_ES51SP1
AS5749-2314 G50Mikk	EMEA	Spain	LX.RR702.001	AS5749-2314G50Mikk W7HP64ASES1 MC UMACKk_3 2*2G/500_L/6L2.2/2R/CB_GN_0. 3C_AN_ES51SP1
AS5749-2332 G32Mikk	EMEA	Middle East	LX.RR701.001	AS5749-2332G32Mikk EM W7HB64EMASME1 MC UMACKk_3 1*2G/320/BT/6L2.2/2R/CB_GN_ 0.3C_AN_ARA1SP1
AS5749-2312 G50Mikk	AAP	Vietnam	LX.RR70C.001	AS5749-2312G50Mikk LinpusMGAVN1 UMACKk_3 1*2G/500_L/BT/6L2.2/2R/CB_GN_ _0.3C_outer_AN_XS11
R510HR-B94 2G50Mikk	CHINA	China	LX.D120C.001	R510HR-B942G50Mikk LINPUSfCN1 UMACKk_3 1*2G/500_L/6L2.2/2R/CB_GN_0. 3C_outer_AN_SC25
R510HR-B94 2G50Mikk	CHINA	China	LX.D1201.001	R510HR-B942G50Mikk W7HB32SCfSCN1 UMACKk_3 1*2G/500/6L2.2/2R/CB_GN_0.3 C_outer_AN_SC27SP1





# CHAPTER 8

## Test Compatible Components

---

**Microsoft® Windows® 7 Environment Test. . . . . 8-4**

# Test Compatible Components

---

This computer's compatibility is tested and verified by Acer's internal testing department. All of its system functions are tested under Windows® 7 environment.

Refer to the following lists for components, adapter cards, and peripherals which have passed these tests. Regarding configuration, combination and test procedures, please refer to the Aspire 5349/5749/5749Z. Compatibility Test Report released by the Acer Mobile System Testing Department.

# Microsoft® Windows® 7 Environment Test

**Table 1-1. Test Compatible Components**

Vendor	Type	Description	Acer Part No.
<b>Adapter</b>			
10001023 LITE-ON	65W	Adapter LITE-ON 65W 19V 1.7x5.5x11 Yellow PA-1650-69AW, LV5, Low profile LED LF	AP.06503.029
60016453 CHICONY POWER	65W	Adapter Chicony Power 65W 19V 1.7x5.5x11 Yellow CPA09-A065N1, LV5, low profile LF	AP.0650A.017
10001081 DELTA	65W	Adapter DELTA 65W 19V 1.7x5.5x11 Yellow ADP-65VH BA, LV5, Low profile LED LF	AP.06501.033
<b>Audio Codec</b>			
10004786 REALTEK	ALC271X_VB3	Realtek ALC271X_VB3	LZ.21000.085
<b>Battery</b>			
60001921 SANYO	6CELL2.2	Battery SANYO AS10D Li-Ion 3S2P SANYO 6 cell 4400mAh Main COMMON new IC BQ8055	BT.00603.124
10001063 SONY	6CELL2.2	Battery SONY AS10D Li-Ion 3S2P SONY 6 cell 4400mAh Main COMMON ID:AS10D41	BT.00604.049
60001535 PANASONIC	6CELL2.2	Battery PANASONIC AS10D51, for new IC max1787 Li-Ion 3S2P PANASONIC 6 cell 4400mAh Main COMMON	BT.00605.072
60013145 SAMSUNG SDI	6CELL2.2	Battery SAMSUNG AS10D Li-Ion 3S2P SAMSUNG 6 cell 4400mAh Main COMMON ID:AS10D61	BT.00606.008
60002162 SIMPLO	6CELL2.2	Battery SIMPLO AS10D Li-Ion 3S2P PANASONIC 6 cell 4400mAh Main COMMON ID:AS10D71	BT.00607.125
60002162 SIMPLO	6CELL2.2	Battery SIMPLO AS10D Li-Ion 3S2P LGC 6 cell 4400mAh Main COMMON ID:AS10D73	BT.00607.126
60002162 SIMPLO	6CELL2.2	Battery SIMPLO AS10D Li-Ion 3S2P SAMSUNG 6 cell 4400mAh Main COMMON ID:AS10D	BT.00607.127
60032811 LG CHEM	6CELL2.2	Battery LGC AS10D Li-Ion 3S2P LGC 6 cell 4400mAh Main COMMON ID:AS10D81	BT.0060G.001

**Table 1-1. Test Compatible Components**

<b>Vendor</b>	<b>Type</b>	<b>Description</b>	<b>Acer Part No.</b>
<b>Bluetooth</b>			
10001018 HON HAI	BT 4.0	BT 4.0 Foxconn Atheros BU22	BH.21100.017
10001018 HON HAI	BT 4.0	BT 4.0 Foxconn BCM 20702	BH.21100.018
10001018 HON HAI	BT 3.0	Foxconn Bluetooth ATH BU12	BH.21100.011
10001018 HON HAI	BT 3.0	Foxconn Bluetooth BRM 2070 (T77H114.01) BT 3.0	BH.21100.010
10001018 HON HAI	BT 2.1	Foxconn Bluetooth ATH BU_12	BH.21100.012
23707801 FOXCONN TW	BT 2.1	Foxconn Bluetooth BRM 2070 (T77H114.01)	BH.21100.007
10001018 HON HAI	BT 3.0	Foxconn Bluetooth ATH BU_22	BH.21100.021
10001018 HON HAI	BT 3.0	Foxconn Bluetooth BCM 20702	BH.21100.022
10001018 HON HAI	BT 2.1	BT 2.1 Foxconn ATH BU22	BH.21100.023
10001018 HON HAI	BT 2.1	BT 2.1 Foxconn BCM 20702	BH.21100.024
<b>Camera</b>			
10001023 LITE-ON	0.3M	Liteon 0.3M LT7675AL	AM.21400.078
PLM00012 Suyin	0.3M	Suyin 0.3M SY_7675_AL	AM.21400.109
10001044 CHICONY	0.3M	Chicony Camera CH_7675_AL	AM.21400.111
<b>Card Reader</b>			
10000981 MISC	2-in-1 card reader	2-in-1 card reader	CR.21500.030

**Table 1-1. Test Compatible Components**

Vendor	Type	Description	Acer Part No.
<b>CPU</b>			
10001067 INTEL	Ci32310M	CPU Intel Core i3 i3-2310M PGA 2.1G 35W 2/4	KC.23101.DMP
10001067 INTEL	Ci32330M	CPU Intel Core i3 i3-2330M PGA 2.2G 35W 2/4	KC.23301.DMP
10001067 INTEL	PMDB940	CPU Intel Pentium Dual-Core B940 PGA 2.0G 35W DDR3-1333	KC.94001.DPB
10001067 INTEL	PMDB950	CPU Intel Pentium Dual-Core B950 PGA 2.1G 35W DDR3-1333	KC.95001.DPB
10001067 INTEL	CMB800	CPU Intel Celeron B800 PGA 1.5G 35W DDR3-1333	KC.80001.CMB
10001067 INTEL	CMB710	CPU Intel Celeron B710 PGA 1.6G 35W DDR3-1333, 1/1	KC.71001.CMB
10001067 INTEL	Ci32350M	CPU Intel Core i3 i3-2350M PGA 2.3G 35W 2/4	KC.23501.DMP
10001067 INTEL	PMDB960	CPU Intel Pentium Dual-Core B960 PGA 35W DDR3-1333	KC.96001.DPB
<b>HDD</b>			
60002036 SEAGATE	N250GB5.4KS_4K	HDD SEAGATE 2.5" 5400rpm 250GB ST250LT003/9YG14C-188, Supta 15 320G/P SATA 8MB LF+HF F/W:0001SDM1	KH.25001.020
60001922 TOSHIBA DIGI	N250GB5.4KS_4K	HDD TOSHIBA 2.5" 5400rpm 250GB MK2559GSXP,Capricorn 3BS, 4K drive, 375G/P SATA 8MB LF+HF F/W:GN003J 4K drive	KH.25004.006
60002005 HGST SG	N250GB5.4KS	HDD HGST 2.5" 5400rpm 250GB HTS543225A7A384, Eagle B7, 320G/P SATA 8MB LF+HF F/W:A60W	KH.25007.020
60001994 WD	N250GB5.4KS_4K	HDD WD 2.5" 5400rpm 250GB WD2500BPVT-22JJ5T0, ML320S-AF2, 320G/P, 4K drive SATA 8MB LF+HF F/W:01.01A01	KH.25008.030
60002036 SEAGATE	N320GB5.4KS_4K	HDD SEAGATE 2.5" 5400rpm 320GB ST320LT020 /9YG142-188, Supta 15,320G/P SATA 8MB LF+HF F/W:0001SDM1	KH.32001.021
60001922 TOSHIBA DIGI	N320GB5.4KS_4K	HDD TOSHIBA 2.5" 5400rpm 320GB MK3259GSXP, Capricorn 3BS, 375G/P, 4K drive SATA 8MB LF+HF F/W:GN003J 4K	KH.32004.005

**Table 1-1. Test Compatible Components**

<b>Vendor</b>	<b>Type</b>	<b>Description</b>	<b>Acer Part No.</b>
60002005 HGST SG	N320GB5.4KS	HDD HGST 2.5" 5400rpm 320GB HTS543232A7A384, Eagle B7, 320G/P SATA LF+HF F/W:A60W	KH.32007.013
60001994 WD	N320GB5.4KS_ 4K	HDD WD 2.5" 5400rpm 320GB WD3200BPVT-22JJ5T0, ML320S-AF2, 320G/P, 4K drive SATA 8MB LF+HF F/W:01.01A01	KH.32008.024
60002036 SEAGATE	N500GB5.4KS	HDD SEAGATE 2.5" 5400rpm 500GB ST9500325AS,9HH134-189, Wyatt with new pcb SATA 8MB LF F/W:0001SDM1	KH.50001.017
60001922 TOSHIBA DIGI	N500GB5.4KS_ 4K	HDD TOSHIBA 2.5" 5400rpm 500GB MK5059GSXP, Capricron 3BS, 375G/P SATA 8MB LF+HF F/W:GN003J 4K	KH.50004.003
60002005 HGST SG	N500GB5.4KS_ 4K	HDD HGST 2.5" 5400rpm 500GB HTS547550A9E384, Jet B,375G/P SATA 8MB LF+HF F/W:DA3872	KH.50007.013
60001994 WD	N500GB5.4KS_ 4K	HDD WD 2.5" 5400rpm 500GB WD5000BPVT-22HXZT3, ML375M-AF2, 375G/P, 4K drive SATA 8MB LF+HF F/W:01.01A01	KH.50008.024
60002036 SEAGATE	N640GB5.4KS	HDD SEAGATE 2.5" 5400rpm 640GB ST9640320AS,9RN134-189, Cameron, 320G/P SATA 8MB LF F/W:0001SDM1	KH.64001.004
60001922 TOSHIBA DIGI	N640GB5.4KS_ 4K	HDD TOSHIBA 2.5" 5400rpm 640GB MK6459GSXP, Capricron 3BS, 375G/P SATA 8MB LF+HF F/W:GN003J 4K	KH.64004.003
60002005 HGST SG	N640GB5.4KS_ 4K	HDD HGST 2.5" 5400rpm 640GB HTS547564A9E384,Jet B, 375G/P SATA 8MB LF+HF F/W:DA3872	KH.64007.003
60001994 WD	N640GB5.4KS_ 4K	HDD WD 2.5" 5400rpm 640GB WD6400BPVT-22HXZT3, ML375M-AF2, 375G/P, 4K drive SATA 8MB LF+HF F/W:01.01A01	KH.64008.006
60002036 SEAGATE	N750GB5.4KS_ 4K	HDD SEAGATE 2.5" 5400rpm 750GB ST9750423AS,9ZW14G-188, Desaru5, 375G/P. SATA 8MB LF+HF F/W:0001SDM1	KH.75001.011

**Table 1-1. Test Compatible Components**

<b>Vendor</b>	<b>Type</b>	<b>Description</b>	<b>Acer Part No.</b>
60001922 TOSHIBA DIGI	N750GB5.4KS_4K	HDD TOSHIBA 2.5" 5400rpm 750GB MK7559GSXP, 750G, Capricorn 3BS SATA 8MB LF+HF F/W:GN001A for external HDD market only	KH.75004.003
60002005 HGST SG	N750GB5.4KS_4K	HDD HGST 2.5" 5400rpm 750GB HTS547575A9E384, Jet B, 375G/P SATA 8MB LF F/W:DA3872	KH.75007.004
60002005 HGST SG	N750GB5.4KS	HDD HGST 2.5" 5400rpm 750GB Dummy P.N SATA 8MB LF+HF F/W: 0000	KH.75007.005
60001994 WD	N750GB5.4KS_4K	HDD WD 2.5" 5400rpm 750GB WD750BPVT-22HXZT3, ML375M-AF2, 375G/P, 4K drive SATA 8MB LF+HF F/W:01.01A01	KH.75008.011
60001922 TOSHIBA DIGI	N750GB5.4KS_4K	HDD TOSHIBA 2.5" 5400rpm 750GB MK7559GSXP, 375G/P, Capricorn BS, 4K drive SATA 8MB LF+HF F/W:GN003J	KH.75004.001
60001922 TOSHIBA DIGI	N750GB5.4KS_4K	HDD TOSHIBA 2.5" 5400rpm 750GB MK7559GSXP, 750G, Capricorn 3BS SATA 8MB LF+HF F/W:GN001A for external HDD market only	KH.75004.003
60001922 TOSHIBA DIGI	N750GB5.4KS_4K	HDD TOSHIBA 2.5" 5400rpm 750GB MK7559GSXP, 750G, Capricorn 3BS SATA 8MB LF+HF F/W:GN001A for external HDD market only	KH.75004.003
60002036 SEAGATE	N640GB5.4KS_4K	HDD SEAGATE 2.5" 5400rpm 640GB Desaru, ST9640423AS,9ZW144-188, 375G/P, 4K drive SATA 8MB LF+HF F/W:0001SDM1	KH.64001.005
60002036 SEAGATE	N640GB5.4KS	HDD SEAGATE 2.5" 5400rpm 640GB ST9640320AS,9RN134-189, Cameron, 320G/P SATA 8MB LF F/W:0001SDM1	KH.64001.004
60002036 SEAGATE	N640GB5.4KS	HDD SEAGATE 2.5" 5400rpm 640GB ST9640320AS,9RN134-189, Cameron, 320G/P SATA 8MB LF F/W:0001SDM1	KH.64001.004
<b>Keyboard</b>			



**Table 1-1. Test Compatible Components**

<b>Vendor</b>	<b>Type</b>	<b>Description</b>	<b>Acer Part No.</b>
60004864 DARFON	AC7T_A10B	Keyboard ACER AC7T_A10B AC7T Internal 17 Standard Black NONE Y2010 Acer Texture	KB.I170A.143
<b>LAN</b>			
10017383 Atheros	AR8158L	Atheros AR8158L	NI.22400.058
<b>LCD</b>			
60003316 AUO	NLED15.6WXG AG	LED LCD AUO 15.6"W WXGA Glare B156XW02 V6 LF 200nit 8ms 400:1	LK.15605.019
60002215 SAMSUNG	NLED15.6WXG AG	LED LCD SAMSUNG 15.6"W WXGA Glare LTN156AT02-A11 LF 220nit 8ms 500:1	LK.15606.012
60003089 LG	NLED15.6WXG AG	LED LCD LPL 15.6"W WXGA Glare LP156WH2-TLEA LF 220nit 16ms 500:1 (color engine)	LK.15608.011
60003089 LG	NLED15.6WXG AG	LED LCD LPL 15.6"W WXGA Glare LP156WH4-TLA1 LF 220nit 16ms 500:1	LK.15608.015
10001038 CMO	NLED15.6WXG AG	LED LCD CMO 15.6"W WXGA Glare N156B6-LOB LF 220nit 8ms 650:1	LK.1560D.010
60002215 SAMSUNG	NLED15.6WXG AG	LED LCD SAMSUNG 15.6"W WXGA Glare LTN156AT24-A01 LF 220nit 8ms 500:1	LK.15606.013
<b>Memory</b>			
60024207 KINGSTON-FAR EAST	SO2GBIII13	Memory KINGSTON SO-DIMM DDRIII 1333 2GB ACR256X64D3S13C9G LF+HF	KN.2GB07.006
60004668 ELPIDA	SO2GBIII13	Memory ELPIDA SO-DIMM DDRIII 1333 2GB EBJ20UF8BCS0-DJ-F LF 256*8 46nm	KN.2GB09.010
60002215 SAMSUNG	SO2GBIII13	Memory SAMSUNG SO-DIMM DDRIII 1333 2GB M471B5773DH0-CH9 LF 256*8	KN.2GB0B.030
60002045 HYNIX	SO2GBIII13	Memory HYNIX SO-DIMM DDRIII 1333 2GB HMT325S6BFR8C-H9 LF 256*8 46nm	KN.2GB0G.018
60001993 NANYA	SO4GBIII13	Memory NANYA SO-DIMM DDRIII 1333 4GB NT4GC64B8HB0NS-CG LF 256*8 0.055um	KN.4GB03.005

**Table 1-1. Test Compatible Components**

<b>Vendor</b>	<b>Type</b>	<b>Description</b>	<b>Acer Part No.</b>
60024207 KINGSTON-FAR EAST	SO4GBIII13	Memory KINGSTON SO-DIMM DDRIII 1333 4GB ACR512X64D3S13C9G LF+HF	KN.4GB07.001
60004668 ELPIDA	SO4GBIII13	Memory ELPIDA SO-DIMM DDRIII 1333 4GB EBJ41UF8BCS0-DJ-F LF 256*8 46nm	KN.4GB09.002
60001993 NANYA	SO2GBIII13	Memory NANYA SO-DIMM DDRIII 1333 2GB NT2GC64B8HC0NS-CG LF 128*8 0.065um	KN.2GB03.017
60002215 SAMSUNG	SO4GBIII13	Memory SAMSUNG SO-DIMM DDRIII 1333 4GB M471B5273DH0-CH9 LF 256*8 35nm	KN.4GB0B.015
60002045 HYNIX	SO4GBIII13	Memory HYNIX SO-DIMM DDRIII 1333 4GB HMT351S6BFR8C-H9 LF 256*8 46nm	KN.4GB0G.004
60024207 KINGSTON-FAR EAST	SO1GBIII13	Memory KINGSTON SO-DIMM DDRIII 1333 1GB ACR128X64D3S1333C9 LF 128*8 0.065um	KN.1GB07.004
60002000 UNIFOSA	SO1GBIII13	Memory UNIFOSA SO-DIMM DDRIII 1333 1GB GU672203EP0200 LF 128*8 0.065um	KN.1GB0H.017
60001993 NANYA	SO1GBIII13	Memory NANYA SO-DIMM DDRIII 1333 1GB NT1GC64BH4B0PS-CG LF 128*16 0.055um	KN.1GB03.034
60004668 ELPIDA	SO4GBIII10	Memory NONE SO-DIMM DDRIII 1066 4GB dummy P/N LF	KN.4GB00.001
60002041 QIMONDA	SO1GBIII10	Memory NONE REG-ECC DDRIII 1066 1GB phantom p/n LF	KN.1GB00.003
60002215 SAMSUNG	SO2GBIII10	Memory NONE SO-DIMM DDRIII 1066 2GB dummy 1066 LF	KN.2GB00.001
<b>NB Chipset</b>			
10001067 INTEL	HM65	NB Chipset Intel CS BD82HM65 B3 Huron River	KI.G6501.004
<b>ODD</b>			
60001939 PIONEER	NSM8XS	ODD PIONEER Super-Multi DRIVE 12.7mm Tray DL 8X DVR-TD11RS LF W/O bezel 1.01 SATA HF + ZP (HME OPU)	KU.00805.051

**Table 1-1. Test Compatible Components**

<b>Vendor</b>	<b>Type</b>	<b>Description</b>	<b>Acer Part No.</b>
60001535 PANASONIC	NSM8XS	ODD PANASONIC Super-Multi DRIVE 12.7mm Tray DL 8X UJ8A0 LF W/O bezel SATA (HF + Windows 7) Foxconn Yentai Facotry	KU.00807.075
60001535 PANASONIC	NSM8XS	ODD PANASONIC Super-Multi DRIVE 12.7mm Tray DL 8X UJ8B0 LF W/O bezel SATA (HF + ZP) Foxconn Yentai Facotry	KU.00807.078
610105 HLDS	NSM8XS	ODD HLDS Super-Multi DRIVE 12.7mm Tray DL 8X GT32N (R5-2) LF W/O bezel SATA with Renesas solution + PCC LD (HF + Windows 7)	KU.0080D.055
60003901 HITACHI EAST	NSM8XS	ODD HLDS Super-Multi DRIVE 12.7mm Tray DL 8X GT34N LF W/O bezel SATA Zero Power Supported, PCC LD (HF + Windows 7)	KU.0080D.057
10001070 PHILIPS	NSM8XS	ODD PLDS Super-Multi DRIVE 12.7mm Tray DL 8X DS-8A5SH LF+HF W/O bezel SATA With TI + Rohm Solution (HF + Windows 7)	KU.0080F.014
60001535 PANASONIC	NSM8XS	ODD PANASONIC Super-Multi DRIVE 12.7mm Tray DL 8X UJ8B0AW LF+HF W/O bezel SATA (Win7)	KU.00807.079
60003901 HITACHI EAST	NSM8XS	ODD HLDS Super-Multi DRIVE 12.7mm Tray DL 8X GT51N LF W/O bezel SATA Zero Power Supported (HF + Windows 7)	KU.0080D.059
<b>SB Chipset</b>			
9999995 ONE TIME VENDER	N	N	KI.22800.011
<b>Software</b>			
10000981 MISC	KIS	Antivirus application KIS Antivirus application KIS	SR.23900.011
<b>VGA Chip</b>			
10001067 INTEL	UMA	UMA (Intel)	KI.23200.038
<b>VRAM</b>			
9999995 ONE TIME VENDER	N	N no VRAM	KI.23300.014
<b>WiFi Antenna</b>			

**Table 1-1. Test Compatible Components**

<b>Vendor</b>	<b>Type</b>	<b>Description</b>	<b>Acer Part No.</b>
1000105 WNC	PIFA	PIFA	LZ.23500.006
<b>Wireless LAN</b>			
10001067 INTEL	3rd WiFi 1x1 BGN	Lan Intel WLAN 100BN.HMWWG Crane Peak 1x1 BGN	KI.CNH01.002
10001023 LITE-ON	3rd WiFi 1x1 BGN	Liteon Wireless LAN Atheros HB125 1x1 BGN	NI.23600.086
10001023 LITE-ON	3rd WiFi 1x1 BGN	Liteon Wireless LAN Realtek RTL8188CE 1x1 BGN	NI.23600.088
10001018 HON HAI	3rd WiFi 1x1 BGN	Foxconn Wireless LAN Broadcom 4313 IPA 1x1 BGN	NI.23600.090
10001018 HON HAI	3rd WiFi 1x1 BGN	Foxconn Wireless LAN Atheros HB125 1x1 BGN	NI.23600.085
23707801 FOXCONN TW	3rd WiFi 1x1 BGN	Foxconn Wireless LAN Broadcom 4313 1x1 BGN (HM) T77H194.00	NI.23600.076
10001018 HON HAI	3rd WiFi 1x1 BGN	Foxconn Wireless LAN Atheros HB95 1x1 BGN (HM) L	NI.23600.078
23707801 FOXCONN TW	3rd WiFi 1x1 BGN	Foxconn Wireless LAN Atheros HB95 1x1 BGN (HM) T77H121.01	NI.23600.068
10001018 HON HAI	3rd WiFi 1x1 BGN	Foxconn Wireless LAN Atheros HB95 1x1 BGN (HM) L	NI.23600.078
10001018 HON HAI	3rd WiFi 1x1 BGN	Foxconn Wireless LAN Atheros HB95 1x1 BGN (HM) L	NI.23600.078

# CHAPTER 9

## Online Support Information

---

**Introduction . . . . . 9-3**

# Online Support Information

---

## Introduction

---

This section describes online technical support services available to help users repair their Acer Systems.

For distributors, dealers, ASP or TPM, please refer the technical queries to a local Acer branch office. Acer Branch Offices and Regional Business Units may access our website. However some information sources will require a user i.d. and password. These can be obtained directly from Acer CSD Taiwan.

Acer's Website offers convenient and valuable support resources.

In the Technical Information section users can download information on all of Acer's Notebook, Desktop and Server models including:

- Service guides for all models
- Bios updates
- Software utilities
- Spare parts lists
- TABs (Technical Announcement Bulletin)

For these purposes, we have included an Acrobat File to facilitate the problem-free downloading of our technical material.

Also contained on this website are:

- Detailed information on Acer's International Traveller's Warranty (ITW)
- Returned material authorization procedures
- An overview of all the support services we offer, accompanied by a list of telephone, fax and email contacts for all technical queries.

We are always looking for ways to optimize and improve our services, so do not hesitate to direct any suggestions or comments to us.





## Free Manuals Download Website

<http://myh66.com>

<http://usermanuals.us>

<http://www.somanuals.com>

<http://www.4manuals.cc>

<http://www.manual-lib.com>

<http://www.404manual.com>

<http://www.luxmanual.com>

<http://aubethermostatmanual.com>

Golf course search by state

<http://golfingnear.com>

Email search by domain

<http://emailbydomain.com>

Auto manuals search

<http://auto.somanuals.com>

TV manuals search

<http://tv.somanuals.com>