

Liquid M220 User's Manual



© 2015 All Rights Reserved

Acer Liquid M220 User's Manual

Model: M220

This revision: April 2015



Important

This manual contains proprietary information that is protected by copyright laws. The information contained in this manual is subject to change without notice. Images provided herein are for reference only and may contain information or features that do not apply to your computer. Acer Group shall not be liable for technical or editorial errors or omissions contained in this manual.

Acer Liquid M220 smartphone

Model number: _____

Serial number: _____

Date of purchase: _____

Place of purchase: _____

TABLE OF CONTENTS

Setting up	4	Messaging	22
Unpacking your smartphone.....	4	Creating a new message	22
Getting to know your smartphone.....	4	Replying to a message	23
Views	4	MMS messages	23
Charging the battery	5	Receiving MMS messages	23
Installing a SIM or microSD card	6	Dictating messages	24
SIM card lock	8	Messaging settings	24
Using your smartphone	9	Emergency messages	24
Turning on for the first time.....	9	Going online	25
Entering your PIN.....	9	Browsing the Internet.....	25
Activating a new SIM card	9	Using the browser.....	25
Using the touchscreen.....	9	Setting up email	26
Locking your smartphone.....	10	Windows Store.....	27
Waking your smartphone	10	Maps and navigation.....	27
Changing the lock screen wallpaper	10	Using the map.....	28
The Start screen	11	Using the camera	29
Rearranging the tiles on the Start screen .	11	Camera icons and settings	29
Pinning items to the Start screen	11	Photo settings	30
Hubs	12	Video settings	31
Viewing currently open applications.....	12	Taking a photo	31
Additional menus	13	Shooting a video	31
Status icons	13	Viewing photos and videos	31
Adjusting the volume	13	Accessories and tips	32
Entering text	14	Using the headset.....	32
Predictive text	14	Sharing your Internet connection	32
People	15	Appendix	34
The people Hub.....	15	FAQ and troubleshooting.....	34
Adding a contact	16	Other sources of help	35
Editing a contact	16	Warnings and precautions	36
Pin a contact to the Start screen.....	16	Medical devices	37
Making calls	17	Vehicles	38
Before making a call	17	Potentially explosive environments.....	38
Making a call.....	17	Emergency calls	39
Making an emergency call	17	Taking care of your smartphone	39
Dialing an international number	18	Specifications.....	41
Dialing a number from your call history.....	18	Performance	41
Saving a dialed number to contacts.....	18	Display	41
Making a call to one of your contacts.....	19	Multimedia	41
Answering or declining a call	19	USB connector.....	41
Ending a call	20	Connectivity	42
The voice call screen.....	20	Camera	42
Using the speakerphone.....	20	Expansion	42
Accessing the onscreen number pad.....	20	Battery	43
Muting a call.....	20	Dimensions.....	43
Putting a call on hold.....	21	End User License Agreement	44
Conference calls	21		
Having a private conversation with one participant	21		

SETTING UP

Unpacking your smartphone

Your new smartphone comes packed in a protective box. Carefully unpack the box and remove the contents. If any of the following items is missing or damaged, contact your dealer immediately:

- Your new Acer smartphone
- USB cable
- AC adapter
- Headset



Note

In-box content varies depending on country and region.

Getting to know your smartphone

Views

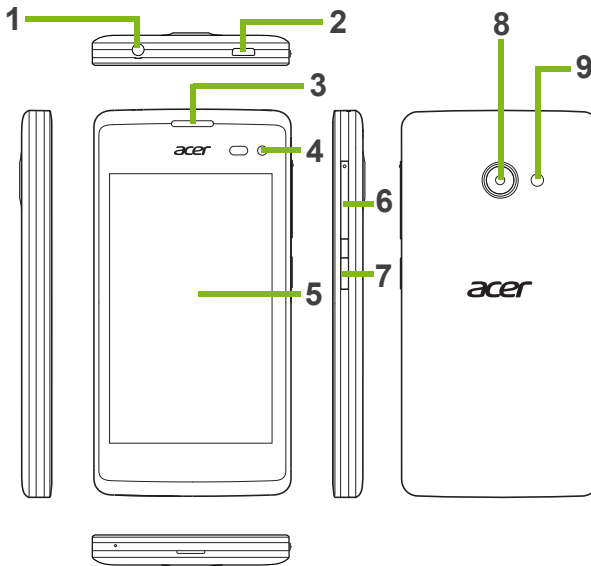

No.	Item	Description
1	3.5 mm headphone jack	Connects to stereo headphones.
2	Micro USB connector	Connects to a USB cable/charger.
3	Smartphone speaker	Emits audio from your smartphone; suitable for holding to your ear.
4	Front-facing camera	Use for self-portrait images and online video chat.
5	Touchscreen	4-inch capacitive touchscreen to display data, smartphone content and enter information.
6	Volume up/down button	Increases or decreases the smartphone volume.
7	Power button	Press to turn the screen on/off or enter sleep mode; press and hold to turn the smartphone on or off.
8	Camera	A camera for taking high-resolution images.
9	Flash	LED flash for camera.

Charging the battery

For initial use, you need to charge your smartphone for eight hours. After that you can recharge the battery as needed.

Connect the AC adapter cord to the micro USB connector on your smartphone.

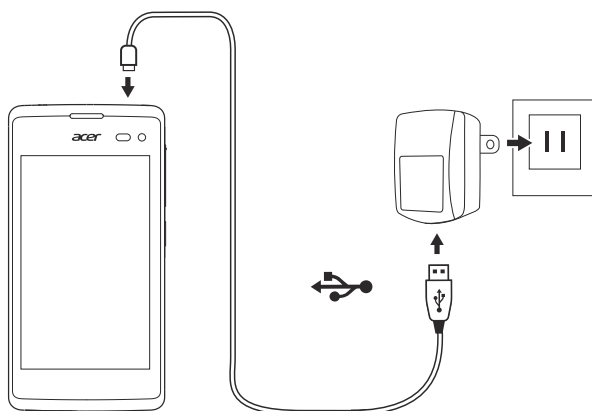

Installing a SIM or microSD card

To take full advantage of your smartphone's telephony capabilities, you must install a SIM card.

Your new smartphone has multiple SIM card holders; install any combination of SIM cards.

Additionally, you may wish to increase your smartphone's storage by inserting a microSD card into the labeled slot.

1. Turn off the smartphone by pressing and holding the power button.
2. Insert your fingernail into the notch located at the bottom of the phone and remove the cover.



3. Insert the SIM or microSD card as shown.

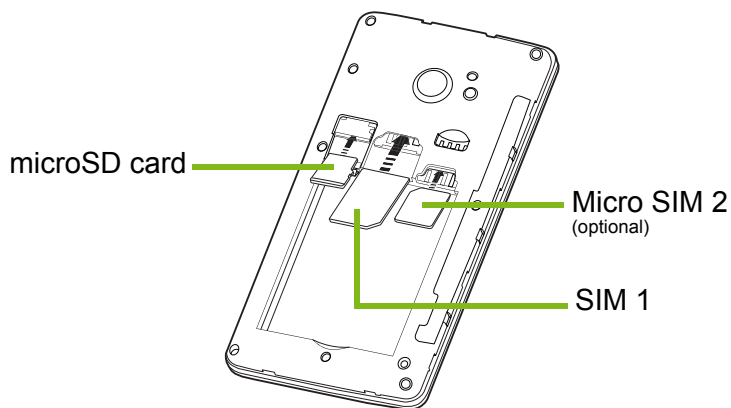

Note: Your smartphone may be equipped with one or two SIM slots depending on model.

4. Align the gold-colored connectors on the battery with the connectors at the top of the battery compartment and insert the battery.

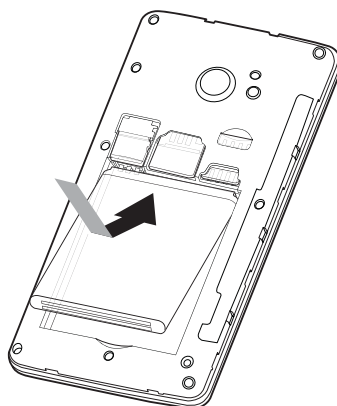

5. Replace the cover by aligning the tabs on the cover into the slots on the smartphone. Gently press the cover until it snaps in place.

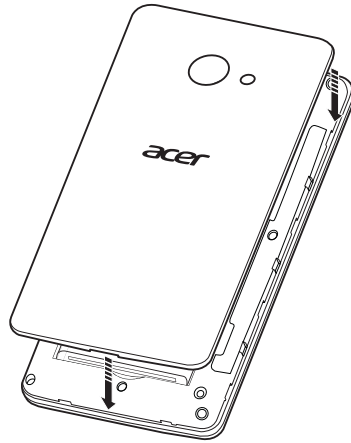

SIM card lock

Your smartphone may come with a SIM card lock, i.e., you will only be able to use the SIM card provided by your network operator.

To cancel the SIM lock, contact your network provider.

USING YOUR SMARTPHONE

Turning on for the first time

To turn on your smartphone for the first time, press and hold the power button until the screen turns on. You will then be asked to configure some settings before you can use your smartphone.

Follow the onscreen instructions to complete setup.



Note

You will be asked for your Windows ID during setup. A Windows ID is necessary to use some features on your smartphone.

Entering your PIN

When you install a SIM card for the first time, you may need to enter a PIN using the onscreen number pad. Depending on your settings, you may also be required to enter your PIN each time you switch on the phone function.

Activating a new SIM card

If you are using your SIM card for the first time, it may require activation. Contact your network provider for details on how to do this.

Using the touchscreen

Your smartphone uses a touchscreen for selecting items and entering information. Use your finger to tap the screen.

Tap: Touch the screen once to open items and select options.

Drag: Hold your finger on the screen and drag across the screen to select text and images.

Tap and hold: Tap and hold an item to see a menu of actions available for that item. On the pop-up menu that appears, tap the action you want to perform.

Scroll: To scroll up or down the screen, simply drag your finger up or down the screen in the direction that you want to scroll.

Locking your smartphone

If you will not use your smartphone for a while, briefly press the power button to lock access. This saves power and ensures your smartphone does not unintentionally use any services. Your smartphone will lock automatically if it is not used for one minute.

Waking your smartphone

If the screen is off and the smartphone does not react to any taps on the screen or front panel button, then it has been locked and is in sleep mode.

Press the power button to wake your smartphone. Swipe the lock screen up to unlock the smartphone.

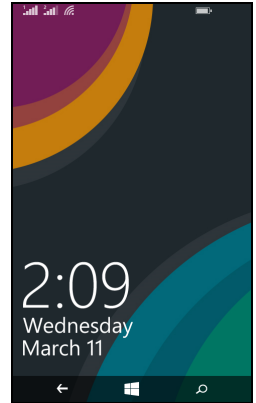

Changing the lock screen wallpaper

You can change your lock screen wallpaper to an image of your choice.

1. Open the applications list and tap **Settings > lock screen > choose background**.
2. Choose the source for your new background: Photo; Bing; or Facebook.
3. If you choose **photo**, you can tap **change photo** to select a photo from your **Camera roll** or preloaded **Backgrounds**.



Note

If the photo is larger than the allowed size, you may be prompted to crop it. Move the area you want to use as your wallpaper in the crop box and tap .

The Start screen

The first screen you see after starting up the smartphone is the Start screen. This screen displays a selection of information in *live tiles* which update in real time. Tap a tile to open the corresponding application or Hub (please see [see Hubs on page 12](#) for more information).

Tiles show you things like how many new messages you have, missed calls, your photo album, and XBOX LIVE.



Note

There may be more tiles at the top or bottom of the screen, swipe your finger up or down the screen to display them.

Swipe your finger to the left to view the full menu of applications and settings available on your smartphone.

Rearranging the tiles on the Start screen

1. Press and hold a tile until it floats.
2. Drag the tile to where you want to move it; tap the tile to dock it.



Note

Pause at the top or bottom of the screen to move the tile to the extended Start screen.

Pinning items to the Start screen

You can pin items to the Start screen, applications, files or contacts. You will see any updates for contacts pinned to the Start screen.

Tap and hold the item to open a menu and tap **pin to start**.

Unpinning a tile

Tap and hold the tile you want to unpin, then tap the unpin icon.

Hubs

You can arrange items into *Hubs* to simplify everyday tasks. There are some pre-defined Hubs that group items with similar themes together, such as the *People* Hub. In this Hub, you can view your contacts, social networking updates.

Other pre-defined Hubs include:

- Office
- Pictures
- Music + Videos

Viewing currently open applications

Tap and hold the Back button to display thumbnails of applications that are currently open.

Tap an icon to jump to the open application.

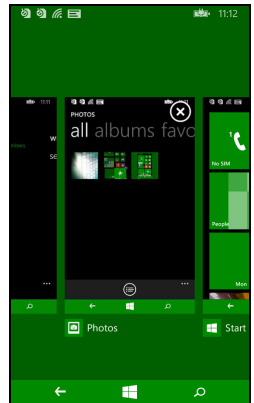

Additional menus

Many applications have further menus that are accessible by swiping upwards when the '...' icon is visible at the bottom of the screen.

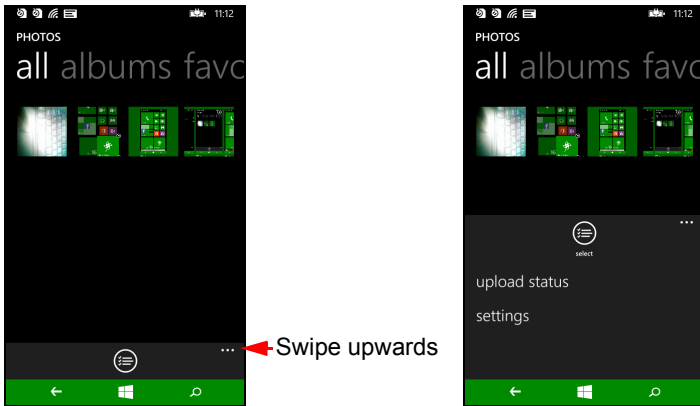

Status icons

The icons visible in the status bar give you a quick overview of your smartphone's status. To view the status bar, tap the top of the screen. The status bar disappears after a few seconds.



Adjusting the volume

Use the Volume up or Volume down buttons on the side of the smartphone to adjust the volume. The volume bar appears at the top of the screen to indicate the set level. Swipe the volume bar downwards to adjust other related settings.



Note

Tap the icon to the right of the volume bar to quickly change to ring or vibrate. If you wish to have silent as an option, you need to turn vibrate off.

Entering text

There is a standard onscreen QWERTY keyboard that allows you to enter text. Tap and hold a key to select alternative characters, such as letters with accents.

Tap the **&123** button to see numbers and special characters.

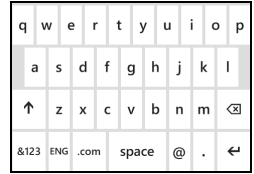

You can switch between multiple input languages by tapping the **ENG** key. The keyboard layout will change accordingly. To select your preferred languages, tap **Settings** > **keyboard** and select your preferred alternate languages.



Note

*The keyboard layout will change according to the text box type selected.
The language selection key will change according to the language selected.*

To type in ALL CAPS, tap and hold the  key.

To type special characters, such as æ or ê, tap and hold the letter to open a list of available special characters.

Predictive text

Windows Phone provides predictive text input. As you tap the letters of a word, a selection of words are displayed above the keyboard that continue the sequence of letters tapped, or are a close match allowing for errors. The word list changes after every key press. If the word you need is displayed, you can tap on it to insert it into your text.



PEOPLE

The *people* Hub

Once you have set up an email or Facebook account on your smartphone (please [see Setting up email on page 26](#)) any contacts stored for that account will be imported to your smartphone.

Your friends' Windows Live and Facebook feeds will appear in the *People* Hub, their photos appear in your *Pictures* Hub and your own feeds in the *Me* tile.

When you tap a contact's name, their *profile* page opens, displaying contact details. You can call, send a text message, or send an email to the contact.

Slide the *profile* page to the left to see *what's new* with the contact, provided you're signed in to your Windows Live and/or Facebook account(s), and the contact is also your friend in Windows Live and/or Facebook.

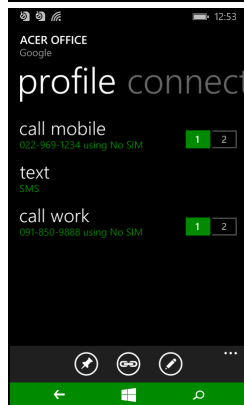
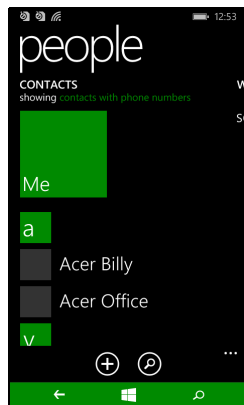

Adding a contact

Open the *people* Hub to the *all* page.

Tap \oplus then select an account for the new contact:

- Phone
- <Email account>

Enter the information for the contact by tapping \oplus next to each field.

You will need to tap Ⓜ when you are finished entering information for each category, and then again when you have finished entering the contact's information.

To assign an image to your contact, tap **add photo** and select an image from your *albums*, alternatively tap the camera icon and take a photo of the contact.

You may also create a contact from an already dialed or received number, [see Saving a dialed number to contacts on page 18](#).

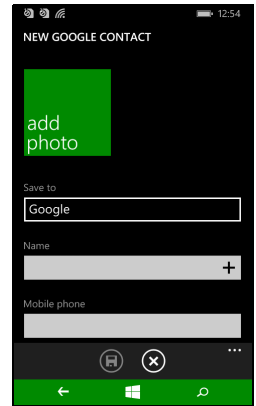

Editing a contact

To edit a contact, open the contact's *profile* page and tap ✎ . This will allow you to make changes to the contact's information.

Linking contacts

You may find that there are multiple entries for a single contact, for example an entry from your Windows Live contact list, one from Facebook, and one from Gmail. You can link multiple entries so that you can view all the entries on one *profile* page. Tap ⊖ at the bottom of one of the *profile* pages, then search for the contact's other entries.

Pin a contact to the Start screen

If you often call or message one or more contacts, you can pin them to the Start screen. Open the contact's *profile* page and tap 📌 .

MAKING CALLS

This chapter shows you how to make phone calls, and the various options available to you during your call.

Before making a call

Check that the phone function is on before you make a call. You can confirm the phone status from the status bar.



Note

*Most SIM cards come with a pre-set PIN from the provider. If you are asked to enter a PIN, enter it and tap **OK**.*

Making a call

1. Tap the **Phone** tile on the Start screen.
2. Tap  to open the onscreen number pad and enter the number you wish to dial.
3. Tap **call**.
4. To end the call, tap **End**.

Making an emergency call

You can make emergency calls, even if your smartphone does not have a SIM installed, or if the SIM has been blocked.

1. Turn on the phone and tap **emergency call** on the screen.
2. Enter the emergency number for your area.



Important

If you have enabled the phone lock and/or SIM lock, and you have forgotten the unlock code or SIM PIN, you can still make emergency calls by tapping emergency call.

**Note**

GSM carriers all recognize 112 as an emergency number. This will usually connect you to an operator who will be able to connect you to the emergency services in your area. In North America, dialling 112 will redirect you to 911. SIM cards may come with other emergency numbers, contact your network provider for details.

Dialing an international number

When dialing international numbers, there is no need to enter the international direct dialing prefix ('00' etc.) before the country code. Simply tap and hold **0+** on the onscreen number pad until **+** appears onscreen.

**Important**

International call rates can vary greatly depending on the country you are calling and your network provider. We suggest you check all call rates with your network provider, to avoid excessive phone bills. If you are using your smartphone abroad, roaming charges will apply. Consult your network provider for roaming rates specific to the country you are visiting before you leave.

Dialing a number from your call history

Your call history can be viewed by tapping the **Phone** tile. It displays recent received, dialed, and missed calls.

Tap the symbol next to the number to open the number's *profile* then tap **call number** or tap **text** to SMS the number.

Saving a dialed number to contacts

You can save a number you have dialed to your contacts for future use.

1. Tap the **Phone** tile to open your call *history*, then tap the number you want to save.
2. Tap  at the bottom of the screen. You will be asked to *Choose a contact* to associate the number with, or you can create a new contact by tapping the + at the bottom of the screen.

3. Enter the contact information and tap .

Making a call to one of your contacts

You can make a call to one of your contacts by tapping either the **Phone** tile, or the **People** tile.

- From the **Phone** tile, tap  at the bottom of the page to open your list of contacts.
- In the **People** Hub your contacts will be visible.
 1. Tap the contact you want to call to open their contact card.
 2. Tap the number you wish to use to call them.

Answering or declining a call

When you have an incoming call, the number will be shown on the screen. If the call is coming from a contact, the contact name and photo (if available) will be shown.

To **answer** or **ignore** the call, tap the appropriate button.

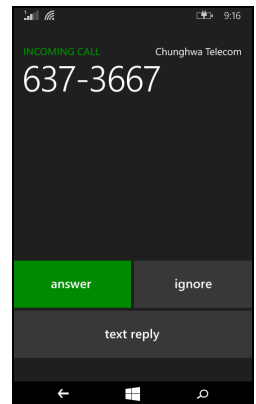

Note

If the smartphone is locked, you will need to swipe the lock screen up before you can answer or ignore the call.

Muting the ringer

If you wish to mute the ringer without ignoring the call:

- Press the volume up or down button.
- Press the power button.

Ending a call

To end a call, press **End call** from the voice call screen.

The voice call screen

Once you have dialed your number the voice call screen appears, which displays the number/contact you are talking to, the call duration and tiles to open the onscreen number pad, put the call on hold, route audio to the speaker, mute the call or add another call (please refer to [Conference calls on page 21](#)).

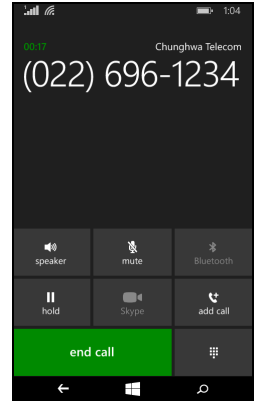

Using the speakerphone

The speakerphone function allows you to make calls without having to hold your smartphone. This handsfree function is especially useful for multitasking.

To activate the speakerphone, tap **speaker**. Tap **speaker** again to disable the speakerphone.

Accessing the onscreen number pad

- To access the onscreen number pad while in a call, tap ☰.
- Tap ☰ to close the onscreen number pad.

Muting a call

To mute a call, tap **mute** on the voice call screen to switch off the microphone (the button background changes color to your selected accent color to indicate that *mute* is active). Tap **mute** again to switch the microphone back on.

Putting a call on hold

To put a call on hold, tap **hold**. To return to the call, tap **hold** again.

Conference calls

If you have one call on hold and another online, you can combine both calls to create a conference call.

After the first call is established, tap **Add call** to dial the second number. When both calls are connected, tap **Merge calls** to start the conference call.



Note

You may need to have conference calls activated on your SIM card. Contact your network provider for details.

Having a private conversation with one participant

During a conference call, you can have a private conversation with one person on the call. The other people can't hear you until you merge everyone back onto the conference call.

1. During a conference call, tap **Private**.
2. Tap the person's name or phone number to have a private conversation with them. Their name or phone number appears near the top of the screen. The other people on the conference call won't be able to hear your conversation.
3. Tap **Merge calls** to merge the other people back and continue the conference call.
4. Tap **End call** to end the conference call and hang up.

MESSAGING

This chapter shows you how to set up and use the messaging functions of your smartphone.

All SMS and MMS messages are accessed via **Messaging**. Messaging automatically arranges received and sent messages into conversations by contact name or phone number.

To access Messaging tap the **Messaging** tile on the Start screen.

Creating a new message

You can use your smartphone to compose SMS and MMS messages.

Tap  to compose a new message.

Enter one or more recipients. Use a semicolon to separate recipients:

- Enter the phone number directly.
- Enter a contact's name. As you enter letters, your smartphone will suggest contacts.
- Tap  on the right of the recipient field to open your contact list and tap a contact to send the message to.

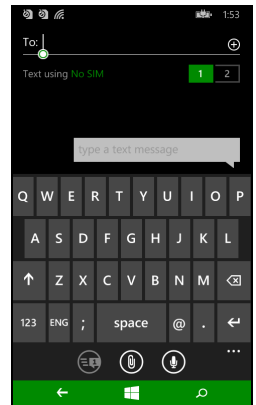

Once you have entered the recipient, enter your message in the text box labeled **type a message**.

Tap  to open your *albums* so that you can attach a picture and convert the message to an MMS message.

- Tap the *camera* icon to open the camera and take a photo.

Tap  to send the message.



Note

SMS messages may be up to 160 characters long. If your message is longer than 160 characters, it will be sent as multiple linked messages. Most phones will automatically join the linked messages to present the recipient with a single long message, however, some older phones do not have this ability.

Replying to a message

When a new text message arrives the smartphone will play a sound. A summary of the message and sender information will appear briefly in the Status bar.

Tap **Messaging** on the Start screen to open the message list.

To reply to an SMS or MMS message, open the message from the message list and enter your text in the text box labeled **type a text message**.

MMS messages

MMS messages are similar to text messages but also allow you to attach multimedia files such as pictures, audio or video clips. Each MMS message can be up to 300 kB in size.



Note

Your smartphone can receive MMS messages with picture, video or audio attachments, however, you can only attach a picture to an MMS message when sending.

You need to set up an MMS profile before you can send MMS messages. Normally, your smartphone will set up the profile for you based on information retrieved from your provider.

Receiving MMS messages

When a new MMS message arrives, a message icon appears at the top of the screen and a notification message is displayed.

1. Open Messaging to view a summary of the message.
2. Tap **Download** to download the message content.





Important

You may be charged to download message content, especially if you are roaming. Please contact your provider if you have any questions.





Note

Downloads can take a long time, depending on your connection quality. If you reply or open another application, the download will be stopped.

3. Tap the message to view the content.
4. To reply to the message, enter your text in the text box labeled **type a text message** and tap . Plain text replies will be sent as SMS messages. If you wish to attach a file, tap  to attach a file as described in **Creating a new message on page 22**.

Dictating messages

Your smartphone allows you to dictate message content.

1. Enter the recipient(s) as described in **Creating a new message on page 22**.
2. Tap  and speak your message. The smartphone will use voice recognition technology to convert your spoken words to text.
3. Review the text and tap  to send the message.



Note

Voice recognition technology is affected by accents and personal speech patterns. It is important to review the text closely before sending the message to avoid misunderstandings and embarrassment.

Messaging settings

You can adjust some settings for *Messaging*. Tap the **Messaging** tile and then swipe the the '...' icon upwards; tap **Settings**.

Here you can enable or disable *SMS delivery confirmation* or *Group text* by tapping the appropriate slider.

Group text

This automatically groups text messages by sender.

Emergency messages

You can enable or disable receiving emergency messages, also known as *Amber alerts*. The default setting is to receive **all alerts**.

GOING ONLINE

Browsing the Internet

In order to browse the Internet with your smartphone, you must be connected to a data or wireless network.

Using the browser

Tap the **Internet Explorer** tile on the Start screen to start browsing. To open a new website, tap the address box at the bottom of the page. Enter the address using the keyboard and tap → .

To view your browsing history, bookmarks or frequently visited sites, swipe up the menu using the the '...' icon alongside the address box.

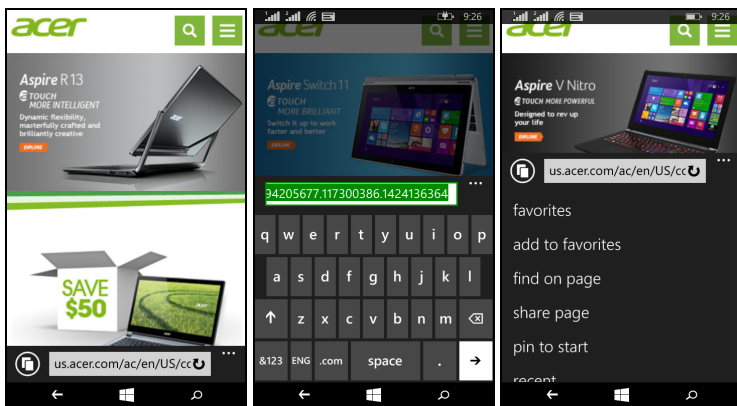

You may open multiple pages. When a page is open, tap the icon that is on the left of the address box. This will display thumbnails of all the open tabs. Tap ⊕ to open a new tab.

You can zoom in or out of pages using a pinch action.

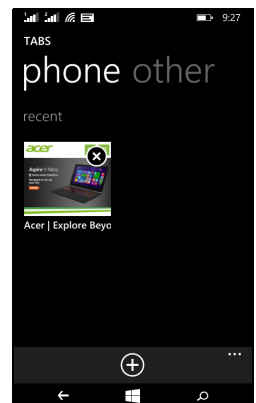

Tap and hold an item on a page to open a context menu that lists the available options for that item.

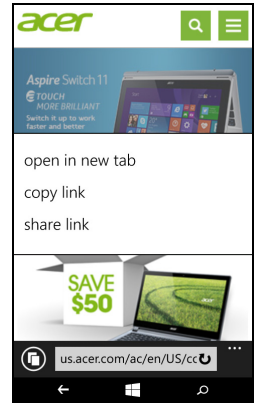

Setting up email

Your smartphone enables you to access your email. Most popular ISPs can be set up in a few easy steps. Tap **Email** on the Start screen to start.

Select your email service provider and tap **sign in**. Enter your email address and password. If your email provider is not in the list, tap **advanced setup**, and enter your email address , password, and other required information. Tap **Next** to finish the setup process.



Windows Store



Note

Windows Store may not be available in all countries and regions. You need to have a Windows ID set up and active on your smartphone before you can use Windows Store. You will be prompted to set up or sign into your account(s) the first time you use Windows Store.

Tap the *Store* tile on the Start screen to begin. Here you can obtain a variety of add-on programs and applications to enhance the functionality of your smartphone.

You can browse by category or tap the search icon to search for a specific application.

Once you have selected an application, tap the **Try**, **Buy** or **Install** button to download and install the application.

Maps and navigation



Note

Maps does not have information about every location.

You can obtain easy-to-follow directions using Bing Maps, view real-time traffic conditions and navigate by using spoken, turn-by-turn driving instructions with Navigation, view where your friends are and places of interest and local businesses.

Tap **Maps** from the applications list.

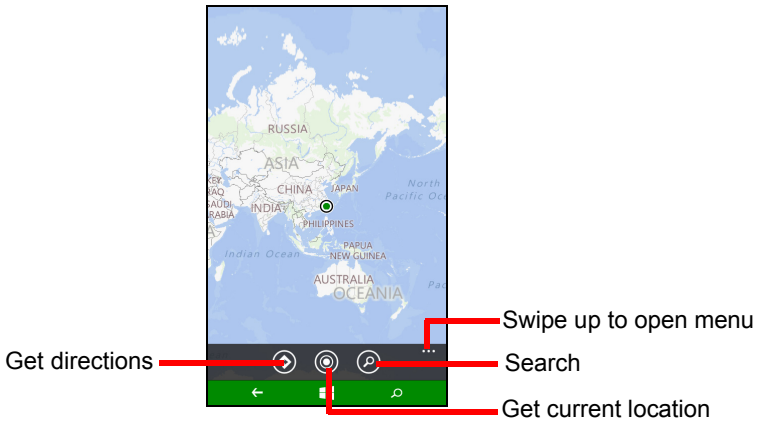

Using the map

Tap the Maps icon in the applications list. Drag the map with your finger to move the map around.

You can zoom in or out using a pinch action, or double tap a location on the map to zoom in on the location.



Note

Not all zoom levels are available for all locations.

USING THE CAMERA

Your smartphone features two digital cameras, one mounted on the rear, the other on the front. This section will take you through all the steps in taking photos and videos with your smartphone.

To activate the camera open the applications list and tap **Camera**.

Camera icons and settings

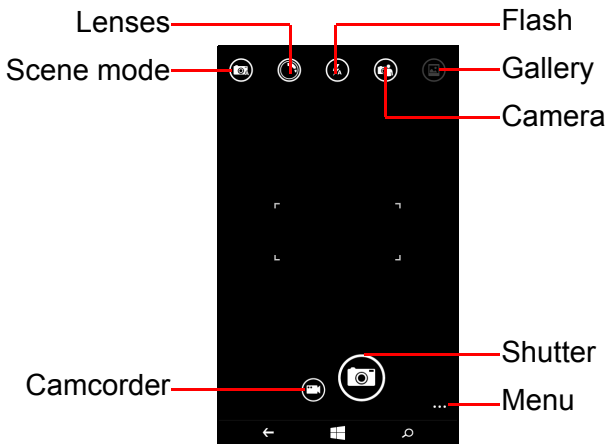

In the camera window, the icons across the top of the screen allow you to select a scene mode, apply effects through *Lens* apps, turn the flash on or off, switch between the front and rear cameras, and open the gallery to see the photos you have taken.

The icons at the bottom of the screen allow you to take a picture, change to the camcorder function and open a menu of options.

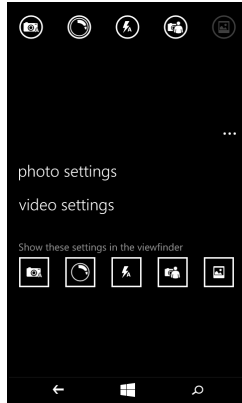

Once you have a photo open in the gallery, a menu appears at the bottom of the screen that provides options to:

- **share...** the image via *Facebook*, *Messaging* or *OneNote*.
- edit the photo.
- delete the photo.
- add the photo to your favorites.

Photo settings

Tap the *settings* icon in the lower right-hand corner of the screen to open the photo settings menu. Here you can adjust settings to suit your needs.

- **Flash:** Turn the flash on or off.
- **Tap to take photo:** Turn the feature on or off. If the feature is *On* you can tap anywhere on the screen to immediately take the photo. If the feature is off, tap anywhere on the screen to focus on that part of the scene; you will need to tap the *Shutter* icon to take the photo.
- **Resolution:** Set the resolution for photos you take.
- **Scene mode:** Change settings to ensure the camera takes the best photo for the current scene.
- **ISO:** Set the ISO level.

- **Exposure compensation:** Choose if you want the camera to be under- or over-exposed.
- **White balance:** Adjust the white balance to get the best color reproduction for different light environments.
- **Effect:** Apply an effect to change the photo.

Video settings

Tap the *settings* icon in the lower right-hand corner of the screen to open the video settings menu. Here you can adjust settings to suit your needs.

- **Video light:** Turn the LED light on or off while shooting a video.
- **Resolution:** Set the resolution for videos you shoot.

Taking a photo

1. Ensure you have adjusted the parameters described above.
2. Frame your subject and steady your smartphone.
3. Tap the *Shutter* icon to take the photo.

Shooting a video

Turn on camcorder mode by tapping the *Camcorder* icon.

1. Ensure you have adjusted the parameters described above.
2. Frame your subject and steady your smartphone.
3. Tap the *Record* icon to begin recording.

Viewing photos and videos

After you have taken your photo or video, it is automatically saved.

Once you have taken a photo or video, you can view it by tapping the **Photo** tile on the Start screen. Scroll through the collections to find the item you wish to view. Tap the thumbnail to view the file.

ACCESSORIES AND TIPS

This chapter shows you how to use accessories with your smartphone, as well as provide useful tips for when you are using your smartphone.

Using the headset

Your smartphone comes packaged with a headset with built-in microphone for handsfree use when making calls.

To use the headset, plug it into the smartphone's 3.5 mm headphone jack.

When the headset is plugged in, all audio is routed to the headset, and the speakers are turned off.

- To answer an incoming call, press the button on the microphone.
- Adjust the volume using the volume up/down keys on the smartphone.
- End the call by pressing the button on the microphone again.

You may also use a Bluetooth headset to make and receive calls.

Sharing your Internet connection

Your smartphone supports Internet connection sharing with up to five clients or computers. You can set the connection name and an optional password for security (using WPA2).

Tap **Settings** > **internet sharing**, then tap the slider next to **Sharing**.



You will be shown the password and access point name for the smartphone (the AP SSID that other devices will use for connecting).



Note

Internet sharing and Wi-Fi are mutually exclusive. If you have a Wi-Fi connection enabled, and turn on Internet sharing, the Wi-Fi connection will be terminated.



Important

Some providers and countries do not allow the use of a smartphone as a modem over cellular networks. Please check with your provider before trying to do so.

APPENDIX

FAQ and troubleshooting

This section lists frequently asked questions that may arise during the use of your smartphone, and gives easy answers and solutions to these questions.

Aspect	Question	Suggestions
Audio	Why is there no sound coming from the device?	If the headset is plugged into the device, the speaker is automatically shut off. Disconnect the headset. Check that the device volume setting is not muted. Check that the volume control is not at its lowest setting.
Multimedia files	Why can't I view my picture files?	You may be trying to view an image that is not supported. See Multimedia on page 41.
	Why can't I view my video files?	You may be trying to view a video that is not supported. See Multimedia on page 41.
	Why can't I play my music files?	You may be trying to play a file that is not supported. See Multimedia on page 41.
System information and performance	How do I check the OS version of my device?	Tap Settings > Device information to check the OS version (Build number) and other hardware and software information.
Power	I can't turn on the device.	The battery power may be depleted. Recharge the device. See Charging the battery on page 5 for more information.

Aspect	Question	Suggestions
Internal storage	My device's available internal storage is full or almost full.	Uninstall apps to increase available storage.
Heat	The smartphone heats up when charging or making long duration calls.	It is normal for the smartphone to heat up when charging. When charging is complete, it will return to its normal temperature. It is also normal for the smartphone to heat up during long periods of use, such as watching a video or a long smartphone conversation.

Other sources of help

For information on	Refer to ...
Up-to-date information regarding your smartphone	www.acer.com mobile.acer.com
Service enquiries	www.acer.com/support

WARNINGS AND PRECAUTIONS

- Do not use this product near water.
- Do not place this product on an unstable cart, stand or table. If the product falls, it could be seriously damaged.
- Slots and openings are provided for ventilation to ensure reliable operation of the product and to protect it from overheating. These openings must not be blocked or covered. The openings should never be blocked by placing the product on a bed, sofa, rug or other similar surface. This product should never be placed near or over a radiator or heat register, or in a built-in installation unless proper ventilation is provided.
- Never push objects of any kind into this product through cabinet slots as they may touch dangerous voltage points or short-out parts that could result in a fire or electric shock. Never spill liquid of any kind onto or into the product.
- To avoid damage of internal components and to prevent battery leakage, do not place the product on a vibrating surface.
- Never use this product when engaging in sporting activities, exercising, or in any vibrating environment which may cause a short circuit or damage, and even a risk of explosion from the battery pack.

Protecting your hearing

To protect your hearing, follow these instructions.

- Increase the volume gradually until you can hear clearly and comfortably.
- Do not increase the volume level after your ears have adjusted.
- Do not listen to music at high volumes for extended periods.
- Do not increase the volume to block out noisy surroundings.
- Decrease the volume if you can't hear people speaking near you.

Additional safety information

Your device and its enhancements may contain small parts. Keep them out of the reach of small children.

Operating environment



Important

For safety reasons, turn off all wireless or radio transmitting devices when using your smartphone device under the following conditions. These devices may include, but are not limited to: wireless LAN (WLAN), Bluetooth and/or cellular services.

Remember to follow any special regulations in force in any area, and always switch off your device when its use is prohibited or when it may cause interference or danger. Use the device only in its normal operating positions. To successfully transmit data files or messages, this device requires a good quality connection to the network. In some cases, transmission of data files or messages may be delayed until such a connection is available. Ensure that the above separation distance instructions are followed until the transmission is completed. Parts of the device are magnetic. Metallic materials may be attracted to the device, and persons with hearing aids should not hold the device to the ear with the hearing aid. Do not place credit cards or other magnetic storage media near the device, because information stored on them may be erased.

Medical devices

Operation of any radio transmitting equipment, including wireless smartphones, may interfere with the functionality of inadequately protected medical devices. Consult a physician or the manufacturer of the medical device to determine if they are adequately shielded from external RF energy or if you have any questions. Switch off your device in health care facilities when any regulations posted in these areas instruct you to do so. Hospitals or health care facilities may be using equipment that could be sensitive to external RF transmissions.

Pacemakers. Pacemaker manufacturers recommend that a minimum separation of 15.3 cm (6") be maintained between wireless devices and a pacemaker to avoid potential interference with the pacemaker. These recommendations are consistent with the independent research by and recommendations of Wireless Technology Research. Persons with pacemakers should do the following:

- Always keep the device more than 15.3 cm (6") from the pacemaker.

- Not carry the device near your pacemaker when the device is switched on. If you suspect interference, switch off your device, and move it.

Hearing aids. Some digital wireless devices may interfere with some hearing aids. If interference occurs, consult your service provider.

Vehicles

RF signals may affect improperly installed or inadequately shielded electronic systems in motor vehicles such as electronic fuel injection systems, electronic anti-skid (anti-lock) braking systems, electronic speed control systems, and air bag systems. For more information, check with the manufacturer, or its representative, of your vehicle or any equipment that has been added. Only qualified personnel should service the device, or install the device in a vehicle. Faulty installation or service may be dangerous and may invalidate any warranty that may apply to the device. Check regularly that all wireless equipment in your vehicle is mounted and operating properly. Do not store or carry flammable liquids, gases, or explosive materials in the same compartment as the device, its parts, or enhancements. For vehicles equipped with an air bag, remember that air bags inflate with great force. Do not place objects, including installed or portable wireless equipment in the area over the air bag or in the air bag deployment area. If in-vehicle wireless equipment is improperly installed, and the air bag inflates, serious injury could result. Using your device while flying in aircraft is prohibited. Switch off your device before boarding an aircraft. The use of wireless teledevices in an aircraft may be dangerous to the operation of the aircraft, disrupt the wireless telephone network, and may be illegal.

Potentially explosive environments

Switch off your device when in any area with a potentially explosive atmosphere and obey all signs and instructions. Potentially explosive atmospheres include areas where you would normally be advised to turn off your vehicle engine. Sparks in such areas could cause an explosion or fire resulting in bodily injury or even death. Switch off the device at refueling points such as near gas pumps at service stations. Observe restrictions on the use of radio equipment in fuel depots,

storage, and distribution areas; chemical plants; or where blasting operations are in progress. Areas with a potentially explosive atmospheres are often, but not always, clearly marked. They include below deck on boats, chemical transfer or storage facilities, vehicles using liquefied petroleum gas (such as propane or butane), and areas where the air contains chemicals or particles such as grain, dust or metal powders.

Follow any restrictions. Do not use the device where blasting is in progress.

Emergency calls



Important

Wireless smartphones, including this device, operate using radio signals, wireless networks, landline networks, and user-programmed functions. Because of this, connections in all conditions cannot be guaranteed. You should never rely solely on any wireless device for essential communications like medical emergencies.

If certain features are in use, you may first need to turn those features off before you can make an emergency call. Consult this guide or your service provider for more information.

When making an emergency call, give all the necessary information as accurately as possible. Your wireless device may be the only means of communication at the scene of an accident. Do not end the call until given permission to do so.

Taking care of your smartphone

1. **DO** take care not to scratch the screen of your smartphone. Keep the screen clean. When working with your smartphone, use your finger or fingernail. Never use an actual pen or pencil or other sharp object on the screen surface.
2. **DO NOT** expose your smartphone to rain or moisture. Do not let water enter the circuitry through the front panel buttons or expansion slots. In general, treat your smartphone as you would a mobile phone or other small electronic device.

3. **DO** be careful not to drop your smartphone or subject it to any strong impact. Do not place your smartphone in your back pocket.
4. **DO NOT** expose your smartphone to extreme temperatures. For example, do not leave your smartphone on the dashboard of a car on a hot day or when temperatures are below freezing point. Also, keep it away from heaters and other sources of heat.
5. **DO NOT** use or store your smartphone in any location that is dusty, damp or wet.
6. **DO** use a soft, damp cloth to clean your smartphone. If the surface of the screen becomes soiled, clean it with a soft cloth moistened with diluted window-cleaning solution.
7. **DO NOT** press down on the screen with force, otherwise you may crack the screen.

Specifications



Note

Specifications may vary depending on region and configuration.

Performance

- 1.2 GHz dual-core processor
- System memory:
 - 512 MB or 1 GB of RAM (depending on model)
 - 4 GB or 8 GB of ROM (depending on model)
- Windows 8.1 operating system*

* For updated operating system information, please refer to www.acer.com.

Display

- 4" TFT LCD, capacitive touchscreen
- 800 x 480 resolution

Multimedia

Formats supported:

Type	Formats
Image	JPEG, GIF, PNG, BMP
Audio playback	MP3, AMR, AAC LC, AAC+, eAAC+, Vorbis, FLAC, MIDI, WAVE
Ringtone	MP3, AMR, AAC LC, AAC+, eAAC+, Vorbis, FLAC, MIDI, WAVE
Video recording	H.263, H.264, MPEG4
Video playback	H.263, H.264, MPEG4, VP8

USB connector

- Micro USB connector

- USB client
- DC power-in (5 V, 0.5 A)

Connectivity

- Bluetooth 4.0
- IEEE 802.11b/g/n
- GSM 850 / 900 / 1800 / 1900 MHz
- HSPA / WCDMA*
 - SKU 1: 900 MHz (B8) / 2100 MHz (B1)
 - SKU 2: 850 MHz (B5) / 1900 MHz (B2)
 - SKU 3: 850 MHz (B5) / 1700 MHz (B4 - AWS)
- HSPA+ / GPRS / EDGE
- GPS

* Frequencies depend on model.

Camera

- 5 MP rear camera
 - Auto-focus
 - LED flash
- 2 MP front camera
 - Fixed focus

Expansion

- microSD memory card slot (up to 32 GB)

Battery

- 1300 mAh Lithium-ion battery (user-replaceable)



Note

Length of battery operation will depend on power consumption which is based on system resource use. For example, constantly using the backlight or using power-demanding apps will shorten battery life between charges.

Dimensions

Height	124.9 mm
Width	64.6 mm
Thickness	9.57 mm
Weight	120 g (with battery)

END USER LICENSE AGREEMENT

IMPORTANT-READ CAREFULLY: THIS END USER LICENSE AGREEMENT ("AGREEMENT") IS A LEGAL AGREEMENT BETWEEN YOU (EITHER AN INDIVIDUAL OR A SINGLE ENTITY), AND ACER INC. INCLUDING ITS SUBSIDIARIES ("ACER") FOR THE SOFTWARE (WHETHER PROVIDED BY ACER OR BY ACER'S LICENSORS OR SUPPLIERS) THAT ACCOMPANIES THIS AGREEMENT, INCLUDING ANY ASSOCIATED MEDIA, PRINTED MATERIALS AND RELATED USER ELECTRONIC DOCUMENTATION WHICH MAY BE BRANDED "ACER" ("SOFTWARE"). AGREEMENTS RELATING TO ANY OTHER PRODUCT OR TOPIC ARE NEITHER INTENDED NOR SHOULD THEY BE IMPLIED. BY INSTALLING THE ACCOMPANYING SOFTWARE OR ANY PORTION THEREOF, YOU AGREE TO BE BOUND BY THE TERMS AND CONDITIONS OF THIS AGREEMENT. IF YOU DO NOT AGREE TO ALL OF THE TERMS AND CONDITIONS OF THIS AGREEMENT, DO NOT CONTINUE THE INSTALLATION PROCESS AND IMMEDIATELY DELETE ALL INSTALLED FILES, IF ANY, OF THE ACCOMPANYING SOFTWARE FROM YOUR SMARTPHONE.

IF YOU DO NOT HAVE A VALIDLY-LICENSED COPY OF THE APPLICABLE SOFTWARE, YOU ARE NOT AUTHORIZED TO INSTALL, COPY OR OTHERWISE USE THE SOFTWARE, AND HAVE NO RIGHTS UNDER THIS AGREEMENT.

The Software is protected by U.S. and international copyright laws and conventions as well as other intellectual property laws and treaties. The Software is licensed, not sold.

GRANT OF LICENSE

Acer grants to you the following non-exclusive and non-transferable rights with respect to the Software. Under this Agreement, you may:

1. Install and use the Software only on a single designated smartphone. A separate license is required for each smartphone on which the Software will be used;
2. Make one copy of the Software solely for backup or archival purposes;
3. Make one hardcopy of any electronic documents included in the Software, provided that you receive the documents electronically.

RESTRICTIONS

You may NOT:

1. Use or copy the Software except as provided in this Agreement;
2. Rent or lease the Software to any third party;
3. Modify, adapt, or translate the Software in whole or in part;
4. Reverse engineer, decompile, or disassemble the Software or create derivative works based upon the Software;
5. Merge the Software with any other program or modify the Software, except for your personal use; and
6. Sublicense or otherwise make the Software available to third parties, except that you may, after prior written notification to Acer, transfer the Software as a whole to a third party so long as you do not retain any copies of the Software and such third party accepts the terms of this Agreement.
7. Transfer your rights under this Agreement to any third parties.
8. Export the Software in contravention of applicable export laws and regulations, or (i) sell, export, re-export, transfer, divert, disclose technical data, or dispose of, any Software to any prohibited person, entity, or destination including, without limitation, Cuba, Iran, North Korea,

Sudan and Syria; or (ii) use any Software for any use prohibited by the laws or regulations of the United States.

SUPPORT SERVICES

Acer is not obligated to provide technical or other support for the Software.

ACER LIVE UPDATE

Certain of the software contains elements that enable the use of the Acer Live Update service, which allows for updates for such software to be automatically downloaded and installed on your smartphone. By installing the software, you hereby agree and consent that Acer (or its licensors) may automatically check the version of such software that you are using on your smartphone and may provide upgrades to such software that may be automatically downloaded on to your smartphone.

OWNERSHIP AND COPYRIGHT

Title, ownership rights and intellectual property rights in and to the Software and all copies thereof shall remain with Acer or Acer's licensors or suppliers (as applicable). You do not have or shall not gain any proprietary interest in the Software (including any modifications or copies made by or for you) or any related intellectual property rights. Title and related rights in the content accessed through the Software is the property of the applicable content owner and may be protected by applicable law. This license gives you no rights to such contents. You hereby agree

1. Not to remove any copyright or other proprietary notices from the Software;
2. To reproduce all such notices on any authorized copies you make; and
3. To use best efforts to prevent any unauthorized copying of the Software.

TRADEMARKS

This Agreement does not grant to you any rights in connection with any trademarks or service marks of Acer or of Acer's licensors or suppliers.

DISCLAIMER OF WARRANTIES

TO THE MAXIMUM EXTENT PERMITTED BY APPLICABLE LAW, ACER, ITS SUPPLIERS, AND ITS LICENSORS, PROVIDE THE SOFTWARE "AS IS" AND WITH ALL FAULTS, AND HEREBY DISCLAIM ALL OTHER WARRANTIES AND CONDITIONS, EITHER EXPRESS, IMPLIED OR STATUTORY, INCLUDING, BUT NOT LIMITED TO, ANY IMPLIED WARRANTIES, DUTIES OR CONDITIONS OF MERCHANTABILITY, OF FITNESS FOR A PARTICULAR PURPOSE, OF ACCURACY OR COMPLETENESS OF RESPONSES, OF RESULTS, OF WORKMANLIKE EFFORT, OF LACK OF VIRUSES, AND OF LACK OF NEGLIGENCE, ALL WITH REGARD TO THE SOFTWARE AND THE PROVISION OF OR FAILURE TO PROVIDE SUPPORT SERVICES. ALSO, THERE IS NO WARRANTY OR CONDITION OF TITLE, QUIET ENJOYMENT, QUIET POSSESSION, CORRESPONDENCE TO DESCRIPTION OR NON-INFRINGEMENT WITH REGARD TO THE SOFTWARE.

EXCLUSION OF INCIDENTAL, CONSEQUENTIAL AND CERTAIN OTHER DAMAGES

TO THE MAXIMUM EXTENT PERMITTED BY APPLICABLE LAW, IN NO EVENT SHALL ACER, ACER'S SUPPLIERS, OR ACER'S LICENSORS, BE LIABLE FOR ANY SPECIAL, INCIDENTAL, INDIRECT, PUNITIVE, OR CONSEQUENTIAL DAMAGES WHATSOEVER (INCLUDING, BUT NOT LIMITED TO, DAMAGES FOR LOSS OF PROFITS OR CONFIDENTIAL OR OTHER INFORMATION, FOR BUSINESS INTERRUPTION, FOR PERSONAL INJURY, FOR LOSS OF PRIVACY, FOR FAILURE TO MEET ANY DUTY INCLUDING OF GOOD FAITH OR OF REASONABLE CARE, FOR NEGLIGENCE, AND FOR ANY OTHER PECUNIARY OR OTHER LOSS WHATSOEVER) ARISING OUT OF OR IN ANY WAY RELATED TO THE USE OF OR INABILITY TO USE THE SOFTWARE, THE PROVISION OF OR FAILURE TO PROVIDE SUPPORT SERVICES, OR OTHERWISE UNDER OR IN CONNECTION WITH ANY

PROVISION OF THIS AGREEMENT, EVEN IN THE EVENT OF THE FAULT, TORT (INCLUDING NEGLIGENCE), STRICT LIABILITY, BREACH OF CONTRACT OR BREACH OF WARRANTY OF ACER OR ITS SUPPLIERS OR LICENSORS, AND EVEN IF ACER AND ITS SUPPLIERS AND LICENSORS HAVE BEEN ADVISED OF THE POSSIBILITY OF SUCH DAMAGES.

LIMITATION OF LIABILITY AND REMEDIES

NOTWITHSTANDING ANY DAMAGES THAT YOU MIGHT INCUR FOR ANY REASON WHATSOEVER (INCLUDING, WITHOUT LIMITATION, ALL DAMAGES REFERENCED ABOVE AND ALL DIRECT OR GENERAL DAMAGES), THE ENTIRE LIABILITY OF ACER, ITS SUPPLIERS, AND ITS LICENSORS, UNDER ANY PROVISION OF THIS AGREEMENT, AND YOUR EXCLUSIVE REMEDY FOR ALL OF THE FOREGOING, SHALL BE LIMITED TO THE AGGREGATE AMOUNT PAID BY YOU FOR THE SOFTWARE. THE FOREGOING LIMITATIONS, EXCLUSIONS AND DISCLAIMERS (INCLUDING DISCLAIMER OF WARRANTIES AND EXCLUSION OF INCIDENTAL, CONSEQUENTIAL AND CERTAIN OTHER DAMAGES ABOVE) SHALL APPLY TO THE MAXIMUM EXTENT PERMITTED BY APPLICABLE LAW, EVEN IF ANY REMEDY FAILS ITS ESSENTIAL PURPOSE; PROVIDED, HOWEVER, THAT BECAUSE SOME JURISDICTIONS DO NOT ALLOW THE EXCLUSION OR LIMITATION OR LIABILITY FOR CONSEQUENTIAL OR INCIDENTAL DAMAGES, THE ABOVE LIMITATION MAY NOT APPLY TO YOU.

TERMINATION

Without prejudice to any other rights, Acer may immediately terminate this Agreement without notice if you fail to comply with any terms and conditions of this Agreement.

In such event, you must:

1. Cease all use of the Software;
2. Destroy or return to Acer the original and all copies of the Software; and
3. Delete the Software from all smartphones on which it was resident.

All disclaimers of warranties and limitation of liability set forth in this Agreement shall survive termination of this Agreement.

GENERAL

This Agreement represents the complete agreement between you and Acer relating to this license for the Software and supersedes all prior agreements, communications, proposals and representations between the parties and prevails over any conflicting or additional terms of any quote, order, acknowledgement or similar communication. This Agreement may only be modified by a written document signed by both parties. If any provision of this Agreement is held by a court of competent jurisdiction to be contrary to law that provision will be enforced to the maximum extent permissible and the remaining provisions of this Agreement will remain in full force and effect.

ADDITIONAL PROVISIONS APPLICABLE TO THIRD PARTY SOFTWARE AND SERVICES

Software provided hereunder by Acer's licensors or suppliers ("Third Party Software") is made available to you for your personal, non-commercial use only. You may not use the Third Party Software in any manner that could damage, disable, overburden, or impair the services provided by Acer's licensors or suppliers hereunder ("Third Party Services"). Furthermore, you may not use the Third Party Software in any manner that could interfere with any other party's use and enjoyment of the Third Party Services, or the services and products of Acer's licensors' or suppliers' third party licensors. Your use of the Third Party Software and Third Party Services is also subject to additional terms and conditions and policies which can be accessed through our global website.

Privacy policy

During registration you will be asked to submit some information to Acer. Please refer to Acer's privacy policy at www.acer.com or your local Acer website.

Free Manuals Download Website

<http://myh66.com>

<http://usermanuals.us>

<http://www.somanuals.com>

<http://www.4manuals.cc>

<http://www.manual-lib.com>

<http://www.404manual.com>

<http://www.luxmanual.com>

<http://aubethermostatmanual.com>

Golf course search by state

<http://golfingnear.com>

Email search by domain

<http://emailbydomain.com>

Auto manuals search

<http://auto.somanuals.com>

TV manuals search

<http://tv.somanuals.com>