



Acer V223W
Service Guide

Service Guide Version and Revision

Version	Release Date	Revision History	TPV model
A00	Mar.-17-2008	Initial Release	TC7ANCD8W7AYHN

Copyright

Copyright © 2003 by Acer Incorporated. All rights reserved. No part of this publication may be reproduced, Transmitted, transcribed, stored in a retrieval system, or translated into any language or computer language, in any form or by any means, electronic, mechanical, magnetic, optical, chemical, manual or otherwise, without the prior written permission of Acer Incorporated.

Disclaimer

The information in this guide is subject to change without notice. Acer Incorporated makes no representations or warranties, either expressed or implied, with respect to the contents hereof and specifically disclaims any warranties of merchantability or fitness for any particular purpose. Any Acer Incorporated software described in this manual is sold or licensed "as is". Should the programs prove defective following their purchase, the buyer (and not Acer Incorporated, its distributor, or its dealer) assumes the entire cost of all necessary servicing, repair, and any incidental or consequential damages resulting from any defect in the software.

Intel is a registered trademark of Intel Corporation.

Pentium and Pentium II/III are trademarks of Intel Corporation.

Other brand and product names are trademarks and/or registered trademarks of their respective holders.

Trademarks

Acer is a registered trademark of Acer Incorporated.

All other trademarks are property of their respective owners.

Conventions

The following conventions are used in this manual:

Screen messages	Denotes actual messages that appear on screen.
Note	Gives bits and pieces of additional information related to the current topic.
Warning	Alerts you to any damage that might result from doing or not doing specific actions.
Caution	Gives precautionary measures to avoid possible hardware or software problems.
Important	Remind you to do specific actions relevant to the accomplishment of procedures.

Preface

Before using this information and the product it supports, please read the following general information.

1. This Service Guide provides you with all technical information relating to the BASIC CONFIGURATION decided for Acer's "global" product offering. To better fit local market requirements and enhance product competitiveness, your regional office may have decided to extend the functionality of a machine (e.g. add-on card, modem, or extra memory capability). These LOCALIZED FEATURES will NOT be covered in this generic service guide. In such cases, please contact your regional offices or the responsible personnel/channel to provide you with further technical details.
2. Please note WHEN ORDERING FRU PARTS, that you should check the most up-to-date information available on your regional web or channel. If, for whatever reason, a part number change is made, it will not be noted in the printed Service Guide. For ACER-AUTHORIZED SERVICE PROVIDERS, your Acer office may have a DIFFERENT part number code to those given in the FRU list of this printed Service Guide. You MUST use the list provided by your regional Acer office to order FRU parts for repair and service of customer machines.

Warning: (For FCC Certified Models)

Note: This equipment has been tested and found to comply with the limits for a Class B digital device, pursuant to Part 15 of the FCC Rules. These limits are designed to provide reasonable protection against harmful interference in a residential installation. This equipment generates, uses and can radiate radio frequency energy, and if not installed and used in accordance with the instructions, may cause harmful interference to radio communications. However, there is no guarantee that interference will not occur in a particular installation. If this equipment does cause harmful interference to radio or television reception, which can be determined by turning the equipment off and on, the user is encouraged to try to correct the interference by one or more of the following measures:

1. Reorient or relocate the receiving antenna.
2. Increase the separation between the equipment and receiver.
3. Connect the equipment into an outlet on a circuit different from that to which the receiver is connected.
4. Consult the dealer or an experienced radio/TV technician for help.

Notice:

1. The changes or modifications not expressly approved by the party responsible for compliance could void the user's authority to operate the equipment.
2. Shielded interface cables and AC power cord, if any, must be used in order to comply with the emission limits.
3. The manufacturer is not responsible for any radio or TV interference caused by unauthorized modification to this equipment. It is the responsibility of the user to correct such interference.

As ENERGY STAR® Partner our company has determined that this product meets the ENERGY STAR® guidelines for energy efficiency.

Warning:

To prevent fire or shock hazard, do not expose the monitor to rain or moisture. Dangerous high voltages are present inside the monitor. Do not open the cabinet. Refer servicing to qualified personnel only.

Precautions

- Do not use the monitor near water, e.g. near a bathtub, washbowl, kitchen sink, laundry tub, swimming pool or in a wet basement.
- Do not place the monitor on an unstable trolley, stand, or table. If the monitor falls, it can injure a person and cause serious damage to the appliance. Use only a trolley or stand recommended by the manufacturer or sold with the monitor. If you mount the monitor on a wall or shelf, use a mounting kit approved by the manufacturer and follow the kit instructions.
- Slots and openings in the back and bottom of the cabinet are provided for ventilation. To ensure reliable operation of the monitor and to protect it from overheating, be sure these openings are not blocked or covered. Do not place the monitor on a bed, sofa, rug, or similar surface. Do not place the monitor near or over a radiator or heat register. Do not place the monitor in a bookcase or cabinet unless proper ventilation is provided.
- The monitor should be operated only from the type of power source indicated on the label. If you are not sure of the type of power supplied to your home, consult your dealer or local power company.
- The monitor is equipped with a three-pronged grounded plug, a plug with a third (grounding) pin. This plug will fit only into a grounded power outlet as a safety feature. If your outlet does not accommodate the three-wire plug, have an electrician install the correct outlet, or use an adapter to ground the appliance safely. Do not defeat the safety purpose of the grounded plug.
- Unplug the unit during a lightning storm or when it will not be used for long periods of time. This will protect the monitor from damage due to power surges.
- Do not overload power strips and extension cords. Overloading can result in fire or electric shock.
- Never push any object into the slot on the monitor cabinet. It could short circuit parts causing a fire or electric shock. Never spill liquids on the monitor.
- Do not attempt to service the monitor yourself; opening or removing covers can expose you to dangerous voltages and other hazards. Please refer all servicing to qualified service personnel
- To ensure satisfactory operation, use the monitor only with UL listed computers which have appropriate configured receptacles marked between 100 - 240V AC, Min. 5A.
- The wall socket shall be installed near the equipment and shall be easily accessible.

Special Notes On LCD Monitors

The following symptoms are normal with LCD monitor and do not indicate a problem.

Notes

- Due to the nature of the fluorescent light, the screen may flicker during initial use. Turn off the Power Switch and then turn it on again to make sure the flicker disappears.
- You may find slightly uneven brightness on the screen depending on the desktop pattern you use.
- The LCD screen has effective pixels of 99.99% or more. It may include blemishes of 0.01% or less such as a missing pixel or a pixel lit all of the time.
- Due to the nature of the LCD screen, an afterimage of the previous screen may remain after switching the image, when the same image is displayed for hours. In this case, the screen is recovered slowly by changing the image or turning off the Power Switch for hours.

Table Of Contents

Chapter 1	Monitor Features	7
	Introduction	7
	Electrical Requirements	8
	LCD Monitor General Specification	9
	LCD Panel Specification	10
	Support Timing	13
	Monitor Block Diagram	14
	Main Board Diagram	15
	Software Flow chart	16
	Main Board Layout	18
	Installation	19
	Attaching/Removing the base	20
Chapter 2	Operating Instructions	21
	External Controls	21
	Front Panel Controls	21
	eColor Management (OSD)	22
	How to Adjust a Setting	23
	LOGO	27
Chapter 3	Machine Disassembly	28
Chapter 4	Troubleshooting	31
Chapter 5	Connector Information	37
Chapter 6	FRU (Field Replacement Unit) List	38
	Exploded Diagram	38
Chapter 7	Schematic Diagram	41

Introduction**Scope**

This specification defines the requirements for the 22" MICROPROCESSOR based Multi-mode supported high resolution color LCD monitor. This monitor can be directly connected to general 15-pin D-sub VGA connector, also supports VESA DPMS power management and plug & play function.

Description

The LCD monitor is designed with the latest LCD technology to provide a performance oriented product with no radiation. This will alleviate the growing health concerns. It is also a space saving design, allowing more desktop space, and comparing to the traditional CRT monitor, it consumes less power and gets less weight in addition MTBF target is 50k hours or more.

Chart of V223W

Panel	LTM220M1-L01
Signal Interface	D-Sub 15-pin
Sync Type	Separate / Compatible
Color Temp User Adjust	Support
DDC	DDC2B
Speaker	No
Headphone Jack	No
Microphone Jack	No
USB Hub	Not support
Tilt / Swivel	Yes / No

Electrical Requirements

Standard Test Conditions

All tests shall be performed under the following conditions, unless otherwise specified.

Ambient light	Dark room (< 1 cd/m ²)
Viewing distance	35-50cm
Warm up time	>30 minutes
Analog Input signal	700 mVss
Control temperature	6500° K
User brightness control	The value under user mode
User contrast control	Set to The value under user mode, which allows that the brightest two of 32 linear distributed gray-scales (0~ 700mv) can be distinguished.
Picture position and size	Factory preset value
Viewing angle	90°±20 °H and 90°±10°V
AC Supply voltage	230V± 5%, 50±3Hz
Ambient temperature	20+5□
Humidity	65% ± 20%
Display mode	1680x1050, 60 Hz, all white
e-color mode	Set to "User" mode

Measurement systems

The units of measure stated in this document are listed below:

1 gamma = 1 nano tesla

1 tesla = 10,000 gauss

cm = in x 2.54

Lb = kg x 2.2

Degrees F = [°C x 1.8] + 32

Degrees C = [°F - 32]/1.8

$u' = 4x/(-2x + 12y + 3)$

$v' = 9y/(-2x + 12y + 3)$

$x = (27u'/4)/[(9u'/2) - 12v' + 9]$

$y = (3v')/[(9u'/2) - 12v' + 9]$

nits = cd/(m²) = Ft-L x 3.426

lux = foot-candle x 10.76

LCD Monitor General Specification

LCD Panel	Driving system	TFT Color LCD
	Active Display Area	473.76(H) x 296.1(V)
	Pixel pitch	0.282(H) x 0.282(W)
	Contrast Ratio	1000 : 1
	Response time	5ms
	Luminance of White	300(Typ.) cd/m ²
Input	Separate Sync.	H/V TTL
	H-Frequency	30kHz – 83kHz
	V-Frequency	56-76Hz
Viewing angle	(H)160 (V) 160(Type)	
Display Colors	16.7M	
Display mode	1680 x 1050 @60Hz	
EPA ENERGY STAR®	ON Mode	< 49W
	OFF Mode	< 1W
Contrast control	Set to The value under user mode, which allows that the brightest two of 32 linear distributed gray-scales (0~ 700mv) can be distinguished.	
Power Source	90 V ~ 240 V, 50 ± 3Hz, 60 ± 3Hz	
Environmental Considerations	Operating Temp: 0° to 40°C Storage Temp: -30° to 65°C Operating Humidity: 0% to 90% Storage Humidity: 0% to 90%	
Peak surge current	< 100 A peak at 230 VAC and cold starting & 25°C & DC Output at Full-load	
Power line surge	No advance effects (no loss of information or defect) with a maximum of 1 half-wave missing per second	

LCD Panel Specification

LTM220M1-L01 is a color active matrix liquid crystal display (LCD) that uses amorphous silicon TFT (Thin Film Transistor) as switching components. This model is composed of a TFT LCD panel, a driver circuit and a back light unit. The resolution of a 22" is 1680 x 1050 and this model can display up to 16.7 millions colors.

General Specifications

Items	Specification	Unit
Pixel Pitch	0.282(H) x 0.282(W)	mm
Active Display Area	473.76(H) x 296.1(V)	mm
Surface Treatment	Haze 25% Hard coating (3H)	
Display Colors	16.7M (6 bit Hi-FRC)	colors
Number of Pixels	1,680 x 1,050	pixel
Pixel Arrangement	RGB vertical stripe	
Display Mode	Normally White	
Power Consumption	31.3 Watt (Typ)	
Luminance of White	300(Typ.)	cd/m ²

Mechanical Information

Item		Min.	Typ.	Max.	Unit	Note
Module size	Horizontal (H)	493.2	493.7	494.2	mm	w/o inverter ass'y
	Vertical (V)	319.6	320.1	320.6	mm	
	Depth (D)	-	-	17.0	mm	
Weight		-	-	2,600	g	LCD module only

Electrical Characteristics

Ta = 25°C

Item		Symbol	Min.	Typ.	Max.	Unit	Note
Voltage of Power Supply		V _{DD}	4.5	5.0	5.5	V	(1)
LVDS Input Characteristics	Differential Input Voltage for LVDS Receiver Threshold	High	-	-	+100	mV	(2)
		Low	-100	-	-	mV	
	LVDS skew	t _{SKEW}	-300		300	ps	(3)
	Differential input voltage	V _{ID}	200		600	mV	(4)
	Input voltage range (single-ended)	V _{IN}	0		2.4	V	(4)
	Common mode voltage	V _{CM}	0+ V _{ID} /2	1.2	2.4- V _{ID} /2	V	(4)
Current of Power Supply	(a) Black	I _{DD}	-	1,500	-	mA	(5),(6)
	(b) White		-	900	-	mA	
	(c) Dot		-	1,700	1,900	mA	
Vsync Frequency		f _V	53	60	76	Hz	
Hsync Frequency		f _H	57.2	64.8	83.2	kHz	
Main Frequency		f _{DCLK}	52.6	59.5	77.5	MHz	
Rush Current		I _{RUSH}	-	-	4.0	A	(7)

Optical Specifications

(Ta = 25 ± 2°C, VDD=5V, fv= 60Hz, fDCLK=59.6MHz, IL = 7.5mArms)

Item	Symbol	Condition	Min.	Typ.	Max.	Unit	Note	
Contrast Ratio (Center of screen)	C/R		600	1000	-		(3) SR-3	
Response Time	On/Off	Tr + Tf	-	5	8	msec	(5) RD-80S	
Luminance of White (Center of screen)	Y _L		250	300	-	cd/m ²	(6) SR-3	
Color Chromaticity (CIE 1931)	Red	Rx	0.610	0.640	0.670		(7),(8) SR-3	
		Ry	0.300	0.330	0.360			
	Green	Gx	0.270	0.300	0.330			
		Gy	0.570	0.600	0.630			
	Blue	Bx	0.120	0.150	0.180			
		By	0.030	0.060	0.090			
	White	Wx	0.283	0.313	0.343			
		Wy	0.299	0.329	0.359			
	Color Chromaticity (CIE 1976)	Red	Ru'	-	0.451	-		
			Rv'	-	0.523	-		
Green		Gu'	-	0.125	-			
		Gv'	-	0.564	-			
Blue		Bu'	-	0.175	-			
		Bv'	-	0.158	-			
White		Wu'	-	0.198	-			
		Wv'	-	0.468	-			
C.G.L (ACC ONLY)	White	Δu'v'	-	-	0.02		(9)	

* C.G.L : Color Grayscale Linearity

Item	Symbol	Condition	Min.	Typ.	Max.	Unit	Note
Color Gamut	-		-	72	-	%	
Color Temperature	-		-	6500	-	K	
Viewing Angle	Hor.	θ _L	70(80)	80(89)	-	Degrees	(8) EZ- Contrast
		θ _R	70(80)	80(89)	-		
	Ver.	θ _U	70(80)	80(89)	-		
		θ _D	70(80)	80(89)	-		
Brightness Uniformity (9 Points)	B _{uni}		-	-	25	%	(4) SR-3

Support Timing

Mode	Resolution	Total	Horizontal		Vertical		Nominal Pixel Clock (MHz)
			Nominal Frequency +/- 0.5kHz	Sync Polarity	Nominal Freq. +/- 1 Hz	Sync Polarity	
VGA	640x480@60Hz	800 x 525	31.469	N	59.940	N	25.175
	640x480@72Hz	832 x 520	37.861	N	72.809	N	31.500
	640x480@75Hz	840 x 500	37.500	N	75.00	N	31.500
SVGA	800x600@56Hz	1024 x 625	35.156	N/P	56.250	N/P	36.000
	800x600@60Hz	1056 x 628	37.879	P	60.317	P	40.000
	800x600@72Hz	1040 x 666	48.077	P	72.188	P	50.000
	800x600@75Hz	1056x625	46.875	P	75.000	P	49.500
XGA	1024x768@60Hz	1344x806	48.363	N	60.004	N	65.000
	1024x768@70Hz	1328x806	56.476	N	70.069	N	75.000
	1024x768@72Hz	1304x798	57.7	P	72	P	78.4
	1024x768@75Hz	1312x800	60.023	P	75.029	P	78.750
	1152x864@75Hz	1600X900	67.5khz	P	75	P	108.000
SXGA	1280x1024@60Hz	1688x1066	63.981	P	60.020	P	108.000
	1280x1024@70Hz	1688x1066	74.4	P	70	P	124.9
	1280x1024@72Hz	1688x1066	77.9	P	72	P	134.6
	1280x1024@75Hz	1688x1066	79.976	P	75.025	P	135.000
	1280x960@60Hz	1800x1000	60	P	60	P	108
	1440x900@60Hz	1904x934	55.93	P	60	P	106.5
WSXGA	1680x1050@60Hz	2240x1089	65.29	N	59.95	P	146.25
UXGA	1600x1200@60Hz	2160x1250	75	P	60	P	162

Monitor Block Diagram

The LCD MONITOR will contain a main board, a power board, and key board which house the flat panel control logic, brightness control logic and DDC.

The power board will provide AC to DC Inverter voltage to drive the backlight of panel and the main board chips each voltage.

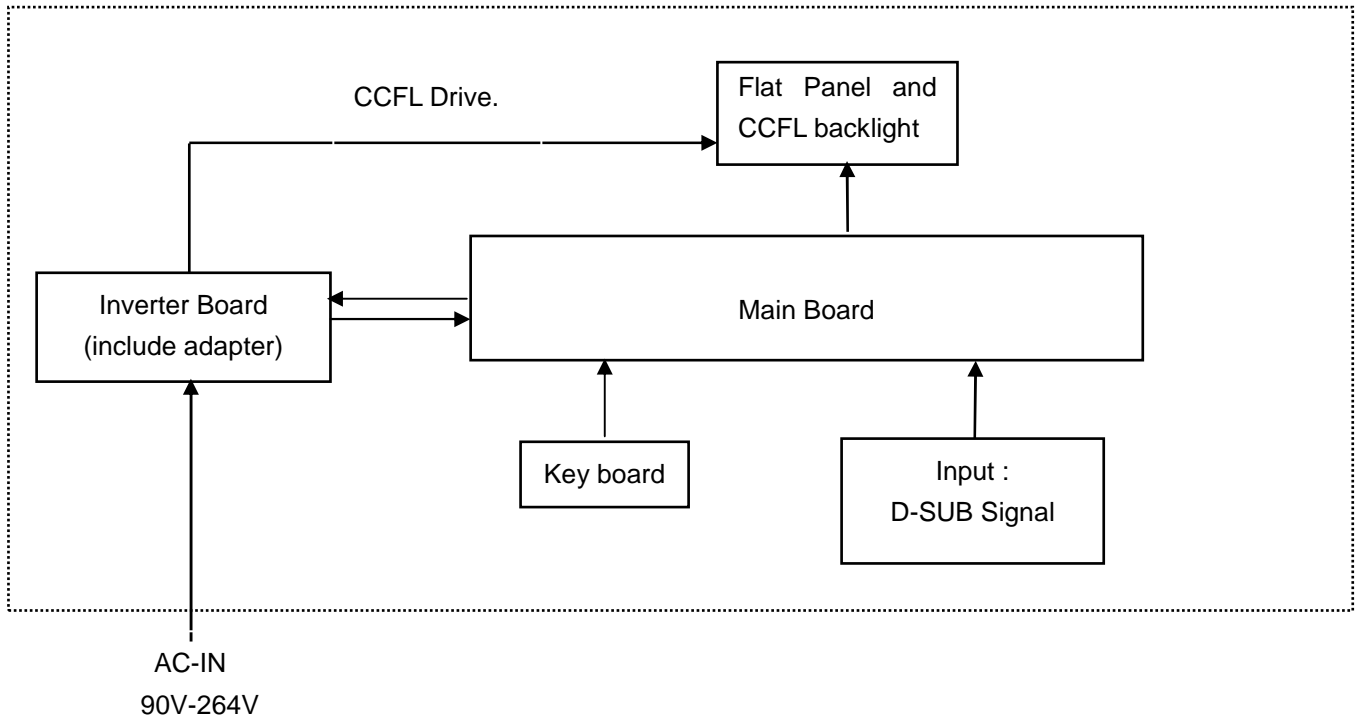

Main Board Diagram

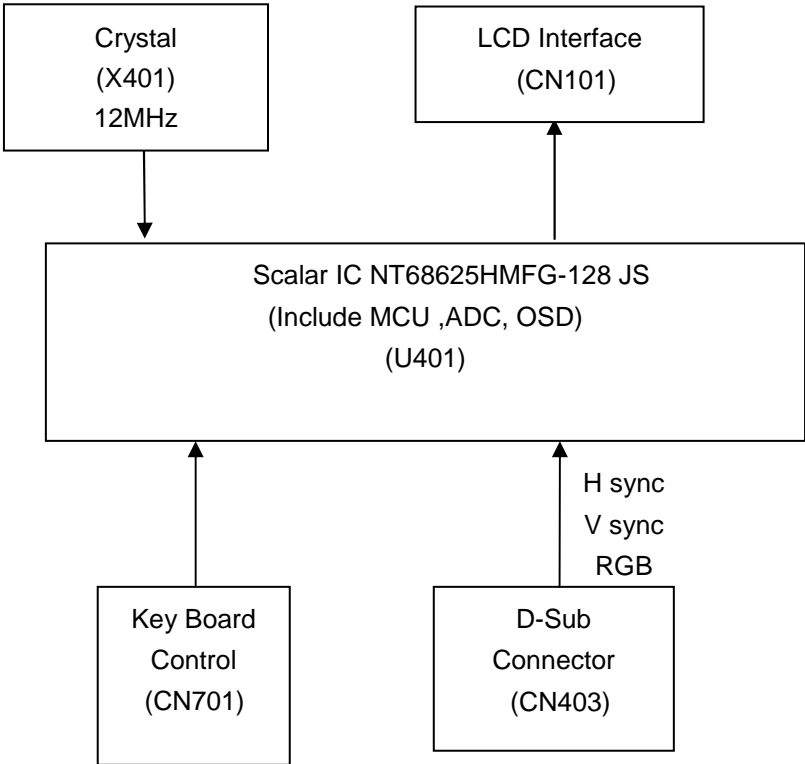

Software Flow Chart

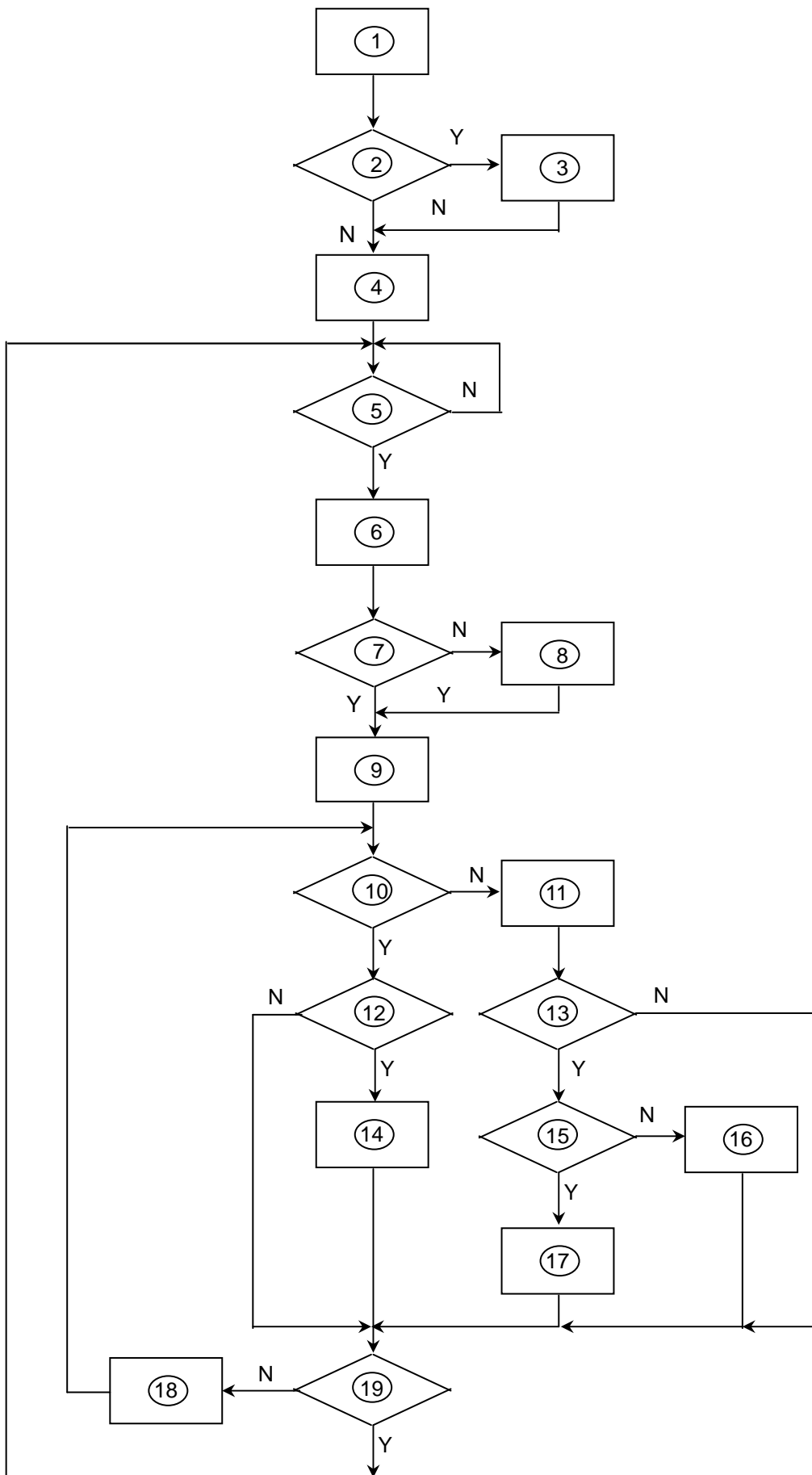

Remark:

1) MCU initializes.
2) Is the EEPROM blank?
3) Program the EEPROM by default values.
4) Get the PWM value of brightness from EEPROM.
5) Is the power key pressed?
6) Clear all global flags.
7) Are the AUTO and SELECT keys pressed?
8) Enter factory mode.
9) Save the power key status into EEPROM. Turn on the LED and set it to green color. Scalar initializes.
10) In standby mode?
11) Update the lifetime of back light.
12) Check the analog port, are there any signals coming?
13) Does the scalar send out an interrupt request?
14) Wake up the scalar.
15) Are there any signals coming from analog port?
16) Display "No connection Check Signal Cable" message. And go into standby mode after the message disappears.
17) Program the scalar to be able to show the coming mode.
18) Process the OSD display.
19) Read the keyboard. Is the power key pressed?

Main Board Layout

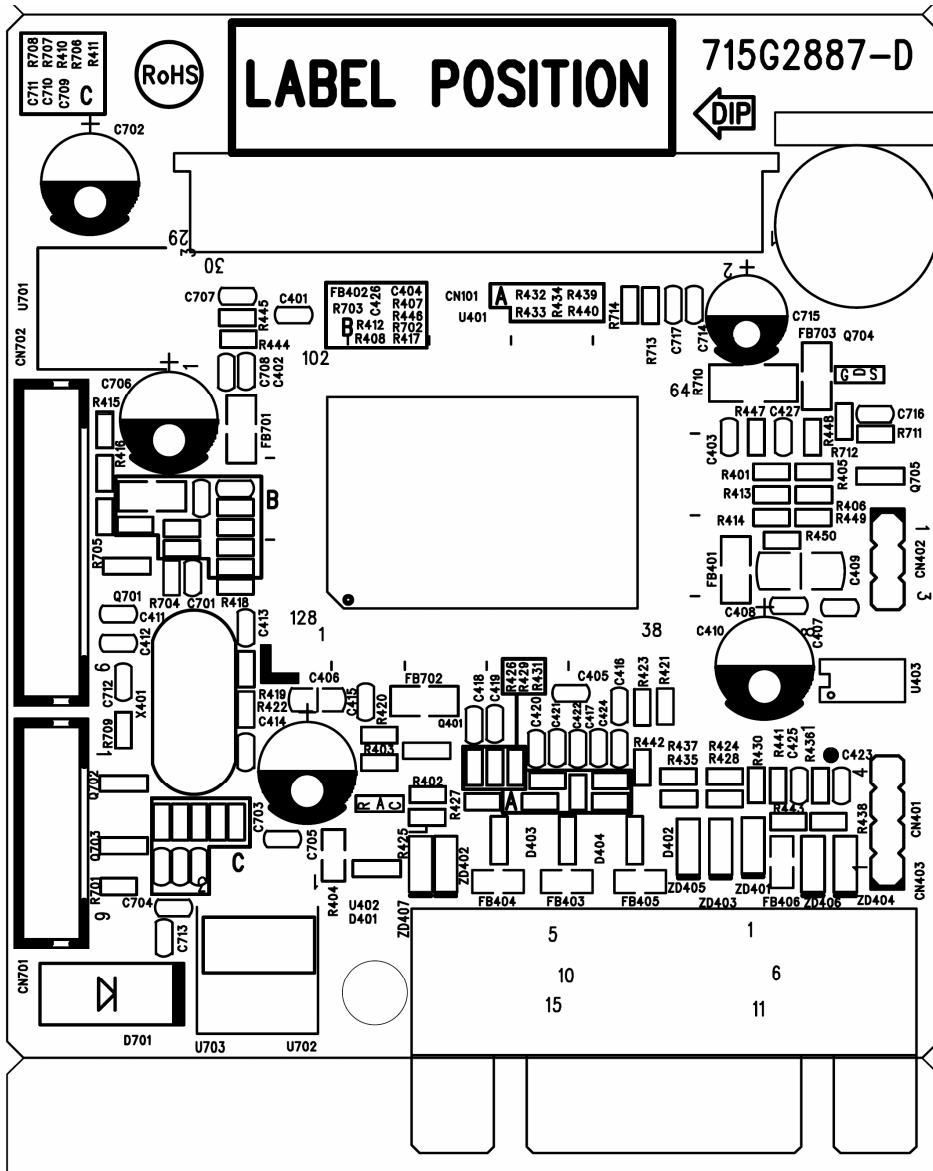

Symbol	Description	Symbol	Description
U402	AZ431AN-A-E1	CN701	WAFER 6PIN
U401	NT68625HMF-128 JS	CN702	WAFER 9P RIGHT ANELE PITCH
U702	AP1117E33LA	CN403	D-SUB 15PIN
CN101	CONNECTOR	X401	NXS12.000AC30F-BT-2

Installation

To install the monitor on your host system, please follow the steps below:

Steps

1 Connect the video cable

A: Make sure both the monitor and computer are switched off.

B: Connect the VGA video cable to the computer.

2 Connect the power cord

Connect the power cord to the monitor, then to a properly grounded AC outlet.

3 Turn on the monitor and computer

Turn on the monitor first, then the computer. This sequence is very important.

4 If the monitor does not function properly, please refer to the troubleshooting section to diagnose the problem.

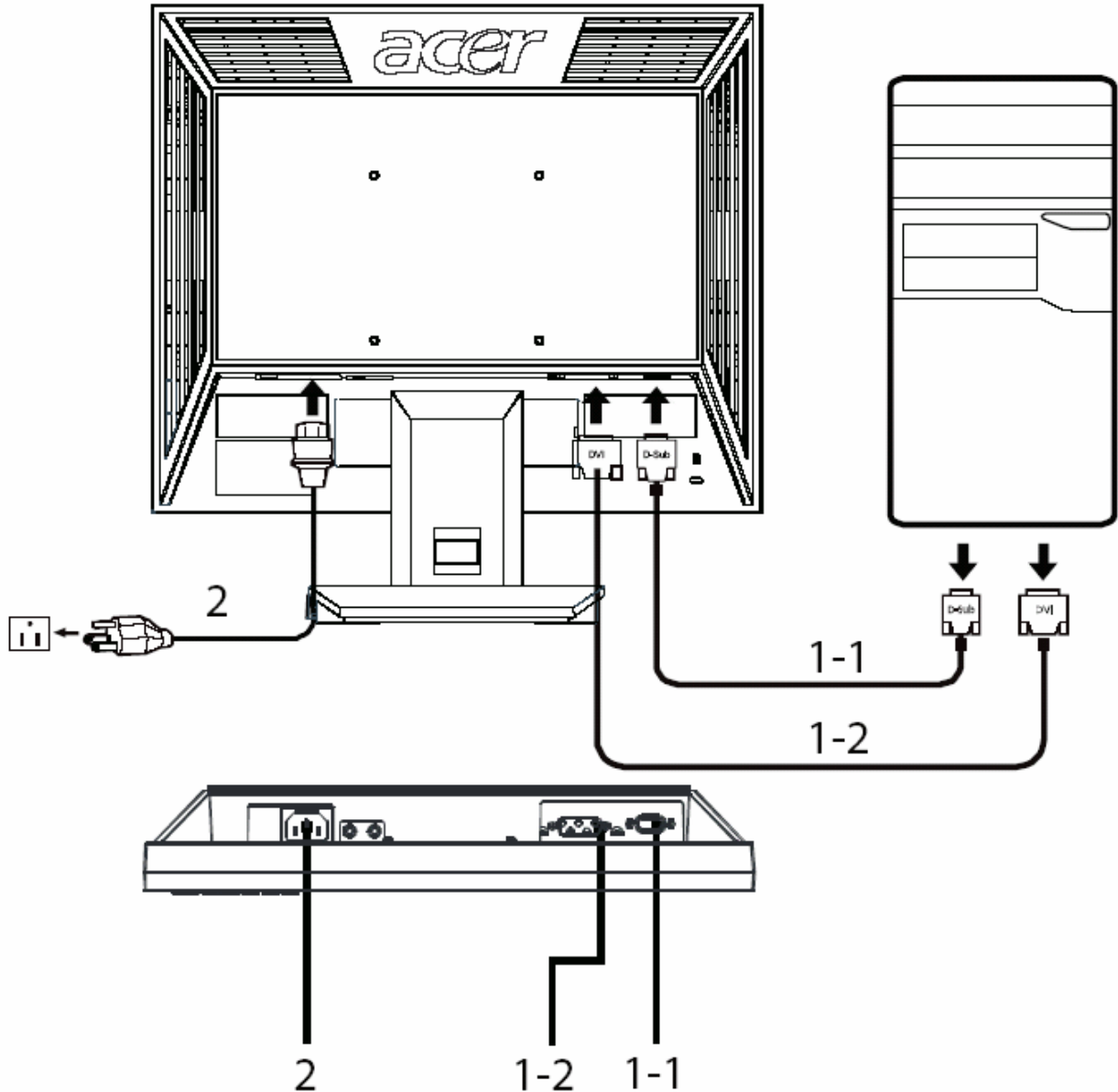

Attaching/Removing the Base

Attaching:

Align the release button on the bottom of the monitor with the corresponding slots on the bottom of the base.

Removing:

Press the release button as indicated, then pull in the direction of the arrow to remove the base.

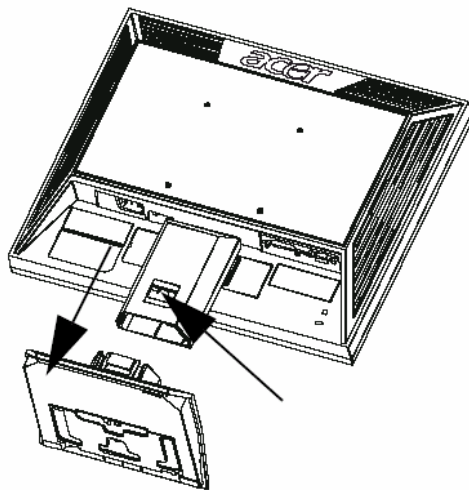
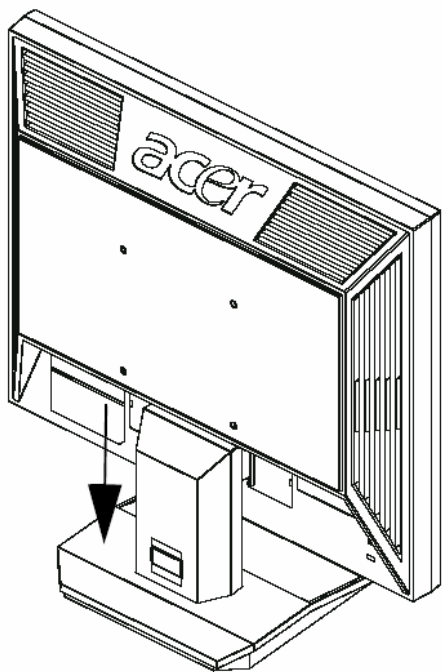

Press the power button to turn the monitor on or off. The other control buttons are located at front panel of the monitor. By changing these settings, the picture can be adjusted to your personal preferences.

- The power cord should be connected.
- Connect the video cable from the monitor to the video card.
- Press the power button to turn on the monitor position. The power indicator will light up.

External Controls

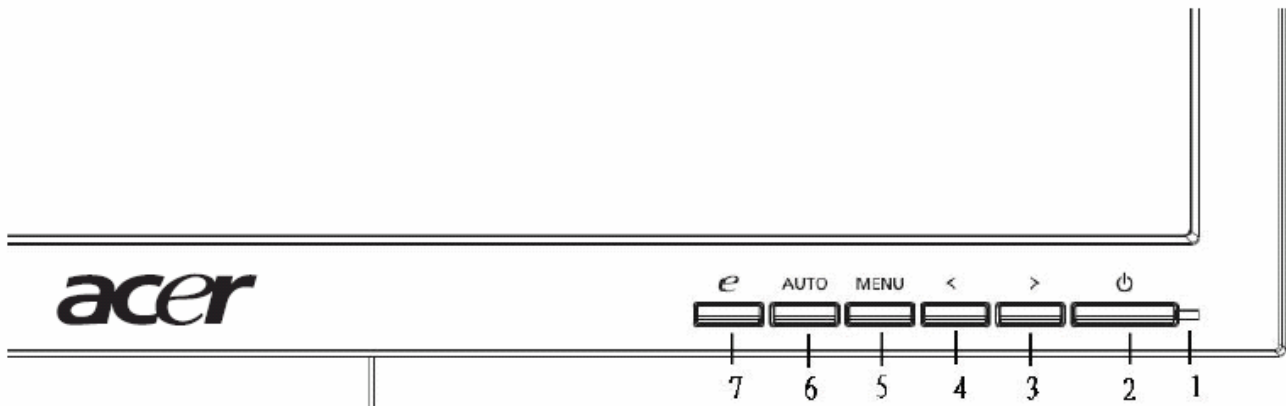

Front panel controls

1 Power LED: Lights up to indicate the power is turned on.

2 Power Switch: Turn the power on or off.

3.4 < / > : Press < or > to navigate to the desired function, press Enter to select the function. Press < or > to change the settings of the current function.

5 Menu/Enter: Activate the OSD menu when the OSD is off or activate deactivate the adjustment function when the OSD is on.

6 Auto adjust button/Exit:

a. When the OSD menu is active, this button will act as the exit key exit OSD menu).

b. When the OSD menu is inactive, press this button for two seconds to activate the Auto Adjustment function. The Auto Adjustment function s used to set the HPos, VPos, Clock and Focus.

7 Empowering Key/Exit:

a. When the OSD menu is active, this button will act as the exit key exit OSD menu).

b. When the OSD menu is inactive, press this button to select scenario mode.

eColor Management (OSD)

- Operation instructions
 - 1 Press the *e* Empowering Key to open the Acer eColor Management OSD and access the scenario modes.
 - 2 Press "<" or ">" to select the mode.
 - 3 Press the Auto-adjust button to confirm the mode and run Auto Adjust.

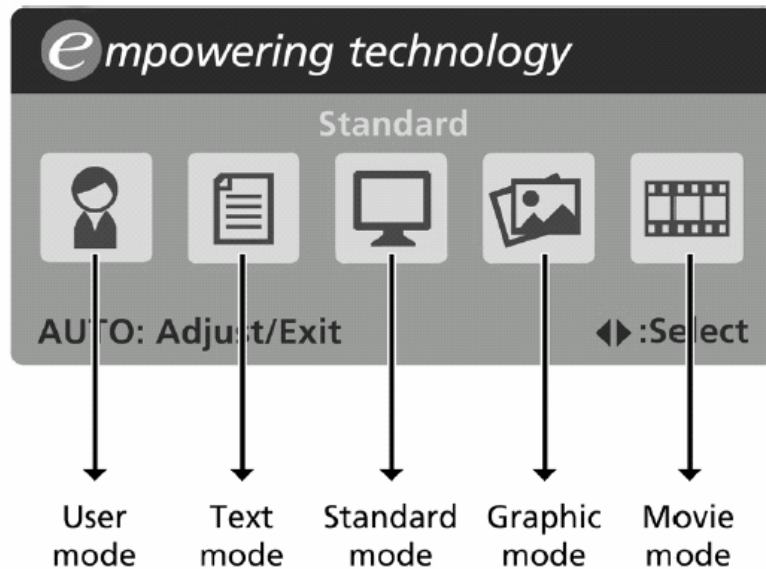

- Features and benefits

Main menu icon	Sub menu item	Description
	User mode	User-defined. Settings can be fine-tuned to suit any situation.
	Text mode	Optimal balance of brightness and contrast to prevent eyestrain. The most comfortable way to read onscreen text.
	Standard mode	Default settings. Reflects native display capability.
	Graphic mode	Enhances colors and emphasizes fine detail. Pictures and photographs appear in vibrant colors with sharp detail.
	Movie mode	Displays scenes in clearest detail. Presents great visuals, even in unsuitably-lit environments.

How to Adjust a Setting

1. Press the MENU-button to activate the OSD window.
 2. Press < or > to select the desired function.
 3. Press the MENU-button to select the function that you want to adjust.
 4. Press < or > to change the settings of the current function.
 5. To exit and save, select the exit function. If you want to adjust any other function, repeat steps 2-4.
- P/X Series OSD behave
When user press "MENU" button on front bezel

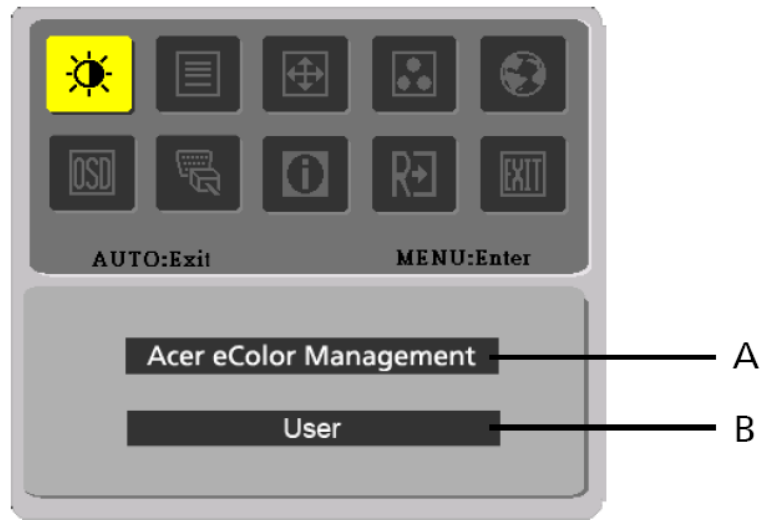

- A. Acer eColor Management
If selected to "Acer eColor Management" item, will appear the Acer eColor" OSD
- B. USER
If selected to "USER" item, will appear the Standard OSD

















I. Only Analog Input Model











II. Only Dual Input Model

Adjusting the picture

Main Menu icon	Sub Menu icon	Sub Menu item	Description
		Contrast	Adjust the contrast between the foreground and background of the screen image
		Brightness	Adjust the background brightness of the screen image
		ACM	ACM (Adaptive Contrast Management) ACM ON/OFF Switch, default "OFF"
		Focus	Adjust picture Focus (available in analog mode only)
		Clock	Adjust picture Clock (available in analog mode only)

Main Menu Icon	Sub Menu Icon	Sub Menu Item	Description
		H. Position	Adjust the horizontal position. (available in Analog mode only)
		V. Position	Adjust the vertical position. (available in Analog mode only)
	N/A	Warm	Set the color temperature to warm white.
	N/A	Cool	Set the color temperature to cool white.
		User /Red	Adjusts Red/Green/Blue intensity.
		User /Green	
		User /Blue	

	N/A	English	Multi-language selection.
	N/A	繁體中文	
	N/A	Deutsch	
	N/A	Francais	
	N/A	Espanol	
	N/A	Italiano	
	N/A	简体中文	
	N/A	日本語	
	N/A	Suomi	EMEA version OSD only
	N/A	Nederlands	
	N/A	Рысскнн	

Main Menu Icon	Sub Menu Icon	Sub Menu Item	Description
		H. Position	Adjust the horizontal position of the OSD.
		V. Position	Adjust the vertical position of the OSD.
		OSD Timeout	Adjust the OSD timeout.
	N/A	Analog	Select input signal from analog (D-Sub)
	N/A	Digital (only Dual-Input Model)	Select input signal from digital(DVI) (only Dual-Input Model)
	N/A	DDC/CI	Turn ON/OFF DDC/CI support
	N/A	Information	Show the resolution, HV frequency and input port of current input timing.
	N/A	Reset	Clear each old status of Auto-configuration and set the color temperature to Cool.
	N/A	Exit	Save user adjustment and OSD disappear.

OSD Message

a. Outline



b. The Description For OSD Message

Item	Description
Auto Config Please Wait	When Analog signal input, if User Press Hot-Key "Auto", will show this message, and the monitor do the auto config function.
Input Not Supported	When the Hsync Frequency, Vsync Frequency or Resolution is out of the monitor support range, will show this message. This message will be flying.
Cable Not Connected	Analog-Only Model: When the video cable is not connected, will show this message. This message will be flying.
No Signal	Analog-Only Model: When the video cable is connected, but there is no active signal input, will show this message, then enter power saving.

Logo

When the monitor is power on, the LOGO will be showed in the center, and disappear slowly.



How To Optimize The DOS-Mode

Plug And Play

Plug & Play DDC2B Feature

This monitor is equipped with VESA DDC2B capabilities according to the VESA DDC STANDARD. It allows the monitor to inform the host system of its identity and, depending on the level of DDC used, communicate additional information about its display capabilities.

The DDC2B is a bi-directional data channel based on the I²C protocol. The host can request EDID information over the DDC2B channel.

This monitor will appear to be non-functional if there is no video input signal. In order for this monitor to operate properly, there must be a video input signal.

This monitor meets the Green monitor standards as set by the Video Electronics Standards Association (VESA) and/or the United States Environmental Protection Agency (EPA) and The Swedish Confederation Employees (NUTEK). This feature is designed to conserve electrical energy by reducing power consumption when there is no video-input signal present. When there is no video input signals this monitor, following a time-out period, will automatically switch to an OFF mode. This reduces the monitor's internal power supply consumption. After the video input signal is restored, full power is restored and the display is automatically redrawn. The appearance is similar to a "Screen Saver" feature except the display is completely off. Pressing a key on the keyboard, or clicking the mouse restores the display.

Using The Right Power Cord

The accessory power cord for the Northern American region is the wallet plug with NEMA 5-15 style and is UL listed and CSA labeled. The voltage rating for the power cord shall be 125 volts AC.

Supplied with units intended for connection to power outlet of personal computer: Please use a cord set consisting of a minimum No. 18 AWG, type SJT or SVT three conductors flexible cord. One end terminates with a grounding type attachment plug, rated 10A, 250V, and CEE-22 male configuration. The other end terminates with a molded-on type connector body, rated 10A, 250V, having standard CEE-22 female configuration.

Please note that power supply cord needs to use VDE 0602, 0625, 0821 approval power cord in European countries.

This chapter contains step-by-step procedures on how to disassemble the monitor for maintenance.

Disassembly Procedure

1. Remove the cover hinge as the following indicator. (Fig 1)

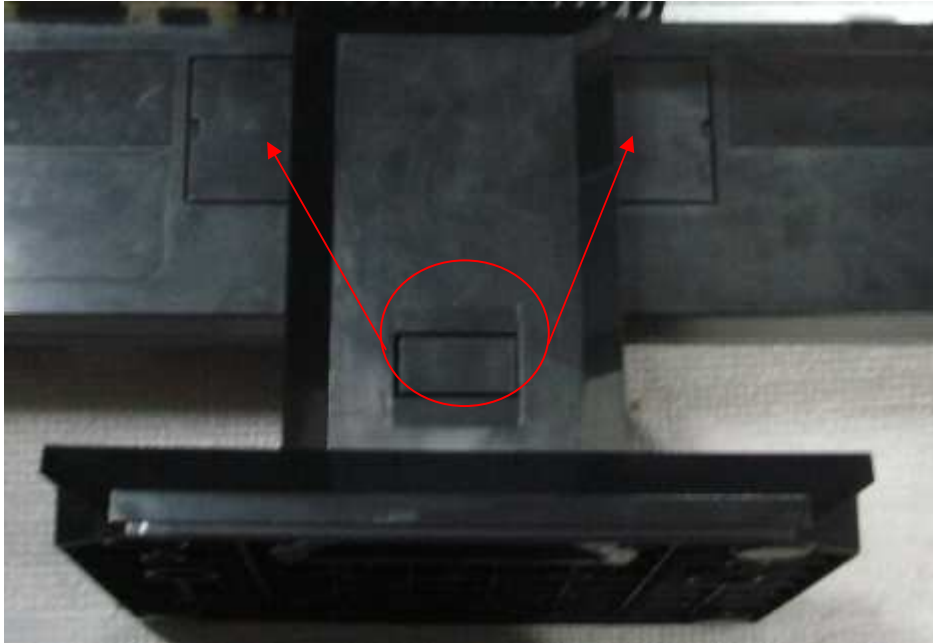

Fig 1

2. Remove the screws as following indicate to release base stand. (Fig 2)

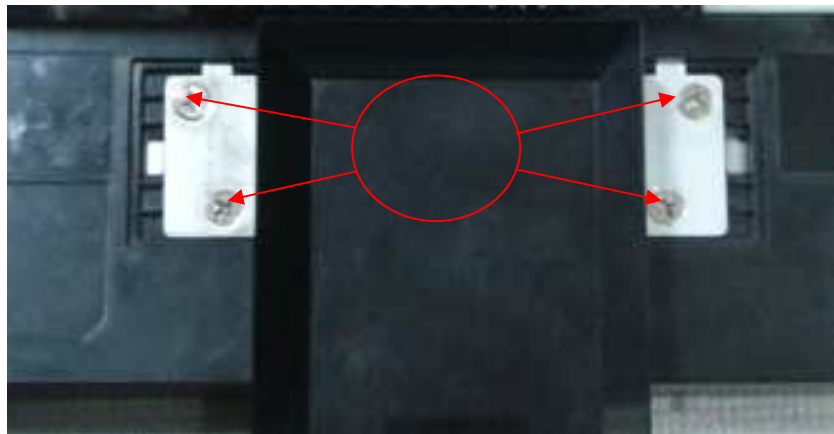

Fig 2

3. Remove the back cover and bezel. (Fig 3)



Fig 3

4. Remove the lamp connectors and the screw. (Fig 4-5)



Fig 4



Fig 5

5. Remove the screws to remove the panel. Put attention to the LVDS cable.(Fig 6-7)

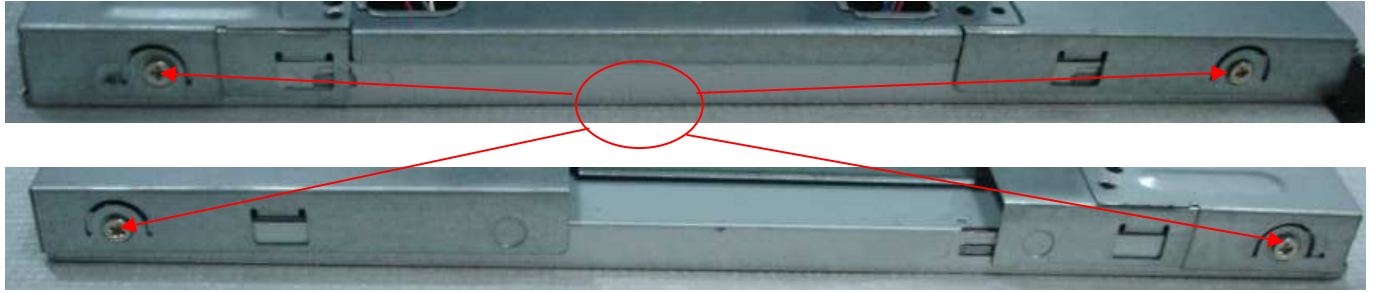

Fig 6



Fig 7

6. Remove the screws to remove the main board and power board.(Fig 8)



Fig 8

This chapter provides troubleshooting information for the V223W:

1. No Power

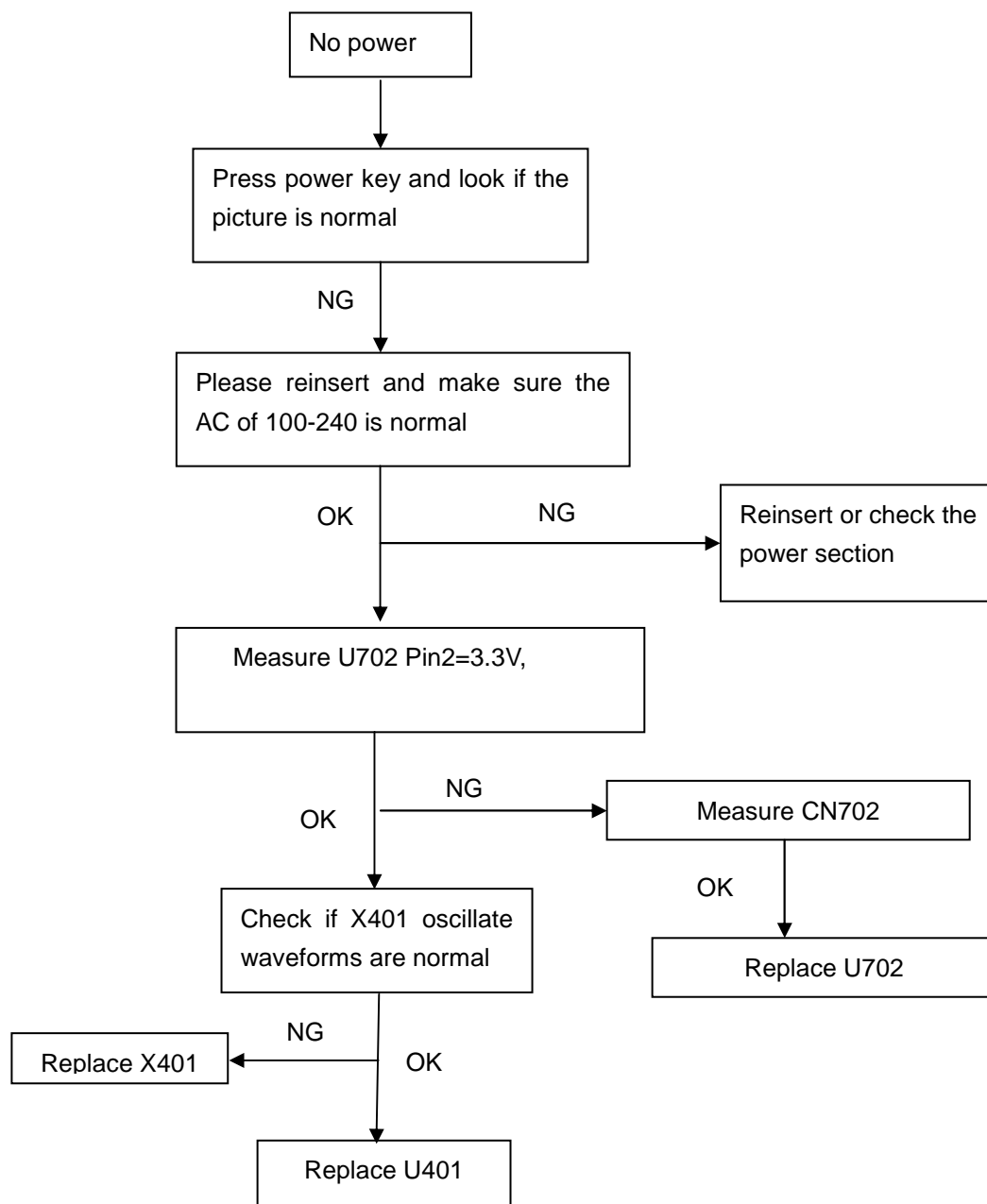

2. No Picture (LED is orange)

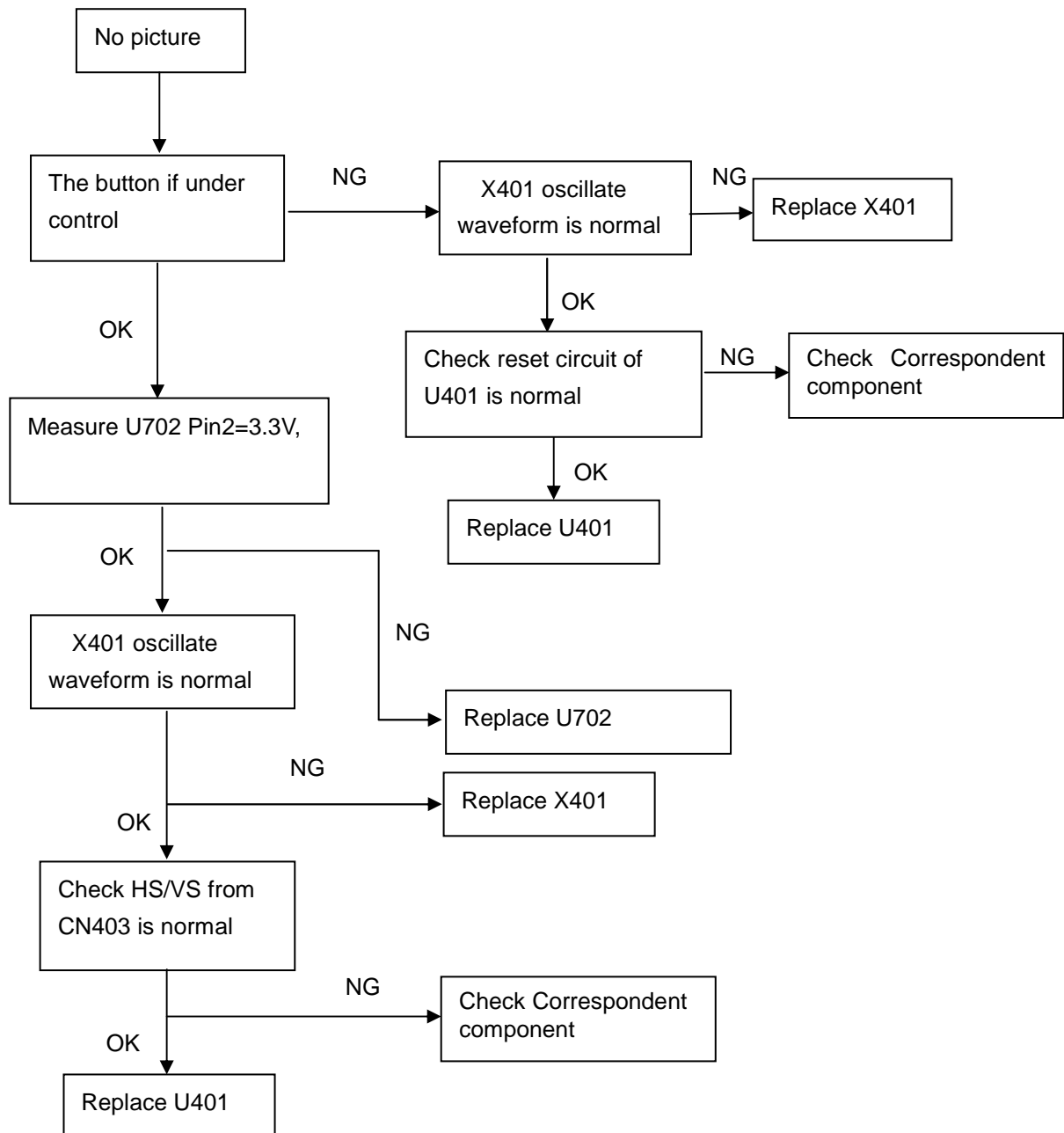

3. Panel Power Circuit

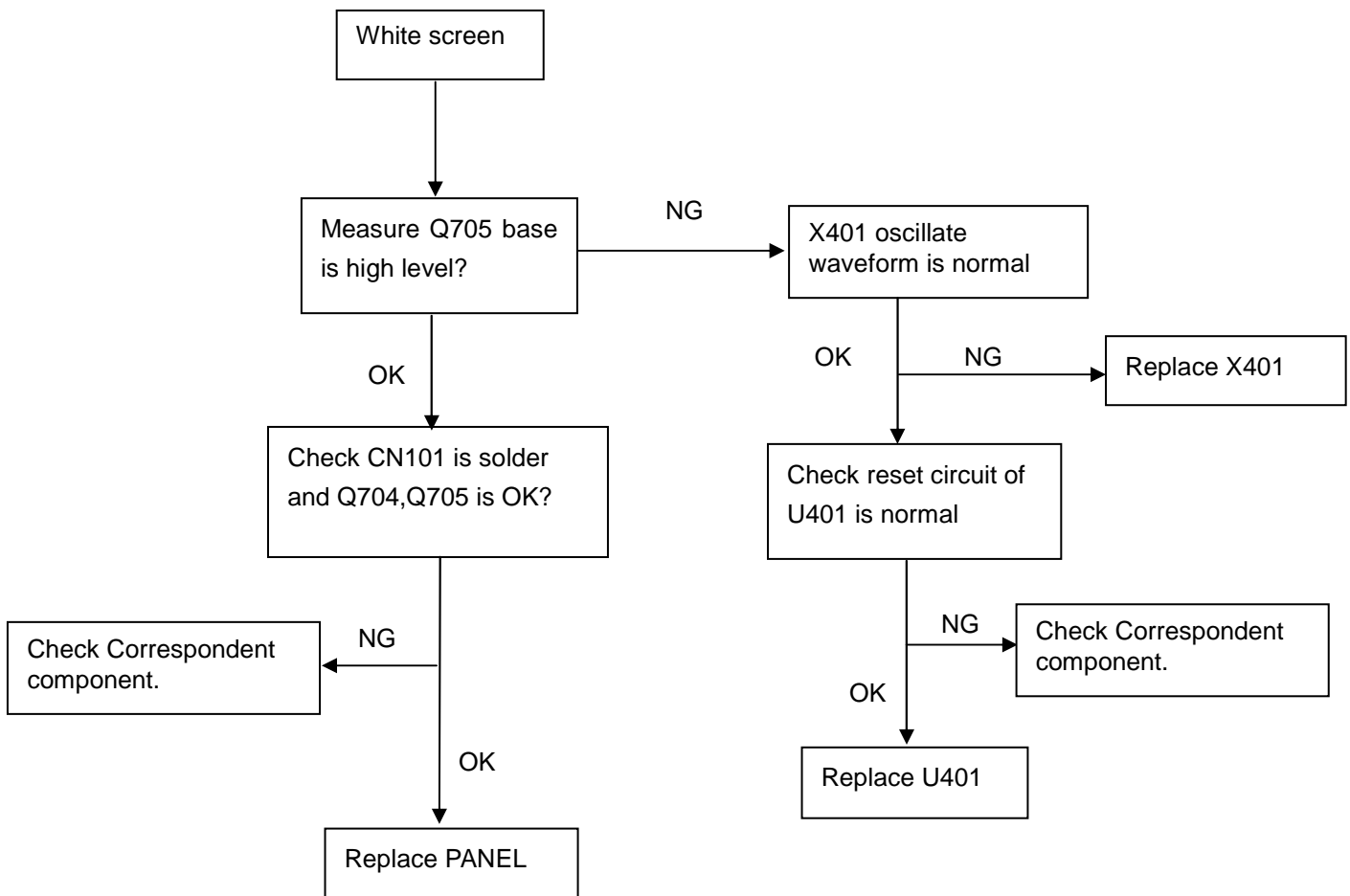

4. Key Board

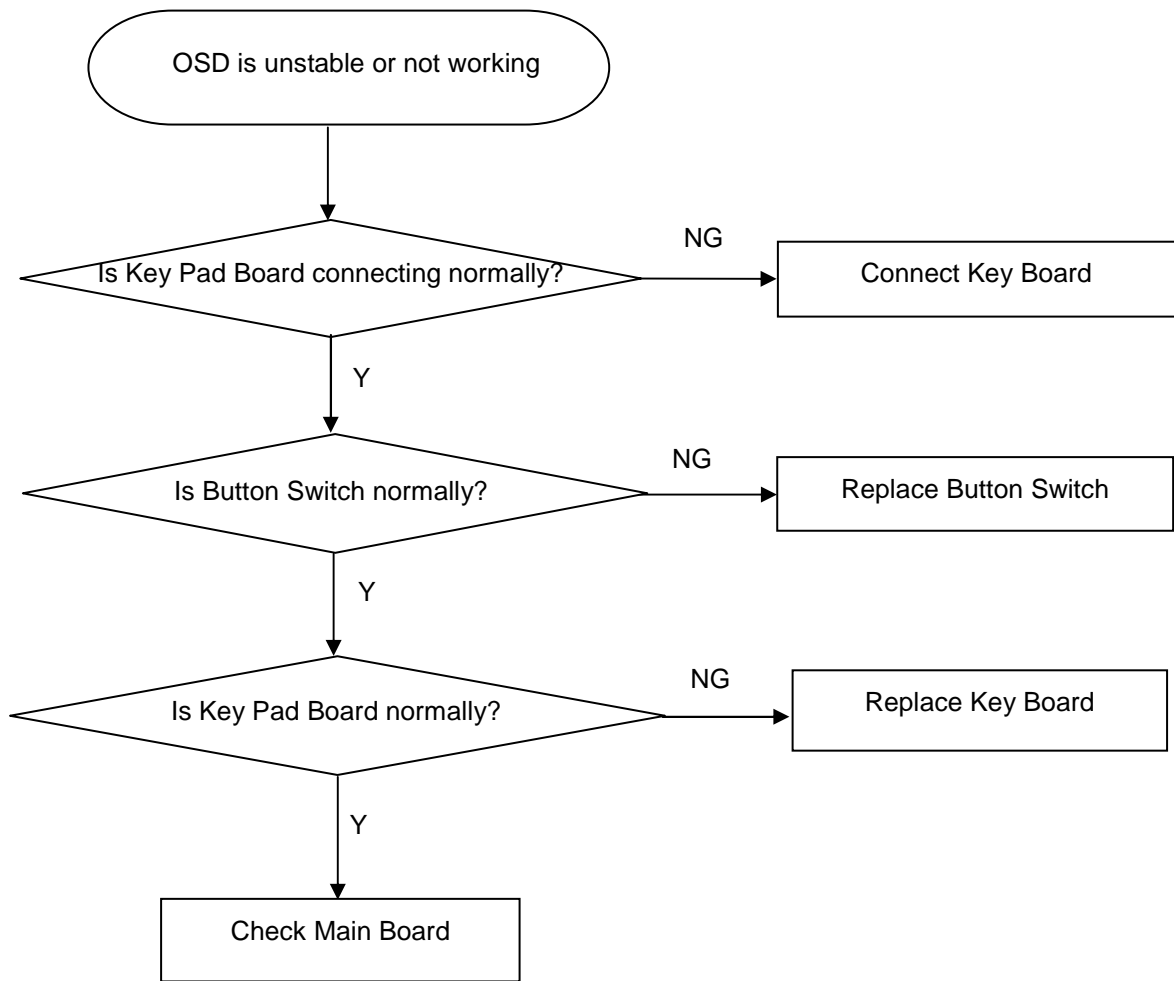

5. Power Board

No power

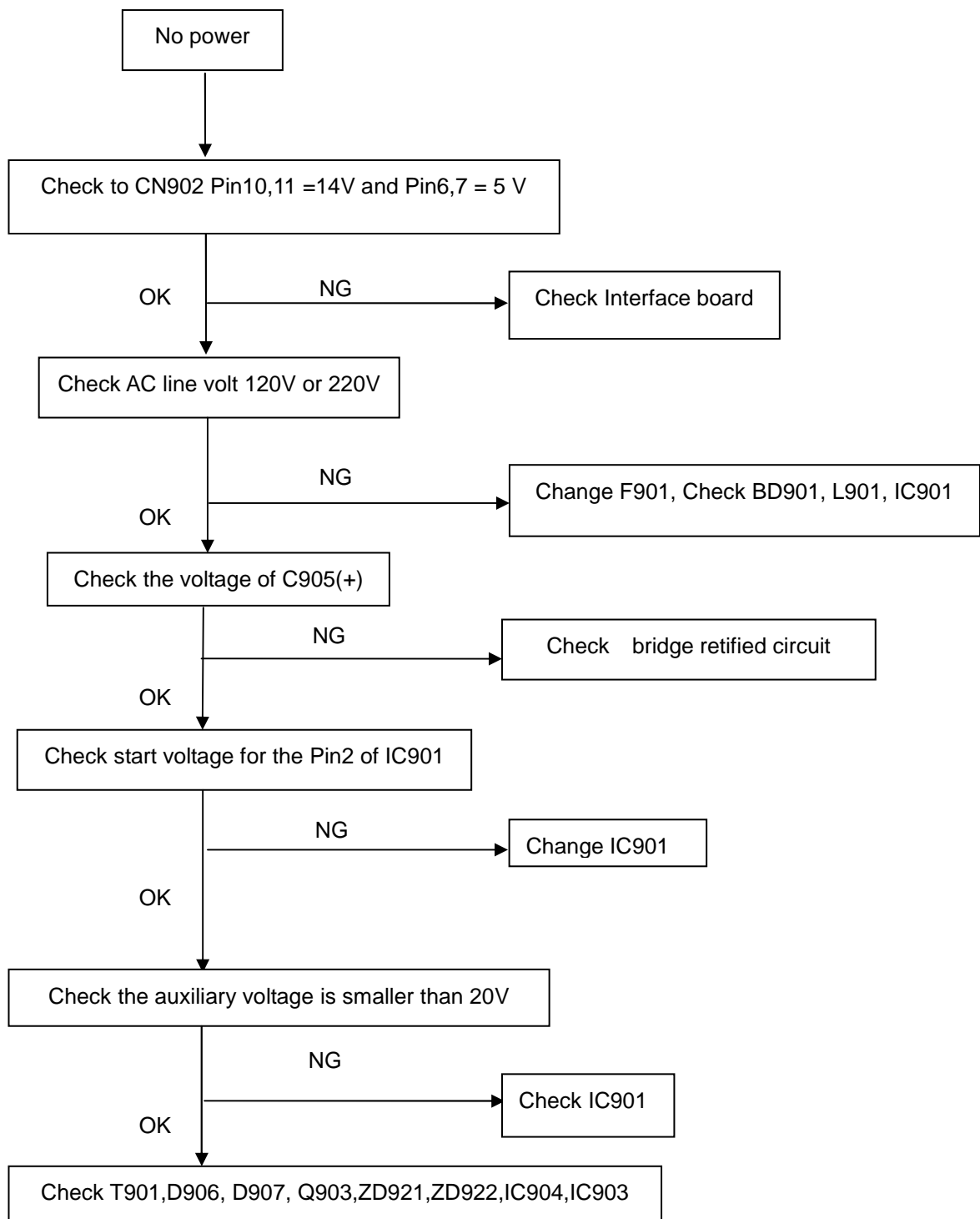

W/LED No Backlight

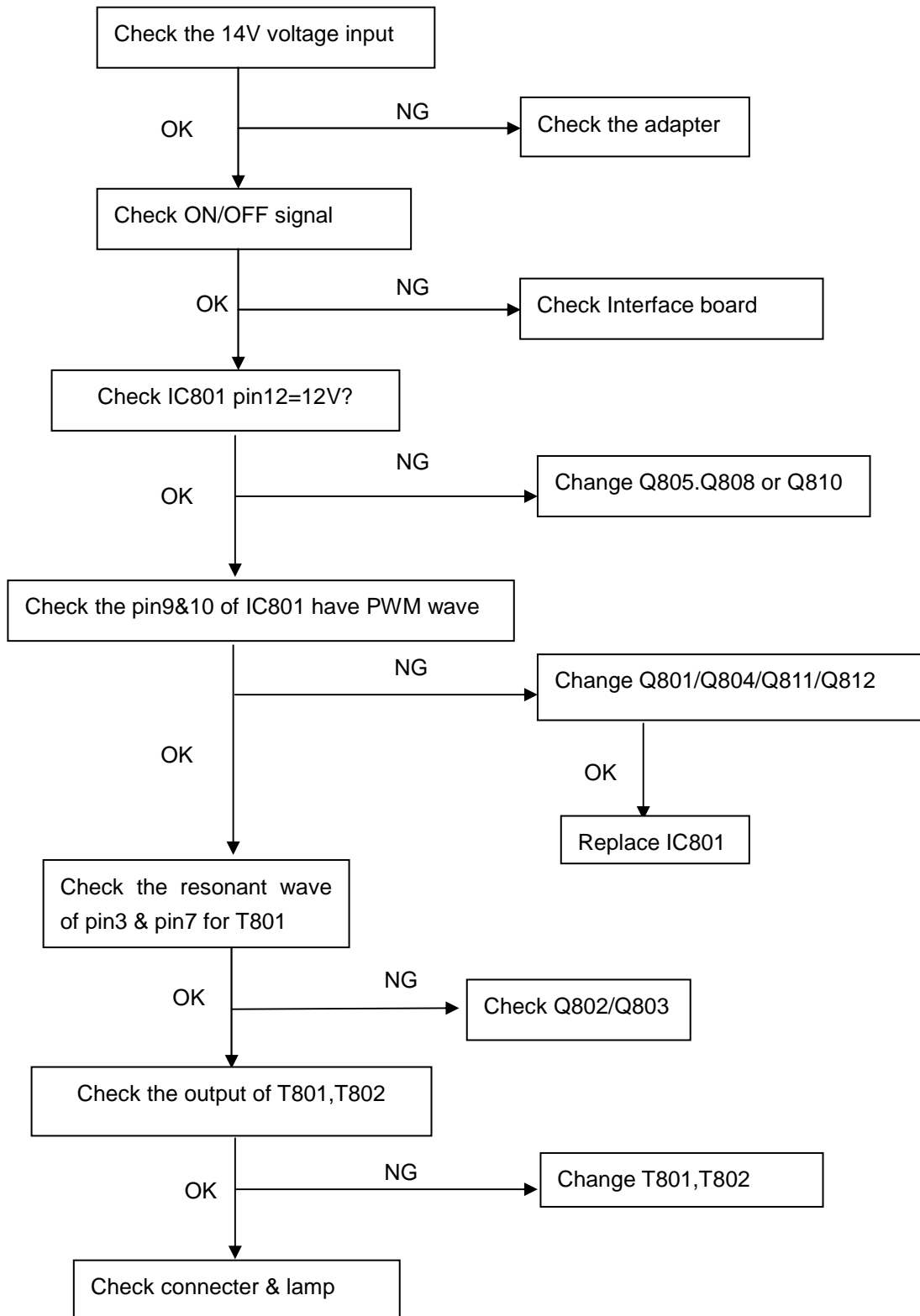

The following figure shows the connector locations on the monitor:

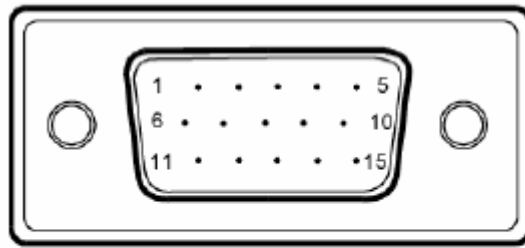

15-Pin Color Display Signal Cable

PIN NO.	DESCRIPTION	PIN NO.	DESCRIPTION
1.	Red	9.	+5V
2.	Green	10.	Logic Ground
3.	Blue	11.	Monitor Ground
4.	Monitor Ground	12.	DDC-Serial Data
5.	DDC-return	13.	H-Sync
6.	R-Ground	14.	V-Sync
7.	G-Ground	15.	DDC-Serial Clock
8.	B-Ground		

This chapter gives you the FRU (Field Replaceable Unit) listing in global configurations of V223W. Refer to this chapter whenever ordering for parts to repair or for RMA (Return Merchandise Authorization).

NOTE: Please note WHEN ORDERING FRU PARTS, that you should check the most up-to-date information available on your regional web or channel (<http://aicsl.acer.com.tw/spl/>). For whatever reasons a part number change is made, it will not be noted in the printed Service Guide. For ACER AUTHORIZED SERVICE PROVIDERS, your Acer office may have a DIFFERENT part number code from those given in the FRU list of this printed Service Guide. You MUST use the local FRU list provided by your regional Acer office to order FRU parts for repair and service of customer machines.



NOTE: To scrap or to return the defective parts, you should follow the local government ordinance or regulations on how to dispose it properly, or follow the rules set by your regional Acer office on how to return it.

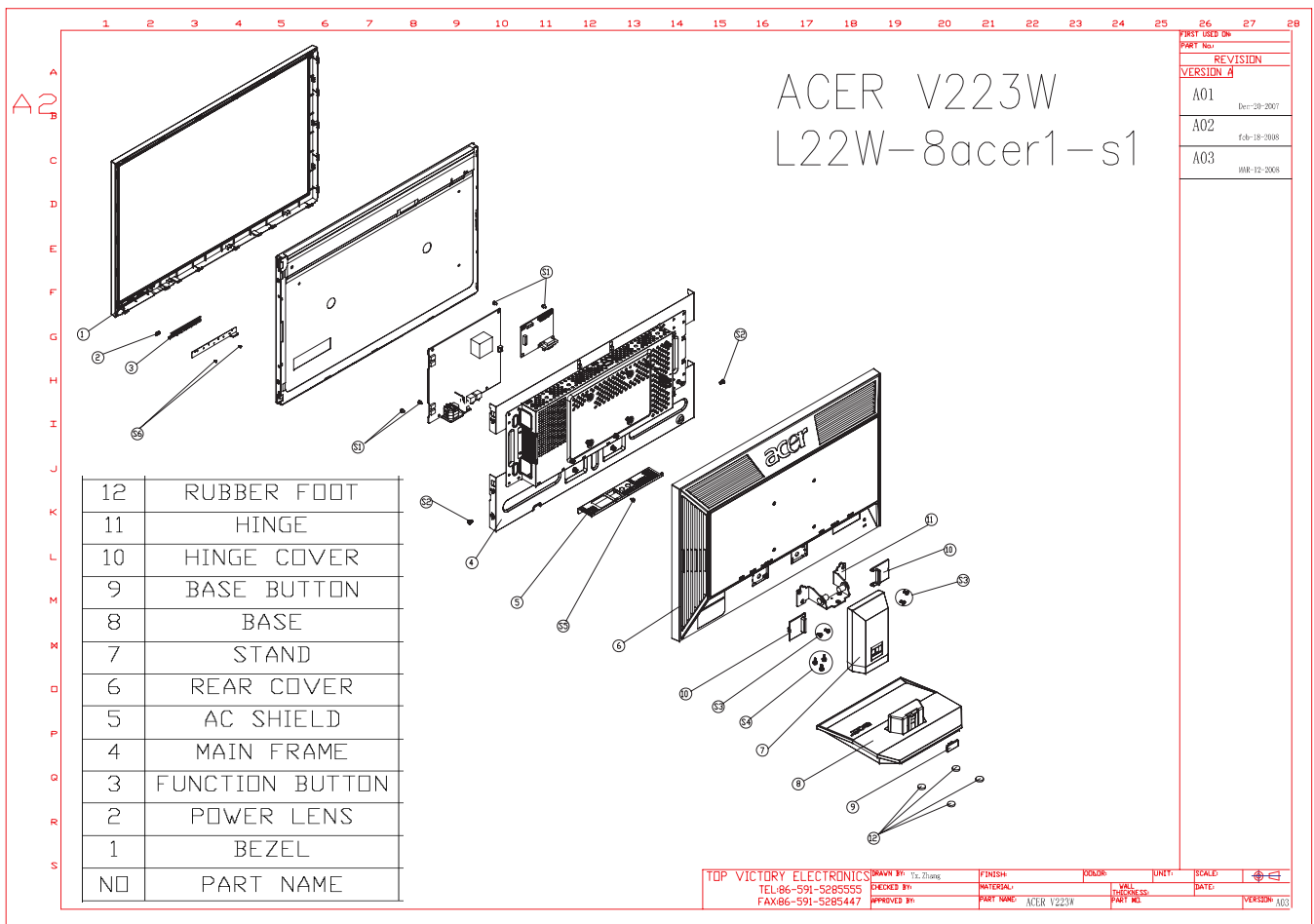

Exploded Diagram (Model: V223W)

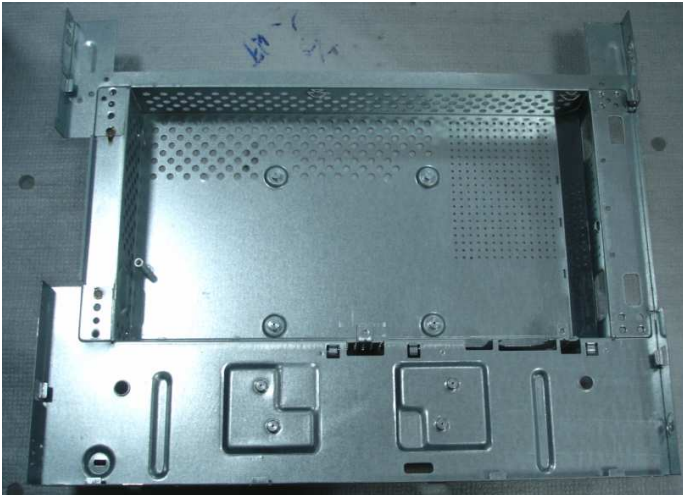

Part List

Above picture show the description of the following component.

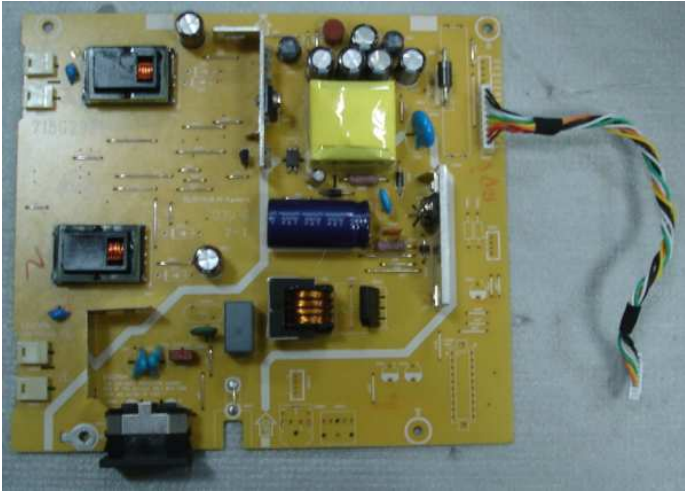
Item	Picture	Description
1		Base
2		Main Frame
4		Panel

5		Power Board
6		Main Board

Main Board

move FB403 FB404 FB405 to CN403

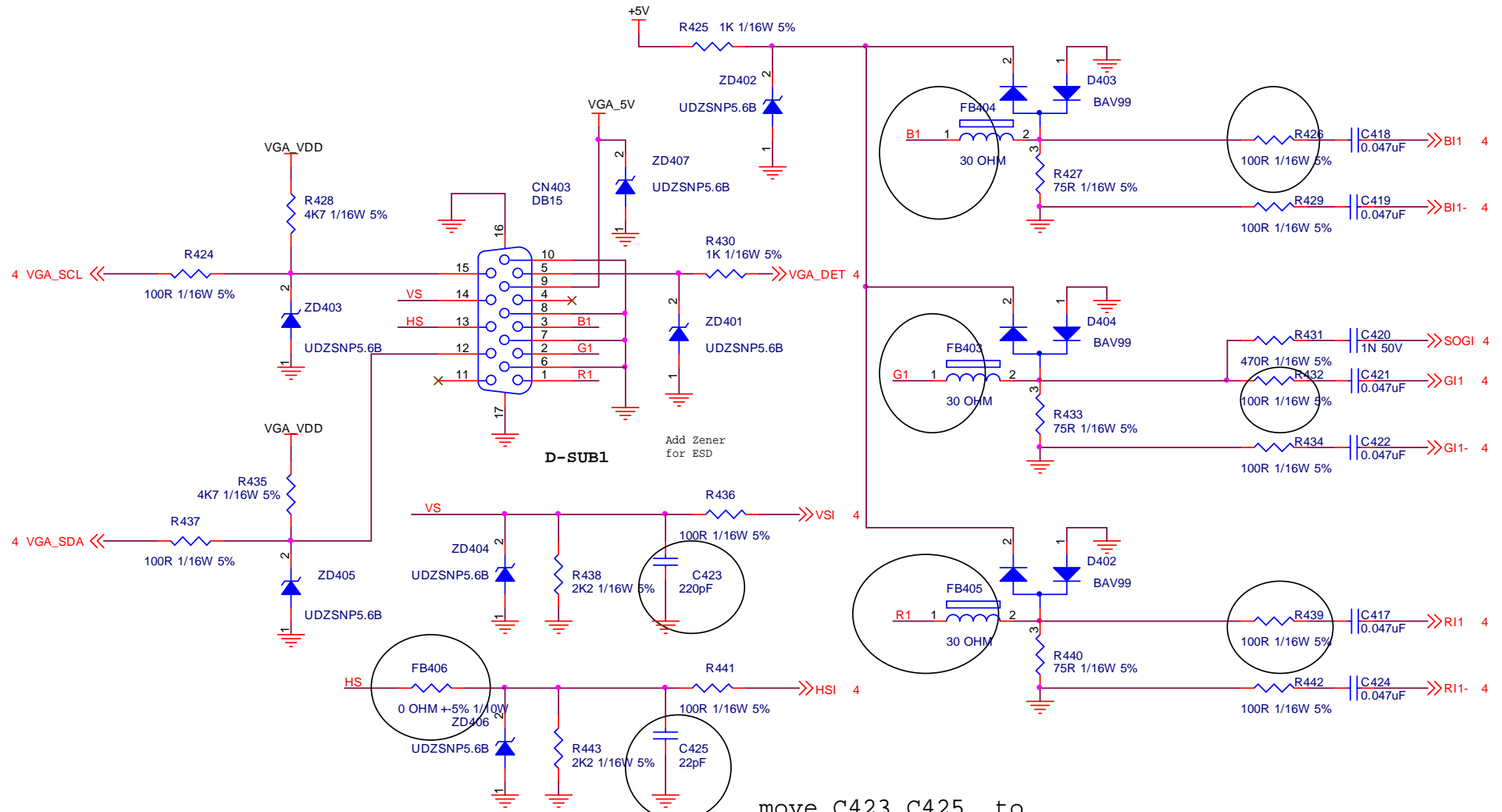

move C423 C425 to R438 R443

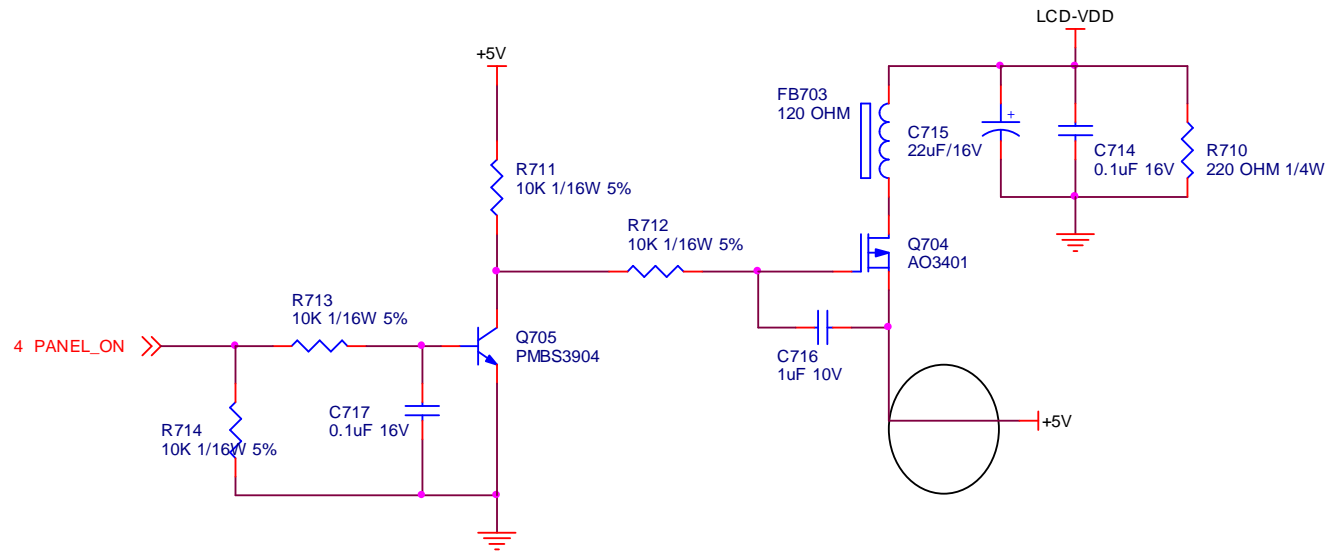
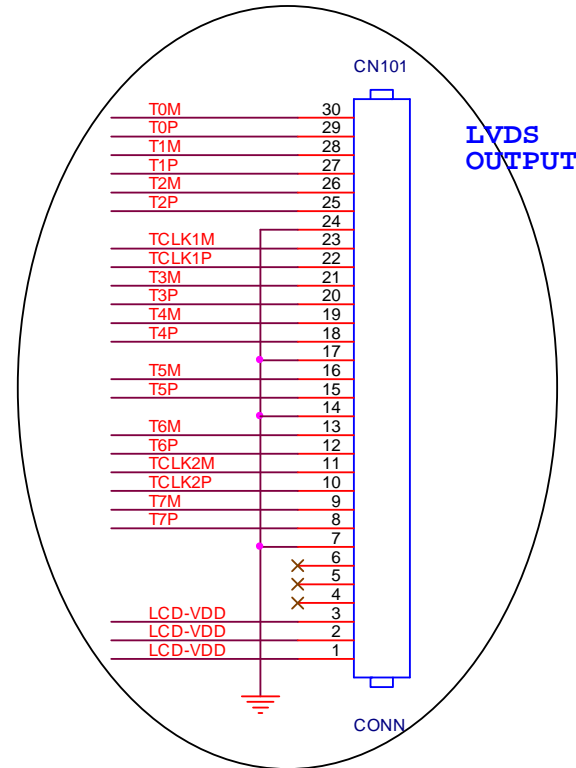
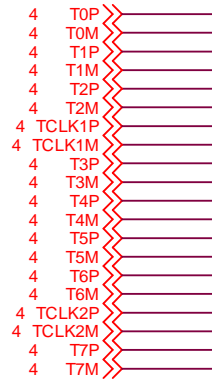

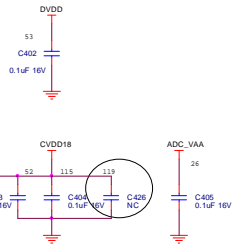

NO.	PARTS	NONE OD	OD
1	U401	NT68665	NT68670
2	R444	0R	NC
3	R445	NC	0R
4	C426	NC	0.1u
5	R422	100R	NC
6	R447	0R	NC
7	R448	NC	0R
8	C427	NC	0.1u

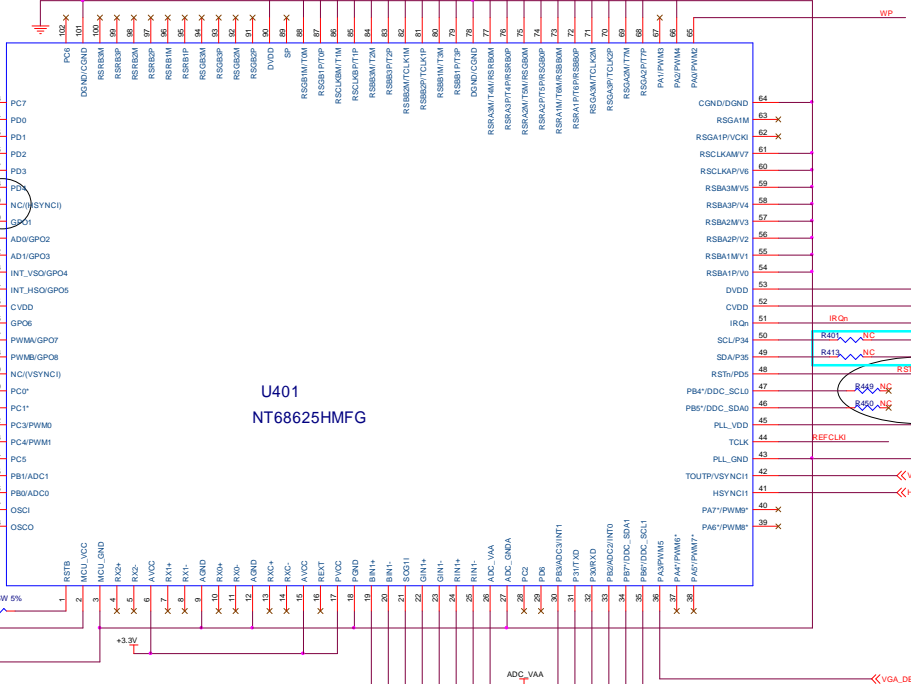
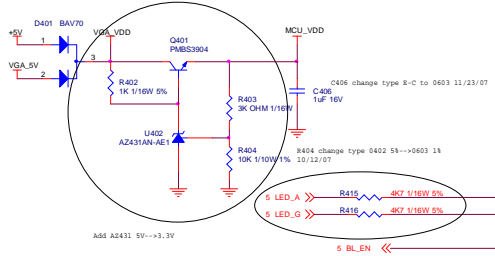
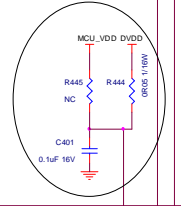

U401
NT68625HMF6

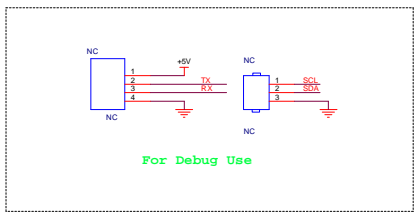
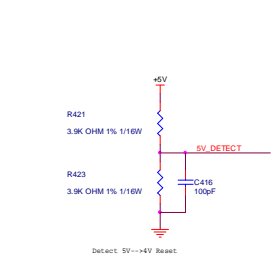
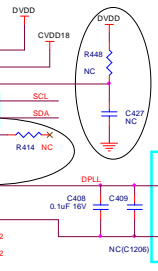
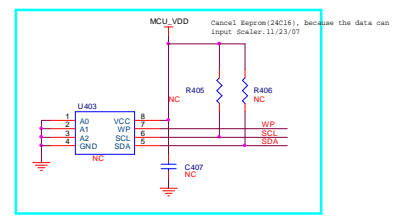

- 2 BH1 >>
- 2 BH1 >>
- 2 SOGI >>
- 2 G11 >>
- 2 G11 >>
- 2 R11 >>
- 2 R11 >>

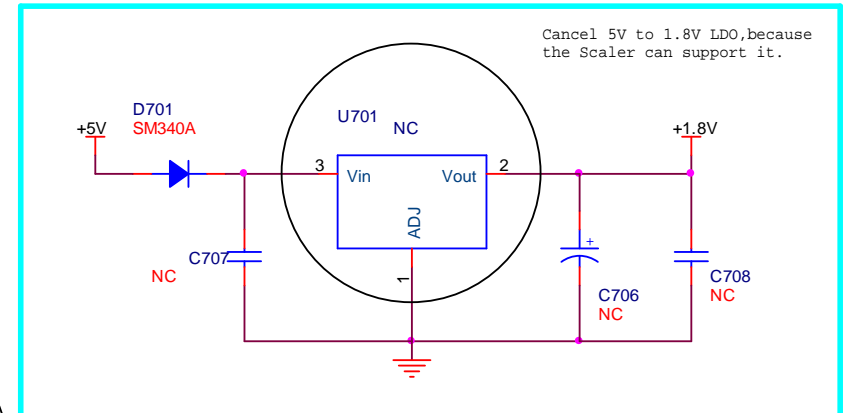
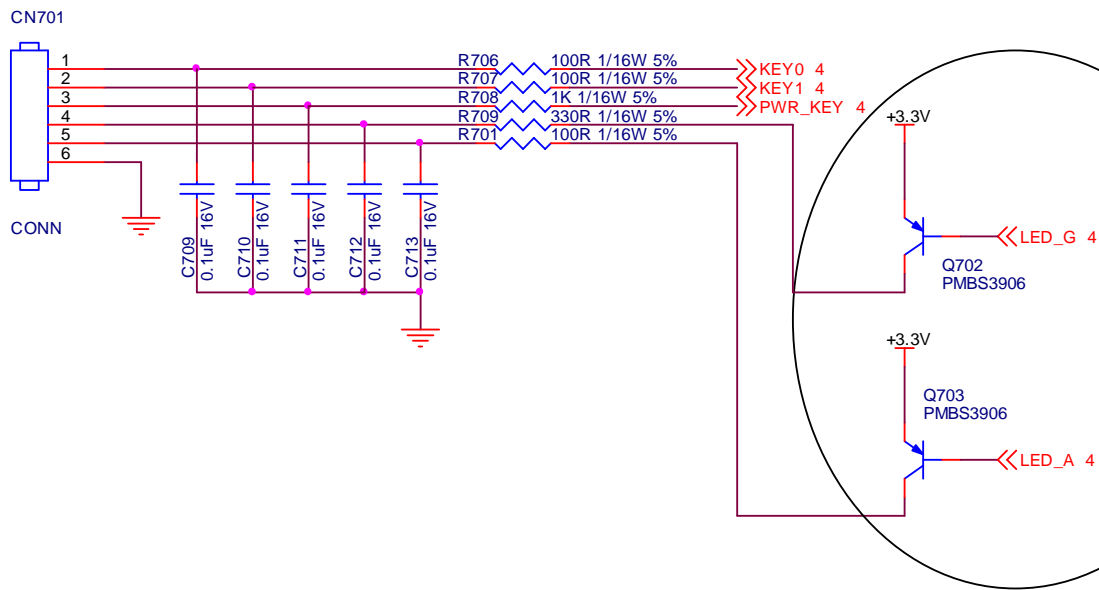
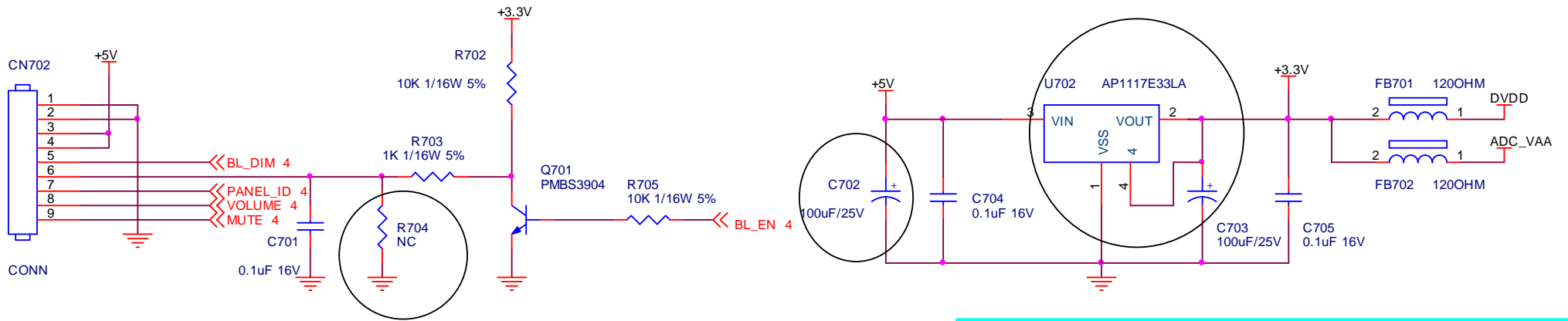

Power board

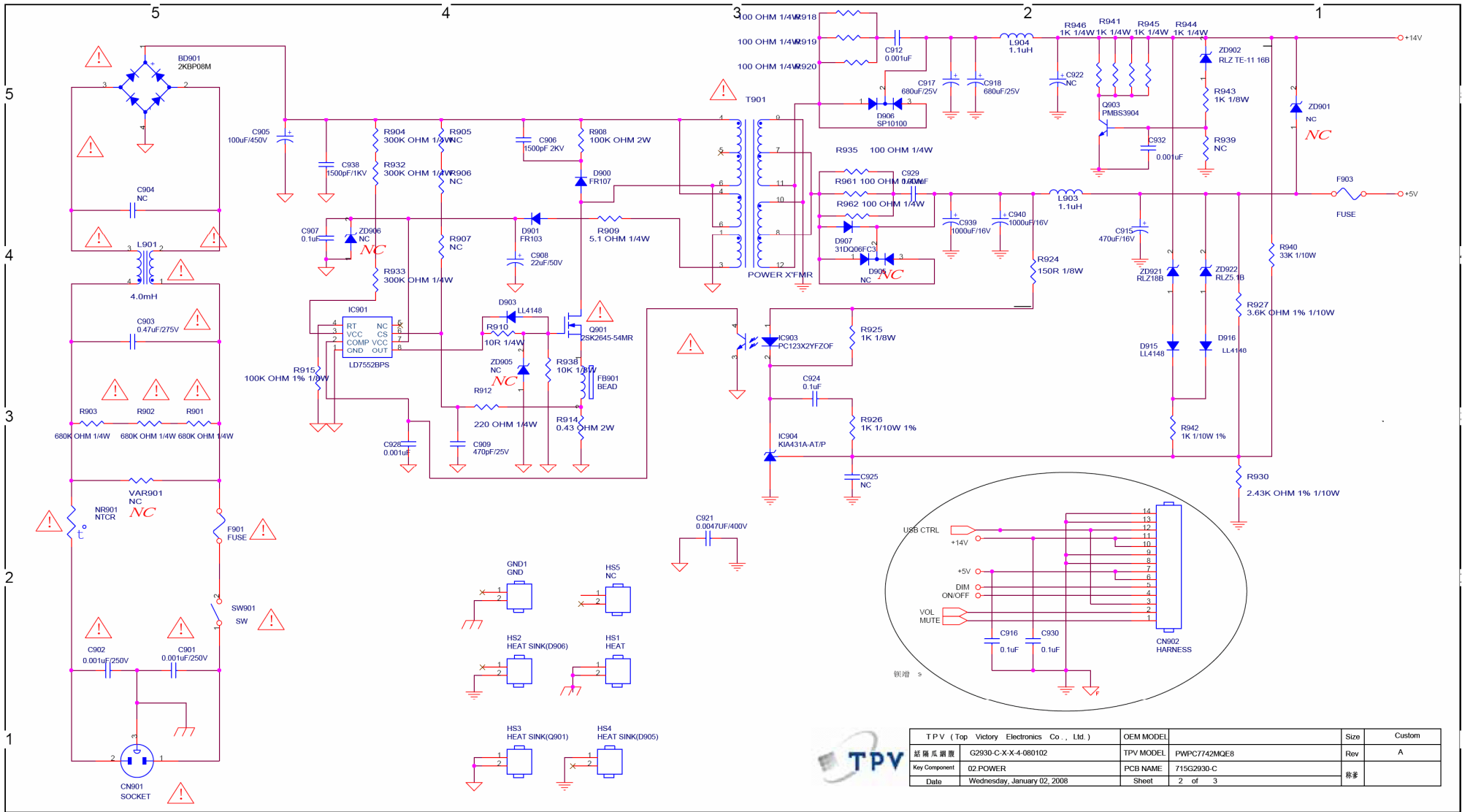

TPV (Top Victory Electronics Co., Ltd.)		OEM MODEL	Size	Custom	
客戶編號	G2930-C-X-4-080102	TPV MODEL	PWPC7742MQE8	Rev	A
Key Component	02.POWER	PCB NAME	715G2930-C	修版	
Date	Wednesday, January 02, 2008	Sheet	2 of 3		

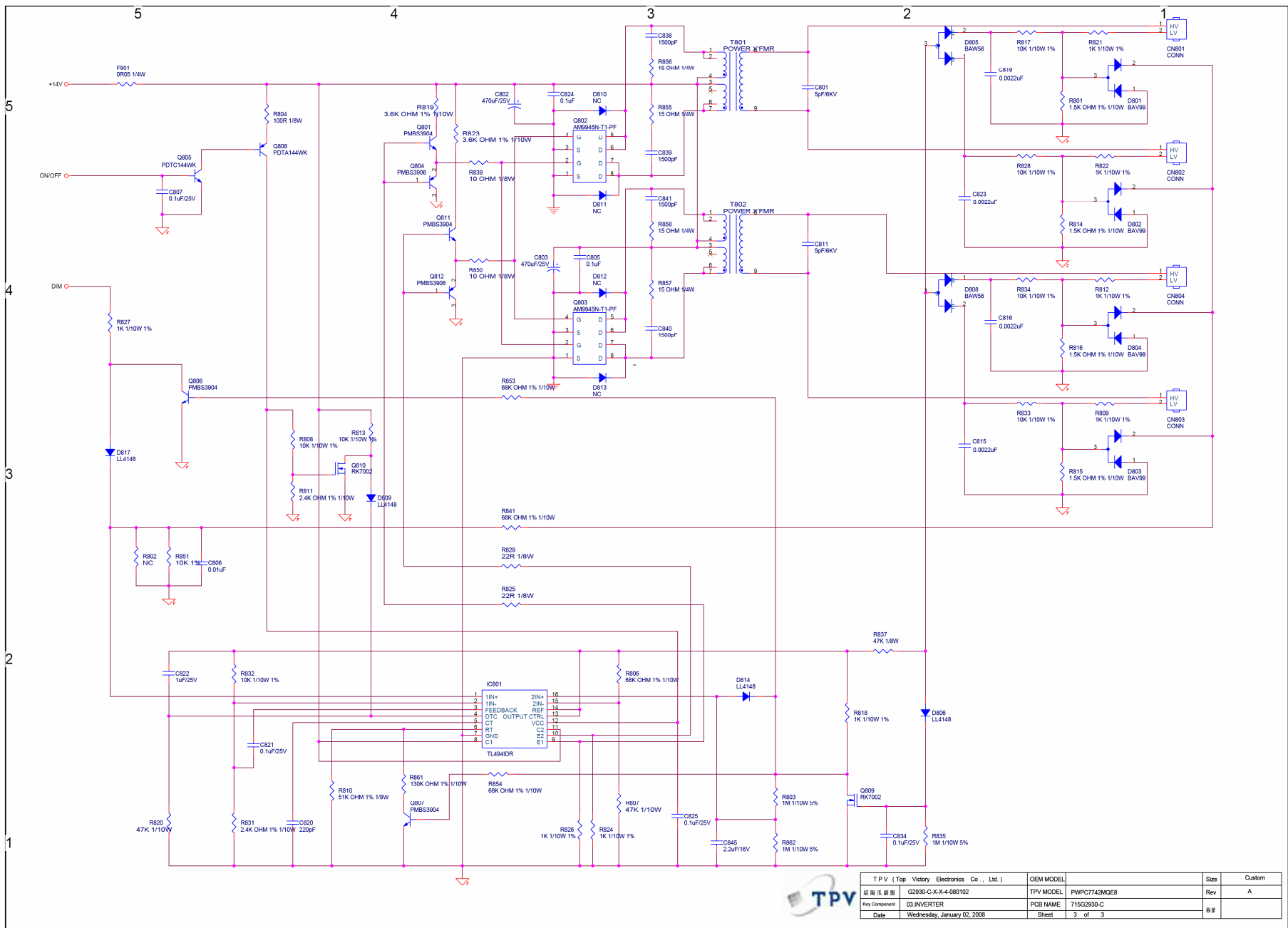

T P V (Top Victory Electronics Co., Ltd.)	OEM MODEL		Size	Custom
新南成 廣興	G2930-C-X-4-080102	TPV MODEL	PWPC742MCE8	Rev
Key Component	03.INVERTER	PCB NAME	715Q2930-C	A
Date	Wednesday, January 02, 2008	Sheet	3 of 3	頁#

Key board

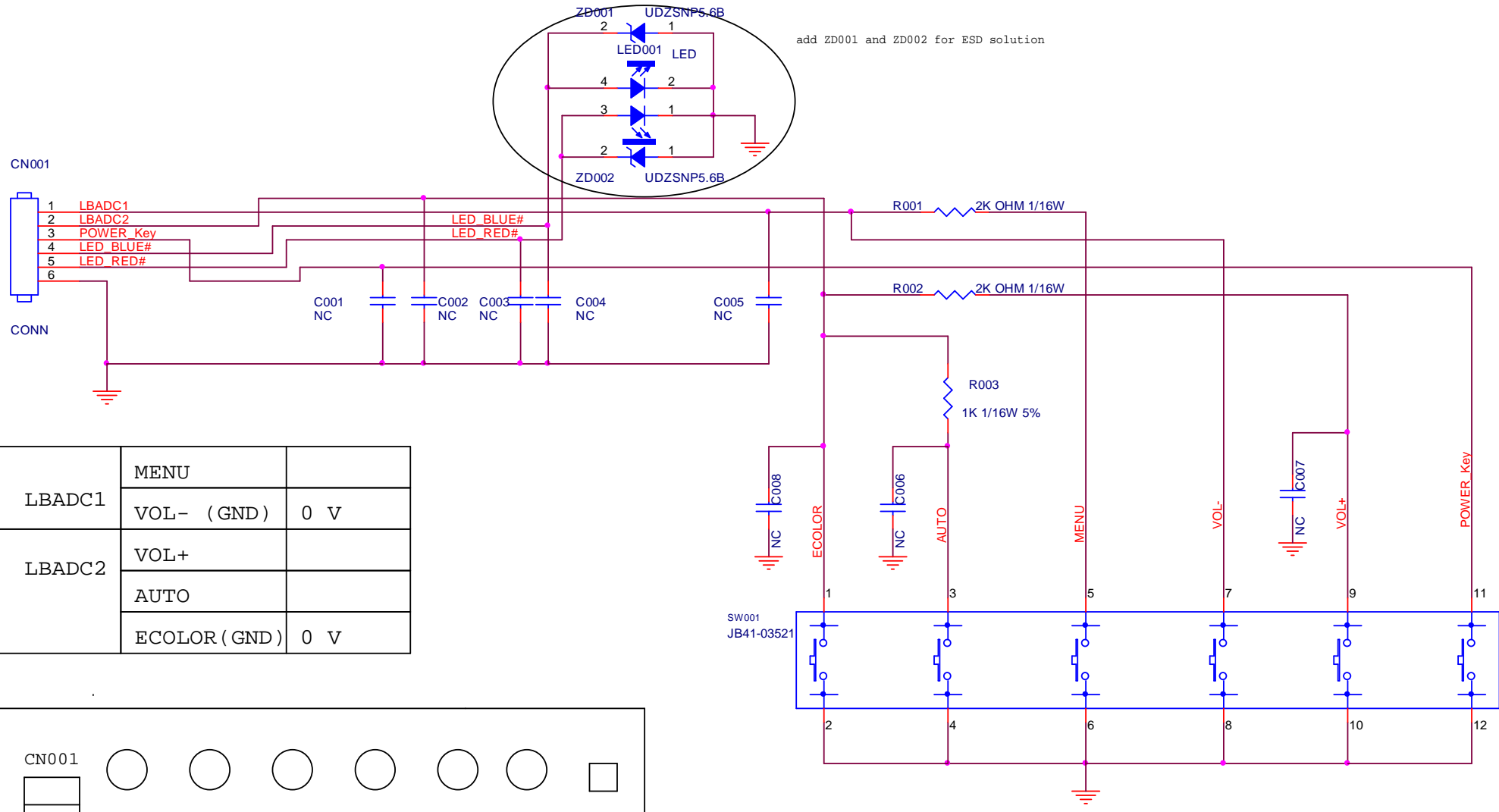

add ZD001 and ZD002 for ESD solution

LBADC1	MENU	
	VOL- (GND)	0 V
LBADC2	VOL+	
	AUTO	
	ECOLOR (GND)	0 V

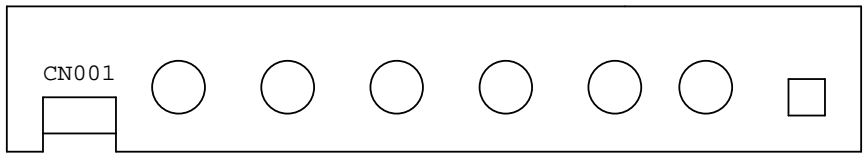

CONNECTOR ECOLOR AUTO MENU VOL- VOL+ POWER LED

Free Manuals Download Website

<http://myh66.com>

<http://usermanuals.us>

<http://www.somanuals.com>

<http://www.4manuals.cc>

<http://www.manual-lib.com>

<http://www.404manual.com>

<http://www.luxmanual.com>

<http://aubethermostatmanual.com>

Golf course search by state

<http://golfingnear.com>

Email search by domain

<http://emailbydomain.com>

Auto manuals search

<http://auto.somanuals.com>

TV manuals search

<http://tv.somanuals.com>