



MODEL 3500

6.5 HP Generator

Item # 56352
Owner's Manual
Manual del Propietario



DO NOT RETURN TO STORE

**Questions? Problems?
Please call our customer help line:**

(888) 315-3080 M-F 8-5 CST

FEATURES

- 3500 Surge Watt Output
- 3000 Rated Watt Output
- Powerful Enough to Run Essential Appliances During Power Outages
- 120 and 240 Volt AC Outputs
- Low Oil Automatic Shutoff
- Circuit Breaker for Overload Protection
- 4 Gallon Fuel Tank Capacity
- Engine Hour Counter
- Cigarette Lighter Style 12V DC Outlet
- Spark Arrester
- Meets EPA Emission Standards

GENERATOR IDENTIFICATION

For information and questions, please contact the Customer Service Help Line by calling **888-315-3080**. Certain information will be requested by the Customer Service Representative and to facilitate that, please fill in the information below.

Refer to the illustration below for the location of Serial Number. Record generator information in the spaces provided below.

DATE OF PURCHASE: _____

PURCHASED FROM: _____

GENERATOR MODEL NUMBER: _____

ENGINE SERIAL NUMBER: _____



ENGINE SERIAL NUMBER

SERVICE RECORD

Record Service Dates:

	Date	Date	Date	Date	Date	Date
Oil Change						
Change spark plug						
Clean Fuel Tank						
Clean Filter Cup						
Clean Air Cleaner						

TABLE OF CONTENTS

GENERATOR IDENTIFICATION	i
SERVICE RECORD	i
INTRODUCTION	1
SAFETY INFORMATION.....	2
GENERAL SAFETY PROCEDURES	3
IMPORTANT SAFETY INSTRUCTIONS	5
PACKAGE CONTENTS	8
GENERATOR COMPONENTS.....	9
ASSEMBLY	10
Attach Feet.....	10
Attach Handles	11
Attach Wheels.....	11
GENERATOR PREPARATION	13
Using the Generator for the First Time	13
Step 1 - Fill Oil	13
Step 2- Add Gasoline.....	14
Step 3- Ground the Generator.....	15
STARTING THE GENERATOR.....	16
SUBSEQUENT STARTING OF THE GENERATOR.....	17
Step 1- Check the Oil.....	17
Step 2 – Check the Fuel Level.....	18
Step 3- Ground the Generator.....	18
USING THE GENERATOR	19
AC Usage.....	19
DC Usage.....	22
STOPPING THE GENERATOR	22
MAINTENANCE / CARE	23
Cleaning the Generator	23
Checking the Oil.....	23
Changing/ Adding Oil	24
Air Cleaner Maintenance.....	25
Fuel Filter Cup Cleaning	25
Spark Plug Maintenance.....	26
Draining the Fuel Tank.....	26
STORAGE / TRANSPORT PROCEDURES	27
SPECIFICATIONS	28
TROUBLESHOOTING	29
EXPLODED VIEW AND PARTS LIST	30
WIRING DIAGRAM	34
WARRANTY STATEMENT	36

INTRODUCTION

Thank You for Purchasing a WEN Power™ Product.

This manual provides information regarding the safe operation and maintenance of this product. Every effort has been made to ensure the accuracy of the information in this manual. WEN Power™ reserves the right to change this product and specifications at any time without prior notice.

Please keep this manual available to all users during the entire life of the generator.

Special Messages

This manual contains special messages to bring attention to potential safety concerns, generator damage as well as helpful operating and servicing information. Please read all the information carefully to avoid injury and machine damage.



Questions? Problems?

DO NOT RETURN TO STORE

Store personnel where the generator was purchased are not trained to handle technical questions or problems.

In order to answer questions and solve problems in the most efficient and speedy manner, contact Customer Service at:

(888) 315-3080 M-F 8-5 CST

NOTICE REGARDING EMISSIONS

Engines that are certified to comply with U.S. EPA emission regulations for SORE (Small Off Road Equipment), are certified to operate on regular unleaded gasoline, and may include the following emission control systems: (EM) Engine Modifications and (TWC) Three-Way Catalyst (if so equipped).

SAFETY INFORMATION

Before operating this generator read and observe all warnings, cautions, and instructions on this sheet, on the generator, and in the Owner's Manual.

NOTE: The following safety information is not meant to cover all possible conditions and situations that may occur. Read the entire Owner's Manual for safety and operating instructions. Failure to follow instructions and safety information could result in serious injury or death.

This safety alert symbol is used to identify safety information about hazards that can result in personal injury.



A signal word (**DANGER**, **WARNING**, or **CAUTION**) is used with the alert symbol to indicate the likelihood and the potential severity of injury. In addition, a hazard symbol may be used to represent the type of hazard.



DANGER indicates a hazard, which, if not avoided, **will result in death or serious injury**.



WARNING indicates a hazard, which, if not avoided, **could result in death or serious injury**.



CAUTION indicates a hazard, which, if not avoided, **might result in minor or moderate injury**.

CAUTION, when used **without** the alert symbol, indicates a situation that **could result in damage to the engine or generator**.

SAFETY SYMBOLS AND MEANINGS

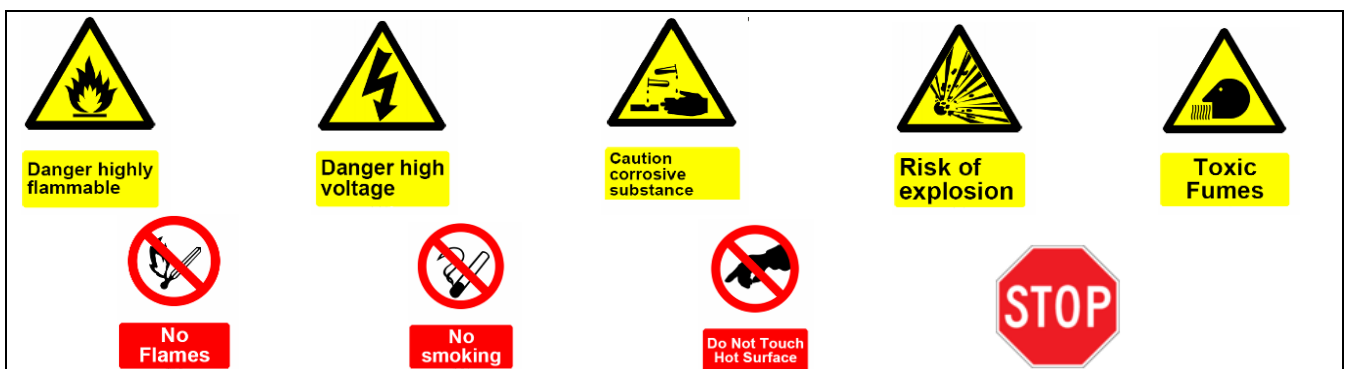

GENERAL SAFETY PROCEDURES



For any questions regarding the hazard and safety notices listed in this manual or on the product, please call (888) 315-3080 M-F 8-5 CST before using the generator.



DANGER: CARBON MONOXIDE. Using a generator indoors **CAN KILL YOU IN MINUTES.**

Generator exhaust contains carbon monoxide (CO). This is a poison gas you cannot see or smell. If you can smell the generator exhaust, you are breathing CO. But even if you cannot smell the exhaust, you could be breathing CO.

- **NEVER** use a generator inside homes, garages, crawlspaces, or other partly enclosed areas. Deadly levels of carbon monoxide can build up in these areas. Using a fan or opening windows and doors does **NOT** supply enough fresh air.
- **ONLY** use a generator outside and far away from windows, doors, and vents. These openings can pull in generator exhaust.

Even if you use a generator correctly, CO may leak into the home. **ALWAYS** use a battery-powered or battery-backup CO alarm in the home.

If you start to feel sick, dizzy, or weak after the generator has been running, move to fresh air **RIGHT AWAY**. See a doctor. You may have carbon monoxide poisoning.



WARNING: The exhaust from this product contains chemicals known to the State of California to cause cancer, birth defects, or other reproductive harm.



Risk of explosion



Danger highly flammable



No Flames



No smoking

WARNING: This generator may emit highly flammable and explosive gasoline vapors, which can

cause severe burns or even death, if ignited. A nearby open flame can lead to explosion even if not directly in contact with gasoline.

- Do not operate near open flame.
- Do not smoke near generator.
- Always operate on a firm, level surface.
- Always turn generator off before refueling. Allow generator to cool for at least 2 minutes before removing fuel cap. Loosen cap slowly to relieve pressure in tank.
- Do not overfill fuel tank. Gasoline may expand during operation. Do not fill to the top of the tank. Allow for expansion.
- Always check for spilled fuel before operating.
- Empty fuel tank before storing or transporting the generator.
- Before transporting, turn fuel valve to off and disconnect spark plug wire.



Danger high voltage

WARNING: This generator produces powerful voltage, which can result in electrocution.

- **ALWAYS** ground the generator before using it (see the “Ground the Generator” portion of the “GENERATOR PREPARATION” section).
 - Generator should only be plugged into electrical devices, either directly or with an extension cord. **NEVER** connect to a building electrical system without a qualified electrician. Such connections must comply with local electrical laws and codes. Failure to comply can create a back-feed, which may result in serious injury or death to utility workers.
 - Use a ground fault circuit interrupter (GFCI) in highly conductive areas such as metal decking or steel work. GFCIs are available in-line with some extension cords.
 - Do not use in rainy conditions.
 - Do not touch bare wires or receptacles (outlets).
 - Do not allow children or non-qualified persons to operate.
-



Do Not Touch Hot Surface

WARNING: This generator produces heat when running. Temperatures near exhaust can exceed 150° F (65° C).

- Do not touch hot surfaces. Pay attention to warning labels on the generator identifying hot parts of the machine.
 - Allow generator to cool down after use before touching engine or areas of the generator that become hot during use.
-

CAUTION: Misuse of this generator can damage it or shorten its life.

- Use generator only for its intended purposes.
 - Operate only on dry, level surfaces.
 - Allow generator to run for several minutes before connecting electrical devices.
 - Shut off and disconnect any malfunctioning devices from generator.
 - Do not exceed the wattage capacity of the generator by plugging in more electrical devices than the unit can handle.
 - Do not turn on electrical devices until *after* they are connected to the generator.
 - Turn off all connected electrical devices before stopping the generator.
 - Turn engine switch to “off” position when the engine is not running.
-

IMPORTANT SAFETY INSTRUCTIONS

- **SAVE THESE INSTRUCTIONS** – This manual contains important instructions for WEN 3500 generator that should be followed during installation and maintenance of the generator.
- Generators vibrate in normal use. During and after the use of the generator, inspect the generator as well as extension and power supply cords connected to it for damage resulting from vibration. Have damaged items repaired or replaced as necessary. Do not use plugs or cords that show signs of damage such as broken or cracked insulation or damaged blades.
- For power outages, permanently installed stationary generators are better suited for providing backup power to the home. Even a properly connected portable generator can become overloaded. This may result in overheating or stressing the generator components, possibly leading to a generator failure.
- **WARNING:** When this generator is used to supply a building wiring system: Generator must be installed by a qualified electrician and connected to a transfer switch as a separately derived system in accordance with the National Electrical Code, NFPA 70. The generator shall be connected to a transfer switch that switches all conductors other than the equipment grounding conductor. The frame of the generator shall be connected to an approved grounding electrode.

In addition to the previous safety notices, please become familiar with the safety and hazard markings on the generator.

RATED WATTAGE	3000W	IMPORTANT BEFORE STARTING 1. Make sure unit is properly grounded. 2. Check that crankcase is sufficiently filled with oil. 3. Turn off or unplug all devices connected to generator.	OPERATION SUMMARY 1. Move switch to ON position. 2. Turn fuel valve to ON position. 3. Move choke lever to start position. 4. Pull start cord to start engine. 5. If engine fails to start, adjust choke and pull cord again. 6. Allow generator to run for several minutes before connecting devices.	CAUTION DO NOT OVERLOAD GENERATOR (SEE MANUAL). DO NOT CONNECT TO ANY BUILDING ELECTRICAL SYSTEM.
RATED VOLTAGE	240/120V			
RATED AMPERAGE	12.5A/25A			
RATED FREQUENCY60HZ			
DC OUTPUT	12V/8.3A			
PHASE	SINGLE			

⚠ DANGER Using a generator indoors CAN KILL YOU or SUFFOCATE. Generator exhaust contains carbon monoxide. This is a poison gas you cannot see or smell. 	⚠ DANGER L'utilisation de ce générateur à l'intérieur d'un bâtiment peut vous tuer ou vous étouffer. Les émissions d'un générateur contiennent du monoxyde de carbone. C'est un gaz invisible et inodore. 	⚠ PELIGRO El uso de este generador dentro de una casa o un garaje es un peligro de muerte o asfixia. Los gases de escape del generador contienen monóxido de carbono. Este es un gas invisible que usted no puede ver ni oler. 	⚠ WARNING To reduce the risk of injury user must read and understand instruction manual. Failure to follow these instructions may result in property damage, serious injury, or even death. • Check for spilled fuel and fuel leaks. • Do not operate until near flammable materials. Never smoke near unit. • Gasoline and its vapors are extremely flammable. Allow engine to cool at least thirty minutes before refueling. • Transfer switch must be used when connecting generator to a building's electrical system. See instruction manual. • Muffler area temperature may exceed 60° C. (150° F) DO NOT TOUCH HOT PARTS. • Never operate in wet grass, damp areas, rain, snow, or near water. Keep this unit dry at all times. • Test GFCI before each use. The engine exhaust from this product contains chemicals known to the state of California to cause cancer, birth defects or other reproductive harm.
Never use inside a home or garage, EVEN if doors and windows are open. Only use OUTSIDE and far away from windows, doors and vents.	Neuf utilisez jamais à l'intérieur d'une maison ou d'un garage et ce, même si les portes et fenêtres sont ouvertes.	Ne use nunca el generador dentro de una casa o un garaje, INCLUSO si las puertas y las ventanas están abiertas.	



IMPORTANT

⚡

CONNECT GROUND TO EARTH BEFORE OPERATING

←



CAUTION  
MUFFLER AREA TEMPERATURE
MAY EXCEED 150° F.
DO NOT TOUCH HOT PARTS.

CAUTION  
HIGH TEMPERATURE
DO NOT TOUCH!







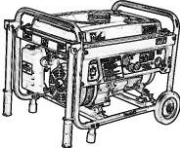

PACKAGE CONTENTS

Your generator comes with the items listed below. Please check to see that all of the following items are included with your generator.

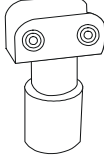
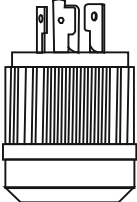

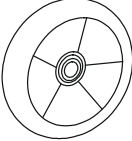
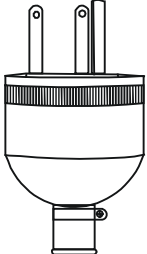
If there are any damaged or missing items, please call (888) 315-3080 M-F 8-5 CST for customer service. DO NOT RETURN TO STORE. Store personnel are not trained to assist with damaged or missing items.

ITEM LIST

 <p style="text-align: right;">Generator</p>	 <p style="text-align: right;">Instruction manual and registration card</p>	 <p style="text-align: right;">Rubber Foot (2pcs)</p>
 <p style="text-align: right;">NEMA L14-30 plug</p>	 <p style="text-align: right;">Set of four wrenches for assembly</p>	 <p style="text-align: right;">Wheel (2pcs)</p>
 <p style="text-align: right;">Three-prong plug</p>	 <p style="text-align: right;">Vinyl Tool Pouch</p>	 <p style="text-align: right;">Wheel kit hardware</p>
 <p style="text-align: right;">Spark plug wrench</p>	 <p style="text-align: right;">Handle (2pcs)</p>	

GENERATOR COMPONENTS

Please familiarize yourself with the locations and functions of the various components and controls of your generator.



(1) Fuel Cap- Access to the fuel tank for adding fuel.

(2) Voltage Selector-To switch between 120 and 240 Volt output.

(3) Circuit Reset Buttons- Reset buttons that protect the generator from electrical overload.

(4) Power Indicator-Green lights that turn on to indicate the output of power to each receptacle.

(5) 240/120 Volt AC Receptacle- To connect electrical devices that run 120 and/or 240 Volt, 60 Hz, single phase, AC current.

(6) Ground Terminal- Connect grounding wires here to properly ground unit.

(7) Engine hour counter.

(8) 120 Volt AC Duplex Receptacle- To connect electrical devices that run 120 Volt, 60 Hz, single phase, AC current.

(9) 12V Cigarette lighter Style DC Receptacle.

(10) Oil Fill and Dipstick- Location for checking and filling engine oil.

(11) Engine Switch- To start/stop engine.

(12) Recoil Starter- Pull-cord for starting engine.

(13) Fuel Filter Cup- Traps dirt from fuel before it enters the engine.

(14) Air Cleaner- A removable, cleanable, sponge-like element that limits the amount of dirt pulled into the engine.

(15) Choke Lever- Adjusts the amount of air let into the engine.

(16) Fuel Valve- Allows fuel to enter engine.

(17) Fuel Gauge- Indicates the amount of fuel in the tank.

(18) Spark Plug- Provides proper engine ignition.

(19) Muffler- Reduces engine noise.

ASSEMBLY

In order to best protect the generator while in the package, this product comes with some components disassembled. Please complete the following assembly steps before proceeding to use the generator. For ease of assembly, we recommend attaching the components in the order listed in this manual.

If after reading this section, you are unsure about how to perform any of the steps, please call (888) 315-3080 M-F 8-5 CST for customer service.



WARNING: This generator is heavy. Some assembly procedures may require lifting equipment or two people.

Attach Feet

To attach the feet to the generator, perform the following steps:

1. Stack the two generator wheels on top of each other. Lift the end of the generator that has the recoil starter onto the stack of wheels (see figure 1). Be careful not to obstruct any holes on the generator frame.
2. Place one leg onto the frame as shown in figure 2. Line up the holes on the generator frame with the holes on the bracket portion of the leg. Tighten using two M6x40 bolts, two M6 nuts, and the included wrench.
3. Repeat step 2 for the other generator leg.



Figure 1- Stacking the wheels

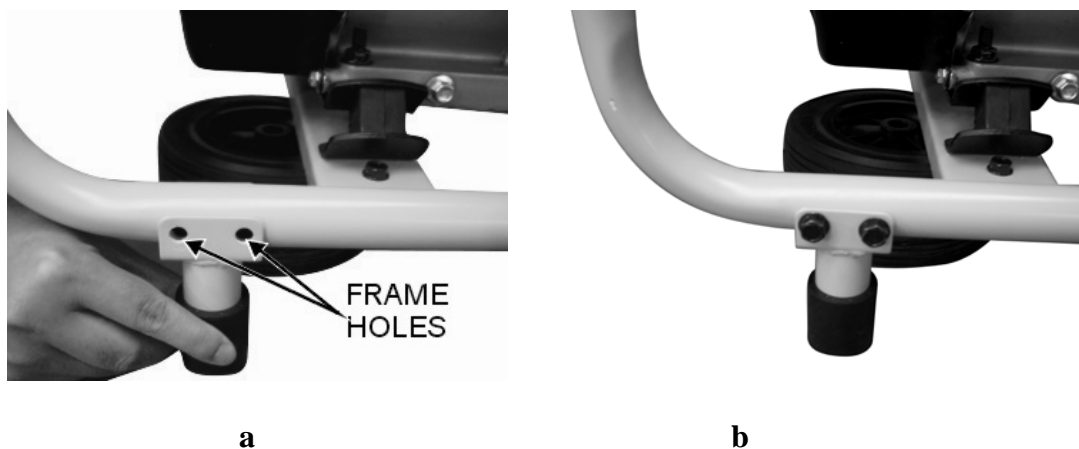

Figure 2- foot assembly

Attach Handles

The handles attach to the same end of the generator as the feet. To attach the handles to the generator, perform the following steps:

1. Place one handle onto the upper portion of the generator frame as shown in figure 3.
2. Slide handle with M8×40 bolt attached through the hole and secure using an M8 nut.
3. Repeat steps 1 and 2 for the other side.

At this point, gently remove the two wheels from underneath the generator.



Figure 3- handle assembly

Attach Wheels

To attach the wheels to the generator, perform the following steps:

1. Find a wood block or similar item that is 3 inches thick or greater and rest the exhaust end of the generator on the block as shown in figure 4.
2. Take one wheel shaft, and one M12 nut as shown. Slide the wheel shaft, with the threaded part facing inward, through the frame. Secure using an M12 nut and the included wrench as shown in figure 5.
3. Slide the wheel onto the axle and secure in place using a large cotter pin as shown in figure 6. Spread the pin legs apart slightly to help secure the pin in place.
4. Repeat steps 2 and 3 for the other wheel.

At this point, the generator assembly is complete. Gently remove the generator from the wood block.

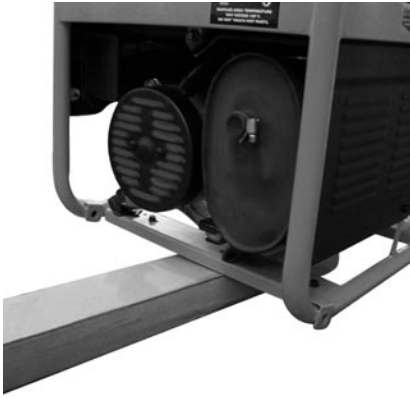

Figure 4- supporting the generator

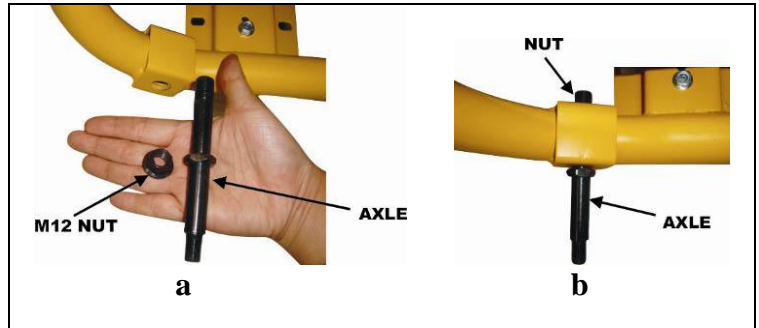

Figure 5- axle assembly

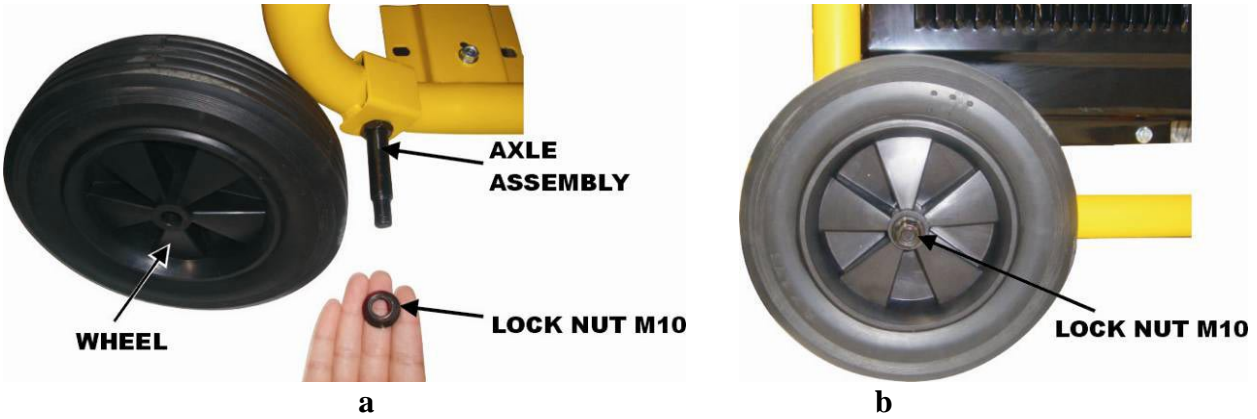

Figure 6- wheel installation

GENERATOR PREPARATION

Using the Generator for the First Time



The following section describes steps necessary to prepare the generator for use. If after reading this section, you are unsure about how to perform any of the steps please call (888) 315-3080 M-F 8-5 CST for customer service. Failure to perform these steps properly can damage the generator or shorten its life.

Step 1 - Fill Oil

The generator is shipped without oil. User must add the proper amount of oil before operating the generator for the first time. The oil capacity of the engine crankcase is 20 fluid oz.

Select good quality detergent oil bearing the American Petroleum Institute (API) service classifications SJ, SL, or SM. (Synthetic oils may be used.) Use the SAE viscosity grade of oil from the following chart that matches the starting temperature anticipated before the next oil changes.

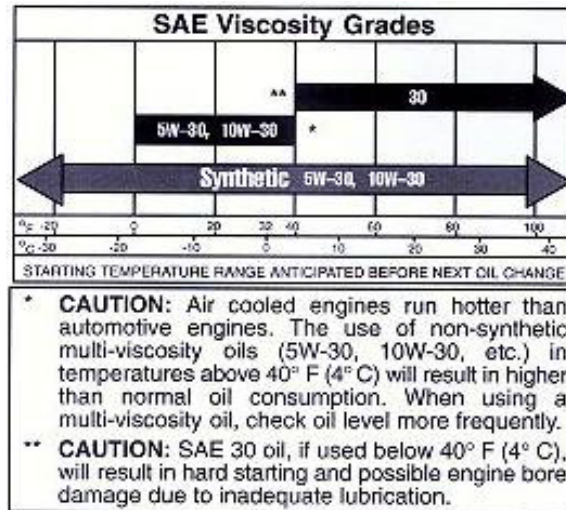

Figure 7- Engine oil recommendations

To fill oil to the crankcase, follow these steps:

1. Make sure the generator is on a level surface. **Tilting the generator to assist in filling will cause oil to flow into engine areas and will cause damage. Keep generator level!**
2. Remove the oil filler/dipstick cap from the engine as shown in figure 8.
3. Using a funnel, add the appropriate type and amount of oil into the crankcase. The crankcase is full when the oil level has reached the second thread from the lip of the opening (see figure 9).
4. Check for oil leaks. Reinstall oil filler cap before starting engine.

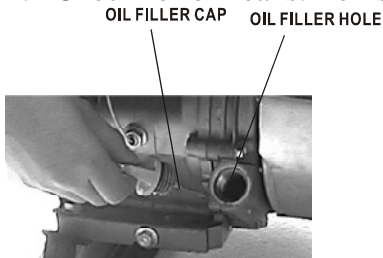

Figure 8- Unscrewing the oil cap



Figure 9- filling oil

Step 2- Add Gasoline



Danger highly flammable



Risk of explosion



No Flames



No smoking

WARNING: This generator may emit highly flammable and explosive gasoline vapors, which can cause severe burns or even death if ignited. A nearby open flame can lead to explosion even if not directly in contact with gasoline.

- Do not operate near open flame.
- Do not smoke near generator.
- Always operate on a firm, level surface.
- Always turn generator off before refueling. Allow generator to cool for at least 2 minutes before removing fuel cap. Loosen cap slowly to relieve pressure in tank.
- Do not overfill fuel tank. Gasoline may expand during operation. Do not fill to the top of the tank. Allow for expansion.
- Always check for spilled fuel before operating. Clean up any spilled fuel before starting.
- Empty fuel tank before storing or transporting the generator.
- Before transporting, turn fuel valve to off position and disconnect spark plug wire.

Use fresh (within 30 days from purchase), unleaded gasoline with a minimum 87 octane rating. Do not use gasoline which contains Methanol. Do not mix oil with gasoline.

To add gasoline, follow these steps:

1. Make sure the generator is on a level surface.
2. Unscrew fuel cap and set aside (NOTE: the fuel cap may be tight and hard to unscrew).
3. Slowly add unleaded gasoline to the fuel tank. Be careful not to overfill. Please refer to the chart in figure 10 for the fuel capacity. The fuel gauge on the top of the generator indicates how much gasoline is in the generator fuel tank. NOTE: **Do not fill the fuel tank to the very top.** Gasoline will expand and spill over during use even with the fuel cap in place.
4. Reinstall fuel cap and wipe off any spilled gasoline with a dry cloth.

IMPORTANT:

- Never use an oil/gasoline mixture.
- Never use old gasoline.
- Avoid letting dirt or water into the fuel tank.
- Gasoline can age in the tank and make it hard to start up the generator in the future. Never store generator for extended periods of time with fuel in the tank.

Model number	3500
Fuel tank capacity	15 L (4 gallons)

Figure 10- Fuel Tank Capacity

Step 3- Ground the Generator



WARNING: Failure to properly ground the generator can result in electrocution.

Ground the generator by tightening the grounding nut against a grounding wire (see figure 11). A generally acceptable grounding wire is a No. 12 AWG (American Wire Gauge) stranded copper wire. This grounding wire should be connected at the other end to a copper or brass grounding rod that is driven into the earth. Wire and grounding rod are not included in generator contents.

Grounding codes can vary by location. Please contact a local electrician to check the grounding regulations for your area.



Figure 11- Grounding nut location

NOTE: After completing the 3-step Generator Preparation, the generator is ready to be started.

STARTING THE GENERATOR



Before starting the generator, make sure you have read and performed the steps in the “Generator Preparation” section of this manual. If you are unsure about how to perform any of the steps in this manual please call (888) 315-3080 M-F 8-5 CST for customer service.



Toxic
Fumes

DANGER: CARBON MONOXIDE. Using a generator indoors **CAN KILL YOU IN MINUTES.**

Generator exhaust contains carbon monoxide (CO). This is a poison gas you cannot see or smell. If you can smell the generator exhaust, you are breathing CO. But even if you cannot smell the exhaust, you could be breathing CO.

- NEVER use a generator inside homes, garages, crawlspaces, or other partly enclosed areas. Deadly levels of carbon monoxide can build up in these areas. Using a fan or opening windows and doors does NOT supply enough fresh air.
- ONLY use a generator outside and far away from windows, doors, and vents. These openings can pull in generator exhaust.

Even if you use a generator correctly, CO may leak into the home. ALWAYS use a battery-powered or battery-backup CO alarm in the home.

If you start to feel sick, dizzy, or weak after the generator has been running, move to fresh air RIGHT AWAY. See a doctor. You may have carbon monoxide poisoning.



Danger high
voltage

WARNING: This generator produces powerful voltage, which can result in electrocution.

- ALWAYS ground the generator before using it (see the “Ground the Generator” portion of the “GENERATOR PREPARATION” section).
- Generator should only be plugged into electrical devices, either directly or with an extension cord. NEVER connect to a building electrical system without a qualified electrician. Such connections must comply with local electrical laws and codes. Failure to comply can create a back-feed, which may result in serious injury or death to utility workers.
- Use a ground fault circuit interrupter (GFCI) in highly conductive areas such as metal decking or steel work. GFCIs are available in-line with some extension cords.
- Do not use in rainy or wet conditions.
- Do not touch bare wires or receptacles (outlets).
- Do not allow children or non-qualified persons to operate.



CAUTION: Disconnect all electrical loads from the generator before attempting to start.

To start your generator, perform the following steps:

1. No electrical devices should be connected to the generator during starting. Devices can make it difficult for the engine to start.
2. Check that the generator is properly grounded (see “Ground the Generator”).
3. Check the oil and fuel levels.
4. Turn the fuel valve to the “on” position (see figure 12).
5. Move the choke lever to the “closed” position (see figure 13).
6. Set the engine switch to the “on” position.
7. Pull on the recoil starter handle slowly until a slight resistance is felt (see figure 14). Then pull quickly to start the engine. Return cord gently into the machine. Never allow the cord to snap back.
8. If engine fails to start, repeat step 7. NOTE: After repeated failed attempts to start the engine, please consult the troubleshooting guide before attempting again. If problems persist please call **(888) 315-3080 M-F 8-5 CST**.
9. Once the engine has started, **slowly** return the choke lever all the way to the “open” position.
10. Allow the generator to run for several minutes before attempting to connect any electrical devices. This allows the generator to stabilize its speed and temperature.

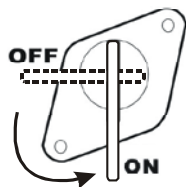

Figure 12- Fuel Valve in the “on” position

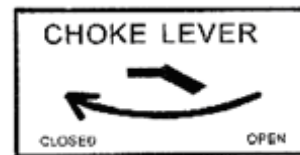

Figure 13- Pull choke out for closed position.
Push in for open position.



Figure 14- Pulling the start cord

SUBSEQUENT STARTING OF THE GENERATOR

If this is not the first time using the generator, user should take the following steps to prepare it for operation.

IMPORTANT: At this point the user should be familiar with the procedures described in the section titled “Using the Generator for the First Time.” If the user has not yet read this section, go back and read it now.

Step 1- Check the Oil

Oil consumption is normal during generator usage. The generator is equipped with a low-oil shutoff to protect it from damage. The oil level in the engine should be checked before each use to ensure that the engine crankcase contains sufficient lubricant.

To check or add oil, follow these steps:

1. Make sure the generator is on a level surface. Clean around oil fill.
2. Remove the oil filler/dipstick cap and check oil level.
3. If oil level is below the second thread from the lip of the oil fill opening, slowly add oil until the engine crankcase is filled.
4. Reinstall and tighten oil filler cap before starting the engine. .

Step 2 – Check the Fuel Level

Before starting the generator, check to see that there is sufficient gasoline in the fuel tank. The fuel gauge on top of the generator will indicate the fuel level in the tank. Add gasoline if necessary but leave sufficient room in tank for expansion.



Danger highly flammable



Risk of explosion



No Flames



No smoking

WARNING: This generator may emit highly flammable and explosive gasoline vapors, which can cause severe burns or even death if ignited. A nearby open flame can lead to explosion even if not directly in contact with fuel.

- Do not operate near open flame.
- Do not smoke near generator.
- Always operate on a firm, level surface.
- Always turn generator off before refueling. Allow generator to cool for at least 2 minutes before removing fuel cap. Loosen cap slowly to relieve pressure in tank.
- Do not overfill fuel tank. Gasoline may expand during operation. Do not fill to the top of the tank. Allow for expansion.
- Always check for spilled fuel before operating. Clean up any spilled fuel before starting.
- Empty fuel tank before storing or transporting the generator.
- Before transporting, turn fuel valve to off and disconnect spark plug wire.

IMPORTANT:

- Use only UNLEADED gasoline with an octane rating of 87 or higher.
- Do not use old gasoline.
- Never use an oil/gasoline mixture.
- Avoid letting dirt or water into the fuel tank.

Step 3- Ground the Generator



Danger high voltage

WARNING: Failure to properly ground the generator can result in electrocution.

Ground the generator by tightening the grounding nut on the front control panel against a grounding wire. (Figure 11) A generally acceptable grounding wire is a No. 12 AWG (American Wire Gauge) stranded copper wire. This grounding wire should be connected at the other end to a copper or brass rod that is driven into the earth. Wire and grounding rod are not included in generator contents.

Grounding codes can vary by location. Contact a local electrician for area codes.

USING THE GENERATOR



Danger high voltage

WARNING: When this generator is used to supply a building wiring system:

Generator must be installed by a qualified electrician and connected to a transfer switch as a separately derived system in accordance with the National Electrical Code, NFPA 70. The generator shall be connected to a transfer switch that switches all conductors other than the equipment grounding conductor. The frame of the generator shall be connected to an approved grounding electrode.

For power outages, permanently installed stationary generators are better suited for providing backup power to the home. Even a properly connected portable generator can become overloaded. This may result in overheating or stressing the generator components, possibly leading to a generator failure.

Before connecting electrical devices, allow the generator to run for a few minutes to stabilize the speed and voltage output.

CAUTION: Become familiar with the markings on the panel before connecting electrical devices.

AC Usage

Connect electrical devices running on AC current according to their wattage requirements. The chart in figure 15 shows the rated and surge wattage of your generator.

NOTE: Although the overall rated wattage of the machine is 3000 Watts, it is not recommended that you attempt to draw more than 2400 Watts (20 A) from any ONE of the 120 Volt receptacles.

The *rated wattage* corresponds to the maximum wattage the generator can output on a continuous basis.

The *surge wattage* corresponds to the maximum amount of power the generator can output for a short period of time. Many electrical devices such as refrigerators require short bursts of extra power, in addition to the rated wattage listed by the device, to stop and start their motors. The surge wattage ability of the generator covers this extra power requirement.

Model Number	Rated(Running) Wattage	Surge Wattage
3500	3000	3500

Figure 15- generator wattage by model number.

The total running wattage requirement of the electrical devices connected to the generator should not exceed the rated wattage of the generator itself. To calculate the total wattage requirement of the electrical devices you wish to connect, find the rated (or running) wattage of each device. This number should be listed somewhere on the device or in its instruction manual. If you cannot find this wattage, you may calculate it by multiplying the Voltage requirement by the Amperage drawn:

$$\text{Watts} = \text{Volts} \times \text{Amperes}$$

If these specifications are not available, you may estimate the Watts required by your device using the chart in figure 16.

When the rated wattage requirement of each electrical device has been determined, add these numbers to find the total rated wattage needed. If this number exceeds the rated wattage of the generator, DO NOT connect all these devices. Select a combination of electrical devices, which has a total rated wattage lower than or equal to the rated wattage of the generator.

CAUTION: The generator can run at its surge wattage capacity for only a short time. Connect electrical devices requiring a rated (running) wattage equal to or less than the rated wattage of the generator. Never connect devices requiring a rated wattage equal to the surge wattage of the generator. This can trip the circuit protectors (circuit breakers).

tool or appliance	rated (running) Watts	additional surge Watts
electric water heater (40 gal)	4000	0
hot plate	2500	0
saw- radial arm	2000	2000
electric stove (each element)	1500-2800	0
saw- circular	1500	1500
air compressor (1 HP)	1500	3000
window air conditioner	1200	1800
saw- miter	1200	1200
microwave	1000	0
well water pump	1000	1000
reciprocating saw	960	1040
sump pump	800	1200
refrigerator freezer	800	1200
furnace blower	800	1300
computer	800	0
electric drill	600	900
television	500	0
deep freezer	500	500
garage door opener	480	0
stereo	400	0
box fan	300	600
clock radio	300	0
security system	180	0
DVD player/ VCR	100	0
common light bulb	75	0

NOTE: The above wattage figures are estimates. Try to check the wattage listed on your electrical device before consulting this chart.

Figure 16- Estimated wattage requirements of common electrical devices.

Once you have determined what electrical devices you will be powering with the generator, connect these devices according to the following procedure:

1. Plug in each electrical device with the device turned off. **NOTE:** Be sure to attach appliances to the correct receptacles (outlets). Connect standard 120 Volt, single phase, 60 Hz loads **only** to the 120 Volt receptacles. Connect 240/120 Volt, single phase, 60Hz loads with a NEMA L14-30 plug **only** to the 240/120 Volt receptacle See Figure 17 for a depiction of each of these receptacles.

2. Push in the circuit reset buttons to the “on” position (NOTE: They may be pushed in already).
3. Move the voltage selector to the desired position. Move the switch to the left to use the standard 120 Volt receptacles. Move the switch to the right to use the 240/120 Volt NEMA receptacle.
4. The power indicator lights will light accordingly as the Volt Selector is selected. They light up when the receptacles receive power. In the case of the 240/120 Volt receptacle, both lights MUST light up for 240/120 Volts of power. If only one light comes on, DO NOT USE the receptacle. Press the circuit reset buttons and see if both lights come on. If both lights will still not illuminate, call the customer service number for instructions.

CAUTION: Do not connect 50Hz or 3-phase loads to the generator.



Figure 17- Receptacles available on the generator

CIRCUIT RESET BUTTONS

The circuit reset buttons help to prevent the generator from electrical overload. If your receptacle short circuits or becomes overloaded by an electrical device or devices with too great a wattage rating, the circuit protector may shut off power to the receptacle. If this happens, you will see the voltage indicator light or lights turn off and you will not be able to draw power from the overloaded receptacle. In the event of such an overload, disconnect all electrical devices from the generator and press the circuit reset buttons. If power still does not return to the receptacle, call our customer service line.

SOME NOTES ABOUT POWER CORDS

Long or thin cords can drain the power provided to an electrical device by the generator. When using such cords, allow for a slightly higher rated wattage requirement by the electrical device. See Figure 18 for recommended cords based on the power requirement of the electrical device.

Device Requirements			Max. Cord Length (ft) by Wire Gauge				
Amps	Watts (120V)	Watts (240 V)	#8 wire	#10 wire	#12 wire	#14 wire	#16 wire
2.5	300	600	NR	1000	600	375	250
5	600	1200	NR	500	300	200	125
7.5	900	1800	NR	350	200	125	100
10	1200	2400	NR	250	150	100	50
15	1800	3600	NR	150	100	65	NR
20	2400	4800	175	125	75	50	NR
25	3000	6000	150	100	60	NR	NR
30	3600	7200	125	65	NR	NR	NR
40	4800	9600	90	NR	NR	NR	NR

*NR= not recommended

Figure 18- Maximum Extension Cord Lengths by Power Requirement

DC Usage

This Generator is equipped with a cigarette lighter style 12V DC receptacle. The maximum draw for this DC outlet is 8.3 Amps. The 12V DC receptacle is not intended for use to charge automotive batteries.

The cigarette lighter style receptacle permits the use of any electrical device designed for use in a 12V DC cigarette style outlet similar to ones found in automobiles. The electrical device has a power cord with a metal pin on the bottom and two leaf springs on the sides. Some common automotive type electrical devices are inflators, vacuum cleaners, chargers of various types and more.

To Use: Simply plug the electrical device power cord into the 12V DC outlet and ensure the power cord is securely in place. Use the device as instructed. Remove after use by simply pulling the power cord out of the receptacle. The 12V DC receptacle is protected against overloads by an in-line fuse located behind the control panel.

STOPPING THE GENERATOR

To stop the generator:

1. Turn off all electrical devices prior to unplugging them from the generator. Unplugging running devices can cause damage to the generator.
2. Turn the engine switch to the “OFF” position.
3. Turn the fuel valve to the “OFF” (horizontal) position.



**Do Not Touch
Hot Surface**

WARNING: Allow the generator to cool for several minutes before touching areas that become hot during use.

CAUTION: Allowing gasoline to sit in the generator tank for long periods of time without use can make it difficult to start the generator in the future. Never store generator for extended periods of time with fuel in the tank.

MAINTENANCE / CARE

Proper routine maintenance of your generator will help prolong the life of your machine. Please perform maintenance checks and operations according the schedule in figure 19.



If you have questions about any of the maintenance procedures listed in this manual, please call (888) 315-3080 M-F 8-5 CST.

CAUTION: Never perform maintenance operations while the generator is running.

Recommended Maintenance Schedule

		each use	first month then every 20 hrs	every 3 months or 50 hrs	every 6 months or 100 hrs	every year or 300 hrs
Engine oil	check level	x				
	replace		x	x		
Air cleaner	check	x				
	clean			x		
fuel filter cup	clean				x	
spark plug	check/ clean				x	
fuel tank	check fuel level	x				
	clean					x

Figure 19- Recommended maintenance schedule

Cleaning the Generator

Never clean the generator when it is running! Never clean with a bucket of water or a hose. Water can get inside the working parts of the generator and cause a short circuit or corrosion.

Always try to use the generator in a cool, dry place. If the generator becomes dirty, clean the exterior with a damp cloth, a soft brush, vacuum or pressurized air.

Checking the Oil

Check the oil level of the generator according to the Recommended Maintenance Schedule in Figure 19. The generator is equipped with an automatic shutoff to protect it from running with low oil pressure. The generator should be checked before each use for proper oil level. This is a critical step for proper engine starting.

To check or add oil, follow these steps:

1. Make sure the generator is on a level surface. Clean around oil fill.
2. Remove the oil filler/dipstick cap and check oil level.
3. If oil level is below the second thread from the lip of the oil fill opening, slowly add oil until the engine crankcase is filled.
4. Reinstall and tighten oil filler cap before starting the engine. .

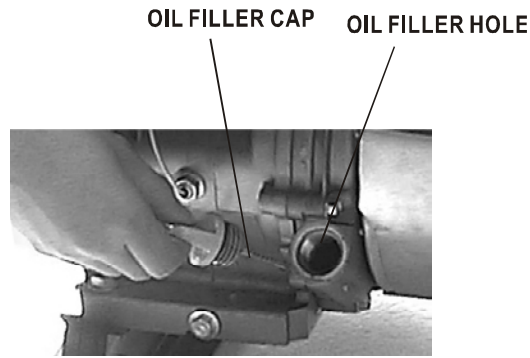

Figure 20- Checking the oil

Changing/ Adding Oil

Change the oil according to the maintenance schedule in figure 19. Change the oil when the engine is warm. This will allow for complete drainage. Change oil more often if operating under heavy load or high ambient temperatures. It is also necessary to drain the oil from the crankcase if it has become contaminated with water or dirt.

The oil capacity of the engine in this generator is 20 fluid oz. Add oil when the oil level is low.

Drain the oil from the generator according to the following steps:

1. Place a container underneath the engine to catch oil as it drains.
2. Using a 10 mm hex wrench, unscrew the oil drain plug (see figure 21). Allow all the oil to drain from the engine.
3. Reinstall the oil drain plug and tighten with a 10 mm hex wrench.

To fill the crankcase with oil, follow these steps:

1. Make sure the generator is on a level surface. **Tilting the generator to assist in filling will cause oil to flow into engine areas and will cause damage. Keep generator level!**
2. Remove the oil filler/dipstick cap from the engine as shown in figure 20 above.
3. Using a funnel, add the appropriate type and amount of oil into the crankcase. The crankcase is full when the oil level has reached the second thread from the lip of the opening (see figure 22).
4. Check for oil leaks. Reinstall oil filler cap before starting engine.

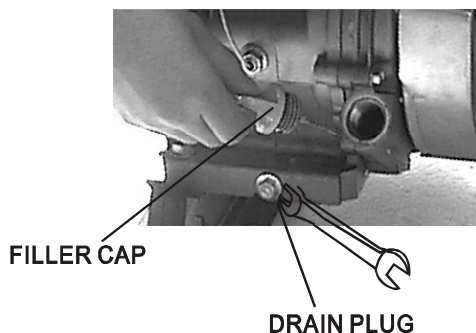

Figure 21- Draining oil



Figure 22- Adding oil

NOTE: Never dispose of used motor oil in the trash or down a drain. Please call your local recycling center or auto garage to arrange oil disposal.

Air Cleaner Maintenance

Routine maintenance of the air cleaner helps maintain proper air flow to the carburetor. Check that the air cleaner is free of excessive dirt.

1. Unhinge the clasps at the top and bottom of the air cleaner cover (see figure 23).
2. Remove the sponge-like element from the casing.
3. Wipe the dirt from inside the empty air cleaner casing
4. Wash the sponge-like element in household detergent and warm water. Allow to dry.
5. Reinstall the sponge-like element in the air cleaner casing and reinstall the cover.



Figure 23- Removing the air cleaner casing.

Fuel Filter Cup Cleaning

The fuel filter cup is a small well underneath the fuel valve. It helps to trap dirt and water that may be in the fuel tank before it can enter the engine. To clean the fuel filter cup:

1. Turn the fuel valve to the “off” position.
2. Unscrew the fuel filter cup from the fuel valve using a wrench. Turn the valve toward you to unscrew (see figure 24).
3. Clean the cup of all sediment using a rag or brush.
4. Reinstall the fuel filter cup.

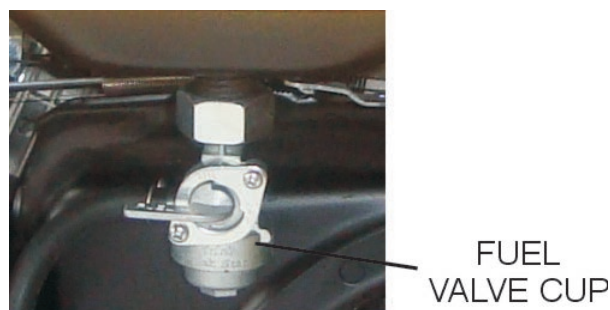

Figure 24- Removing the Fuel Filter Cup

Spark Plug Maintenance

The spark plug is important for proper engine operation. A good spark plug should be intact, free of deposits, and properly gapped. To inspect the spark plug:

1. Pull on the spark plug cap to remove it.
2. Unscrew the spark plug from the generator using the spark plug wrench included with this product (see figure 25).
3. Visually inspect the spark plug. If it is cracked or chipped, discard and replace with a new spark plug.
4. Measure the plug gap with a gauge (see figure 26). The gap should be 0.7-0.8mm (0.028-0.031in).
5. If you are re-using the spark plug, use a wire brush to clean any dirt from around the spark plug base and then re-gap the spark plug.
6. Screw the spark plug back into its place on the generator using the spark plug wrench. **Do not** over-tighten spark plug. Recommended tightening of spark plug is $\frac{1}{2}$ to $\frac{3}{4}$ of a turn after spark plug gasket contacts spark plug hole. Reinstall the spark plug cap.

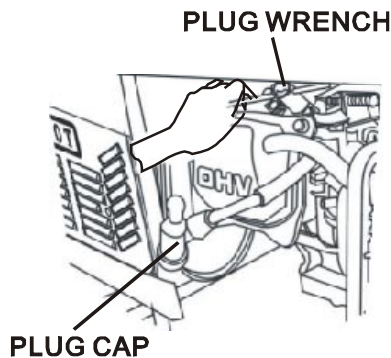

Figure 25- Removing the spark plug cap

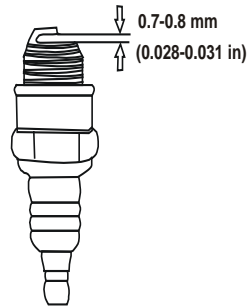

Figure 26- Measuring the spark plug gap
Spark plug: NGK BP7ES

Draining the Fuel Tank

Clean fuel tank each year or before storing the generator for extended periods of time. To drain the fuel tank and carburetor:

1. Turn the fuel valve to the “off” position.
2. Remove the fuel line between the fuel valve and carburetor. Caution: a small amount of fuel may leak from the hose during removal.
3. Attach a fuel line (not included with the generator) to exposed end of the fuel valve.
4. Position fuel line into an appropriate container and open the fuel valve allowing fuel to flow into the container.
5. Once fuel is drained, shut off the fuel valve.
6. Start and run the engine until fuel runs out.
7. Remove the fuel filter cup (see “Fuel Filter Cup Cleaning” earlier in this section).
8. Empty the fuel filter cup of any fuel and clean
9. Reinstall the fuel filter cup.
10. Store the emptied gasoline in a suitable place.

⚠ CAUTION: Do not store fuel for more than 3 months.

STORAGE / TRANSPORT PROCEDURES



CAUTION: Never place any type of storage cover on the generator while it is still hot.

If the generator is being stored for short periods of time (30 – 60 days), add stabilized fuel to the fuel tank until full. NOTE: Filling the tank reduces the amount of air in the tank and helps reduce deterioration of fuel. Run the engine for 2 – 3 minutes allowing stabilized fuel mixture to circulate through the carburetor.

When transporting or storing the generator for extended periods of time:

- Drain the fuel tank (see “Draining the Fuel Tank” in the “Maintenance” section).
- Disconnect the spark plug cap from the spark plug.
- Do not obstruct any ventilation openings.
- Keep the generator in a cool dry area.

SPECIFICATIONS

Generator

AC Output

Rated Wattage	3000 W
Surge Wattage	3500 W
Rated Voltage	240V/120 V
Rated Amperage	12.5A/25A
Rated Frequency	60 Hz
Phase	Single
Dimensions(in):	length= 24.4 width= 17.7 height= 18.5
Weight	111.2 lbs

Engine

Engine type	4-stroke OHV single cylinder with forced air cooling system
Ignition system	non-contact transistor
Displacement	196 cm ³
Fuel tank capacity:	15 L (4 US gal.)
Oil capacity	0.6 L (20 fl oz.)
Run time on 50% load	11 hrs
Noise rating at 22 feet	67 dB idle 74 dB fully loaded
Spark Plug	NGK BP7ES

TROUBLESHOOTING

IMPORTANT: If trouble persists please call our customer help line at **(888) 315-3080** M-F 8-5 Central Time.

Problem	Cause	Solution
Engine will not start	Engine switch is set to "OFF".	Set engine switch to "ON".
	Fuel valve is turned to "OFF".	Turn fuel valve to "ON" position.
	Choke is open.	Close the choke
	Engine is out of fuel.	Add gasoline.
	Engine is filled with contaminated or old gasoline.	Change the gasoline in the gas tank.
	Spark plug is dirty.	Clean spark plug.
	Spark plug is broken.	Replace spark plug.
	Generator is not on level surface.	Move generator to a level surface to prevent low oil shutdown from triggering.
	Oil is low.	Add or replace oil.
Engine runs but there is no electrical output	Circuit reset button is off.	Wait for 2 minutes and push the circuit reset button to the "ON" position.
	Bad connecting wires/cables.	If you are using an extension cord, try a different one.
	Bad electrical device connected to generator.	Try connecting a different device.
Generator runs but does not support all electrical devices connected.	Generator is overloaded.	Perform these steps: 1. Turn off all electrical devices. 2. Unplug all electrical devices. 3. Turn off generator. 4. Wait several minutes. 5. Restart generator. 6. Try connecting fewer electrical loads to the generator.
	Short in one of the connected devices.	Try disconnecting any faulty or short-circuited electrical loads.
	Air cleaner is dirty.	Clean or replace air cleaner.
DC No Power	Power cord plug not securely in place	Twist and push power cord plug into receptacle until contact is made with bottom of receptacle.
	Protective fuse is blown	Contact our customer service help line at (888) 315-3080 .

EXPLODED VIEW AND PARTS LIST

Engine exploded view

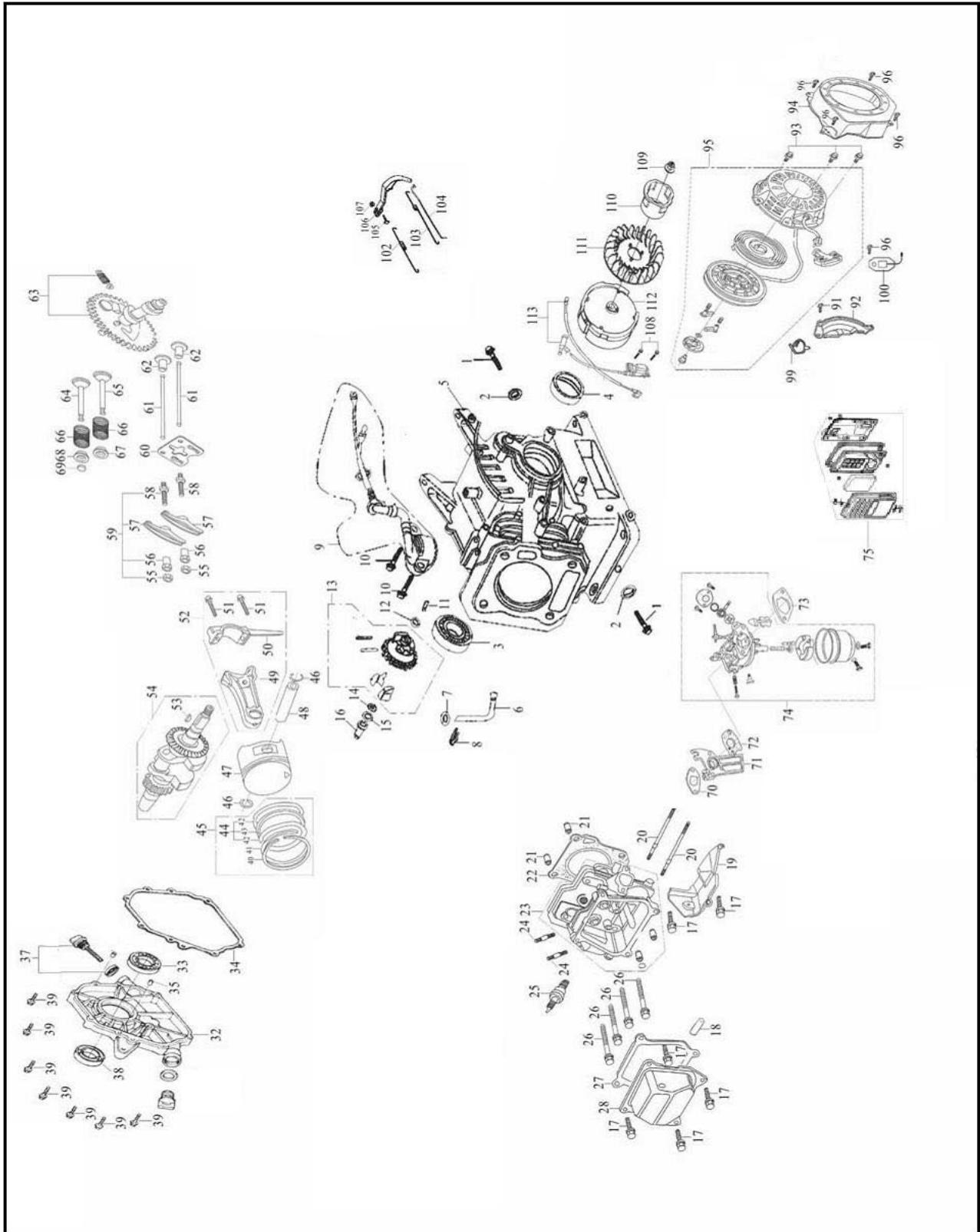

Engine parts list

Item	Order #	Qty	Description
1	P54000	2	Oil drain plug
2	P54002	2	Washer
3	P54004	1	Bearing 6205
4	P54008	1	Crankshaft oil seal
5	P54010	1	Crankcase
6	P54014	1	Regulating sway bar
7	P54016	1	Washer
8	P54018	1	Split pin
9	P54020	1	Oil sensor
10	P54024	2	M6×14 bolt
11	P54026	1	Regulating shaft
12	P54028	1	Washer
13	P54031	1	Regulator gear assembly
14	P54032	1	Snap ring
15	P54034	1	Washer
16	P54036	1	Sleeve
17	P54040	6	M6×12 bolt
18	P54043	1	Air duct
19	P54044	1	Wind cover
20	P54047	2	M6×96 bolt
21	P54048	2	Set pin 10×16
22	P54050	1	Cylinder head gasket
23	P54054	1	Cylinder head Assembly
24	P54058	2	M8×34 bolt
25	P54060	1	Spark plug
26	P54062	4	Bolt
27	P54064	1	Cylinder head cover gasket
28	P54066	1	Cylinder head cover assembly
32	P54075	1	Crankcase cover
33	P54004	1	Bearing 6205
34	P54080	1	Crankcase gasket
35	P54082	2	Set pin
37	P54086	1	Oil dipstick assembly
38	P54088	1	Crankshaft oil seal
39	P54092	7	M8×32 bolt
45	P54104	1	Piston ring assembly
46	P54106	2	Piston pin clip
47	P54108	1	Piston
48	P54112	1	Piston pin
49	P54114	1	Connecting rod
50	P54116	1	Connecting rod cover
51	P54118	2	Bolt
52	P54120	1	Connecting rod assembly

Item	Order #	Qty	Description
53	P54122	1	Woodruff key
54	P54127	1	Crankshaft assembly
55	P54128	2	Lock nut
56	P54130	2	Sleeve
57	P54132	2	Valve rocker
58	P54134	2	Adjusting bolt for valve gap
59	P54136	2	Valve rocker assembly
60	P54138	1	Pusher guide
61	P54140	2	Pusher
62	P54142	2	Tappet
63	P54146	1	Camshaft assembly
64	P54150	1	Exhaust valve
65	P54152	1	Intake valve
66	P54154	2	Valve spring
67	P54156	1	Intake valve spring seat
68	P54158	1	Exhaust valve spring seat
69	P54160	1	Cap
70	P54162	1	Inlet gasket
71	P54164	1	Connecting block
72	P54166	1	Carburetor gasket
73	P54168	1	Air cleaner gasket
74	P54173	1	Carburetor assembly
75	P54175	1	Air cleaner
91	P54186	1	M6×22 bolt
92	P54596	1	Crankcase side plate assembly
93	P54598	3	M6×8 bolt
94	P54668	1	Fan hood assembly (black)
95	P54604	1	Recoil starter (black)
96	P54040	5	M6×12 bolt
99	P54610	1	Plastic clip
100	P54612	1	Diode
102	P54616	1	Back spring
103	P54618	1	Regulating spring
104	P54620	1	Pulling rod
105	P54622	1	Lock bolt
106	P54624	1	Regulating arm
107	P54176	1	M6 nut
108	P54628	2	M6×25 screw
109	P54630	1	M14×1.5 nut
110	P54632	1	Starting flange
111	P54634	1	Flywheel fan
112	P54636	1	Flywheel
113	P54638	1	Ignition coil assembly

Generator exploded view

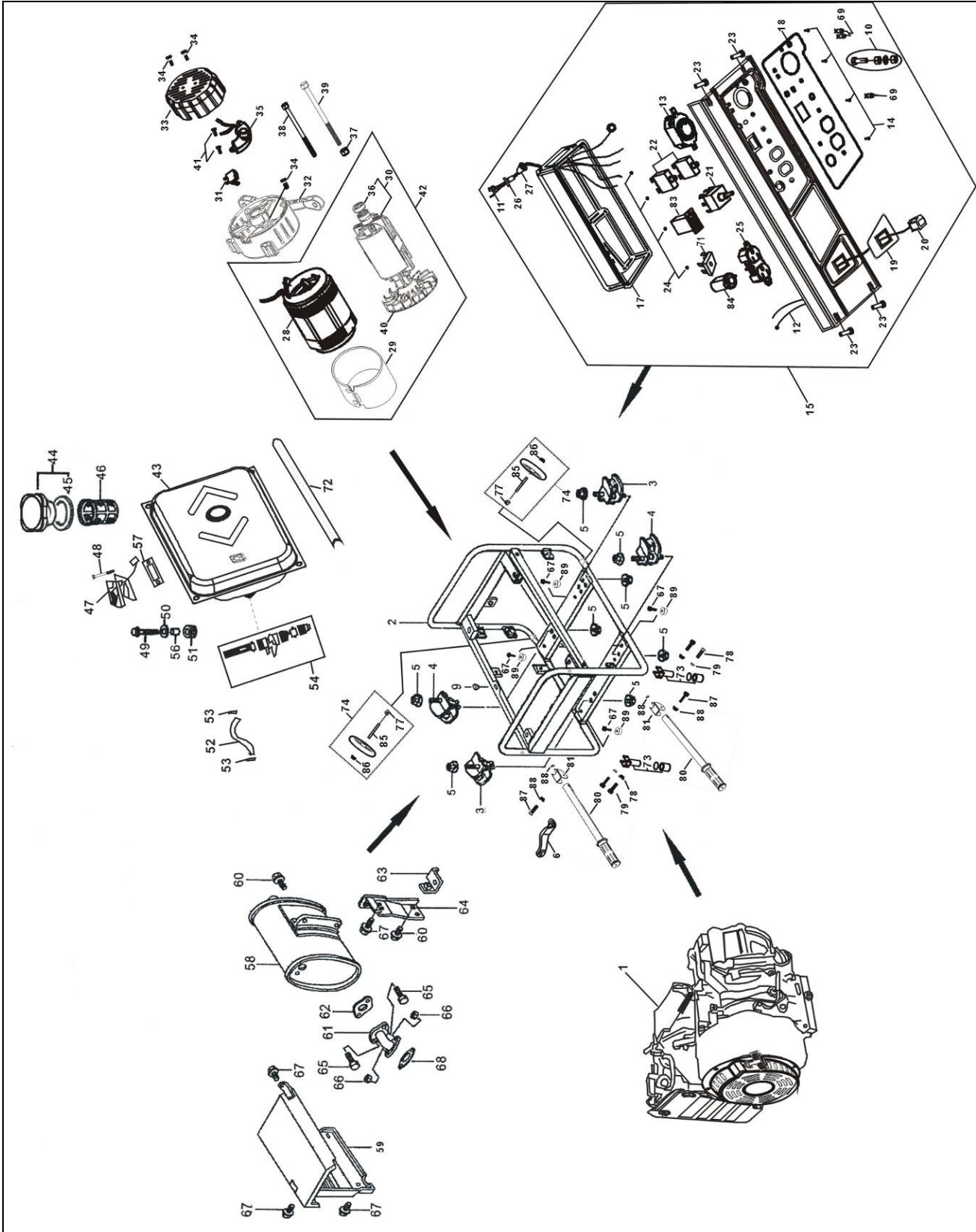

Generator parts list

Item	Order #	Qty	Description
1	P54868	1	Gasoline engine
2	P54237	1	Frame comp
3	P54242	2	Bottom rubber A
4	P54244	2	Bottom rubber B
5	P54246	8	Flange nut M8
9	P54258	1	Frame rubber pad
10	P54262	1	Earth terminal set
11	P54830	1	Wire harness assembly
12	P54831	1	Switch wire
13	P54272	1	Receptacle(30A)
14	P54276	4	Bolt M4×10
15	P54283	1	Control panel assembly
17	P54834	1	Control panel case
18	P54291	1	Panel switch mark, RH
19	P54293	1	Panel switch mark, LH
20	P54296	1	Ignition switch
21	P54826	1	Voltage selector
22	P54838	2	Circuit breaker(13A)
23	P54304	4	Circuit bolt M6×25
24	P54308	4	Nut M4
25	P54454	1	Duplex receptacle
26	P54316	1	AC output wire boot
27	P54318	1	Main wire harness boot
28	P54327	1	Stator assembly
29	P54324	1	Stator cover
30	P54328	1	Rotor comp
31	P54332	1	Brush assembly
32	P54336	1	Generator stay
33	P54337	1	Generator end cover (Black)
34	P54340	3	Bolt M5×12
35	P54342	1	Voltage regulator
36	P54346	1	Bearing 6202-2RS
37	P54348	1	Plain washer
38	P54350	4	Flange bolt M6×160
39	P54354	1	Bolt M8×210
40	P54358	1	Generator fan
41	P54360	3	Bolt M5×14

Item	Order #	Qty	Description
42	P54361	1	Stator & rotor assembly
43	P54369	1	Fuel tank (Black)
44	P54368	1	Fuel cap
46	P54372	1	Fuel filter
47	P54374	1	Fuel gauge assembly
48	P54376	2	Screw M5×10
49	P54186	4	Flange bolt M6×22
50	P54384	4	Washer
51	P54386	4	Cushion
52	P54388	1	Outlet pipe $\phi 9 \times \phi 4.5 \times 130$
53	P54390	2	Tube clip
54	P54392	1	Fuel cock
56	P54396	4	Fitting brush, fuel tank
58	P54401	1	Muffler
59	P54402	1	Muffler guard
60	P54404	3	Flange bolt M8×16
61	P54406	1	Exhaust pipe comp
62	P54408	1	Muffler gasket
63	P54410	1	Supporting plate
64	P54412	1	Muffler stay
65	P54414	2	Bolt M8×25
66	P54246	2	Nut M8
67	P54422	10	Flange bolt M6×12
68	P54426	1	Exhaust pipe gasket
69	P54828	3	Power indicator
71	P54451	1	Rectifier
72	P54870	1	Decorating stripe, fuel tank
73	P54871	2	Rubber foot assembly
74	P54872	2	Wheel assembly
77	P54873	2	Nut
78	P54874	4	Bolt M6×40
79	P54875	4	Nut M6
80	P54876	2	Handle assembly
83	P54877	1	Engine hour counter (E)
84	P54878	1	12V Cigarette lighter style DC receptacle
85	P54879	2	Wheel shaft assembly
89	P54254	4	Rubber bottom

WIRING DIAGRAM

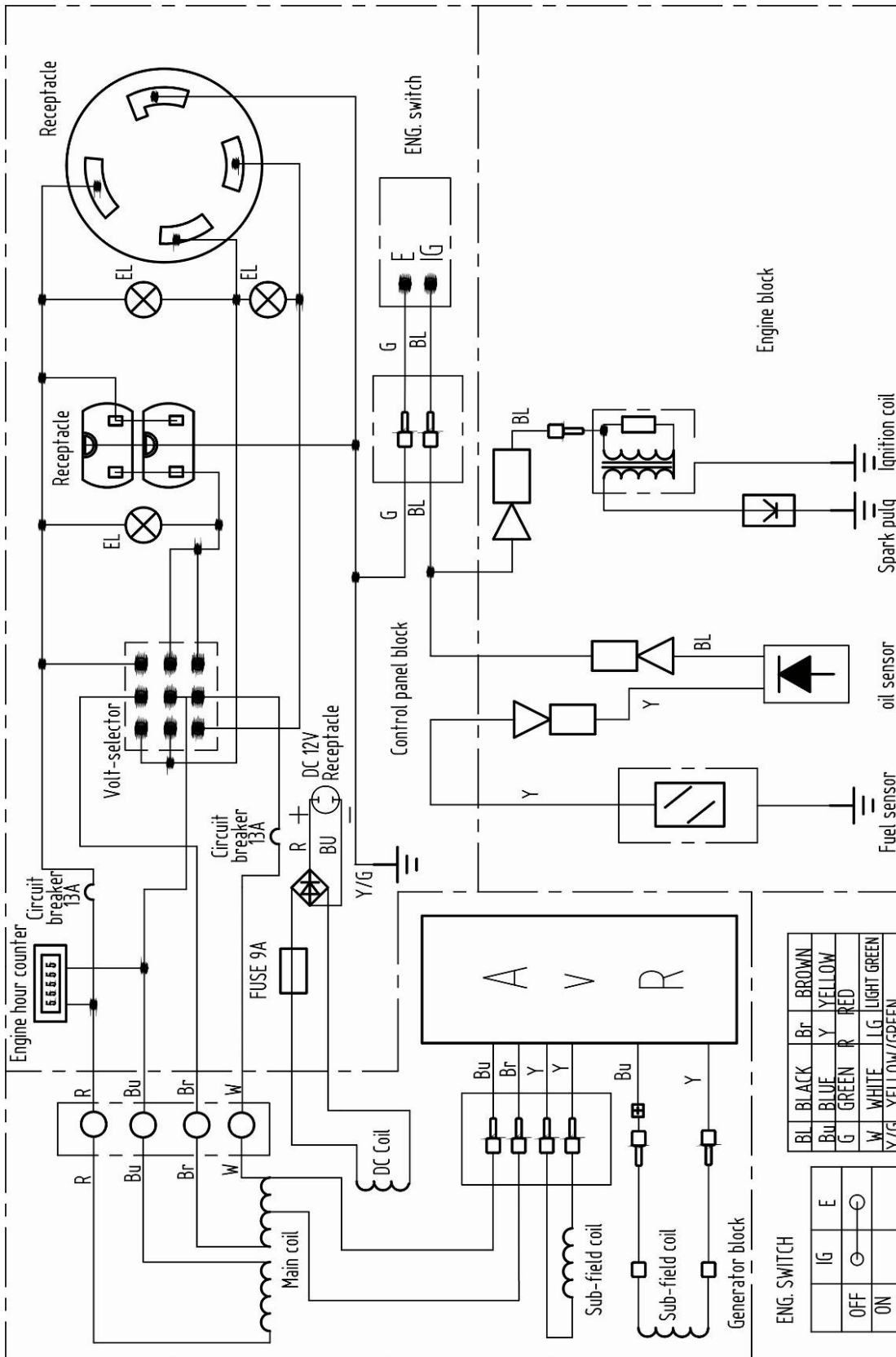

ENG. SWITCH	
IG	E
OFF	⊖
ON	⊕

BL	BLACK	Br	BROWN
Bu	BLUE	Y	YELLOW
G	GREEN	R	RED
W	WHITE	LG	LIGHT GREEN
Y/G	YELLOW/GREEN		

WARRANTY STATEMENT FOR WEN POWER™ GENERATORS

WEN Power™ generators are warranted (to the original purchaser) to be free from defects in materials and workmanship for a period of two (2) years from the date of original purchase. Generators used for commercial or for rental have a warranty period of 90 days from date of original purchase. Please fill out and mail the enclosed warranty card and mail it to Power Pro Technology along with a copy of the receipt. The information is required to process warranty claims.

WEN Power™ will repair or replace, at its discretion, any part that is proven to be defective in materials or workmanship under normal use during the two (2) year warranty period. Warranty repairs or replacements will be made without charge for parts or labor. Parts replaced during warranty repairs will be considered as part of the original product and will have the same warranty period as the original product.

TO EXERCISE WARRANTY COVERAGE:

Do not return to retailer! For warranty and technical support call the toll-free Customer Service Number: (888) 315-3080 and you will be informed of the nearest authorized service center. We will prearrange the repair with the center.

WARRANTY COVERAGE:

This warranty is conveyed to the original purchaser and is not transferable. Generators contain parts that will wear out with usage and parts that need maintenance. The warranty does not cover wear or maintenance parts. Specifically, the warranty does not cover replacement of air filter, spark plug, brush and recoil starter rope. Warranty does not extend to generators damaged or affected by accidents, neglect, misuse, contaminated fuel, unauthorized alterations, use in applications beyond product design and any other modification or abuse.

WEN Power™ is not liable for any indirect, incidental or consequential damages from the sale or use of this product. Any implied warranties are limited to two (2) years as stated in this written limited warranty. Some states do not allow limitation on the length of an implied warranty. Some states do not allow the exclusion or limitation of incidental or consequential damages. This warranty gives you the specific legal right, and you may have other rights that vary by state.

Free Manuals Download Website

<http://myh66.com>

<http://usermanuals.us>

<http://www.somanuals.com>

<http://www.4manuals.cc>

<http://www.manual-lib.com>

<http://www.404manual.com>

<http://www.luxmanual.com>

<http://aubethermostatmanual.com>

Golf course search by state

<http://golfingnear.com>

Email search by domain

<http://emailbydomain.com>

Auto manuals search

<http://auto.somanuals.com>

TV manuals search

<http://tv.somanuals.com>