



## Refrigerator

### Contents

Appliance Registration	2	Light Bulb Replacement	14
Base Grille	4	Model and Serial Numbers	2
Care and Cleaning	13	Problem Solver	15-18
Condenser	13	Repair Service	19
Energy Saver	8	Safety Instructions	3
Energy-Saving Tips	2	Shelves	11, 12
Food Saver System	10	Storage Drawers	10, 11
Food Storage Suggestions	9	Drawer & Cover Removal	10, 11
Storage Times	9	Temperature Controls	8
Ice Dispenser	5-7	Vacation & Moving Tips	14
Icemaker	5-7	Warranty	Back Cover
Installation	3, 4	Water Filter Accessory	14
Adapter Plug	4		
Adjustable Rollers	4		
Clearances	4		
Electrical Requirements	3, 4		
Extension Cord	4		
Grounding	3		
Location	4	<b>GE Answer Center®</b>	
Water Supply to Icemaker	4	<b>800.626.2000</b>	

**Models** TFX22R TFX24R  
TFXH22R TFXW24R  
TFX22V TFX24V  
with Ice & Chilled Water Service

### GE Appliances

TFX22RG ✓ ✓ ✓  
TFXH22RL ✓ PUBNO  
TFX22RH ✓ TFXW24RL ✓ 49-6596  
TFX22VL ✓ ✓  
TFX24RG ✓ ✓  
TFX24RH ✓ ✓  
TFX24VL ✓ ✓

49-6596

# Help us help you . . .

## Read this book carefully.

It is intended to help you operate and maintain your new refrigerator properly.

Keep it handy for answers to your questions.

If you don't understand something or need more help, write (include your phone number):

Consumer Affairs  
GE Appliances  
Appliance Park  
Louisville, KY 40225

## Write down the model and serial numbers.

You'll see them on a label at the bottom, just inside the fresh food compartment door.

These numbers are also on the Consumer Product Ownership Registration Card that came with your refrigerator.

Before sending in this card, please write these numbers here:

---

Model Number

---

Serial Number

Use these numbers in any correspondence or service calls concerning your refrigerator.

**If you received a damaged refrigerator, immediately contact the dealer (or builder) that sold you the refrigerator.**

### Save time and money.

**Before you request service, check the Problem Solver on pages 15 through 18. It lists causes of minor operating problems that you can correct yourself.**

## Energy-saving tips

- Location of your refrigerator is important. Avoid locating it next to your range, a heating vent or where the sun will shine directly on it.
- Don't open the doors more often than necessary.
- Close the doors as soon as possible, particularly in hot, humid weather.
- Be sure the doors are closed tightly. Before leaving the house or retiring for the night, check to be sure the doors haven't been left open accidentally.
- Store only those foods requiring refrigeration in your refrigerator.
- Wipe moisture from bottles and cartons before putting them in the refrigerator.
- Keep foods covered to reduce moisture buildup inside the refrigerator.
- If you turn the controls to the coldest position for quick chilling or freezing, be sure to turn them back to regular settings.
- Don't overcrowd your refrigerator. Overcrowding can require extra electrical energy to keep everything cool.

# IMPORTANT SAFETY INSTRUCTIONS

Read all instructions before using this appliance.

**WARNING**—when using this appliance, always exercise basic safety precautions, including the following:

- Use this appliance only for its intended purpose as described in this Use and Care Book.
- This refrigerator must be properly installed in accordance with the Installation Instructions before it is used. See grounding instructions below and on page 4.
- Never unplug your refrigerator by pulling on the power cord. Always grip plug firmly and pull straight out from the outlet.
- Repair or replace immediately all electric service cords that have become frayed or otherwise damaged. Do not use a cord that shows cracks or abrasion damage along its length or at either the plug or connector end.
- When moving your refrigerator away from the wall, be careful not to roll over or damage the power cord.
- After your refrigerator is in operation, do not touch the cold surfaces, particularly when hands

are damp or wet. Skin may adhere to these extremely cold surfaces.

- Do not place fingers or hands on the automatic icemaking mechanism while the refrigerator is plugged in. This will prevent contact with the moving parts of the ejector mechanism, or with the heating element that releases the cubes.

- Don't refreeze frozen foods which have thawed completely. The United States Department of Agriculture in Home and Garden Bulletin No. 69 says:

“... You may safely refreeze frozen foods that have thawed if they still contain ice crystals or if they are still cold—below 40°F.

“... Thawed ground meats, poultry, or fish that have any off-odor or off-color should not be refrozen and should not be eaten. Thawed ice cream should be discarded. If the odor or color of any food is poor or questionable, get rid of it. The food may be dangerous to eat.

“Even partial thawing and refreezing reduce the eating quality of foods, particularly fruits, vegetables and prepared foods. The eating quality of red meats is affected less than

that of many other foods. Use refrozen foods as soon as possible to save as much of their eating quality as you can.”

- If your old refrigerator is still around the house but not in use, be sure to remove the doors. This will reduce the possibility of danger to children.

- Unplug your refrigerator.

A. Before making any repairs.

Note: We strongly recommend that any servicing be performed by a qualified individual.

B. Before cleaning.

C. Before replacing a burned-out light bulb, the refrigerator should be unplugged in order to avoid contact with a live wire filament. (A burned-out light bulb may break when being replaced.)

Note: Turning control to OFF position does not remove power to the light circuit.

- Do not operate your refrigerator in the presence of explosive fumes.

## SAVE THESE INSTRUCTIONS

## Installation Requirements **IMPORTANT:** Please read carefully.

### How to connect electricity

For personal safety, this appliance must be properly grounded.

The power cord of this appliance is equipped with a grounding plug which mates with a standard grounded wall outlet (Fig. 1) to minimize the possibility of electric shock hazard from this appliance.

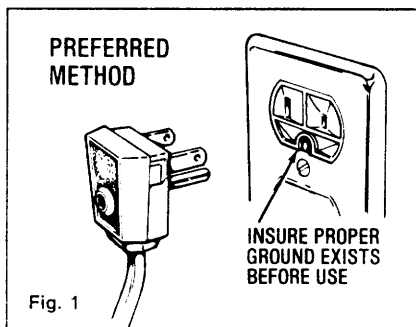

Have the wall outlet checked by a qualified electrician to make sure the outlet is properly grounded.

Where a standard two-prong wall outlet is encountered, it is your personal responsibility and obligation to have it replaced with a properly grounded three-prong wall outlet.

**DO NOT, UNDER ANY CIRCUMSTANCES, CUT OR REMOVE THE THIRD (GROUND) PRONG FROM THE POWER CORD.**

*(continued next page)*

# Installation Requirements (continued)—IMPORTANT... Please Read Carefully

## Use of Adapter Plug

Because of potential safety hazards under certain conditions, we strongly recommend against use of an adapter plug. However, if you still elect to use an adapter, where local codes permit, a TEMPORARY CONNECTION may be made to a properly grounded two-prong wall outlet by use of a UL listed adapter (Fig. 2) available at most local hardware stores.

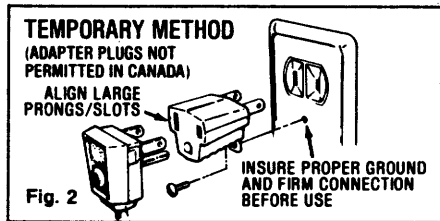

The larger slot in the adapter must be aligned with the larger slot in the wall outlet to provide proper polarity in the connection of the power cord.

**CAUTION:** Attaching adapter ground terminal to wall outlet cover screw does not ground the appliance unless cover screw is metal, and not insulated, and wall outlet is grounded through house wiring. You should have the circuit checked by a qualified electrician to make sure the outlet is properly grounded.

When disconnecting the power cord from the adapter, always hold the adapter with one hand. If this is not done, the adapter ground terminal is very likely to break with repeated use.

Should the adapter ground terminal break, **DO NOT USE** the appliance until a proper ground has again been established.

## Use of Extension Cords

Because of potential safety hazards under certain conditions, we strongly recommend against the use of an extension cord. However, if you still elect to use an extension cord, it is absolutely necessary that

it be a UL listed 3-wire grounding type appliance extension cord having a grounding type plug and outlet and that the electrical rating of the cord be 15 amperes (minimum) and 120 volts.

**The refrigerator should always be plugged into its own individual electrical outlet—**(115 volt, 60 Hertz, or 100 volt, 50 Hertz, single phase AC). This is recommended for best performance and to prevent overloading house wiring circuits, which could cause a fire hazard from overheating wires.

## Refrigerator Location

Do not install refrigerator where temperature will go below 60°F. because it will not run often enough to maintain proper temperatures.

Do install it on a floor strong enough to support a fully loaded refrigerator.

Also see Energy-Saving Tips regarding location.

## Clearances

Allow the following clearances for ease of installation and proper air circulation:

Sides .....	5/8"
Top .....	1"
Back .....	1"

If the refrigerator is against a wall on either side, allow 3/4" for door clearance.

## Water Supply to Icemaker

You will need to connect your icemaker to a cold water line. A water supply kit containing copper tubing, shut-off valve, fittings and instructions is available at extra cost from your dealer. There should be sufficient tubing for the icemaker from the cold water supply to allow you to move the refrigerator out from the wall several feet (approximately 8 feet of 1/4" copper tubing in three 10-inch diameter coils.)

## Rollers

Adjustable rollers behind the base grille enable you to move the refrigerator away from the wall for cleaning. These rollers should be set so the refrigerator rests firmly on the floor. To assure that the doors will close automatically from a halfway-open position, there is a built-in tilt from the front to the back of the cabinet. Side-by-side refrigerators also have specially designed door hinges that lift both doors slightly when opened, allowing the force of gravity to help close them securely.

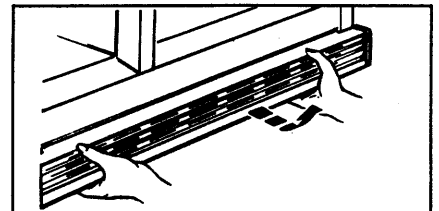

To adjust rollers, remove the base grille by grasping it at the bottom and pulling it out.

Turn roller adjusting screws clockwise to raise refrigerator, counterclockwise to lower it. Use adjustable wrench (3/8" hex head bolt) or pliers.

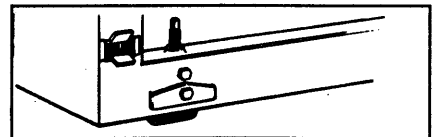

When adjusting front rollers for proper door closure, we recommend that the bottom front edge of the cabinet be approximately 5/8" from the floor.

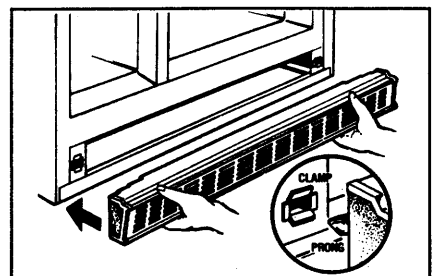

To replace base grille, align prongs on back of grille with clamps in cabinet and push forward until grille snaps into place.

# Ice & Chilled Water Dispenser

## Automatic Icemaker and Ice & Water Dispenser

Your refrigerator has an automatic icemaker and a dispenser that dispenses chilled water, ice cubes and crushed ice through the freezer compartment door. Here's how they work.

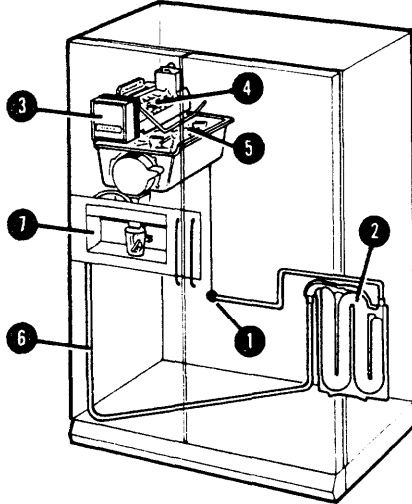

Water flows from the household supply through a

- (1) dual solenoid valve to the
- (2) water reservoir and to the
- (3) automatic icemaker as needed.

Water is frozen in the

- (4) cube mold and ejected into the
- (5) storage bin where a motor-powered auger moves cubes forward into the dispensing unit. Cubes or crushed ice, as selected, dispense through chute in door when cradle is pressed.

When the switch is moved to **CRUSHED**, baffle in housing channels cubes through the crusher and crushed ice falls through chute into glass.

Chilled water from reservoir flows through the

- (6) tubing in the door and is dispensed when the cradle is pressed.
- (7) A light switch turns the night light\* in the dispenser on or off.

\*Light switch and night light on models TFX24R, TFXW24R and TFX24V only.

## Important Facts about Your Ice & Water Dispenser

- **Your icemaker will produce eight cubes per cycle**—approximately 120 cubes in a 24-hour period—depending on freezer compartment temperature, room temperature, number of door openings and other use conditions.

- **Intermittent dispensing of ice is normal.** If ice flow interruption is more than brief, ice clump(s) may be the cause and should be removed following instructions below and on page 7.

- **Avoid overfilling glasses with ice and using narrow or extra-tall glasses.** This can jam the chute or cause the door in the chute to freeze shut. Periodically open the freezer compartment door and look down into the chute. If ice is blocking the chute, poke it through with a wooden spoon.

- **To help keep bits of ice from being sprayed beyond the glass,** place glass close to ice chute—but not so close that it blocks outcoming ice.

- **Ice should not be dispensed into thin glasses, fine china or delicate crystal**—they can crack or chip from the combined pressure of your hand pressing them against the cradle and ice dropping into the container.

- **Ice should be dispensed before filling glass with soda or other beverage mixes.** This will prevent splashing which is annoying and which, if the splash reaches the ice and water selector switch, could cause it to stick or bind.

- **Beverages and foods should not be quick-chilled in the ice storage bin.** Cans, bottles or food packages in the storage bin may cause the icemaker to malfunction.

- **Ice other than that produced by your icemaker should not be added to the ice storage bin**—it may not crush or dispense well.

## Before Using Your Icemaker and Dispenser

If you use your refrigerator before the water connection is made, raise the ice access door and make sure the icemaker feeler arm is in the OFF (up) position as shown below.

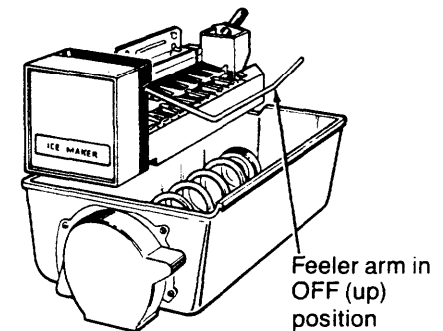
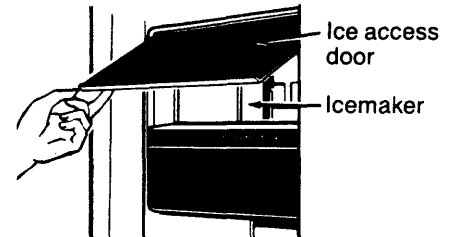

When water supply has been connected to icemaker, move feeler arm to ON (down) position.

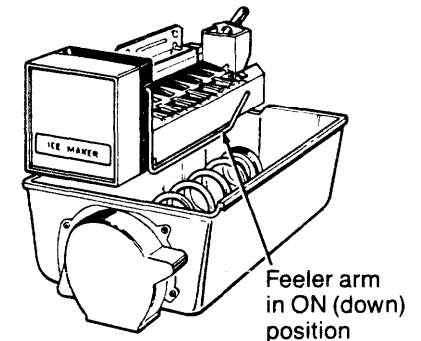

Depress water dispenser cradle for about two minutes to remove trapped air from the water line and to fill water reservoir automatically.

Ice cube mold automatically fills with water after cooling to freezing temperatures. First cubes normally freeze after several hours.

**NOTE:** With a newly-installed refrigerator, allow about 24 hours for the freezer compartment to cool down to the proper ice-making temperature.

(continued next page)

# Ice & Chilled Water Dispenser (continued)

## Once Your Icemaker and Dispenser Are in Operation

Throw away the first few batches of ice cubes (16 or 24 cubes). This will flush away any impurities in the water line. Do the same thing after vacations or extended periods when ice isn't used.

Discard the first six glassfuls of water in the kitchen sink. This will eliminate the slight "plastic" taste temporarily imparted to the water by the water reservoir.

**Keep ice level to keep icemaker productive.** Cubes ejected into an empty storage bin will pile up close to the icemaker and push the feeler arm up to the OFF position prematurely when the bin is only partially full. Open the ice access door, reach in, level the cubes by hand and icemaking will resume. Keeping cubes distributed evenly will allow the icemaker to produce enough ice to fill the bin to its maximum capacity.

### Caution:

Under certain rare circumstances, ice cubes may be discolored, usually appearing with a greenish hue. The cause of this unusual discoloration is apparently due to a combination of factors such as certain characteristics of local waters, household plumbing and the accumulation of copper salts in an inactive water supply line which feeds the icemaker. Continued consumption of such discolored ice cubes may be injurious to health. If such discoloration is observed, discard the ice cubes and contact your GE Factory Service Center or an authorized Customer Care® Servicer.

## To Dispense Ice and Water (TFX22R, TFXH22R, TFX22V)

- Set selector to CUBES, CRUSHED ICE or CHILLED WATER.

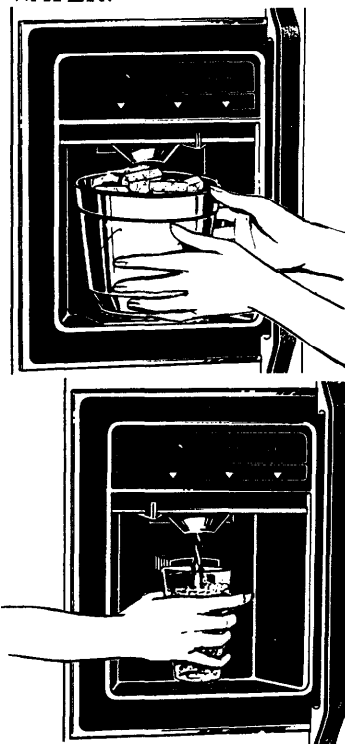

- Grip glass or other container near the rim and press rim gently but firmly against the rubber-cushioned cradle.

## To Dispense Ice and Water (TFX24R, TFXW24R, TFX24V)

- For ice, set selector switch to CUBES or CRUSHED. For water, simply position glass beneath words "CHILLED WATER."

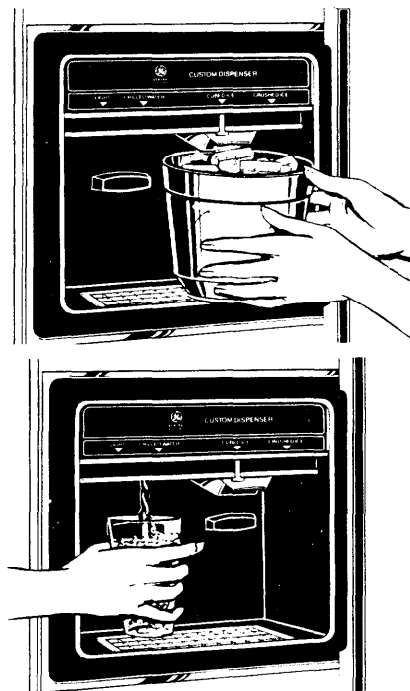

- Grip glass or other container gently near the rim and press rim firmly against ice or water dispenser cradle.

**Caution: Never put fingers or other objects into the ice crusher discharge opening.**

## When Dispensing Ice...

Some crushed ice may be dispensed even though you selected CUBES. This happens occasionally when a few cubes accidentally get channeled to the crusher.

**Sometimes a mound of snow will form on the door in the ice chute.** This condition is normal, and usually occurs when you have dispensed crushed ice repeatedly. The snow will eventually evaporate.

## When Dispensing Water...

The water system provides approximately six successive 6-ounce glassfuls—after which several hours must be allowed for replenished water reservoir supply to cool. You probably will not drain all the chilled water from the reservoir on a single occasion.

**The first glass of water dispensed may be warmer than the following ones.** This is normal.

**Dispensed water is chilled, not iced.** For colder water, simply add crushed ice or cubes before dispensing water.

## To Stop Dispensing

Release pressure from cradle and withdraw slowly to catch last bits of ice or drops of water.

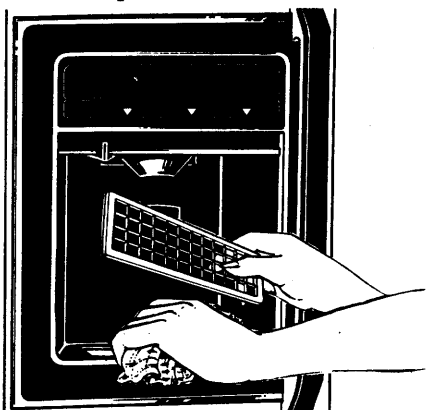

Some slight dripping may occur following dispensing of crushed ice or chilled water. If excessive, the spill should be wiped dry immediately.

Do not pour water in spill shelf because it is not self draining—pour it in kitchen sink. The shelf and its grille should be cleaned regularly according to instructions on page 13.

## If Ice Clumps Form in Storage Bin...

The Icemaker ejects cubes in groups of eight, and it is normal for several cubes to be joined together. However, if you don't use the ice very often ice clumps may form in the storage bin and can clog the dispenser.

If this happens:

- Remove storage bin from freezer compartment.
- Break up ice clumps with fingertip pressure and discard remaining clumps.
- Replace bin before remaining cubes melt and fuse together.

## To Remove Ice Cube Storage Bin

(TFX22R, TFXH22R, TFX22V)



1. Slide ice storage cover straight up until it disengages and remove it.

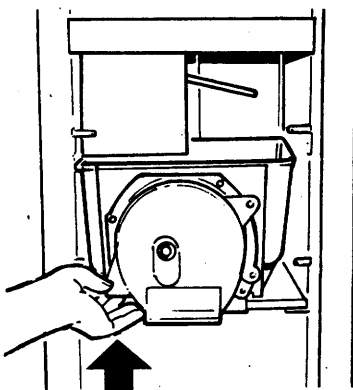

2. Lift left front corner to free bin from shelf, and pull bin straight out while supporting it at front and back.

(TFX24R, TFXW24R, TFX24V)

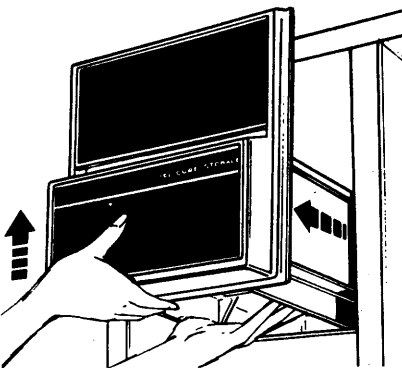

Lift the left corner to free the bin from the shelf, and pull the bin straight out while supporting it at front and back.

## To Replace Ice Cube Storage Bin

Slide the bin back until the tab on the bin locks into the slot in the shelf.

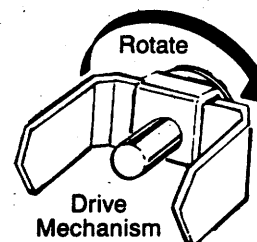

If bin does not go all the way back, remove it and rotate the drive mechanism 1/4 turn. Then push bin back again until the tab on the bin locks into the slot in the shelf.

## If Ice Is Not Used Frequently...

“Old” ice cubes will become cloudy and taste stale. Empty ice storage bin periodically and wash it in lukewarm water. Be sure to allow storage bin to cool before replacing it—otherwise ice cubes will stick to the metal auger.

## Move Icemaker Feeler Arm to OFF (up) Position when...

- Home water supply is to be turned off for several hours.
- Ice storage bin is to be removed for a period of time.
- Going away on vacation, at which time you should also turn off the valve in the water supply line to your refrigerator.

## If This is Your First Icemaker...

You'll hear occasional sounds that may be unfamiliar. These are normal icemaking sounds and are not cause for concern.

# Operating Your Refrigerator

## Set the Temperature Controls

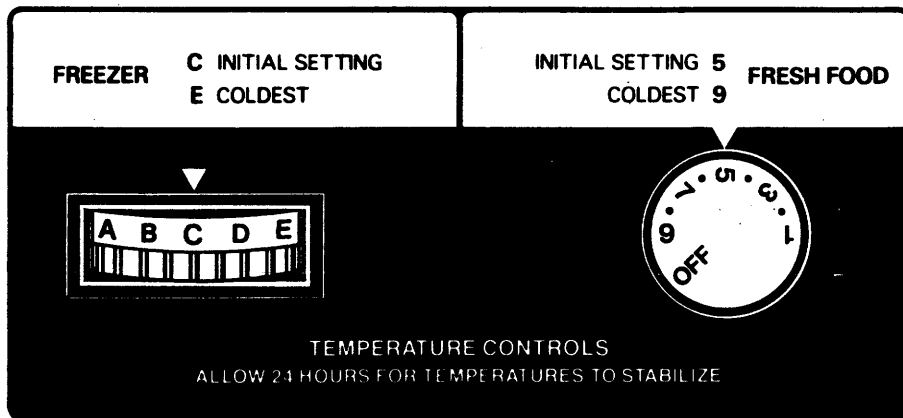

Your refrigerator has two controls that let you regulate the temperature in the fresh food and freezer compartments.

**INITIALLY**, set the **FRESH FOOD** control at 5 and the **FREEZER** control at C.

For colder or warmer temperatures, adjust the desired compartment control one letter or number at a time.

### IMPORTANT

**When your refrigerator is first installed, allow 24 hours for stabilization to normal operating temperature before filling it with large amounts of fresh or frozen foods.**

Note: Turning the fresh food control to "OFF" turns off BOTH compartments—fresh food AND freezer.

## How to Test Temperatures

**Use the milk test for the fresh food compartment.** Place a container of milk on the top shelf in the fresh food compartment. Check it a day later. If the milk is too warm or too cold, adjust the temperature controls.

**Use the ice cream test for the freezer compartment.** Place a container of ice cream in the center of the freezer compartment. Check it after a day. If it's too hard or too soft, adjust the temperature controls..

## If you turn your household thermostat below 60°F. at night

... you may want to turn the *lettered* control one step colder, as from "C" to "D." Cooler temperatures in the house may cause the compressor to operate less frequently, thus allowing the freezer compartment to warm somewhat. To protect your frozen food supply, leave your *lettered* setting at this colder setting for the entire winter or for whatever period of time you are turning down your thermostat. This is especially important when the thermostat is turned down for an extended period.

This change should have no effect on your fresh food compartment. However, if freezing occurs, turn the numbered control one step warmer, as from "5" to "4."

When you stop turning the thermostat down, turn temperature controls back to their regular settings.

## Automatic Energy Saver System

You won't find an "energy saver" switch on this refrigerator.

Warm liquid from the refrigerator's condenser is automatically circulated around the front edge of the freezer compartment to help keep moisture from forming on the outside of the refrigerator during humid weather.

Many refrigerators use special electric heaters. This refrigerator needs none. That's why there is no "energy saver" switch... there's no need for it.

## No Defrosting

It is not necessary to defrost the freezer or fresh food compartments. Your refrigerator is designed and equipped to defrost itself automatically.



# Food Storage Suggestions

## Suggested storage times\*

Eating quality drops after time shown	DAYS IN REFRIGERATOR AT 35° to 40°F.	MONTHS IN FREEZER AT 0°F.
	<b>Fresh Meats</b>	
Roasts (Beef & Lamb) .....	3 to 5	6 to 12
Roasts (Pork & Veal) .....	3 to 5	4 to 8
Steaks (Beef) .....	3 to 5	6 to 12
Chops (Lamb) .....	3 to 5	6 to 9
Chops (Pork) .....	3 to 5	3 to 4
Ground & Stew Meats .....	1 to 2	3 to 4
Variety Meats .....	1 to 2	3 to 4
Sausage (Pork) .....	1 to 2	1 to 2
<b>Processed Meats</b>		
Bacon .....	7	1
Frankfurters .....	7	½
Ham (Whole) .....	7	1 to 2
Ham (Half) .....	3 to 5	1 to 2
Ham (Slices) .....	3	1 to 2
Luncheon Meats .....	3 to 5	Freezing not recom- mended.
Sausage (Smoked) .....	7	
Sausage (Dry & Semi-Dry) .....	14 to 21	
<b>Cooked Meats</b>		
Cooked Meats and		
Meat Dishes .....	3 to 4	2 to 3
Gravy & Meat Broth .....	1 to 2	2 to 3
<b>Fresh Poultry</b>		
Chicken & Turkey (Whole) .....	1 to 2	12
Chicken (Pieces) .....	1 to 2	9
Turkey (Pieces) .....	1 to 2	6
Duck & Goose (Whole) .....	1 to 2	6
Giblets .....	1 to 2	3
<b>Cooked Poultry</b>		
Pieces (Covered with Broth) .....	1 to 2	6
Pieces (Not Covered) .....	3 to 4	1
Cooked Poultry Dishes .....	3 to 4	4 to 6
Fried Chicken .....	3 to 4	4
<b>(Other than for meats &amp; poultry) FREEZER</b>		
Most fruits and vegetables .....	8-12 months	
Lean fish .....	6-8 months	
Fatty fish, rolls and breads, soups, stew, casseroles .....	2-3 months	
Cakes, pies, sandwiches, leftovers (cooked), Ice cream (original carton) .....	1 month max.	

New techniques are constantly being developed. Consult the College or County Extension Service or your local Utility Company for the latest information on freezing and storing foods.

\*U.S. Department of Agriculture

Meats, fish and poultry purchased from the store vary in quality and age; consequently, safe storage time in your refrigerator will vary.

### To store unfrozen meats, fish and poultry:

- Always remove store wrappings.
- Rewrap in foil, film or wax paper and refrigerate immediately.

To store cheese, wrap well with wax paper or aluminum foil, or put in a plastic bag.

- Carefully wrap to expel air and help prevent mold.
- Store pre-packaged cheese in its own wrapping if you wish.

To store vegetables, use the vegetable drawers—they've been designed to preserve the natural moisture and freshness of produce.

- Covering vegetables with a moist towel helps maintain crispness.
- As a further aid to freshness, pre-packaged vegetables can be stored in their original wrapping.

*Note: Special fresh food compartment drawers (on models so equipped) make it unnecessary to wrap certain foods which they've been designed to preserve. These drawers are described on pages 10 and 11.*

To store ice cream—Fine-quality ice cream, with high cream content, will normally require slightly lower temperatures than more "airy" already-packaged brands with low cream content.

- It will be necessary to experiment to determine the freezer compartment location and temperature control setting to keep your ice cream at the right serving temperature.
- The rear of the freezer compartment is slightly colder than the front.

### Tips on freezing foods

There are three essential requirements for efficient home freezing.

- 1. Initial quality.** Freeze only top-quality foods. Freezing retains quality and flavor; it cannot improve quality.
- 2. Speed.** The quicker fruits and vegetables are frozen after picking, the better the frozen product will be. You'll save time, too, with less culling and sorting to do.
- 3. Proper packaging.** Use food wraps designed especially for freezing; they're readily available at most food stores.

To freeze meat, fish and poultry, wrap well in freezer-weight foil (or other heavy-duty wrapping material) forming it carefully to the shape of the contents. This expels air. Fold and crimp ends of the package to provide a good, lasting seal.

Don't refreeze meat that has completely thawed; meat, whether raw or cooked, can be frozen successfully only once.

Limit freezing of fresh (unfrozen) meats or seafoods to number of pounds at a time as follows:

TFX22R, TFXH22R,	
TFX22V .....	21 pounds
TFX24R, TFXW24R,	
TFX24V .....	26 pounds

### For convenience...

- Store like things together. This saves both time and electricity because you can find foods faster.
- Place the oldest items up front so they can be used up promptly.
- Use shelves on the door for most often used sauces and condiments.
- Use the meat drawer for meats you do not freeze.

### To save money in energy and food costs

- Place most perishable items, such as milk, cream or cottage cheese, toward the rear of the top shelf, as they will stay coldest in this part of the fresh food compartment.
- Cover moist foods with tight lids, plastic film or foil.
- Leaf vegetables and fruits placed in drawers will last longer when stored in closed plastic containers or wrapped in plastic film.
- Do not overload your fresh food or freezer compartment with a lot of warm food at one time.
- Open the door the fewest times possible to save electrical energy.
- When going out of town for several days, leave as few perishables as possible in the refrigerator. Set the icemaker to the "OFF" position and shut off water to the refrigerator.

# General Electric Food-Saver System

## Moist 'n Fresh Drawer

The full-width top drawer is designed to keep **unwrapped foods** fresh by retaining the natural moisture content of foods such as:

- Artichokes
- Asparagus
- Beets, topped
- Blueberries
- Carrots
- Celery
- Cherries
- Corn
- Currants
- Greens, leafy
- Lettuce
- Parsley
- Peas, green
- Plums
- Radishes
- Rhubarb
- Spinach
- Tomatoes, ripe

As in any refrigerated storage area, it is recommended that **odorous foods be stored wrapped**—foods such as:

- Broccoli
- Brussels Sprouts
- Cabbage
- Cauliflower
- Green Onions
- Parsnips
- Turnips

Storage time will depend upon the type of food and its condition when placed in the drawer.

Excess water which may accumulate in the bottom of the Moist 'n Fresh drawer should be poured out and the drawer wiped dry.

The Moist 'n Fresh drawer is partially sealed by gaskets attached to the cover at the front and back edges. *Always push the drawer all the way in.*

## Convertible Meat Keeper

The Convertible Meat Pan drawer has its own cold air duct to allow a stream of cold air from the freezer compartment to flow around the drawer.

The **variable temperature control** regulates the air flow from the freezer compartment.

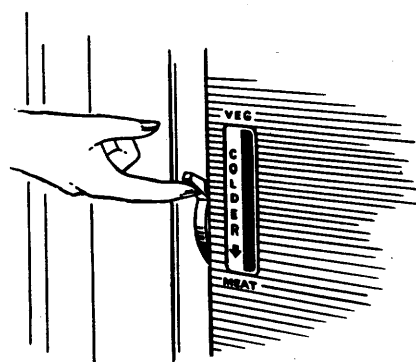
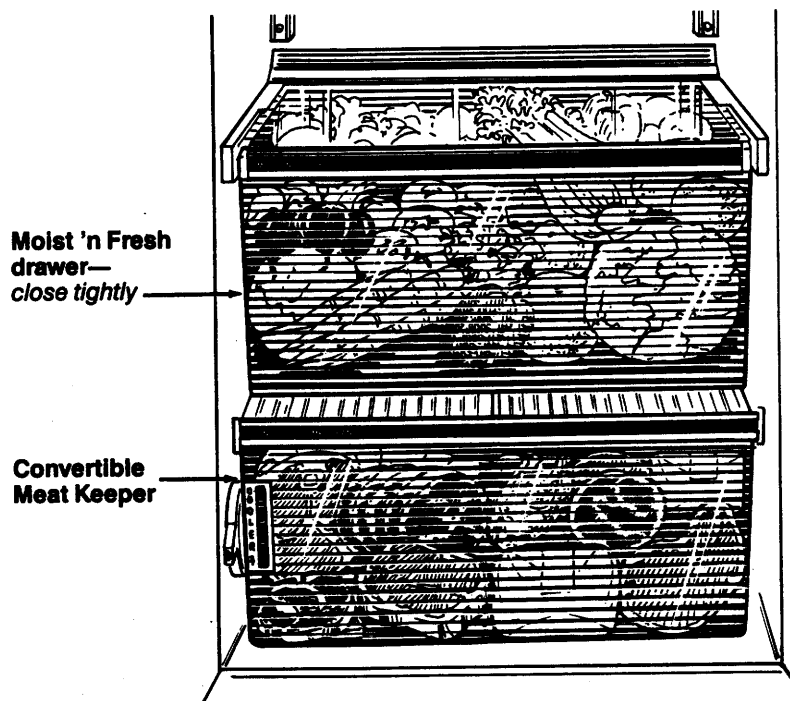

Set control lever to **MEAT**—the coldest setting—to store fresh meats. If lever is left in meat position for a long period of time, some frost may form on the inside of the drawer.

Set control lever to **VEG** to convert the drawer to normal refrigerator temperature and provide extra vegetable storage space. Cold air duct is turned off.

Variable settings between these extremes can be selected.

## Drawer Removal

Drawers will stop before coming all the way out of refrigerator to help prevent contents from spilling onto floor. Drawers can easily be removed by tilting up slightly and pulling past "stop" location.

**To remove drawers when the fresh food compartment door cannot be opened fully:**

1. Remove food from the shelf above the Moist 'n Fresh drawer and take out the shelf. Take food off of the glass cover and out of the drawer.

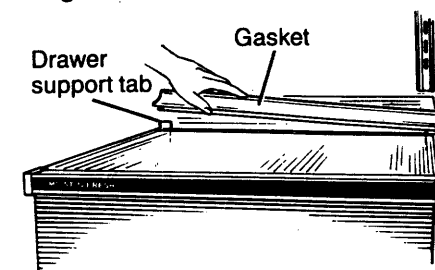

2. Remove the flexible gasket at the rear of the Moist 'n Fresh drawer. Lift each end straight up until the slots on the gasket are free of the drawer support tabs.

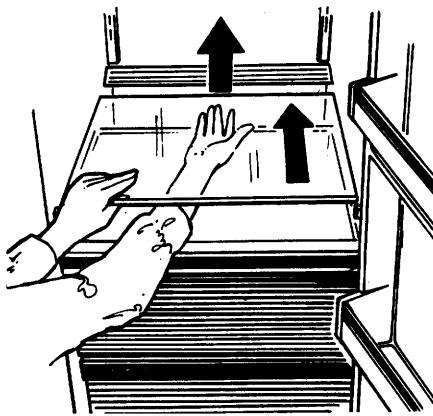

3. Pull the drawer part-way out. Reach in, push the rear of the glass up and, at the same time, push it back until it clears the front corner retainers.

4. Tilt and remove the cover.



5. Pull the drawer forward, lift the front to clear stops, and remove the drawer. If the refrigerator door doesn't open completely, pull the drawer out until it hits the door. Then lift the drawer up until it is higher than the drawer supports, tilt it and take it out.

6. If tape holds Convertible Meat Pan cover to drawer supports, remove the tape. Pull drawer partway out. Reach in, push the rear of the glass up and, at the same time, back, until it clears front-corner retainers.

7. Tilt and remove the cover.

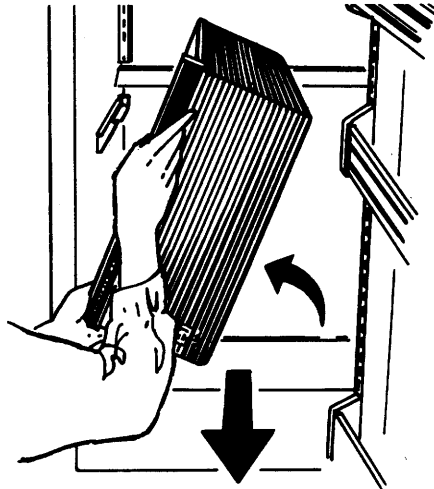

8. Tilt and remove the drawer.

After cleaning, replace in reverse order.

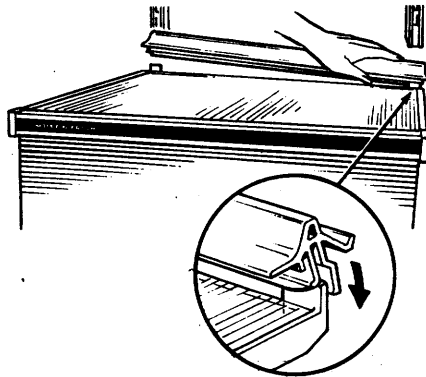

9. Reinstall the gasket at the rear of the Moist 'n Fresh drawer. Fit the end of the plastic drawer support into the slot on the gasket, with the rubber gasket flap facing you. Make sure the gasket snaps into place.

## Sealed Snack Pack

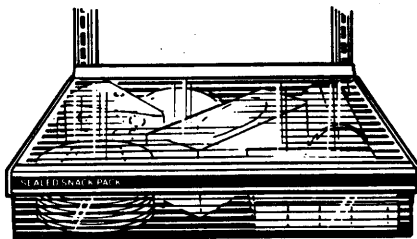

The Sealed Snack Pack—and shelf to which it is attached—can be relocated within the Fresh Food compartment. The sealed drawer retains high humidity for convenient storage of meats and cheese, bacon, hors d'oeuvres, spreads and snacks.

## Shelf Positions

### How to Rearrange Your Shelves

#### Adjustable Shelves

Shelves in the fresh food and freezer compartments are adjustable, enabling you to make efficient shelf arrangements to fit your family's food storage needs.

#### Tempered Glass Shelves in Fresh Food Compartment

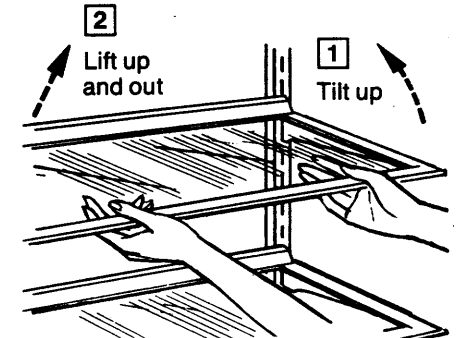

To remove shelves: Tilt shelf up at front, then lift it up and out of tracks on rear wall of refrigerator.

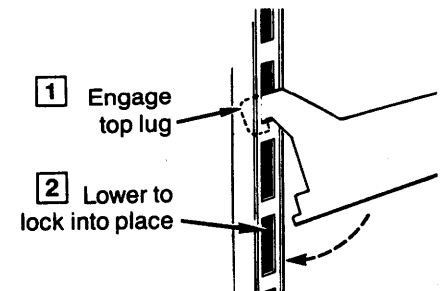

To relocate shelves: Select desired shelf height. With shelf front raised slightly, engage top lugs in tracks at rear of cabinet. Then lower front of shelf until it locks into position.

## Shelf Positions (continued)

### Porta-bins on Fresh Food Compartment Door (on models so equipped)

Adjustable Porta-Bins can easily be carried from refrigerator to work area. A dozen eggs in their original carton will fit securely in a Porta-Bin.

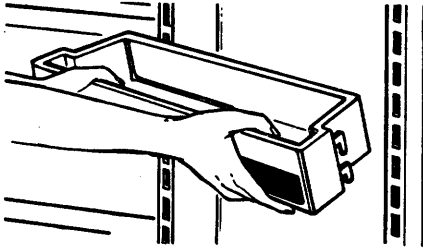

**To remove:** Lift Porta-Bin straight up until mounting hooks disengage.

**To relocate:** Select desired shelf height, engage Porta-Bin's hook in slots on the tracks of the door, and push in. Porta-Bin will lock in place.

### Multi-Position Shelves in Freezer Compartment

Shelf supports at various levels in the freezer compartment let you reposition the shelves from time to time to better accommodate your variable inventory of frozen foods.

**To reposition shelves:**

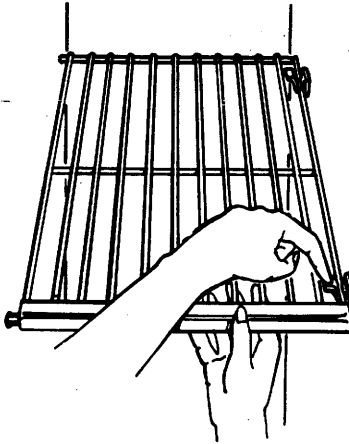

1. While pressing tabs on shelf supports on right wall, lift shelf out of grooves in supports.

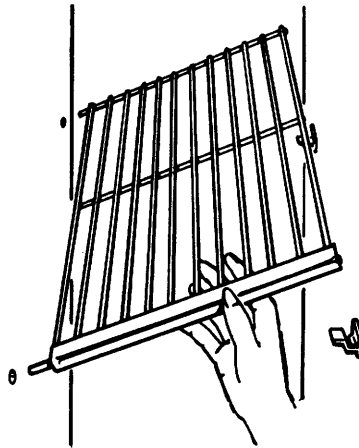

2. Pull shelf sideways until shelf rods come out of holes on left wall.

3. Select desired shelf height and insert shelf rods into holes on left wall. **If shelf supports at desired level on right wall have tabs,** lower shelf into grooves on support while pressing tabs. Be sure shelf wire is fully inserted into grooves.

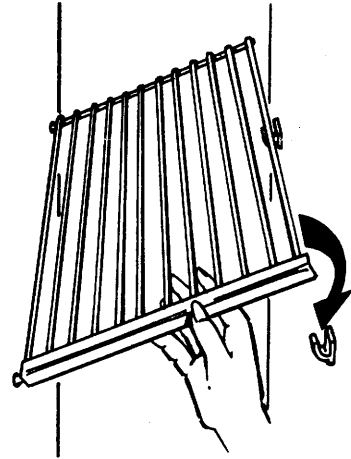

**If shelf supports at desired level on right wall do not have tabs,** merely lower shelf into place on supports.

# Care and Cleaning

## Cleaning—Outside

The water and ice dispenser spill shelf should be wiped dry immediately to prevent spotting. Water left on the shelf may leave deposits that you can remove by soaking with undiluted vinegar. You can also use a paste of non-precipitating water softener (such as Calgon brand) and water, or one teaspoon of citric acid powder per pint of hot tap water. Soak until the deposit disappears or becomes loose enough to rinse away. Usually 30 minutes soaking time is adequate. Avoid using wax on the spill shelf and trim.

The door handles and trim can be cleaned with a cloth dampened with a solution of mild liquid dishwashing detergent and water. Dry with a soft cloth. Don't use wax on the door handles and trim.

**Keep the finish clean.** Wipe with a clean cloth lightly dampened with kitchen appliance wax or mild liquid dishwashing detergent. Dry and polish with a clean, soft cloth. Do not wipe the refrigerator with a soiled dishwashing cloth or wet towel. These may leave a residue that can erode the paint. Do not use scouring pads, powdered cleaners, bleach or cleaners containing bleach because these products can scratch and weaken the paint finish.

**Protect the paint finish.** The finish on the outside of the refrigerator is a high quality, baked-on paint finish. With proper care, it will stay new-looking and rust-free for years. Apply a coat of kitchen/appliance wax when the refrigerator is new and then at least twice a year.

Appliance Polish Wax & Cleaner (Cat. No. WR92X216) is available from GE Appliance Parts Marts.

## Cleaning—Inside

Inside the fresh food and freezer compartments should be cleaned at least once a year. Unplug the refrigerator before cleaning. If this is not practical, wring excess moisture out of sponge or cloth when cleaning around switches, lights or controls.

Use warm water and baking soda solution—about a tablespoon of baking soda to a quart of water. This both cleans and neutralizes odors. Rinse thoroughly with water and wipe dry.

Other parts of the refrigerator—including door gaskets, meat and vegetable drawers, ice storage bin and all plastic parts—can be cleaned the same way. Do not use cleansing powders or other abrasive cleaners.

To help prevent odors, leave an open box of baking soda in the rear of the refrigerator, on the top shelf. Change the box every three months. An open box of baking soda in the freezer will absorb stale freezer odors.

**Do not wash any plastic parts from your refrigerator in your automatic dishwasher.**

**Drain opening in freezer compartment.** During yearly cleaning, remove bottom freezer basket and flush a solution of baking soda—one teaspoon and two cups of hot (not boiling) water—through the drain line with the help of a meat baster. This will help eliminate odor and reduce the likelihood of a clogged drain line.

If drain becomes clogged, use a meat baster and baking-soda-and-water solution to force the clog through the drain line.

Continue flushing until line is clear, then empty and replace the defrost water pan immediately.

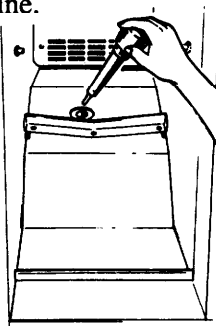

## Behind Refrigerator

Care should be taken in moving your refrigerator away from the wall. All types of floor coverings can be damaged, particularly cushioned coverings and those with embossed surfaces. Pull the refrigerator straight out and return it to position by pushing it straight in. Moving your refrigerator in a side direction may result in damage to your floor covering or refrigerator.

## Condenser

The condenser is located behind the base grille. For most efficient operation, remove the base grille (see page 4) and either sweep away or vacuum up dust that is readily accessible. This easy cleaning operation should be done at least once a year.

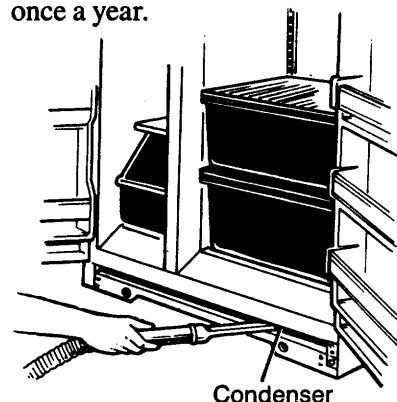

## Defrost Water Pan

Pan behind base grille should be cleaned at least once a year. When reinstalling pan, firmly push it ALL THE WAY IN until it stops.

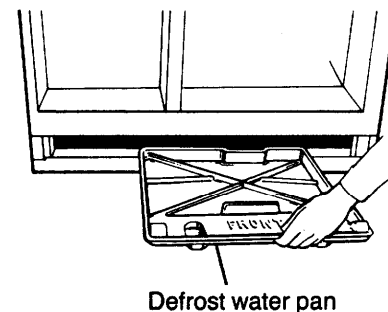

## Light bulb replacement

### In Fresh Food Compartment

1. Unplug refrigerator.
2. To align the control knob properly, note position of numbered control for proper reassembly and pull off knob.

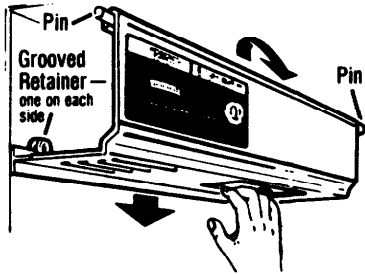

3. Pull bottom of light panel down about 1/4"—just enough to disengage lip at rear from grooves in retainers on rear wall.

4. Lift panel to disengage top from pins on side walls; remove panel.

After replacing with same size bulb, reinstall panel (hang top on pins; pull bottom down, push it back and release it to let lip engage grooves in retainers). Replace temperature control knob in OFF position, turn it to previous setting, and plug refrigerator back in.

### In Freezer Compartment

1. Unplug refrigerator.

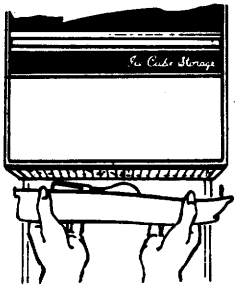

2. Remove shelf just below light shield. (Shelf will be easier to remove if it is emptied first.)
3. Pull plastic light shield toward you. (It will bend to free tabs from grooves.)

After replacing with same size bulb, reinstall shield and shelf and plug refrigerator back in.

## When you go on vacation

For extended vacations or absences, shut off power to refrigerator, turn the numbered control to OFF, clean interior with baking soda solution of one tablespoon of soda to one quart of water. Wipe dry. To prevent odors, leave open box of soda in refrigerator. Leave doors open.

For shorter vacations, remove perishable foods and leave controls at regular settings. However, if room temperature is expected to drop below 60°F., follow same instructions as for extended vacations.

Move icemaker feeler arm to OFF (up) position and be sure to shut off water supply to the refrigerator.

## When you move

Disconnect power cord from wall outlet, remove all food and clean and dry the interior.

Secure all loose items such as grille, shelves and storage pans by taping them securely in place to prevent damage.

Be sure refrigerator stays in *upright position* during actual moving and in van. Refrigerator must be secured in van to prevent movement. Protect outside of refrigerator with blanket.

## Water filter accessory

The perfect companion to your automatic icemaker—a water filter

Your ice cubes can only be as fresh-tasting as the water that produces them. That's why it's a good idea to purify your water with a water filter.

Its activated charcoal removes musty, stale odors and unpleasant medicinal, metallic tastes. A porous fiber cartridge catches dirt, rust particles, sand and silt while special crystals reduce deposits of hard scale.

The water filter is an option at extra cost and is available from your GE dealer. Specify WR97X214. It has complete installation instructions and installs in minutes on 1/4" O.D. copper water line.

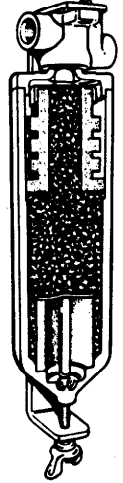

## Rapid Electrical Diagnosis

Your refrigerator is wired for accurate electrical diagnosis in your home—takes only minutes for a service technician to check its entire electrical system. No need for the technician to unplug, move or unload the refrigerator to make the diagnosis.



## Questions? Use This Problem Solver

PROBLEM	POSSIBLE CAUSE AND REMEDY
REFRIGERATOR DOES NOT OPERATE	<ul style="list-style-type: none"> <li>• May be in defrost cycle when motor does not operate for about 30 minutes.</li> <li>• Temperature control in OFF position.</li> <li>• If interior light is not on, refrigerator may not be plugged in at wall outlet.</li> <li>• If plug is secure and the refrigerator still fails to operate, plug a lamp or a small appliance into the same outlet to determine if there is a tripped circuit breaker or burned out fuse.</li> </ul>
MOTOR OPERATES FOR LONG PERIODS	<ul style="list-style-type: none"> <li>• Modern refrigerators with more storage space and a larger freezer compartment require more operating time.</li> <li>• Normal when refrigerator is first delivered to your home—usually requires 24 hours to completely cool down.</li> <li>• Large amounts of food placed in refrigerator to be cooled or frozen.</li> <li>• Hot weather—frequent door openings.</li> <li>• Door left open.</li> <li>• Temperature controls are set too cold. Refer to instructions for use of TEMPERATURE CONTROLS on page 8.</li> <li>• Grille and condenser need cleaning. Refer to page 13.</li> <li>• Check ENERGY-SAVING TIPS on page 2.</li> </ul>
MOTOR STARTS & STOPS FREQUENTLY	<ul style="list-style-type: none"> <li>• Temperature control starts and stops motor to maintain even temperatures.</li> </ul>
VIBRATION OR RATTLING	<ul style="list-style-type: none"> <li>• If refrigerator vibrates, more than likely it is not resting solidly on the floor and front roller screws or front leveling legs need adjusting or floor is weak or uneven. Refer to ROLLERS on page 4.</li> <li>• If dishes vibrate on shelves, try moving them. Slight vibration is normal.</li> <li>• Defrost water pan rattling, needs to be positioned properly.</li> </ul>
HOT AIR FROM BOTTOM OF REFRIGERATOR	<ul style="list-style-type: none"> <li>• Normal air flow cooling motor. In the refrigeration process, it is normal that heat be expelled in the area under the refrigerator. Some floor coverings will discolor at these normal and safe operating temperatures. Your floor covering supplier should be consulted if you object to this discoloration.</li> </ul>
DOOR NOT CLOSING PROPERLY	<ul style="list-style-type: none"> <li>• Door gasket on hinge side sticking or folding over. To correct, put a small amount of petroleum jelly on face of gasket.</li> </ul>

(continued next page)

# The Problem Solver (continued)

PROBLEM	POSSIBLE CAUSE AND REMEDY
OPERATING SOUNDS	<ul style="list-style-type: none"> <li>• The high speed compressor motor required to maintain near zero temperatures in the large freezer compartment may produce higher sound levels than your old refrigerator.</li> <li>• Normal fan air flow—one fan blows cold air through the refrigerator and freezer compartments, another fan cools the compressor motor.</li> <li>• These NORMAL sounds will also be heard from time to time:               <ul style="list-style-type: none"> <li>• Defrost timer switch clicks at defrost.</li> <li>• Defrost water dripping into drain pan.</li> <li>• Temperature control clicks ON or OFF.</li> <li>• Refrigerant boiling or gurgling.</li> <li>• Cracking or popping of cooling coils caused by expansion and contraction during defrost and refrigeration following defrost.</li> <li>• With automatic icemaker, the sound of cubes dropping into the bin and water running in pipes as icemaker refills.</li> </ul> </li> </ul>
FRESH FOOD OR FREEZER COMPARTMENT TEMPERATURE TOO WARM	<ul style="list-style-type: none"> <li>• Temperature control not set cold enough. Refer to TEMPERATURE CONTROLS on page 8.</li> <li>• Warm weather—frequent door openings.</li> <li>• Door left open for too long time.</li> <li>• Package may be holding door open.</li> </ul>
FOODS DRY OUT	<ul style="list-style-type: none"> <li>• Foods not covered, wrapped or sealed properly.</li> </ul>
FROST OR ICE CRYSTALS ON FROZEN FOOD	<ul style="list-style-type: none"> <li>• Door may have been left ajar or package holding door open.</li> <li>• Too frequent and too long door openings.</li> <li>• Frost within package is normal.</li> </ul>
SLOW ICE CUBE FREEZING	<ul style="list-style-type: none"> <li>• Door may have been left ajar.</li> <li>• Turn temperature of freezer compartment colder.</li> </ul>
ICE CUBES HAVE ODOR/TASTE	<ul style="list-style-type: none"> <li>• Old cubes need to be discarded.</li> <li>• Ice storage bin needs to be emptied or washed.</li> <li>• Unsealed packages in refrigerator and/or freezer compartments may be transmitting odor/taste to ice cubes.</li> <li>• Interior of refrigerator needs cleaning—refer to page 13.</li> <li>• Poor-tasting incoming water. Install a water filter—see page 14.</li> </ul>



PROBLEM	POSSIBLE CAUSE AND REMEDY
AUTOMATIC ICEMAKER DOES NOT WORK	<ul style="list-style-type: none"> <li>• ON-OFF control in OFF position.</li> <li>• Water supply turned off or not connected.</li> <li>• Freezer compartment too warm.</li> <li>• Cubes too small—water shut-off valve connecting refrigerator to home water line may be clogged.</li> <li>• Sometimes cubes fuse to the side of the ice mold and hold the feeler arm in the OFF (up) position. Remove this ice to restart the icemaker.</li> <li>• When reaching for cubes by hand, you may have pushed the feeler arm into the OFF (up) position by mistake.</li> <li>• Piled up cubes in storage bin may cause icemaker to shut off prematurely. With icemaker feeler arm in OFF (up) position, level cubes in bin by hand.</li> </ul>
CUBE DISPENSER DOES NOT WORK	<ul style="list-style-type: none"> <li>• No ice cubes. Remove storage container. If cubes are frozen to wire arm, remove cubes.</li> <li>• No ice cubes. Icemaker turned off or water supply turned off.</li> <li>• Irregular ice clumps in storage container. Break up as many as you can with fingertip pressure and discard the remaining clumps.</li> </ul>
WATER HAS POOR TASTE/ODOR	<ul style="list-style-type: none"> <li>• If water dispenser has not been used for an extended period, dispense water in regular manner until all water in reservoir is replenished with fresh water.</li> <li>• Poor-tasting incoming water. Install water filter—see page 14.</li> </ul>
WATER IN FIRST GLASS IS WARM	<ul style="list-style-type: none"> <li>• Allow about 24 hours for water to cool to proper temperature after refrigerator is first installed.</li> <li>• If water dispenser has not been used for extended period, water in first glass will not be as cool as succeeding glasses.</li> <li>• If water reservoir has been drained, allow several hours for replenished supply to chill.</li> </ul>
WATER DISPENSER DOES NOT WORK	<ul style="list-style-type: none"> <li>• Water supply line turned off or not connected.</li> <li>• Supply line may be clogged with sediment.</li> </ul>
DIVIDER BETWEEN FRESH FOOD AND FREEZER COMPARTMENT FEELS WARM	<ul style="list-style-type: none"> <li>• Normal warmth is created by automatic energy saver system circulating warm liquid around front edge of freezer compartment to help prevent condensation on outside of refrigerator in hot, humid weather.</li> </ul>
MOISTURE FORMS ON OUTSIDE OF REFRIGERATOR	<ul style="list-style-type: none"> <li>• Not unusual during period of high humidity.</li> </ul>
MOISTURE COLLECTS INSIDE	<ul style="list-style-type: none"> <li>• Too frequent and too long door openings.</li> <li>• In humid weather air carries moisture into refrigerator when doors are opened.</li> </ul>

(continued next page)

## The Problem Solver (continued)

PROBLEM	POSSIBLE CAUSE AND REMEDY
WATER ON KITCHEN FLOOR OR ON BOTTOM OF FREEZER	<ul style="list-style-type: none"><li>• The drain in bottom of freezer may be clogged. Remove any ice on the freezer bottom and clean the drain. Refer to page 13.</li><li>• If you use a glass over 6 inches tall, you may be jamming cubes in the funnel chute. They can fuse inside the chute and drop out later, leaving water or ice on the floor.</li><li>• Defrost water pan full, missing or not in position.</li></ul>
REFRIGERATOR HAS ODOR	<ul style="list-style-type: none"><li>• Foods with strong odors should be tightly covered.</li><li>• Check for spoiled food.</li><li>• Interior needs cleaning. Refer to page 13.</li><li>• Defrost water pan needs cleaning.</li><li>• Keep open box of baking soda in refrigerator; replace every three months.</li></ul>
INTERIOR LIGHT DOES NOT LIGHT	<ul style="list-style-type: none"><li>• No power at outlet.</li><li>• Light bulb needs replacing. See page 14.</li></ul>

If you need more help...call, toll free:  
GE Answer Center®  
800.626.2000  
consumer information service

## **If You Need Service**

To obtain service, see your warranty on the back page of this book.

We're proud of our service and want you to be pleased. If for some reason you are not happy with the service you receive, here are three steps to follow for further help.

**FIRST**, contact the people who serviced your appliance. Explain why you are not pleased. In most cases, this will solve the problem.

**NEXT**, if you are still not pleased, write all the details—including your phone number—to:

Manager, Consumer Relations  
GE Appliances  
Appliance Park  
Louisville, Kentucky 40225

**FINALLY**, if your problem is still not resolved, write:

Major Appliance  
Consumer Action Panel  
20 North Wacker Drive  
Chicago, Illinois 60606

# YOUR GE REFRIGERATOR WARRANTY

Save proof of original purchase date such as your sales slip or cancelled check to establish warranty period.

## WHAT IS COVERED

### FULL ONE-YEAR WARRANTY

For one year from date of original purchase, we will provide, free of charge, parts and service labor in your home to repair or replace **any part of the refrigerator** that fails because of a manufacturing defect.

### FULL FIVE-YEAR WARRANTY

For five years from date of original purchase, we will provide, free of charge, parts and service labor in your home to repair or replace **any part of the sealed refrigerating system** (the compressor, condenser, evaporator and all connecting tubing) that fails because of a manufacturing defect.

### LIMITED LIFETIME WARRANTY

For the life of the refrigerator, we will replace, free of charge, **any tinted see-through pan or drawer made from Lexan® polycarbonate resin** and furnished with the refrigerator if the pan or drawer breaks during normal household use. Drawer covers are not included. The drawers can be exchanged at a General Electric Appliance Parts Mart, Factory Service Center, or by writing to the address below.

This warranty is extended to the original purchaser and any succeeding owner for products purchased for ordinary home use in the 48 mainland states, Hawaii and Washington, D.C. In Alaska the warranty is the same except that it is LIMITED because you must pay to ship the product to the service shop or for the service technician's travel costs to your home.

All warranty service will be provided by our Factory Service Centers or by our authorized Customer Care® servicers during normal working hours.

Look in the White or Yellow Pages of your telephone directory for GENERAL ELECTRIC COMPANY, GENERAL ELECTRIC FACTORY SERVICE, GENERAL ELECTRIC-HOTPOINT FACTORY SERVICE or GENERAL ELECTRIC CUSTOMER CARE® SERVICE.

## WHAT IS NOT COVERED

- Service trips to your home to teach you how to use the product.

**Read your Use and Care material.** If you then have any questions about operating the product, please contact your dealer or our Consumer Affairs office at the address below, or call, toll free:  
GE Answer Center®  
800.626.2000  
consumer information service

- Improper installation.

If you have an installation problem, contact your dealer or installer. You are responsible for providing adequate electrical, plumbing and other connecting facilities.

- Replacement of house fuses or resetting of circuit breakers.
- Failure of the product if it is used for other than its intended purpose or used commercially.
- Damage to product caused by accident, fire, floods or acts of God.

**WARRANTOR IS NOT RESPONSIBLE FOR CONSEQUENTIAL DAMAGES.**

Some states do not allow the exclusion or limitation of incidental or consequential damages, so the above limitation or exclusion may not apply to you. This warranty gives you specific legal rights, and you may also have other rights which vary from state to state. To know what your legal rights are in your state, consult your local or state consumer affairs office or your state's Attorney General.

**Warrantor: General Electric Company**

**If further help is needed concerning this warranty, write:  
Manager—Consumer Affairs, GE Appliances, Louisville, KY 40225**

Part No. 468332P08  
Pub. No. 49-6596

TFX22R TFX24R  
TFXH22R TFXW24R  
TFX22V TFX24VL

## Free Manuals Download Website

<http://myh66.com>

<http://usermanuals.us>

<http://www.somanuals.com>

<http://www.4manuals.cc>

<http://www.manual-lib.com>

<http://www.404manual.com>

<http://www.luxmanual.com>

<http://aubethermostatmanual.com>

Golf course search by state

<http://golfingnear.com>

Email search by domain

<http://emailbydomain.com>

Auto manuals search

<http://auto.somanuals.com>

TV manuals search

<http://tv.somanuals.com>