

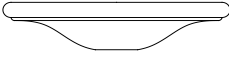







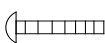

Fixture Name: Madera 1821-3P BI

This fixture assembled PO: \_\_\_\_\_ Date: \_\_\_\_\_

**Notice:** Please review the parts listing and check for all parts before assembling the fixture. If any parts are missing or damaged, please note on this sheet and contact the place of purchase to arrange for replacement parts.

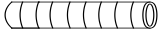
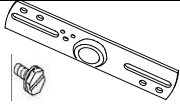
| <b>PARTS LIST</b>   |  | Company Name: _____ Co. Account #: _____<br>to be filled out by retailer  |  |
|---|--|---|--|
| Canopy<br>1ea @5-1/2"x1-1/2"<br>                   | Wire Connectors<br>3ea P4 Orange<br>                 | Top Loop<br>1ea 90 x 98mm<br>          |  |
| Chain<br>1ea 6ft x4.2mm<br>                        | Junction Box Screw<br>2ea 8/32" x 1"<br>             | Spring Washer<br>1ea @15 x 2mm<br>     |  |
| Chain Connector<br>2ea @4.2X50mm<br>               | Canopy Loop with Collar<br>1ea @3/8 x 40mm x 5mm<br> | Nipple<br>1ea @3/8 x 50mm<br>          |  |
| Mounting Strap w/ ground screw<br>1ea 3/4"x4"<br> | Hex Nut<br>2ea @3/8 x 3mm<br>                        | Decorative Chain (support)<br>3ea<br> |  |
| Part Needed _____   | Quantity _____   |   |  |
| Part Needed _____   | Quantity _____   |   |  |
| Reason why _____  | ( missing, scratched, broken glass, bent, bad finish)  |   |  |
| Comments _____  |  |   |  |

## FIXTURE ASSEMBLY INSTRUCTIONS

Read and review installation instruction sheet before assembling the fixture.

### ASSEMBLING THE FIXTURE (Fig. 1)

1. Attach one end of Support Chain (N) to the hooks of Top Loop (J) and the other end to the hooks on Fixture Body (M). Note: The hooks are the metal curls shown in the diagram.
2. Feed the fixture wires through Top loop (J) and pull the wires until taut.

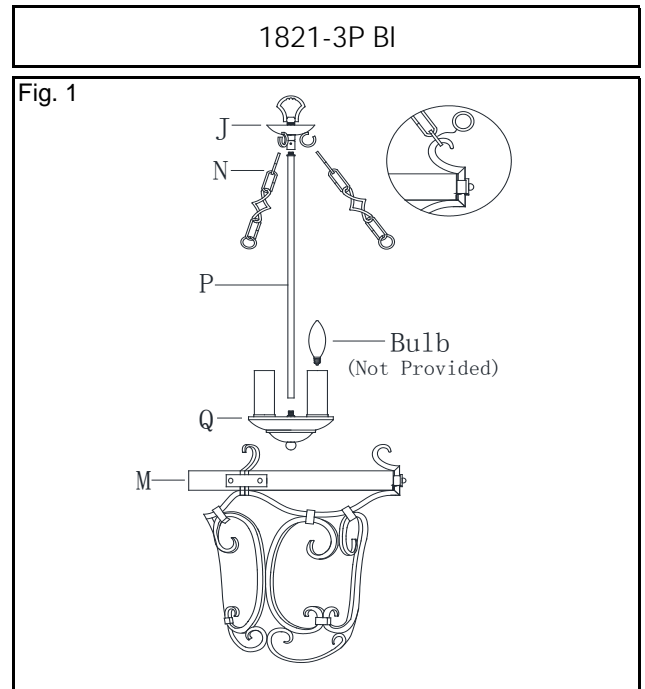

# PARTS & ASSEMBLY SHEET

Fixture Name: Madera 1821-3P BI

## ASSEMBLING THE FIXTURE (Fig. 2)

4. Measure to determine the correct number of links needed for proper hanging height. Use a pair of pliers to open one link of Chain (K). Remove and discard the excess chain.

5. Use one Chain Connector (L) to attach one end of the chain to the Top loop (J) and close the chain connector.

6. Feed the fixture wires through the chain (every three links) and pull the wires until taut.

7. Slip Canopy Loop Collar (H) over the chain, then do the same with the Canopy (G).

8. When ready to complete the installation, use the other chain connector and attach the other end of the chain to the canopy loop (F) and close the chain connector.

9. Make sure the weight of the chandelier will be supported by the chain-not the electrical wire.

9. Make sure the weight of the chandelier will be supported by the chain and not by the electrical wire.

\* You may now install the fixture.

Note: Complete these remaining steps after the fixture is hung.

10. Install the light bulbs (not provided) in accordance with the fixture's specifications.

(DO NOT EXCEED MAXIMUM WATTAGE RATING)

Fig. 2

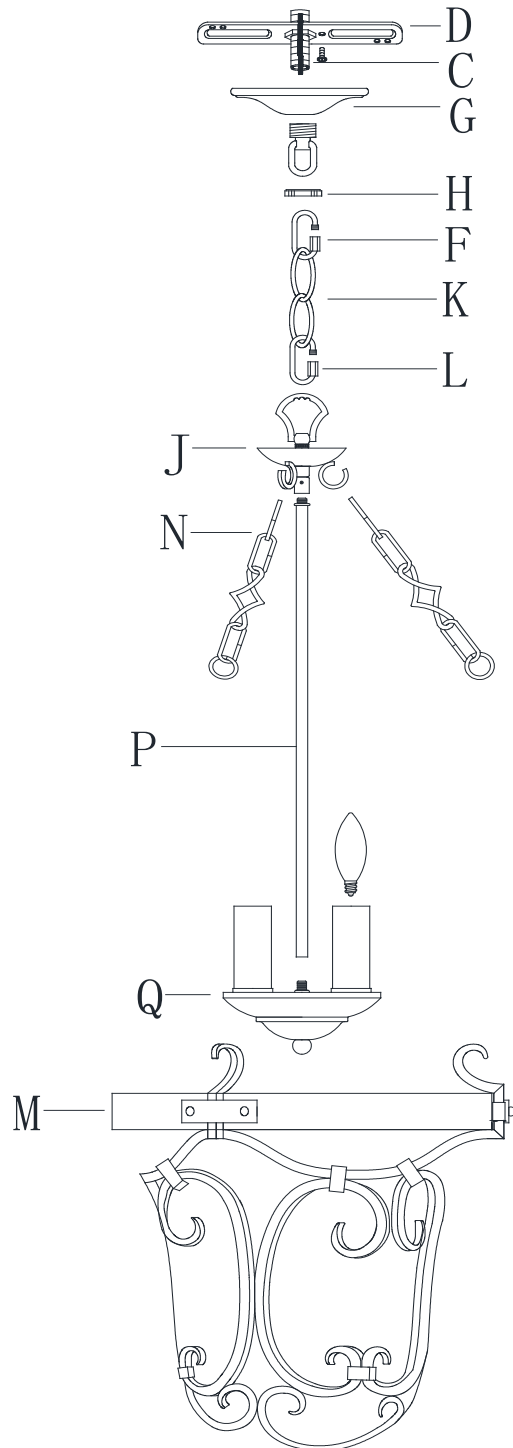



# INSTALLATION INSTRUCTIONS

Fixture Name: Madera 1821-3P BI

For Chandelier Light Fixture

## WARNING ! SHUT OFF POWER AT FUSE OR CIRCUIT BREAKER.

### HANGING THE FIXTURE (Fig. 1)

1. Carefully remove the new fixture from the carton and the yellow bag that holds all parts. Check that all parts are included as shown in the illustration and parts list.
2. Shut off the power at the circuit breaker and remove the old fixture from ceiling, including the old mounting strap.
3. Thread Nipple (C) onto Canopy Loop (F) until snug.
4. Thread the other end of the Nipple (C) with Canopy Loop (F) attached into Mounting Strap (D).
5. Place Lock Washer (B) over the end of Nipple (C) which should protrude through Mounting Strap (D). Then, thread Hex Nuts (A) onto the nipple until tight.
6. Take this mounting strap assembly and mount it to the ceiling junction box with Junction Box Screws (E). Tighten the screws securely with screw driver.
7. Unscrew Canopy Loop Collar (H) from the canopy loop. Take the canopy and pass over the canopy loop. Approximately one half of the canopy loop exterior threads should be exposed. Adjust until the desired height is reached. Note: The Canopy loop collar should fit snugly on the canopy loop after the canopy is installed. Remove the canopy and canopy lock collar.
8. Assemble the fixture and have an assistant or secure support to hold the weight of the fixture while you complete the wiring connections.
9. Thread the fixture wires and ground wire of the assembled fixture through the canopy loop and nipple and into the outlet box.

### CONNECTING THE WIRES (Fig. 2)

10. Attach the power supply wires to the fixture lead wires by connecting BLACK to BLACK (or SMOOTH) and WHITE to WHITE (or RIBBED).
11. Attach the GROUND wire (GREEN or COPPER) from the Junction Box and the fixture Ground wire to the green Ground Screw on the Mounting Bracket (D) or connect both wires together using the correct size of wire connectors.  
**NOTE:** Twist the wires together in the same direction you twist the wire connector onto the wires.
12. Tuck these wire connections neatly into the Junction Box.
13. Raise Canopy (G) to the ceiling and secure in place by tightening Canopy Loop Collar (H) into Canopy Loop (F).
14. Install the light bulbs as per the fixture assembly sheet.

Fig. 1

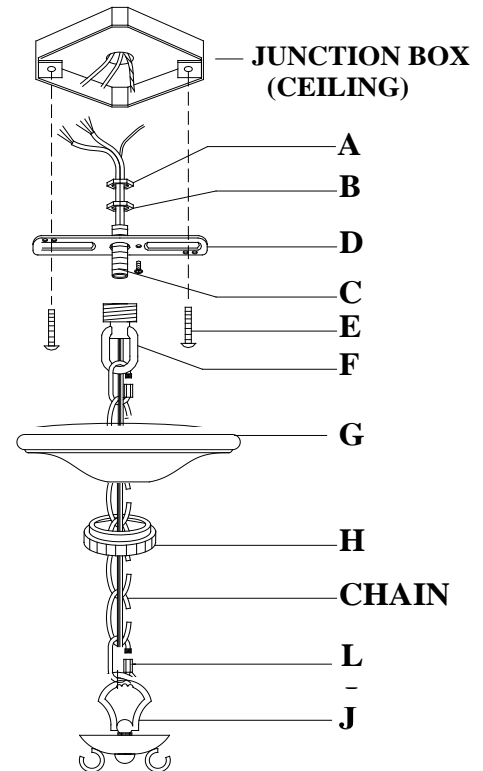
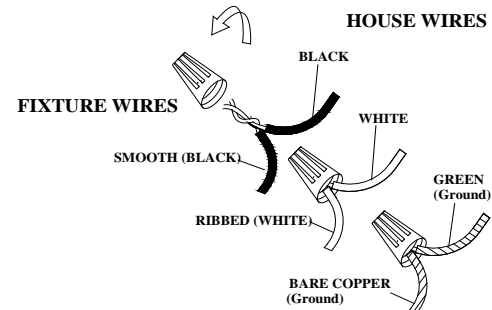

Fig. 2



YOUR INSTALLATION IS NOW COMPLETE.  
RETURN POWER TO THE JUNCTION BOX  
AND TEST THE FIXTURE.

## Free Manuals Download Website

<http://myh66.com>

<http://usermanuals.us>

<http://www.somanuals.com>

<http://www.4manuals.cc>

<http://www.manual-lib.com>

<http://www.404manual.com>

<http://www.luxmanual.com>

<http://aubethermostatmanual.com>

Golf course search by state

<http://golfingnear.com>

Email search by domain

<http://emailbydomain.com>

Auto manuals search

<http://auto.somanuals.com>

TV manuals search

<http://tv.somanuals.com>