



Wet/Dry Vacuums

## Operator's Manual



**2.5 Gallon**  
Model No.  
**VOM205P**

### FOR YOUR SAFETY

Read and understand this manual before use.

Keep this manual for future reference.



**Intertek**  
3084514

CONFORMS TO UL  
STD. No. 1017  
Certified to CSA STD.  
C22.2 No.243-10

www.vacmaster.com  
Cleva North America  
44 Parkway Commons, Greer, SC 29650

Part No. VO70BZ.40.60.01

# TABLE OF CONTENTS

SECTION	Page
Warranty.....	2
Safety Instructions and Warnings.....	3
Double Insulation Instructions.....	4
Extension Cord.....	4
Unpacking and Checking Carton Contents.....	5
General Assembly Instructions.....	6
Dry Vacuuming Operation.....	7
Liquid Vacuuming Operation.....	8
Blowing Operation.....	9
Maintenance.....	9
Installing & Cleaning Reusable Cloth Filter.....	10
Installing & Cleaning Foam Sleeve Filter.....	10
Troubleshooting.....	11
Exploded View and Parts List.....	12

**Thank you for purchasing this Vacmaster<sup>®</sup> wet/dry vacuum cleaner. Feel confident that with Vacmaster<sup>®</sup> you are obtaining a high quality product engineered for optimal performance. This vacuum is capable of picking up liquids and dry materials.**

**FOR YOUR SAFETY CAREFULLY READ AND UNDERSTAND ALL INSTRUCTIONS**

## WARRANTY

We take pride in producing a high quality, durable product. This Vacmaster<sup>®</sup> product carries a limited two (2) year warranty against defects in workmanship and materials from date of purchase under normal household use. If product is to be used for commercial, industrial or rental use, a 90 day limited warranty will apply. Warranty does not apply to defects due to direct or indirect abuse, negligence, misuse, accidents, repairs or alterations and lack of maintenance. Please keep your receipt as proof of purchase. This warranty gives you specific legal rights, and you may have other rights, which vary from state to state. For product service call Customer Service at (866) 384-8432

# SAFETY INSTRUCTIONS & WARNINGS

## IMPORTANT SAFETY INSTRUCTIONS

### Read and understand all instructions before using this vacuum

Read and understand this owner's manual and all labels on the Wet/Dry Vacuum cleaner before operating. Safety is a combination of common sense, staying alert and knowing how your vacuum works. Use this Wet/Dry Vac only as described in this manual. To reduce the risk of personal injury or damage to your Wet/Dry Vac, use only Vacmaster<sup>®</sup> recommended accessories.

Household Type

## SAVE THIS MANUAL FOR FUTURE REFERENCE.

When using an electrical appliance, basic precautions should always be followed including the following:

### **WARNING:** TO REDUCE THE RISK OF FIRE, ELECTRIC SHOCK OR INJURY:

- Do not run vac unattended.
- Do not vacuum, or use this Wet/Dry Vac near flammable liquids, gases, or explosive vapors like gasoline or other fuels, lighter fluids, cleaners, oil-based paints, natural gas, hydrogen, or explosive dusts like coal dust, magnesium dust, grain dust, or gun power. Sparks inside the motor can ignite flammable vapors or dust.
- Do not vacuum anything that is burning or smoking, such as cigarettes, matches, or hot ashes.
- Keep cord away from heated surfaces.
- Do not expose to rain. Store indoors.
- Do not unplug by pulling on cord. To unplug, grasp the plug, not the cord.
- Do not use with damaged cord, plug or other parts.
- If your Wet/Dry Vac is not working as it should, has missing parts, has been dropped or damaged, left outdoors or dropped into water, return it to an independent service center.
- Do not pull or carry by cord, use cord as handle, close a door on cord, or pull cord around sharp edges or corners.
- Do not run Wet/Dry Vac over cord.
- Do not handle plug or the Wet/Dry Vac with wet hands.
- To reduce the risk of health hazards from vapors or dusts, do not vacuum toxic materials.
- Do not use or store near hazardous materials.
- Do not use this Wet/Dry Vac with a torn filter or without the filter installed except when vacuuming liquids as described in the operation section of this manual.
- Do not allow to be used as a toy. Close attention is necessary when used by or near children.
- To reduce the risk of injury from accidental starting, unplug power cord before changing or cleaning filter.
- Do not leave Wet/Dry Vac unattended when plugged in. Unplug from outlet when not in use and before servicing.
- Turn off Wet/Dry Vac before unplugging.
- Do not put any object into ventilation openings. Do not vacuum with any ventilation openings blocked; keep free of dust, lint, hair or anything that may reduce air flow.
- Keep hair, loose clothing, fingers, and all parts of body away from openings and moving parts.
- To reduce the risk of falls, use extra care when cleaning on stairs.

### When using as blower:

- Direct air discharge only at work area.
- Do not use Wet/Dry Vac as a sprayer.
- Do not direct air at bystanders.
- Keep children away when blowing.
- Wear safety goggles.

# DOUBLE INSULATION INSTRUCTIONS

This Wet/Dry Vac is double-insulated, eliminating the need for a separate grounding system. Use only identical replacement parts. Read the instructions for Servicing Double-Insulated Wet/Dry Vacs before servicing. Use this Wet/Dry Vac as described in this manual. Observe the following warnings that appear on the motor housing of your Wet/Dry Vac.



**DOUBLE INSULATED - GROUNDING NOT REQUIRED - WHEN SERVICING USE ONLY IDENTICAL REPLACEMENT PARTS.**

**WARNING: TO REDUCE THE RISK OF ELECTRIC SHOCK-DO NOT EXPOSE TO RAIN. STORE INDOORS.**

**WARNING: FOR YOUR OWN SAFETY, READ AND UNDERSTAND OPERATOR'S MANUAL. DO NOT RUN UNATTENDED. DO NOT PICK UP HOT ASHES, COALS, TOXIC, FLAMMABLE OR OTHER HAZARDOUS MATERIALS, DO NOT USE AROUND EXPLOSIVE LIQUIDS OR VAPORS.**

## CAUTION:

- Do not vacuum drywall dust or fireplace soot or ash with standard Wet/Dry filter. This is a very fine dust which will not be captured by the filter and may cause damage to motor. When vacuuming fine dust use a fine dust filter.

**WARNING: SERVICING OF DOUBLE-INSULATED WET/DRY VACUUM**  
**WITH A DOUBLE-INSULATED WET/DRY VACUUM, TWO SYSTEMS OF INSULATION ARE PROVIDED INSTEAD OF GROUNDING. NO GROUNDING MEANS IS PROVIDED ON A DOUBLE-INSULATED APPLIANCE, NOR SHOULD A MEANS FOR GROUNDING BE ADDED. SERVICING A DOUBLE INSULATED WET/DRY VACUUM REQUIRES EXTREME CARE AND KNOWLEDGE OF THE SYSTEM, AND SHOULD BE DONE ONLY BY QUALIFIED SERVICE PERSONNEL. REPLACEMENT PARTS FOR A DOUBLE-INSULATED WET/DRY VACUUM MUST BE IDENTICAL TO THE PARTS THEY REPLACE. YOUR DOUBLE-INSULATED WET/DRY VAC IS MARKED WITH THE WORDS 'DOUBLE INSULATED' AND THE SYMBOL  (SQUARE WITHIN A SQUARE) MAY ALSO BE MARKED ON THE APPLIANCE.**

- To reduce the risk of electric shock-unplug before cleaning or servicing.
- DO NOT use without filters in place.

**CAUTION: TO REDUCE THE RISK OF INJURY FROM MOVING PARTS- UNPLUG BEFORE SERVICING.**

# EXTENSION CORDS

When using an extension cord with your Wet/Dry Vac refer to the following table to determine the required A.W.G. wire size. Before using the cleaner make sure the power cord and extension cord are in good working conditions. Make repairs or replacements before using the vacuum cleaner. Only use extension cords that are rated for outdoor use.

	Length of Extension Cord			
	25 Feet 7.5 Meters	50 Feet 15.25 Meters	100 Feet 30.5 Meters	150 Feet 45.7 Meters
Amps	A.W.G Wire Size			
0-6	18	16	16	14
7-10	18	16	14	12
11-12	16	16	14	12
13-16	14	12	Not recommended	

# UNPACKING AND CHECKING CARTON CONTENTS

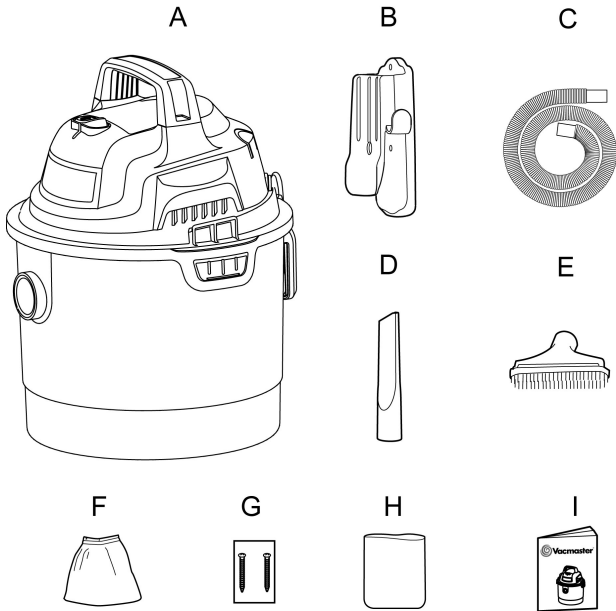

Remove entire contents of carton. Check each item against the carton contents list.

Key Description.....	QTY
A Vac Assembly.....	1
B Wall Mounting Support.....	1
C Hose .....	1
D Crevice Tool.....	1
E 2-in-1 Utility Nozzle..	1
F Cloth Filter.....	1
G Screws.....	2
H Foam Filter.....	1
I Operator's Manual.....	1

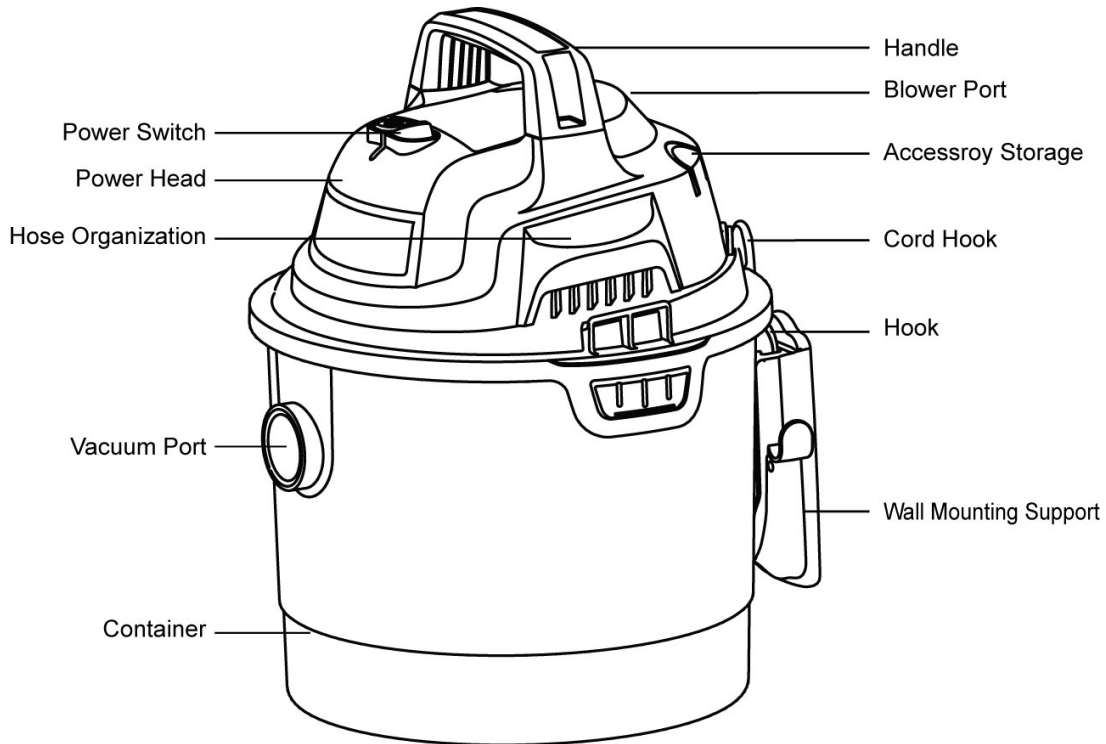

# GENERAL ASSEMBLY INSTRUCTIONS

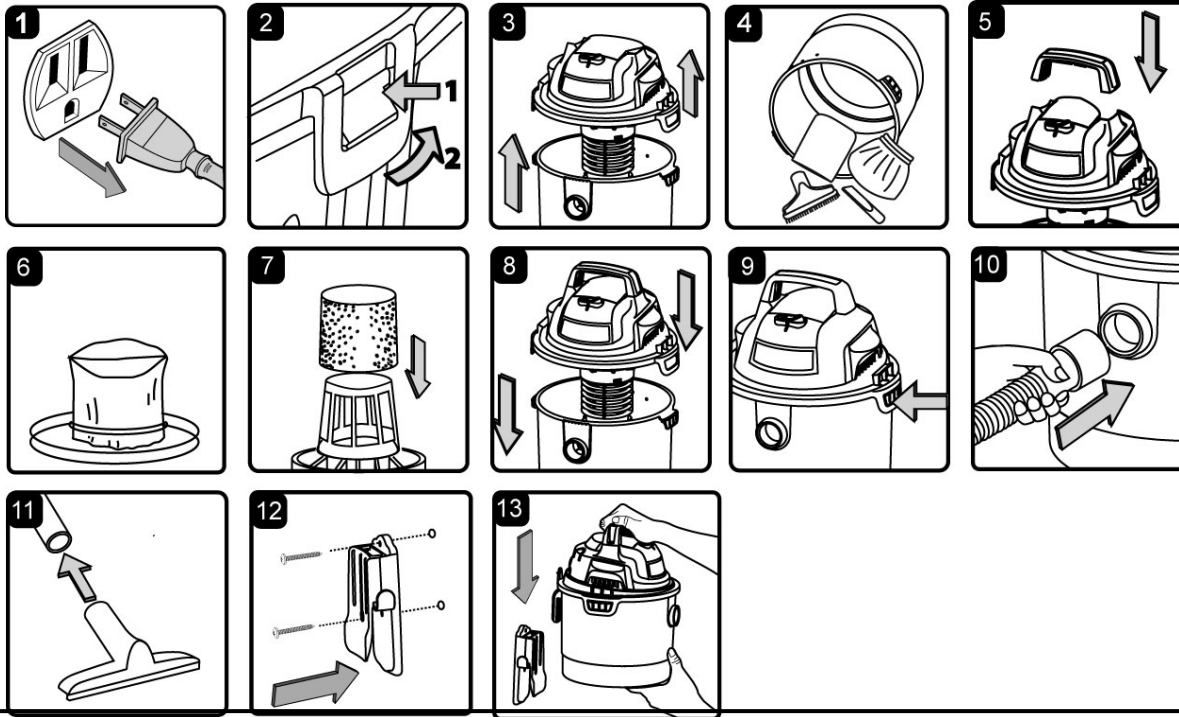

**WARNING: DO NOT PLUG IN POWER CORD TO POWER OUTLET, MAKE SURE PLUG IS DISCONNECTED BEFORE ASSEMBLING THE WET/DRY VAC.**

#### **UNPACKING YOUR WET/DRY VACUUM & GENERAL ASSEMBLY**

1. Verify that the power cord is disconnected from the outlet. (fig. 1)
2. Undo the latches. (fig. 2)
3. Lift the power head off the container. (fig. 3)
4. Remove the contents from inside the container, make sure you have all contents as listed on page 5. (fig. 4)
5. Find the handle and insert the ends into the handle opening on the power head. Apply force to lock the handle into place. (fig. 5)
6. For dry vacuum cleaning, install the supplied reusable cloth filter. (fig. 6) See page 10 for filter installation.
7. For wet vacuum cleaning, install the supplied foam filter. (fig. 7) See page 10 for filter installation.
8. Place the power head back on the container, aligning the top section with the latches, and snap into place. (fig. 8 & 9)
9. Insert the larger end of the hose into the desired port. (fig. 10)
10. Choose the desired accessories and insert onto the end of the hose. (fig. 11)

**For your convenience this vacuum comes with a wall mounting support for storage.**

#### **IMPORTANT!**

- Do not mount the rack over 5 feet from the floor.
  - Do not screw the rack to drywall only. Secure the screws to a stud.
  - Do not hang from or sit on the vacuum when on mounting rack.
11. Align the two screw holes so that they are over a stud and secure the mounting support to the wall stud with the two screws provided. (fig. 12)
  12. Place the wet and dry vacuum cleaner into the support. (fig. 13)

#### **POLARIZED PLUG**

To reduce the risk of electrical shock, this appliance has a double polarized plug (one with the blade wider than the other). This plug will fit in a polarized outlet only one way. If the plug does not fit fully in the outlet, reverse the plug. If it still does not fit, contact a qualified electrician to install the proper outlet. Do not change the plug in any way. Double insulation  eliminates the need for the three wire grounded power cord and grounded power supply system.

## DRY VACUUM OPERATION

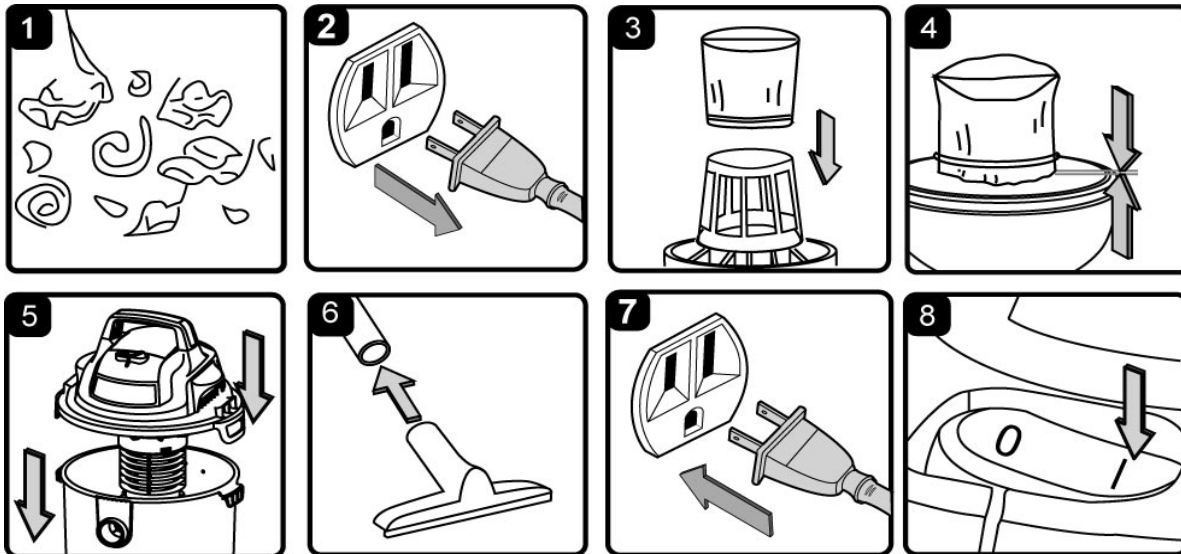

### DRY VACUUMING

**WARNING: BE SURE TO READ, UNDERSTAND, AND APPLY INFORMATION, ENTITLED 'SAFETY INSTRUCTIONS & WARNINGS'. DO NOT VACUUM IN AREAS WITH FLAMMABLE GASES, VAPORS, OR EXPLOSIVE DUSTS IN THE AIR. FLAMMABLE GASES OR VAPORS INCLUDE BUT ARE NOT LIMITED TO; LIGHTER FLUID, SOLVENT TYPE CLEANERS, OIL-BASE PAINTS, GASOLINE, ALCOHOL OR AEROSOL SPRAYS. EXPLOSIVE DUSTS INCLUDE BUT ARE NOT LIMITED TO; COAL, MAGNESIUM, GRAIN OR GUN POWDER. TO REDUCE THE RISK OF HEALTH HAZARDS FROM VAPORS OR DUST, DO NOT VACUUM TOXIC MATERIALS.**

1. Verify that the power cord is disconnected from the outlet. (fig. 2)
2. In order to prepare your vacuum for dry vacuuming, make sure the filter is completely covering the filter cage against the power head. (fig. 3 & 4) (Your Wet/Dry Vac comes with the reusable cloth filter pre-installed, if not installed, see page 10 for installation instructions.)
3. Place the power head section back on the container, and secure it in place using the latches. (fig. 5)

### OPERATING INSTRUCTIONS: DRY VACUUMING

4. Insert the larger end of the hose into the vacuum port on the power head. Push the required attachment onto the free end of the hose or extension. (fig. 6)
5. Plug in the power cord into the outlet. (fig. 7)
6. Turn the motor on by flipping the switch to the 'I' ON position and begin vacuuming. (fig. 8)
7. Once you have completed vacuuming, flip the switch to the 'O' OFF position and unplug the power cord from the outlet.

O = OFF      I = ON

**DO NOT USE THE REUSABLE CLOTH FILTER FOR LIQUID VACUUMING.**

# LIQUID VACUUM OPERATION

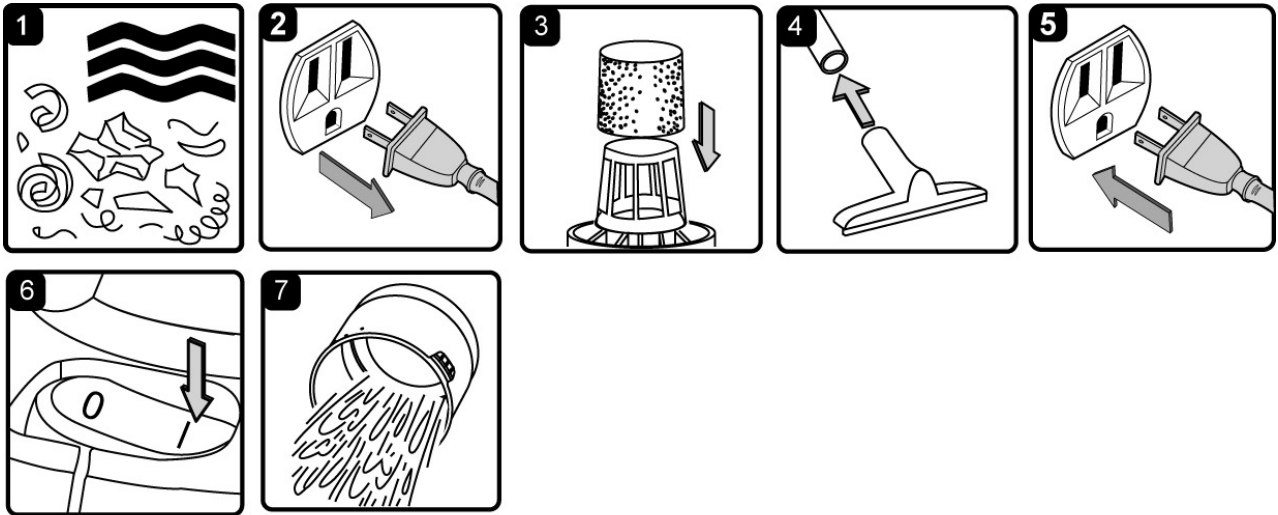

## LIQUID VACUUMING

**WARNING: BE SURE TO READ, UNDERSTAND, AND APPLY INFORMATION, ENTITLED 'SAFETY INSTRUCTIONS & WARNINGS'. DO NOT VACUUM IN AREAS WITH FLAMMABLE GASES, VAPORS, OR EXPLOSIVE DUSTS IN THE AIR. FLAMMABLE GASES OR VAPORS INCLUDE BUT ARE NOT LIMITED TO; LIGHTER FLUID, SOLVENT TYPE CLEANERS, OIL-BASE PAINTS, GASOLINE, ALCOHOL OR AEROSOL SPRAYS. EXPLOSIVE DUSTS INCLUDE BUT ARE NOT LIMITED TO; COAL, MAGNESIUM, GRAIN OR GUN POWDER. TO REDUCE THE RISK OF HEALTH HAZARDS FROM VAPORS OR DUST, DO NOT VACUUM TOXIC MATERIALS.**

**WARNING: DO NOT PLUG IN POWER CORD TO POWER OUTLET, MAKE SURE PLUG IS DISCONNECTED BEFORE ASSEMBLING THE WET/DRY VAC**

1. Verify that the power cord is disconnected from the outlet. (fig. 2)
2. Remove reusable cloth filter, then carefully install the foam sleeve filter over the filter cage and place the power head back on the container. (fig. 3) See filter installing instructions on page 10.

**DO NOT USE THE REUSABLE CLOTH FILTER FOR LIQUID VACUUMING.**

### OPERATING INSTRUCTIONS – WET VACUUMING

3. Fit the desired nozzle to the vacuum hose. (fig. 4)
4. Verify that the switch is in the 'O' OFF position before plugging the power cord into the outlet. (fig. 5)
5. Turn the motor on by flipping the switch to the 'I' ON position. (fig. 6)
6. After use, empty the container, clean and dry the inside and outside before storage. (fig. 7)

**IMPORTANT!** When vacuuming large quantities of liquids, do not immerse the nozzle completely in the liquid; leave a gap at the tip of the nozzle opening to allow air inflow. The machine is fitted with a float valve that stops the suction action when the container reaches its maximum capacity. You will notice an increase in motor speed. When this happens, turn off the machine, disconnect from power supply, and drain the liquid into a suitable receptacle or drain. To continue vacuuming, refit the container with the drain cap. After wet vacuuming, turn the machine off and remove plug from power supply. Empty the container, clean and dry the inside and outside before storage.

**REMEMBER!** The foam filter must be removed after wet vacuuming, and a reusable cloth filter must be installed before dry vacuuming again.



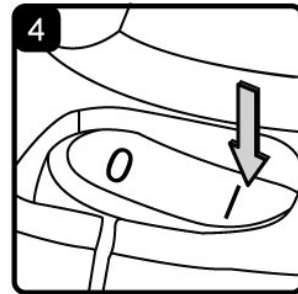
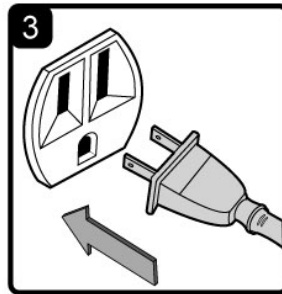
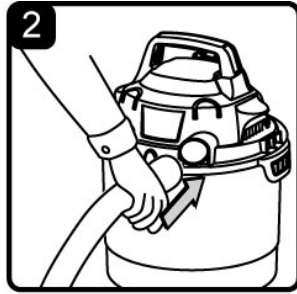
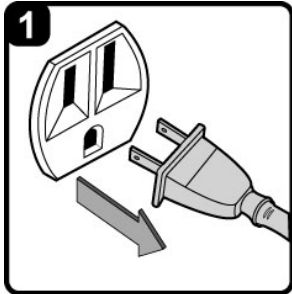

This Wet/Dry Vac has blowing capabilities. To use the blower feature follow the instructions listed.

**WARNING: ALWAYS WEAR SAFETY GOGGLES COMPLYING WITH ANSI Z87.1 (OR IN CANADA, CSAZ94.3) BEFORE USING BLOWER.**

**WARNING: KEEP BYSTANDERS CLEAR FROM BLOWING DEBRIS.**

**WARNING: WEAR A DUST MASK IF BLOWING CREATES DUST THAT MIGHT BE INHALED.**

1. Verify that the power cord is disconnected from the outlet. (fig. 1)
2. Make sure the container is empty before using as a blower.
3. Remove hose from the vacuum port.
4. Insert the larger end of the hose into the blowing port on the backside of the power head. (fig. 2)
5. Ensure the power switch is turned off and plug into the power supply. (fig. 3)
6. Before turning on the vac, firmly hold loose end of the hose. Turn the motor on by flipping the switch to the 'I' ON position. (fig. 4)

## MAINTENANCE & FILTER CLEANING

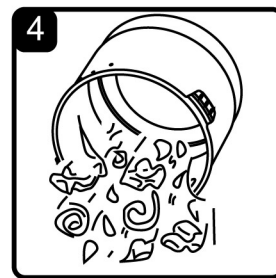
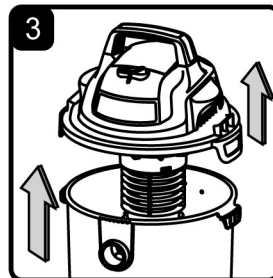
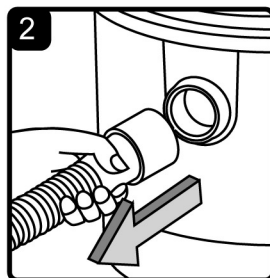
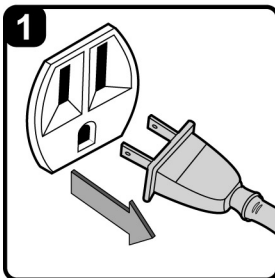

1. Verify that the power cord is disconnected from the outlet. (fig. 1)
2. Disconnect the hose from the vacuum. (fig. 2)
3. Undo the latches and remove the power head from the container. (fig. 3)
4. Clear all dirt or debris from the container and hose. (fig. 4)

**For filter changing and maintenance see instructions on page 10.**

**IMPORTANT!** Clean or change the dust filter regularly for best performance. **ALWAYS USE DUST FILTER FOR DRY VACUUMING.** If the machine is used without the dust filter, the motor will burn out and the warranty will be voided. Always keep spare filters on-hand.

**NOTICE!** The filter included is made of high quality material designed to stop small dust particles. The filter should be used for dry pick-up only. A dry filter is necessary to pick up dust. If the dust filter is wet, it will clog quickly and be very difficult to clean. Handle the filter carefully when removing it for cleaning and

replacing it. Check the filters for tears or small holes, a small hole can let dust pass through and out of the cleaner. Do not use a filter with holes or tears, replace it immediately.

**WARNING: ALWAYS DISCONNECT THE PLUG FROM THE POWER OUTLET BEFORE REMOVING THE POWER HEAD FROM CONTAINER.**

## INSTALLING & CLEANING REUSABLE CLOTH FILTER

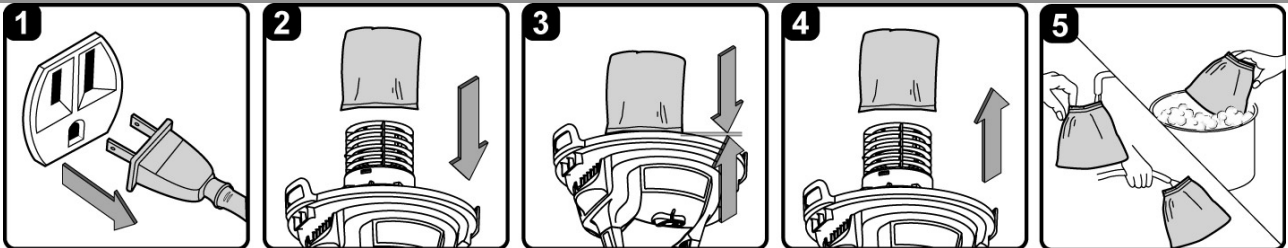

### Installing Reusable Cloth Filter

1. Verify that the power cord is disconnected from the outlet. (fig.1)
2. Remove power head and place in upside down position.
3. Slide reusable cloth filter down over the filter cage making sure the whole cage is covered. (fig. 2 & 3)
4. Replace and lock the power head on to the container.

### Removing and Cleaning Reusable Cloth Filter

1. With the removed power head in the upside down position.
2. Carefully remove the reusable cloth filter from the filter cage. (fig. 4) Clean the filter by gently tapping or brushing dirt off. Cleaning should **not** be done indoors in living areas.
3. Use a mild soap and water solution to wash reusable cloth filter and rinse with clean water. (fig. 5)
4. Allow the wet filter to air dry for 24 hours before installing onto the filter cage.

## INSTALLING & CLEANING FOAM SLEEVE FILTER

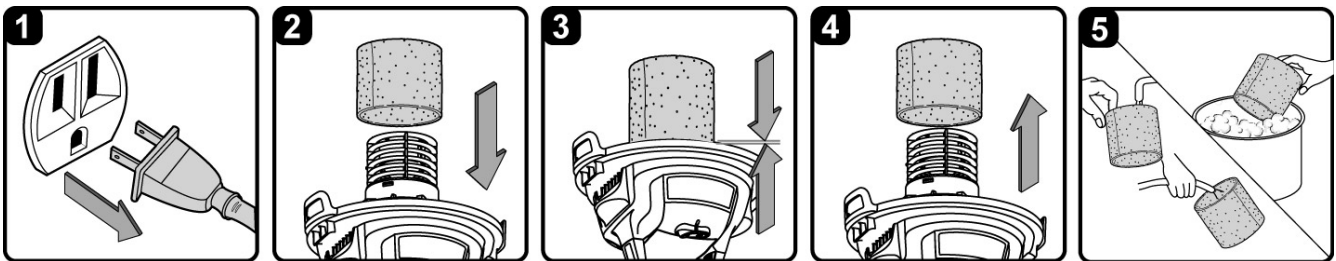

### Installing Foam Sleeve Filter

1. Verify that the power cord is disconnected from the outlet. (fig. 1)
2. Remove power head and place in upside down position. Follow instructions to remove cloth filter.
3. Carefully slide foam sleeve filter down over the filter cage making sure the whole cage is covered. (fig. 2 & 3)
4. Replace the power head on to the container.

### Cleaning Foam Sleeve Filter

1. With the removed power head in the upside down position, carefully remove foam sleeve filter. (fig. 4)
2. Use a mild soap and water solution to wash foam sleeve filter and rinse with clean water. (fig. 5)
3. Allow filter to air dry before installing and using again.

# TROUBLESHOOTING

**WARNING: TO REDUCE THE RISK OF ELECTRIC SHOCK-UNPLUG BEFORE TROUBLESHOOTING**

Symptom	Possible Causes	Corrective Action
Vacuum will not operate.	1) No power supply.	1) Check power supply – cord, breakers, fuses.
	2) Faulty power cord.	2) Unplug and check the power cord. If damaged, have it repaired by a professional.
	3) Container full.	3) Empty container.
Dust comes from motor cover.	1) The reusable cloth filter is missing or damaged.	1) Attach or replace the reusable cloth filter.
Reduced efficiency and motor/speed vibration.	1) There is a blockage in the nozzle, hose, or the vacuum inlets. Or the dust filter is blocked by fine dust.	1) Check nozzle, hose and inlets for blockage. Take off the filter and clean it. Or install new filter.

# EXPLODED VIEW AND PARTS LIST

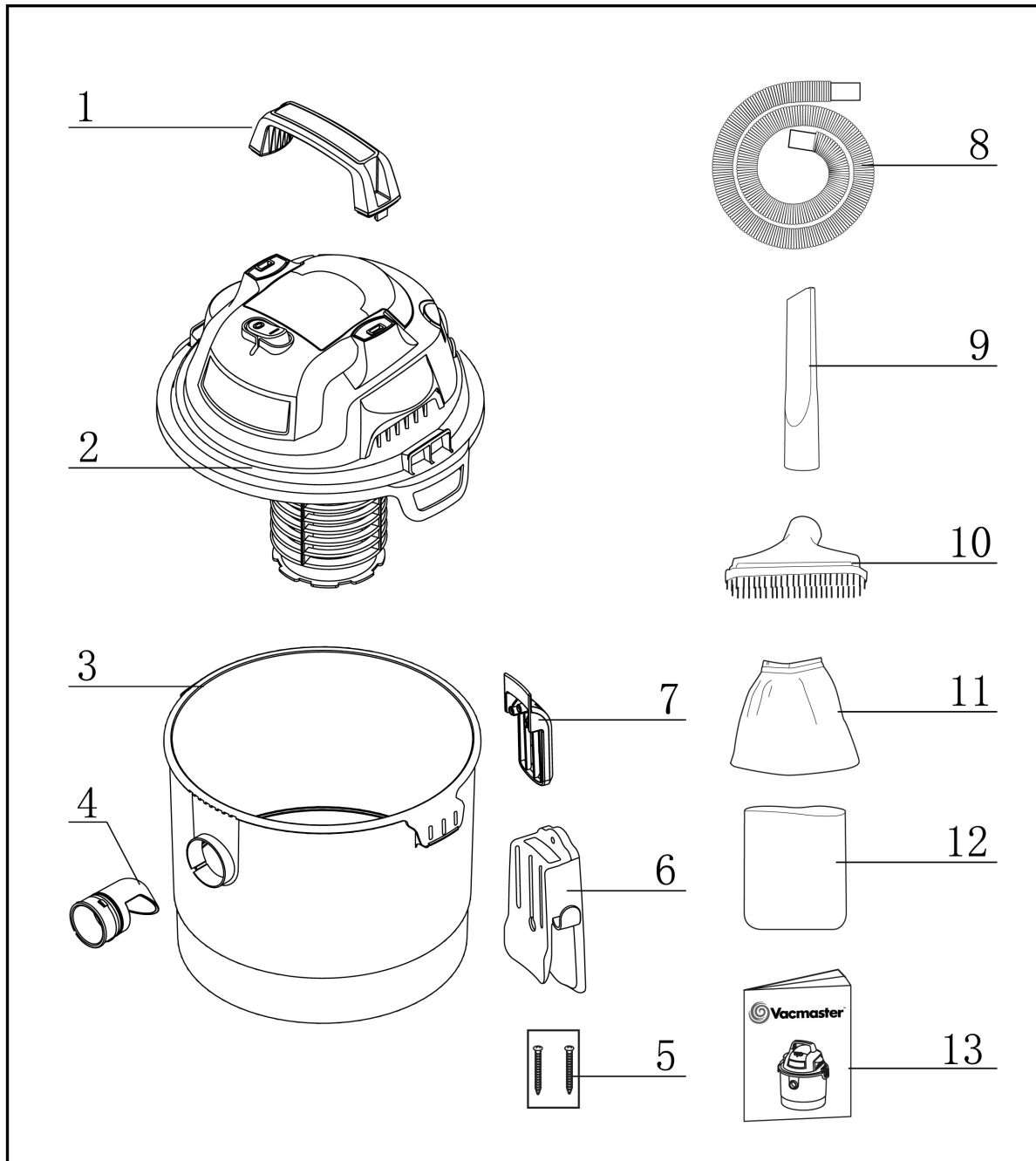

VOM205P Manual Parts List

Key Number	Drawing Number	Description	Quantity	Key Number	Drawing Number	Description	Quantity
1	VO70P0.10.01	Handle	1	8	FV7822.08.00	Hose	1
2	FV9202.01.01	Power Head	1	9	FV7772.02.01	Crevice Tool	1
3	VO70P0.20.01	Container	1	10	FV7774.01.00	2-in-1 Utility Nozzle	1
4	TVQTXK.10.01	Vacuum port	1	11	FV9642.02.00	Cloth Filter	1
5	BOA2ZZ.48.01	Screws	2	12	FV9502.07.00	Foam Filter	1
6	FV9201.02.01	Mounting Support	1	13	VO70BZ.40.60.01	Operator's Manual	1
7	FV9202.01.01	Hook	1				

## Free Manuals Download Website

<http://myh66.com>

<http://usermanuals.us>

<http://www.somanuals.com>

<http://www.4manuals.cc>

<http://www.manual-lib.com>

<http://www.404manual.com>

<http://www.luxmanual.com>

<http://aubethermostatmanual.com>

Golf course search by state

<http://golfingnear.com>

Email search by domain

<http://emailbydomain.com>

Auto manuals search

<http://auto.somanuals.com>

TV manuals search

<http://tv.somanuals.com>