



SERVICE MANUAL

E-Multi series

- 4-WAY CASSETTE INDOOR UNIT
- DUCT INDOOR UNIT
- CONSOLE INDOOR UNIT
- WALL MOUNTED INDOOR UNIT
- OUTDOOR UNIT(28/42000BTU/h)

Haier Commercial Air Conditioner

Version: 200808

CONTENT

1.General information -----	1
1.1 Free Multi series line up -----	1
1.2 Operation temperature range -----	1
2.Description of products & features -----	2
2.1 Product code explanation-----	2
2.2 Product character -----	2
3. Specification -----	3
3.1 Outdoor unit -----	3
3.2 Cassette unit -----	4
3.3 Duct type -----	5
3.4 Console type -----	6
3.5 Wall mounted type -----	7
4. Net dimension of indoor and outdoor-----	7
4.1 AU282XHEAA -----	7
4.2 AU422XIEAA -----	8
4.3 Cassette type (AB07-14) -----	9
4.4 Wall mounted type -----	9
4.5 Cassette type (AB21) -----	10
4.6 Duct type -----	11
4.7 Console type -----	11
5. Part name -----	12
5.1 Cassette type AB07-14-----	12
5.2 Cassette type AB21 -----	12
5.3 Duct type -----	13
5.4 Console type -----	13
5.5 Wall mounted type -----	14
5.6 AU282XHEAA -----	15
5.7 AU422XIEAA -----	15
6. Refrigerant diagram -----	16
6.1 AU282XHEAA -----	16
6.2 AU422XIEAA -----	17
7. The unit capacity and performance mode -----	18
7.1 AU282XHEAA -----	18
7.2 AU422XIEAA -----	20
8. Installation procedure -----	23
8.1 Cassette type AB07-142XCEAA -----	23
8.2 Cassette type AB212XCEAA -----	28
8.3 Duct type AE***XLEAA -----	37
8.4 Console type AF***XCEAA -----	44
8.5 Wall mounted type AS***XCEAA -----	50
9. Wiring diagram, PCB photo and function information -----	54
9.1 AB07-142XCEAA -----	54
9.2 AB212XCEAA -----	58
9.3 AF07-142XCEAA -----	62
9.4 AS***XCEAA -----	66
9.5 Outdoor unit AU282XHEAA, AU422XIEAA-----	68
10. Trouble shooting -----	76
11. Outdoor performance curves -----	77
12. indoor air velocity and temperature distribution curves -----	79
13. Air flow and static pressure chart -----	86

1. General information

1.1 E-Multi (R410a) series line up

				
AB072XCEAA AB092XCEAA AB122XCEAA AB142XCEAA	AB212XCEAA	AD072XLEAA AD092XLEAA AD122XLEAA AD142XLEAA AD212XLEAA	AF072XCEAA AF092XCEAA AF122XCEAA AF142XCEAA	AS072XCEAA AS092XCEAA AS122XCEAA AS142XCEAA
				
AU282XHEAA	AU422XIEAA			

1.2 Operation temperature range

Fixed frequency single unit,multi split unit

			Rated	Maximum	Minimum
Cooling	Indoor	DB °C	27	32	18
		WB °C	19	23	14
	Outdoor	DB °C	35	43	10
		WB °C	24	26	6
Heating	Indoor	DB °C	20	27	15
		WB °C	14.5	--	--
	Outdoor	DB °C	7	24	-7
		WB °C	6	18	--

2.DESCRPTION OF PRODUCTS & FEATURES

2.1. Products code explanation

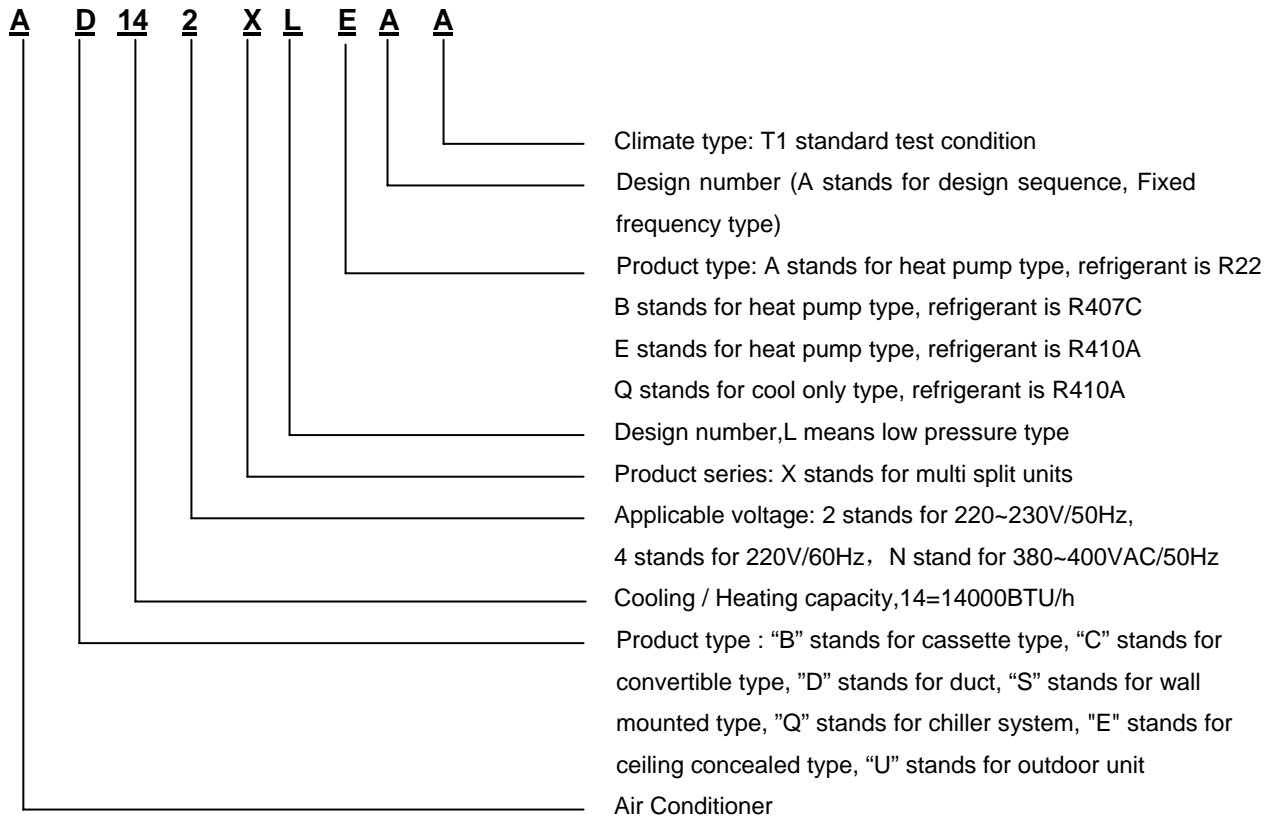

2.2 Product character

2.2.1 Phylogeny

E-Multi(R410A) series is multi split ON/OFF type series, developed based on Free Multi (R407C).

2.2.2 Operating individually and operating simultaneously

The unit can realize individual operation which can control one unit running, stop, and adjusting running mode. Also the unit can operate simultaneously which control multi indoor units at same time.

2.2.3 Variable quantity of indoor unit

If you want to add or reduce the quantity of indoor units (of course the match must correspond with the design), it can meet your need at any time. More convenient, more random.

2.2.4 Universal outdoor unit, multiform indoor unit

We realize universal outdoor unit, and 6 kinds of indoor unit, choose freely according to customer's favor and indoor decoration, more stylish and more beautiful

2.2.5 The total capacity of indoor unit can be more than that of outdoor unit.

When all the indoor units are running at the same time, the actual capacity of every indoor unit is proportional according to outdoor capacity.

2.2.6 Long distribution pipe and high drop

The distance of outdoor and indoor can be max. 15m, and the drop between indoor and outdoor can be max. up to 5m, consequently, the installation can be more free, and can meet various need of the customer.

2.2.7 Duct type unit be equipped with high efficiency filter, and its high static pressure can be up to 30Pa, running more silent, making room air more comfortable and more clean.

2.2.8 Auto-check function

The unit can display the malfunction codes on the control board by using advanced auto-check technology, convenient for user find and dwell with the abnormal running.

2.2.9 Auto-restart function (optional)

All indoor units have auto-restart function. When the power supply cut off suddenly, the unit will automatically recover the previous running mode once the power supply is on

2.2.10 Variable Control modes

Wired remote control, Remote control, Group control, Weekly timer, Group control (For wired type)

2.2.11 universal PCB

Except AB072-142XCEAA types, the other units' PCBs are completely same with Free Multi R407C types, so it's easy to get spare parts, install E-Multi R410a and solve problems.

3. Specification

3.1. Outdoor Units

Model			AU282XHEAA	AU422XIEAA
Capacity				
Cooling		Btu/h	28000	42000
		kw	8.2	12.3
Heating		Btu/h	31000	45000
		kw	9.0	13.0
Electrical parameters				
Power supply		Ph/V/Hz	1PH, 230VAC, 50Hz	
Power input	Cooling	kw	2720	4.08
	Heating	kw	2630	3.8
EER/COP			3.01/3.42	3.01/3.42
Performance				
Air flow	H	m ³ /h	3800	6000
Noise Level	H/M/L	dB(A)	56	60
Installation				
External dimensions(WxHxD)		mm	1068x340x840	948x340x1250
Shipping dimensions(WxHxD)		mm	1100x410x990	1095x410x1400
Net weight/Shipping weight		kg	88/94	105/115
Compressor type	Scroll/Rotary		Rotary	Rotary
Refrigerant type				
Refrigerant liquid pipe		mm	4x6.35	4x6.35
Refrigerant gas pipe		mm	4x9.52	4x9.52
Max pipe length		m	15	15
Max drop between I.N.&O.U		m	5	5

3.2. Cassette Type

Model		AB072XCEAA	AB092XCEAA	AB122XCEAA	AB142XCEAA	AB212XCEAA
Capacity						
Cooling	Btu/h	7000	9000	12000	14000	20000
	kw	2.05	2.6	3.5	4.1	5.8
Heating	Btu/h	8000	10000	13000	15500	2.2
	kw	2.35	2.9	3.8	4.5	6.4
Electrical parameters						
Power supply	Ph/V/Hz	1PH, 230VAC, 50Hz				
Performance						
Air flow	H/M/L	m3/h 600/480/350				1200/1000/800
Noise Level	H/M/L	dB(A) 37/34/32		41/38/33	41/38/33	46/43/40
Installation						
External dimensions(WxHxD)	mm	570/570/260				840/840/240
Shipping dimensions(WxHxD)	mm	718/680/380				930/930/330
Net weight/Shipping weight	kg	17/20	17/20	17/20	19/23.5	27/33
Refrigerant liquid pipe	mm	6.35				9.52
Refrigerant gas pipe	mm	9.52				12.7
Control	Wired /Infrared	Infrared(YR-H71)				
Static pressure	Pa	0				
Panel						
External dimensions	mm	700/700/60				950/950/80
Shipping dimensions	mm	740/750/115				980/980/100
Net weight/Shipping weight	kg	2.8/4.8				6.0/9.0

AB072-142XCEAA Panel : PB-700IA

AB212XCEAA Panel : PB-950IA

3.3. Duct type

Model		AD072XLEAA	AD092XLEAA	AD122XLEAA	AD142XLEAA	AD212XLEAA	
Capacity							
Cooling	Btu/h	7000	9000	12000	14000	21000	
	kw	2.05	2.6	3.5	4.1	6.1	
Heating	Btu/h	8000	10000	14000	15500	22000	
	kw	2.35	2.9	4.1	4.5	6.4	
Electrical parameters							
Power supply	Ph/V/Hz	1PH, 230VAC, 50Hz					
Performance							
Air flow	H/M/L	m3/h	560/450/360/300		820/700/600/500	900/780/600/500	1200/950/700/550
Noise Level	H/M/L	dB(A)	38/34/31/29		44/42/37/33	44/40/35/29	46/44/40/33
Installation							
External dimensions(WxHxD)		mm	674/450/225		828/225/450		1124/450/225
Shipping dimensions(WxHxD)		mm	816/288/526		976/288/526		1272/288/526
Net weight /Shipping weight		kg	18/20	18/20	20/22	20/22	28/32
Refrigerant liquid pipe		mm	6.35	6.35	6.35	6.35	9.52
Refrigerant gas pipe		mm	9.52	9.52	9.52	9.52	12.7
Control	Wired /Infrared		Wired	Wired	Wired	Wired	Wired
Static pressure		Pa	30	30	30	30	30

3.4. Console Type

Model			AF072XCEAA	AF092XCEAA	AF122XCEAA	AF142XCEAA
Capacity						
Cooling	Btu/h		7000	9000	12000	14000
	kw		2.05	2.6	3.5	4.0
Heating	Btu/h		8000	10000	14000	15500
	kw		2.35	2.9	4.1	4.5
Electrical parameters						
Power supply	Ph/V/Hz	1PH, 230VAC, 50Hz				
Performance						
Air flow	H/M/L	m3/h	500/400/320	500/400/320	700/650/600	700/650/600
Noise Level	H/M/L	dB(A)	40/36/34	40/36/34	45/40/37	45/40/37
Installation						
External dimensions(WxHxD)		mm	720/205/630			
Shipping dimensions(WxHxD)		mm	780/280/690			
Net weight/Shipping weight		kg	15.5/19	15.5/19	17/20.7	17/20.7
Refrigerant liquid pipe		mm	6.35	6.35	6.35	6.35
Refrigerant gas pipe		mm	9.52	9.52	9.52	9.52
Control	Wired /Infrared		Infrared	Infrared	Infrared	Infrared
Static pressure		Pa	0	0	0	0

Console type units can be controlled by remote controller(YR-H71), control controller YCZ-A001 and weekly timer YCS-A001, but in central controller installation, it need detector YCJ-A001, console type couldn't be connected with controller YR-E12

3.5. Wall mounted type

Model		AS072XCEAA	AS092XCEAA	AS122XCEAA	AS142XCEAA
Capacity					
Cooling	Btu/h	7000	9000	12000	13000
	kw	2.05	2.6	3.5	3.8
Heating	Btu/h	7350	9500	13000	14500
	kw	2.15	2.8	3.8	4.25
Electrical parameters					
Power supply	Ph/V/Hz	1PH, 230VAC, 50Hz			
Performance					
Air flow	H/M/L	m3/h		350/300/240	
Noise Level	H/M/L	dB(A)		40/35/31	
Installation					
External dimensions(WxHxD)	mm	795x197x265		795x197x265	
Shipping dimensions(WxHxD)	mm	880/315/330			
Net weight/Shipping weight	kg	7.6/10.6			
Refrigerant liquid pipe	mm	6.35			
Refrigerant gas pipe	mm	9.52			
Control	Wired /Infrared	Infrared(YR-H71)			
Static pressure	Pa	0			

E- Multi R410a wall mounted indoor units use same PCB with R407C, they only can be controlled by remote controller, in central control or weekly timer installation, it need detector to set address.

4. Net dimensions of indoor and outdoor

4.1.AU282XHEAA

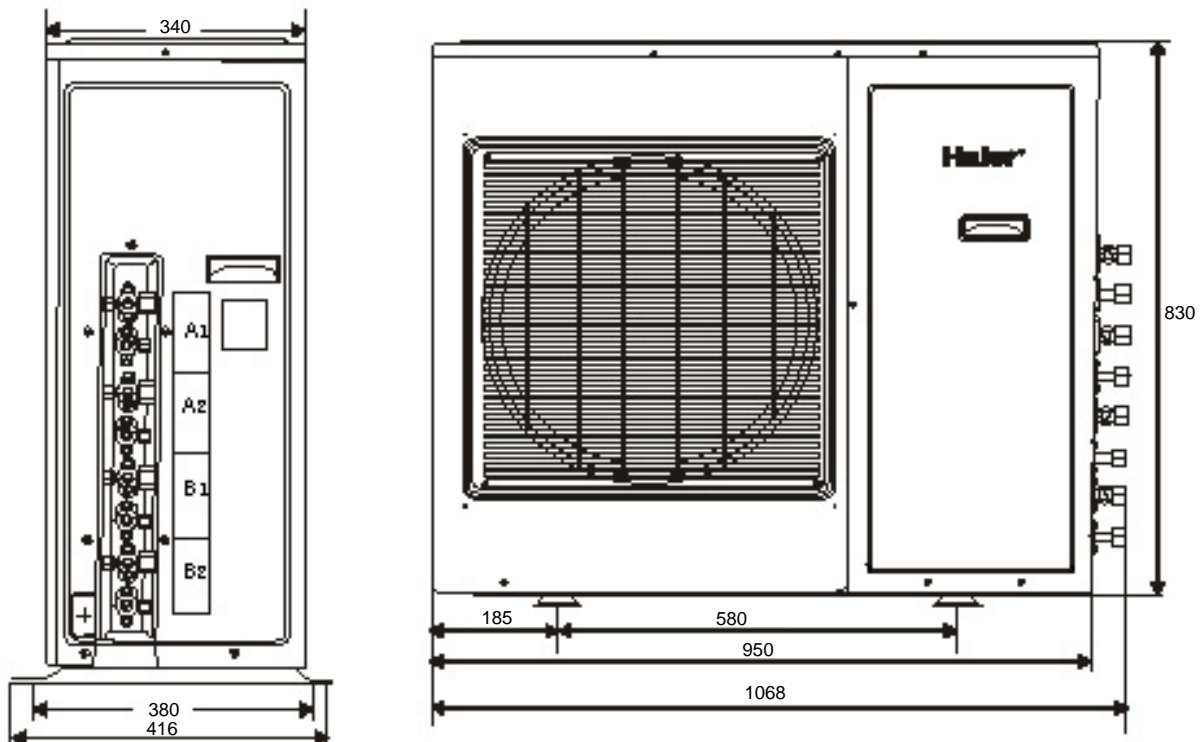

4.2. Outdoor unit: AU422XIEAA

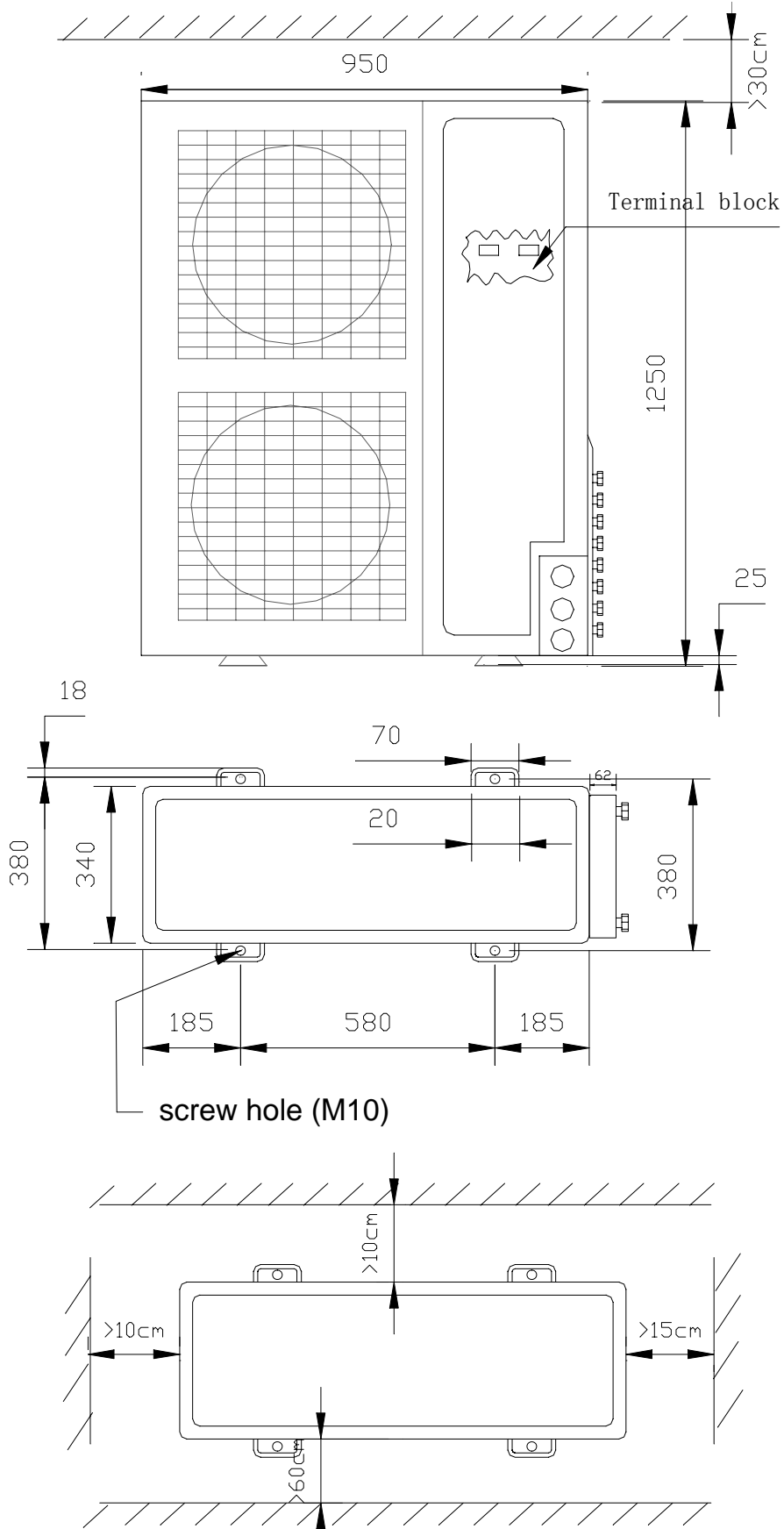

4.3. Cassette Type AB07-142XCEAA

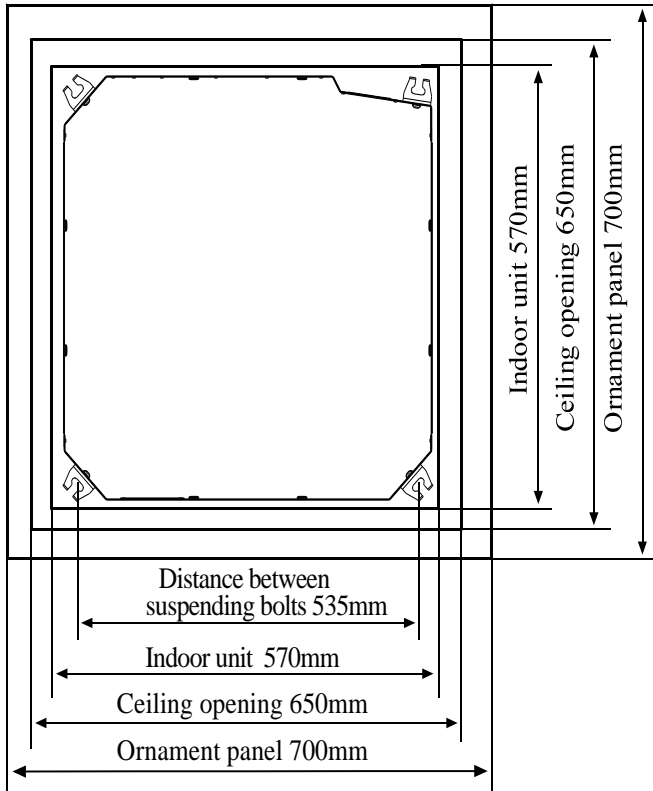

4.4. Wall Mounted Type AS07-142XCEAA

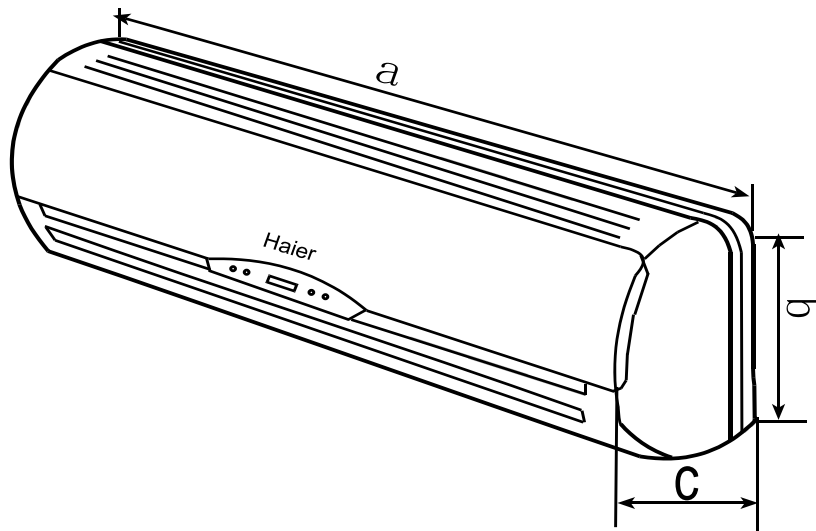

model	a	b	c
AS072XCEAA AS092XCEAA AS122XCEAA AS142XCEAA	795	265	182

4.5. Model: AB212XCEAA

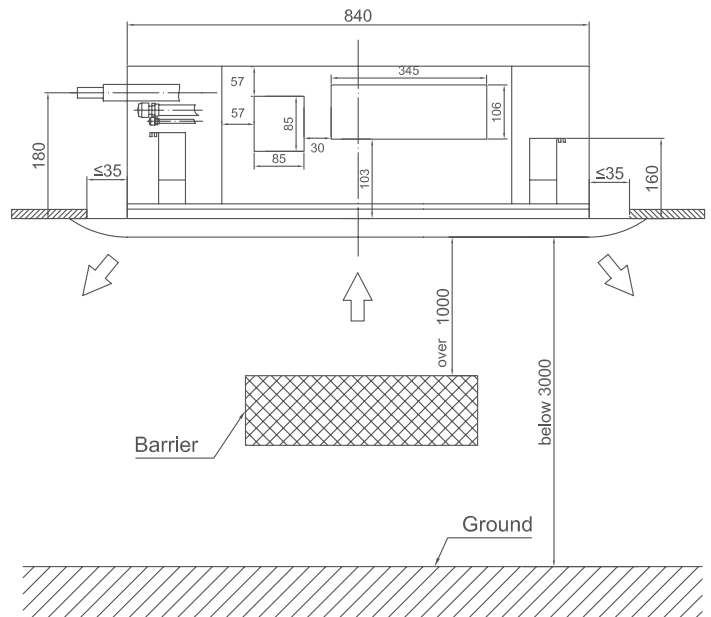
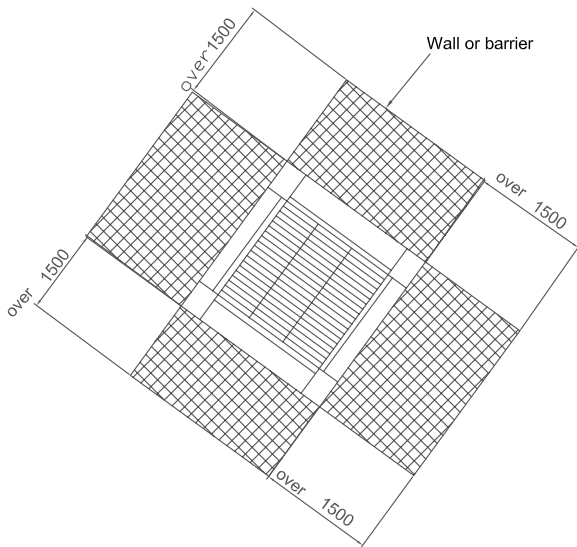
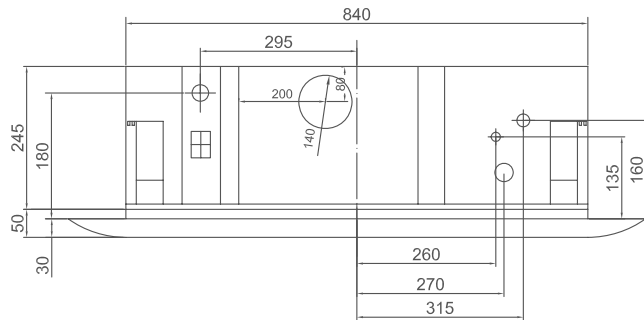
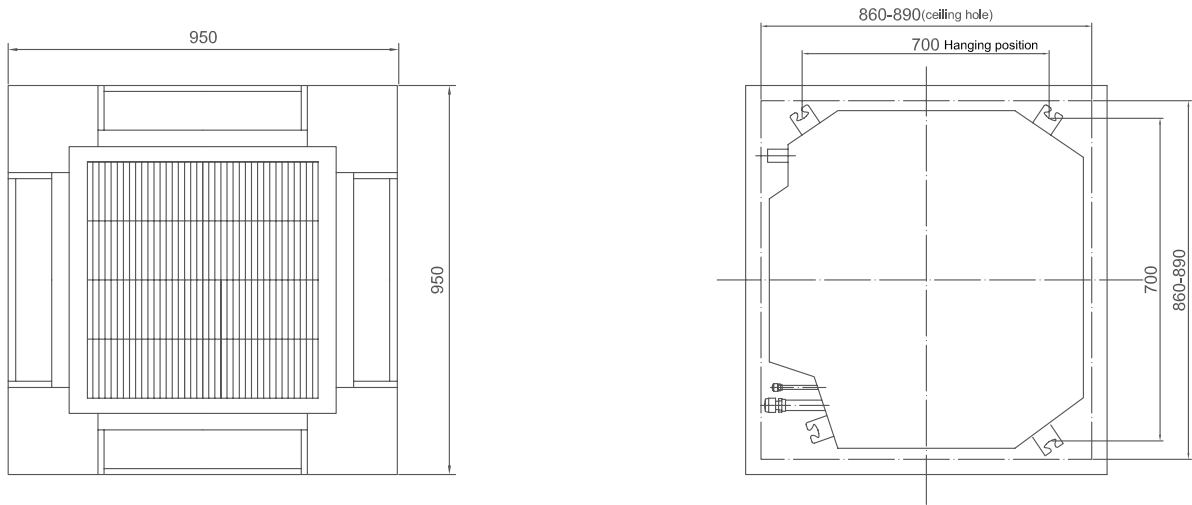

4.6. Duct Type AD***XLEAA

Figure showing installation dimensions: (unit:mm)

Model	a	b	c	d	e	f	g	i
Series 07-09	615	648	450	220	80	125	225	100
Series 12-14	770	804	450	220	80	125	225	100
Series 18-21	1060	1120	450	220	80	125	225	100

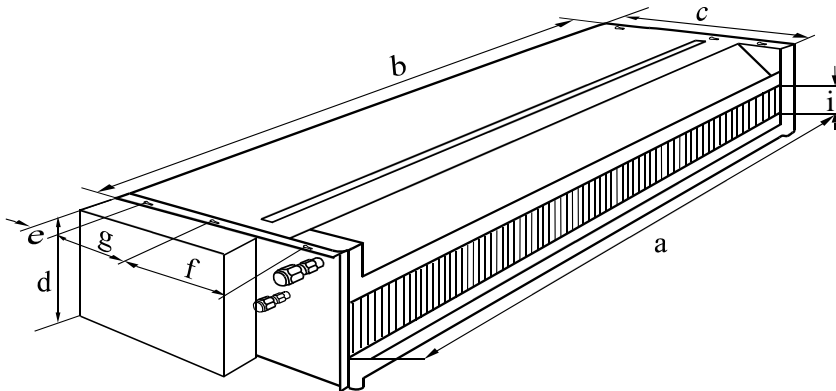

4.7. Console Type AF***XCEAA

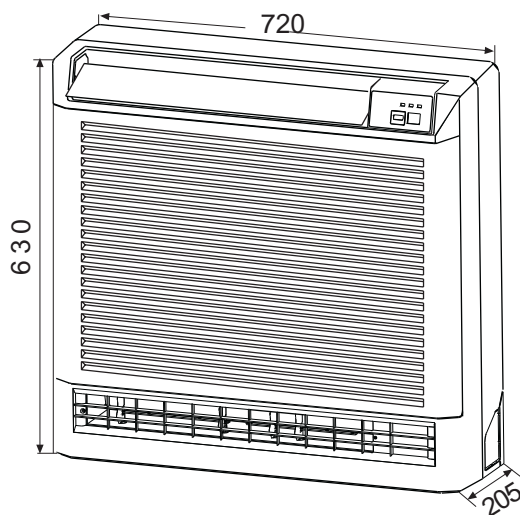

5.Part Name

5.1 Cassette Type AB07-142XCEAA

Swing louver
 (Air flow direction can be adjusted by using the SWING button on the remote controller)

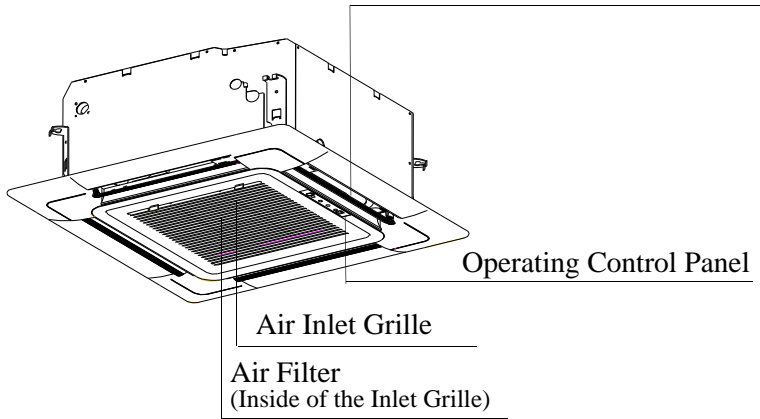

Operating Control Panel

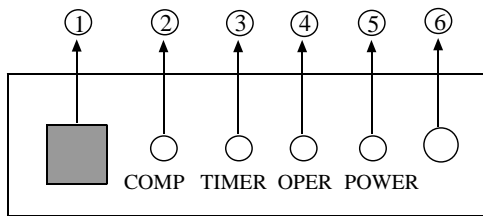

- ① Remote receiver
- ② Compressor Lamp
- ③ TIMER Lamp
- ④ OPERATION Lamp
- ⑤ Power Lamp
- ⑥ Emergency switch

5.2. Cassette Type AB212XCEAA

Discharge unit (built in)

In cooling operation, to discharge the water from inside the room.

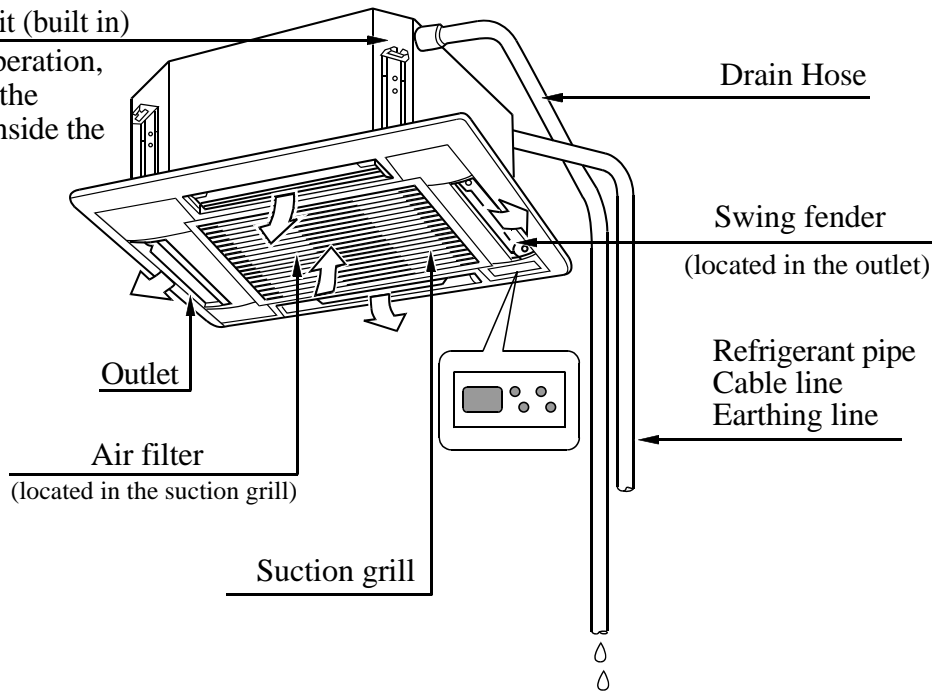

5.3 Duct type AD***XLEAA

NOTE

When the unit have the Return air box (see the following picture) when shipping from the factory and they are of back-side return air type. During the installation, the unit also can be changed to a Down-side Return air according to the user's need.

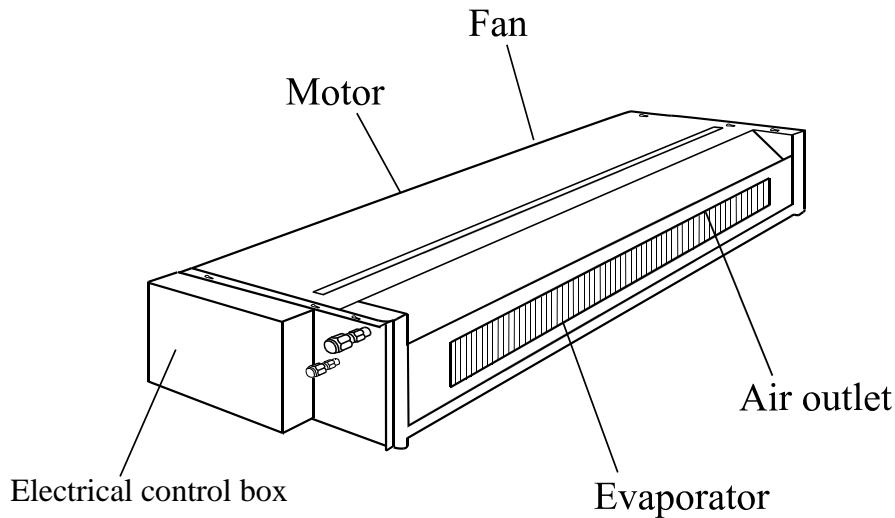

5.4 Console Type AF***XCEAA

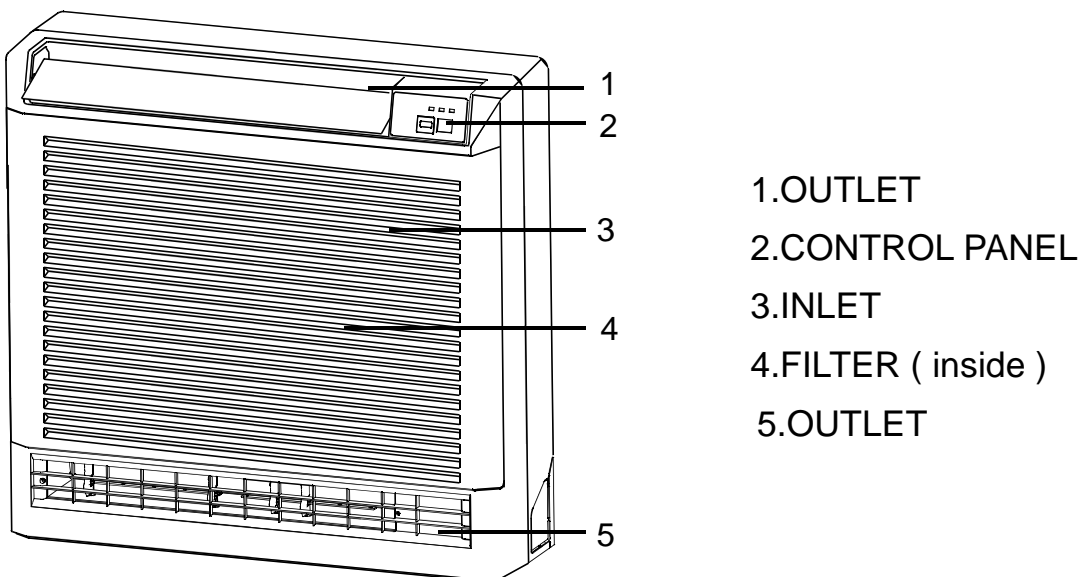

5.5 Wall Mounted Type AS***XCEAA

INDOOR UNIT FRONT VIEW

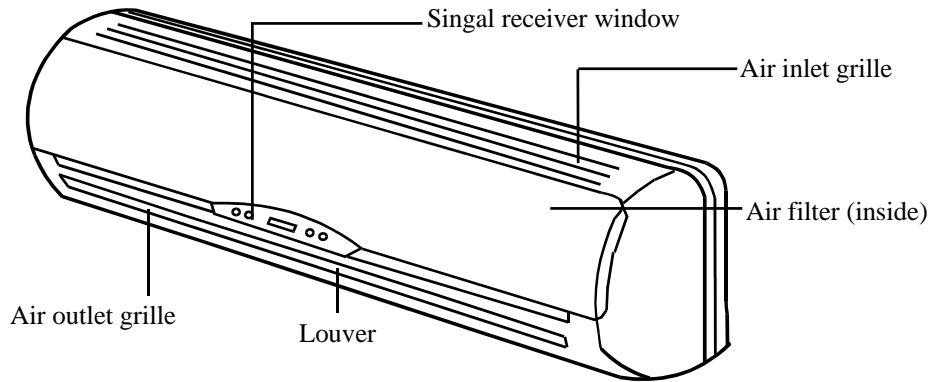

INDOOR UNIT BACK VIEW

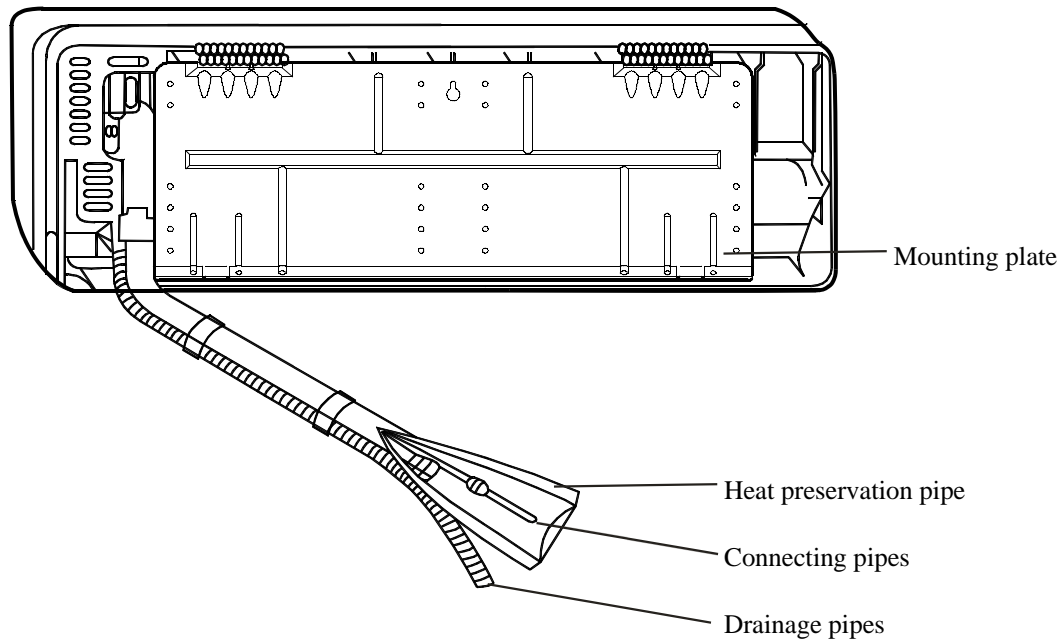

5.6. Outdoor Unit AU282XHEAA

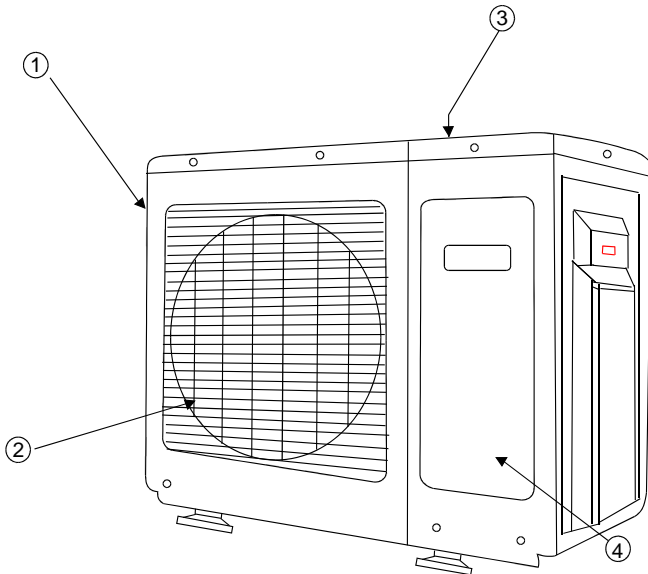

- ① Air inlet
- ② Air outlet
- ③ Air inlet
- ④ Service panel

5.7. AU422XIEAA

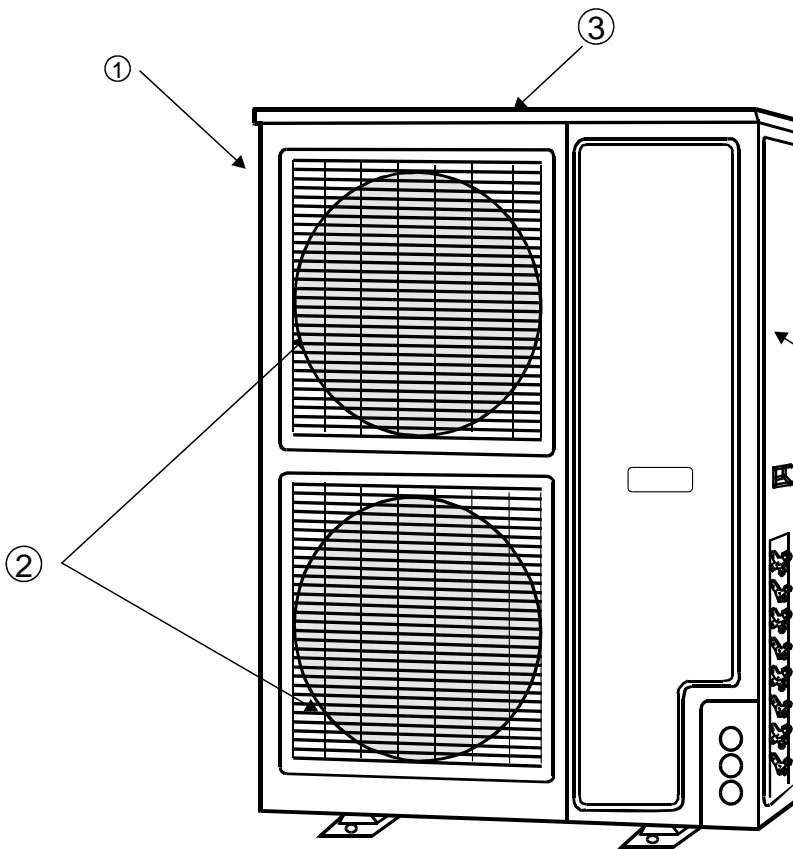

- ① Air inlet
- ② Air outlet
- ③ Air inlet
- ④ Service panel

6. Refrigerant Diagram

6.1. Refrigeration diagram for AU282XHEAA

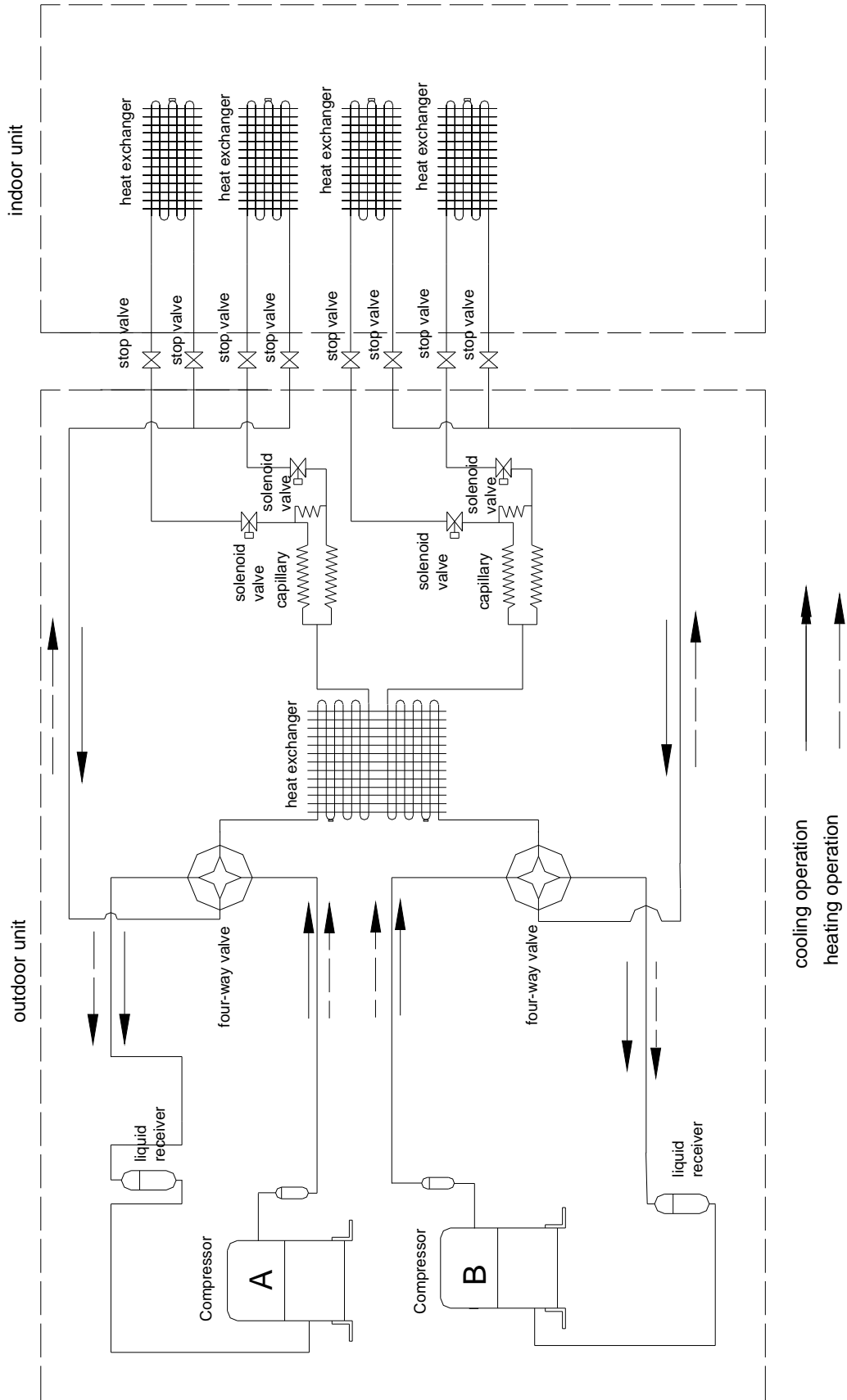

6.2. Refrigerant diagram for AU422XIEAA

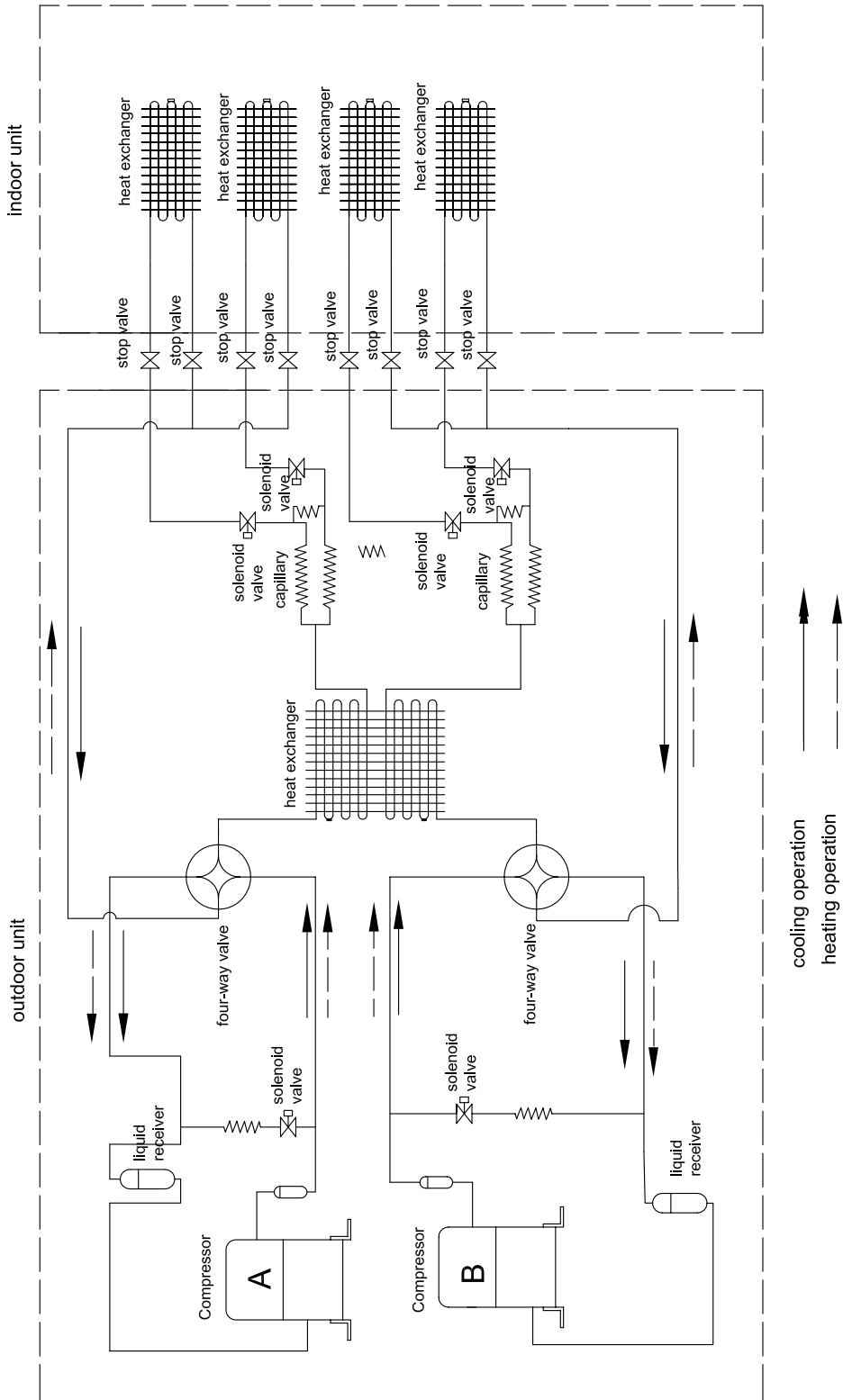

HEATING		Combinations			Rated capacity Output/kW (Nom. heating)				total heating capacity(kW)			total power input (W)			total current (A)@230V			EER (W/W)	ENERGY LABEL
1to2	072	—	—	072	—	—	3.50	—	3.50	7.00	7.00	1.65	2.70	2.70	7.40	11.98	11.98	2.59	F
	092	—	—	092	—	—	3.80	—	3.80	7.60	7.60	1.65	2.60	2.60	7.40	11.54	11.54	2.92	D
	072	—	—	092	—	—	3.80	—	3.80	7.30	7.30	1.65	2.60	2.60	7.40	11.54	11.54	2.81	D
	072	072	—	—	—	—	2.35	2.35	—	4.70	4.70	1.65	1.55	1.55	7.40	6.88	6.88	3.03	C
	092	092	—	—	—	—	2.35	2.35	—	4.70	4.70	1.65	1.55	1.55	7.40	6.88	6.88	3.03	C
	072	092	—	—	—	—	2.35	2.35	—	4.70	4.70	1.65	1.55	1.55	7.40	6.88	6.88	3.03	C
	122	—	122	—	—	—	4.00	—	4.00	8.20	8.20	1.80	2.80	2.80	8.07	12.42	12.42	2.71	E
	142	—	142	—	—	—	4.50	—	4.50	9.00	9.00	1.55	2.63	2.63	6.88	11.67	11.67	3.42	B
	072	072	142	—	—	—	2.35	2.35	4.50	9.20	9.20	1.65	2.63	2.63	7.40	11.67	11.67	3.50	B
	092	092	142	—	—	—	2.35	2.35	4.50	9.20	9.20	1.65	2.63	2.63	7.40	11.67	11.67	3.50	B
1to3	072	092	142	—	—	—	2.35	2.35	4.50	9.20	9.20	1.65	2.63	2.63	7.40	11.67	11.67	3.50	B
	072	092	142	—	—	—	2.35	2.35	4.50	9.20	9.20	1.65	2.63	2.63	7.40	11.67	11.67	3.50	B
	072	072	122	—	—	—	2.35	2.35	3.80	8.80	8.80	1.65	2.63	2.63	7.40	11.67	11.67	3.23	C
	092	092	122	—	—	—	2.35	2.35	3.80	8.80	8.80	1.65	2.63	2.63	7.40	11.67	11.67	3.23	C
	072	092	122	—	—	—	2.35	2.35	3.80	8.80	8.80	1.65	2.63	2.63	7.40	11.67	11.67	3.23	C
	072	072	122	—	—	—	2.35	2.35	3.80	8.80	8.80	1.65	2.63	2.63	7.40	11.67	11.67	3.23	C
	072	072	072	—	—	—	2.35	2.35	3.50	8.20	8.20	1.65	2.65	2.65	7.40	11.76	11.76	3.09	C
	072	072	092	—	—	—	2.35	2.35	3.80	8.50	8.50	1.65	2.65	2.65	7.40	11.76	11.76	3.21	C
	072	092	092	—	—	—	2.35	2.35	3.80	8.50	8.50	1.65	2.65	2.65	7.40	11.76	11.76	3.21	C
	072	092	072	—	—	—	2.35	2.35	3.50	8.20	8.20	1.65	2.65	2.65	7.40	11.76	11.76	3.09	C
1to4	092	092	092	—	—	—	2.35	2.35	3.80	8.50	8.50	1.65	2.65	2.65	7.40	11.76	11.76	3.21	C
	072	072	072	072	—	—	2.35	2.35	2.35	9.40	9.40	1.65	2.63	2.63	7.40	11.67	11.67	3.57	B
	072	072	072	092	—	—	2.35	2.35	2.35	9.40	9.40	1.65	2.63	2.63	7.40	11.67	11.67	3.57	B
	072	072	092	092	—	—	2.35	2.35	2.35	9.40	9.40	1.65	2.63	2.63	7.40	11.67	11.67	3.57	B
	072	092	092	092	—	—	2.35	2.35	2.35	9.40	9.40	1.65	2.63	2.63	7.40	11.67	11.67	3.57	B
	072	092	092	092	—	—	2.35	2.35	2.35	9.40	9.40	1.65	2.63	2.63	7.40	11.67	11.67	3.57	B
	092	092	092	092	—	—	2.35	2.35	2.35	9.40	9.40	1.65	2.63	2.63	7.40	11.67	11.67	3.57	B
	092	092	092	092	—	—	2.35	2.35	2.35	9.40	9.40	1.65	2.63	2.63	7.40	11.67	11.67	3.57	B
	092	092	092	092	—	—	2.35	2.35	2.35	9.40	9.40	1.65	2.63	2.63	7.40	11.67	11.67	3.57	B
	092	092	092	092	—	—	2.35	2.35	2.35	9.40	9.40	1.65	2.63	2.63	7.40	11.67	11.67	3.57	B

Note: For wall mounted unit, please refer to the data on its nameplate.

7.2. The unit capacity and performance mode for AU422XIEAA:

COOLING	Combinations				Rated capacity Output/kW (Nom. cooling)				total cooling capacity(kW)				total power input (kW)				total current (A)@230V				EER (W/W)		ENERGY LABEL
	Unit A1		Unit B1		Unit A2		Unit B2		min. data		rated data		max. Data		min. data		rated data		max. Data		rated capacity	EER	
	122	—	122	—	—	—	—	—	4.00	8.00	8.00	3.60	3.60	8.43	15.97	15.97	2.22	F					
1to2	122	122	—	—	3.08	3.08	—	—	4.00	6.15	6.15	2.10	2.10	8.43	9.32	9.32	2.93	C					
1to3	122	—	212	—	4.00	—	—	—	4.00	10.15	10.15	3.70	3.70	8.43	16.42	16.42	2.74	D					
	212	—	212	—	6.15	—	—	—	6.15	12.30	12.30	4.08	4.08	8.43	18.10	18.10	3.01	B					
1to4	122	122	212	—	3.08	3.08	—	—	4.00	12.30	12.30	4.08	4.08	8.43	18.10	18.10	3.01	B					
	122	122	122	—	3.08	3.08	—	—	4.00	10.15	10.15	3.70	3.70	8.43	16.42	16.42	2.74	D					
1to4	122	122	122	122	3.08	3.08	3.08	3.08	4.00	12.30	12.30	4.08	4.08	8.43	18.10	18.10	3.01	B					

HEATING	Combinations				Rated capacity Output/kW (Nom. heating)				total heating capacity(kW)				total power input (W)				total current (A)@230V				EER (W/W)		ENERGY LABEL
	Unit A1		Unit B1		Unit A2		Unit B2		min. data		rated data		max. Data		min. data		rated data		max. Data		rated capacity	EER	
	122	—	122	—	—	—	—	—	4.40	8.80	8.80	3.65	3.65	8.65	16.19	16.19	2.41	F					
1to2	122	122	—	—	3.30	3.30	—	—	4.40	6.60	6.60	2.10	2.10	8.65	9.32	9.32	3.14	C					
1to3	122	—	212	—	4.40	—	—	—	4.40	10.90	10.90	3.50	3.50	8.65	15.53	15.53	3.11	C					
	212	—	212	—	6.50	—	—	—	6.50	13.00	13.00	3.80	3.80	8.65	16.86	16.86	3.42	B					
1to4	122	122	212	—	3.30	3.30	—	—	4.40	13.10	13.10	3.80	3.80	8.65	16.86	16.86	3.45	B					
	122	122	122	—	3.30	3.30	—	—	4.40	11.00	11.00	3.50	3.50	8.65	15.53	15.53	3.14	C					
1to4	122	122	122	122	3.30	3.30	3.30	3.30	4.40	13.20	13.20	3.80	3.80	8.65	16.86	16.86	3.47	B					

Note: For wall mounted unit, please refer to the data on its nameplate.

1 TO 2(except for 21000BTU/h units)

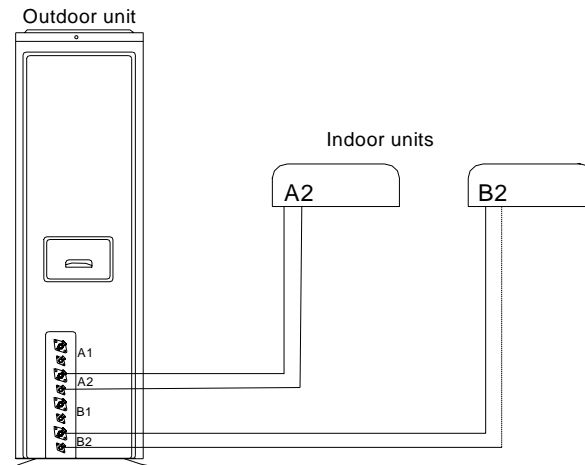

Communication Wire connection:

1. The indoor unit whose liquid pipe is connected to A1 in A system is called unit A1, its communication wire of A1(3)、A1(4) should be connected to A1(P)、A1(Q) respectively.
2. The indoor unit whose liquid pipe is connected to A2 in A system is called unit A2, its communication wire of A2(3)、A2(4) should be connected to A2(P)、A2(Q) respectively.
3. The indoor unit whose liquid pipe is connected to B1 in B system is called unit B1, its communication wire of B1(3)、B1(4) should be connected to B1(P)、B1(Q) respectively.
4. The indoor unit whose liquid pipe is connected to B2 in B system is called unit B2, its communication wire of B2(3)、B2(4) should be connected to B2(P)、B2(Q) respectively.

Note: Because the customers themselves match the communication wire, and the P and Q are nonpolar, the customers must use shielded communication wires.

Special Installation Guide to 21000BTU indoor units on Free Multi system

Only for outdoor unit AU422XIEAA working with 21000BTU indoor units

1. Special accessory pipes for 21000BTU indoor units:

A	B
Changing pipe (3/8-1/2)	Collecting pipe (1/4-3/8)

2. Pipe installations:

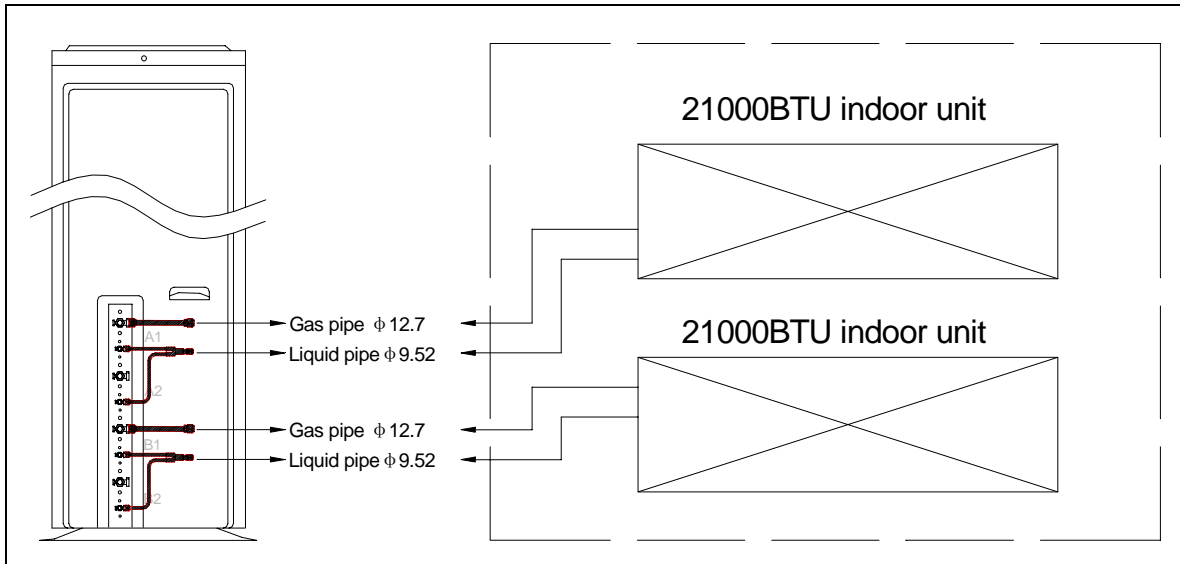

Note: Though AU422XIEAA can match with the R407C free multi indoor unit, we do not recommend so. Because that will not only lower the capacity, also the changing pipe 0010759292 will be required for all R407C free multi indoor unit when installation.

3. Outdoor wiring diagram should be changed as the following:

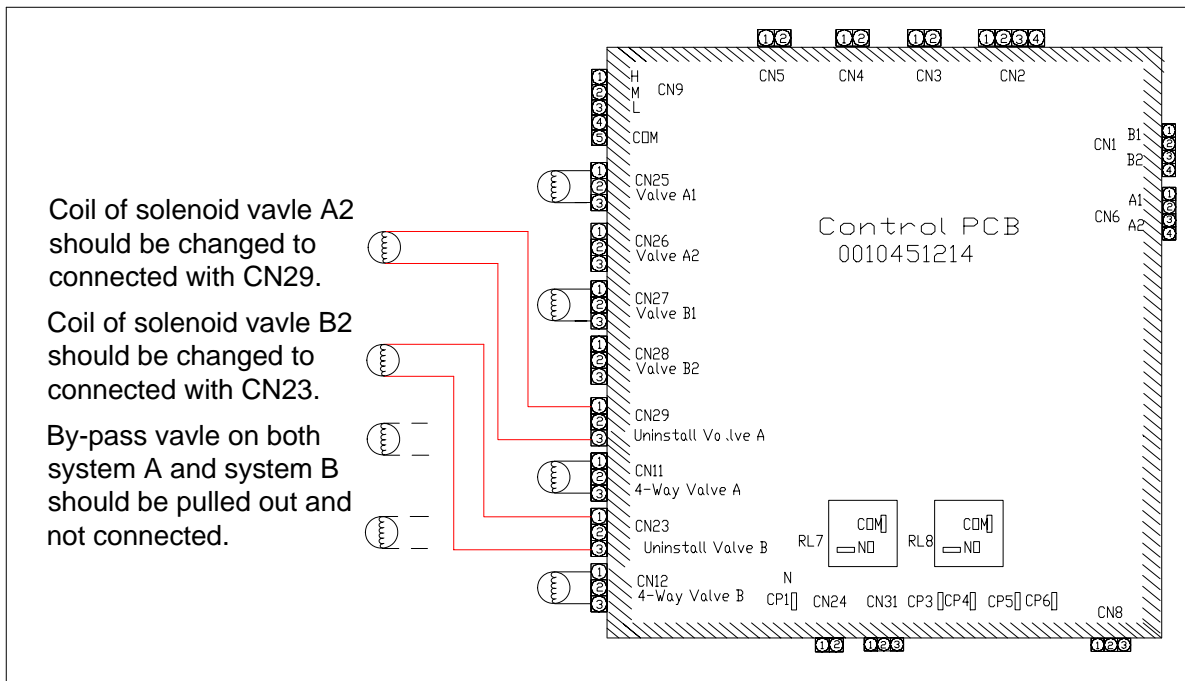

8. Installation Procedure

8.1.1. Selection of Installation Place (For AB072-142XCEAA)

- (1) Place above the ceiling where it is enough space to arrange the unit.
- (2) Place where the drainage pipe can be arranged well.
- (3) Place where inlet and outlet air of indoor and outdoor unit will not be blocked.
- (4) Do not expose the unit to the place with heavy oil or moisture (e.g.kitchen and workshop).
- (5) Do not set the unit in the place where destructive gas (such as sulfuric acid gas) or pungent gas (thinner and gasoline) concentrates and retains.
- (6) Place strong enough to support the unit .
- (7) No expensive articles such as television and piano below indoor unit.
- (8) Enough space for maintenance.
- (9) Place more than 1m away from television and radio to avoid disturbing television and radio.
- (10) Easy for maintenance.

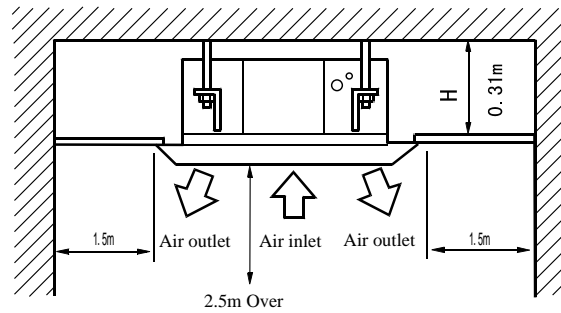

- (1) Position of ceiling opening between unit and suspending bolt (front view of unit).
- (11) Dimension of connecting pipe

AB072XCEAA	Gas pipe	Φ9.52mm
AB092XCEAA		
AB122XCEAA	Liquid pipe	Φ6.35mm
AB142XCEAA		

8.1.2. Electrical Wiring

Cautions: Use copper wire only. Paramet line : H05RN-F 3G(1.0~1.5)mm²+H05RN-F 2x(0.75~1.5)mm²
 Power supply :1PH,220-230V~,50Hz.
 Power supply wire parameters: H05RN-f 3G(0.75~1.5)mm²
 Signal wire parameters: H05RN-F 2x0.75mm²
 The signal wire must be shielded wire.

Wiring methods:

1. Wiring method of ring terminal

For connecting line which end is a ring,its wiring method as shown in the right figure: remove wiring screw and pass it through the end ring of connecting line,then connect it to the terminal block and tighten screw.

2. Wiring method of straight terminal

For connecting line which end is not a ring, its wiring method as follows: loosen wiring screw and insert the end of connecting line totally into the terminal block,then tighten the screw and pull the connecting line slightly to confirm that it is clamped firmly.

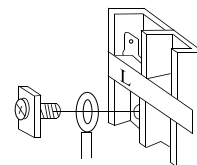

Wiring method of ring terminal

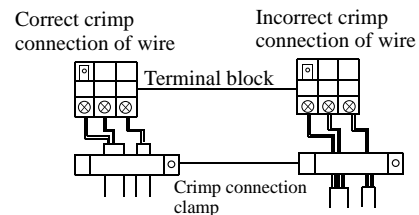

(3) Install a suspending bolt

To support the unit weight, anchor bolt should be used in the case of the existing ceiling. For new ceiling, use flush-in type bolt, built-in type bolt or parts prepared in the field.

Before going on installing, adjust the distance to ceiling.

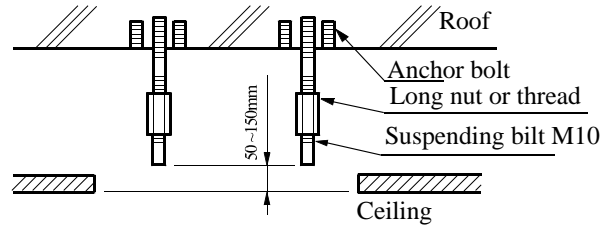

Note: All the above mentioned parts shall be prepared in field, the diameter of suspending bolt is M10

8.1.3 . Installation of indoor unit <Installation Example>

In case of no ceiling

Install unit temporarily

Put suspending bracket on the suspending bolt to hang the unit up. Be sure to use nut and washer at both end of the bracket to secure firmly.

After installation on the ceiling

(1) Adjust unit to its right position (Refer to preparation for installation-(1))

(2) Check that unit is horizontal.

Water pump and floating switch is installed inside indoor unit, check four corners of the unit for its level using horizontal comparator or PVC tube with water. (If unit is tilting against the direction of water drainage, problem may occur on floating water leakage.)

In the case of existing ceiling

(1) Install unit temporarily

Put suspending bracket on the suspending bolt to hang the unit up. Be sure to use nut and washer at both end of the bracket to secure it firmly.

(2) Adjust the height and position of the unit.

(3) Proceed with procedure (4) of " In the case of no ceiling "

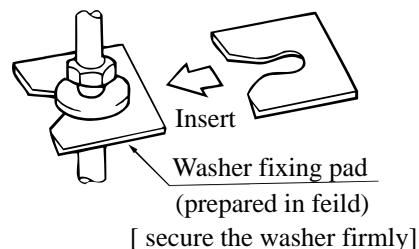
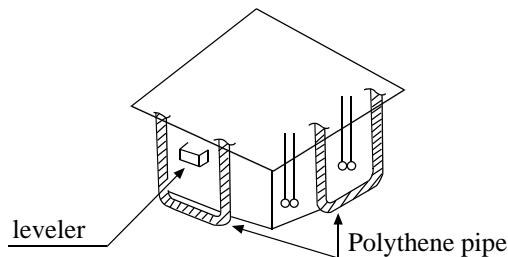
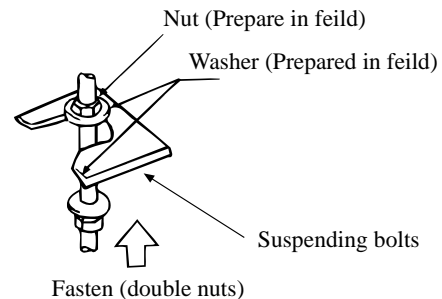

8.1.4. Installation of water drainage pipe

(1) Install water drainage pipe

- Pipe diameter shall be equal or larger than that of connecting pipe (Pipe of polythene; size: 25mm; O.D.: 32mm)
- Drainpipe should be short, with a downward slope at least 1/100 to prevent air bag from forming.
- If downward slope of drainpipe cannot be made, lifting pipe shall be installed.
- Keep a distance of 1-1.5m between suspending bolts, to make water hose straight.

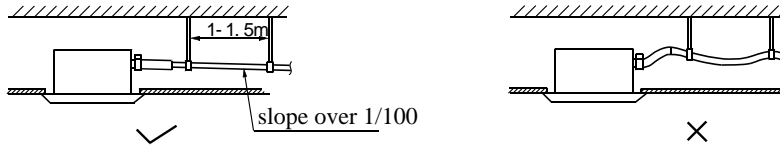

- Use the drainage hose and clip provided with unit.
Insert water pipe into water plug until it reaches the white tape.
Tighten the clip until head of the screw is less than 4mm from hose.
- Wind the drainage hose to the clip using seal pad for heat insulation.
- Insulate drainage hose in the room.

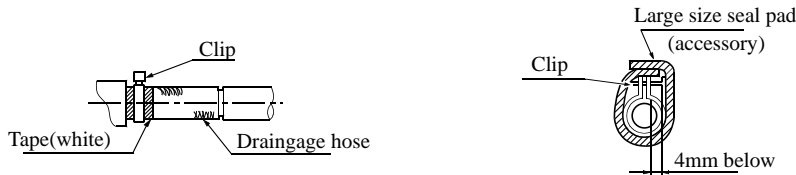

8.1.6. Cautions for the water drainage lifting pipe

- Installation height of water drainage lifting pipe shall be less than 280mm
- There should be a right angle with unit ,300mm from unit.

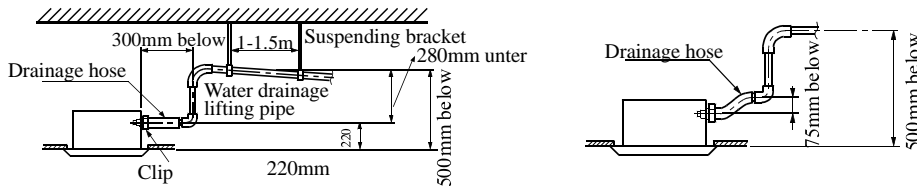

< Note >

- The slope of water drainage hose shall be within 75mm , make the drainage plug not to bear excessive force.
- If several water hoses join together, of as per following procedures.

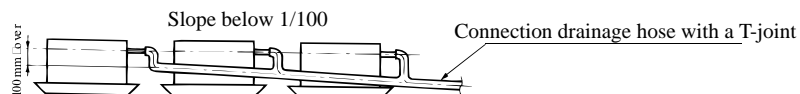

Specifications of the selected drainage hoses shall meet the requirements for the unit running

8.1.6. Installation of Ornament Panel

Install ornament panel on indoor unit

- (1) Check whether indoor unit is horizontal with leveler or polythene pipe filled with water , and check that the dimension of the ceiling opening is correct. Take off the lever gauge before installing the ornament panel.
- (2) Fasten the screws to make the height difference between the two sides of indoor unit less than 5mm.
- (3) Firstly fix it with screws temporarily.
- (4) Fasten the two temporarily fixing screws and other two, and tighten the four screws.
- (5) Connect the wires of synchro-motor.
- (6) Connect the wire of signal.
- (7) If no response of remote controller,check whether the wiring is correct,restart remote controller 10 seconds after shut off power supply.

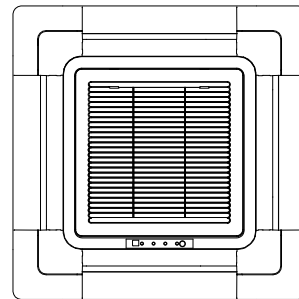
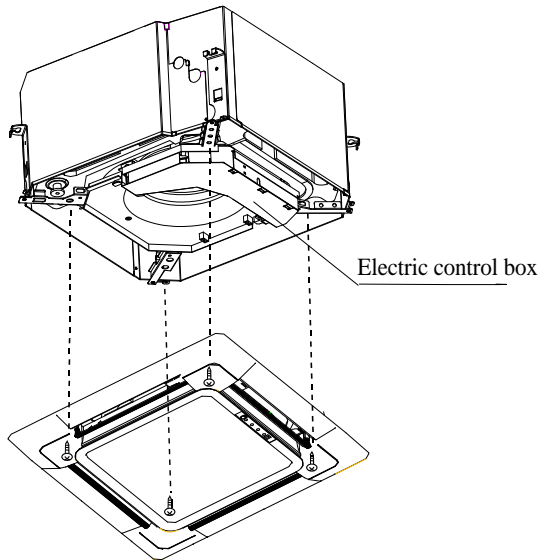

Panel limitation board installation

- (1) Install the panel board in the direction shown in the figure.
- (2) The incorrect direction will result in water leakage, meanwhile swing and signal receiving are displayed that cannot be connected.

Piping Connection

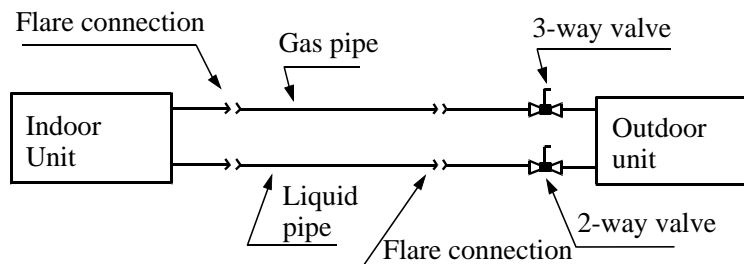

8.2.1. Installation procedure (For AB212XCEAA)

(1) Installation place shall meet the following and agreed by customers:

- Place where proper air flow can be ensured.
- No block to air flow.
- Water drainage is smooth.
- Place strong enough to support unit weight.
- Place where inclination is not evident on ceiling.
- Enough space for maintenance.
- Indoor and outdoor unit piping length is within limit. (Refer to Installation Manual for outdoor unit.)
- Indoor and outdoor unit, power cable, inter unit cable are at least 1 m away from T.V. radop. This is helpful to avoid picture disturbance and noise. (Even if 1 m is kept, noise can still appear if radio wave is strong)

(2) Ceiling height

Indoor unit can be installed on ceiling of 2.5-3m in height. (Refer to Field setting and Installation Manual of ornament panel.)

(3) Install suspending bolt. Check if the installation place is strong enough to hold weight. Take necessary measures in case it is not safe. (Distance between holes are marked on paper pattern. Refer to paper pattern for place need be reinforced)

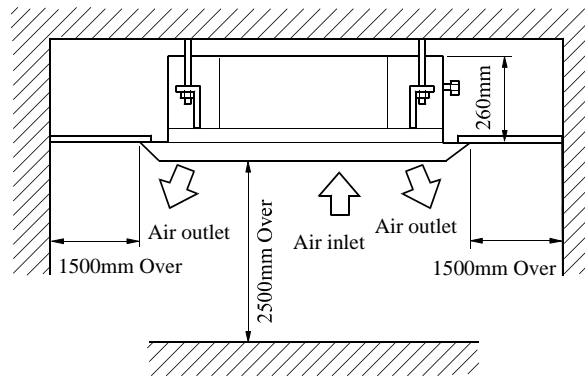

(2) Cut an opening in ceiling for installation if necessary. (when ceiling already exists.)

- Refer to paper pattern for dimension of ceiling hole.
- Connect all pipings (refrigerant, water drainage), wirings (inter unit cable) to indoor unit, before installation.
- Cut a hole in ceiling, may be a frame should be used to ensure a smooth surface and to prevent vibration. Contact your real estate dealer

(3) Install a suspending bolt.

(Use a M10 bolt)

To support the unit weight, anchor bolt shall be used in the case of already exists ceiling. For new ceiling, use built-in type bolt or parts prepared in the field. Before going on installing adjust space between ceiling.

<Installation example>

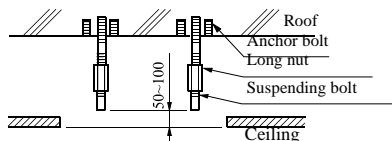

Note: All the above mentioned parts shall be prepared in field.

4 INSTALLATION OF INDOOR UNIT

In the case of new ceiling

(1) Install unit temporarily

- Put suspending bracket on the suspending bolt. Be sure to use nut and washer at both ends of the bracket.
- (2) ● As for the dimensions of ceiling hole, see paper pattern. Ask your real estate dealer for details.
 - Center of the hole is marked on the paper pattern.
 - Center of the unit is marked on the card in the unit and on the paper pattern.
 - Mount paper pattern ⑤ onto unit using 3 screws ⑥. Fix the corner of the drain pan at piping outlet.

< After installation on the ceiling >

(3) Adjust unit to its right position. (Refer to preparation for the installation-(1))

(4) Check unit's horizontal level.

- Water pump and flating switch is installed inside indoor unit, check four corners of the unit for its level using horizontal compartor or PVC tube with water. (If unit is tilting against the direction of water drainage, problem may occur on floating switch, causing water leakage.)

(5) Remove the washer mounltng ②, and tighten the nut above.

(6) Remove the paper pattern.

In the case of ceiling already exists

(1) Install unit temporarily

- Put suspending bracket on the suspending bolt. Be sure to use nut and washer at both ends of the bracket. Fix the bracket firmly.
- (2) Adjust the height and position of the unit. (Refer to preparation for the installation (1)).
- (3) Proceed with ③ and ④ of "In the case of new ceiling".

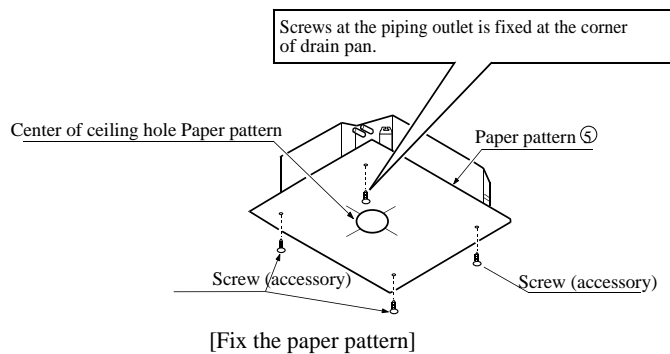
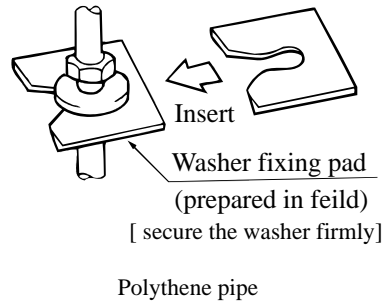
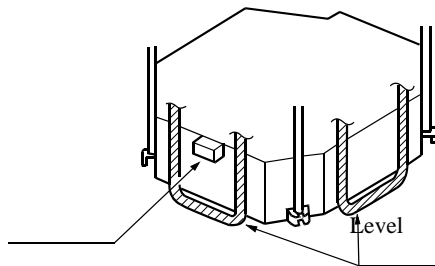
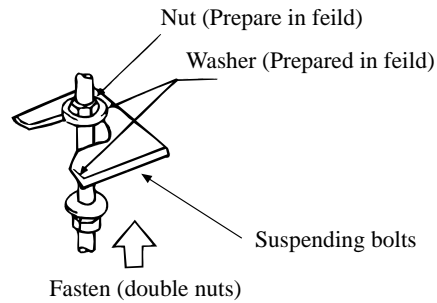

5 REFRIGERANT PIPING (As for outdoor piping, please refer to installation Manual of outdoor unit.)

- Outdoor is precharged with refrigerant.
- Be sure to see the Fig.1, when connecting and removing piping from unit.
- For the size of the flare nut, please refer to Table 1.
- Apply refrigerant oil at both inside and outside of flare nut. Tighten it band tight 3-4 turns then tighten it.
- Use torque specified in Table 1. (Too much force may damage flare nut, causing gas leakage).
- Check piping joints for gas leakage. Insulate piping as shown in Fig. below.
- Cover joint of gas piping and insulator ⑦ with seal.

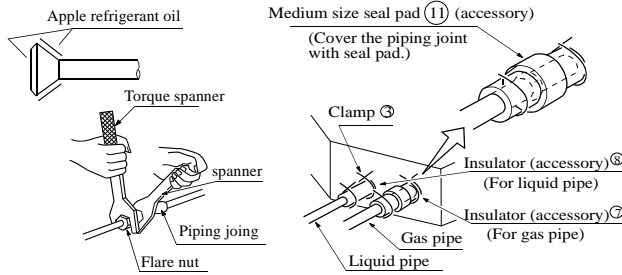

Table 1

Pipe size	Tighten torque	A(mm)	Flare shape
φ.35	420~1720N·cm (144~176kgf·cm)	8.3~8.7	
φ9.52	3270~3990N·cm (333~407kgf·cm)	2.0~12.4	
φ12.7	4950~6030N·cm (504~616kgf·cm)	15.4~15.8	
φ15.88	6180~7540N·cm (630~770kgf·cm)	18.6~19.0	
φ19.05	9720~11860N·cm (990~1210kgf·cm)	22.9~23.3	

6 INSTALLATION OF WATER DRAINAGE PIPE

(1) Install water drainage pipe

- Pipe dia. shall be equal or larger than that of unit piping.(pipe of polyethylent; size: 25mm; O.D:32mm)
- Drain pipe should be short, with a downward slope at least 1/100 to prevent air bag from happening.
- If downward slope can't be made, take other measures to lift it up.
- Keep a distance of 1-1.5m between suspending brackets, to make water hose straight.

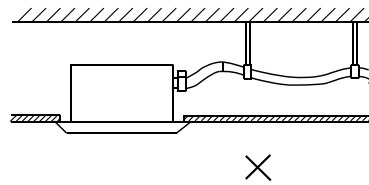
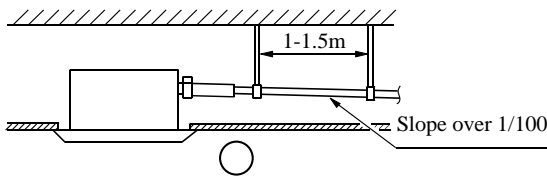

- Use the self-provided stiff pipe and clamp ① with unit. Insert water pipe into water plug until it reaches the white tape. Tighten the clip until head of the screw is less than 4mm from hose.
- Wind the drain hose to the clip using seal pad ⑨. Insulate drain hose in the room.

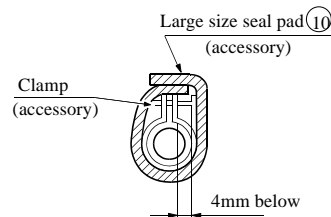
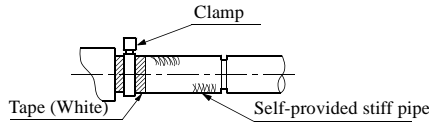

<Cautions for the drain water lifting pipe

- Installation height shall be less than 280mm.
- There should be a right angle with unit, 300mm from unit.

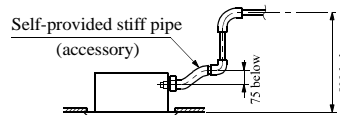
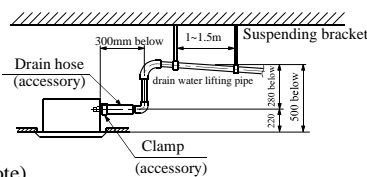

(Note)

- The slope of water drain hose (1) shall be within 75mm, don't apply too much force on it.
- If several water hoses join together, do as per following procededures.



Specifications of the water hoses shall meet the requirements for the unit running.

(2) Check if water drainage is smooth after installation.

- Charge, through air outlet or inspecting hole, 1200ccd water to see water drainage.

After wiring

Check water drainage in cooling operation.

When wiring is not complete

- Remove cover of control box, short connect "CHECK" terminal of the indoor unit, which is on the upper part of indoor unit PCB.
- Connect 1PH power to terminal 1 and 2 on terminal block.
- Note, in this operation, fan will be running.
- Upon confirmation of a smooth water drainage, be sure to cut off power supply and remove short connection of "CHECK" terminal.

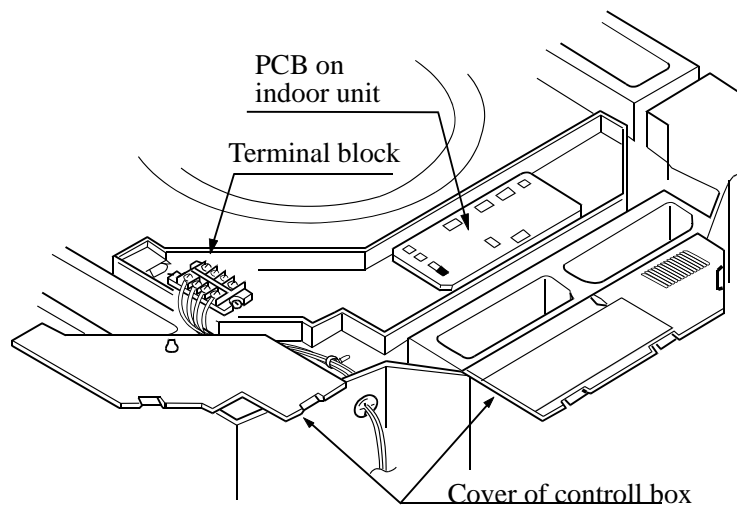
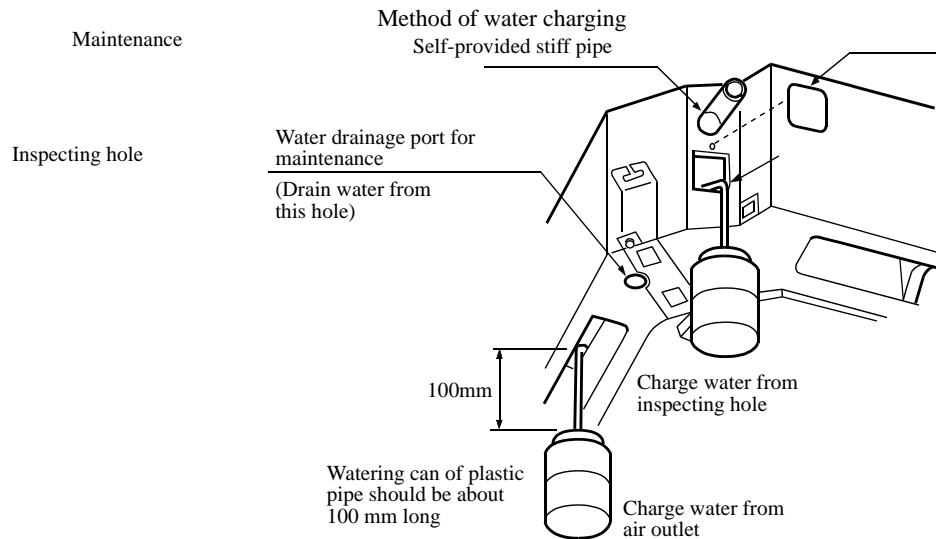

7 WIRING

- All supplied parts, materials and wiring operation must in appliance with local code and regulations.
- Use copper wire only.
- When make wiring, please refer to wiring diagram also.
- All wiring work must be done by qualified electricians.
- A circuit breaker must be installed, which can cut power supply to all system.
- See Installation Manual of outdoor unit for specifications of wires, circuit breaker, switches and wiring etc.
- Connecting of unit
Remove cover of switch box (1), drag wires into rubber tube A, then, after proper wiring with other wires, tighten clamp A. Connect wires of correct pole to the terminal block inside.
- Wind seal (2) around wires. (Be sure to do that, or, dew may occur).
- Upon connecting, replace control box cover (1) and (2).

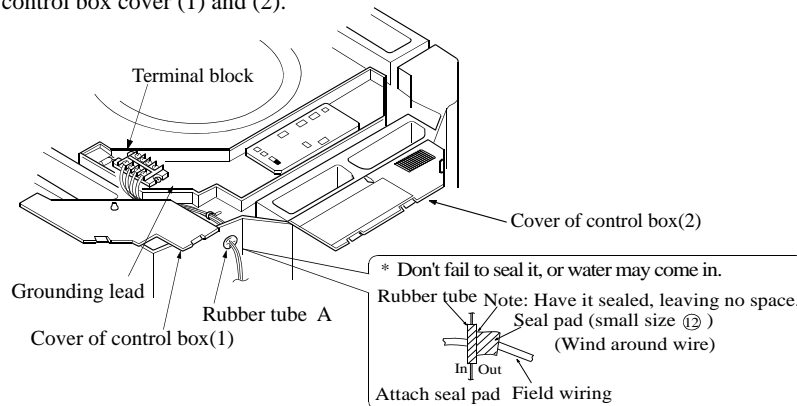

<<WARNING>>

Observe the following when connecting power supply terminal block:

Don't connect wires of different specifications to the same terminal block.

(Loose wire may cause overheating of circuit)

Connect wires of same specifications as shown in right Fig.

Connect wires of the same specifications at two sides.

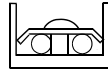

Don't connect wires of the same specifications at one side.

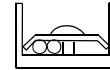

Don't connect wires of the different specifications.

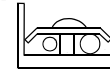

8 WIRING EXAMPLE

As for outdoor unit circuit, please see Installation Manual of outdoor unit.

Note: All electric wires have their own poles, poles must match that on terminal block.

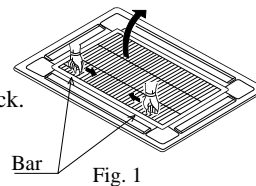

9 INSTALLATION OF ORNAMENT PANEL

Cautions for the installation

- Be sure to show customers Operation Manual and guide them how to operate unit correctly. Before installation, read also the Installation Manual of indoor unit.
- With this ornament, 2 or 3 air flow direction is not available. Suitable height is 3 m.

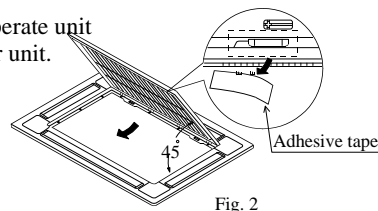

1. Prepare ornament panel Handling of ornament panel

- Ornament panel shall not be placed face down or against wall, neither on an uneven object.
- Don't bend carelessly the swing flap, or, problem may occur.

(1) Remove air inlet grill from ornament panel *

- ① Push in the bar on inlet grill and lift it up. (Refer to Fig. 1)
- ② Lift it up for about 45 degree and remove it from ornament. Tear off adhesive tape fixing air filter on the back of the air inlet grill. (Refer to Fig. 2)
- (2) **Remove cover plate at corner**
Tear off the adhesive tape, and slide it off. (Refer to Fig. 3)

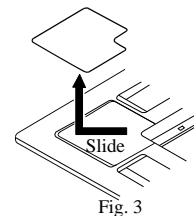

2. Mounting on high ceiling

- (1) Ornament panel can be mounted on ceiling as high as 3 m.
- (2) Please install pad as accessory.
- ① Cut open the pad along cutting line. Use part (a) only and discard part (b). (Refer to Fig. 4)
- ② Install part a of the pad on the place shown in Fig. 5. Refer to Fig. 6.

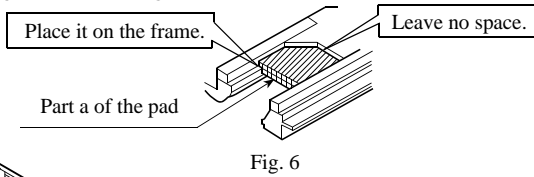
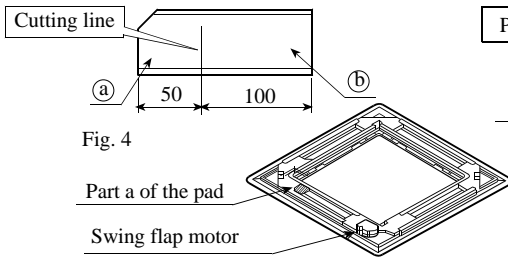

- (3) Wiring on ornament panel
Connecting of wiring of the swing flap motor on ornament panel. (2 places)
(Refer to Fig. 10)

If connecting is not made, error code (A7) appears on remote controller. So, make proper connecting.

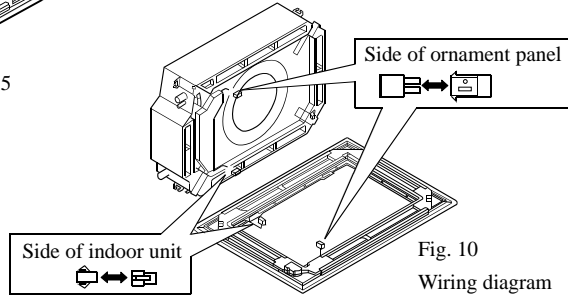

3. Install ornament panel on indoor unit.

For indoor unit installation, please refer to Installation Manual.

- (1) As shown in Fig. 7, match the position of swing flap motor with that of the indoor unit piping hole, so that ornament panel can be placed on to indoor unit.
- (2) Installation of ornament panel
 - ① Place the holding ring on swing flap motor side temporarily on hooks of the indoor unit. (2 pcs)
 - ② Put the other two holding rings on the hooks at both side of the indoor unit. (Care should be taken not to push wiring of swing flap motor into seals).
 - ③ Screw in all 4 screws under holding ring for about 15mm. (Panel will rise).
 - ④ Adjust the ornament panel as per Fig. 7 to cover opening on the ceiling.
 - ⑤ Tighten screws to reduce the thickness of seals between ornament and indoor unit to 5-8mm.

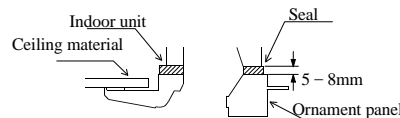
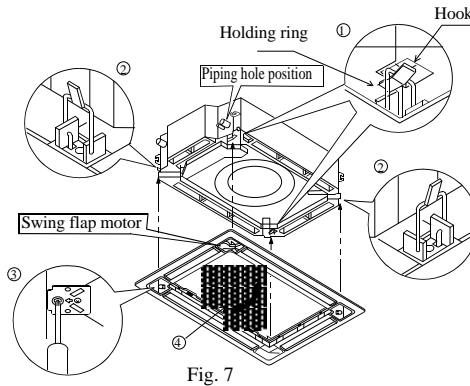

Caution

If screws are not tighten tight, problems in Fig. 8 might occur. Tighten screws properly.

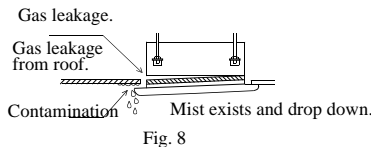

If there are still space after tightening of screws, please readjust the height of indoor unit. (Refer to Fig. 9)

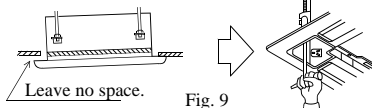

If indoor unit is at horizontal level and water drainage is smooth, then, indoor unit height can be adjusted through holes at corners of ornament panel.

4. Installation of inlet grill and cover plate

(1) Installation of inlet grill

Install in reversed order of "Prepare ornament panel".

Inlet grill can be adjusted into four directions by turning inlet grill. Inlet grill position can be adjusted as per customers request.

When installing inlet grill, take care not to twist wiring of swing flap motor.

(2) Install cover plate on the corner

① As shown in Fig. 11 tie the cover plate onto the bolt on ornament plate.

② Install cover plate onto ornament plate.

(Refer to Fig. 12)

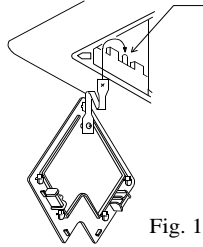
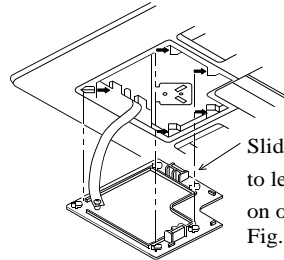

Fig. 11



Slide all five hold rings to let them drop in holes on ornament plate, Fig. 12

Pay special care to the following and check after installation

Item to be checked	Unproper installation may cause	Check
Is indoor unit firmly installed?	Unit might fall down, make vibration or noise.	
Is gas leakage check performed?	This may lead to gas shortage.	
Is unit properly insulated?	Dew or water drop may occur.	
Is water drainage smooth?	Dew or water drop may occur.	
Is power voltage meet that stipulated on the nameplate?	Problem may occur or parts got burned.	
Is wiring and piping correctly arranged?	Problem may occur or parts got burned.	
Is unit safely grounded?	There might be a danger of electric shock.	
Is wire size correct?	Problem may occur or parts got burned.	
Are there any obstacles on air inlet and outlet grill of indoor and outdoor unit?	This may cause poor cooling.	
Is record made for piping length and refrigerant charging amount?	It is hard to control refrigerant charging amount.	

⚠ Warning

- The electric wiring work shall be conducted by qualified electricians according to the installation instructions. A separate power circuit shall be used. Insufficient power cord amperage or improper wiring will cause danger of electric shock or fire.
- During wiring connection, the power cord shall be of the specified cable and reliably fastened so that external forces applied to the cable wouldnt transfer to the terminals. Improper connection or fastening will cause danger of heating, fire etc. The power cord must be fitted with a grounding wire.
- Grounding shall be made as specified. Unreliable grounding will cause electric shock. The grounding wire shall not be connected to the gas pipeline, water pipeline, thunder arrestor and telephone wire

⚠ Caution

- A current leakage breaker shall be installed, otherwise it electric shock would happen easily.
- The connection method of power cord is "Y" type.
- If the power cord is damaged, it must be replaced by the manufacturer or its service center or similar personnel to avoid risks. The power supply to the indoor unit shall be laid in complying with the operational instruction manual.
- The electric wiring shall avoid contacting with the high temperature part of the piping so as to prevent the cable insulation melts and cause dangers.
- After connected on the terminal block, the wires shall be bent to U form and then fastened with wire clip.
- The control wiring and refrigerant piping may be laid and fastened together.
- Before completion of vacuum pumping of the refrigerant pipe system, do not electrify the indoor unit.
- The power cord of the indoor unit and connection wiring between indoor and outdoor units shall be laid out according to the operational instruction manual of the indoor unit.
- The connection of the power cord shall comply with the local regulations.
- The power supply wiring connection should meet the local regulation.
- After electric installation, power on them to do electric leakage test.

Wiring connection method : (the wiring diagram is attached inside the machine)**1) Ring terminal connection method**

If there is a ring at the end of the connection wire, the wire connection method is as shown in the right figure. Remove the terminal screw and insert it through the ring at the connection wire end, then connect to the terminal board and fasten the screw.

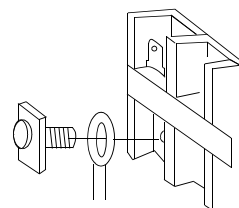

Connection method
for ring terminal

2) Straight terminal connection method

If there isnt a ring at the end of the connection wire, the connection method shall be: loosen the terminal screw, insert the connection wire end completely into the terminal board and fasten the screw. Pull the connection wire outwards slightly to confirm it is clamped tightly.

3) Clamping method of the connection wire

After wire connection is finished, the connection wire must be pressed tightly with wire clips, which shall apply to the outer sheath of the connection wire.

Wire connection for built-in indoor unit

- Insert from outside the connection wire and signal transmission wire through the wall hole with pipeline already arranged.
- Pull out the front ends of connection wire and signal wire and make a circle on the signal wire.
- Connect the connection wire according to the connection method and indoor and outdoor wiring diagram.
- Pull the connecting conductor outwards slightly to confirm it is clamped tightly.
- Connect the plug for connecting the signal wire with the plug of the signal wire connected from the indoor unit.
- After wire connection is finished, install wire clips using the same method for connection wire clamping.

Note: When connecting the indoor unit and the outdoor unit, please do connect the wires with the same color terminals.

Notes:

- Before connecting the conductors between indoor unit and outdoor unit, check for the number on the indoor and outdoor units connecting terminals. Connect the terminals with the same color and number with a wire.
- Wrong connection would damage the controller of the air conditioner or the machine couldnt operate.
- Do not connect the connection wire and signal wire with the same cable. They shall be connected respectively to ensure system normal operation.
- For some models, connection wire shall be provided by the user.
If the fuse on PC board is broken please change it with the type of T 3.15A /250VAC.
The power cable and connecting cable are self-provided.

power cable	Signal cable
H05RN-F 3G (1.0~1.5)mm ²	H05RN-F 2X(0.75~1.5)mm ²

All the cables shall have got the European authentication certificate.

- The breaker of the air conditioner should be all-pole switch; and the distance between its two contacts should be no less 3mm. Such means for disconnection must be incorporation in the fixed wiring.
- The signal wire must be shielded wire.

Note: The terminal block will be the below two types due to different models.

When wiring, please select the proper wiring type due to the actual terminal block.

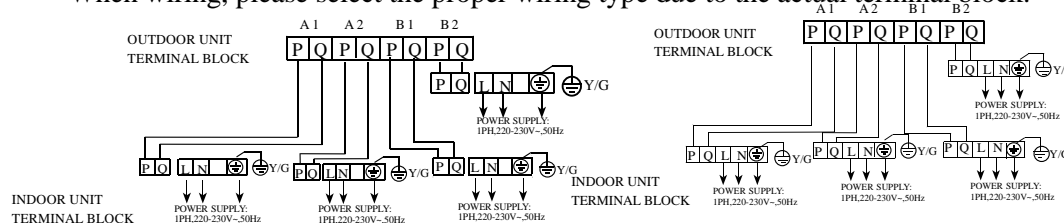

8.3. Duct Type (For AE***XLEAA)

8.3.1. Installation Procedure

Indoor unit

1. Select suitable places the outlet air can be sent to the entire room, and convenient to lay out the connection pipe, connection wire and the drainage pipe to outdoor.
2. The ceiling structure must be strong enough to support the unit weight.
3. The connecting pipe, drain pipe and connection wire shall be able to go though the building wall to connect between the indoor and outdoor units.
4. The connecting pipe between the indoor and outdoor units as well as the drain pipe shall be as short as possible. (See Figure 1)
5. If its necessary to adjust the filling amount of the refrigerant, please refer to the installation manual attached with the outdoor unit.
6. The connecting flange should be provided by the user himself.
7. The indoor unit have 2 drainage outlet, one outlet be jamedwith rubber cap, during installation only use another outlet (In/Out liquid pipe side). When necessary, use the two together.
8. Do not place the TV, equipment, facility, piano etc, expensive goods below the AC. This is to prevent the water dropping down from the AC and lead to damage to the goods.

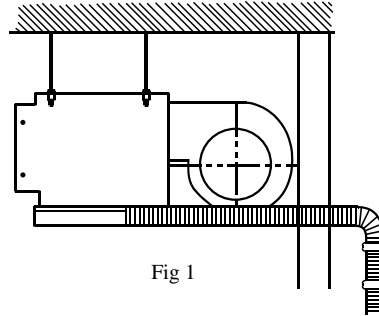

Fig 1

After selecting the unit installation location, proceed the following steps:

1. Drill a hole in the wall and insert the connecting pipe and wire through a PVC wall-through tube purchased locally. The wall hole shall be with a outward down slope of at least 1/100. (See Figure 2)
2. Before drilling check that there is no pipe or reinforcing bar just behind the drilling position. Drilling shall avoid at positions with electric wire or pipe.
3. Mount the unit on a strong and horizontal building roof. If the base is not firm, it will cause noise, vibration or pipe broken and refrigerant leakage (see Figure 6).
4. Support the unit firmly.
5. Change the form of the connection pipe, connection wire and drain pipe so that they can go through the wall hole easily.

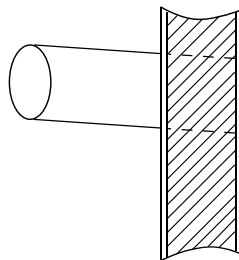

Fig 2

- When installing the ceiling concealed type indoor unit, a specially designed return air bellows shall be installed, as shown in Figure 3, Figure 4.

Figure 3

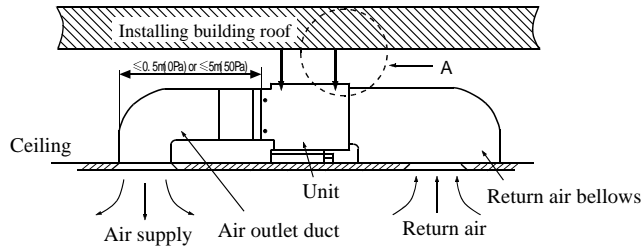
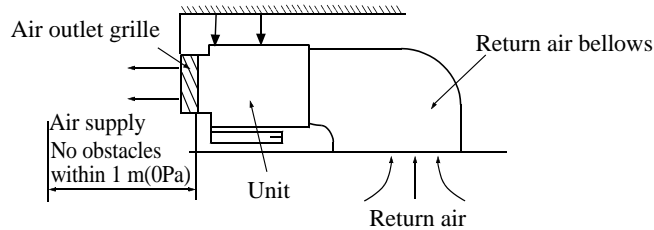
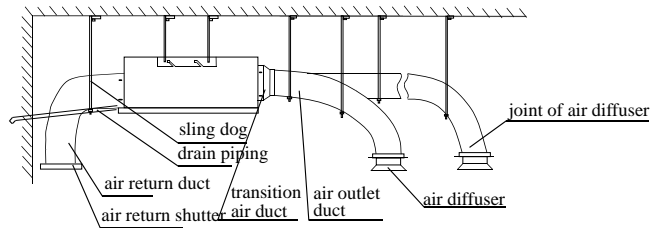

Figure 4



- Each air return and supply duct should fix to the floor precast slab by using an iron stand. Use glue to seal the interface closely. Recommend the distance between the air return duct and the wall is more than 150mm.
- The distance between air duct outlet and air conditioner outlet is according to the length of actually installed air duct and in service behavior of the static pressure terminal: Installation sketch map for long and short air duct is showed below, when connect to short air duct, using low static terminal (terminal color is white), the distance between air duct outlet and air conditioner outlet is no more than 0.5m; when connect to long air duct, using middle static terminal (terminal color is red), the distance between air duct outlet and air conditioner outlet could be within 5m at this point.

Figure 5



- Drain piping of condensed water should keep a downhill grade of 1% or more. Use insulating pipe to cover the drain piping of condensed water to keep warmth.
- As figure shown, suspend and install the unit.

Figure 6

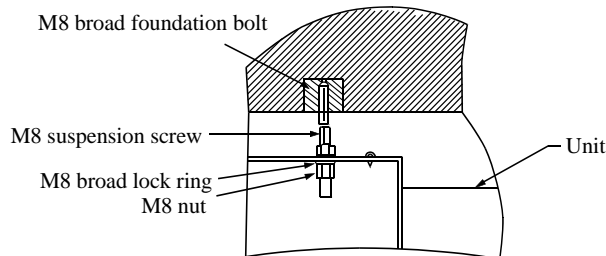

Figure 6

Installation for air duct of indoor unit

1. Installation of air discharge duct

- This type of unit uses circular air duct with its caliber of 180mm.
- An additional transitive air duct is necessary for the circular air duct to connect to the air supply inlet. It should be also connected to its respective air diffuser separately. See Fig.1. Adjust the wind speed of each air diffuser outlet to keep in line on the whole, so as to meet a demand of the air conditioner in the room.

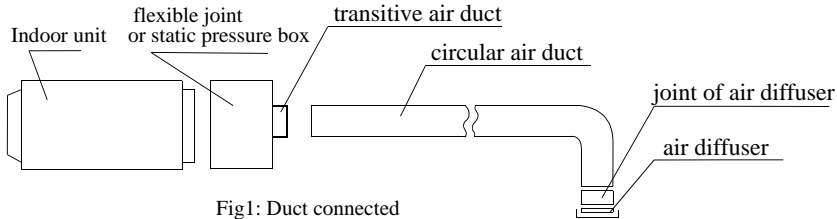

Fig1: Duct connected

2. Installation of air return duct

- Use rivets to connect the air return duct to the air return inlet of the indoor unit. The other end connects to the air return shutter. as shown in Fig.2.

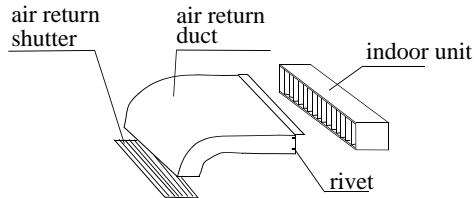
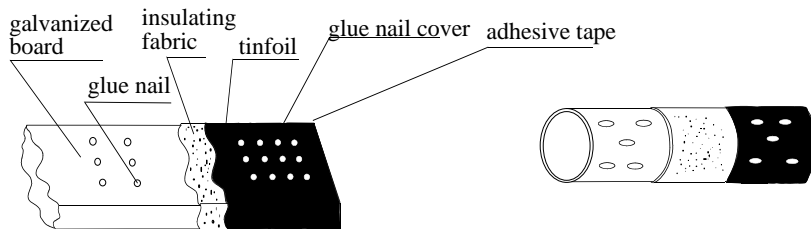

Fig2: Duct return connected

3. Air duct insulation

- Insulation layer is needed for air supply and return duct. First, paste a glue nail to the air duct, and then attach the insulating cotton that has a tinfoil layer and use the glue nail cover to fix. Finally, seal the air duct interface with tinfoil adhesive tape closely. as shown in Fig3.



Installing the suspension screw:

Use M8 or M10 suspension screws (4, prepared in the field) (when the suspension screw height exceeds 0.9 m, M10 size is the only choice). These screws shall be installed as follows with space adapting to air conditioner overall dimensions according to the original building structures.

Wooden structure

A square wood shall be supported by the beams and then set the suspension screws.

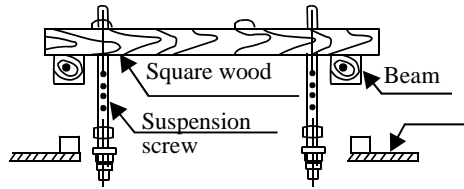

New concrete slab

To set with embedded parts, foundation bolts etc.

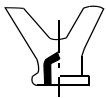

Knife embedded part

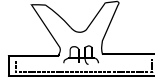

Guide plate embedded part

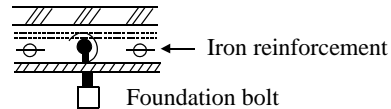

Pipe suspension foundation bolt

Original concrete slab

Use hole hinge, hole plunger or hole bolt.

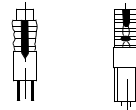

Steel reinforcement structure

Use steel angle or new support steel angle directly.

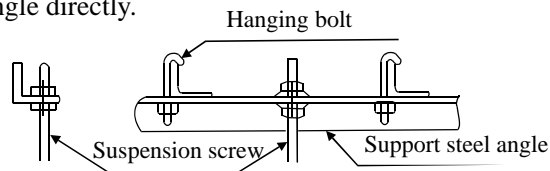

Hanging of the indoor unit

- Fasten the nut on the suspension screw and then hang the suspension screw in the T slot of the suspension part of the unit.
- Aided with a level meter, adjust level of the unit within 5 mm.

⚠ Caution

- In order to drain water normally, the drain pipe shall be processed as specified in the installation manual and shall be thermal insulated to avoid dew generation. Improper hose connection may cause indoor water leakage.

Requirements

- The indoor drain pipe shall be thermal insulated.
- The connection part between the drain pipe and the indoor unit shall be insulated so as to prevent dew generation.
- The drain pipe shall be slant downwards (greater than 1/100). The middle part shall not be of S type elbow, otherwise abnormal sound will be produced.
- The horizontal length of the drain pipe shall be less than 20 m. In case of long pipe, supports shall be provided every 1.5 – 2m to prevent wavy form.
- Central piping shall be laid out according to the following figure.
- Take care not to apply external force onto the drain pipe connection part.

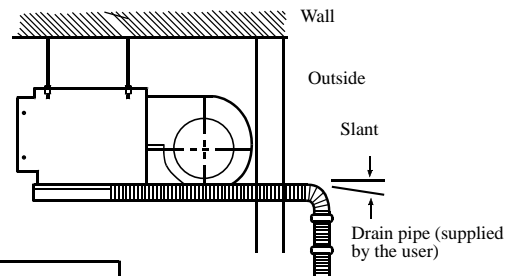
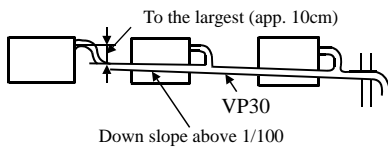
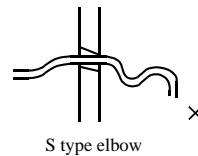
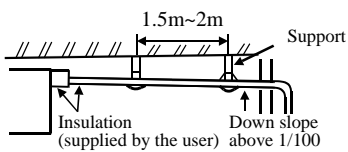

Pipe and insulation material

Pipe	Rigid PVC pipe VP31.5mm (internal diameter)
Insulation	Foamed PE with thickness above 7mm

Hose

Drain pipe size: ? 19.05mm² (3/4") PVC pipe

The hose is used for adjusting the off-center and angle of the rigid PVC pipe.

- Directly stretch the hose to install without making any deformation.
- The soft end of the hose must be fastened with a hose clamp.
- Please apply the hose on horizontal part

Insulation treatment:

- Wrap the hose and its clamp until to the indoor unit without any clearance with insulating material, as shown in the figure.

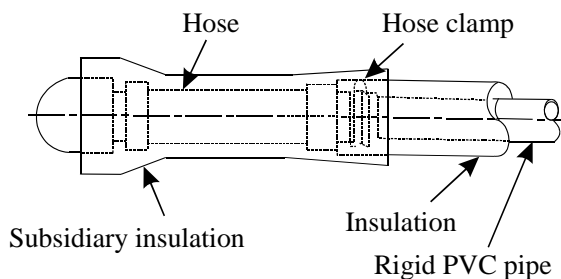

Drain confirmation

During trial run, check that there is no leakage at the pipe connection part during water draining even in winter.

Allowable pipe length and drop

These parameters differ according to the outdoor unit. See the instruction manual attached with the outdoor unit for details.

Supplementary refrigerant

The refrigerant supplementation shall be as specified in the installation instructions attached with the outdoor unit. The added refrigerant shall be R22. The adding procedure shall be aided with a measuring meter for a specified amount of supplemented refrigerant

Requirement

Overfilling or underfilling of refrigerant will cause compressor fault. The amount of the added refrigerant shall be as specified in the instructions.

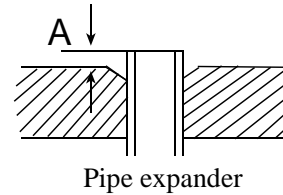

Connection of refrigerant pipe

Conduct flared connection work to connect all refrigerant pipes.

Pipe cutting and expanding

If the pipe is too long or the flare is damaged, it needs to be cut or expanded.

1. Pipe cutting
2. Removing burrs
3. Insertion nut
4. Pipe expansion

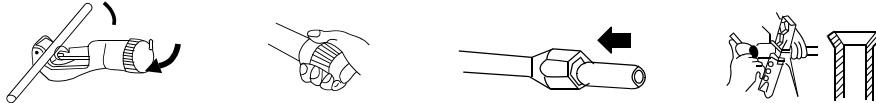

Pipe expansion dimensions as follows:

Pipe diameter *	Size A (mm)
6.35 mm (1/4")	0.8 ~ 1.5
9.52 mm (3/8")	1.0 ~ 1.8
12.7 mm (1/2")	1.2 ~ 2.0
15.88 mm (5/8")	1.4 ~ 2.2

Correct	Incorrect				
	Slope	Damage	Bur	Partial	Overlong

- The connection of indoor unit pipes must use double spanners.
- The installing torque shall be as given in the following table.

Connecting pipe O.D.(mm)	Installing torque (N-m)	Increased installing torque (N-m)
? 6.35	11.8 (1.2kgf-m)	13.7 (1.4 kgf-m)
? 9.52	24.5 (2.5kgf-m)	29.4 (3.0 kgf-m)
? 12.70	49.0 (5.0 kgf-m)	53.9 (5.5 kgf-m)
? 15.88	78.4 (8.0 kgf-m)	98.0 (10.0 kgf-m)

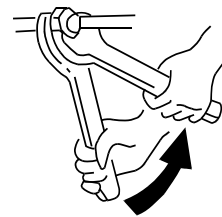

Double-spanner operation

Vacuum pumping

With a vacuum pump, create vacuum from the stop valve of the outdoor unit.

- Emptying with refrigerant sealed in the outdoor unit is absolutely forbidden.

Open all valves

Open all the valves on the outdoor unit.

Gas leakage detection

Check with a leakage detector or soap water that if there is gas leakage at the pipe connections and bonnets.

Insulation treatment

Conduct insulation treatment on both the gas side and liquid side of pipes respectively.

During cooling operation, both the liquid and gas sides are cold and thus shall be insulated so as to avoid dew generation.

- The insulating material at gas side shall be resistant to a temperature above 120°C.
- The indoor unit pipe connection part shall be insulated.

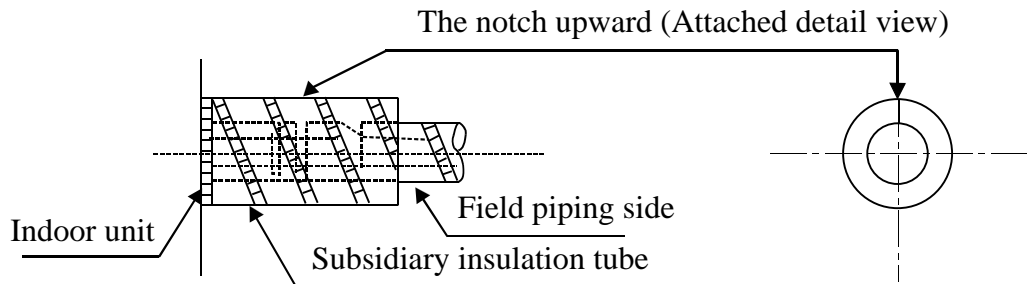

8.4. Installation Precedure(For AF***XCEAA)

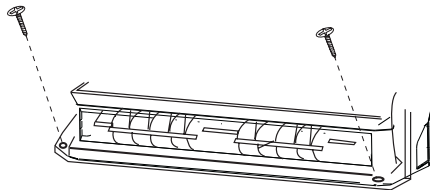
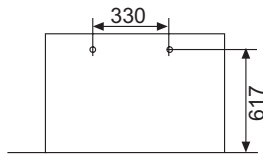
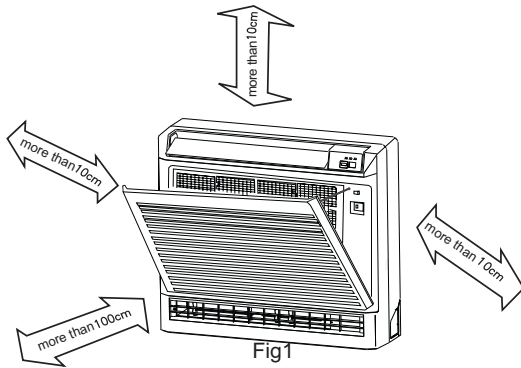

Fig3

Tool necessary

1. Screw driver
2. Hacksaw
3. 70mm dia.hole core drill
4. Spanner(dia. 17,27mm)
5. Spanner(14,17,27mm)
6. Pipe cutter
7. Flaring tool
8. Knife
9. Nipper
10. Gas leakage detector or soap water
11. Measuring tape
12. Reamer
13. Refrigerant oil

Standard accessories

Following parts shall be field supplied

Mark	Part name
(A)	Adhesive tape
(B)	Pipe clip
(C)	Connecting hose
(D)	Insulation material
(E)	Putty
(F)	Drain hose

Fixing the unit

1. Position of the wall hole

Wall hole should be decided according to installation place and piping direction.(refer to installation drawings).







2. Making a wall hole

Selection of installation place

- Place where it is easy to route drainage pipe and outdoor piping.
- Place ,away from heat source and with less direct sunlight.
- Place where cool and warm air could be delivered evenly to every corner of the room.
- Place near power supply socket.Leave enough space around the unit.
- Place ,robust not causing vibration,where the body can be supported sufficiently.
- To prevent interference, place it at least 1m away from other electric machines, such as TV set, radio.

Installing

- According to the dimension of the figure 2 shown, nail two cement steel nails on the wall,Keep 2~3 mm out.then hang the back of the unit on them.
- There must be no gap between the indoor unit and wall.
- Remove the front panel,then use two expansible screws to fix the unit on the floor.As figure 3 shown.
- Once refrigerant piping and drain piping connections are complete,fill the gap of the throught hole with putty.
- Attach the front panel and front grille in their original positions once all connections are complete.

No.	Shape and description	QTY
①	 Remote controller	1
②	 Expansion bushing	4
③	 Self-tapping screw	4
④	 Wall hole cover	1
⑤	 Dry battery #7	1
⑥	 Cement steel nail	6

Note: There isn't connecting wire with this unit.

Drill a hole of 120x70 mm dia. with a little slope towards outside

3. Piping connection

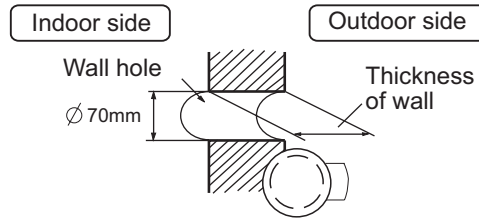

(Cross section of wall hole)

(1) Schematic diagram for unit connection

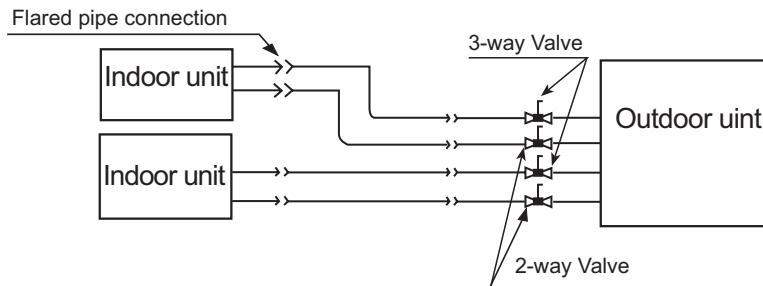

(2) Connection pipe dimensions:

Pipe Value		Torque
Liquid	6.35mm	18 N·m
Gas	12.7mm	50 N·m
Gas	9.52mm	40 N.m

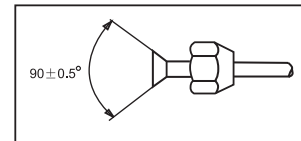

- Apply and tighten the nut.

(3) Cautions for pipe connection

- Pipes free from twists, deformation, water, dust. Dedicated tools for each R407C and R22 should be used and stored separately.
- Optimized radii of bends
- Insulation to be applied on all gaseous pipes
- Flared section free from cracks

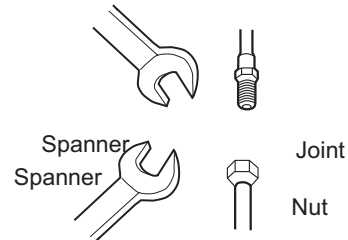

Threads on the pipes may be damaged when tightening if the pipes are not well aligned.

(4) Pipe connection process

Apply refrigeration oil on the end of the pipe to be connected and on the flared section.

Align the pipes to be connected and tighten the nut. (See the figure)

Ensure that no foreign articles enter into the pipes.

Piping connection of the indoor unit

1. Arrangement of piping and drainage pipe

After opening inlet grill, you will see a control box.

Remove the cover before working.

Cut away, with a hammer or a saw, the lid for piping according to piping direction.

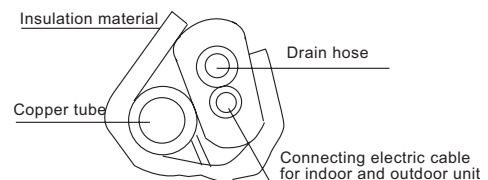

According to the piping method, connect the piping on indoor unit with union of connection pipe. Arrange the piping as per the wall hole and bind drain hose connecting electric cable and piping together with polyethylene tape. Insert the bound piping connecting electric cable and drain hoses through wall hole to connect with outdoor unit.

2. Arrangement drain hose

Drain hose shall be placed in under place.

There should be a slope when arrange drain hose. Avoid up and down waves in drain hose.

If humidity is high, drain pipe(especially in room and indoor unit) must be covered with installation material.

Electric wiring :

Process of wire connections

1. Loop terminal

After removing the screw, fix the wire ring on the screw, reinsert the screw into the block terminal and then tighten the screw.

2. Straight terminal

After loosening the screw, inset the wire end into the block terminal and then tighten the screw. Slightly pull the wire to see if it is tightly fixed.

3. Wire capping

After completion of connection, capping clips must be applied on the external sleeve of the wires.

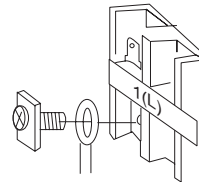

Wiring of indoor unit

- Remove air intake screen and take out the front wires.
- Connect the wires as specified in the above methods and diagrams for indoor unit and wire connections.
- Properly apply capping clips on the wires.
- Replace the air intake screen.
- Do not link the connecting and signal wire with the same cable, a snug space must be maintained between connecting and signal wires.
- Shield of the signal wire should be spot grounded.

Wiring diagram of loop terminals

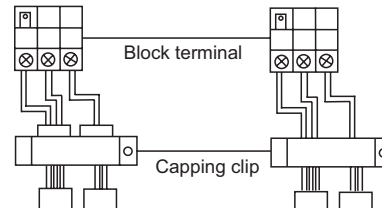

Wiring diagram:

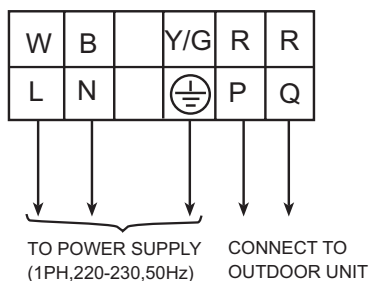

Note:

- When connecting indoor and outdoor wire, check the number on indoor and outdoor terminal blocks. Terminals of same number and same color shall be connected by the same wire.
- Incorrect wiring may damage air conditioner's control or cause operation failure.

Others

1. Power supply requirements:

- Voltage: single-phase 1PH, 220-230V~, 50Hz
- Dedicated electrical cable should be installed by a qualified technician in accordance with the state regulation for electrical engineering.
- The power source must be grounded.
- A circuit breaker must be installed
- Electrical cables should be connected by Y method. Damaged or worn electrical cable must be replaced by authorized after sales agents.
- The power plug should be connected as follows: L for live line, N for neutral line and ⊕ for grounding.
- Connection parameters: H05RN-F 3G(1.0~1.5)mm²
- Signal parameters: H05RN-F2X(0.75~1.5)mm² (Shielded wire)
- Cables for power supply, connection and signals are prepared by the owner.

2. Piping cutting and flaring

Be sure to carry out deburring after cutting with a pipe cutter.
Insert flaring tool to make a flare.

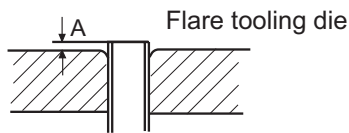

	Pipe diameter ϕ	Size A (mm)
Liquid pipe	6.35mm(1/4")	0.8 ~1.5
Gas pipe	12.7mm(1/2")	1.2 ~2.0

Correct	Incorrect					
	Lean	Damage of flare	Crack	Partial	Too outside	

Installation inspection and test run:

Please operate unit according to this Manual.

Items to be checked during test run. Please make a "✓" in "□"

- Are there any gas leakage?
- How is insulation at piping connection carried out?
- Are electric wires of indoor and outdoor unit firmly inserted into terminal block?
- Is electric wiring of indoor and outdoor securely fixed?
- Is drainage securely carried out?
- Is earth line(grounding) securely connected?
- Is power supply voltage abided by the code?
- Is there any noise?
- Is control display normal?
- Is cooling operation normal?
- Is room temp. regulator normal?

Allowable pipe length and drop

These parameters differ according to the outdoor unit. See the instruction manual attached with the outdoor unit for details.

Supplementary refrigerant

The refrigerant supplementation shall be as specified in the installation instructions attached with the outdoor unit. The added refrigerant shall be R22.

The adding procedure shall be aided with a measuring meter for a specified amount of supplemented refrigerant

Requirement

Overfilling or underfilling of refrigerant will cause compressor fault. The amount of the added refrigerant shall be as specified in the instructions.

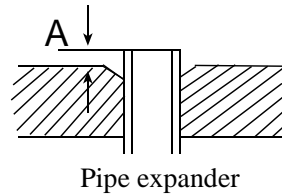

Pipe expander

Connection of refrigerant pipe

Conduct flared connection work to connect all refrigerant pipes.

Pipe cutting and expanding

If the pipe is too long or the flare is damaged, it needs to be cut or expanded.

1. Pipe cutting
2. Removing burrs
3. Insertion nut
4. Pipe expansion

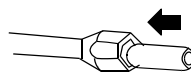
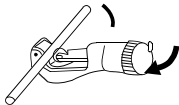

Pipe expansion dimensions as follows:

Pipe diameter *	Size A (mm)
6.35 mm (1/4 ")	0.8 ~ 1.5
9.52 mm (3/8 ")	1.0 ~ 1.8
12.7 mm (1/2 ")	1.2 ~ 2.0
15.88 mm (5/8 ")	1.4 ~ 2.2

Correct	Incorrect
	Slope Damage Bur Partial Overlong

- The connection of indoor unit pipes must use double spanners.
- The installing torque shall be as given in the following table.

Connecting pipe O.D.(mm)	Installing torque (N-m)	Increased installing torque (N-m)
6.35	11.8 (1.2kgf-m)	13.7 (1.4 kgf-m)
9.52	24.5 (2.5kgf-m)	29.4 (3.0 kgf-m)
12.70	49.0 (5.0 kgf-m)	53.9 (5.5 kgf-m)
15.88	78.4 (8.0 kgf-m)	98.0 (10.0 kgf-m)

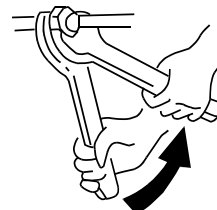

Double-spanner operation

Vacuum pumping

With a vacuum pump, create vacuum from the stop valve of the outdoor unit.

- Emptying with refrigerant sealed in the outdoor unit is absolutely forbidden.

Open all valves

Open all the valves on the outdoor unit.

Gas leakage detection

Check with a leakage detector or soap water that if there is gas leakage at the pipe connections and bonnets.

Insulation treatment

Conduct insulation treatment on both the gas side and liquid side of pipes respectively.

During cooling operation, both the liquid and gas sides are cold and thus shall be insulated so as to avoid dew generation.

- The insulating material at gas side shall be resistant to a temperature above 120°C.
- The indoor unit pipe connection part shall be insulated.

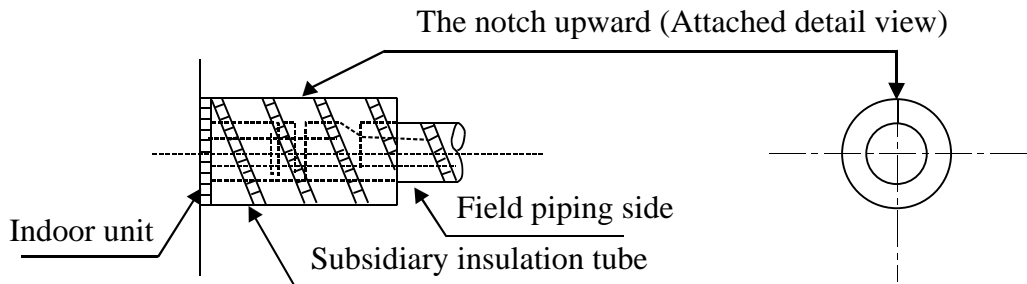

8.5. Wall Mounted Type (For AS***XCEAA)

Instructions to installation

PRECAUTION

- Execute proper grounding. Do not connect the earth wire to a gas pipe, water pipe, lightning rod, or a telephone ground wire. Improper placement of earth wires can result in electric shock.
- An electric leakage breaker must be installed, otherwise electric shock or other accidents would occur.
- After completion of the installation, the air conditioner shall be electrified to check for electric leakage.

5.5.1. Preparation for installation

Installation tools

1	Screw Driver (flat head, wabblers, triangle)	8	Pipe Expander
2	Steel Saw	9	Knives
3	60mm Drill	10	Clippers
4	Inner Hexagon Spanner	11	Leakage Checker or Soap Liquid
5	Shifting Spanner	12	Measuring Tape
6	Spanner	13	Scraper or File
7	Pipe Cutter	14	Refrigeration Oil

8.5.2. Wiring connection

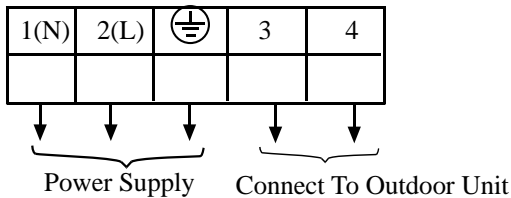

Note: Connect ports 3 and 4 of Indoor terminal board with ports P and Q of outdoor terminal board.
--

Electrical Requirements

A specialized power supply wire, which shall be installed by a competent person as per the rules of the national standard.

Power supply must be grounded effectively.

An electric leakage breaker shall be installed.

Layout of power supply wiring shall be Y connection. If the power supply wire is damaged, it must be replaced by the manufacturer or its service center or professional person (the power supply wire shall be self-contained).

For connection of the power supply plug, L shall be connected with the live wire, N shall be connected with neutral line, shall be connected with earth wire.

Power supply wire parameters:H05RN-F 3G(1.0-1.5)mm² ;

Signal wire parameters:H05RN-F 2x(0.75-1.5)mm² (User shall self-provide signal wire).

Note:The signal wire and connection wire should be provided for oneself.
--

The signal wire must be shielded wire

8.5.3. Choose the installation place

- Install the indoor unit where the weight of the unit can be supported.
- Install the indoor unit where the heat source and steam source are not close and the unit inlet and outlet are not blocked.
- Install the indoor unit where the drainage is easy and the outdoor unit can be easily connected.
- Install the indoor unit where its cold air and hot air can be easily sent to all the comers of the room.
- Install the indoor unit where the power socket is near and there is sufficient space around the indoor unit.
- Install the indoor unit where there is no T.V set, radio set, and wireless aplian ce underneath, and the sunlight lamp is over one meter away.
- If the remote controller is installed on the wall, the indoor unit shall be ensured to receive the signal while the sunlight lamp is on.

8.5.4. Method for Cutting and Expanding Pipes.

When the pipe is too long or the mouth is damaged, the pipe needs to cut or expanded.

1. cutting hose
2. Removing burr
3. Put on nut
4. Expand Hose

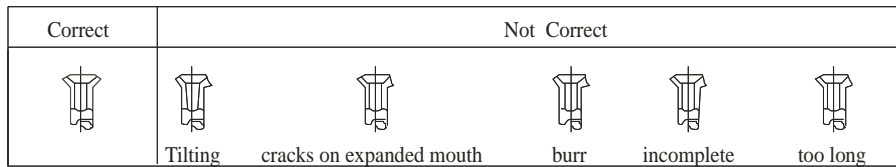
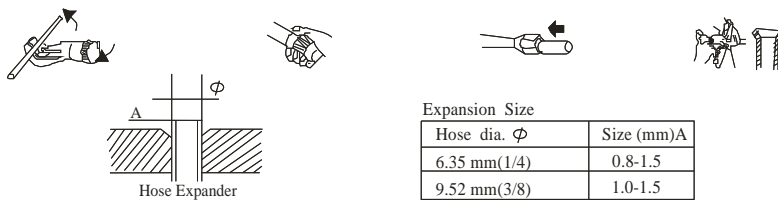

8.5.5. When the mounting plate is first fixed

1. Carry out, based on the neighboring pillars or lintels, a proper leveling for the plate to be fixed against the wall, then temporarily fasten the plate with one steel nail.
2. Make sure once more the proper level of the plate, by hanging a thread with a weight from the central top of the plate, then fasten securely the plate with the attachment steel nail.

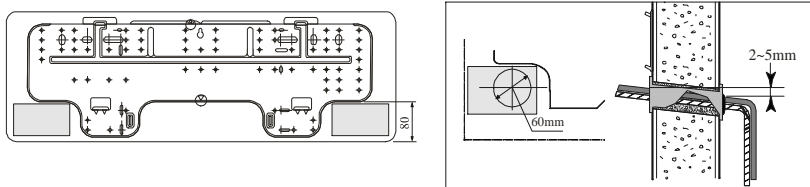

3. Making a Hole on the wall and Fitting the piping Hole cover.

- Make a hole of 60mm in diameter, slightly descending to outside the wall.
- Install piping hole cover and seal it off with putty after installation.

4. Drawing of pipe Rear piping

- Draw pipes and the drain hose, then fasten them with the adhesive tape. Left Left-rear, piping.
- In case of left side piping, cut away, with a nipper, the lid for left piping.
In case of left-rear piping, bend the pipes according to the piping direction to the mark of hole for left-rear piping which is marked on heat insulation materials.

- (1) Insert the drain hose into the dent of heat insulation materials of indoor unit.
 - (2) Insert the indoor/outdoor electric cord from backside of indoor unit, and pull it out on the front side, then connect them.
 - (3) Coat the flaring seal face with refrigerant oil and connect pipes.
- Cover the connection part with heat insulation materials closely, and make sure fixing with adhesive tape.

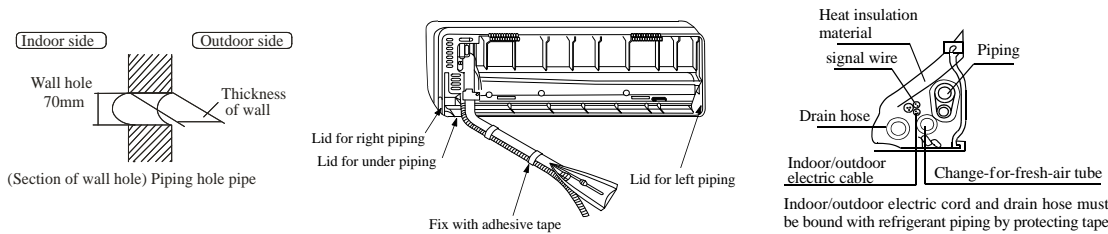

5.5.6. Other direction piping

- Cut away, with a nipper, the lid for piping according to the piping direction and then bend the pipe according to the position of wall hole. When bending, be careful not to crash pipes.
- Connect beforehand the indoor/outdoor electric cable, and then pull out the connected to the heat insulation of connecting part specially.
- Hang surely the unit body onto the upper notches of the mounting plate. Move the body from side to verify its secure fixing.
- In order to fix the body onto the mounting plate, hold up the body aslant from the underside and then put it down perpendicularly.

8.5.7. When connecting the cord before installing the indoor unit

- Insert the cord from the back side of the unit, then pull it out on the front side.
- Loosen the screws and insert the cord ends fully into terminal block, then tighten the screws.
- Pull the cord slightly to make sure the cords have been properly inserted and tightened.
- After the cord connection, never fail to fasten the connected cord with the wiring cover.

Note: when connecting the cord, confirm the terminal number of indoor and outdoor units carefully. If wiring is not correct, proper operation can not be carried out and will cause defect.

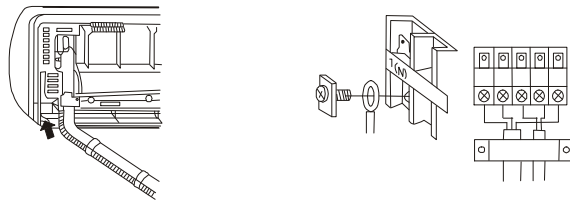

8.5.8. How to connect wiring to the terminals

1. For solid core wiring (or F-cable)(Fig.1)
 - (1) Cut the wire with a wire cutter or wire-cutting pliers, then strip the insulation to about 25mm of the exposed solid wire.
 - (2) Using a screwdriver, remove the terminal screw (s) on the terminal board.
 - (3) Using pliers, bend the solid wire to form a loop suitable for the terminal screw.
 - (4) Shape the loop wire properly, place it on the terminal board and tighten securely with the terminal screw using a screw driver.
2. For strand wiring (Fig.2)
 - (1) Cut the wire with a wire cutter or wire-cutting pliers, then strip the insulation to about 10mm of the exposed strand wiring.
 - (2) Using a screwdriver, remove the terminal screw (s) on the terminal board.

- (3) Using a round terminal fastener or pliers, securely clamp a round terminal to each stripped wire end.
- (4) Position the round terminal wire, and replace and tighten the terminal screw using a screw driver.

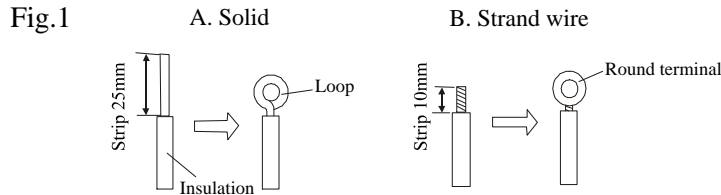

After passing the connection cord and power cable through the insulation tube, fasten it with the cord clamp, as shown in Fig.18

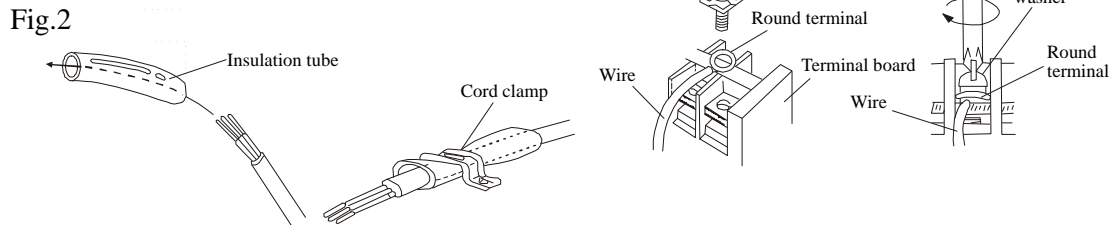

Use VW-1,0.5 to 1.0mm thick, PVC tube as the insulation tube.

3. How to check the addresses?

When finish all the above works, please power off and power on again to the whole system but set all the indoor units in STANDBY. Then continuously press the emergency switch until you hear the buzzer sound 5 times(Pi Pi Pi Pi Pi), and then the LCD display board will show the address of this indoor unit. Press any key on the remote controller, it will exit the address checking procedure.

8.5.9.Installation check and trial operation

Check the Layout of the Drain Pipe and Connection Wires, and also the piping and address setting. The drain pipe should be placed underneath, and the connection wires should be placed upside; and the drain pipe especially the section inside the machine and indoors must be wound up with insulating material to preserve heat. The drain pipe shall be sloped and no concave and convex shall occur along the whole pipe. And the cases as the right figure indicates shall not occur.

8.5.10.Installation check

- Is power supply voltage required?
- Is water completely drained to outdoors?
- Are power wire and connection wires between indoor and outdoor units correctly connected?
- Is any gas leaked from the pipe connectors?
- Are series numbers of the terminals on the indoor and outdoor units corresponding to each other?
Is the connection section of the auxiliary pipe insulated? Is the indoor unit fixed firmly?
- Is noise big?

8.5.11.Trial operation

The person who has completed this installation shall be requested to conduct a test operation for check:

- Is the temperature adjuster working normally?
- Does the location for installation conform to requirements?

Winding up with Protective Plastic Tape.The connection pipes,drain pipe, and the connection wires shall be wound up with PVC tape.

Notes: The connection pipes shall also be wound up with insulating material to preserve the temperature. The airing direction shall be from bottom to top.

9. Wiring Diagram, PCB photo and function information

9.1.1. Wiring Diagram for AB072-142XCEAA

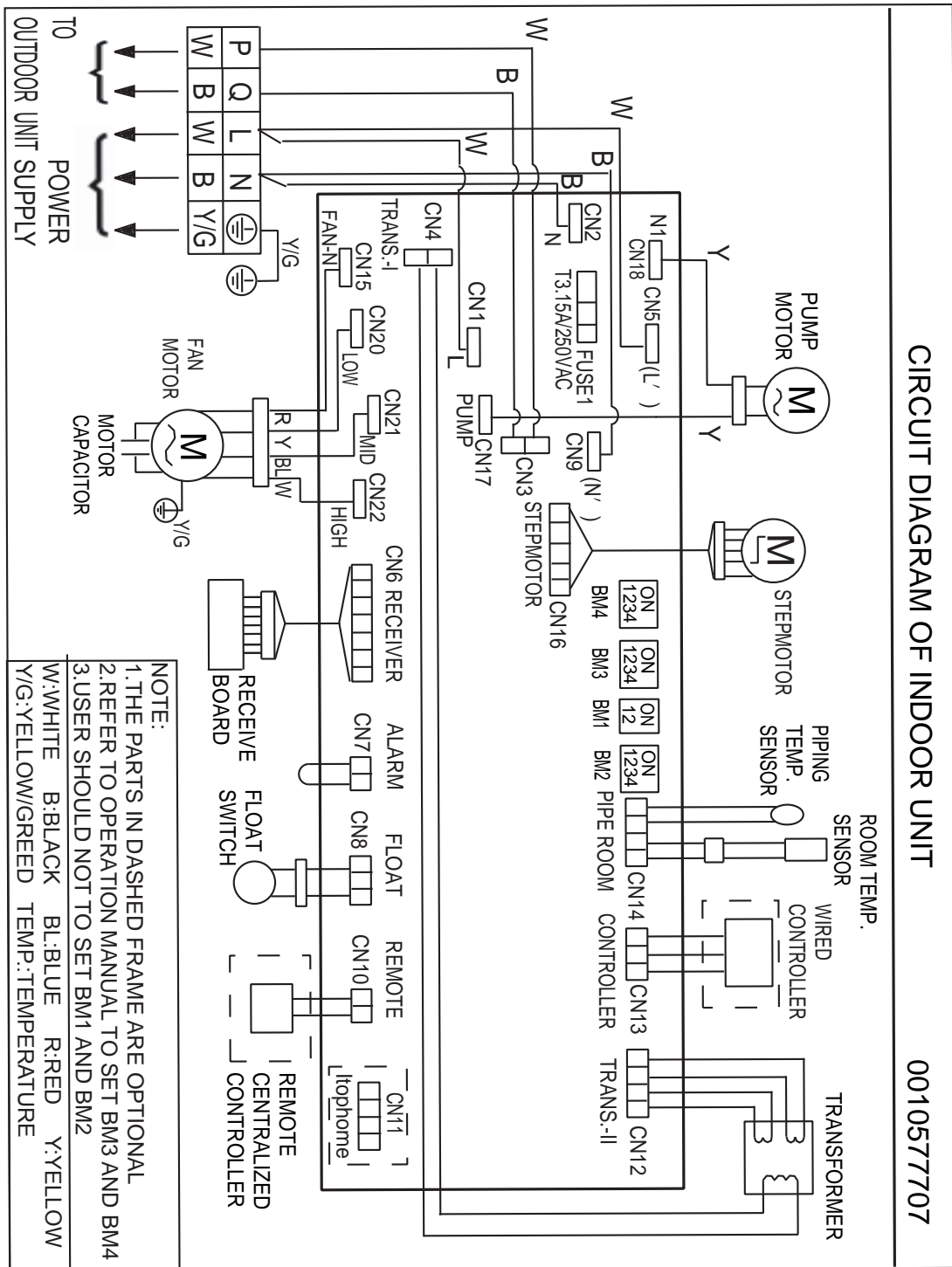

9.1.2. 0010451869 PCB Photo

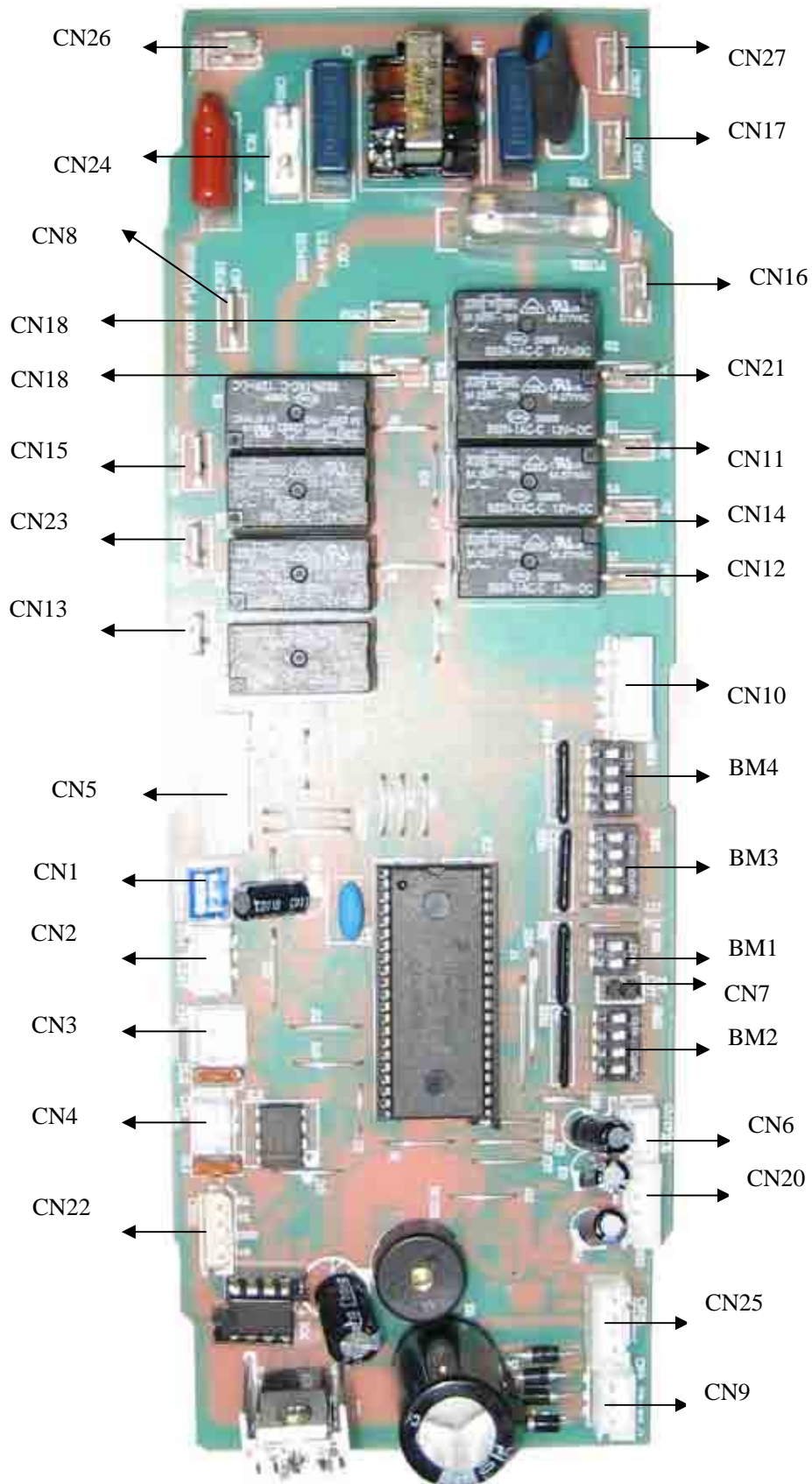

9.1.3. Dip Switch Functions (For AB072-142XCEAA)

Functions of dip switch 1 (BM1)

ON : ON , OFF : OFF

Description	BM1(1)	BM1(2)
Outdoor unit hasn't PC	OFF	OFF
Outdoor unit is fixed frequency single split unit	ON	OFF
Outdoor unit is fixed frequency Multi split unit	OFF	ON
Outdoor unit is inverter type single split unit	ON	ON

Functions of dip switch 2 (BM2)

Description	BM2(1)	BM2(2)	BM2(3)	BM2(4)
Heating temp. compensation(+4/0)	ON/OFF	*	*	*
Wired controller/infrared controller	*	ON/OFF	*	*
Cooling only/heat pump	*	*	ON/OFF	*
Master unit/slave unit	*	*	*	ON/OFF

Functions of dip switch 3,4 (BM3,BM4)

Address	BM3				BM4				4
	1	2	3	4	1	2	3		
1	OFF	OFF	OFF	OFF	OFF	OFF	OFF	OFF, system hasn't BMS control function;ON, system has BMS control function	
2	ON	OFF	OFF	OFF	OFF	OFF	OFF		
3	OFF	ON	OFF	OFF	OFF	OFF	OFF		
4	ON	ON	OFF	OFF	OFF	OFF	OFF		
5	OFF	OFF	ON	OFF	OFF	OFF	OFF		
6	ON	OFF	ON	OFF	OFF	OFF	OFF		
...		
126	ON	OFF	ON	ON	ON	ON	ON		
127	OFF	ON	ON	ON	ON	ON	ON		
128	ON	ON	ON	ON	ON	ON	ON		

BMS: including Group control, Central controller, Weekly timer. CN10 is the port for central controller or weekly timer communication. the installation is same with Free Multi R407C

9.1.4.Diagnostic code

Diagnostic code for AB072-142XCEAA

For remote type, flash times	Failure description	Reason	Remarks
1	Indoor ambient temp. sensor failure	Sensor broken down or short circuit for more than 2m continuously	○
2	Indoor coil temp. sensor failure	Sensor broken down or short circuit for more than 2m continuously	○
3	Outdoor ambient temp. sensor failure	Sensor broken down or short circuit for more than 2m continuously	○
4	Outdoor coil temp. sensor failure (compressor discharging temp. sensor)	Sensor broken down or short circuit for more than 2m continuously	✕
5	Over-current protection	CT check abnormal 3 times in 30m	✕
6	High pressure abnormal	High pressure switch acts 3 times in 30m	✕
7	Power supply abnormal	Fault phase, short of phase, out of balance greatly	○
8	Communication between wired controller and indoor abnormal	Communication abnormal for more than 4m continuously	○
9	Communication between indoor and outdoor abnormal	Communication abnormal for more than 4m continuously	○
10	Drainage system abnormal	Float switch broken down for more than 25m continuously	○
11	Outside alarm signal input	Outside signal broken down for more than 10s	○
13	Solenoid valve abnormal	Solenoid valve act incorrectly 3 times continuously	○
14	Discharging temp. sensor abnormal	Sensor broken down or short circuit for more than 2m continuously	○
15	EEPROM abnormal	EEPROM data missing	○
16	Pressure abnormal (low pressure)	Low pressure switch acts in normal running	✕
17	Compressor overheat	The discharging temperature is higher than 120degree	○ Resumable if lower than 100 degree
18	Abnormal mode	Indoor operation mode is different with the running indoor unit.	○

○ shows resumable fault, ✕ shows it is not resumable fault.

9.2.1. Wiring Diagram for AB212XCEAA 0010574152

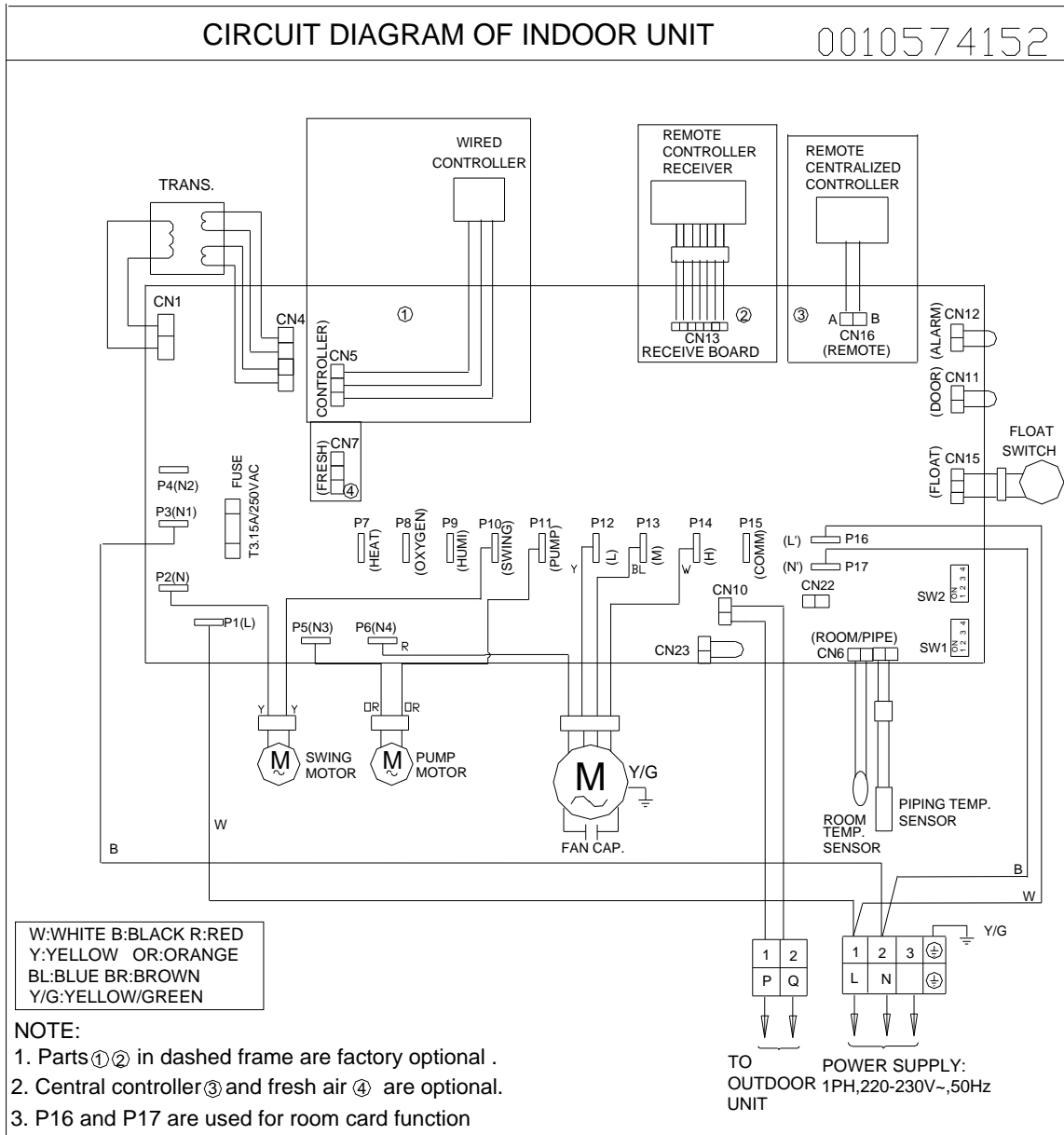

9.2.2.PCB 0010451847

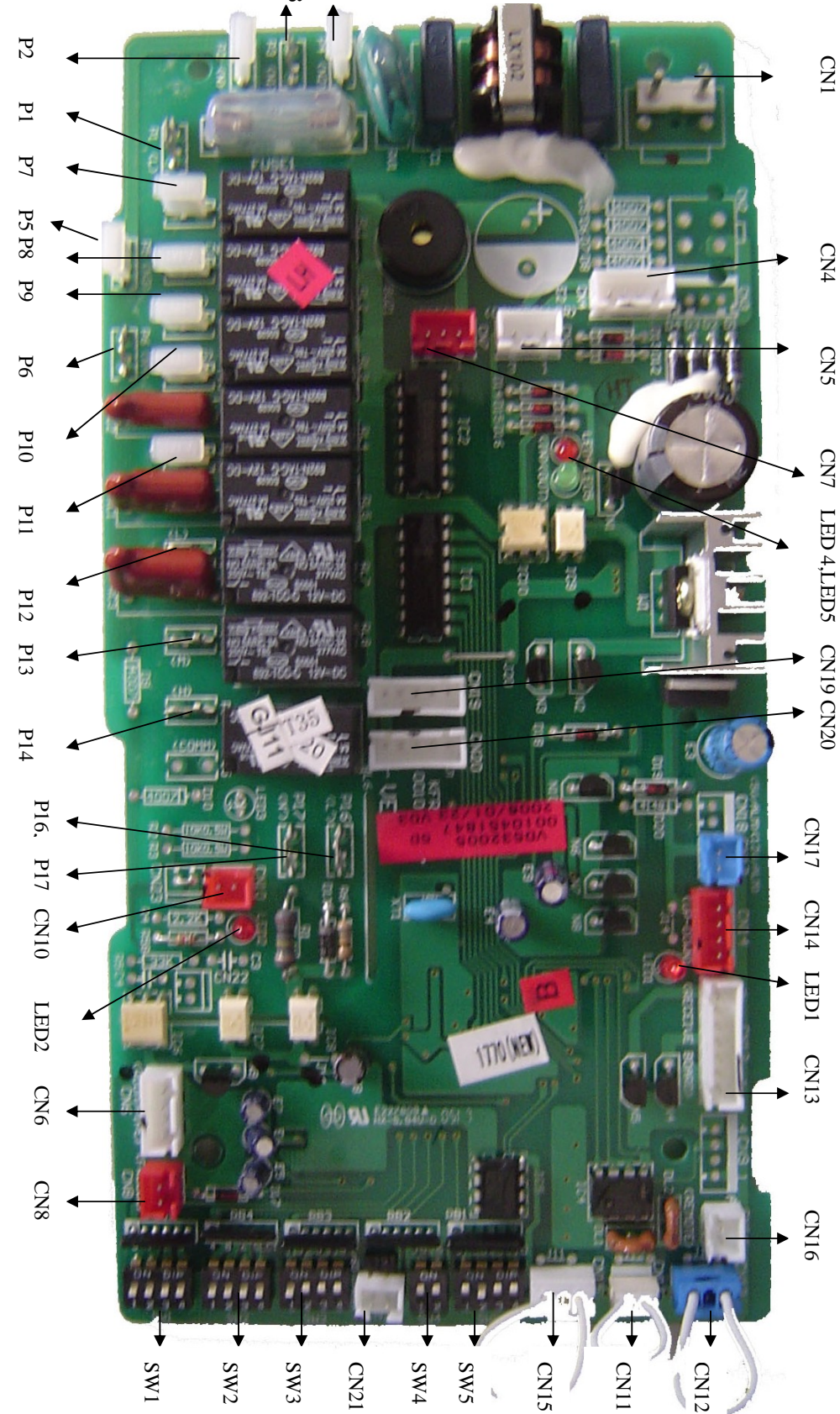

9.2.3. 0010451847 PCB Dip Switch Functions

Caution: ON is 1, OFF is 0

SW1-SW2: used for indoor unit to set unit address from 1 to 16'

SW3-SW5: used for indoor unit to select different functions.(every dip switches are corresponding to J1-J10.

SW2-4——logistic relationship of control function (door card control and remote/wired control) 0 means logistic relationship is “and”, 1 means the later coming is preferential.

J1, SW3-1——function selection-control type: 1 means remote control, 0 means wired control.

J2, SW3-2——function selection-temperature compensation in heating mode: 1 means “yes”, 0 means “no”.

J3, SW3-3——function selection-outdoor communication: 1means “yes”, 0 means “no”. This PCB must be 1.

J4, SW3-4——function selection-heat pump unit: 1means “heat pump”, 0 means “cooling only”.

1/60——test in short circuit, but in operation short circuit mustn't be permitted.

CHECK——short spring switch control, it also can be used as switch of convertible type except for testing.

J5, SW4-1——function selection-outdoor pressure switch control function(if outdoor is without PCB): 1means the pressure switch is invalid, 0 means the pressure switch is valid.

J6, SW4-2 —— function selection –outdoor defrosting temp. sensor control function(when outdoor is without PCB): 1means outdoor def rost temp. sensor is invalid; 0 means outdoor defrost temp. sensor is valid.

J7, SW5-1——function selection –swing mode: 1 means common (simultaneous motor) , 0 means special (swing motor).

J8, SW5-2——function selection – system combination: 1means fixed frequency single unit, 0 means fixed frequency multi split. (Notice: Free Multi: Must be 0)

J9, SW5-3——function selection –group control: 1 stands for the master unit (its address in wired controller is 0), 0 stands for the slave units (the address should be set by the dip switch, their addresses only can be in the range: 1~15)

J10, SW5-4——function selection –preset: 1 no meaning, 0 no meaning

Caution: PCB, Wiring Diagram, Diagnostic Code of AD07-212XLEAA are same with AB212XCEAA

9.2.4. Diagnostic code

Display 1	Display 2	Display 3	Diagnostic description	Possible reason
1	01	01	Indoor ambient temp. sensor failure	sensor broken down or short circuit for more than 2m continuously
2	02	02	Indoor coil temp. sensor failure	sensor broken down or short circuit for more than 2m continuously
3	4A	11	Outdoor ambient temp. sensor failure	sensor broken down or short circuit for more than 2m continuously
4	49	12	Outdoor coil temp. sensor or compressor discharging temp. sensor failure	Sensor broken down or short circuit for more than 2m continuously
5	48	10	Over-current protection	CT check abnormal 3 times in 30m
6	53	14	High pressure abnormal	High pressure switch acts 3 times in 30m
7	47	22	Power supply abnormal	Fault phase, out of balance greatly
8	07	06	Communication between wired controller and indoor abnormal	Communication abnormal for more than 4m continuously
9	06	05	Communication between indoor and outdoor abnormal	Communication abnormal for more than 4m continuously
10	08	21	Drainage system failure	Float switch broken down for more than 25m continuously
11	0B	30	indoor PCB CN12(Outside alarm signal input) abnormal	Outside signal broken down for more than 10s
12	03	20	Gas pipe temp. sensor abnormal	Sensor broken down or short circuit for more than 2m continuously
13	0D	31	Solenoid valve abnormal	Solenoid valve act incorrectly 3 times continuously
14	4C	15	Discharging temp. sensor abnormal	sensor broken down or short circuit for more than 2m continuously
15	05	17	EEPROM abnormal	EEPROM data missing
16	54	26D	Low pressure switch abnormal	Low pressure switch acts in normal running(Open : Alarm, Close : Normal)
17	50	15	Compressor overheat	The discharging temp, is higher than 120℃
18	12	23	Abnormal mode	Indoor operation mode is different with the running indoor unit. (for example: one in cooling, one in heating)
21	32	07	Outdoor power model abnormal	Check outdoor power model wires connection or change the model
22	54	08	The current is overlow	No signal comes from current testor or compressor doesn't work

Mark:

Display 1: For remote type, flash times;

Display 2: Diagnostic code on YR-E12;

Display 3: For central controller YCZ-A001

9.3.1. Wiring Diagram For AF07-142XCEAA

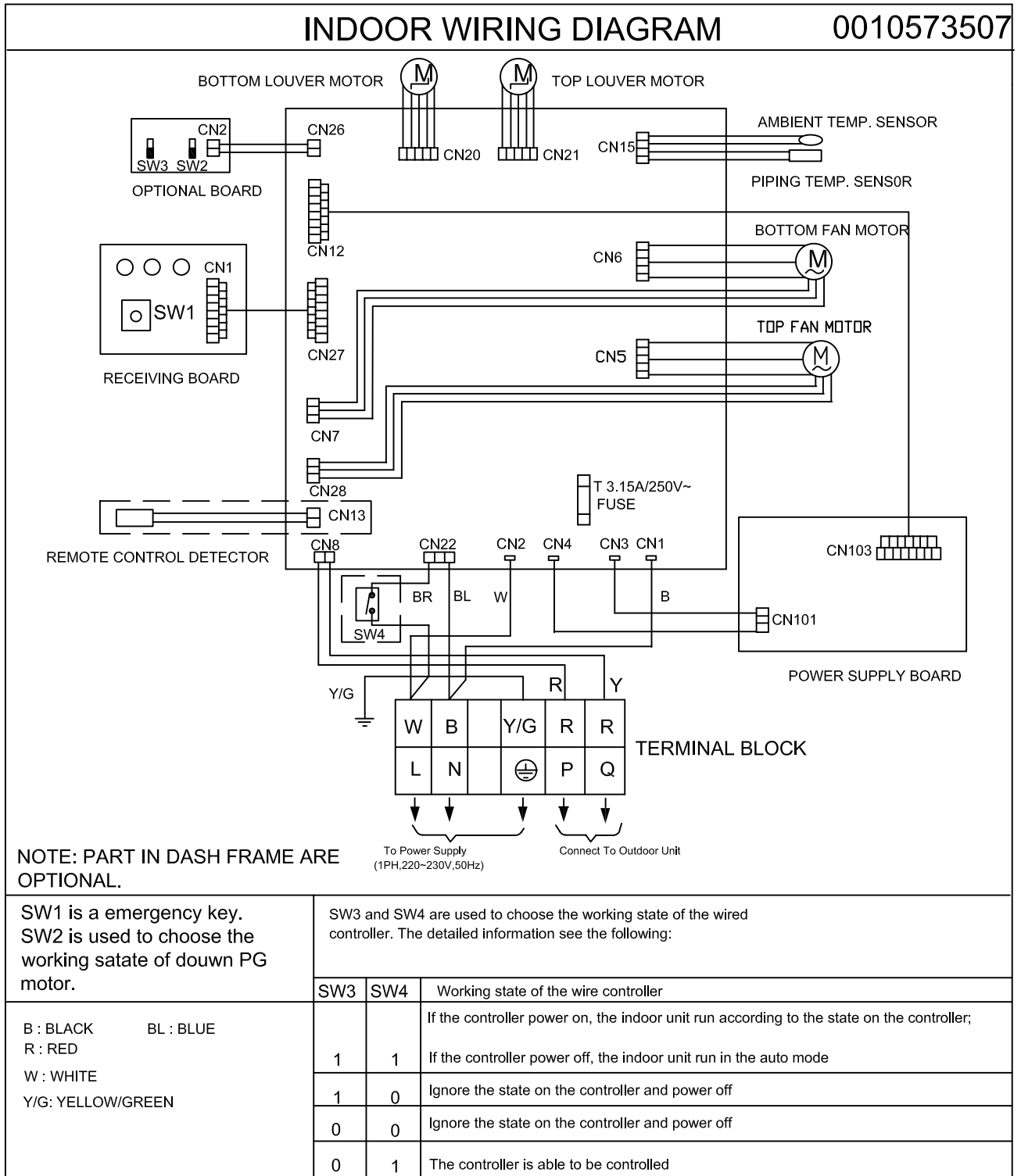

9.3.2. PCB Photo

PCB 0010451212-Part 1:

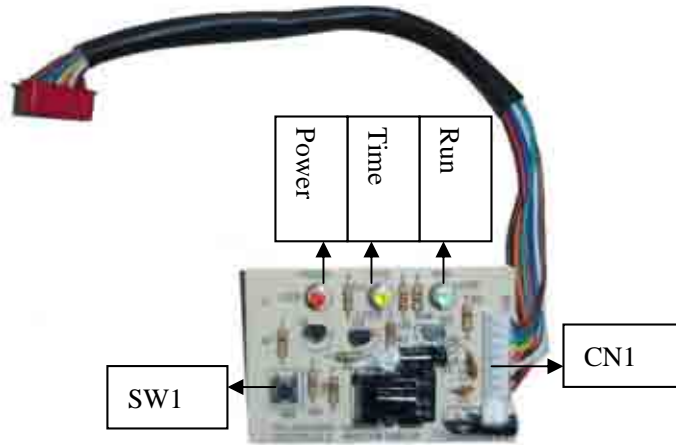

PCB 0010451212-Part 2:

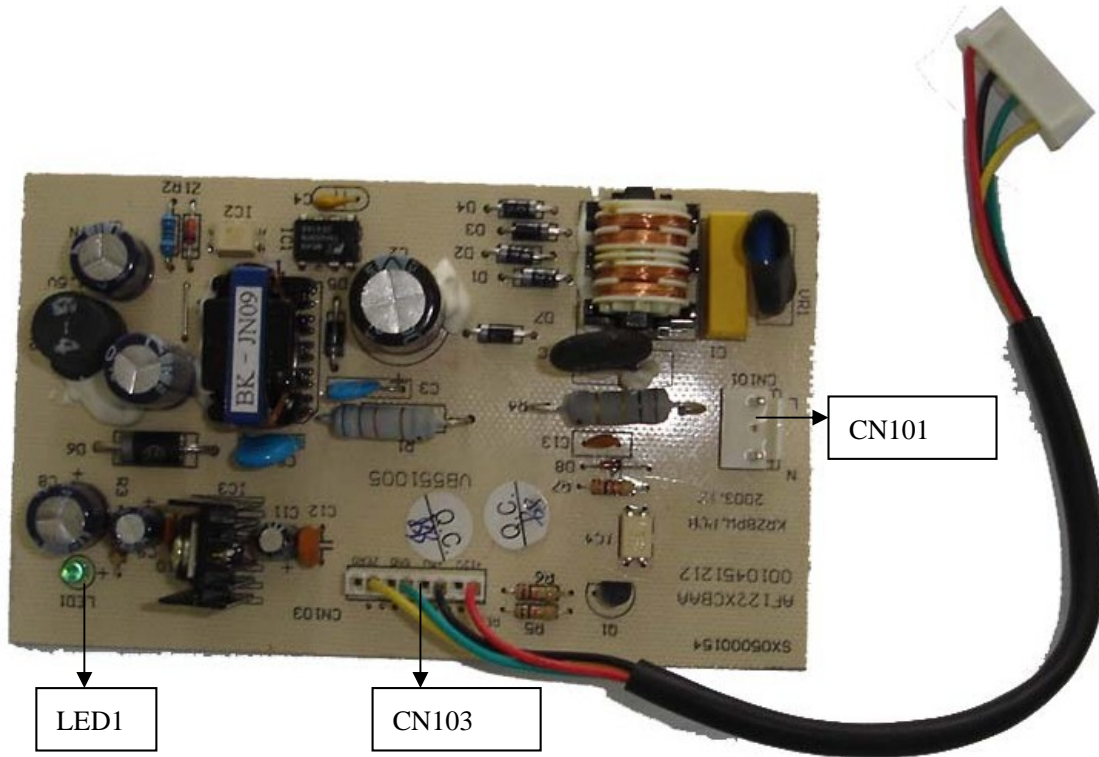

9.3.3. PCB 0010451212-Part 3:

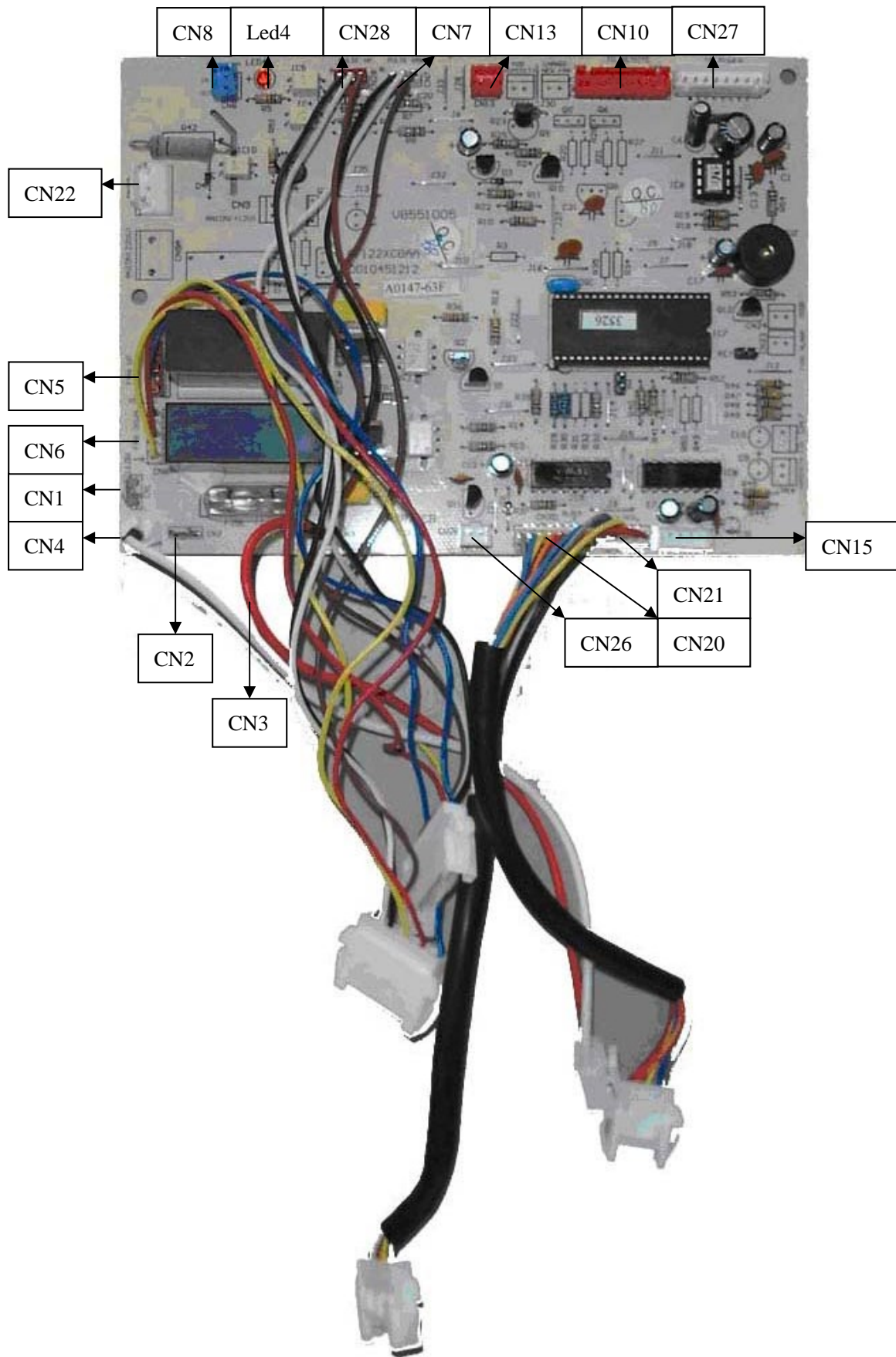

9.3.4. Diagnostic Code

Resumable failures are marked with "⊙", the others are not resumable failures. Resumable failure will disappear when the failure is eliminated and its failure code will disappear automatically within 30 seconds. But the other failure code will disappear only after the unit starts up once again.

When failure occurs, the unit only can receive "OFF" signal from the controller.

And when the unit is shut off, the failure code will disappear.

Failure description	Flash times of indoor receiver board
Room temp. sensor abnormal ⊙	Power LED flashes 1 time
Indoor coil temp. sensor abnormal (liquid pipe) ⊙	Power LED flashes 2 times
Refrigerant system abnormal ⊙	Power LED flashes 3 times
High pressure abnormal (outdoor) ⊙	Power LED flashes 5 times
Drainage abnormal	Power LED flashes 6 times
Communication between indoor and wired controller ⊙	Power LED flashes 7 times
Indoor fan motor abnormalup	Power LED flashes 8 times
Indoor fan motor abnormaldown	Power LED flashes 9 times
3 phase abnormal	Running LED flashes once
Low pressure abnormal (outdoor)	Running LED flashes twice
Communication between indoor and outdoor abnormal⊙	Running LED flashes 3 times
Compressor overheat	Running LED flashes 4 times
CT current abnormal	Running LED flashes 5 times
Outdoor ambient temp. sensor abnormal ⊙	Running LED flashes 6 times
Outdoor coil pipe temp. Sensor A abnormal⊙	Running LED flashes 7 times
Outdoor discharging temp. sensor B abnormal ⊙	Running LED flashes 8 times
Outdoor coil pipe temp. sensor B abnormal ⊙	Running LED flashes 10 times
Abnormal modes running ⊙	Running LED flashes 11 times
Outdoor discharging temp. sensor A abnormal⊙	Running LED flashes 12 times
Indoor EEPROM abnormal	Running LED flashes 14 times

Notice: Wall mounted AS type diagnostic code is same with console type AF.

9.4.1. Wiring Diagram for AS***XCEAA

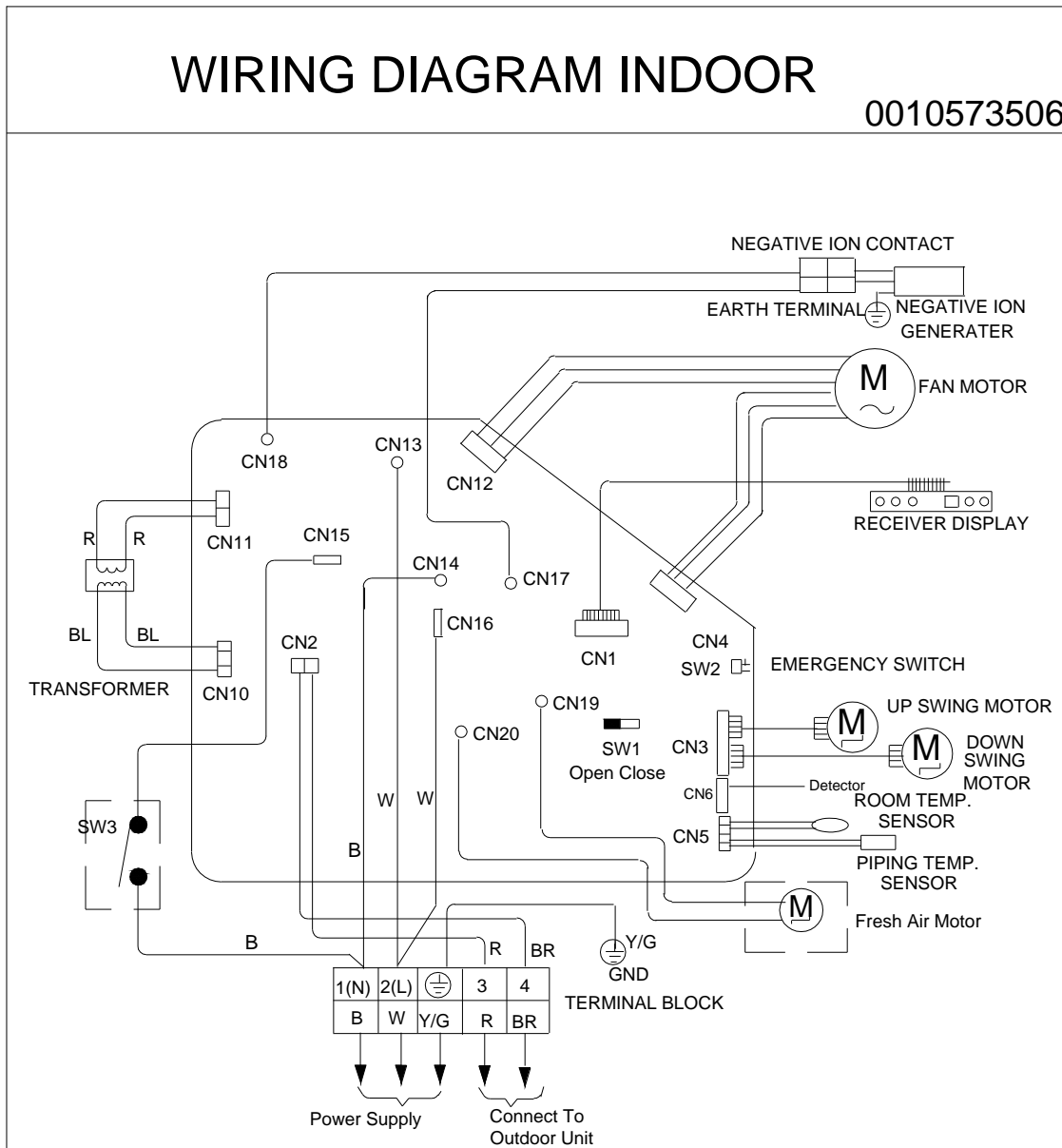

SW1 and SW3 are used to choose the working state of the wire controller. The detailed information see the following:

NOTE : PARTS IN DASHED FRAMES ARE OPTIONAL.

SW1	SW3	Working state of the wire controller
1	1	if the controller power on, the indoor unit run according to the state on the controller; if the controller power off, the indoor unit run in the auto mode
1	0	Ignore the state on the controller and power off
0	0	Ignore the state on the controller and power off
0	1	The controller is able to be controlled

W : WHITE
 B : BLACK
 R : RED
 BR : BROWN
 Y/G: YELLOW/GREEN

1-CLOSE 0-OPEN

9.4.2. 0010451213 PCB Photo

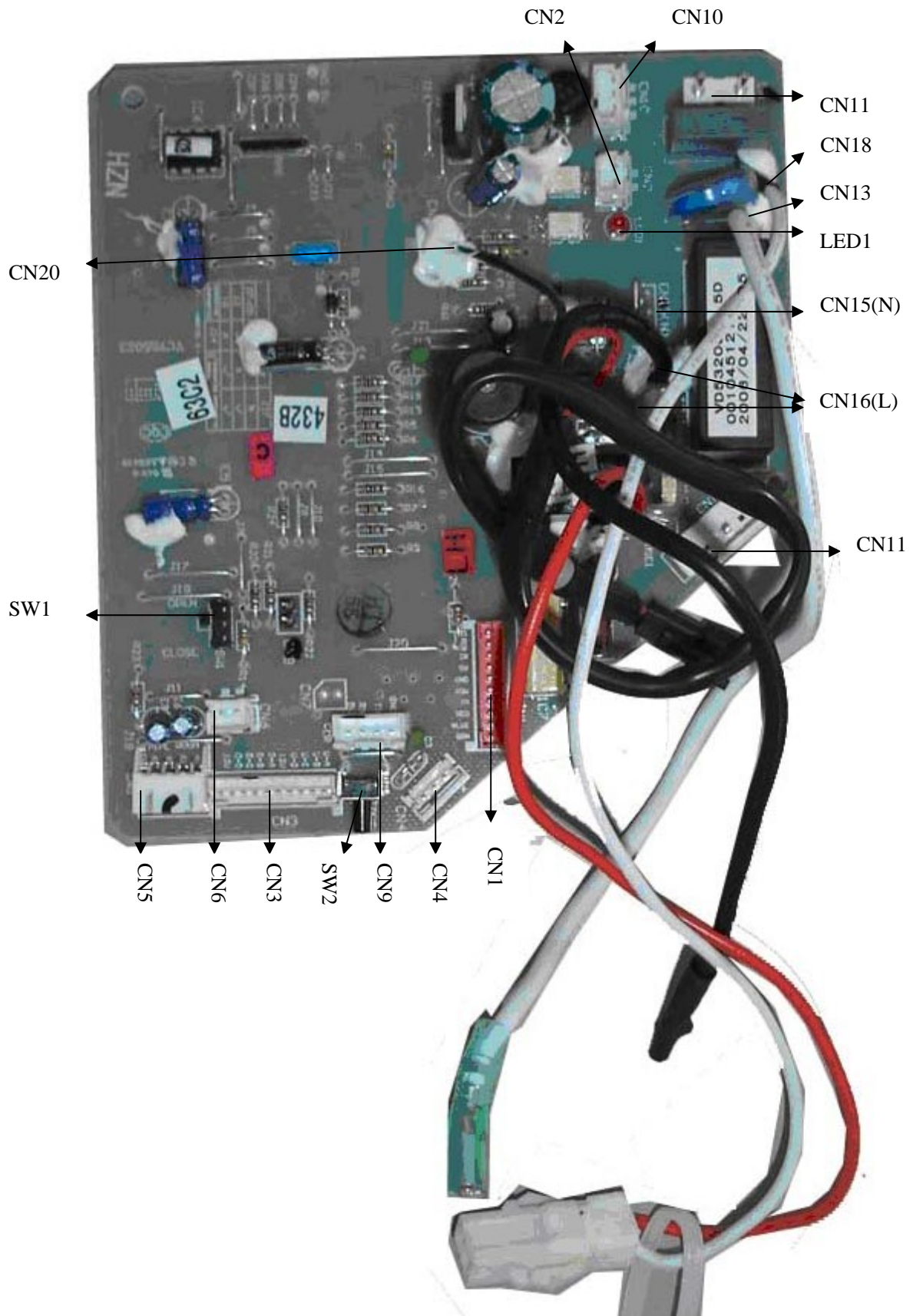

Notice: Wall mounted AS type diagnostic code is same with console type AF.

9.5.1. Wiring Diagram

Outdoor unit: AU282XHEAA, AU422XIEAA

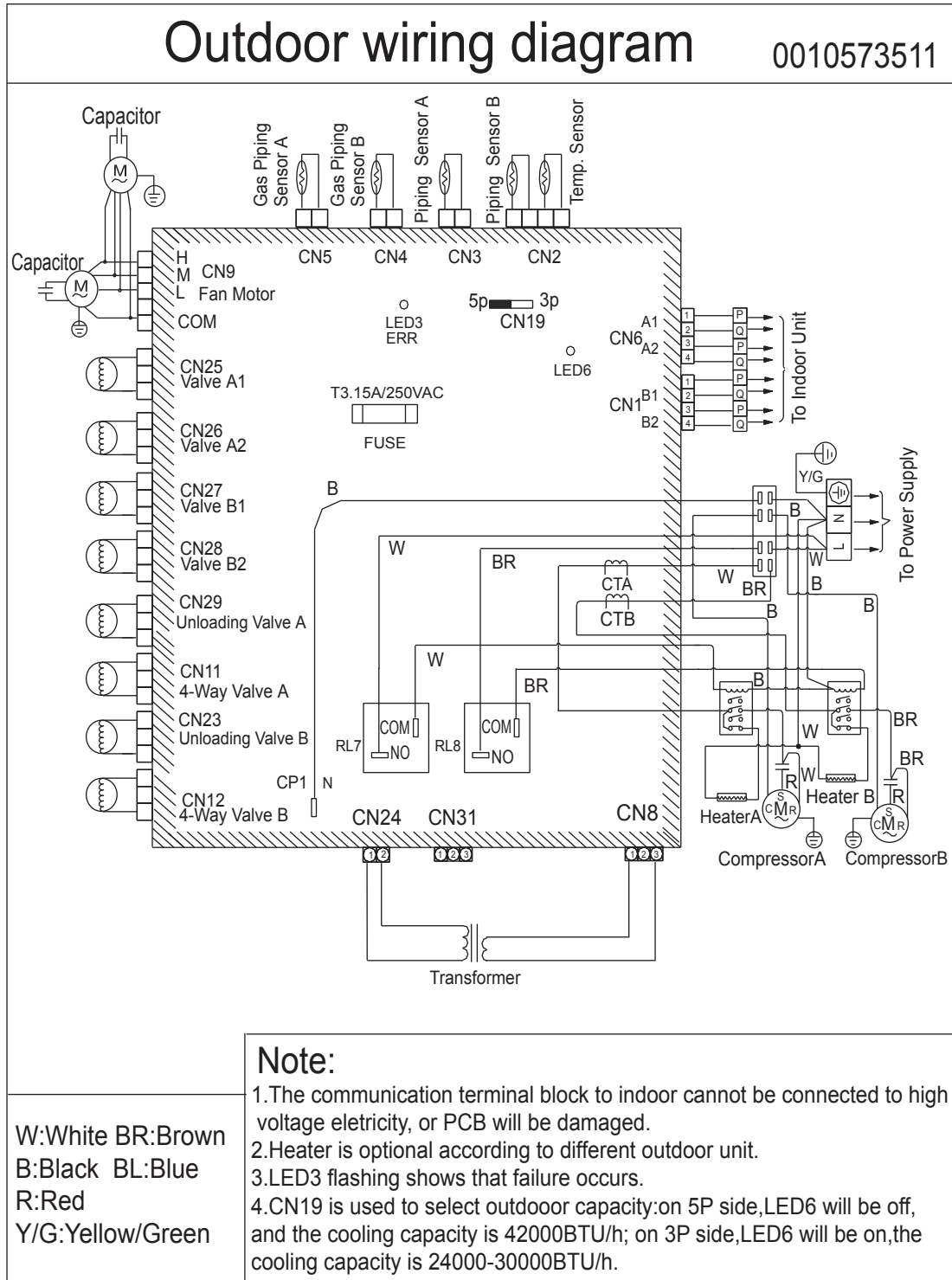

9.5.2. AU282XHEAA and AU422XIEAA PCB Photo 0010451214E

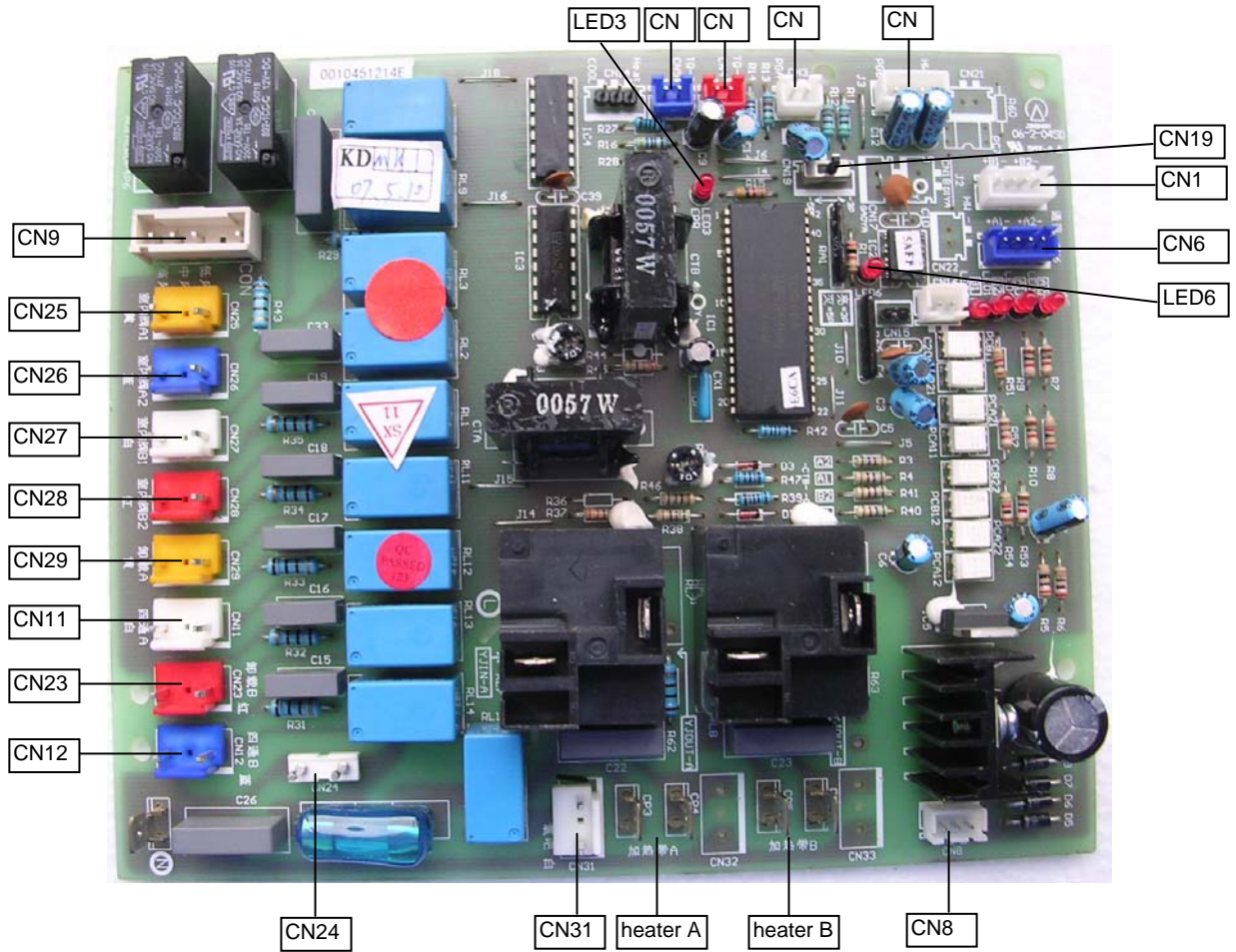

9.5.3. Electric control function (For outdoor unit)

A. Indoor unit

A.1 Cooling operation

A.1.1 Anti-freezed function of evaporator

- Be valid in cooling or defrost mode; be invalid in trial or heating mode.
- If the evaporator temperature is below -1°C for 5 minutes, outdoor fan and compressor will stop; if the evaporator temperature goes up to over 7°C and the compressor has stopped for over 3 minutes, the unit will resume.
- When the evaporator anti-freezed function works, the indoor motor and the thermostat will work together.
- Compressor control

Being powered on for the first time is without the 3-minutes protection. If the compressor stops, it can start up 3 minutes later.

e. Remote controller control

The adjustment of set temperature and the remote controller shutoff will not be limited by 6-minute control, you can shut off the unit right now.

A.1.2 Dehumidification operation

***temperature range:** $16\sim 30^{\circ}\text{C}$

***temperature control precision:** $\pm 1^{\circ}\text{C}$

***Control characteristic:** T_r =room temperature; T_s =set temperature

- $T_r > T_s + 2^{\circ}\text{C}$, the compressor and the outdoor motor will go on running, the indoor motor will run at the set speed.
- $T < T_r < T_s + 2^{\circ}\text{C}$, the compressor and the outdoor motor will run for 10 minutes and then stop for 6 minutes; the indoor motor will stop within 3 minutes after compressor stops, in the other time, it is at low speed.
- $\text{In the cross section, there is tolerance of } \pm 1^{\circ}\text{C}.$

***Against the current impulse:** outdoor motor will run 2 seconds later after compressor starts up.

*Flap position control:

Set the swing flap position due to the actual requirement, press "SWING" to stop swing; press again, flap can swing freely. Powered on for the first time, the flap will not swing.

*Ice-proof protection(invalid for trial and heating mode):

Avoid the evaporator being iced in cooling or dehumidification mode. When compressor runs for over 5 minutes and indoor coil temperature is not more than -1°C , the compressor will stop. When indoor coil temperature goes up to over 10°C , and the compressor has stopped for over 9 minutes, the compressor will re-start up.

*TIMER ON/OFF function

*SLEEP function

A.1.3 Heating operation

The compensation temperature: 4.67°C

Control tolerance: $\pm 1^{\circ}\text{C}$

***Temperature control range:** $16\sim 30^{\circ}\text{C}$

***Temperature control precision:** $\pm 1^{\circ}\text{C}$

*Control characteristic:

When $T_r \leq T_s$ for the first time, the compressor, 4-way valve and outdoor motor will run; indoor motor will run at anti-cold air mode, after the compressor starts up, the

Compensation of 5 degree will be valid

When $T_r > T_s + 4^\circ\text{C}$, the compressor and outdoor motor will be OFF, indoor motor will run at anti-cold air mode.

When $T_r < T_s + 4^\circ\text{C}$, the compressor, 4-way valve and outdoor motor will run; indoor motor will run at anti-cold air mode.

***Control of indoor motor:**

Manual control: set High/Med/Low/Auto speed due to the actual request.

***Flap position control:**

Set the swing flap position due to the actual requirement, press "SWING" to stop swing; press again, flap can swing freely. Powered on for the first time, the flap will not swing, instead, flap will reset. If the reset distance is more than the max. swing distance, the air sending will stop, but the flap swing will not stop.

*** Compressor control**

Being powered on for the first time is without the 3-minutes protection. If the compressor stops, it can start up 3 minutes later.

*** Remote controller control**

The adjustment of set temperature and the remote controller shutoff will not be limited by 8-minute control, you can shut off the unit right now.

***TIMER ON/OFF function**

***SLEEP function**

***Anti-cold air operation:**

a. On compressor running or compressor running after defrosting, if the indoor evaporator temperature is below 32°C , the indoor motor will stop; if indoor evaporator temperature is over 32°C , indoor motor runs at low speed.

b. If indoor coil temperature can not be over 38°C within 4 minutes, the fan motor will run at set speed.

c. If indoor coil temperature is over 38°C within 4 minutes, the fan motor will run at set speed (for cassette unit, ceiling concealed unit, and AS**XAEAA).

d. If the unit stops when it arrives the set temperature, indoor motor will blow air for 50 seconds and then stop.

e. After indoor motor starts up, it will not stop because the coil temperature decreases.

f. Sensor OFF

When the compressor changes from running to stop, fan motor will stop.

g. Remote controller shuts off the unit, and indoor fan motor will stop.

***High temperature protection and high temperature cutoff protection:**

a. High temperature protection: When indoor coil temperature is over 60°C , outdoor motor stops; when indoor coil temperature reduces to 54°C , outdoor motor will re-start up, fan speed changing frequency is over 45 seconds.

b. High temperature cutoff protection: When indoor coil temperature is over 68°C , 10 seconds later, outdoor motor will stop, and indoor motor will run as the sensor is off. After the compressor is standby for 3 minutes and when the coil temperature is below 60°C , the unit will start up.

9.5.4. Electric functions of outdoor

A.1 Control of the compressor, outdoor motor and 4-way valve

A.1.1 Outdoor fan motor control

A. When system do not have overheating or over current protection, outdoor fan speed will vary with outdoor ambient temperature, as follows:

a. in cooling mode

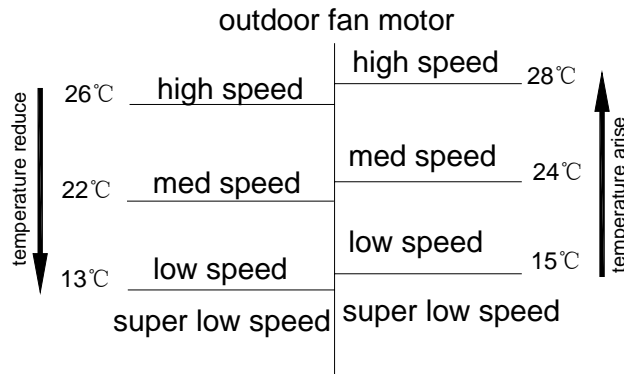

b. in heating mode (heat pump unit)

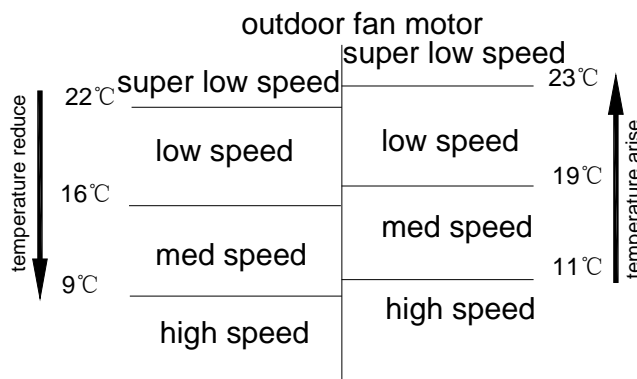

B. When fan speed changes, if it is from Low speed to High speed, there is no time delay; if it is from High speed to Low speed, there is 45-second delay.

C. In cooling mode, in one minute before the compressor begins to run, the outdoor motor will be switched on to run.

D. Super low speed control: outdoor motor will be off for 1 minute at the interval of 45 seconds.

A.1.2 Compressor control

After receiving the “compressor ON” signal sent from indoor unit, the compressor will run. Its running-stop interval is 3 minutes. Being powered on firstly is without 3-minute delay.

If the two systems receive the “compressor ON” signal simultaneously, they will start up in turn, and the interval is 20 seconds.

A.1.3 4-way valve control

A. In cooling or dehumidification mode, 4-way valve is not electrified.

B. When receiving the “heating” and “compressor ON” signal from indoor unit, 4-way valve and compressor will start up simultaneously.

C. In 3 minutes after heating is over, it will be shut off 2 minutes and 50 seconds later. In 3-minute standby period, at 2-minute and 50-second clock, it is electrified.

D. Changing from cooling mode to heating mode, 3 minutes later, it is electrified.

Changing from heating mode to cooling mode , 3 minutes later, it is shut off.

- E. In heating mode, when indoor temperature has arrived the set one (sensor is OFF), 4-way valve will be shut off 3 minutes later.

A.1.4 Solenoid valve control

Cooling mode: After the outdoor unit receives the Startup signal from indoor unit, the corresponding solenoid valve will open 10 seconds earlier than compressor startup.

Heating mode: After the outdoor unit receives the Startup signal from indoor unit, all the solenoid valve of the corresponding system will open 10 seconds earlier than compressor startup.

After the compressor shuts off, the solenoid valves will close 3 minutes later.

A.1.5 Unloading valve control

When only one indoor unit of one system starts up, the solenoid valve will open.

When receiving the overheating signal from indoor unit, solenoid valve will open.

If one system only connects one indoor unit (single type), solenoid valve will open.

If two indoor units of one system are running, and outdoor ambient temperature is no more than -2 degree, the solenoid valve will open.

Priority of operation modes:

All indoor units are running in the same mode:

- 1) Operate as "prior to the earlier entering", the outdoor will adjust if there is non-matching type and inform of indoor units which is entering later.
- 2) When there is non-matching, the indoor unit entering later will act: the indoor buzzer sounds two times, and then the indoor unit is in standby state.
- 3) Method to eliminate the non-matching type
 - a) The operation mode of indoor unit entering later changes to the same mode of the one earlier.
 - b) The operation mode of indoor unit entering later changes to FAN mode.
 - c) The operation mode of indoor unit entering earlier stops or changes the mode.
 - d) The operation mode of indoor unit entering later stops.

A.2 Protection functions

Protection functions of the system can be controlled individually.

A.2.1 Overheating protection

If the units of the two systems are all operating, when the four indoor units all reach the stop-motor point of the overheating protection, outdoor motor can stop. Outdoor motor has not the control point of High/Med/Low speed. If one indoor unit reaches the stop-compressor point of overheating protection, the corresponding compressor will stop, but the outdoor motor and the other system will work normally. If the two systems all arrives at the stop-compressor point of overheating protection, the outdoor unit stops; at this time, if one system resumes, the outdoor motor and the system will work normally, the compressor not resuming will stop.

A.2 3-minute protection when compressor starts up

If the compressor stops running, it must 3 minutes later that it can re-start up; if the unit is powered off during operation within 3 minutes, after being powered on, 3 minutes later, the compressor can start up again.

A.2.3 Communication abnormal between indoor and outdoor

Within 4 minutes after outdoor unit is powered on, it cannot communicate with indoor unit, or in the course of communication, it cannot communicate with indoor unit for 4 minutes

continuously, then the outdoor stops running, and shows failure code. After the communication resumes normal operation and cancel the failure

When all indoor units can not communicate normally, it shows communication malfunction.

A.2.4 Solenoid valve control with single unit in cooling mode

If indoor unit sends the “start-compressor” signal, the corresponding solenoid valve will open; when shutting off the compressor, the corresponding solenoid valve will close. If the indoor units in one system all send the “stop-compressor” signal, the solenoid valve last receiving signal will close 3 minutes later.

A.2.5 Solenoid valve control with single unit in heating mode

If indoor unit sends the “start-compressor” signal, the corresponding two solenoid valves will open; if there is only one indoor unit, the two valves will open too.

A.2.6 When double units of one system are in cooling mode, if the two indoor units send the “start-compressor” signal, the two solenoid valves will open; if one indoor sends “start-compressor” signal, while the other sends “stop-compressor”, then the solenoid valve will open or close respectively. If the two units all send “stop-compressor” signal, the solenoid valve will open for 3 minutes after compressor stops.

A.2.7 When double units of different system are in cooling mode, if the indoor unit sends the “start-compressor” signal, the corresponding solenoid valves will open; If the unit sends “stop-compressor” signal, the corresponding solenoid valve will open for 3 minutes after compressor stops.

A.2.8 When double units of one system are in heating mode, if any of the two indoor units sends the “start-compressor” signal, the two solenoid valves will open. After compressor stops, the solenoid valve will close 3 minutes later.

A.2.9 When double units of different system are in heating mode, if one indoor unit of one system sends the “start-compressor” signal, the two solenoid valves of this system will open. After compressor stops, the solenoid valve will close 3 minutes later.

A.2.10 The treatment for 1 to 3 or 1 to 4 refers to the different combination of the above 1-7 items.

A.2.11 Treatment for anti-freezed function

When the two systems are in operation, if one system enters anti-freezed function, the compressor of this system will stop, while the outdoor motor and the other system will work normally. If the two systems all enter anti-freezed function, outdoor unit will stop operation, at this moment if one system resumes, outdoor motor and the corresponding system will work normally. The compressor of the system which does not resumes will stop.

A.2.12 Treatment for overheating function

The treatment of stop-compressor status is identical to that of anti-freezed status. If one system enters overheating 3, this system will stop, while the outdoor motor and the other system will work normally. If the two systems enter overheating 3, the outdoor will stop; at this moment if one system resumes, outdoor motor and the corresponding system will work normally. If the indoor units of the two systems all enter the overheating 2, outdoor motor will stop. The outdoor will not deal with the status of overheating 1.

Note: The overheating point is decided by the indoor unit.

Diagnostic code for outdoor unit

(1) The PCB 0010451214 and 0010451848 for FREE-MULTI outdoor unit run the same procedure.

Outdoor lamp flash times	Failure description
1	Discharge pipe A overheat
2	Outdoor coil temp. sensor A failure
3	Outdoor ambient temp. sensor failure
4	Discharge sensor A failure
5	Outdoor coil (suction) temp. sensor B failure
6	Discharge sensor B failure
7	Discharge pipe B overheat
9	Low pressure abnormal
10	Communication error between indoor and outdoor units
11	Over-current protection
13	High pressure abnormal
15	EEPROM failure

10. Trouble shooting:

1 communication error

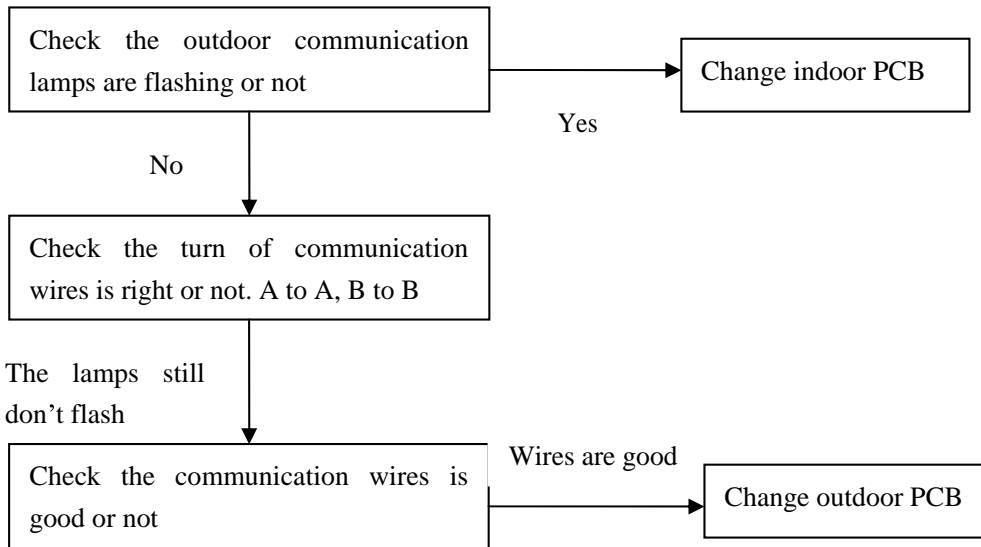

2 sensor error

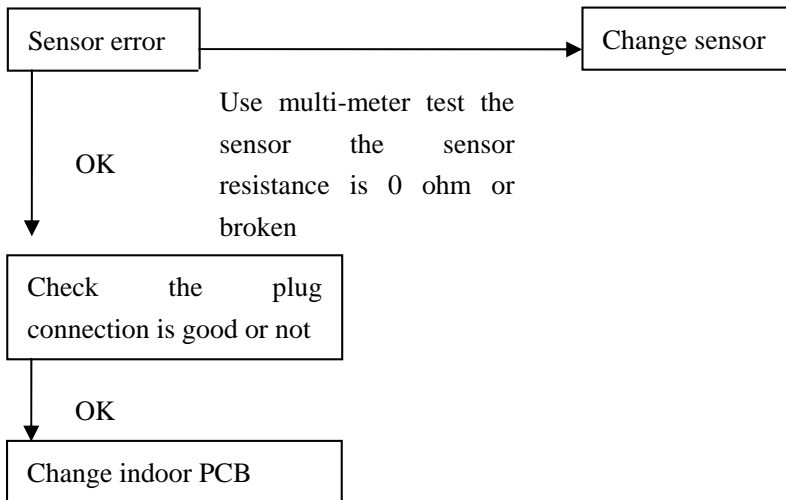

3 Pressure protection

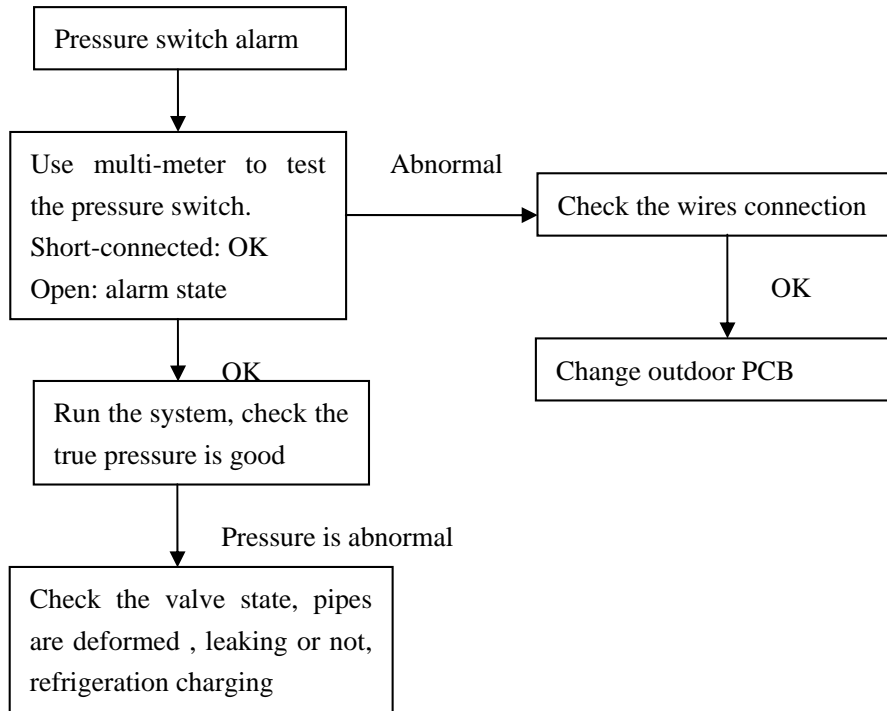

4 discharge temperature is over-high

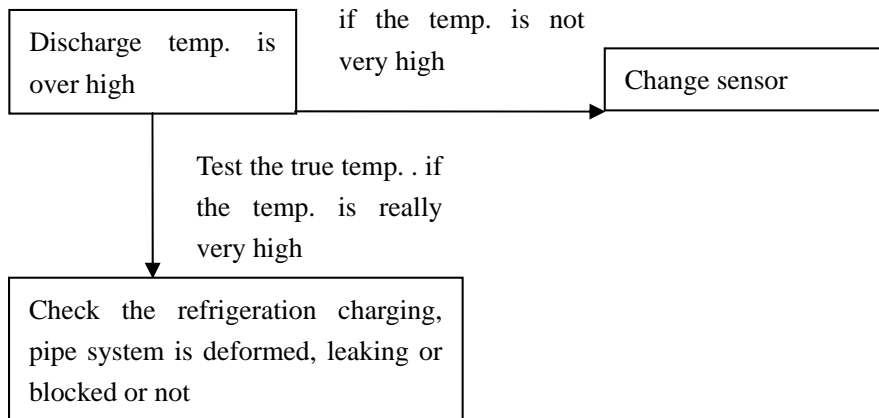

5 compressor doesn't run

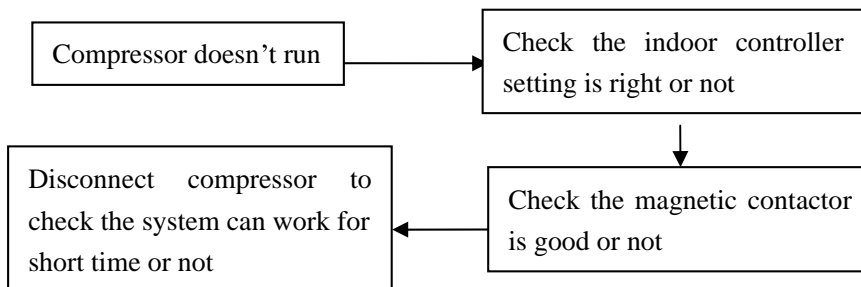

11. Outdoor performance curves

AU282XHEAA:

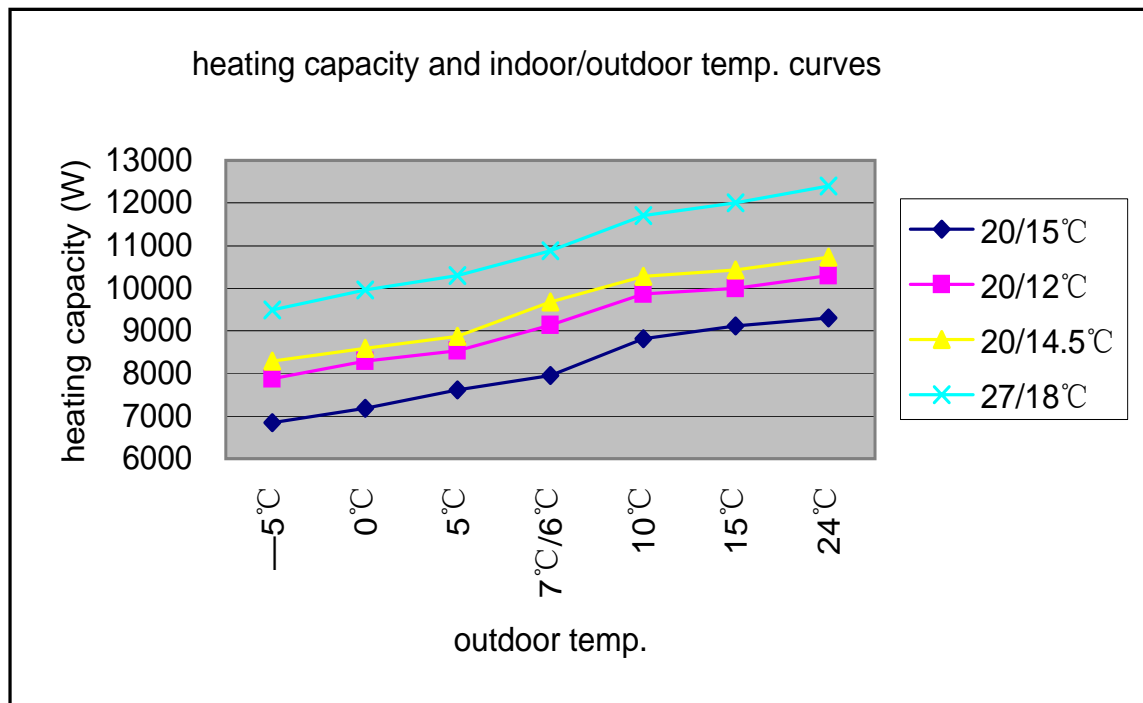
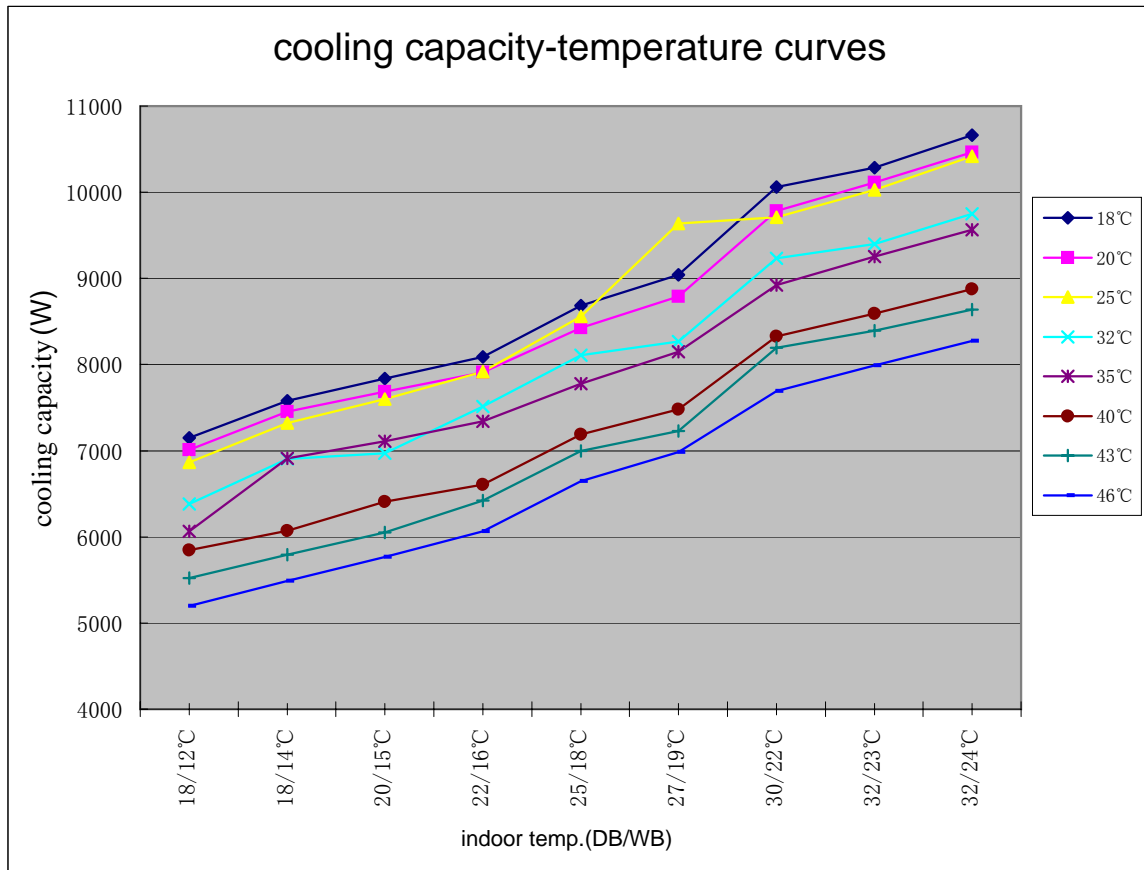

AU422XIEAA:

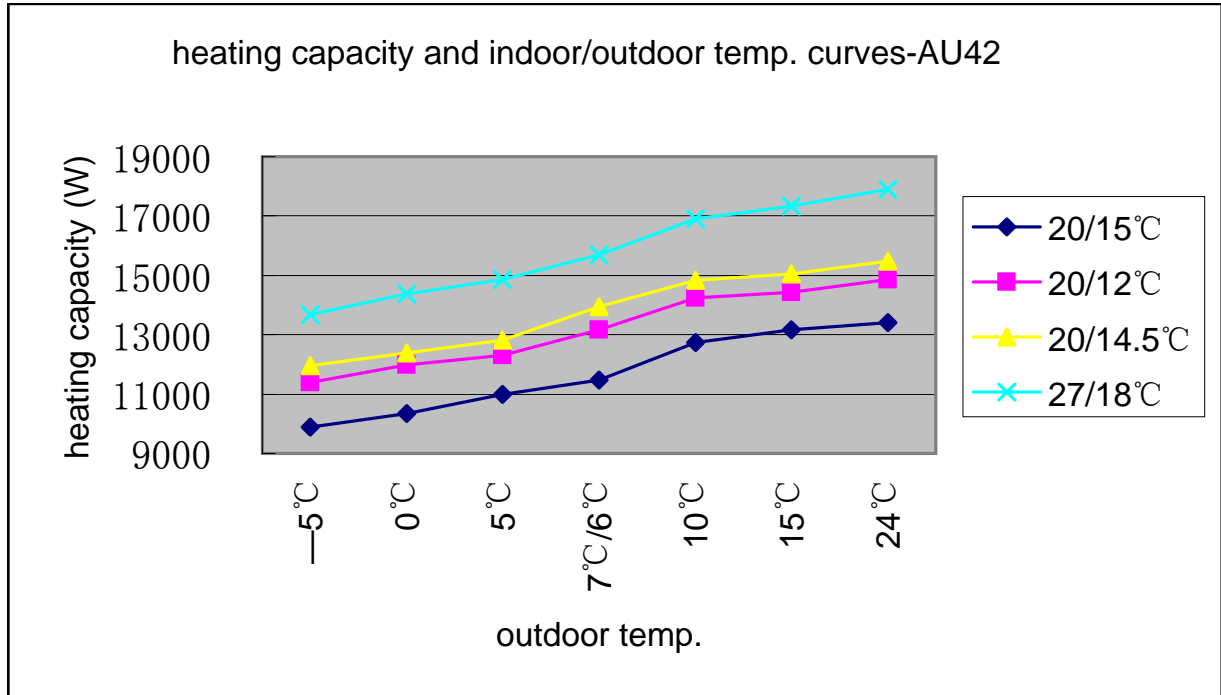
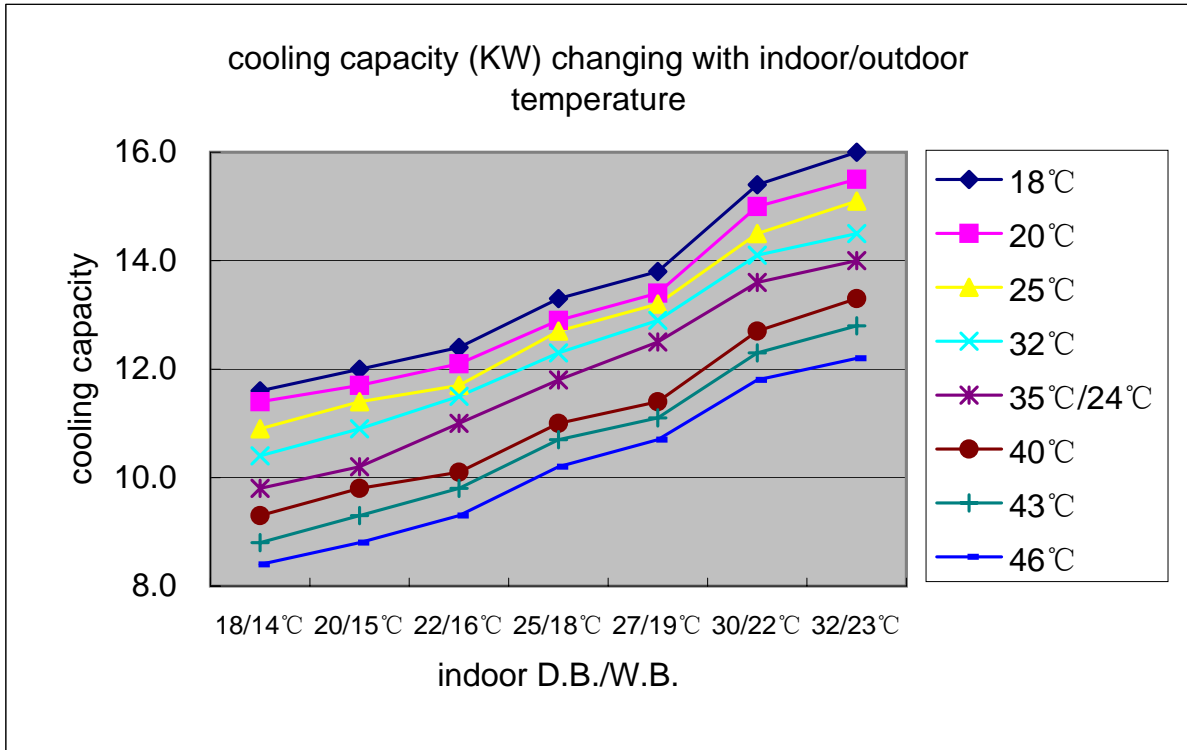

12. Indoor air velocity and temperature distribution curves

12.1 AB072-142XCEAA:

a. Cooling / Air Velocity Distribution

Cooling

Blow angle:40

Air Velocity Distribution

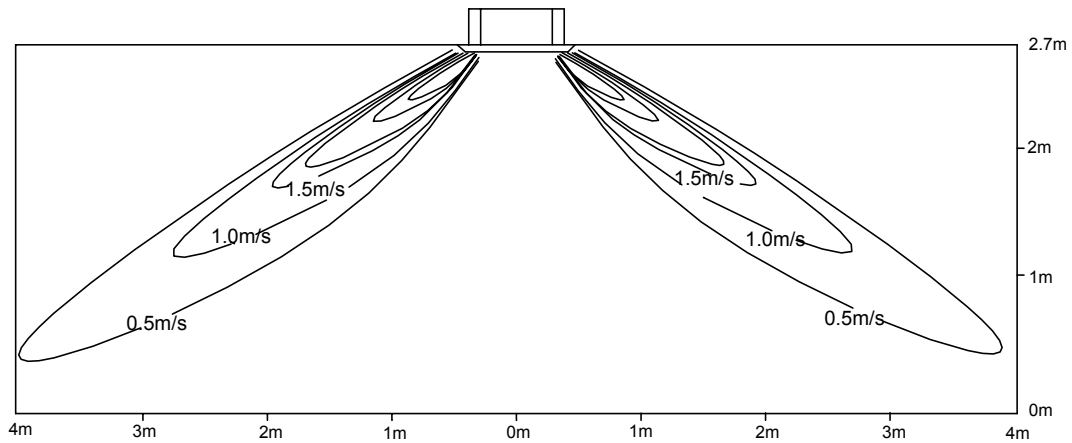

b. Cooling / Temperature Distribution

Cooling

Blow angle:40

Temperature Distribution

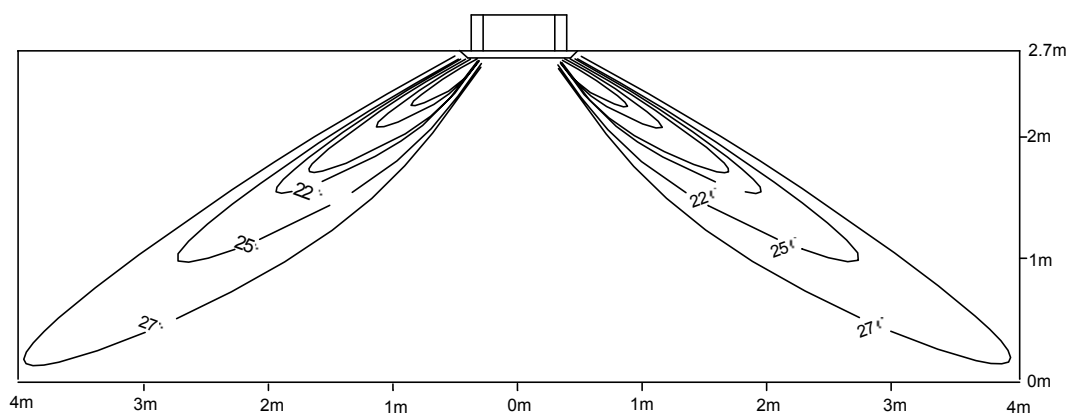

c. Heating / Air Velocity Distribution

Heating

Blow angle:70

Air velocity Distribution

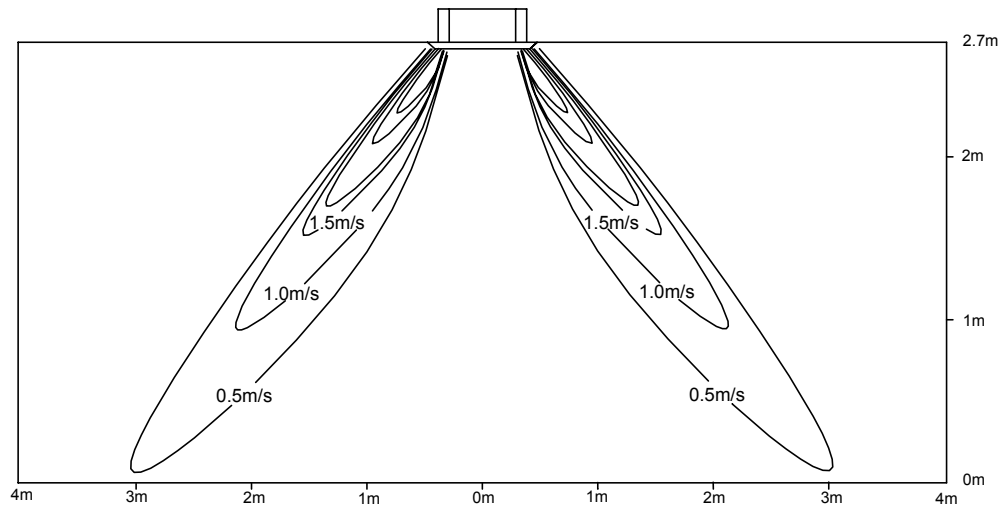

d. Heating / Temperature Distribution

Heating

Blow angle:70

Temperature Distribution

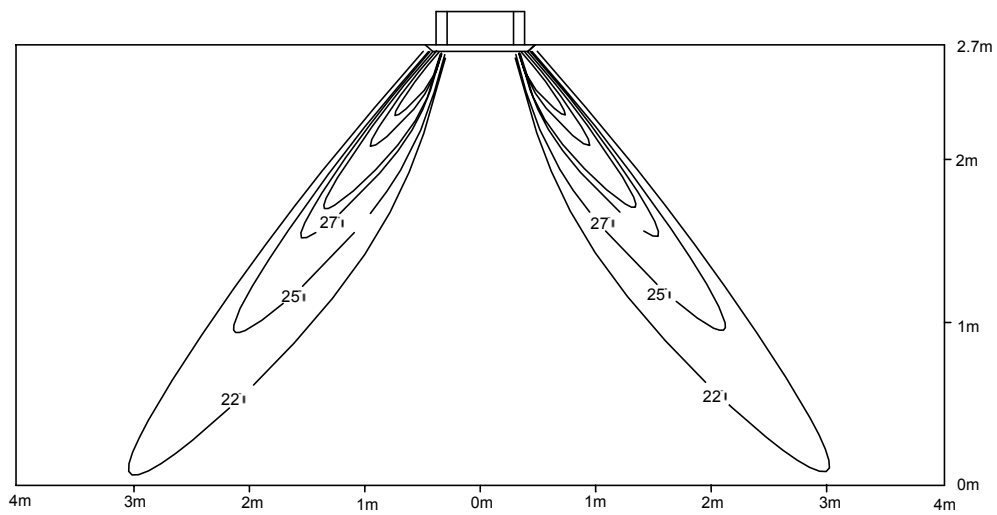

12.2 AB212XCEAA

a. Cooling / Air Velocity Distribution

Cooling

Blow angle:40

Air Velocity Distribution

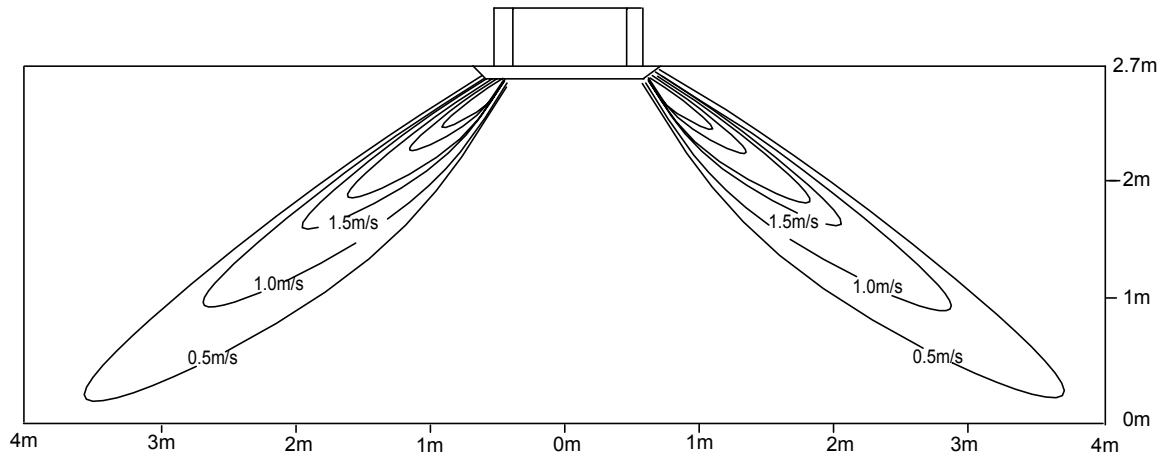

b. Cooling / Temperature Distribution

Cooling

Blow angle:40

Temperature Distribution

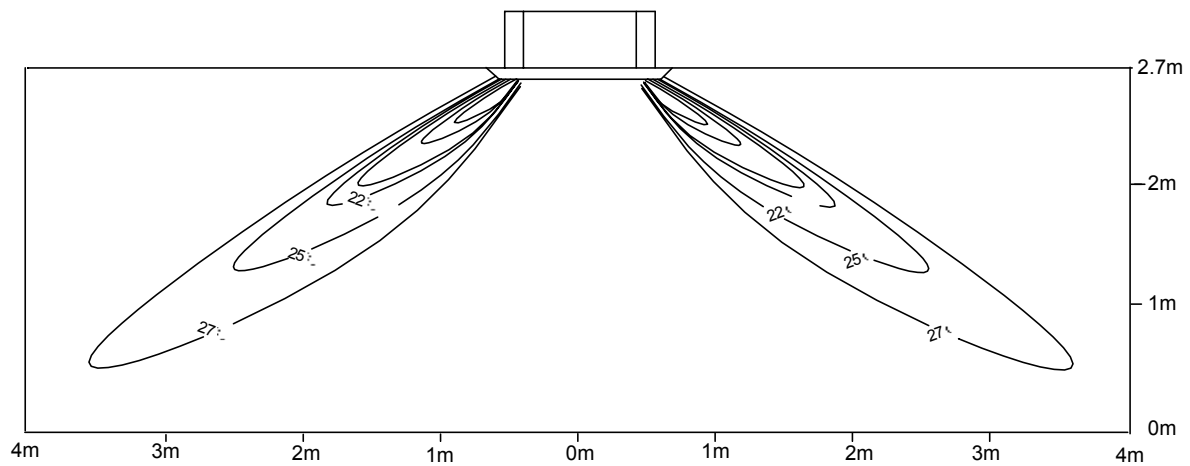

c. Heating / Air Velocity Distribution

Heating

Blow angle: 70°

Air velocity Distribution

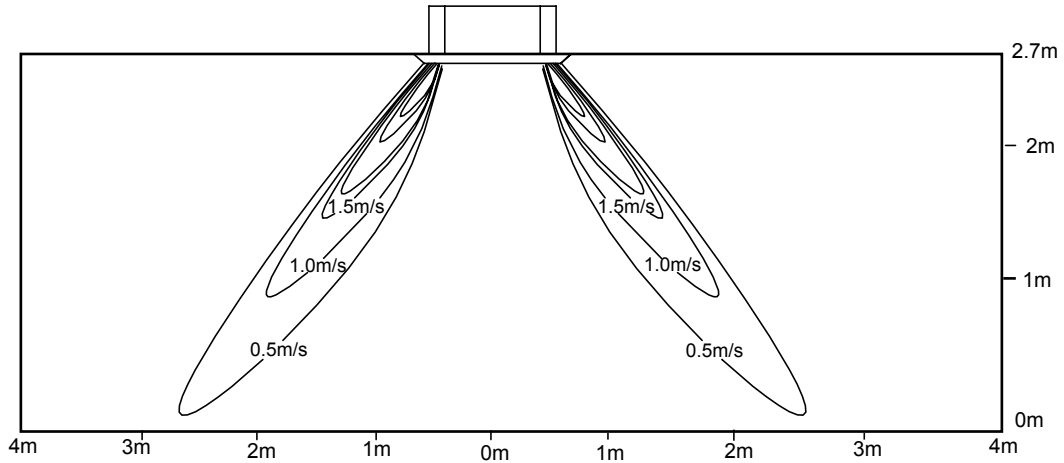

d. Heating / Temperature Distribution

Heating

Blow angle: 70°

Temperature Distribution

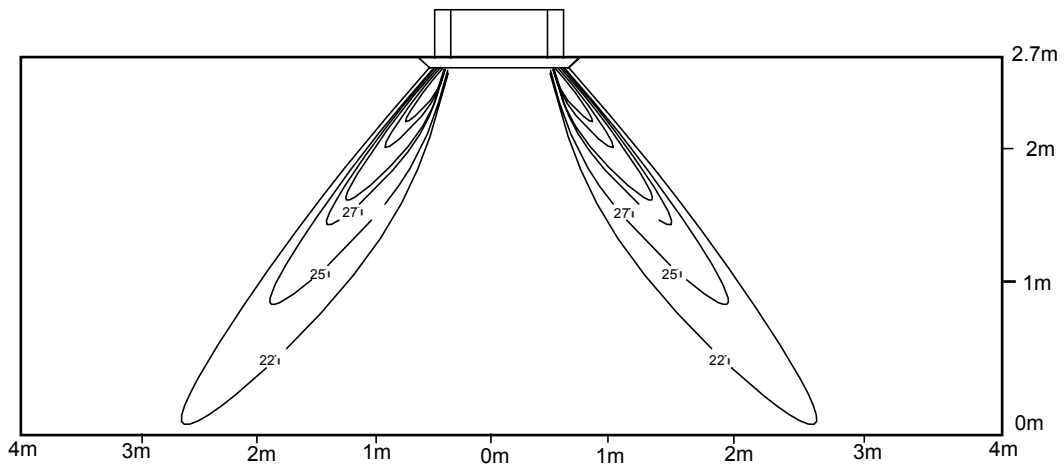

12.3 AF09/122XCEAA:

a. Cooling / Air Velocity Distribution

Cooling

Blow angle:25

Air Velocity Distribution

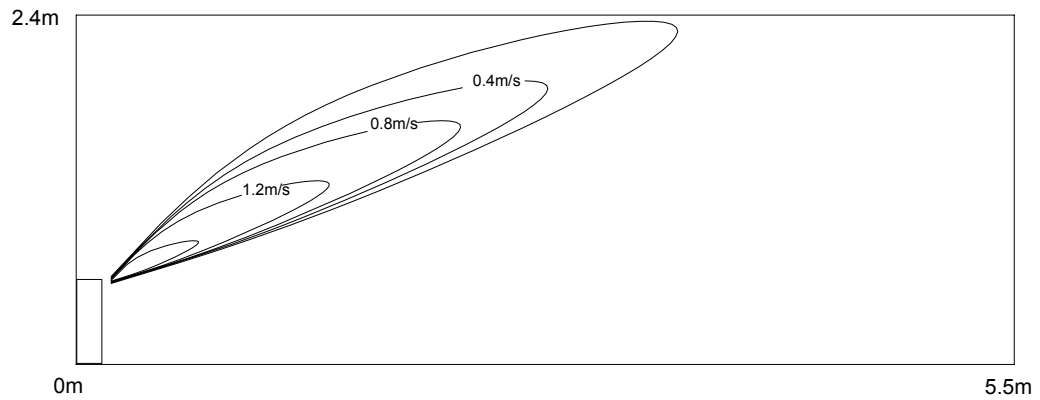

b. Cooling / Temperature Distribution

Cooling

Blow angle:25

Temperature Distribution

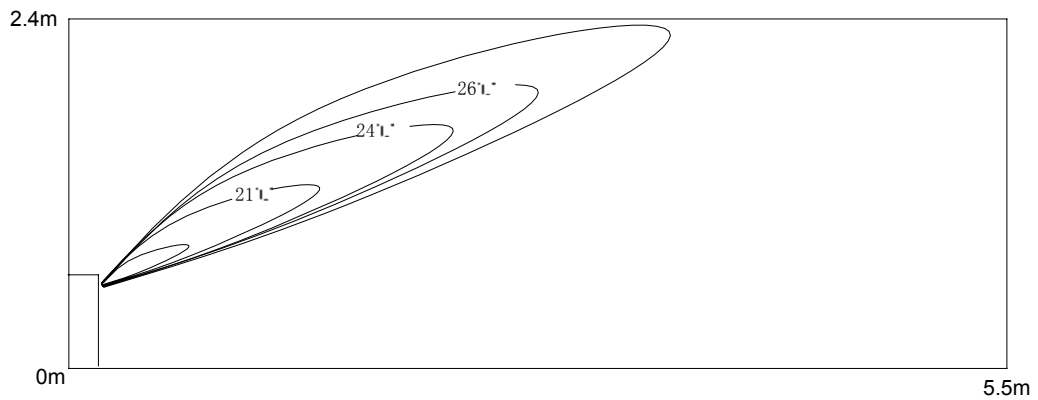

c. Heating / Air Velocity Distribution

Heating

Blow angle:5

Air velocity Distribution

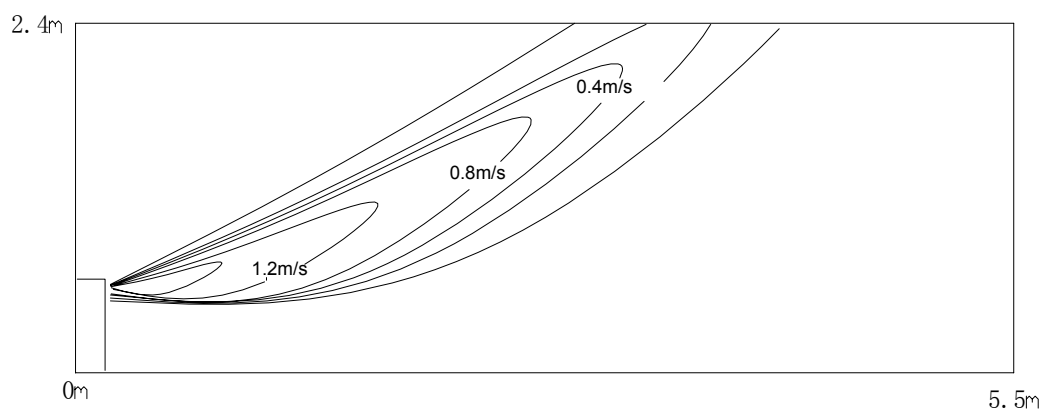

d. Heating / Temperature Distribution

Heating

Blow angle:5

Temperature Distribution

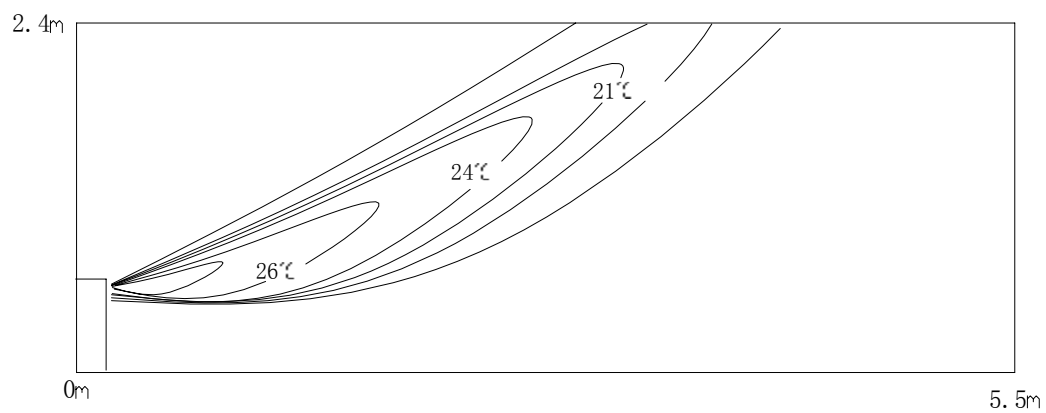

12.4 Wall mounted type:

Fig 1
top view
flow control panel horizontal
louer:center

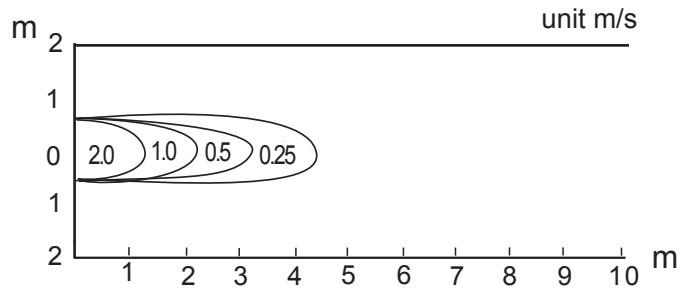

Fig 2
top view
flow control panel horizontal
louer:right and left

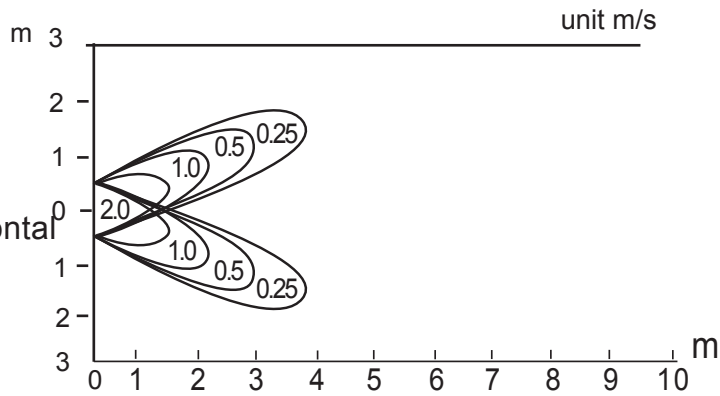

Fig 3
top view
flow control panel horizontal
louer:center

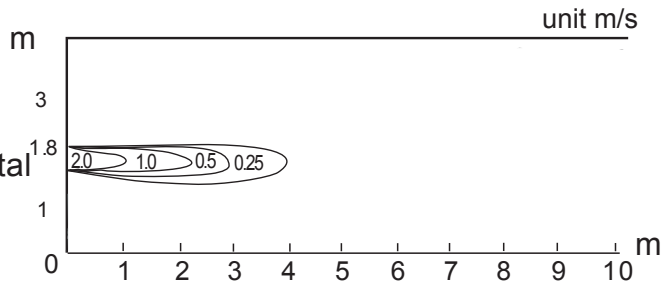
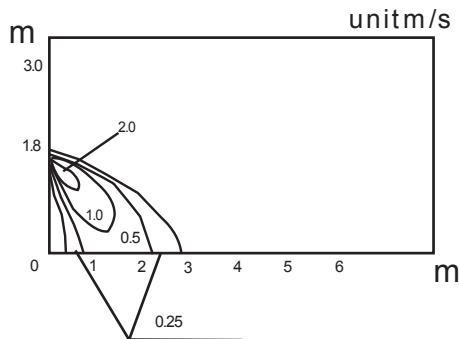

Fig 4
top view
flow control panel vertical
louer:center



Condition
Fan speed:high
Operation mode:fan
Voltage:230V,50Hz

13. Air flow and static pressure chart

AD072,092XLEAA:

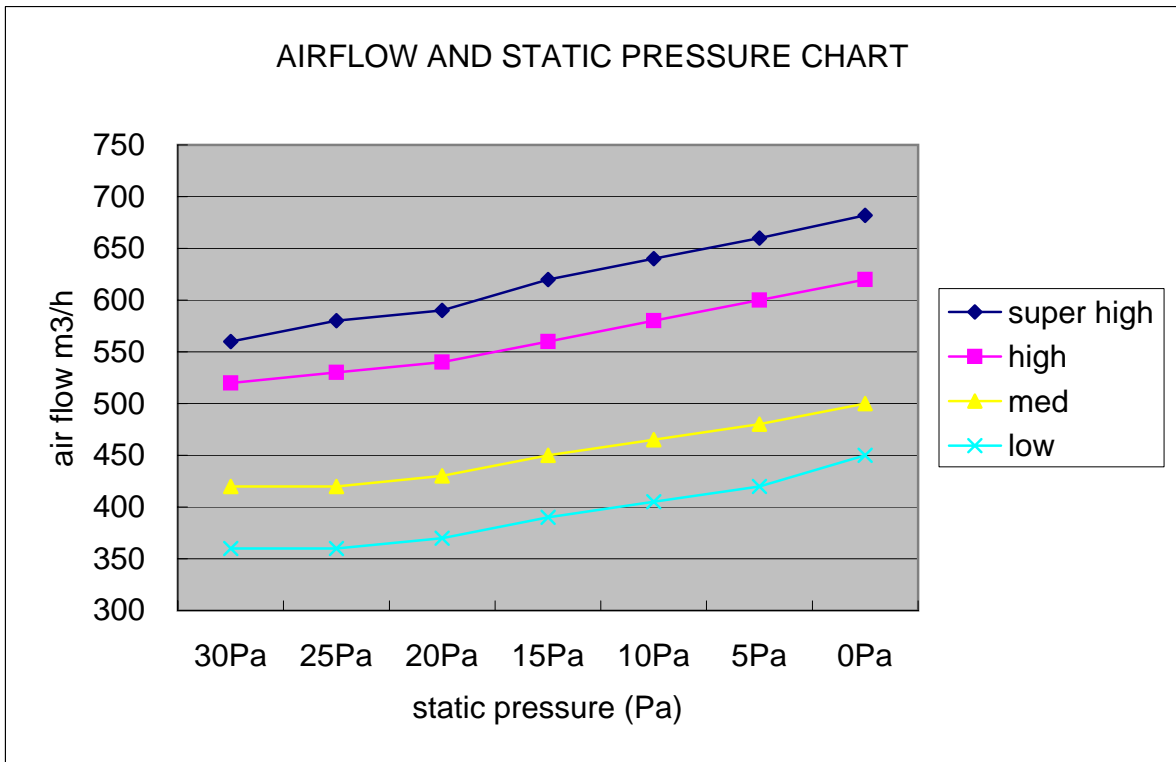

AD122,142XLEAA:

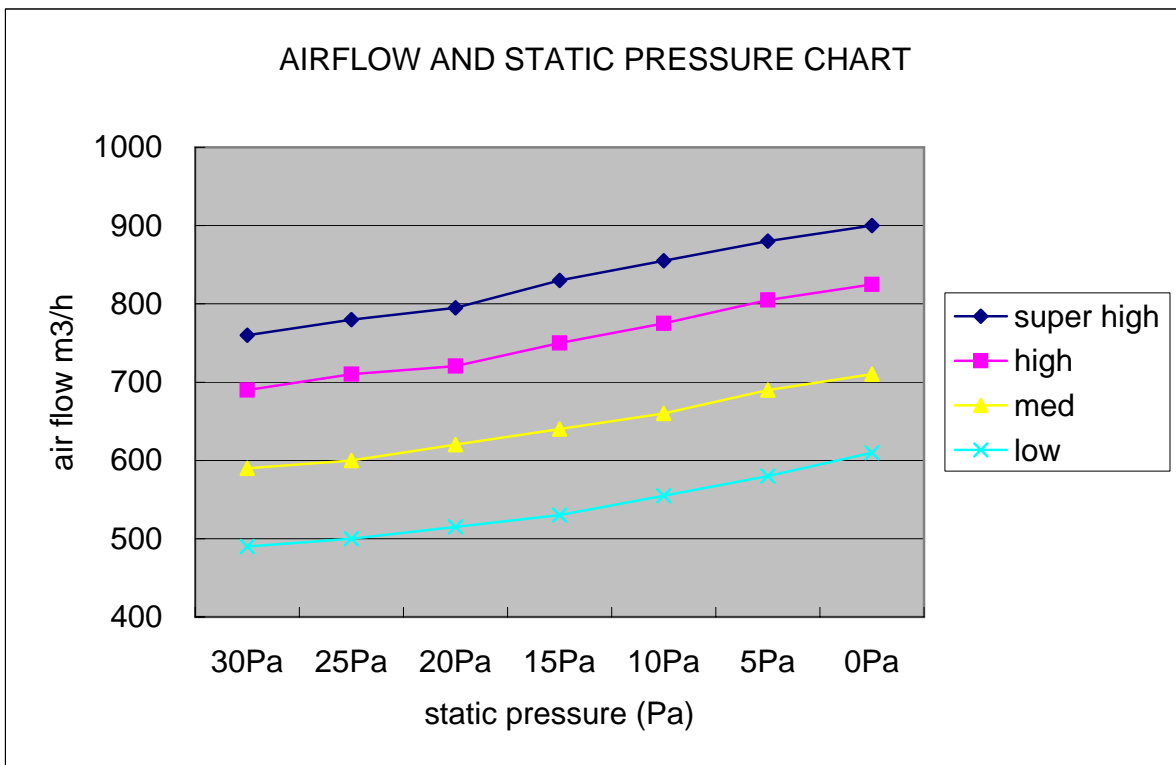

AD212XLEAA

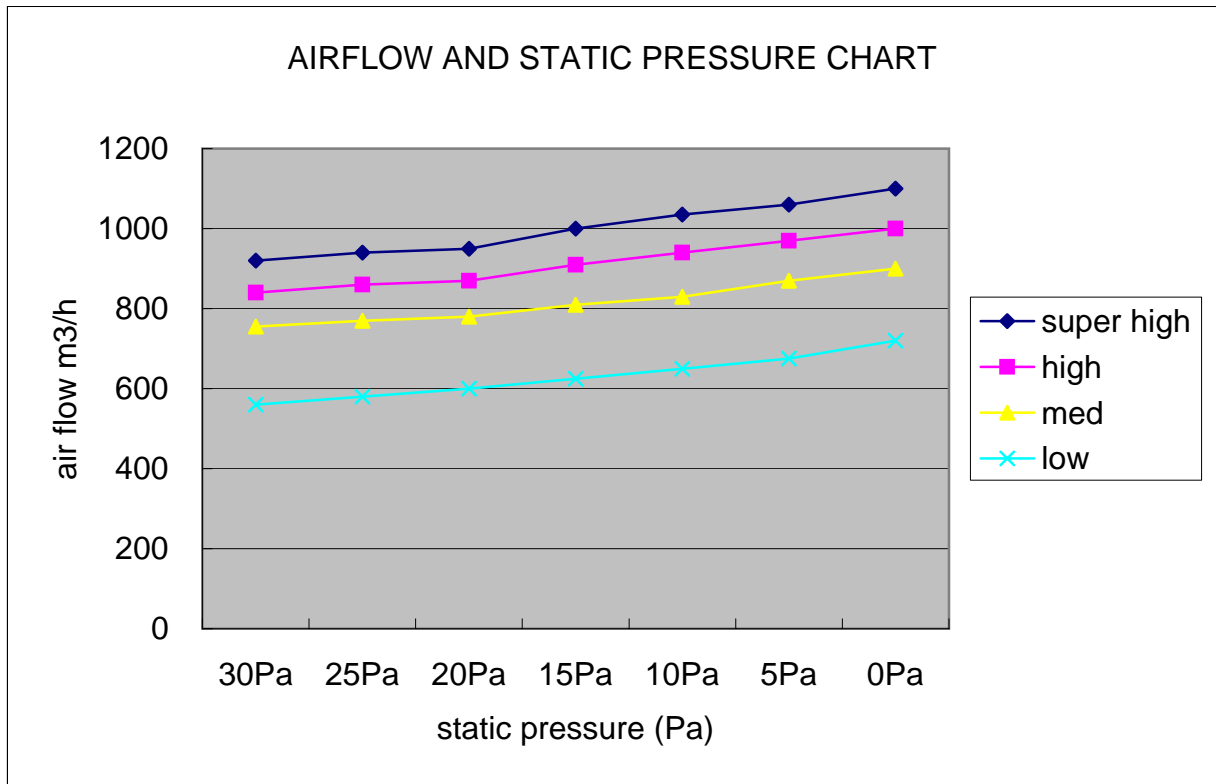

Free Manuals Download Website

<http://myh66.com>

<http://usermanuals.us>

<http://www.somanuals.com>

<http://www.4manuals.cc>

<http://www.manual-lib.com>

<http://www.404manual.com>

<http://www.luxmanual.com>

<http://aubethermostatmanual.com>

Golf course search by state

<http://golfingnear.com>

Email search by domain

<http://emailbydomain.com>

Auto manuals search

<http://auto.somanuals.com>

TV manuals search

<http://tv.somanuals.com>