

## SPLIT TYPE ROOM AIR CONDITIONER OPERATION MANUAL



AS09FBBHRA

AS12FBBHRA

AS18FEBHRA

AS24FEBHRA

AS26FBBHRA

AS35FBBHRA

AS53FEBHRA

AS71FEBHRA

AS28FFAHRA

AS82FFAHRA

- Please read this operation manual before using the air conditioner.  
Keep this operation manual for future reference.



# Parts and Functions

## Indoor Unit

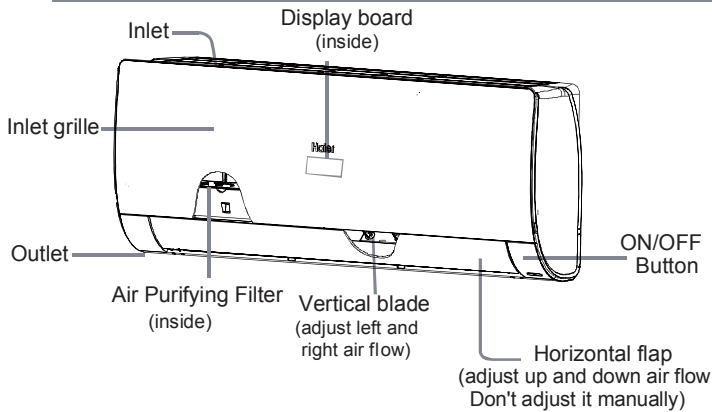

Actual inlet grille may vary from the one shown in the manual according to the product purchased

### Display board

- 1 Signal receiver hole
- 2 Ambient temp. display  
When receiving the remote control signal, display the set temperature.
- 3 Operation mode indicator
- 4 WIFI display

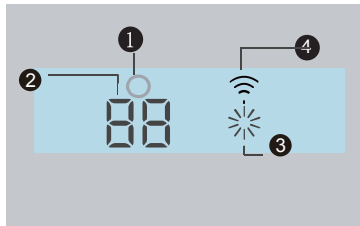

## Remote controller

### Outer side of the controller

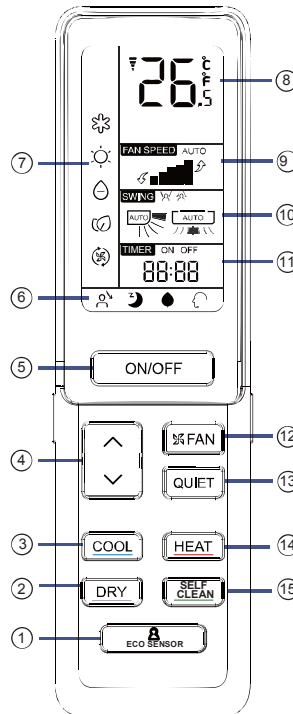

5. ON / OFF button
6. Display of each function status
7. Operation mode display
8. TEMP display
9. FAN SPEED display
10. SWING display  
Swing up/down display  
swing left/right display
11. TIMER ON display  
TIMER OFF display  
CLOCK display
12. FAN button
13. QUIET button
14. HEAT button
15. SELF CLEAN button

1. ECO SENSOR button
2. DRY button  
Used to set DRY operation.
3. COOL button  
Used to set COOL operation.
4. TEMP button  
used to change setting temperature

#### NOTE:

- a. Humidity display is unavailable on some models
- b. If the model you buy has a WIFI function, press the "ON/OFF" button for 5s to emit the WIFI binding signal. Once in the binding mode, the APP will show how to bind.

## Outdoor Unit

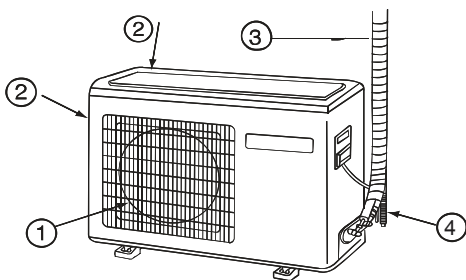

- 1 OUTLET
- 2 INLET
- 3 CONNECTING PIPING AND ELECTRICAL WIRING
- 4 DRAIN HOSE

# Operation

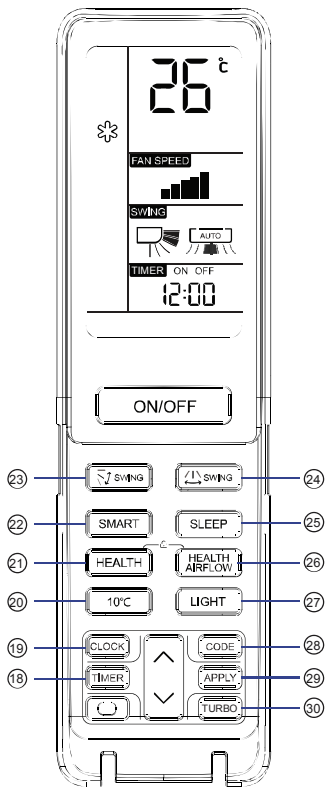

18. TIMER button
19. CLOCK button
20. 10 °C button  
special heating set function: 10 degree heating maintaining (valuable for RS)
21. HEALTH button
22. SMART button  
Used to set SMART operation. (This function is unavailable on some models.)
23. SWING up/down button
24. SWING left/right button
25. SLEEP button
26. HEALTH AIRFLOW button
27. LIGHT button  
Control the lightening and extinguishing of the indoor LED display board.
28. CODE button  
A-B yard
29. APPLY button
30. TURBO button

## Note:

Press "HEALTH"+"HEALTH AIRFLOW" simultaneously can set and cancel the "LOCK" function (  ).



## WiFi Setup

If your Air Conditioner (AC) has a Connected Appliance Information label located under the front cover as shown below, your AC is WiFi Connect Enabled. A WiFi communication card is built into the product allowing it to communicate with your smart phone for remote monitoring, control and notifications.

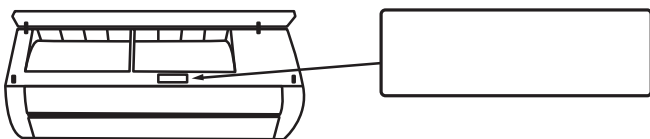
Please visit [www.haier.com.au/smart](http://www.haier.com.au/smart) or [www.haier.co.nz/smart](http://www.haier.co.nz/smart) to learn more about connected appliance features, and to learn what connected appliance apps will work with your smart phone.

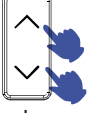

## Clock set

- 1 Press CLOCK button, 
- 2 Press "∧" or "∨" to set correct time.   
Each press will increase or decrease 1min. If the button is kept pressed, time will change quickly.
- 3 Confirm time.   
After time setting is confirmed, press APPLY, while clock starts working.

## Note:

The distance between the signal transmission head and the receiver hole should be within 7m without any obstacle as well. When electronic-started type fluorescent lamp or change-over wireless telephone is installed in the type fluorescent lamp or room, the receiver is apt to be disturbed in receiving the signals, so the distance to the indoor unit should be shorter.

Full display or unclear display during operation indicates the batteries have been used up. Please change batteries. If the remote controller can't run normally during operation, please remove the batteries and reload several minutes later

## Hint:

Remove the batteries in case unit won't be in usage for a long period.

## Dred operation

(This function is unavailable on some models.)

Haier Peaksmart enabled air-conditioners have a Demand Response Mode display on the indoor unit.

The display could be labelled d1, d2, d3 (wording may differ model to model).

These modes are described in more detail below:

Mode	Display	Description	What to do
DRM3	d3	Your air-conditioner will continue to cool or heat during the peak demand event. The energy consumed by your air-conditioner is capped to 75%.	No action is required.
DRM2	d2	Your air-conditioner will continue to cool or heat during the peak demand event. The energy consumed by your air-conditioner is capped to 50%.	No action is required.
DRM1	d1	Your air-conditioner is still turned on and the fan will continue to operate. Your compressor is turned off and cool/hot air will no longer be generated	DRM1 mode is only activated during emergency demand management situations. This mode will automatically reset the device within 2 hours. If your air-con is in this mode for longer than 2 hours please contact Energex on 13 12 53.

# Operation

## QUIET Operation

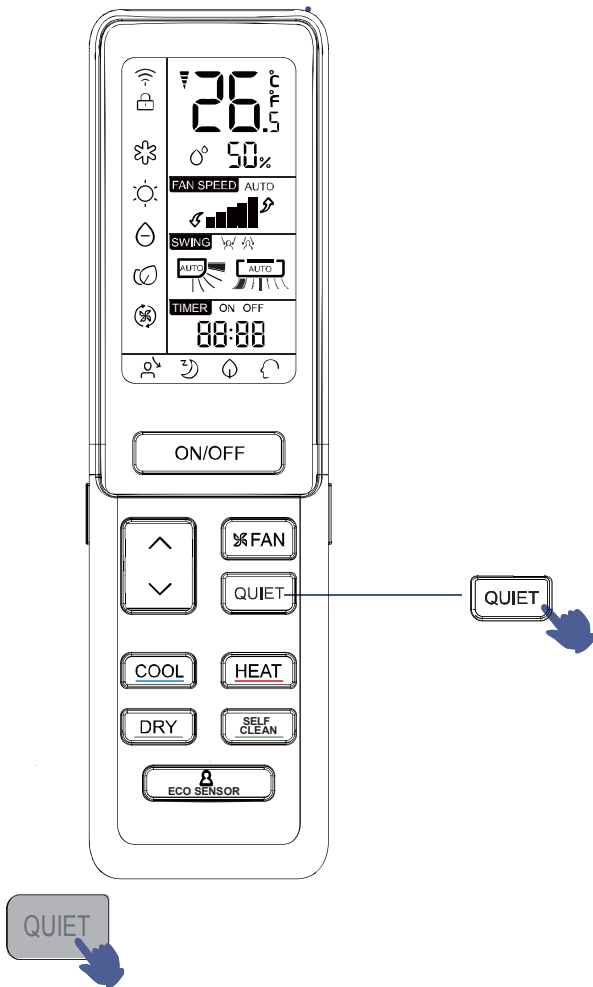

You can use this function when silence is needed for rest or reading.

For each press,  is displayed. Air conditioner starts QUIET function operation. In QUIET operation mode, fan speed automatically takes low speed of AUTO fan mode.

Press QUIET button again,  disappears, the operation stops.

## COOL, HEAT and DRY Operation

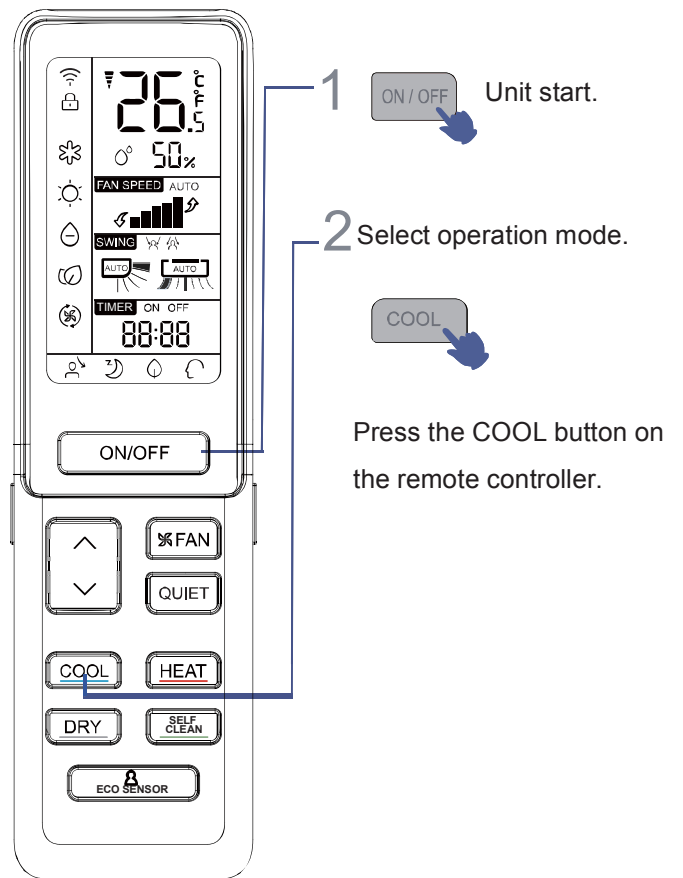

Press the COOL button on the remote controller.



Press the HEAT button on the remote controller.



Press the DRY button on the remote controller.

1. In DRY mode, when room temperature becomes  
• lower than temp. setting +2 °C, unit will run intermittently in LOW speed regardless of FAN setting.
2. Remote controller can memorize each operation status. When starting it next time, just press ON/OFF button and unit will run in previous status.

# Operation

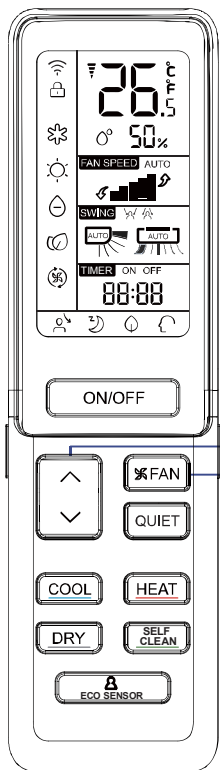

- 1 Press TEMP button.
  - △ Every time the button is pressed, temp. setting increases 1 °C.
  - ▽ Every time the button is pressed, temp. setting decreases 1 °C.

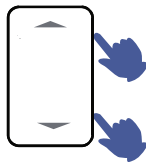

Unit will start running to reach the temp. setting on LCD.

## 2 FAN Operation



Press FAN SPEED button. For each press, fan speed changes as follows:

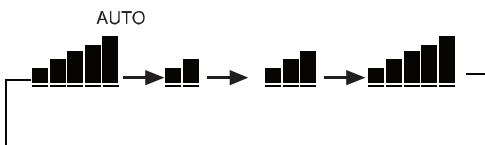

Unit will run at selected fan speed.

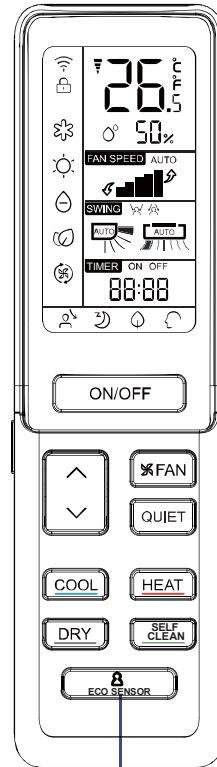

## 1 ECO SENSOR Operation

Press ECO SENSOR button, For each press, changes as follows:

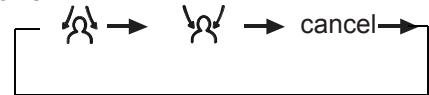

### NOTE :

A human sensor is used to detect changes in the infrared radiation emitted by human bodies. In case of the following conditions, the detection may not be accurate:

- High room temperature, where the ambient temperature is close to body temperature.
- People wear a lot or lie on their stomach or back.
- The speed of human movement exceeds the sensitivity of the sensor.
- Frequent movements of pets, or frequent swing of curtains or other indoor objects due to the wind.
- Moving targets go beyond the detection range of the sensor.
- The left and right ends of the indoor unit are installed too close to the wall.
- There is direct sunlight inside the room.

The air conditioner operates in a room where ambient temperature fluctuates sharply.

Besides, if a person is at the border of two or three air blowing areas, the following air will be sent to these two areas respectively or be swept automatically. The avoiding air will avoid these two areas or be swept automatically.

# Operation

## ECO SENSOR Operation

### Human Sensing Function

1. "Follow" function: It can detect where a person is and adjust the swing flap accordingly and send air to the location of this person. If it detects people in two locations, the swing flap will blow alternatively between these two locations and stay at each location for 15s. If the appliance detects people in two or more locations, the left and right swing flaps will swing automatically.

"Avoid" function: When the appliance detects a person in a location, it will adjust the swing flap to avoid such a location. If it detects people in three or more locations, the left and right swing flaps will swing automatically.

Note:

1) When there are people in several locations or a person frequently moves between several locations, if this person is in the in-between location or the crossing location, whether the appliance is in a "Follow" mode or an "Avoid" mode, the swing flap will swing automatically to send air to these locations.

2) Whether the setting is "Follow" or "Avoid", it takes some time to adjust the air direction after the appliance identifies the location of the people and the air direction will not change immediately.

3) If the actual airflow cannot reach (or avoid) the location where a person is due to such factors as fan speed setting, temperature setting, ambient temperature difference and layout of the room, pressing the left and right swing flaps can adjust the air direction and set the airflow direction by hand.

4) Set the health airflow when the human sensing (including follow/avoid) function is enabled and exit from the human sensing (including follow/avoid) function.

5) Press the upper and lower swing flaps when the human sensing (including follow/avoid) function is enabled, there is no upper and lower full swing status.

6) When the appliance is in the upper and lower full swing status, set the human sensing function (including follow/avoid), the upper and lower swing flaps are in their standard positions of relevant mode.

2. When the human sensing function is enabled, if the appliance cannot detect people for a long time (at least 20 minutes), it will automatically enter the power saving mode. In the power saving mode, the operating frequency will lower down and the fan speed is low. Once a person is detected, the appliance will exit from the power saving mode.

## HEALTH AIRFLOW Operation

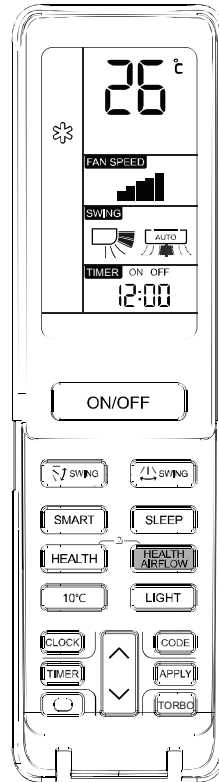

The setting of health airflow function

1). Press the button of health airflow,  appears on the display. Avoid the strong airflow blows direct to the body.

2). Press the button of health airflow again,  appears on the display. Avoid the strong airflow blows direct to the body.



The cancel of the health airflow function



Press the button of health airflow again, both the inlet and outlet grilles of the air conditioner are opened, and the unit goes on working under the condition before the setting of health airflow function. After stopping, the outlet grille will close automatically.

Notice:

Cannot pull direct the outlet grille by hand. Otherwise, the grille will run incorrectly. If the grille is not run correctly, stop for a minute and then start, adjusting by remote controller.

Remote controller can memorize each operation status. when starting it next time, just press ON/OFF button and unit will run in previous status.

Note:

1. After setting the health airflow function, the position of inlet and outlet grilles is fixed.
2. In heating, it is better to select the  mode.
3. In cooling, it is better to select the  mode.
4. In cooling and dry, using the air conditioner for a long time under the high air humidity, a phenomenon falling drips of water occurs at the outlet grille.
5. Select the appropriate fan direction according to the  
• actual conditions.

# Operation

## SWING Operation

**1 Up and down air flow direction**

For each press of “ SWING” button, air flow direction on remote controller displays as follows according to different operation modes:

**COOL/DRY:**

**HEAT:**

**SMART:**

Initial state

## 2 Left and right air flow direction

For each press of “ SWING” button, remote controller displays as follows:

remote controller:

Initial state

- When humidity is high, condensate water might occur at air outlet if all vertical louvers are adjusted to left or right.
- It is advisable not to keep horizontal flap at downward position for a long time in COOL or DRY mode, otherwise, condensate water might occur.
- As cold air flows downward in COOL mode, adjusting air flow horizontally will be much more helpful for a

## TIMER Operation

Set Clock correctly before starting Timer operation. You can let unit start or stop automatically a following times: Before you wake up in the morning, or get back from outside or after you fall asleep at night.

**1 Select your desired operation mode.**

Select your desired **TIMER ON**.

Remote controller: “**TIMER ON**” will flash.

Select your desired **TIMER OFF**.

Remote controller: “**TIMER OFF**” will flash.

**2 Time setting.**

Every time the button is pressed, time setting increases or decreases 1 min, if kept depressed, it will increase rapidly. It can be adjusted within 24 hours.

## 3 Confirming your setting.

After setting correct time, press **APPLY** button to confirm “**ON**” or “**OFF**” on the remote controller stops flashing.

**To cancel TIMER mode**  
Just press **APPLY** button the **TIMER** display disappear.

# Operation

## Comfortable SLEEP

Before going to bed, you can simply press the SLEEP button and unit will operate in SLEEP mode and bring you a sound sleep.

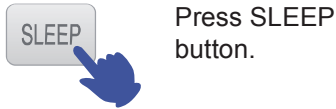
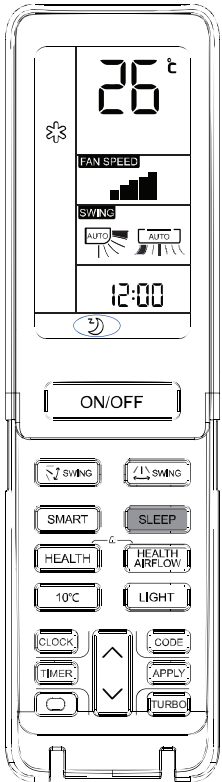

Press SLEEP button.

### Operation Mode

#### 1. In COOL, DRY mode

1 hour after SLEEP mode starts, temp will become 1 °C higher than temp setting. After another 1 hour, temp rises by 1 °C further. The unit will run for further 6 hours then stops Temp is higher than temp setting so that room temperature won't be too low for your sleep.

3 hours then stops. Temp. is lower than temp. setting so that room temperature won't be too high for your sleep.

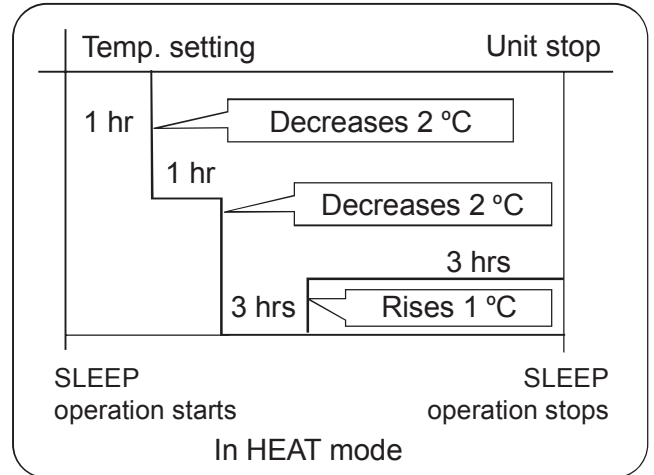

#### 3. In SMART mode

The unit operates in corresponding sleep mode, which adapted to the automatically selected operation mode.

4. When comfortable sleeping function is set to 8 hours the comfortable sleeping time can not be adjusted. When TIMER ON function is set, the comfortable sleeping function can't be set up. After the sleeping function is set up, if user resets TIMER ON function, the sleeping function will be cancelled; the machine will be in the state of timing-off, if the two modes are set up at the same time, either of their operation time is ended first, the unit will stop automatically, and the other mode will be cancelled.

### Power Failure Resume Function

If the unit is started for the first time, the compressor will not start running unless 3 minutes have elapsed. When the power resumes after power failure, the unit will run automatically, and 3 minutes later the compressor starts running.

### Note to the power failure resume:

press the sleep button ten times in five seconds and enter function after hearing four sounds. And press the sleep button ten times within five seconds and leave this function after hearing two sounds.

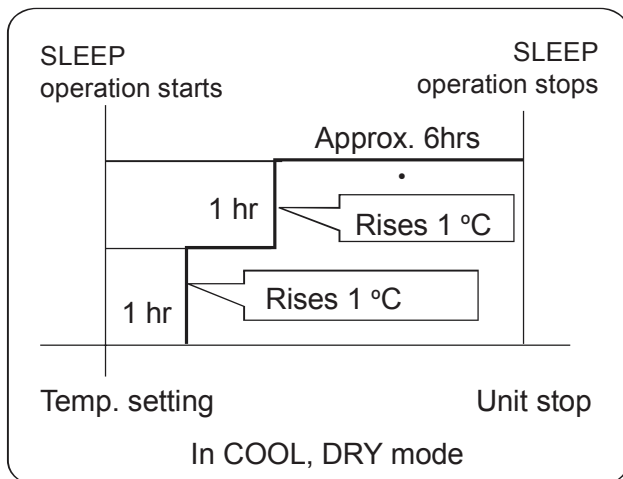

#### 2. In HEAT mode

1 hour after SLEEP mode starts, temp will become 2 °C lower than temp. setting. After another 1 hour, temp decrease by 2 °C further. After more another 3 hours, temp rises by 1 °C further. The unit will run for further



# Operation

## SMART Operation

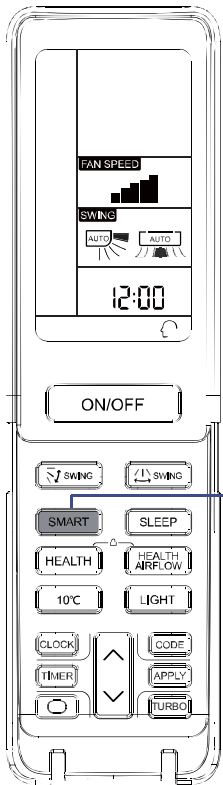

(This function is unavailable on some models)

One key can give you a comfortable room!

The air conditioning unit can judge the indoor temperature and humidity, and make the adjustment accordingly.

SMART SMART start

Press ON/OFF button, unit starts.  
Press SMART button " " is displayed on the remote controller.

SMART or ON/OFF SMART stops

Under the cooling, heating and dehumidifying mode, press the smart key to enter the smart function. Under the smart running mode, when the air conditioning is running, it will automatically select cooling, heating mode as When the smart function is running, press the "cooling" "heating" key to switch to the other mode, you will exit from the smart function.

## Self Clean Operation

◆Functional description: the purpose of this function is to clean the evaporator.

◆Entry and exit: Press self clean button to enter this function, then it will display "CL" on the panel of the indoor unit and also on the remote controller. After running 20-30 minutes, this function will exit automatically when the " Pi " sound is heard twice, then the unit returns to original state. Under operation process of self clean, pressing the button repeatedly has no effect and the function will not exit, but pressing the power off button and other mode button can make it exit.

Note:

- 1.It has no effect under the mode of timer/sleep.
- 2.After this mode starts, the air volume may reduce or it may even have no airflow.
- 3.It is normal if the unit makes some noise like expanding with heat and contracting with coldness.
4. The "CL" display time may last differently on the remote controller and panel.
- 5.It is normal if the temperature is below 0℃ outside, the unit may display "F25"under this mode running. Please turn off the unit for 10 seconds then restart.
- 6.The best condition to run this mode: the temperature is 15℃~27℃ and the humidity is 35%~60% in the door, the temperature is 30℃~40℃ (cooling season) and below 10℃ (heating season) out the door.
- 7.It is hard to frost if the air is too dry(humidity<20%). and if the humidity is too high(humidity>70%), the condensate water may increase, which may move away some frost.

- The power saving function only works under the cooling, heating or dehumidifying mode, after the power saving function is set, press the sharp, mute, sleep, or smart key to exit the power saving function.
- After the power saving is set, the host machine will automatically adjust the setting temperature, and automatically control the switch of the compressor, which may be inconsistent with the user's setting.
- The power saving function is more effective after the air conditioning has been running for a long time (more than 2 hours)

# Operation

## HEALTH Operation

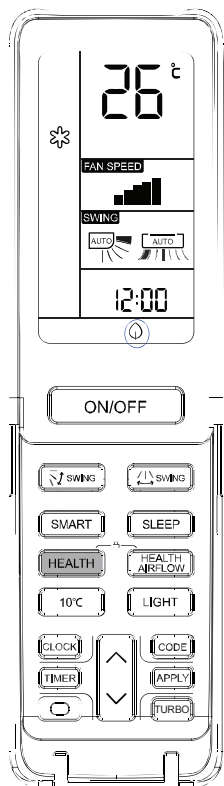

The water-ion generator in the air conditioner can generate a lot of anion effectively balance the quantity of position and anion in the air and also to kill bacteria and speed up the dust sediment in the room and finally clean the air in the room.

Press HEALTH button

For each press,  is displayed Air conditioner starts health anion function operation.



Press HEALTH button for twice press, disappears, the operation stops.

When indoor fan motor is running, it has healthy process function. (It's available under any mode)  
When the fan in the indoor unit does not work, the health lamp lights up, but the anion generator does not release anion.

## ON/OFF operation and test operation

### ON/OFF Operation:

- Use this operation only when the remote controller is defective or lost, and with function of emergency running, air conditioner can run automatically for a while.
- When the emergency operation switch is pressed, the "Pi" sound is heard once, which means the start of this operation.
- When power switch is turning on for the first time and emergency operation starts, the unit will run automatically in the following modes:

Room temperature	Designated temperature	Timer mode	Fan speed	Operation mode
Above 24 °C	24 °C	No	AUTO	COOL
Below 24 °C	24 °C	No	AUTO	HEAT

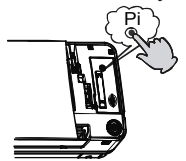

- It is impossible to change the settings of temp. and fan speed, It is also not possible to operate in timer or dry mode.

### Test operation:

Test operation switch is the same as emergency switch.

- Use this switch in the test operation when the room temperature is below 16 °C, do not use it in the normal operation.
- Continue to press the test operation switch for more than 5 seconds. After you hear the "Pi" sound twice, release your finger from the switch: the cooling operation starts with the air flow speed "Hi".

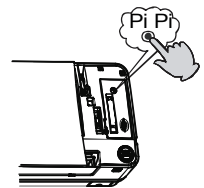

## Loading of the battery

1



Remove the battery cover;

2



Load the batteries as illustrated. 2 R-03 batteries, resetting key (cylinder); Be sure that the loading is in line with the "+" / "-";







3

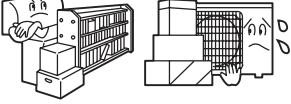

Load the battery, then put on the cover again.

# Maintenance

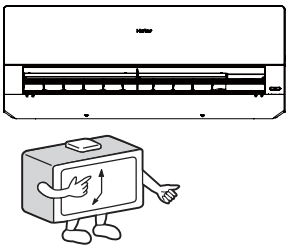
## For Smart Use of The Air Conditioner

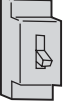
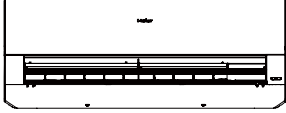
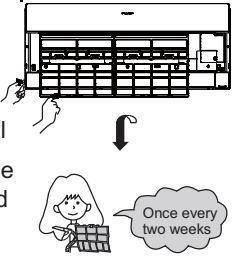
<p>Setting of proper room temperature</p>  <p>Proper temperature</p>	<p>Do not block the air inlet or outlet</p> 	<p>Remote Controller</p>  <p>Do not use water, wipe the controller with a dry cloth. Do not use glass cleaner or chemical cloth.</p>	<p>Indoor Body</p>  <p>wipe the air conditioner by using a soft and dry cloth. For serious stains, use a neutral detergent diluted with water. Wring the water out of the cloth before wiping, then wipe off the detergent completely.</p>
<p>Close doors and windows during operation</p>  <p>During cooling operation prevent the penetration of direct sunlight with curtain or blind</p>	<p>Use the timer effectively</p> 	<p>Do not use the following for cleaning</p>  <p>Gasoline, benzene, thinner or cleanser may damage the coating of the unit. Hot water over 40°C (104°F) may cause discoloring or deformation.</p>	
<p>If the unit is not to be used for a long time, turn off the power supply main switch.</p>  <p>OFF</p>	<p>Use the louvers effectively</p> 	<p>Air Filter cleaning</p> <ol style="list-style-type: none"> <li>1 Press the "SMART" button for 5s to partially raise the panel.</li> <li>2 Open the panel by hand and support the panel with a holder</li> <li>3 Remove the filter</li> <li>4 Clean the filter</li> <li>5 Fit the filter</li> <li>6 Remove the holder and close the panel</li> <li>7 Long press the "SMART" button and the panel will automatically lower down and become closed</li> </ol>  <p>Once every two weeks</p>	

## Replacement of Air Purifying Filter

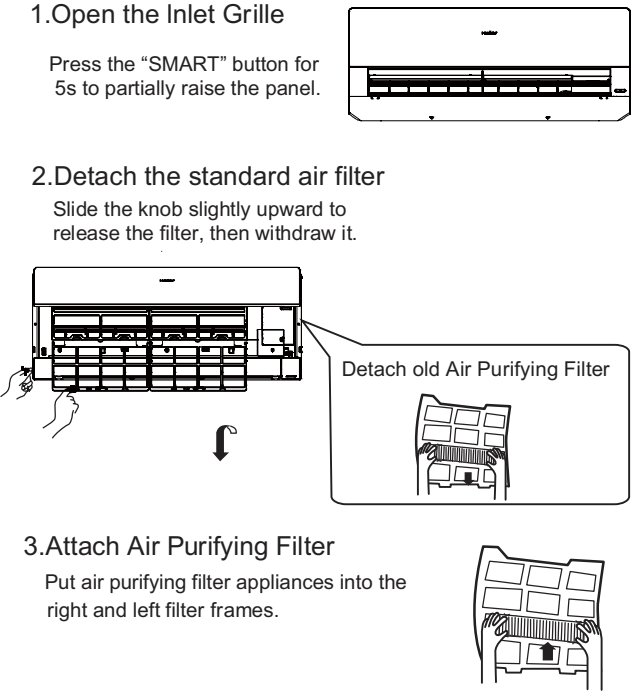
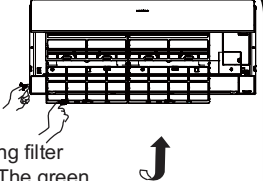
<ol style="list-style-type: none"> <li>1. Open the Inlet Grille Press the "SMART" button for 5s to partially raise the panel.</li> <li>2. Detach the standard air filter Slide the knob slightly upward to release the filter, then withdraw it.</li> <li>3. Attach Air Purifying Filter Put air purifying filter appliances into the right and left filter frames.</li> </ol> 	<ol style="list-style-type: none"> <li>4. Attach the standard air filter (Necessary installation)</li> <li>5. Close the Inlet Grille Long press the "SMART" button and the panel will automatically lower down and become closed.</li> </ol> <p>NOTE:</p> <ul style="list-style-type: none"> <li>• The photocatalyst air purifying filter will be solarized in fixed time. In normal family, it will be solarized every 6 months.</li> <li>• The bacteria-killing medium air purifying filter will be used for a long time, no need for replacement. But in the period of using them, you should remove the dust frequently by using vacuum cleaner or flapping them lightly, otherwise, its performance will be affected.</li> <li>• Please keep the bacteria-killing medium air purifying filter in the cool and dry conditions avoid long time directly sunshine when you stop using it, or its ability of sterilization will be reduced.</li> </ul> 
---	---

# Cautions

## ⚠ WARNING

Please call Sales/Service Shop for the Installation.

Do not attempt to install the air conditioner by yourself because improper works may cause electric shock, fire, water leakage.

## ⚠ WARNING

When abnormality such as burnt-smell found, immediately stop the operation button and contact sales shop.

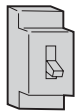

OFF



STRICT ENFORCEMENT

Use an exclusive power source with a circuit breaker

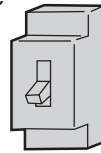

Check proper installation of the drainage securely



STRICT ENFORCEMENT

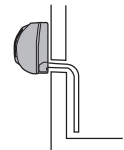

Connect power supply cord to the outlet completely



STRICT ENFORCEMENT

Use the proper voltage



STRICT ENFORCEMENT

1. Do not use power supply cord extended or connected in halfway  
2. Do not install in the place where there is any possibility of inflammable gas leakage around the unit.  
3. Do not get the unit exposed to vapor or oil steam.



PROHIBITION

Do not use power supply cord in a bundle.

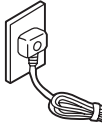

PROHIBITION

Take care not to damage the power supply cord.



PROHIBITION

Do not insert objects into the air inlet or outlet.



PROHIBITION

Do not start or stop the operation by disconnecting the power supply cord and so on.



PROHIBITION

Do not channel the air flow directly at people, especially at infants or the aged.



PROHIBITION

Do not try to repair or reconstruct by yourself.

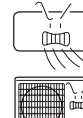

Connect the earth cable.

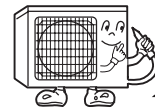

earthing

## ⚠ CAUTION

Do not use for the purpose of storage of food, art work, precise equipment, breeding, or cultivation.

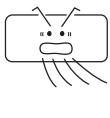

PROHIBITION

Take fresh air occasionally especially when gas appliance is running at the same time.

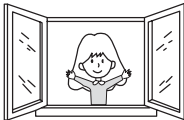

STRICT ENFORCEMENT

Do not operate the switch with wet hand.

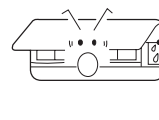

PROHIBITION

Do not install the unit near a fireplace or other heating apparatus.

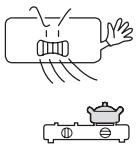

PROHIBITION

Check good condition of the installation stand

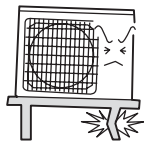

PROHIBITION

Do not pour water onto the unit for cleaning

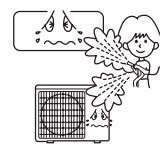

PROHIBITION

Do not place animals or plants in the direct path of the air flow

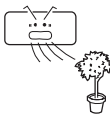

PROHIBITION

Do not place any objects on or climb on the unit.



PROHIBITION

Do not place flower vase or water containers on the top of the unit.





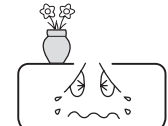

PROHIBITION



# Trouble shooting

Before asking for service, check the following first.

	Phenomenon	Cause or check points
Normal Performance inspection	The system does not restart immediately. 	<ul style="list-style-type: none"> <li>When unit is stopped, it won't restart immediately until 3 minutes have elapsed to protect the system.</li> <li>When the electric plug is pulled out and reinserted, the protection circuit will work for 3 minutes to protect the air conditioner.</li> </ul>
	Noise is heard 	<ul style="list-style-type: none"> <li>During unit operation or at stop, a swishing or gurgling noise may be heard. At first 2-3 minutes after unit start, this noise is more noticeable. (This noise is generated by refrigerant flowing in the system.)</li> <li>During unit operation, a cracking noise may be heard. This noise is generated by the casing expanding or shrinking because of temperature changes.</li> <li>Should there be a big noise from air flow in unit operation, air filter may be too dirty.</li> </ul>
	Smells are generated.	<ul style="list-style-type: none"> <li>This is because the system circulates smells from the interior air such as the smell of furniture, paint, cigarettes.</li> </ul>
	Mist or steam are blown out. 	<ul style="list-style-type: none"> <li>During COOL or DRY operation, indoor unit may blow out mist. This is due to the sudden cooling of indoor air.</li> </ul>
	In dry mode, fan speed can't be changed.	<ul style="list-style-type: none"> <li>In DRY mode, when room temperature becomes lower than temp. setting+2 °C, unit will run intermittently at LOW speed regardless of FAN setting.</li> </ul>
Multiple check		<ul style="list-style-type: none"> <li>Is power plug inserted?</li> <li>Is there a power failure?</li> <li>Is fuse blownout?</li> </ul>
	Poor cooling 	<ul style="list-style-type: none"> <li>Is the air filter dirty? Normally it should be cleaned every 15 days.</li> <li>Are there any obstacles before inlet and outlet?</li> <li>Is temperature set correctly?</li> <li>Are there some doors or windows left open?</li> <li>Is there any direct sunlight through the window during the cooling operation?(Use curtain)</li> <li>Are there too much heat sources or too many people in the room during cooling operation?</li> </ul>

# Cautions

- Do not obstruct or cover the ventilation grille of the air conditioner. Do not put fingers or any other things into the inlet/outlet and swing louver.
- This appliance is not intended for use by persons (including children) with reduced physical, sensory or mental capabilities or lack of experience and knowledge, unless they have been given supervision or instruction concerning use of appliance by person responsible for their safety. Children should be supervised to ensure that they do not play with the appliance.

## Specifications

- The refrigerating circuit is leak-proof.

## The machine is adaptive in following situation

- Applicable ambient temperature range:

Cooling	Indoor	Maximum: D.B/W.B 32°C/23°C Minimum: D.B/W.B 21°C/15°C
	Outdoor	Maximum: D.B/W.B 46°C/26°C Minimum: D.B -20°C
Heating	Indoor	Maximum: D.B 27°C Minimum: D.B 15°C
	Outdoor	Maximum: D.B/W.B 24°C/18°C Minimum: D.B/W.B -7°C/-8°C
	Outdoor (INVERTER)	Maximum: D.B/W.B 24°C/18°C Minimum: D.B -15°C

- If the power supply cord is damaged, it must be replaced by the manufacturer or its service agent or a similar qualified person.
- If the fuse of indoor unit on PC board is broken, please change it with the type of T. 3.15A/250V. If the fuse of outdoor unit is broken, change it with the type of T.25A/250V
- The wiring method should be in line with the local wiring standard.
- After installation, the power plug should be easily reached.
- The waste battery should be disposed properly.
- The appliance is not intended for use by young children or infirm persons without supervision.
- Young children should be supervised to ensure that they do not play with the appliance.
- Please employ the proper power plug, which fit into the power supply cord.
- The power plug and connecting cable must have acquired the local attestation.
- In order to protect the units, please turn off the A/C first, and at least 30 seconds later, cutting off the power.



## Free Manuals Download Website

<http://myh66.com>

<http://usermanuals.us>

<http://www.somanuals.com>

<http://www.4manuals.cc>

<http://www.manual-lib.com>

<http://www.404manual.com>

<http://www.luxmanual.com>

<http://aubethermostatmanual.com>

Golf course search by state

<http://golfingnear.com>

Email search by domain

<http://emailbydomain.com>

Auto manuals search

<http://auto.somanuals.com>

TV manuals search

<http://tv.somanuals.com>