

OPERRATION

SPLIT TYPE ROOM AIR CONDITIONER OPERATION MANUAL

HSU-07HC03/R2	HSU-09HD03/R2
HSU-09HC03/R2	HSU-12HD03/R2
HSU-12HC03/R2	HSU-14HB03/R2
HSU-07HE03/R2	HSU-18HB03/R2
HSU-09HE03/R2	HSU-22HC03/R2
HSU-12HE03/R2	HSU-22HD03/R2
HSU-07HD03/R2	HSU-22HB03/R2

- Please read this operation manual before using the air conditioner.

No.0010557173

Contents

Cautions.....	1
Parts and functions.....	2-4
Operation.....	5-12
Maintenance	13-14
Trouble shooting.....	15

Cautions

The machine is adaptive in following situation

I. Applicable ambient temperature range:

Cooling	Indoor	Maximum: D.B / W.B Minimum: D.B / W.B	32°C/23°C 18°C/14°C
	Outdoor	Maximum: D.B Minimum: D.B	43°C/26°C 18°C
Heating	Indoor	Maximum: D.B Minimum: D.B	27°C 15°C
	Outdoor	Maximum: D.B / W.B Minimum: D.B / W.B	24°C/18°C -7°C/-8°C

2. If the supply cord is damaged, it must be replaced by the manufacturer or its service agent or a similar qualified person. The type of connecting wire is H05RN-F or H07RN-F
3. If the fuse on PC board is broken please change it with the type of T. 3.15A/250V.
4. The distance between the indoor unit and the floor should be more than 2m.
5. The wiring method should be in line with the local wiring standard.
6. After installation, the power plug should be easily reached.
7. The waste battery should be disposed properly.
8. The appliance is not intended to use by young children or infirm persons without supervision.
9. Young children should be supervised ensure that they do not play with the appliance.
10. The appliance must be installed on strong enough supporter.
11. The wiring diagram is attached inside the machine.

Parts and Functions

Indoor Unit

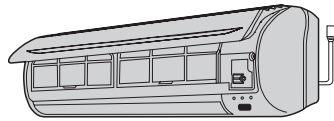
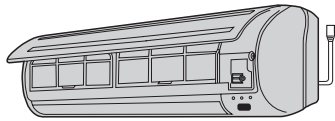
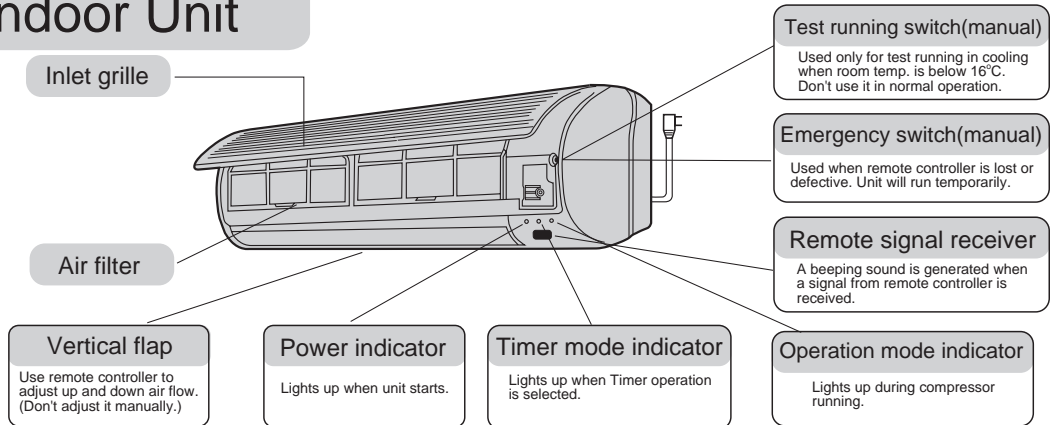

HSU-07HC03/R2
HSU-12HE03/R2

HSU-07HE03/R2
HSU-12HC03/R2

HSU-09HC03/R2
HSU-14HB03/R2

HSU-09HE03/R2
HSU-18HB03/R2

HSU-09HD03/R2
HSU-12HD03/R2

HSU-07HD03/R2

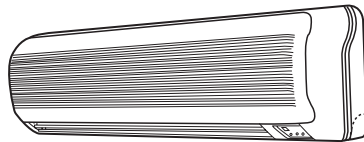

HSU-22HB03/R2 HSU-22HC03/R2 HSU-22HD03/R2

Actual inlet grille may vary from the one shown in the manual according to the product purchased

Outdoor Unit

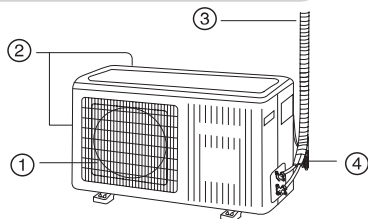

HSU-07HC03/R2 HSU-09HE03/R2
HSU-07HE03/R2 HSU-12HE03/R2
HSU-07HD03/R2 HSU-09HD03/R2
HSU-09HC03/R2 HSU-12HD03/R2

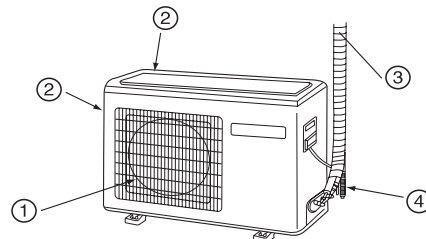

HSU-12HC03/R2
HSU-14HB03/R2

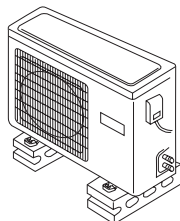

HSU-18HB03/R2

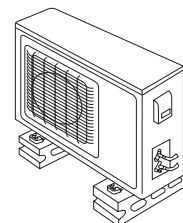

HSU-22HD03/R2
HSU-22HC03/R2
HSU-22HB03/R2

① OUTLET

② INLET

③ CONNECTING PIPING AND ELECTRICAL WIRING

④ DRAIN HOSE

Parts and Functions

Operation

Buttons and display of the remote controller.

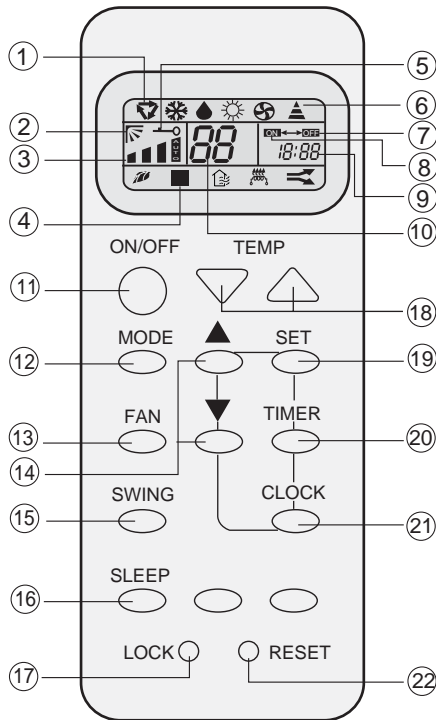

1. Mode display
 AUTO
 COOL
 DRY
 HEAT
 FAN
2. SWING display
3. FAN SPEED display
4. SLEEP display
5. LOCK display
6. SIGNAL SENDING
7. TIMER OFF display
8. TIMER ON display
9. CLOCK display
10. TEMP display
11. POWER ON/OFF
 Used for unit start and stop.
12. MODE
 Used to select AUTO run, COOL, DRY, HEAT and FAN operation
13. FAN
 Used to select fan speed LO, MED, HI, AUTO
14. HOUR
 Used to set clock and timer setting.
15. SWING
 Used to set auto fan direction.
16. SLEEP
 Used to select sleep mode.
17. LOCK
 Used to lock buttons and LCD display.
18. TEMP.
 Used to select your desired temp.
19. SET
 Used to confirm timer and clock settings.
20. TIMER
 Used to select TIMER ON, TIMER OFF, TIMER ON-OFF
21. CLOCK
 Used to set correct time
22. RESET
 Used to reset the controller back to normal condition.

Clock set

When unit is started for the first time and after replacing batteries in remote controller, clock should be adjusted as follows:

Press CLOCK button, "AM" or "PM" flashes.

Press Δ or ∇ to set correct time. Each press will increase or decrease 1min. If the button is kept depressed, time will change quickly.

After time setting is confirmed, press SET, "AM" and "PM" stop flashing, while clock starts working.

NOTE: Cooling only unit do not have displays and functions related with heating

Hints

After replacing with new batteries, remote controller will conduct self-check, displaying all information on LCD. Then, it will become normal.

Parts and Functions

Operation

Buttons and display of the remote controller.

If the unit which you purchased has healthy function, Remote controller should like the following figure:

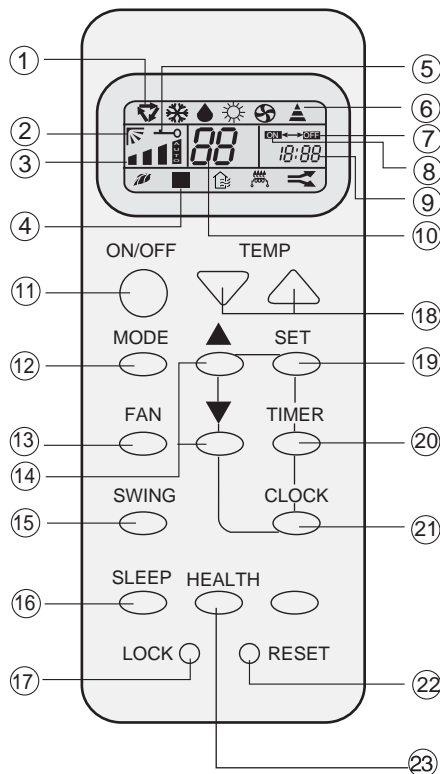

1. Mode display
 AUTO ❄️
 COOL ❄️
 DRY 💧
 HEAT 🔥
 FAN 🌀
2. SWING display
3. FAN SPEED display
4. SLEEP display
5. LOCK display
6. SIGNAL SENDING
7. TIMER OFF display
8. TIMER ON display
9. CLOCK display
10. TEMP display
11. POWER ON/OFF
 Used for unit start and stop.
12. MODE
 Used to select AUTO run, COOL, DRY, HEAT and FAN operation
13. FAN
 Used to select fan speed LO, MED, HI, AUTO
14. HOUR
 Used to set clock and timer setting.
15. SWING
 Used to set auto fan direction.
16. SLEEP
 Used to select sleep mode.
17. LOCK
 Used to lock buttons and LCD display.
18. TEMP.
 Used to select your desired temp.
19. SET
 Used to confirm timer and clock settings.
20. TIMER
 Used to select TIMER ON, TIMER OFF, TIMER ON-OFF
21. CLOCK
 Used to set correct time
22. RESET
 Used to reset the controller back to normal condition.
23. HEALTH
 Used to set healthy operation



BRIEF INTRODUCTION TO HEALTH OPERATION

The anion generator in the air conditioner can generate a lot of anion to effectively balance the quantity of positive and anion in the air and also to kill bacteria and speed up the dust sediment in the room and finally clean the air in the room.

NOTE: Cooling only unit do not have displays and functions related with heating

Hints

After replacing with new batteries, remote controller will conduct self-check, displaying all information on LCD. Then, it will become normal.

Operation

Remote controller's operation

- When in use, put the signal transmission head directly to the receiver hole on the indoor unit.
- The distance between the signal transmission head and the receiver hole should be within 7m without any obstacle as well.
- Don't throw the controller, prevent it from being damaged.
- When electronic-started type fluorescent lamp or change-over type fluorescent lamp or wireless telephone is installed in the room, the receiver is apt to be disturbed in receiving the signals so the distance to the indoor unit should be shorter.

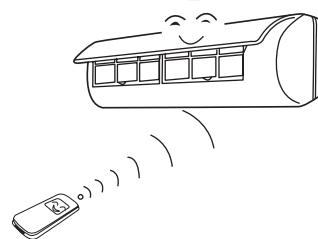

Loading of the battery

Load the batteries as illustrated. 2 R-03 batteries, resetting key (cylinder)

Remove the battery cover:

Slightly press "▼" and push down the cover.

Load the battery:

Be sure that the loading is in line with the "+" / "-" pole request as illustrated.

Put on the cover again

Confirmation indicator:

In disorderation, reload the batteries or load the new batteries after 6mins.

Note:

Use two new same-typed batteries when loading.

If the remote controller can't run normally or doesn't work at all, use a sharp pointed item to press the reset key.

Hint:

Remove the batteries in case unit won't be in usage for a long period.

If there are any display after taking-out just need to press reset key.

Power failure resume(please set and apply as necessary)

If sudden power failure occurs, the unit will resume original operation when power is supplied again.

Note: When sudden power failure happens during unit operation in power failure resume mode, if the air conditioner is not desired for use in a long period, please shut off the power supply in case that the unit automatically resume operation when power is re-supplied, or press ON/OFF to turn off the unit when power resumes.

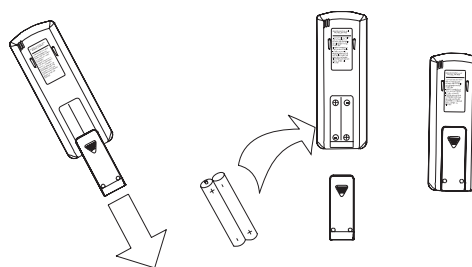

Operation

Auto run, Fan operation

Enjoy yourself by just a gentle press.

(1) Unit start

Press ON/OFF button, unit starts.
 Previous operation status appears on display.
 (Not Timer setting)
 Power indicator on indoor unit lights up.

(2) Select operation mode

Press MODE button. For each press, operation mode changes as follows:



Unit will run in selected mode.
 Stop display at "AUTO" or "FAN".

(3) FAN

Press FAN button. For each press, fan speed changes as follows:

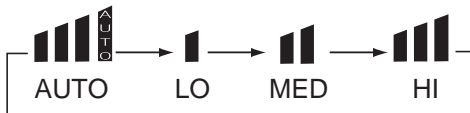

Unit will run at selected fan speed.
 Note: AUTO is not available in FAN mode.

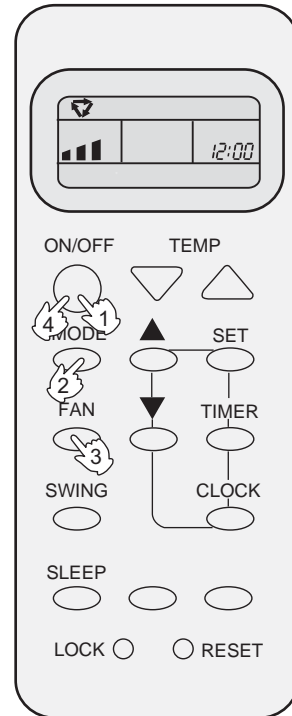

(4) Unit stop

Press ON/OFF button.
 Only time remains on LCD.
 All indicators on indoor unit go out.
 Vertical flap closed automatically.

Hints

Remote controller can memorize settings in each operation mode. To run it next time just select the operation mode and it will start with the previous setting.

No reelecting is needed. (TIMER ON/OFF needs reelecting)

Cautions:

On cooling only unit, heating mode is not available,
 After replacing batteries, press ON/OFF, and display becomes as follows:

Operation mode: AUTO, Temp. No
 Timer mode: No, Fan speed :AUTO

Note:

The above information is the explanation of the displayed information therefore varies with those displayed in actual operation.

Operation

COOL, HEAT and DRY operation

- Recommendations:
- Use COOL in summer.
 - Use HEAT in winter
 - Use DRY in spring, autumn and in damp climate.

(1) Unit start

Press ON/OFF button, unit starts.

Previous operation status appears on display. (Not Timer setting)

Power indicator on indoor unit lights up.

(2) Select operation mode

Press MODE button. For each press, operation mode changes as follows:



Unit will run in operation mode displayed on LCD.

Stop display at your desired mode.

(3) Select temp. setting

Press TEMR button.

△ Every time the button is pressed, temp. setting increases 1°C

▽ Every time the button is pressed, temp. setting decreases 1°C

Unit will start running to reach the temp. setting on LCD.

(4) Fan speed selection

Press FAN button. For each press, fan speed changes as follows:

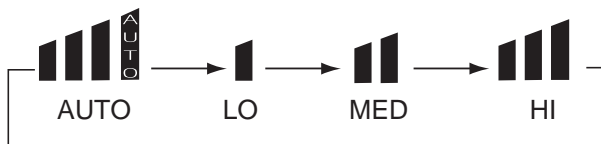

Unit runs at the speed displayed on LCD.

In DRY mode, when room temperature becomes lower than temp.setting+2°C, unit will run intermittently at LOW speed regardless of FAN setting.

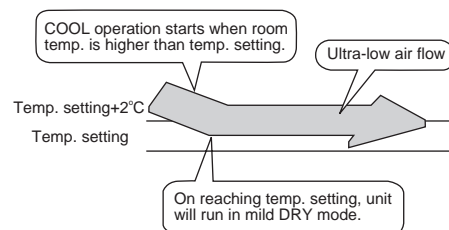
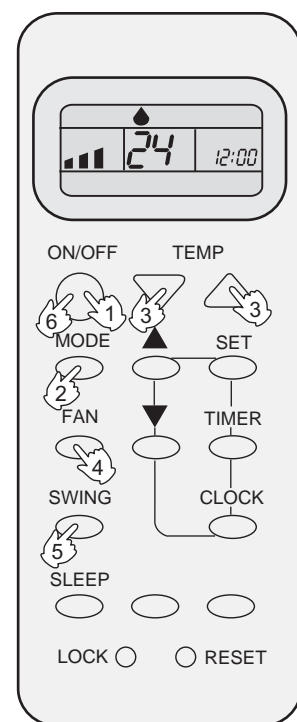

Hints

On cooling only unit, heating mode is not available.

Remote controller can memorize each operation status. When starting it next time, just press ON/OFF button and unit will run in previous status.

Operation

(5) Air flow direction adjustment

After operation mode is selected, vertical flap will open automatically according to the mode. Referring to the Fig.

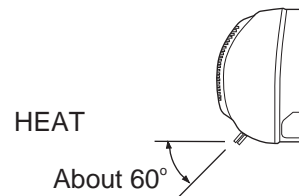
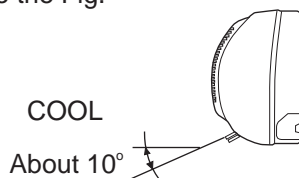

Up and down (Use remote controller)

Press SWING button, vertical flap will move within the range shown in the Fig. Press SWING button stop it at a fixed position.

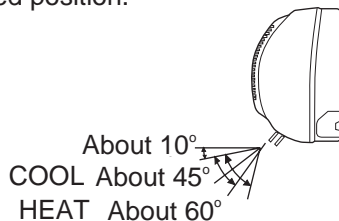

Left and right air flow adjustment (manual)

Move the horizontal blade by a knob on air conditioner to adjust left and right direction referring to Fig.

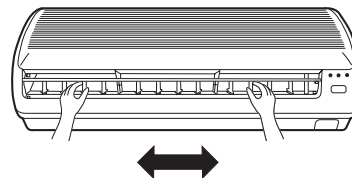

Cautions:

It is advisable not to keep vertical flap at downward position for a long time in COOL or DRY mode, otherwise, condensate water might occur.

Cautions:

When humidity is high, condensate water might occur at air outlet if all horizontal louvers are adjusted to left or right.

(6) Unit stop

Press ON/OFF button.

Only time remains on LCD.

All indicators on indoor unit go out.

Vertical flap closes automatically.

Cautions:

Unit won't restart until 3 minutes have elapsed, due to system protection. HEAT mode is not available on cooling only unit.

Hints

As cold air flows downward in COOL mode, adjusting air flow horizontally will be much more helpful for a better air circulation.

As warm air flows upward in HEAT mode, adjusting air flow downward will be much more helpful for a better air circulation.

Be careful not to catch a cold when cold air blows downward.

It is harmful to your health in summer to go frequently in and out of places where temp. difference is above 7°C. Temp. difference of 3-5°C will remove your fatigue.

More than this, unit's load can be reduced and power consumption cut down as well. So, you'd better set a temp. difference of 3-5°C between indoor and outdoor temp. in COOL mode.

Operation

TIMER Operation

Set Clock correctly before starting Timer operation

You can let unit start or stop automatically at following times: Before you wake up in the morning, or get back from outside or after you fall asleep at night.

TIMER ON/OFF

(1)After unit start, select your desired operation mode.

Operation mode will be displayed on LCD.

Power indicator on indoor unit lights up.

(2)TIMER mode selection

Press TIMER button to change TIMER mode.

Every time the button is pressed, display changes as follows:



Select your desired TIMER mode (TIMER ON or TIMER OFF) ON or OFF will flash.

(3)Timer setting

Press HOUR Δ / ∇ button.

Δ Every time the button is pressed, time increases 10 min. If button is kept depressed, time will change quickly.

∇ Every time the button is pressed, time decreases 10 min. If button is kept depressed, time will change quickly. Time will be shown on LCD. It can be adjusted within 24 hours.

(4)Confirming your setting

After setting correct time, press SET button to confirm, "ON" or "OFF" stops flashing

Time displayed: Unit starts or stops at x hour x min. (TIMER ON or TIMER OFF).

Timer mode indicator on indoor unit lights up.

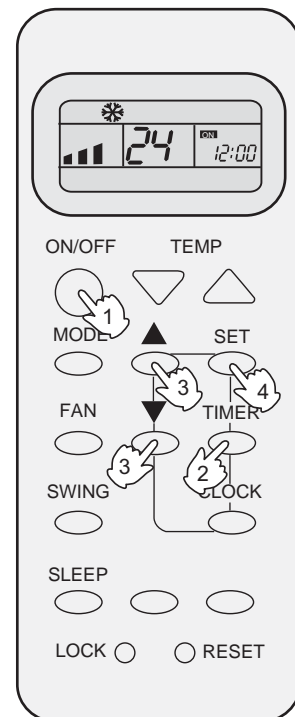

To cancel TIMER mode

Just press TIMER button several times until TIMER mode disappears.

Hints

After replacing batteries or a power failure happens, Time setting should be reset.

Remote controller possesses memory function, when use TIMER mode next time, just press SET button after mode selecting if timer setting is the same as previous one.

Operation

TIMER ON-OFF

(1) After unit start, select your desired operation mode
Operation mode will be displayed on LCD.
Power indicator on indoor unit lights up.

(2) Press TIMER button to change TIMER mode.
Every time the button is pressed, display changes as follows:



Select TIMER ON-OFF. "ON" will flash.

(3) Time setting for TIMER ON

Press HOUR button.

△ Every time the button is pressed, time increases 10 min.

If button is kept depressed, time will change quickly.

▽ Every time the button is pressed, time decreases 10 min.

If button is kept depressed, time will change quickly.

Time will be shown on LCD.

It can be adjusted within 24 hours.

AM refers to morning and PM to afternoon

(4) Time confirming for TIMER ON

After time setting, press TIMER button to confirm.

"ON" stops blinking, While "OFF" starts blinking.

Time displayed: Unit starts at x hour x min.

(5) Time setting for TIMER OFF

Follow the same procedures in "Time setting for TIMER ON".

(6) Time confirming for TIMER OFF

After time setting, press SET button to confirm, "OFF" stops flashing

Time displayed: Unit stops at X hour X min.

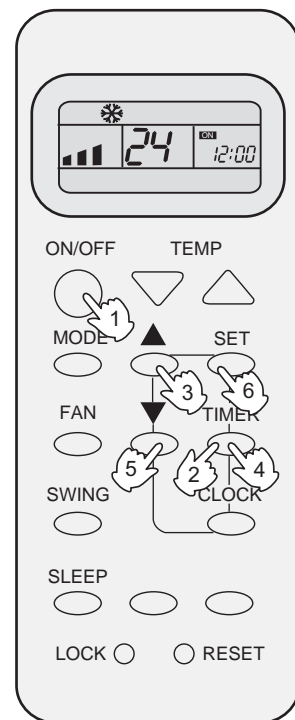

To cancel TIMER mode

- Just press TIMER button several times until TIMER mode disappears.

Operation

Emergency operation and test operation

Emergency Operation:

- Carry out this operation only when the remote controller is defective or lost.
- When the emergency operation switch is pressed, a "Pi" sound starts once, which means the start of this operation.
- In this operation, it is not possible to change the settings of temperature and air flow speed, it is also impossible to do an operation by the timer.
- Follow the requirements below.

Room temperature	Designated temperature	Timer mode	Air flow speed	Operation mode
More than 23°C	26°C	CONTINUOUS	AUTO	COOL
Less than 23°C	23°C	CONTINUOUS	AUTO	HEAT

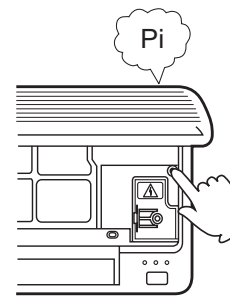

If an air conditioner is a model for both cooling and heating.

Cooling when the room temperature at the start of operation is above 23°C.

Heating when the room temperature at the start of operation is below 23°C

Test operation:

- Use this switch in the test operation when the room temperature is less than 16°C, do not use it in the normal operation.
- Continue to press the test operation switch for more than 5 seconds. After you hear the "Pi" sound twice, release your finger from the switch, the cooling operation starts with the air flow speed setting "Hi".

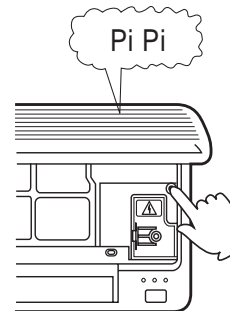

Removal of the restriction of emergency or test operation:

- Press once more the emergency operation switch, or manipulate through the remote controller, a "Pi" sound causes the restriction of emergency or test operation to be removed.
- When the remote controller is manipulated for the removal, then the selected operation by the remote controller.

Operation

Comfortable SLEEP

Before going to bed at night, you can simply press the SLEEP button and unit will bring you a sound sleep in selected mode.

In COOL mode

One hour after SLEEP mode starts, temp. will become 1°C higher than temp. setting. After running for another 1 hour, temp. rises by 1°C further. Unit will run for 6 hours then stops automatically. Temp. is higher than temp. setting so that room temp. won't be too low for your sleep. (As shown in Fig.1)

In HEAT mode

One hour after SLEEP mode starts, temp. will become 2°C lower than temp. setting. After running for another 1 hour, temp. decreases by 2°C further. Unit will run for 3 hours at this temp. then increases another 1°C and stops automatically 3 hours later. Temp. is lower than temp. setting so that room temp. won't be too high for your sleep. (As shown in Fig. 2)

Power Failure Resume Function

If the unit is started for the first time, the compressor will not start running unless 3 minutes have elapsed. When the power resumes after power failure, the unit will run automatically, the power indicator lights up, and 3 minutes later the compressor starts running with the indicator lighting up.

Note:

In AUTO mode, unit will run in SLEEP function according to operation mode.

In FAN mode, comfortable sleep is not available.

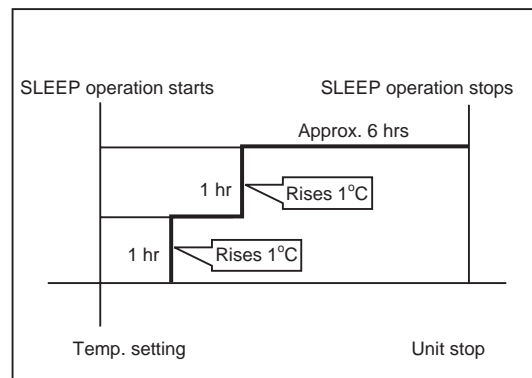
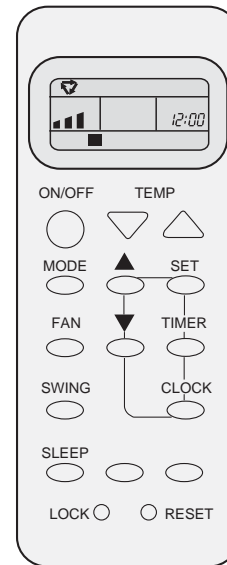

Fig.1

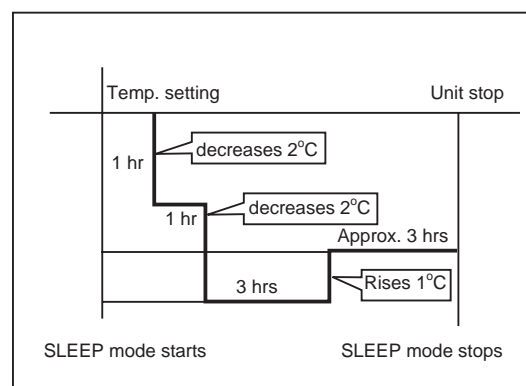

Fig.2

Maintenance

Different models have different appearance



Cleaning of unit casing



Cleaning of remote controller



Cleaning of air filter

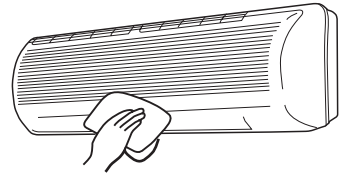

Cut off power supply before cleaning unit casing with soft cloth. In case of heavy stain, clean it with neutral detergent. squeeze water in the cloth, wipe off the detergent on unit casing completely.

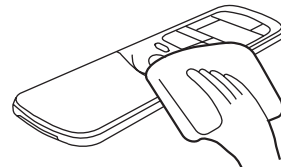

Don't use water to wash unit casing, please use dry cloth. Don't use glass cleaner or cloth soaked with chemicals.

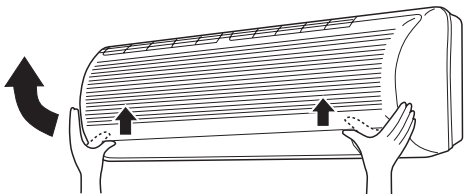

1. Open inlet grille by pulling it upward.

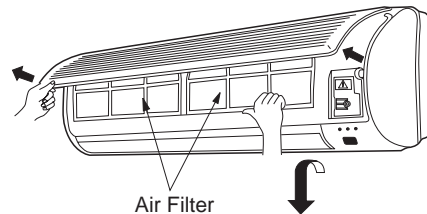

2. Remove air filter
Push up the filter's center tab slightly until it is caesura of the stopper. Remove it by pulling down.

3. Clean the filter
Use a vacuum cleaner to remove dust, or wash the filter with water. After washing, dry the filter completely in the shade.

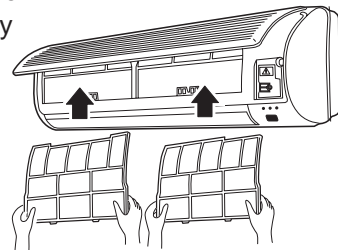
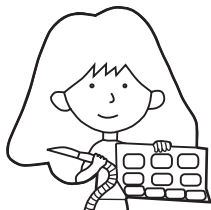

4. Attach the filter
Attach filter behind the stopper so that the "Front" indication is facing to the front. Make sure that it is completely behind the stopper, otherwise problems might occur.

5. Close the inlet grille.

Maintenance

Better use of air conditioner

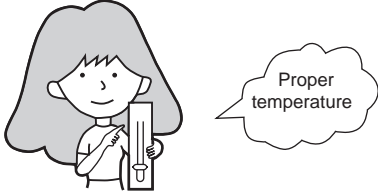
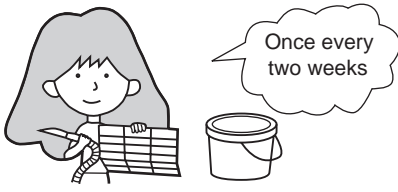
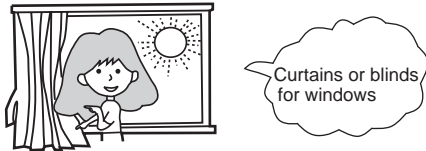
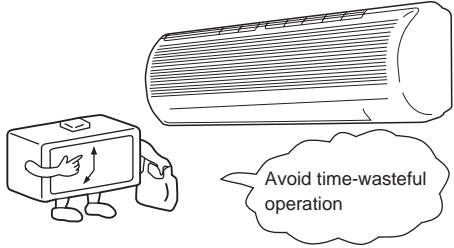

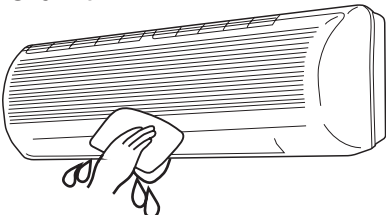
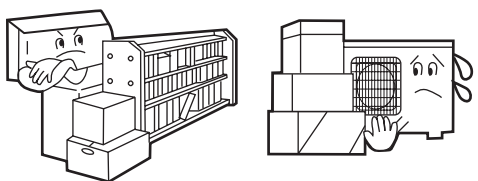
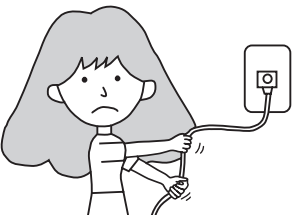
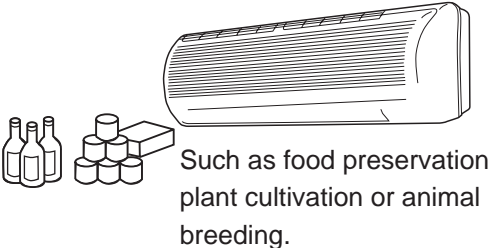

<p>Proper room temperature.</p>  <p>Proper temperature</p>	<p>Cleaning of the air filter.</p>  <p>Once every two weeks</p>
<p>Closing of doors and windows during operation</p>  <p>Curtains or blinds for windows</p>	<p>Effective use of the timer.</p>  <p>Avoid time-wasteful operation</p>

Never fail to observe the followings

<p>Do not sprinkle water over the unit.</p> 	<p>Do not block the inlet or outlet.</p> 
<p>Do not pull power plug.</p> 	<p>Do not use for other purposes.</p>  <p>Such as food preservation plant cultivation or animal breeding.</p>

Trouble shooting

Before asking for service, check the following first.

	Phenomenon	Cause or check points
Normal Performance inspection	<p>The system does not restart immediately.</p> 	<ul style="list-style-type: none"> • When unit is stopped, it won't restart immediately until 3 minutes have elapsed to protect the system. • When the electric plug is pulled out and reinserted, the protection circuit will work for 3 minutes to protect the air conditioner.
	<p>Noise is heard</p> 	<ul style="list-style-type: none"> • During unit operation or at stop, a swishing or gurgling noise may be heard. At first 2-3 minutes after unit start, this noise is more noticeable. (This noise is generated by refrigerant flowing in the system.) • During unit operation, a cracking noise may be heard. This noise is generated by the casing expanding or shrinking because of temperature changes • Should there be a big noise from air flow in unit operation, air filter may be too dirty.
	<p>Smells are generated.</p>	<ul style="list-style-type: none"> • This is because the system circulates smells from the interior air such as the smell of furniture, cigarettes.
	<p>Mist or steam are blown out.</p> 	<ul style="list-style-type: none"> • During COOL or DRY operation, indoor unit may blow out mist. This is due to the sudden cooling of indoor air.
Multiple check	<p>Does not work at all.</p> 	<ul style="list-style-type: none"> • Is power plug inserted? • Is there a power failure? • Is fuse blown out?
	<p>Poor cooling</p> 	<ul style="list-style-type: none"> • Is the air filter dirty? Normally it should be cleaned every 15 days. • Are there any obstacles before inlet and outlet? • Is temperature set correctly? • Are there some doors or windows left open? • Is there any direct sunlight through the window during the cooling operation?(Use curtain) • Are there too much heat sources or too many people in the room during cooling operation?

Application temp. range of air conditioner -7°C~43°C.

ELECTRICAL CONTROLL

Including electrically controlled function introduction of air conditioners:
1、 Introduction of electrically controlled functions
1.1 Automatic running (applicable to fan-coil model)

When the running mode is turned to automation after starting the system, the system will first determine the running mode according to the current room temperature and then will run according to the determined mode. T_r in the following selection conditions means room temperature, T_s means setting temperature, T_p means temperature of indoor coil pipe

- | | | |
|--------------------------------|----------------------|--------------------------|
| a. $T_r > 23^\circ\text{C}$ | running cooling mode | $T_s = 26^\circ\text{C}$ |
| b. $T_r \leq 23^\circ\text{C}$ | running heating mode | $T_s = 23^\circ\text{C}$ |

After turning to the automation mode, the running mode can be switched between refrigerating mode, fan mode and heating mode according to the change of the indoor ambient temperature. But the automatic conversion between refrigerating mode and heating mode must be conducted after 15 minutes.

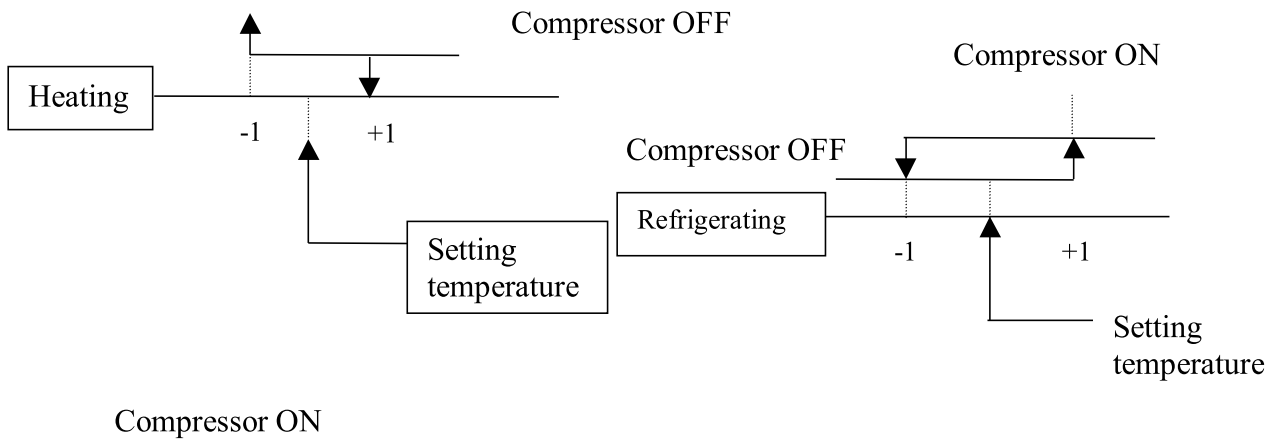
1.2 Indoor temperature control

1.3 Dehumidification running

The compressor, outdoor fan and indoor fan will run as per the following working pattern so as to realize the cooling running of dehumidification:

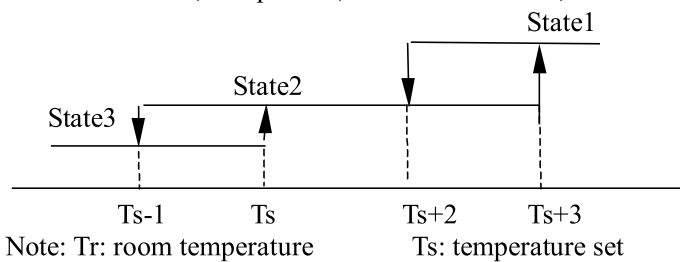
- ① $T_r > T_s + 2^\circ\text{C}$, compressor, outdoor fan run continuously, indoor fan runs as per setting wind speed (State 1);
- ② $T_s + 2^\circ\text{C} \geq T_r \geq T_s$, compressor, outdoor fan run intermittently with 10 minutes ON, 6 minutes OFF. (Compressor and outdoor fan are synchronous) indoor fan runs in fixed lower wind speed, and will cease at the stand-by time of 3 minutes (State 2)
- ③ $T_r < T_s$, compressor, outdoor fan ceases, indoor fan runs in lower wind speed. (State 3)



1.4 Warm start (preventing cold wind when heating running begins, applicable to fan-coil model))

When heating running begins, indoor fan will conduct the following fan control:

- ① If the temperature of indoor coil pipe is $\geq 28^{\circ}\text{C}$, start lower wind speed;
- ② If the temperature of indoor coil pipe is $\geq 38^{\circ}\text{C}$ or the running time of compressor ≥ 4 minutes, turn to setting wind speed.

1.5 Control of indoor fan under heating OFF state (applicable to fan-coil model)

Under heating state, the compressor will cease; if the indoor coil pipe s temperature $T_p \geq 23^{\circ}\text{C}$, indoor fan will run in lower wind speed.

1.6 Defrosting control (applicable to fan-coil model)

(1) Defrosting beginning condition:

- a. After the state of $T_p - T_r < \text{ }^{\circ}\text{C}$ is continued for 5 minutes, the accumulated running time of the compressor exceeds 45 minutes, the continuous running time of the compressor exceeds 20 minutes;
- b. The accumulated running time of the compressor exceeds 3 hours, the continuous running time of the compressor exceeds 20 minutes, indoor unit s $T_p < \text{ }^{\circ}\text{C}$;
- c. The continuous running time of the compressor exceeds 20 minutes, the temperature of indoor coil pipe decreases 1°C every 6 minutes, which lasts for more than 3 times, indoor unit s $T_p < \text{ }^{\circ}\text{C}$;
- d. When the indoor unit is in the state of overload protection and the outdoor unit ceases,when the rerunning time of outdoor unit exceeds 10 minutes, the accumulated running time of the compressor exceeds 45 minutes, the continuous running time of the compressor is over 20 minutes, and $T_p < \text{ }^{\circ}\text{C}$.

Defrosting will begin if one of the above conditions is met.

(2) Defrosting finishing condition:

If the defrosting time exceeds 9 minutes, the original heating state will be resumed;

Note: Sequence of defrosting actions:

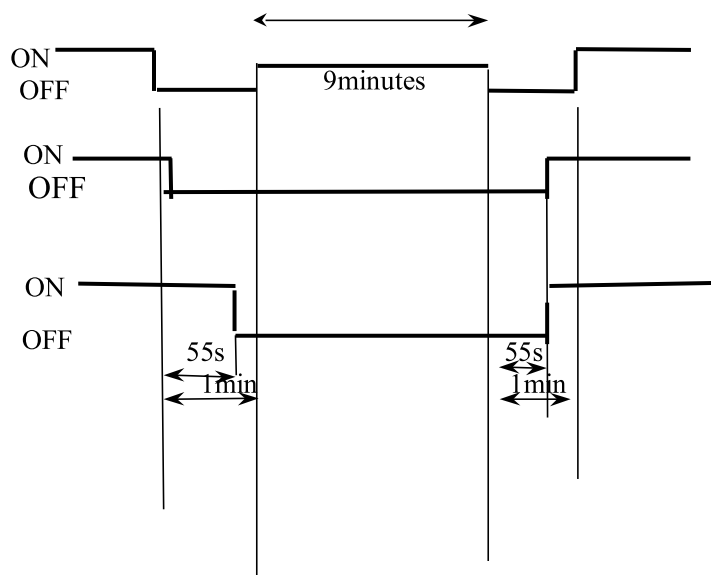

1.7 Freezing prevention function

Under refrigerating and dehumidifying state, the air conditioner will control the outdoor fan as per the temperature T_p of the indoor coil pipe according to the following conditions:

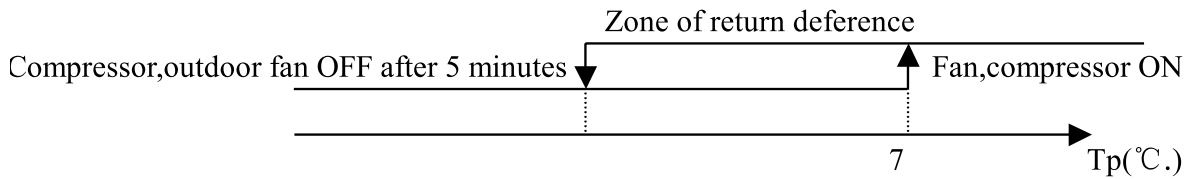

1.8 3 minutes stand-by time

When the compressor ceases due to the sensor OFF, unit On or OFF or fault, it will maintain pause for 3 minutes.

1.9 Overload protection during heating running

Temperature protection of indoor coil pipe: Under heating state, the air conditioner will control the running of the fan as per the temperature T_p of the indoor coil pipe and according to the following conditions:

- $56°C \leq T_p$, outdoor fan ceases; $T_p \leq 52°C$, outdoor fan resumes; the time from ceasing to resuming is about 45 seconds;
- $72°C \leq T_p$, outdoor fan of compressor ceases after 5 seconds; $T_p \leq 64°C$, compressor resumes after 3 minutes.

1.10 Compensatory function of power failure

If the unit is suddenly off during running due to power failure, or closed for maintenance or troubleshooting, it will restart to run after the power resumes with the original condition before the unit is off

Note: 1. Function setting: Pressing the SLEEP button on the remote control unit for 10 times until hearing 4 sounds from the buzzer on the panel.

2. Memory content: Running mode, setting wind speed, setting temperature, sleep state, flap state.

3. Cancellation of function: Pressing the SLEEP button on the remote control unit for 10 times until hearing 2 sounds from the buzzer on the panel.

1.11 Trial run function

When the air conditioner is in OFF state, press the emergency switch for 5 seconds till hearing 2 sounds of click from the buzzer, then the air conditioner will turn to the trial run state. The unit will run in the refrigerating mode and the indoor fan will run in high wind speed mode.

1.12 Emergency running mode

When the air conditioner is in stand-by state, press the emergency switch till hearing a sound from the buzzer, then the air conditioner will turn to the emergency run state. The rules of emergency run are as follows:

- a. $T_r > 23^{\circ}\text{C}$, running refrigerating mode, $T_s = 26^{\circ}\text{C}$;
- b. $T_r \leq 23^{\circ}\text{C}$, running heating mode, $T_s = 2^{\circ}\text{C}$.

1.13 Temperature compensation

There is the function of automatic temperature compensation when heating, with heating temperature setting = $T_s(\text{remote setting}) + 4^{\circ}\text{C}$.

1.14 Sleeping function

- a. After setting the sleeping function, the refrigerating mode and dehumidification mode will run as per the following rules:

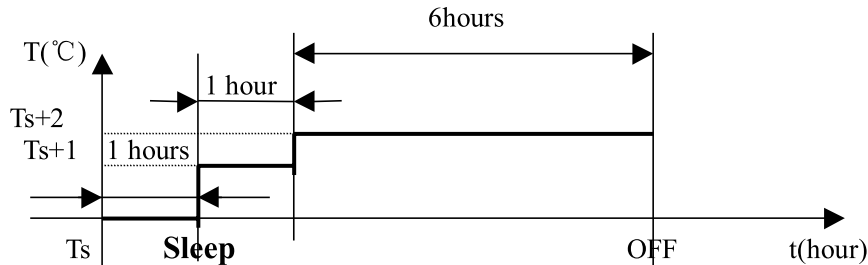

- b. After setting the sleeping function, the heating mode will run as per the following rules:

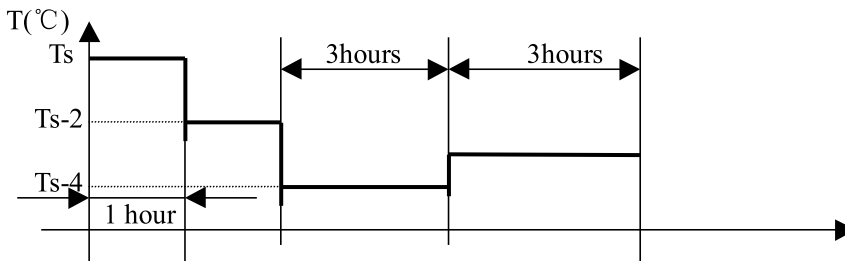

As shown in the above diagram, after running for 1 hour under refrigerating mode and dehumidification mode, the setting temperature will increase 1°C ; after another 1 hour, it will increase 1°C again, and after 6 hours, it will cease; after running for 1 hour under heating mode, the setting temperature will decrease 2°C , after another 1 hour, it will decrease the 2°C again, and after 3 hours, it will increase 1°C , and after other 3 hours, it will cease.

1.15 Trouble displaying method





- a. The temperature sensor of coil pipe of indoor unit is in short circuit or broken circuit: the timing indicator of indoor unit is on, the power indicator is flickered in 1 Hz;
- b. The room temperature sensor of indoor unit is in short circuit or broken circuit: the timing indicator of indoor unit is off, the power indicator is flickered in 1 Hz;

c. The motor of indoor unit has no backfeed of signal, the power indicator of indoor unit and running indicator are flickered twice, then the power indicator, running indicator and timing indicator are all flickered for 1 second, then repeating the cycle.

TROUBLE SHOOTING

Trouble Shooting

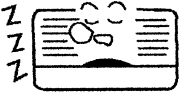
Before asking for service, check the following first.

	Phenomenon	Cause or check points
Normal Performance inspection	The system does not restart immediately. 	<ul style="list-style-type: none"> • When unit is stopped, it won't restart immediately until 3 minutes have elapsed to protect the system. • When the electric plug is pulled out and reinserted, the protection circuit will work for 3 minutes to protect the air conditioner.
	Noise is heard. 	<ul style="list-style-type: none"> • During unit operation or at stop, a swishing or gurgling noise may be heard. At first 2-3 minutes after unit start, this noise is more noticeable. (This noise is generated by refrigerant flowing in the system.) • During unit operation, a cracking noise may be heard. This noise is generated by the casing expanding or shrinking because of temperature changes. • Should there be a big noise from air flow in unit operation, air filter may be too dirty.
	Smells are generated.	<ul style="list-style-type: none"> • This is because the system circulates smells from the interior air such as the smell of furniture, cigarettes.
	Mist or steam are blown out. 	<ul style="list-style-type: none"> • During COOL or DRY operation, indoor unit may blow out mist. This is due to the sudden cooling of indoor air.
Multiple check	Does not work at all. 	<ul style="list-style-type: none"> • Is power plug inserted? • Is there a power failure? • Is fuse blown out?
	Poor cooling 	<ul style="list-style-type: none"> • Is the air filter dirty? Normally it should be cleaned every 15 days. • Are there any obstacles before inlet and outlet? • Is temperature set correctly? • Are there some doors or windows left open? • Is there any direct sunlight through the window during the cooling operation?(Use curtain) • Are there too much heat sources or too many people in the room during cooling operation?

Application temp. range of air conditioner -7°C~43°C.

For the abnormal phenomenon occurred, please conduct trouble analysis and troubleshooting according to the following table:

No	Reason of trouble	Phenomena	Remarks
1	The sensor of indoor ambient temperature is in short circuit or broken circuit	The compressor indicator and timing indicator extinguish, and the running indicator flickers	
2	The temperature sensor of indoor coil pipe is in short circuit or broken circuit	The compressor indicator and timing indicator are on, and the running indicator flickers	
3	The indoor motor is damaged or the computer board is damaged	The power indicator and running indicator of indoor unit flicker twice, the power indicator, running indicator and timing indicator flicker together for 1 second, then repeating the cycle.	The motor has no signal feedback of Hall unit

Free Manuals Download Website

<http://myh66.com>

<http://usermanuals.us>

<http://www.somanuals.com>

<http://www.4manuals.cc>

<http://www.manual-lib.com>

<http://www.404manual.com>

<http://www.luxmanual.com>

<http://aubethermostatmanual.com>

Golf course search by state

<http://golfingnear.com>

Email search by domain

<http://emailbydomain.com>

Auto manuals search

<http://auto.somanuals.com>

TV manuals search

<http://tv.somanuals.com>