

Haier

What The World Comes Home To™

**Room Air Conditioner
Electronic Control**
Climatisation de Pièce
à Commande Electronique
Acondicionador De Aire
Control Electrónico

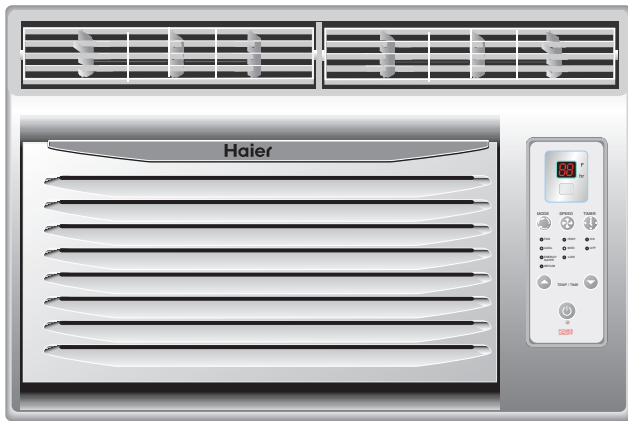

HWR08XC7,ESA3067,ESA3087

User Manual
Manuel d'utilisation
Manual del Usuario



(ESA3067/ESA3087 Only)

*Read instructions before installing.
Call 1-877-337-3639 for questions on parts and services.*

*Lire les instructions avant de procéder à l'installation.
Pour toutes questions concernant les pièces et l'entretien, composez le 1-877-337-3639.*

*Lea las Instrucciones antes de instalar el aparato
Llámenos al 1-877- 337-3639 si tiene preguntas sobre repuestos o servicios*

0010561822

A Word From Haier

Thank you for buying a dependable, energy-saving and easy-to-operate HAIER room air conditioner. This manual contains useful information for you to maintain, operate, install and safely use your room air conditioner. Your air conditioner cleans, cools and dehumidifies the air in your room to provide you with the ultimate level of comfort.

Please read instructions carefully before using the product. Also, do not forget to fill out and mail the **Product Registration Card**.

Product Registration

Record Your Model and Serial Number.

For all your service calls during the warranty period, the following information will be needed. Attach the sales receipt to this guide and keep for future reference. This information can be obtained from the serial plate, which is on your air conditioner. This is either on the cabinet (side or back), or you may have to remove the front grille to locate it.

Model Number:





Serial Number:

Date of Purchase:

Dealer's Name:

Dealer's Address:

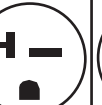
Dealer's Phone Number:

TABLE					
RECEPTACLE AND FUSE TYPES					
RATED VOLTS	125/60		250/60		
AMPS	15	20	15	20	30
WALL OUTLET					
FUSE SIZE	15	20*	15	20*	30
TIME DELAY FUSE (or circuit breaker)	Plug	Plug	Plug		

SAFETY PRECAUTIONS

WARNING: *Following these basic precautions will reduce the risk of fire, electrical shock, injury or death when using your air conditioner.*







- 1) The air conditioner must be connected to a proper electrical outlet with the correct electrical supply. (see table)
-  2) Proper grounding must be ensured to reduce the risk of shock and fire. **DO NOT CUT OR REMOVE THE GROUNDING PRONG.** If you do not have a three-prong electric receptacle outlet in the wall, have a certified electrician install the proper receptacle. The wall receptacle **MUST** be properly grounded.
-  3) Do not use if the power cord is frayed or otherwise damaged. Also, avoid using it if there are cracks or abrasion damage along the length, plug or connector.
-  4) **DO NOT USE AN ADAPTER OR AN EXTENSION CORD.**
-  5) When installing your air conditioner in a window, make sure the window is strong enough to hold the weight of the air conditioner. You also want to secure and install your air conditioner properly to prevent it from falling. Extra brackets and/or support may be required depending on your window.
- 6) Do not block the airflow inside or outside the air conditioner with blinds, drapes, protective covers, shrubs or bushes.
- 7) Be careful of sharp edges on the front and rear fins of the unit that could cut and cause serious injury.
- 8) Be careful when lifting the air conditioner to install or remove the unit. Always use two or more people for this.
- 9) Always unplug the air conditioner before servicing it or moving it.

Table Of Contents

	PAGE
A Word From Haier	1
Product Registration	1
Safety Precautions	2
Warnings	4
Electrical Safety	4
Tips	5
Energy Saving Guide	5
Features	6-7
Operating Guide	8-12
Normal Operating Sounds	8
Operating Instructions	8-12
Installations	13-17
Parts Supplied	14
Tools	14
Steps for Installation	15-17
Clean and Care Guide	18-19
Troubleshooting	19-20
Warranty Information	21

WARNINGS



Following the safety messages is very important.

These messages can save you from being injured or killed.

Warning symbols alert you to be careful and mean **Danger**. Always follow instructions to be safe and reduce chances of injury or death.

Warning and **Danger** signs will precede safety messages.

Electrical Safety



Grounding: This room air conditioner must be grounded. Grounding reduces the risk of electric shock by providing an escape wire for the electric current. The power cord has a grounding wire with a grounding plug. Plug it into an outlet that is properly installed and grounded.

WARNING: Improper use of the grounding plug can result in a risk of electric shock. Call a qualified electrician if you don't understand the grounding instructions, or if you are not sure if the air conditioner is properly grounded. If the wall outlet is not grounded, please contact an electrician to have it replaced with a properly grounded outlet.

Do not, under any circumstances, cut or remove the third (ground) prong from the power cord.

Adapter Plug: We strongly advise against using an adapter plug.

Important: Test power plug before each use:

1. Press "reset" button.
2. Press "test" button. Unit should trip.
3. Press "reset" button again for use.

Do not use if above test fails.

If this device trips, the cause of the malfunction must be corrected before further use of the device.

Tips

- This air conditioner is designed for use in a double hung window.
- While installing unit be sure to tilt air conditioner 5 degrees outward to have the water drip outside the house.
- Install the unit on the north side, as that is normally the shaded side. This will enhance the operation of your unit.
- ⚠ • The window has to be strong for installation. Extra brackets and/or support may be required depending on your window. (Brackets and supports not included in all models.)
- Measure the window before installing. If the window is too big for the unit you may require professional installation.
- ⚠ • Use the correct electric voltage and proper ampere for the unit to run effectively.
- ⚠ • Only let a certified electrician modify your electrical outlet.
- Use a dedicated line for the operation of your air conditioner to avoid the possibility of an electrical surge.

Energy Saving Guide

- When installing your air conditioner, make sure to seal all areas where there is a possibility of air leakage.
- The airflow should not be blocked, either inside by curtains, drapes or furniture, or outside by shrubs or bushes.
- Do not needlessly use an electrical light or other appliances that produce heat.
- Keep the blinds and drapes drawn on all other windows.
- While cooking, use an exhaust fan in the kitchen to remove the excess heat.
- Always use the correct BTU size air conditioner to cool the room to attain optimum efficiency.

Features

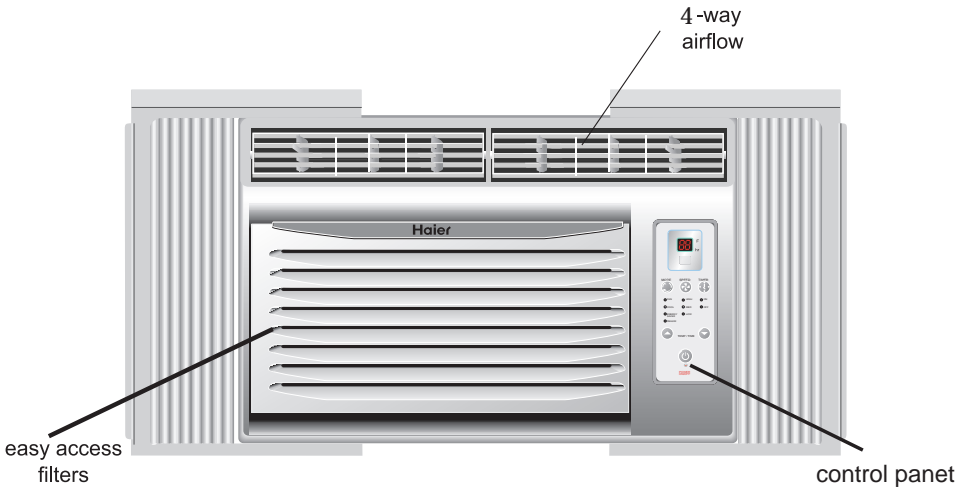

MODEL:HWR08XC7,ESA3067,ESA3087

1. Thermostat

This allows you to adjust the temperature of the air--the lower the setting, the cooler the air temperature. With this you can set the temperature to your desired comfort level. You can set the temperature between 61°F and 86°F.

2. Fan Speed

With this you can control the fan speed as well as the A/C (cooling) speed.

You have 3 levels of A/C Speed to set at your desired level. LO will circulate air at the lowest velocity, MED at medium velocity and HIGH will circulate at the maximum velocity. You have 3 levels of Fan Speed to set at your desired comfort level: HIGH, MED and LOW.

3. Function

Your air conditioner has 4 Functions.

a) COOL

Here the air conditioner will operate the compressor and the desired fan speed set to give you cold air for your comfort.

b) FAN

You can run the fan without the AC function on cooler days. The fan can be set to run at 3

speeds as desired.

c) DEHUMIDIFY

This enables your air conditioner to operate as a dehumidifier as well. It will remove the excess moisture from the air to keep your room at a comfortable, dry stage. You can use this feature alone in case you do not wish to use the air conditioner.

d) ENERGY SAVER

When this feature is "On", the fan will shut off three minutes after the compressor cycles off. This will reduce energy consumption and noise. When the compressor turns back on, the fan will turn on at the same time. In the "Off" position, the fan will not shut off when the compressor cycles off.

4. Timer

Your air conditioner can be set to go on or off at your desire. This can be programmed up to 24 hours in advance.

5. 4-Way Air Flow

The air directional louvers let you control the direction of the airflow to the desired direction. The airflow can be directed up-down-right side-left side.

6. Window Install Kit

This kit enables you to install the air conditioner in a double hung window. Extra brackets or support may be needed, depending on your window.

7. Remote Control

This fully functional wireless remote allows you to operate your air conditioner from a distance. You need not get up to change the settings or the functions, or to turn the unit on or off.

8. LED Display Electronic Control Panel

The 4-function LED displays Room Temperature, Temperature Setting, Timer Setting and Time Remaining to Stop/Start the unit. Electronic Control Panel lets you set the temperature to the exact temperature you desire.

9. Electrostatic Filter (not all models)

Being constructed of high efficiency purifying substance, active carbon fabric, electrostatic fabric, electrostatic active carbon net and other

materials, this air conditioner purifies the air effectively. Its wavy structure increases the capability to filter dust and smoke effectively. Due to the retention of active carbon, it has a high purifying speed capable of strong airflow.

10. How The Unit Drains

On humid days with the air conditioner in use, moisture may collect on the pan or the bottom of the air conditioner. If the unit is positioned properly, the moisture will gather towards the back of the unit. This will not affect the operation of the unit and the moisture will evaporate in time. Occasionally the moisture will flow over the back of the pan, but this will not affect the operation of the unit. Never drill holes in the pan under any circumstance.

Operating Guide

Normal Operating Sounds

The following sounds are normally heard during the operation of an air conditioner.

- Cool airflow movement as dictated by the set fan speed.
- Water sounds. This is normal since your air conditioner also acts as a dehumidifier. Thus you will hear water sounds from water drops falling on the condenser.
- As the refrigerant flows through the inner sealed tubing, a rushing noise may be occur.
- Rattling or vibrating noises may be heard due to poor wall or window installation.
- High pitch compressor sound may be heard.

Operating Instructions

The following are the operating instructions of your electronic air conditioner.

Remote control and control panel operations

After installing your air conditioner, plug it into the proper electrical outlet in the wall. Now set the air conditioner at your comfort level. This fully functional wireless remote allows you to operate your air conditioner without having to get up and go to the unit. The full function feature allows you to change the settings and turn the unit on or off from the remote itself. This control pad works the same as the control pad on the air conditioner. (See Fig. #1)

Fig. # 1
Remote Control

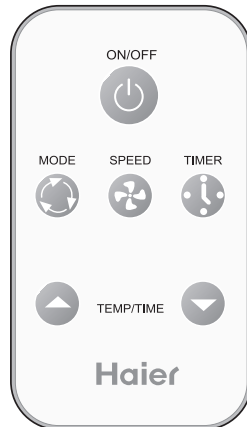

After you plug in the unit, it will perform a self test. All the display lights will turn on for 3 seconds. The LED display will read "88". If any display light fails to turn on you may need service on the unit. After 3 seconds, the unit will automatically go to the stand by mode. Now all lights will be off and you will have to turn "ON" by pressing the On/Off key. After pressing "On/Off", the unit starts to work and enters the status of "Fan" with the low setting. You will have to press the (▲) or (▼) key on the Temp/Time to set the temperature at your desired comfort. You can choose a temperature between 61°F and 86°F. Once the temperature is set you can raise or lower it by pressing the (▲) or (▼) keys. The temperature setting can only be adjusted when the unit is in cooling, energy saver, or dehumidifier. (See Fig. #2) Having set the temperature, you will set the function of the air conditioner.

Fig. # 2
Control Panel.

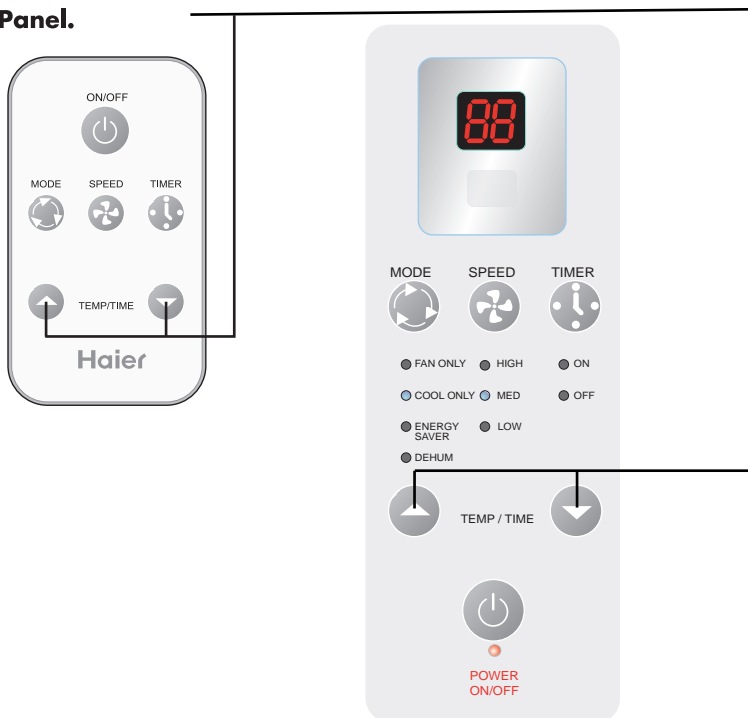

Every time you press the MODE button, it will change between FAN, COOL, ENERGY SAVER and DEHUM. (See fig. #3)

Fig. # 3

Control Panel.

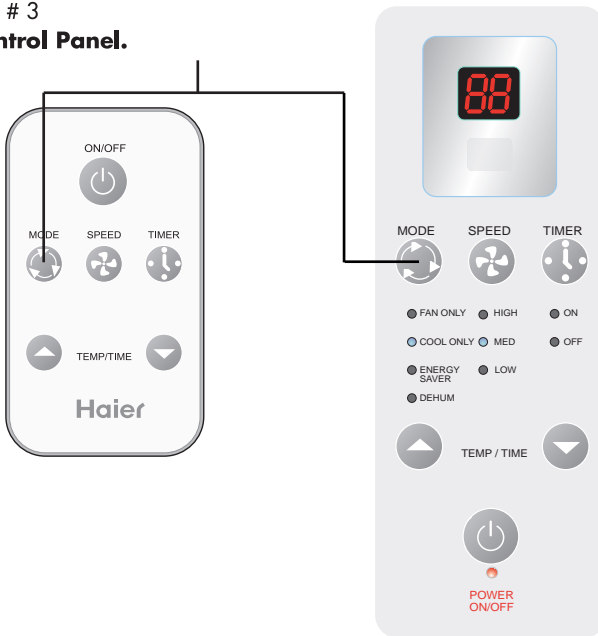

Once the mode function is established, you will have to set the fan speed. (See fig. #4) Every time you press the SPEED button, fan speed will change between LOW, MED, and HIGH.

1) If you choose the COOL mode you can run the fan in one of the 3 speeds: HIGH, MED, or LOW.

2) For cool days you may want to run the "FAN" function. Here the fan runs at one of 3 speeds (HIGH fan, MED fan, LOW fan) as desired by you.

3) The dehumidify function removes excess moisture from the air on excessively humid days.

Tr: temperature inside the room.

Ts: the set temperature.

1) When $Tr > Ts + 3^{\circ}F$, the compressor will run the fan continuously at the selected speed.

2) When $Ts - 1^{\circ}F < Tr < Ts + 3^{\circ}F$, the compressor will cycle for 10 minutes on and 6 minutes off.

3) When $Tr < Ts - 1^{\circ}F$, the compressor will shut off. The dehumidification process takes place between the set temperature-1 and $3^{\circ}F$ above the set temperature.

4) Energy Saver: The unit runs the same as the COOL setting in the ENERGY SAVER mode. But the fan will be off 3 minutes after the compressor cycles off.

Fig. # 4
Control Panel.

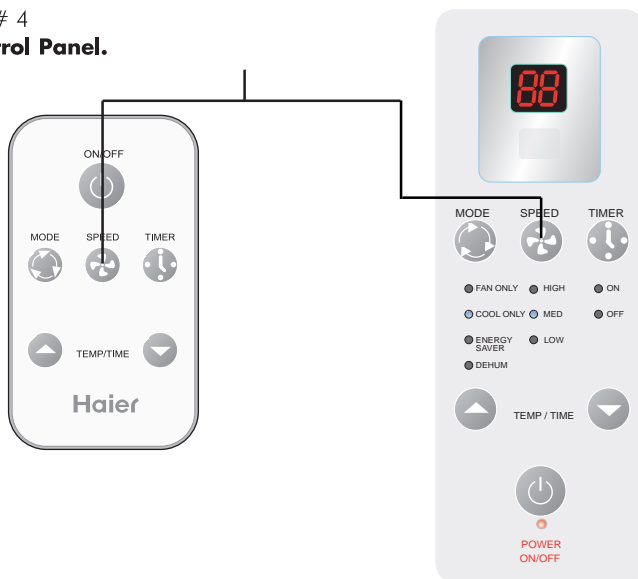

Timer On or Timer Off mode is used to pre-start or shut off your unit in advance. You can program this up to 24 hours in advance. You can use the Timer in 4 functions, i.e. COOL, ENERGY SAVER, DEHUMID or FAN.

● **Timer on** (See Fig. #5)

The unit must be on to set the timer. Unit will shut down automatically after it accepts the settings in 5 seconds. Use this mode to pre-set the start time of the unit 24 hours in advance.

a) Press **TIMER ON**. LED display will show "XX" (time set last time). When power is connected for the first time, LED display will show "01".

b) Set the desired number of hours by pressing the (▲) pad of the Temp/Time buttons, once for each hour. If you pass the desired time, use the (▼) pad key to lower the selection.

c) After you set **TIMER ON**, LED display will show the time. This time displayed means: the unit will start after X hours.

● **Timer off** (See Fig. #5)

The unit must be running to set time off. Use this to preset the time you would like the unit to shut off.

a) Press **TIMER OFF**. LED display will show "XX" (time set last time). When power is connected for the first time, LED display will show "01".

b) Set desired number by pressing the (▲) pad of the Temp/Time buttons, once for each hour. If you pass the desired time, use the (▼) pad key to lower the selection.

c) After you set **TIMER OFF**, LED display will show the room temperature about 5 seconds later. When using the timer, the unit will revert to the last COOL and FAN settings when activated. The timer must be reset every time you choose to use it.

Fig. # 5
Control Panel.

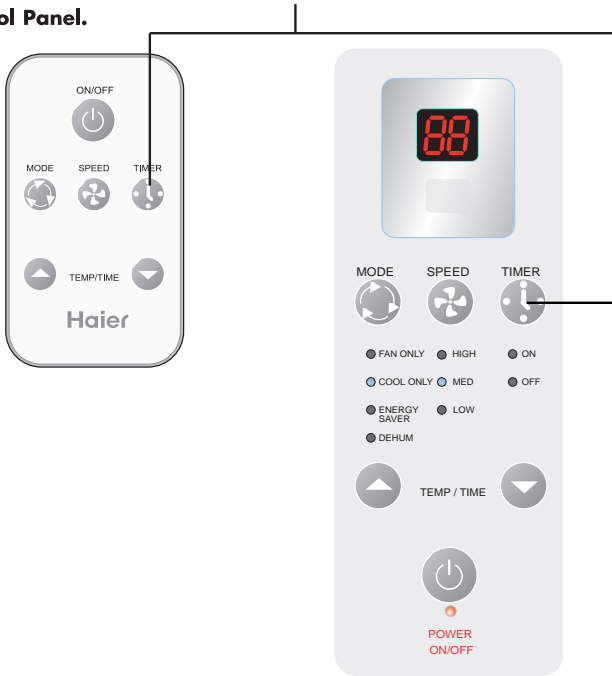

Adjusting the Air Flow Direction

Airflow can be adjusted by changing the direction of the air conditioner's louvers. This can also increase the cooling efficiency of the air conditioner.

Adjusting Horizontal Air Flow Direction

Adjusting the vertical louvers left and right will change horizontal airflow.

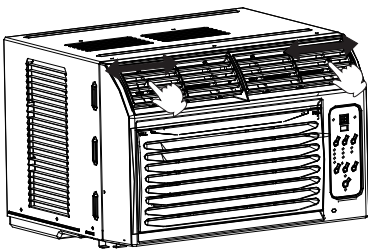

Adjusting Horizontal Air Flow

Adjusting Vertical Air Flow Direction

Adjusting the Horizontal vane up and down will change vertical airflow. The vane can be adjusted by nudging the back or up and down of the vane.

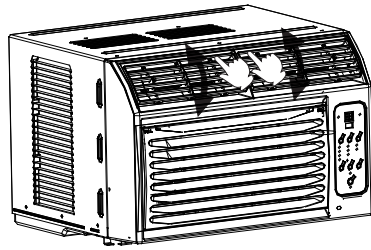

Adjusting Vertical Air Flow

Recommended orientation of louvers

Adjust louvers to face upwards when cooling to maximize cooling efficiency.

Installations

Before you install your air conditioner, check the following:

1) The unit is free of all obstructions inside and outside the room, e.g. drapes, curtains, furniture, plants, shrubs, bushes, trees, other structures like buildings, garage, etc.







The air conditioner must have a clear, unobstructed airflow through the condenser to remove heat.

2) The window is strong enough to hold the weight of the air conditioner. Extra brackets or supports may be needed depending on your windows. (Brackets or supports not provided in all models)

3) The windowsill and track are strong enough to hold the weight of the air conditioner.

4) The wall is strong enough to hold the unit. Extra brackets or supports may be needed depending on the wall. (Brackets or supports not provided in all models)

5) There is adequate and proper power supply near the air conditioner.

-  6) DO NOT use adapter plugs.
-  7) DO NOT use extension cords.
-  8) DO NOT cut or remove the ground prong.
-  9) DO NOT modify the plug or the electrical wall outlet in any way. If plug does not fit the electrical outlet have a certified electrician do the necessary change.
-  10) DO NOT connect electrical power to the unit before installation.
-  11) DO NOT use if power cord is worn out, frayed or otherwise damaged. Avoid using if there are cracks or abrasion damage along the length, plug or connection.
-  12) Be careful of exposed sharp edges of the cabinet and sharp coils (fins) on the back of the unit that could cut and cause serious injury.

Parts

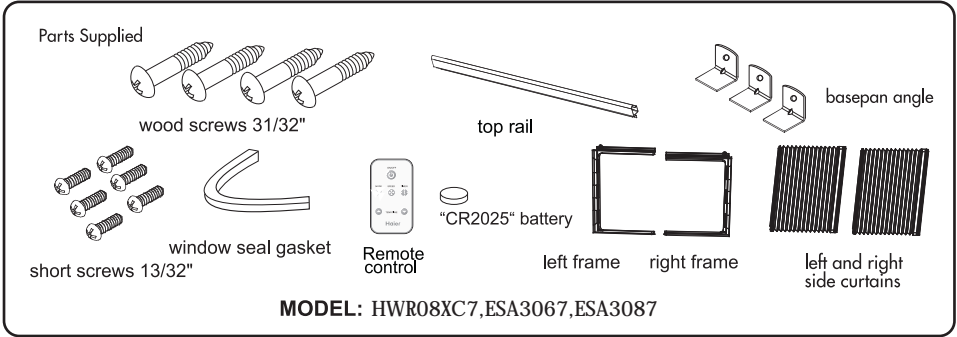

Tools

You will need to have the following tools to help you in the installation of your air conditioner.

- Scissors
- Phillips Screwdriver
- Standard Screwdriver
- Pliers
- Wrench
- Drill and Drill Bits
- Tape Measure
- Gloves
- Level
- Sockets

Installing Unit into A Window

Window Opening Requirements

The air conditioner is designed to fit into double or single hung sash type windows. Each of the units comes with an installation kit that provides adjustable mounting louvers to fill the gaps between the sides of the unit and the window frame. The chart below reflects the dimensions of the units with and without installation kits. Measure your window opening width and compare it to the chart below to ensure that it meets the minimum and maximum window width requirements.

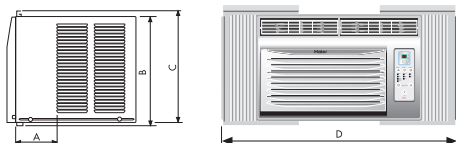

Model	HWR08XC7,ESA3067,ESA3087	
Dimension		
A(inch)		5 $\frac{3}{25}$ "
B(inch)		12 $\frac{2}{5}$ "
C(inch)		13 $\frac{2}{8}$ "
D(inch) Max		36 "
D(inch) Min		25 "
Case High		12 $\frac{7}{16}$ "
Case Width		18 $\frac{1}{2}$ "
Case Depth		12 $\frac{1}{4}$ "

1 ASSEMBLE CURTAINS/TOP RAIL

Install top rail with 3 short screws 13/32".

Place tabbed side of curtain in track on side of air conditioner cabinet, and slide down the track until the curtain is even on top and bottom.

Caution: Never expose plastic front or grille to extreme temperatures.

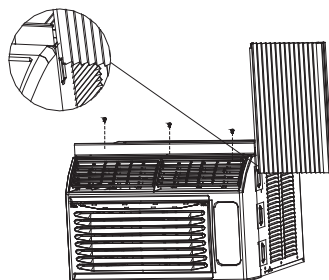
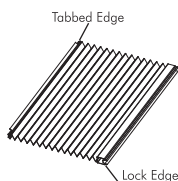

2 ASSEMBLE LEFT FRAME / RIGHT FRAME

Slide the left frame onto the air conditioner cabinet using the tracks on the top and bottom of the unit. Slide the frame as close to the air conditioner as possible so that the curtain locks into place. Gently pull the frame out until it is the correct length for your application.

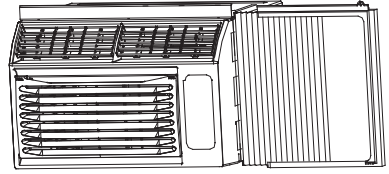

* Install the right curtains and frames in the same way

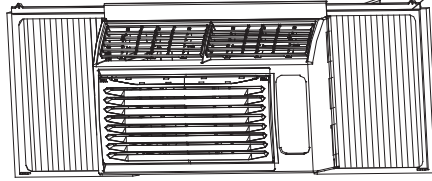

3 PREPARE WINDOW FOR INSTALLATION

1. This unit is designed for installation in standard double hung windows with actual opening widths of 25" to 36". The upper and lower sash must open sufficiently to allow a clear vertical opening of 14" from the bottom of the sash to the window stool.
2. If storm window presents interference, fasten a 2" wide wood strip (not included) (OUTER SILL) to the inner window sill across the full width of the sill. The wood strip should be thick enough to raise the height of the window sill so that the unit can be installed without interference by the storm window frame (STORM WINDOW FRAME) or wood strip (OUTDOORS) to help condensation to drain properly to the outside.
3. Install a second wood strip (approximately 6" long by 3/2" wide and same thickness as first strip) in the center of the outer sill flush against the back off the inner sill. This will raise basepan angle.
4. If the distance between STORM WINDOW FRAME and WOOD STRIP MOUNTED ON TOP OF INNER SILL is more than 1", two of wood strips are not necessary.

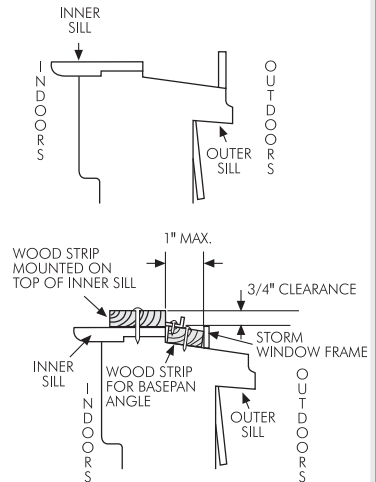

4 LOCATING UNIT IN WINDOW

Open the window and mark center line on the center of the inner sill.

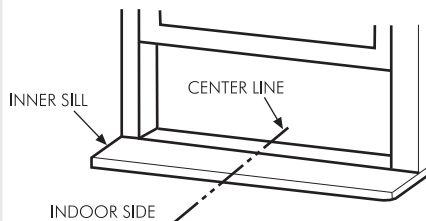

5 ATTACH BASEPAN ANGLE

Install the basepan angle behind the inner windowsill, with the short side of basepan angle as shown. Use the 2 short screws 13/32" provided.

The basepan angle helps to hold unit securely in place. Be sure to place basepan angle edge flush against back of inner sill.

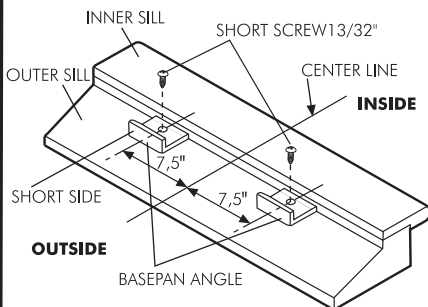

6 INSTALL THE AIR CONDITIONER IN THE WINDOW

Carefully lift the air conditioner and slide it into the open window. Make sure the bottom guide of the air conditioner drops into the notches of the basepan angle. While steadying the air conditioner, carefully bring the window sash down behind the upper guide of the air conditioner.

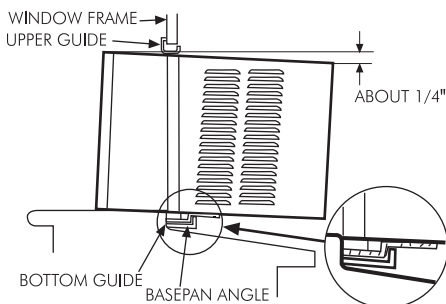

7 INSTALL THE SEAL GASKET AND SASH LOCK

Extend the side curtains to fill the window opening using 4 wood screws 31/32" to secure them.

Cut the seal gasket to the window width. Stuff the sash seal between the glass and the window to prevent air and insects from getting into the room. Fasten the basepan angle, using a short screw 13/32".

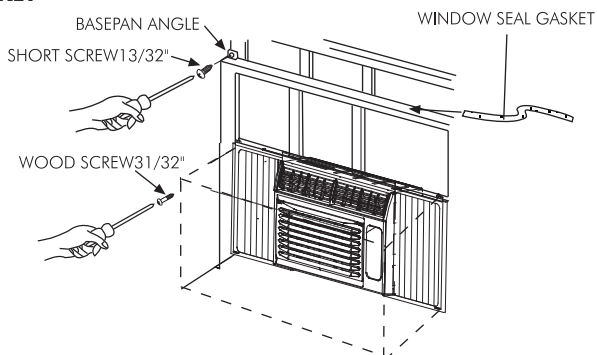

Care and Cleaning Guide

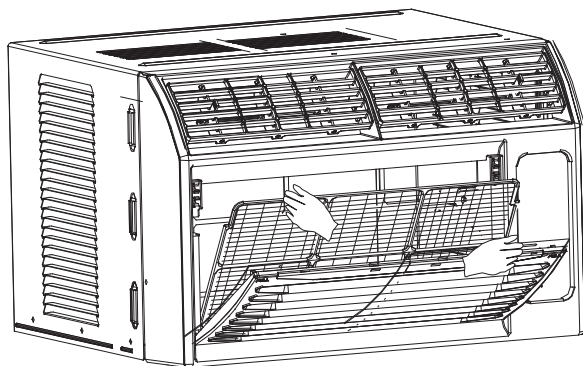

- **Always unplug your air conditioner before cleaning.**
- **The air filter behind the front grille should be checked and cleaned at least once every 2 weeks or more often if necessary.**

To remove:

1. Open the inlet grille downward by pulling out the top of the inlet grille.
2. Remove the air filter from the front grille assembly by pulling the air filter up slightly.
3. Clean the filter with warm, soapy water below 40°C(104°F).
4. Rinse and gently shake the water from the filter and let it dry before replacing it.

DO NOT use your air conditioner without the air filter in place.

- **To clean the front panels or the cabinet DO NOT use harsh chemicals, abrasives, ammonia, chlorine, bleach, concentrated detergents, solvents or metal scouring pads.**

Some of these chemicals may dissolve, damage and/or discolor your air conditioner.

- **Always use a soft cloth dampened with water or mild soap and water solution to wipe the front of the cabinet.**

Wipe dry with a soft cloth.

- To store your air conditioner, remove the unit from the window as per the installation guide. Repack the unit in its original box and store. If you do not intend to remove it from the window then cover the outside with a winter cover.
This can be purchased from the retailer where you purchased your air conditioner or from your local hardware store.
- Before putting away your unit make sure any water left in the pan is removed and drained away. Water left in the pan could lead to rusting or damage to the electrical connections.

Trouble-Shooting

If air conditioner does not operate:

- Check if unit is plugged in. The plug may have come loose.
- Check if the unit is in the "Off" mode.
- The fan control may be in the "Off" position.

Air from air conditioner is warm:

- The A/C setting may need to be raised.
- The temperature outside the room is below 65°F. The compressor will not cycle on if the temperature outside is below 65°F.

Ice formation on cooling coils:

- The outside temperature too cold. Set the unit on "fan only" setting to defrost ice.
- Lower temperature setting. The temperature setting may be too cold.
- The unit BTU may be too high for the room.

Air conditioner is working but room is not cooling:

- The room may have appliances that produce heat. Use an exhaust fan to remove excess heat.
- Redirect the airflow. Remove any obstacles.
- All doors and windows need to be closed so cool air does not escape the room.
- The air filter may need cleaning.
- The unit BTU may be too low for the required cooling area.
- On extreme hot & humid days , air conditioners may take a little longer to cool.

Air conditioner is making noise when cooling:

You may hear sounds of air movement, water, compressor clicking on and off or window vibrations. Please read Operating Guide – Normal Operating Sounds. (see page 8)

Water in the air conditioner cabinet:

This is normal , as your air conditioner not only cools but also dehumidifies the air. If there is water dripping inside the room, check the installation of the unit. The unit may need to be reinstalled. (see page 17)

Limited Warranty

What is covered and for how long?

This warranty covers all defects in workmanship or materials for a period of:

- 12 months for labor
- 12 months for parts (Functional Parts Only)
- 5 years for sealed system

The warranty commences on the date of item purchase. Customer shall provide Haier with proof of the date of purchase, brand, model and serial number for verification prior to any warranty service being provided.

EXCEPTIONS: Commercial or Rental Use warranty;

90 days for labor

90 days for parts

No other warranty applies.

What is covered/not covered?

1. The mechanical and electrical parts of the appliance which serve the functional purpose of this appliance are covered for a period of 12 months. This includes all parts except finish and trim.

2. Manufacturing defects to the components of the sealed system (e.g. hermetic compressor, condenser and evaporator) are covered for a period of 5 years from the date of purchase. Any damages to such components caused by mechanical abuse, improper handling or shipping will not be covered.

3. The limited warranty does not cover any credit or refund for any loss or injury caused by the product or defects to the product including but not limited to incidental or consequential damages.

What will be done?

1. Any mechanical or electrical part that proves to be defective in normal usage during the specified warranty period will be repaired or replaced at Haier's discretion.

A&E factory service is the authorized service provider for Haier.

If it is determined that repair is not appropriate or replacement part is unavailable for repair, Haier will exchange the product with a refurbished or new product the same as or similar to the original at its discretion.

2. There will be no charge to the purchaser for functional replacement parts and labor on any covered items during the initial 12-month period. Beyond this period, only the components of the sealed system are covered. Labor is not provided and must be paid for by the customer.

3. To have your product serviced, please contact Haier customer service at 1-877-337-3639.

THIS WARRANTY COVERS APPLIANCES WITHIN THE CONTINENTAL UNITED STATES, PUERTO RICO AND CANADA. IT DOES NOT COVER

THE FOLLOWING:

Damages from improper installation.
 Damages incurred during shipping.
 Defects other than manufacturing.
 Damage from misuse, abuse, accident, alteration, lack of proper care and maintenance or incorrect current or voltage.

Damage from other than household use.

Damage from service by other than an authorized dealer or service center.

Decorative trims or replaceable light bulbs.

Transportation and shipping.

Labor (after the initial 12 months).

Credit or Refund for products over 30 days past date of purchase

Food loss for food spoiled as a direct result of mechanical failure of the product or of any delay in providing service, repair, replacement. This limited warranty doesn't apply to refurbished product or unit purchased as/like new or second-hand.

THIS LIMITED WARRANTY IS GIVEN IN LIEU OF ALL OTHER WARRANTIES, EXPRESSED OR INCLUDING THE WARRANTIES OF MERCHANTABILITY AND FITNESS FOR A PARTICULAR PURPOSE.

The remedy provided in this warranty is exclusive and is granted in lieu of all other remedies.

This warranty does not cover incidental or consequential damages, so the above limitations may not apply to you. Some states do not allow limitations on how long an implied warranty lasts, so the above limitations may not apply to you.

This warranty gives you specific legal rights, and you may have other rights, which vary from state to state.

Haier America Trading L.L.C.
 New York, NY 10018.
 1-877-337-3639

Free Manuals Download Website

<http://myh66.com>

<http://usermanuals.us>

<http://www.somanuals.com>

<http://www.4manuals.cc>

<http://www.manual-lib.com>

<http://www.404manual.com>

<http://www.luxmanual.com>

<http://aubethermostatmanual.com>

Golf course search by state

<http://golfingnear.com>

Email search by domain

<http://emailbydomain.com>

Auto manuals search

<http://auto.somanuals.com>

TV manuals search

<http://tv.somanuals.com>