

Haier

LCD TV OWNER'S MANUAL

MODELS: L26A16

L32A16

L37A16

L42A16

L26A18

L32A18

L37A18

L42A18

Please READ this manual carefully before operating your TV, and retain it for future reference.

Haier

Haier

Haier

Congratulations on your purchase, and welcome to the "family"!

Dear Haier product owner:

Thank you for your confidence in Haier. You've selected one of the best-built, best-backed products available today. We'll do everything in our power to keep you happy with your purchase for many years to come.

As a member of the Haier "family," you're entitled to protection by one of the most comprehensive warranties and outstanding service networks in the industry.

Thanks for investing in a Haier product.

Warning



WARNING

**RISK OF ELECTRIC SHOCK
DO NOT OPEN**



WARNING : To reduce the risk of electric shock do not remove cover or back. No user-serviceable parts inside refer service to qualified service personnel.

Safety of operators has been taken into consideration at the design and manufacture phase, but in appropriate operation may cause electric shock or fire. To prevent the product from being damaged, the following rules should be observed for the installation, use and maintenance of the product. Read the following safety instruction before starting the operation.

The User Manual uses the following symbols to ensure a safe operation and prevent any damage to operators or properties:



This symbol indicates that high voltage is present inside. It is dangerous to make any kind of contact with any inside part of this product.



This symbol indicates that there are important operating and maintenance instructions in the literature accompanying the appliance.

Important Safety Instructions

Important safeguards for you and your new product

Your product has been manufactured and tested with your safety in mind. However, improper use can result in electrical shock or fire hazards. To avoid defeating the safeguards that have been built into your new product, please read and observe the following safety points when installing and using your new product, and save them for future reference.

1. **Retain these Instructions** ---the safety and operating instructions should be retained for Future reference.
2. **Heed Warnings** ---All warning on the appliance and in the operating instructions should be followed.
3. **Cleaning** --- Unplug from the wall outlet before cleaning. Do not use liquid cleaners or Aerosol cleaners. Use only dry cloth for cleaning.
4. **Attachments** ---do not use attachments not recommended by the manufacturer as they may cause Hazards.
5. **Water and moisture** -- do not place this product near water, for example, near a bathtub, wash bowl, kitchen sink, laundry tub, in a wet basement, or near a swimming pool.
6. Do not place this unit on an unstable cart, stand, tripod, bracket, or table. Use only with a cart, stand, tripod, bracket, or table recommend by the manufacture, or sold with the unit.
7. **Ventilation** ---Slots and openings in the cabinets and the back or bottom are provided for Ventilation and to ensure reliable operation of the product and to protect it from overheating, and these openings must not be blocked or covered. The openings should never be blocked by placing the product on a bed, sofa, rug, or other similar surface. This product should not be placed in a built-in installation such as a bookcase or rack unless proper ventilation is provided or the manufacturer's instructions have been adhered to.
8. **Power Source** ---this unit should be operated only from the type of power source indicated on the rating label. If you are not sure of the type of power supply to your home, consult your Appliance dealer or local power company.
9. **Grounding or polarization** ---Do not defeat the safety purpose of the polarized or grounding-type plug. A polarized plug has two blades with one wider than the other. A grounding type plug has two blades and a third grounding prong. The wide blade or the third prong are provided for your safety. If the provided plug does not fit into your outlet, consult an electrician for replacement of the obsolete outlet. To prevent electric shock, ensure the Grounding pin on the AC cord power plug is securely connected.
10. **Power cord protection** ---Power supply cords should be routed so that they are not likely to Be walked on or pinched by items placed upon or against them. Pay particular attention to cords or plugs, convenience receptacle, and the point where they exit from the appliance.
11. **Lighting precaution** ---for added protection for this product during a lighting storm or when it is left unattended for long period of time, unplug it from the wall outlet and disconnect the antenna or cable system. This will prevent damage to the product due to lighting and power line surges.
12. **Accessories**--- Never push objects of any kind into this product through openings as they may touch dangerous voltage point or short out parts that could result in a fire or electric shock. Avoid spilling liquid of any kind on the product.
13. **Servicing** ---do not attempt to service the product by yourself, as opening or removing covers may expose you to dangerous voltage or other hazards. Refer all servicing to authorized service personnel.
14. **Damage Requiring Service** ---Unplug this unit from the wall outlet and refer servicing to qualified service personnel under the Following conditions:

PORTABLE CARTWARNING
(symbol provided by RETAC)



S3126A

Important Safety Instructions

- a. When the power supply cord or plug is damaged or frayed.
 - b. If liquid has been spilled, or objects have been fallen into the unit.
 - c. If the unit has been exposed to rain or water.
 - d. If the unit does not operate normally by following the operating instructions. Adjust only those controls that are covered by the operating instructions, as improper adjustment of other controls may result in damage and will often require extensive work by a qualified technician to restore the unit to its normal operation.
 - e. If the unit has been dropped or damaged in any way.
 - f. When the unit exhibits a distinct change in performance; this indicates a need for service.
15. **Heat** --- The product should be situated away heat source such as radiators, heat registers, stoves, or other products (Including amplifiers) that product heat.
16. **Overloading** ---Do not overload wall outlets and extension cord as this can result in a risk of Fire or Electric shock.
17. **Outdoor antenna grounding**---If an outside antenna or cable system is connected to the unit, be sure the antenna or cable system is grounded to provide some protection against voltage surges and built-up static charges, Section 810 of the National Electrical Code, ANSI/NFPA 70, provides information with respect to proper grounding of the mast and supporting structure, grounding of the lead-in wire to an antenna discharge unit, size of grounding conductors, location of antenna discharge unit, connection to grounding electrodes, and requirements for the grounding electrode.

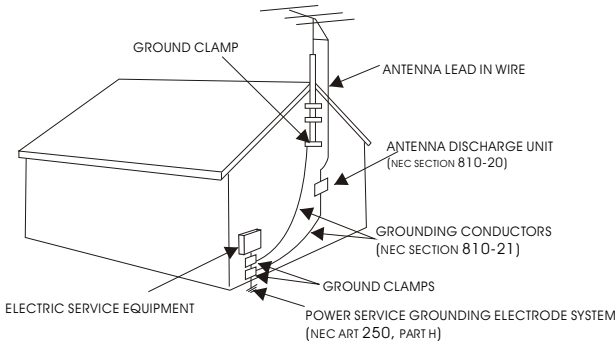

Table of Contents

| | | | |
|--|----|-----------------------------------|----|
| Warning | 1 | Picture Adjustment | 22 |
| Important Safety Instructions..... | 2 | Sound Adjustment..... | 23 |
| Buttons and interface location..... | 5 | Time setting..... | 25 |
| Front control panel..... | 5 | Function menu..... | 26 |
| Rear control panel..... | 6 | Adjust menu | 27 |
| Remote controller..... | 7 | Lock setup..... | 29 |
| Keys of remote controller..... | 8 | Other functions..... | 31 |
| Function introduction | 8 | Teletext functions..... | 32 |
| Effective range | 9 | Maintenance..... | 34 |
| External Equipment Connections | 10 | Specifications and functions..... | 35 |
| Operation | | Troubleshooting..... | 36 |
| Set up your TV..... | 15 | | |
| Switching ON/OFF the TV set..... | 15 | | |
| Choose the Menu Language..... | 15 | | |
| Choose the Input Source..... | 15 | | |
| Tuning menu..... | 16 | | |
| Auto search..... | 16 | | |
| Manual search..... | 17 | | |
| AFT (Auto Fine Tuning)..... | 17 | | |
| Program Table | 18 | | |
| Edit Name..... | 19 | | |
| Skip..... | 20 | | |
| Program swap..... | 20 | | |
| How to select the desired program..... | 21 | | |

Accessories



Remote controller



User's manual



Alkaline battery(AA)×2



Power cable

Buttons and interface location

- This is a simplified representation of front panel.
- Here shown may be somewhat different from your TV.

Front control panel

L26A18, L26A16, L32A18, L32A16

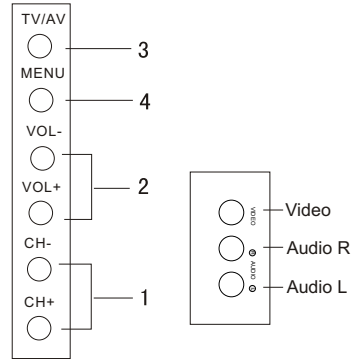
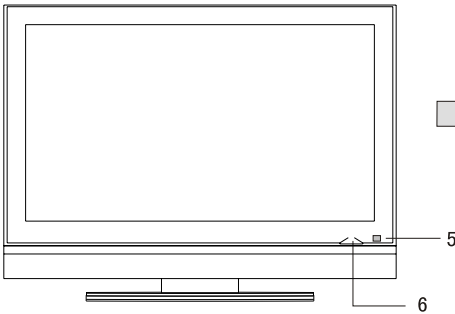

L37A18, L37A16, L42A18, L42A16

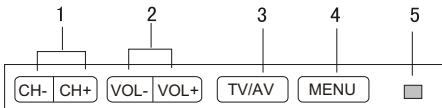

1. CH+/- : program minus and plus, menu options.
2. VOL+/-: volume decrease and increase, menu reset and entry.
3. TV/AV: all input source display.
4. MENU: menu display.
5. Remote control signal receive window.
6. POWER and indicator : Is used to activate the display or return to standby mode.

Buttons and interface location

Rear Control panel

L26A18, L26A16, L32A18, L32A16

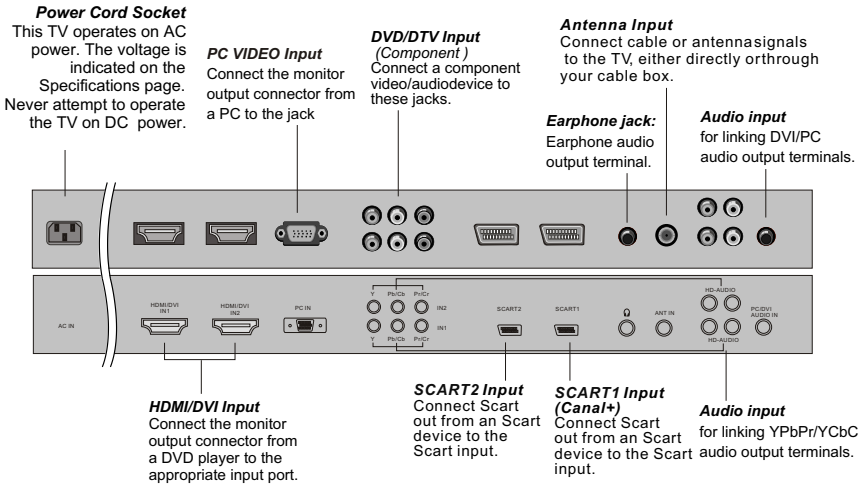

L37A18, L37A16, L42A18, L42A16

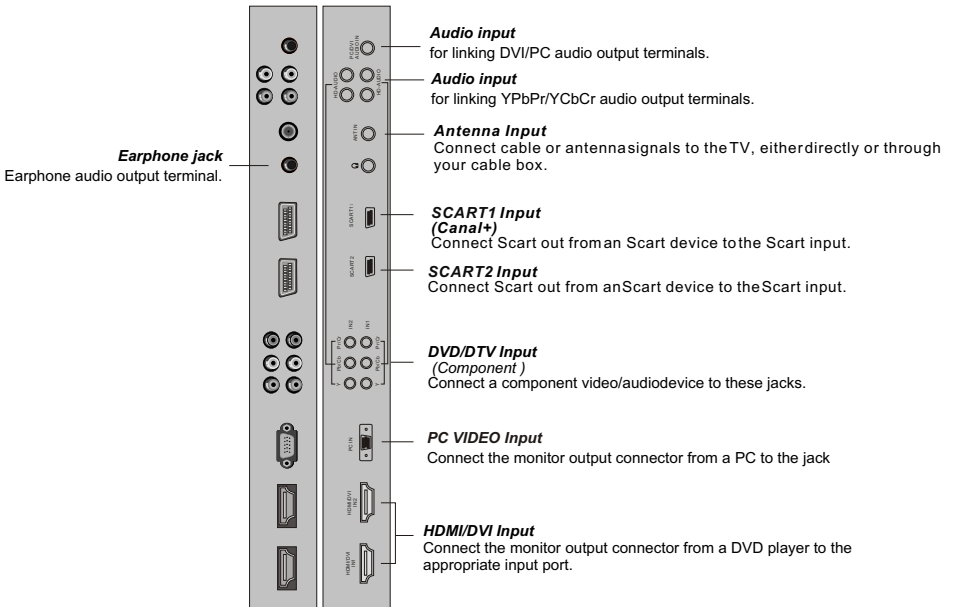

Remote control

Inserting Batteries

1. Slide open the cover of the battery compartment on the back of the remote controller.

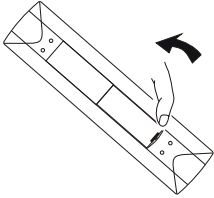

2. Load two AA alkaline batteries in the compartment, paying attention to the polarity diagram in the battery compartment. (plus and minus poles to respective mark)

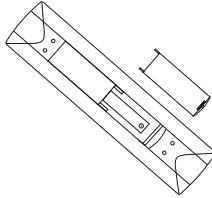

3. Replace the cover of the battery compartment.

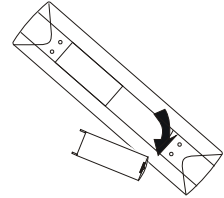

Precautions

As strong light may interfere the signals, change your position to operate the remote controller if the television cannot be turned on or off as you expect.



Make sure that two AA alkaline batteries are loaded. The batteries must be of the same type. The batteries must be located properly. The batteries are not rechargeable.

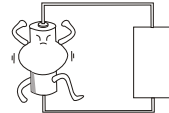

Keep the remote controller away from heat source or humid area to ensure effective performance of the remote controller.

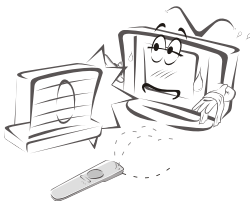

Make sure that there is no obstacle between the remote controller and television set.

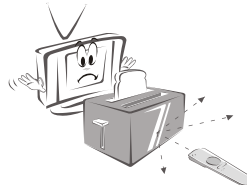

Keys of remote control

- The remote controller cannot be operated unless the batteries are properly loaded.
- When using the remote control, aim it at the remote control sensor on the TV.

Function introduction

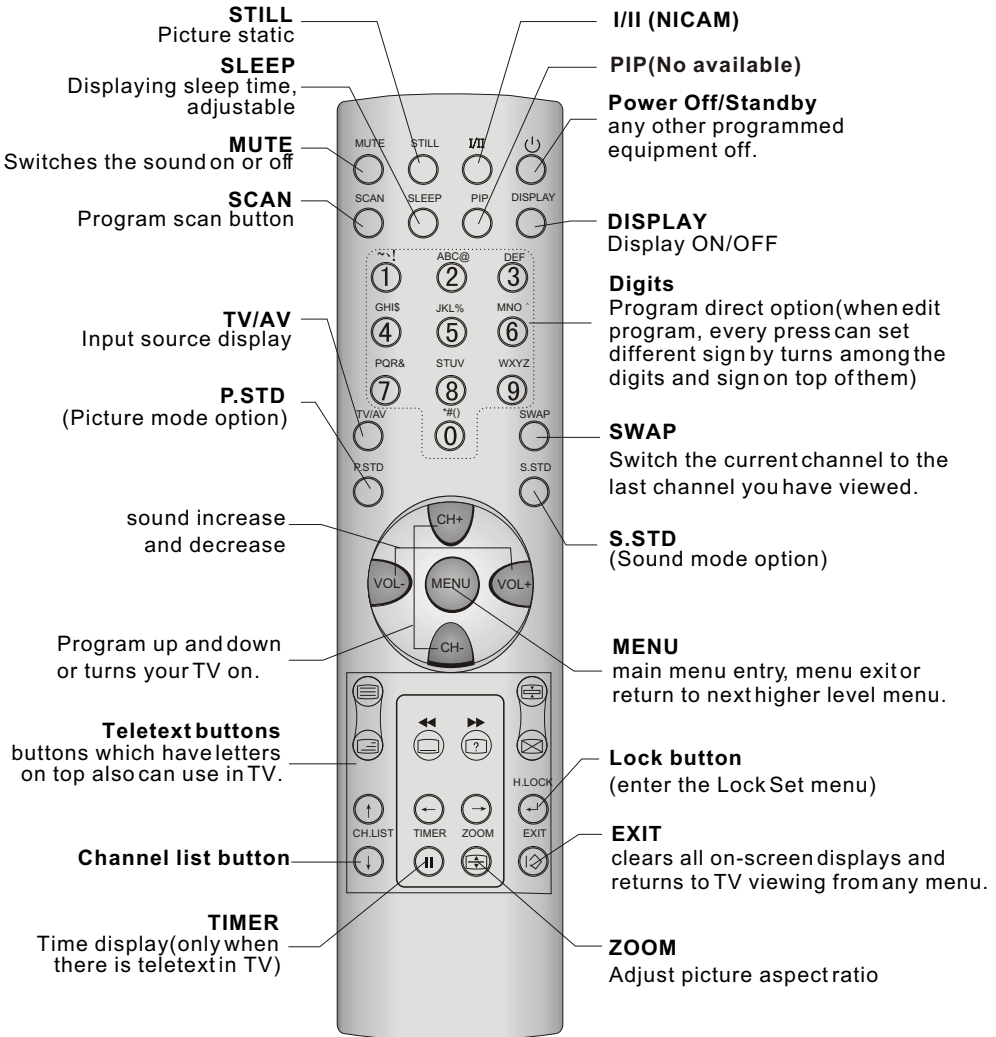

Note:

This User's Manual covers the functions of the remote controller, including CH+/-, VOL-/+ , MENU, TV/AV and POWER keys for control of program up, program down, volume decrease, volume increase, menu, TV/AV and power ON/OFF.

Remote control

Effective range

-Here shows may be somewhat different from your TV, is only the graphic solution, please take material objects as.

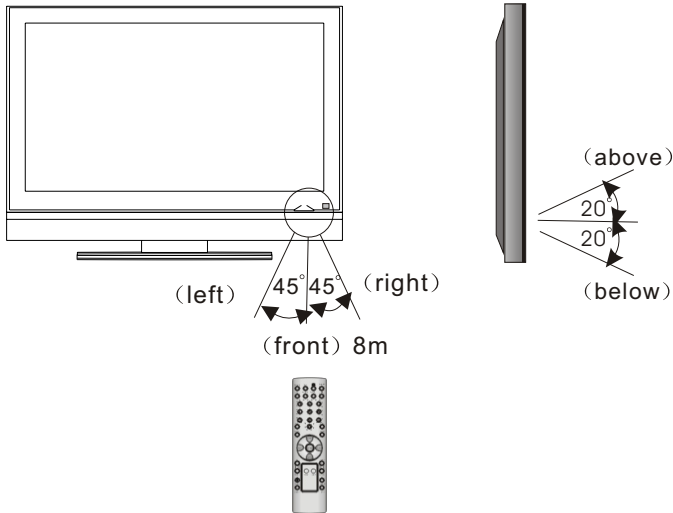

- Ensure the remote control is pointed toward the remote control window on the display.
- No obstacles should be placed between the remote control and the remote control window.
- The effective receiving scope for the signal is 8 meters to the front of the remote control window, and 45° to the left or right side and 20° above or below the control window.

Use of remote control:

1. To ensure a normal operation, the remote controller should not be dropped or damaged in any way .
It should also be kept dry and away from all heat sources.
2. Battery replacement is necessary when the remote control acts inconsistently or stops operating the LCD display.

External Equipment Connections

Antenna Connection

Generally speaking, to enjoy a clearer picture, we recommend that you use a CATV system or an outdoor antenna. In different places, the suitable antenna type and position are different.

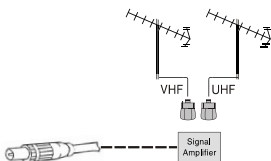
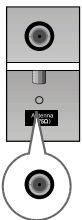
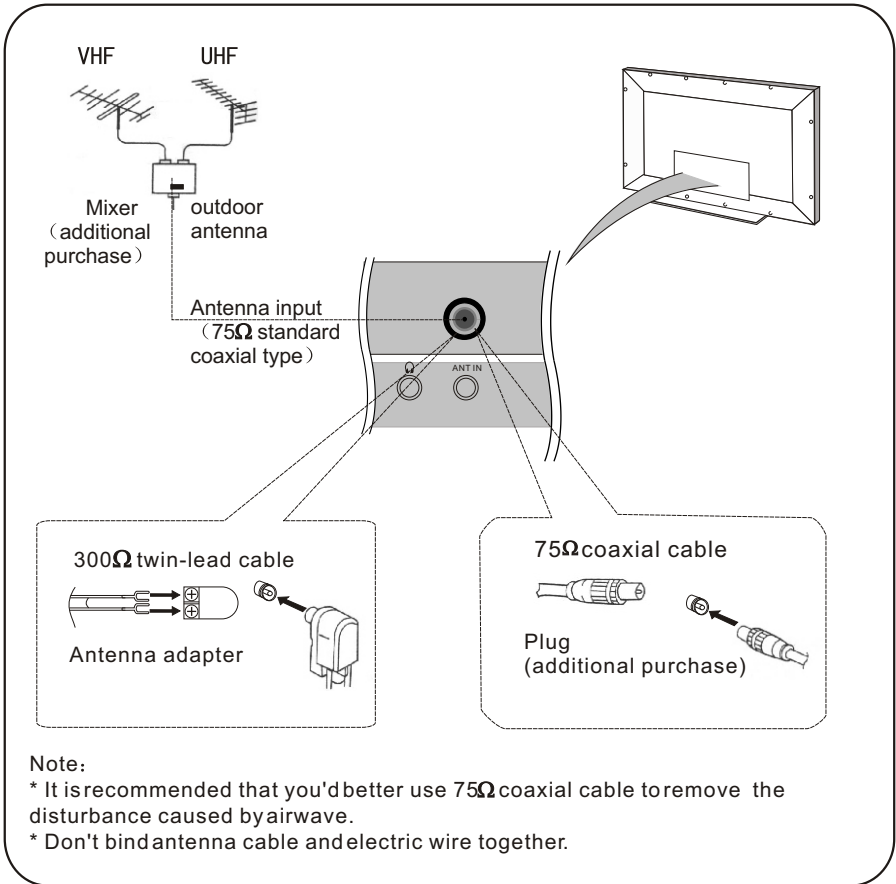

- If the antenna needs to be split for two Tv's, install a "2-Way Signal Splitter" in the connections.
- If the antenna is not installed properly, contact your dealer for assistance.
- To improve picture quality in a poor signal area, purchase and install a signal amplifier.

External Equipment Connection

NOTE: All cables shown are not included with the TV.

Choose Your Connection

There are several ways to connect your television, depending on the components you want to connect and the quality of the signal you want to achieve. The following are examples of some ways to connect your TV.

Choose the connection which is best for you.

VCR connection

- To avoid picture noise (interference), leave an adequate distance between the VCR and TV.

1. Connect the SCART cables from the VCR's output jacks to the TV's input jacks, as shown in the figure.

2. Insert a video tape into the VCR and press PLAY on the VCR. (Refer to the VCR owner's manual.)

3. Select the input source by the TV/AV button on the remote control.

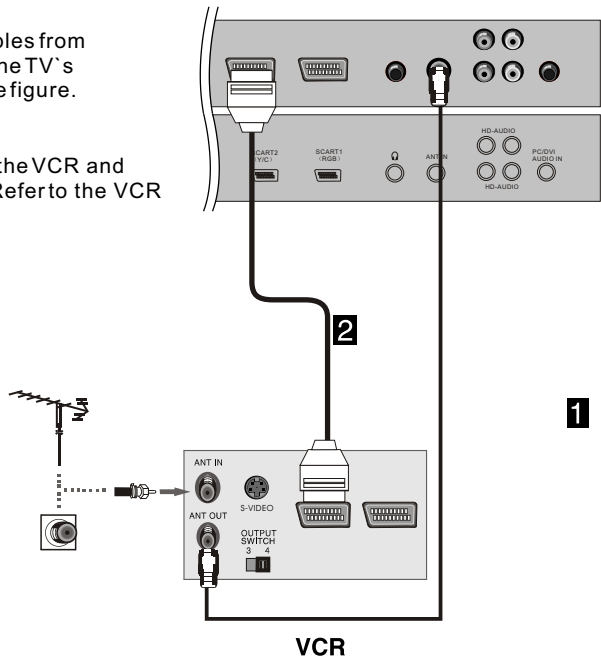

External Equipment Connections

DVD connection

How to connect

1. Connect the DVD video outputs (Y, Pb/Cb, Pr/Cr) to the HDTV IN jacks on the TV and connect the DVD audio outputs to the HD-AUDIO jacks on the TV, as shown in the figure.
2. If your DVD only has an SCART output jack, connect this to the SCART input on the TV, as shown in the figure.

How to use

1. Turn on the DVD player, insert a DVD.
2. Use the TV/AV and VOL +/- button on the remote control to select SCART 1 or SCART 2 mode.
3. Press Play button on external equipment for program play.
4. Refer to the DVD player's manual for operating instructions.

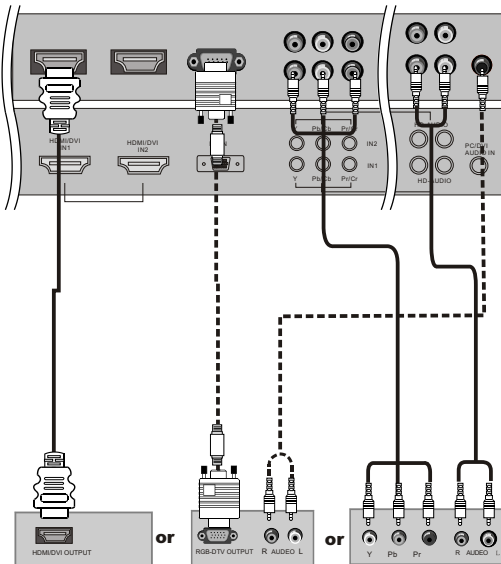
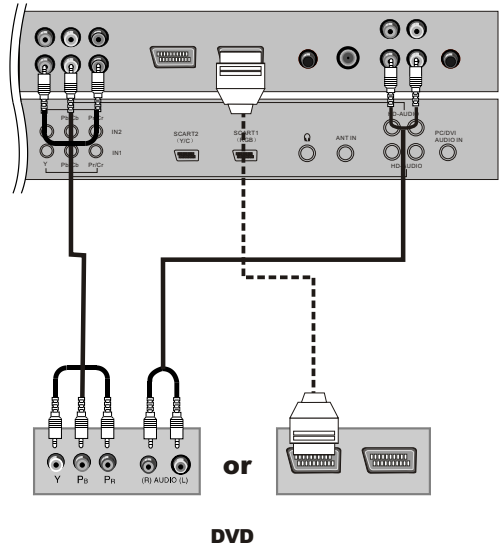

DTV connection

-To watch digitally broadcast programs, purchase and connect a digital set-top box.

How to connect

Use the TV's YPbPr IN and AUDIO IN jacks, PC or HDMI/DVI VIDEO port for video connections, depending on your set-top box connections available. Then, make the corresponding audio connections.

How to use

1. Turn on the digital set-top box. (Refer to the owner's manual for the digital set-top box.)
2. Use TV/AV on the remote control to select HDMI mode.
3. Press Play button on external equipment for program play.

Digital Set-top Box

External Equipment Connections

PC connection

How to connect

1. To get the best picture quality, adjust the PC graphics card to (1024x768),60Hz.
2. Use the TV's PC IN port for video connections, depending on your PC connector.
3. Then, make the corresponding audio connection. If using a sound card, adjust the PC sound as required.

How to use

1. Turn on the PC and the TV.
2. Use TV/AV on the remote control to select PC source.
3. Check the image on your TV. There may be noise associated with the resolution, vertical pattern, contrast or brightness in PC mode. If noise is present, change the PC mode to

another resolution, change the refresh rate to another rate or adjust the brightness and contrast on the menu until the picture is clear. If the refresh rate of the PC graphic card can not be changed, change the PC graphic card or consult the manufacturer of the PC graphic card.

NOTES:

- 1 Use a PC cable.
- 2 Avoid keeping a fixed image on the TV's screen for a long period of time. The fixed image may become permanently imprinted on the screen.
- 3 The synchronization input form for Horizontal and Vertical frequencies is separate.

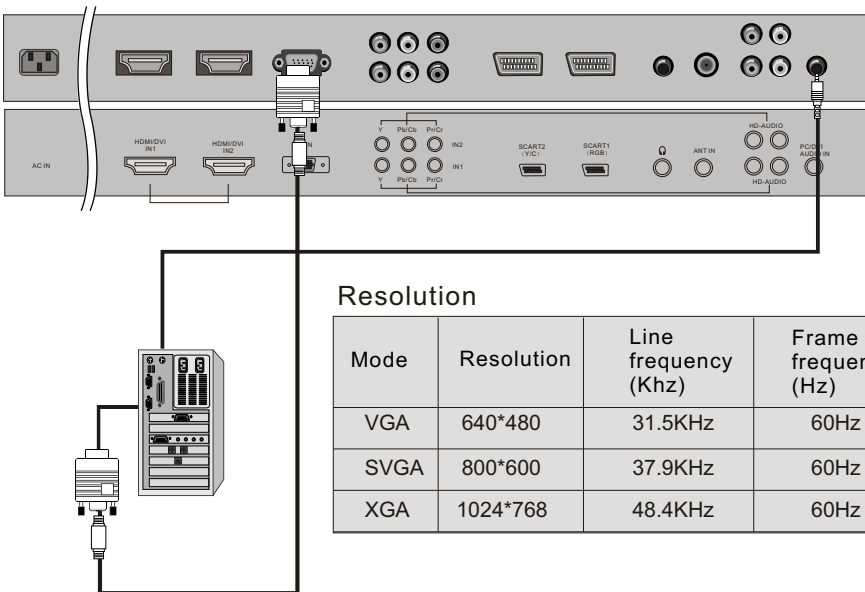

External Equipment Connections

Connecting Headphones

You can connect a set of headphones to your set if you wish to watch a TV programme without disturbing the other people in the room.

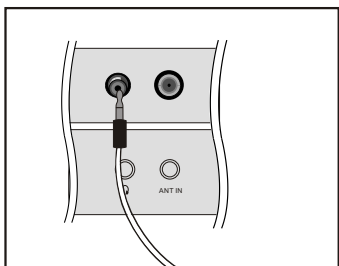

Plug a set of headphones into the 3.5mm mini-jack socket on the rear panel of the set.

Note:

- Prolonged use of headphones at a high volume may damage your hearing.
- You will not receive sound from the speakers when you connect headphones to the system.



Power source

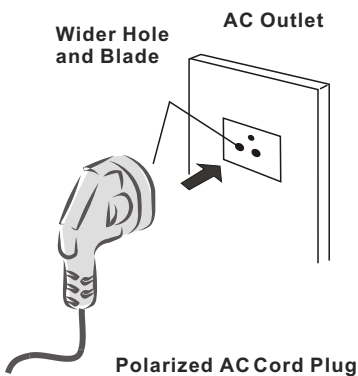

TO USE AC POWER SOURCE

Use the AC polarized line cord provided for operation on AC. Insert the AC cord plug into a standard polarized AC outlet.

NOTES:

- Never connect the AC line cord plug to other than the specified voltage. Use the attached power cord only.
- If the polarized AC cord does not fit into a non-polarized AC outlet, do not attempt to file or cut the blade. It is the user's responsibility to have an electrician replace the obsolete outlet.
- If you cause a static discharge when touching the unit and the unit fails to function, simply unplug the unit from the AC outlet and plug it back in. The unit should return to normal operation.

Set up your TV

-There are several options you might need to setup in order for your TV to work properly. Read the instructions that follow.
-In the manual, the OSD (on screen display) may be different from your TV's, because it is just an example to help you with the TV operation.

Switching ON/OFF the TV set

- 1 first, connect power cord correctly and the power indicator will light.
- 2 If the indicator is lighting in red, press the digit buttons or CH+/- button on the remote controller again or POWER or CH+/- button on the TV set. (with the exception 0 digit)
- 3 If you want to exchange to standing by status, please press down button ϕ on the remote controller.
- 4 Disconnect the power supply or unplug the television if it is intended to completely cease the television performance.

Choose the Menu Language

When you start using your set for the first time, you must select the language which will be used for displaying menus and indications.

- 1 Press **MENU** button and then use CH+/- button to select the **Function** menu.
- 2 Press VOL+/- button and then use CH+/- button to select **Language**.
- 3 Select your language with VOL+/- button and press the MENU button to confirm your selection.
- 4 When you are satisfied with your choice, press the **EXIT** button to return to normal viewing or press **MENU** button to return to the previous menu.

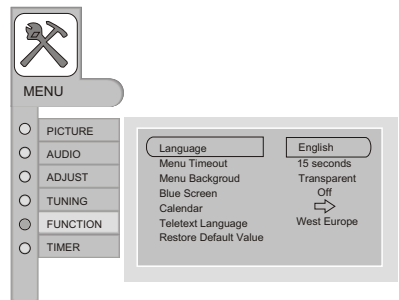

Choose the Input Source

If you hope to enjoy the picture from the external input source, before to select the source, you need to connect the devices, otherwise, when you select the source, the snowflake, blue screen or no signal will appear on the screen.

Press **TV/AV** button on television or remote control, the menu appears on the screen.
Then press CH+/- to select the desired option, and press VOL+/- to ensure it.

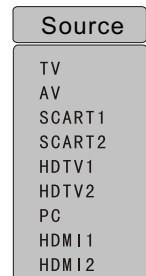

Tuning menu

- This TV set has three methods to set channels, which are respectively full automatic, manual search, fine tune.
- In this section, how to use the remote control to set channel is explained. You can also use buttons on the TV set to set channel.

Automatic search

- 1 Press **MENU** button and then use CH+/- button to select the **TUNING** menu.
- 2 Press VOL+/- button and then use CH+/- button to select **Country**, and use VOL+/- button to set the country. (first according to where you be)
- 3 Press CH+/- button to select **Auto Search**.
- 4 Press VOL+/- button, at this time, the prompt will display on the screen, and then press VOL+/- button to select the Yes option, press MENU button to ensure automatic search with higher level.

After the search has finished, all channels now playing program will be automatically preset in order.

Note:

If you have set TunerLock as on in Lock Set menu. there will be TunerLock display onscreen and you maynot enter the TUNING menu, at this time, you mustset Tunerlock as off in Lock Set menu.

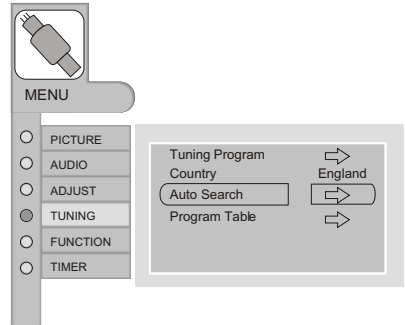

Note :
The **TUNING** menu will be only operated in normal TV and SCART mode.

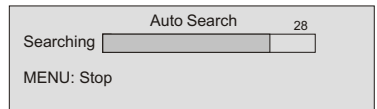
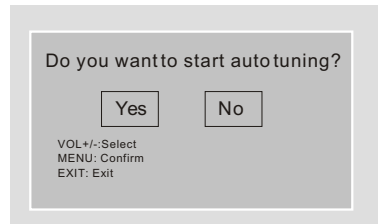

Tuning menu

Manual search

If excessive channel signals of unwanted programs are received in local area, manual search function is recommended.

- 1 Press **MENU** button and then use CH+/- button to select the **TUNING** menu.
- 2 Press VOL+/- button and then use CH+/- button to select **Tuning Program**.
- 3 Press VOL+/- button to enter the submenu.
- 4 Press CH+/- button to select **Manual Search**.
- 5 Press VOL-/+ button repeatedly, till the best picture and sound are obtained.
If you are familiar with the frequency value, press the desired digits direct.
Or press VOL+/- button to surpass for 3 seconds, then become semiautomatically searches for channel, till the channel is obtained.

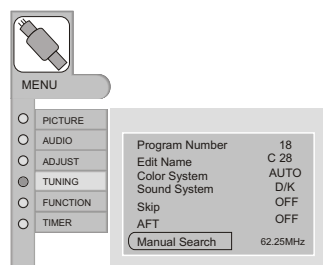
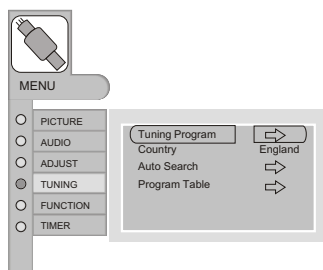

AFT(Auto Fine Tuning)

If the picture and/or sound are poor, try using the Auto Fine Tuning feature. Do not use this feature unless reception is poor.

- 1 Press **MENU** button and then use CH+/- button to select the **TUNING** menu.
- 2 Press VOL+/- button and then use CH+/- button to select **Program Table**.
- 3 Press VOL+/- button to enter the submenu.
- 4 Press CH+/- button to select **AFT**.
- 5 Press VOL-/+ button to set AFT as on or off.
- 6 Press the **EXIT** button to return to normal viewing or press **MENU** button to return to the previous menu.

Note:

If the AFT harmonious effect is not good, suggested uses manually searches for the adjustment picture the effect

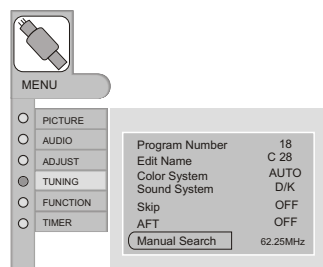
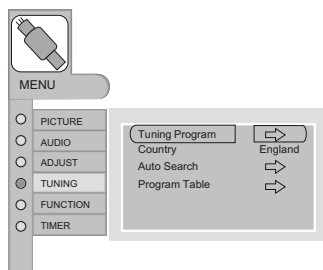

Tuning menu

Program Table

- 1 Press **MENU** button and then use CH+/- button to select the **TUNING** menu.
- 2 Press VOL+/- button and then use CH+/- button to select **Program Table**.
- 3 Press VOL+/- button to enter the submenu. You can press CH.LIST button again to enter the submenu.
- 4 Press CH+/- button to select the edited channel, and press button corresponding to edit.
 - Red button: delete channel name
 - Green button: copy channel
 - Yellow button: Name channel
 - Blue button: Swap

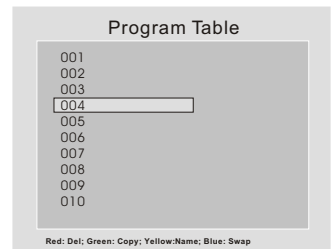
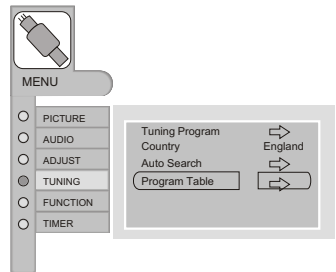

Delete name

- 1 Press CH+/- to select the channel;
- 2 Press the red button on the remote control to delete;
- 3 Press **MENU** button to delete name.

Copy edit name

- 1 Press CH+/- to select the channel,
- 2 Press the green button on the remote control,
- 3 Press CH+/- button to select the channel to copy,
- 4 Press again the green button then press **MENU** button to ensure.

Name channel

- 1 Press CH+/- to select the channel;
- 2 Press the yellow button on the remote control;
- 3 Press the yellow button to display the digital and letter list;
- 4 Press Vol+/- or CH+/- to select the desired digital or letter;
- 5 Press the yellow button to exit list;
- 6 Press **MENU** button to ensure.

Swap channel

- 1 Press CH+/- to select the channel;
- 2 Press the blue button on the remote control;
- 3 Press CH+/- button to select the channel to swap;
- 4 Press again the **blue** button to ensure.

Tuning menu

If the colour of some channel is abnormal

Usually this should be set in the auto position. However if the colour displayed on the screen are incorrect, you can manually select the correct colour system.

- 1 Press **MENU** button and then use CH+/- button to select the **TUNING** menu.
- 2 Press VOL+/- button and then use CH+/- button to select **Program Table**.
- 3 Press VOL+/- button to enter the submenu.
- 4 Press CH+/- button to select **Color System**.
- 5 Press VOL-/+ button to select the correct color system (**AUTO, NTSC, PAL, SECAM and NT4.43**).
- 6 Press the **EXIT** button to return to normal viewing or press **MENU** button to return to the previous menu.

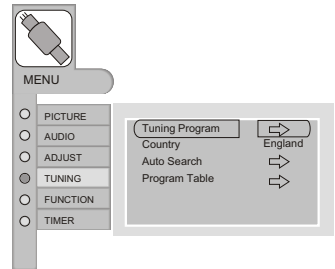

If sound is abnormal

Press CH+/- button to select "Sound System", then press VOL-/+ button to select the correct sound system.
Press VOL+/- button to select **D/K, I, B/G, L, L'** in turn.

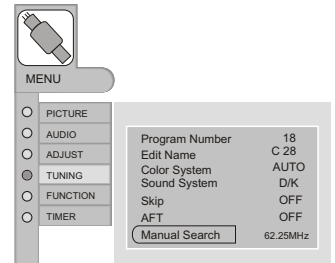

Edit Name

- 1 Press **MENU** button and then use CH+/- button to select the **TUNING** menu.
- 2 Press VOL+/- button and then use CH+/- button to select **Program Table**.
- 3 Press VOL+/- button to enter the submenu.
- 4 Press CH+/- button to select **Edit Name**.
- 5 Press VOL-/+ button to select position you want to change and press digits to change.
- 6 Press MENU button to ensure it.

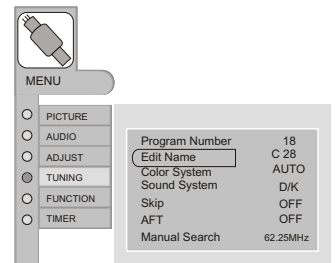

Tuning menu

Skip

After the programs are presetting, you can skip some programs so that to select your favorite channels only.

- 1 Press **MENU** button and then use CH+/- button to select the **TUNING** menu.
- 2 Press VOL+/- button and then use CH+/- button to select **Program Table**.
- 3 Press VOL+/- button to enter the submenu.
- 4 Press CH+/- button to select **Skip**.
- 5 Press VOL-/+ button to set **Skip** as **On**.
- 6 Press the **EXIT** button to return to normal viewing or press **MENU** button to return to the previous menu.

At this time, when you select channel with CH+/- button, the channel will not appear.

If you want to recover the skipped channel

1. Use Direct-digit Choosing button to select the number of the channel to be recovered.
2. Do the above steps again.
3. Press VOL+/- button to set **Skip** as **Off**.

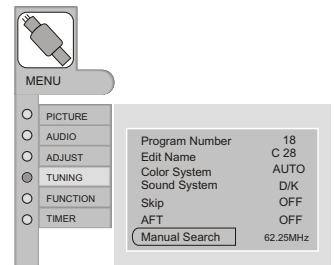
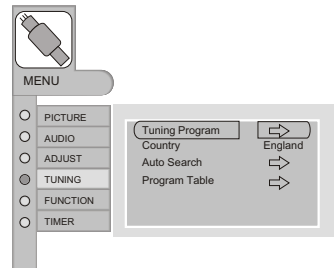

Program swap

Swap function enables quick swap to the last watched program.

- 1 Suppose the channel number you used just now is 8 and the channel number you are using is 18 (as shown in the figure).
- 2 If you want to return to the last watched program channel 8, you can simply press the swap button.
- 3 If you want to return to channel 18, press the button again. Through this function, you can easily change between the channel you are using and the channel you used last time.

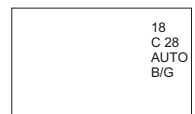
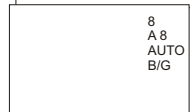
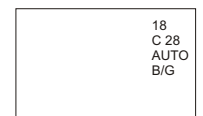

Tuning menu

You can watch TV program in a presetting channel.

How to select the desired program

1 Using "Program number" buttons

Press digit button to select the program.

If 2-digit or 3-digit programs are selected, press digit buttons you needed continuously within 3 seconds.

If selected channel program is set at Lock on mode and no password has been entered after initiation of the television, the screen will indicate require password entry. If wrong password is entered, channel selection will fail and previous program will still stay on the screen. The program locking password can be modified in the preset menu and previous password will be required.

2 Using CH+/- button.

- Press CH+ button to select a channel number in number increasing direction.

- Press CH- button to select a channel number in number decreasing direction.

(Note: If Skip is ON on one channel, press CH+/- button, the channel will not appear.)

How to select the desired sound

Press VOL-/+ button on the remote controller or the front of the TV set to adjust the volume level. The range is 0~100. When the volume buttons are pressed the volume level is displayed automatically on the TV screen.

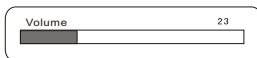

Picture Adjustment

The TV menu gives you an overview of the menus you can select.

Note: Depending on the input signal, one or more menu items may not be selectable.

picture modes

The picture mode provides the pre-defined images settings. Press the P.STD button to select the option.(Normal/Soft/Personal/Bright)

- Personal: A spare setting that can be adjusted to personal status
- Normal: Designed for rooms that have good all round lighting
- Soft: Designed for nighttime low light viewing
- Bright: Designed for rooms with high ambient lighting such as daytime sport;

How to customize your own picture status

- 1 Press **MENU** button and then use CH+/- button to select the **PICTURE** menu.
- 2 Press VOL+/- button and then use CH+/- button to select the item to be adjusted.
- 3 Press VOL+/- button to obtain the desired effect.
- 4 When you are satisfied with your choice, press the **EXIT** button to return to normal viewing or press **MENU** button to return to the previous menu.

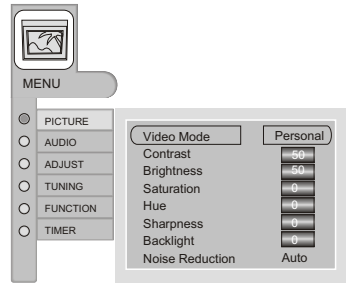

■ Contrast

This will adjust the intensity of bright parts in the picture but keep the dark parts unchanged.

■ Brightness

This will adjust the light output of the complete picture, which will mainly affect the darker areas of the picture.

■ Saturation

This will adjust the saturation level of the colors to suit your personal preference.

■ Hue (Selectable in NTSC mode only)

Allows you to select the color mix (Hue) of the picture.

■ Sharpness

This will adjust the sharpness of fine details in the picture.

■ Noise Reduction

Automatically filters out and reduces the image noise and improves picture quality when receiving weak video signals. Select **Off/Weak/Medium/Strong** according to the image noise.

Note : when the personal mode is not selected, the personal mode will be entered automatically if Contrast, Brightness, Saturation, Hue, Sharpness, Backlight parameters are adjusted.

Sound Adjustment

Sound modes

The sound mode provides the pre-defined sound settings. Press the S.STD button to select the option. (Music/Personal/Standard/Hall)

This selects the modes for sound reproduction dependent on the broadcast signals or signals from external inputs received.

Press CH+/- button to Select **Audio Mode**,
press VOL+/- button to select the **Music**, **Personal**, **Standard** or **Hall**.

- **Personal**: A spare setting that can be adjusted to personal tastes
- **Standard**: Normal sound with moderate bass and treble setting
- **Hall**: Designed to reduce the bass and treble which enhances the voice for news programs
- **Music**: Enables extra bass and treble to enhance the movie experience

How to customize your own sound status

- 1 Press **MENU** button and then use CH+/- button to select the **AUDIO** menu.
- 2 Press VOL+/- button and then use CH+/- button to select the item to adjust.
- 3 Press VOL+/- button to obtain the desired effect.
- 4 When you are satisfied with your choice, press the **EXIT** button to return to normal viewing or press **MENU** button to return to the previous menu.

■ **Volume**

This will adjust the sound output level.

■ **Balance**

This will adjust the output of the right and left speakers to obtain the best reproduction for your listening position. The intermediate value is 0. When indication value of Balance increases toward +50, sound of the right and left speaker becomes stronger and weaker, respectively. When indication value of Balance decreases toward -50, sound of the right and left speaker becomes weaker and stronger.

■ **Treble**

This will adjust the treble output level.

■ **Bass**

This will adjust the bass output level.

■ **Auto Volume**

Each broadcasting station has its own signal conditions, making it sometimes difficult to adjust the volume every time the channel is changed. This feature lets you automatically adjust the volume of the desired channel and reduces the volume differences between channels and programs, providing a more constant overall level.

Press CH+/- button to Select **Auto Volume**,
press VOL+/- button to set **Auto Volume** as **Off** or **On**

■ **Woofer**

Woofer is a speaker that complements front speaker's reproduction capability of low-pitched sound. Press CH+/- button to Select **Woofer**,
press VOL+/- button to adjust the desired value.

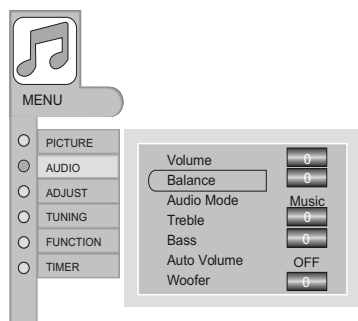

Sound Adjustment

Eliminate sound

When you need to pay attention to surrounded sounds, or there is a telephone calling you or there are some guests visiting you, the sound elimination (mute) function is very convenient.

1 Press the MUTE button on the remote control and "Mute" type face will display on the lower part of the screen. At this time, the sound of the TV set is turned off.

2 If you want to recover the sound, press the MUTE button again or directly press VOL+ button.

Time Setting

Clock setting

The clock will only work if the TV set is turned on or in standby. When the set is disconnect from the power supply or is turned off by the main power, the clock loses power and will need to be reset when the power is reconnected.

- 1 Press **MENU** button and then use CH+/- button to select the **TIMER** menu.
- 2 Press CH -/+ button to select the **Clock** option. then press digit buttons to set the value of hour and minutes;
- 3 When you are satisfied with your choice, press the **EXIT** button to return to normal viewing or press **MENU** button to return to the previous menu.

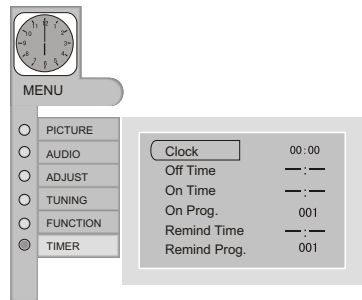

NOTE: When the TV turn on, the clock will start to time.

Off/On Time

Using on/off time function, the TV set can automatically turn on to a preset channel or shut down at a preset time.

- 1 Press CH+/- button to select "On Time", and then press the digit buttons to set the value of both hours and minutes.
- 2 Press CH+/- button to select "On Prog.", then press VOL+/- or the digit buttons to select your desired channel.
- 3 Repeat step 1-2 to set "Off Time".

NOTE: 1. Sleep off and off time associate.
2. When the on time and off time are all setting the time, if the TV is turned off by the remote control, the time of On Time item will hold good.

Remind Time/Remind Prog.

- 1 Press MENU and then use VOL+/- button to select the **TIMER** menu.
- 2 Press CH+/- button to select "**Remind Time**", then press the digit buttons to set the value of hour and minute.
- 3 Press CH+/- button to move the cursor to "**Remind Prog.**". Then press the digit buttons to set the desired channel.

Function menu

It is possible to select language, OSD transparent, Menu Timer and Calendar of the menu as follows:

Function setup

- 1 Press **MENU** button and then use CH+/- button to select the **FUNCTION** menu.
- 2 Press VOL+/- button and then use CH+/- button to select the desired option.
- 3 Press VOL+/- button to adjust the option you have selected.
- 4 When you are satisfied with your choice, press the **EXIT** button to return to normal viewing or press **MENU** button to return to the previous menu.

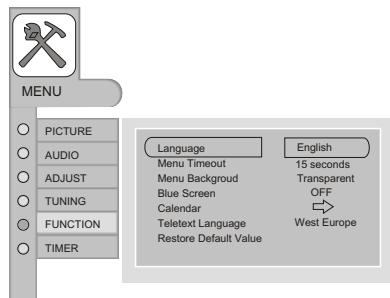

■ OSD language

Repeat step 2 and 3 to select the language you wanted.

■ Menu Timeout

Repeat step 2 and 3 to select the time of the OSD display in sequence as follows:

5 seconds, 10 seconds, 15 seconds, 20 seconds, 25 seconds, 30 seconds and 40 seconds.

■ Menu Background

Repeat step 2 and 3 to select Transparent/ Opaque background of OSD.

■ Blue Screen

Repeat step 2 and 3 to select Blue Screen On/Off. If you select ON, when no signal, the background is blue; if you select Off, when no signal, the background is snownoises.

■ Calendar display and check

Repeat step 2 and 2 to enter Calendar menu, Press VOL+/- to select among year, month and day, and then CH+/- to adjust them.

| 2005-01-01 | | | | | | |
|------------|------|------|------|------|------|------|
| Sun. | Mon. | Tue. | Wed. | Thu. | Fri. | Sat. |
| | | | | | | 1 |
| 2 | 3 | 4 | 5 | 6 | 7 | 8 |
| 9 | 10 | 11 | 12 | 13 | 14 | 15 |
| 16 | 17 | 18 | 19 | 20 | 21 | 22 |
| 23 | 24 | 25 | 26 | 27 | 28 | 29 |
| 30 | 31 | | | | | |

■ Teletext Language

Repeat step 2 and 3 to select from 6 kinds of languages. (West Europe/East Europe/Cyrillic/ Greek/Arabic/Persian.)

■ Restore Default Value

Repeat step 2 and 3 to return the factory mode.

Adjust menu

The TV menu gives you an overview of the menus you can select.

Note: Depending on the input signal, one or more menu items may not be selectable.

Adjustment Setup

When PC input mode is set

- 1 Press **MENU** button and then use CH+/- button to select the **ADJUST** menu.
- 2 Press VOL+/- button and then use CH+/- button to select the desired option.
- 3 Press VOL+/- button to adjust the option you have selected.
- 4 When you are satisfied with your choice, press the **EXIT** button to return to normal viewing or press **MENU** button to return to the previous menu.

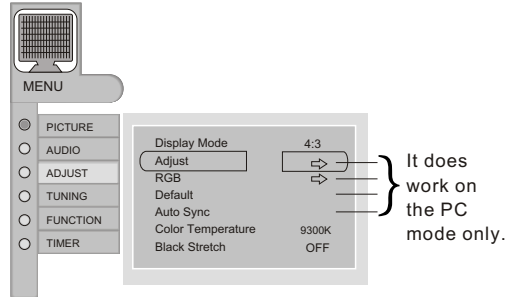

■ Display Mode

This will adjust the picture aspect ratio.

■ RGB

This is used for the adjustment of the numerical value of red, green and blue in PC mode.

■ Default

This is used to reset the default setting parameters

■ Auto sync

This is used for adjustment of picture location frequency and phase parameters in PC mode.

(After the operation, Complete will be on the right of the option.)

■ Color temperature

This will increase or decrease 6500K (red) and 11000K (blue) colors to suit personal preferences.

Select 11000K to give the white colors a blue tint, 9300K to give the white colors a neutral tint, 6500K to give the white colors a red tint.

■ Black Stretch

Black Stretch - (Automatically Increases the Contrast Range)

Press VOL+/- to set as on or off.

Adjust menu

In PC input mode, H-Position and V-Position can be adjusted to eliminate transverse line interference and decentered picture as follows:

■ Adjust

This is used for adjusting HPosition and VPosition as well as relative parameters in PC and modes. (Phase Adjust is not available in HDMI)

- 1 Press **MENU** button and then use CH+/- button to select the **ADJUST** menu.
- 2 Press VOL+/- button and then use CH+/- button to select **Adjust** option.
- 3 Press VOL+/- button and use CH+/- button to select the desired adjust parameter option.
- 4 Press VOL+/- for desired adjust parameter option until satisfactory value is achieved. When PC signals are received, the automatic mode is used for parameter adjustment.
- 5 When you are satisfied with your choice, press the **EXIT** button to return to normal viewing or press **MENU** button to return to the previous menu.

- H Size: Horizontal size of picture can be adjusted in this item.
- H Position: Horizontal position of picture can be adjusted in this item.
- V Size: Vertical size of picture can be adjusted in this item.
- V Position: Vertical position of picture can be adjusted in this item.
- Phase: Adjust the phase of Pixel clock.

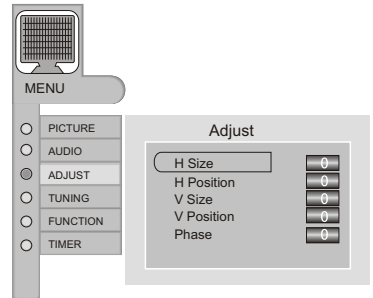
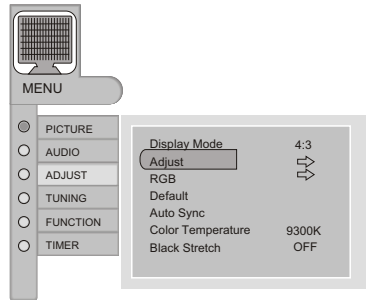

Lock setup

The television has the function of security default lock. Password needs to be entered when the program lock mode is to be set.

Lock setup

Press H.LOCK button on remote control, Password will appear on the screen.

If password is correctly entered, the LOCK menu will be displayed.

If the password is not correctly entered, you will be required to reenter the password and the cursor will remain onscreen.

Press EXIT to exit the window. If the preset OSD time is exceeded, the menu will disappear automatically.

The initial password of the television is 0000.

| LOCK SET | |
|-------------|-----|
| Password | |
| Tuner Lock | OFF |
| Prog.Set | OFF |
| Prog. Num | 1 |
| Source Lock | ⇒ |
| Child Lock | OFF |
| Max Volume | 100 |
| Clear Lock | |

To set new Password

The password can be changed.

After entering the Lock set menu, Press CH+/- to select **password**, Press VOL+/-, the screen will display the follow.

Old Pw. ----

If correct password is entered, the screen will display the follow.

New Pw. ----

Press digital button to set the new desired password, and the screen will display the follow.

Confirm Pw. ----

If the desired password is entered correctly twice, the old password will be changed. If the desired password is not correctly entered twice, the screen will display New Pw.----, then you have to reenter the password.

Note:

If Clear Lock is activated, the password setup cannot be changed.

Tuner Lock

Press CH+/- to select Tuner Lock and VOL+/- to set On/Off.

(To set On, some operation such as search will be not available. When enter the TUNING menu, Tuner Lock will be on the screen, and the time will be the same with the main menu if no operation. If you want to operate TUNING menu, you need to enter the Lock menu to set Tuner Lock Off or operate Clear Lock.

Preset Prog.

Preset prog. is opted for setting up start channel. Press CH+/- button to select Prog Set.

Press VOL+/- button, sources can be swapped in

AV/SCART1/SCART2/HDTV1/HDTV2/PC/HDMI1/HDMI2 mode. After setup, the set mode will be entered if the television is switched off and on again. To set Off, the television will memory the off-channel.

Lock setup

Prog Num

Prog Num is opted for setting up preset channel. Press **CH+/-** button to select Prog Num. Press **VOL+/-** button, to select channel number.(The item is not available except TV signal.)

Source Lock

Source Lock is opted to hinder external input modes, such as AV, Scart and PC. Press **CH+/-** button to select the option, and press **VOL+/-** button to display Source Lock menu.

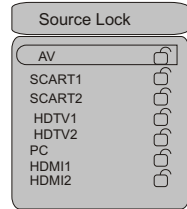

Press **CH+/-** button to select desired option. Press **VOL+/-** button to set up the mode of Source Lock. If some Source Lock is set on, the mode will be entered and the screen will display blue background with the mute mode activated and Lock. In lock on mode, when screen is blank, icon Lock will be always displayed on the screen. If lock mode is to be verified, enter Source Lock submenu and set relative mode off, or select Clear Lock in the Lock Set Menu.

Child Lock

Press **CH+/-** button to select Child Lock.

Press **VOL+/-** button to set **On** or **Off** mode. If lock on mode is set, Child Lock is in activated automatically. In such case, if Child Lock button (button on the television) is pressed, the screen will display **Child Lock**, which can be erased by press of **EXIT** button. 5 seconds later after the latest press, the screen display will disappear automatically. The Child Lock mode can be resumed by entering Lock Set menu, set Child Lock **On** or **Off**.

Max Volume

Press **CH+/-** button to select Max Volume. Press **VOL+/-** button for adjustment between 0~100. If a certain value is set, when volume is being adjusted, the sound value can not exceed maximum volume value. If current volume is over Max Volume, when Lock Set menu is set, current volume will become set maximum volume. If current volume is below maximum volume, customer set volume will stay unchanged.

Clear Lock

Press **CH+/-** button to select Unlock mode. Press **VOL+/-** button to unlock all set modes, setting all lock options to off, and the maximum volume returns to 100.

Other functions

NICAM

If the broadcaster is transmitting Bilingual sound service. The I / II button on the remote controller will allow up to 2 separate languages to be selected. You can press the I / II button to make a choice.

Display function

If current program number, color system and sound system are to be displayed on the screen, press **DISPLAY** button, and all the related information will appear at right up corner of the screen.

If the **DISPLAY** button is pressed again, the displayed information will disappear.

(If the program is named, its name will also appear).

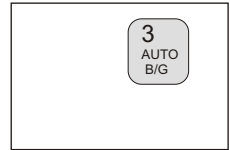

Auto program scan

1 If you want to select a desirable program, you may scan all the TV programs in memory. You can simply press **SCAN** button to do this. Press scan button once, there are nine pictures on the screen.

| | | |
|---|---|---|
| 1 | 2 | 3 |
| 4 | 5 | 6 |
| 7 | 8 | 9 |

2 If you want to stop the function during auto tuning, simply press **SCAN** button again.

Sleep

The TV set will switch automatically to standby at the preset time with the SLEEP time on. You may set the sleep time, Operate as follows:

1 Press SLEEP button repeatedly to select the number of preset minutes, the timer will be set in sequence:

0Min→5Min→15Min→30Min→60Min→90Min→120Min→0Min

Note: If the Off time on the TIMER menu is set, when press first SLEEP button, the remaining time will display on the screen.

2 After the sleep time is set, the Indication will appear on the screen 1 minute prior to expiry of set time.

3 If remaining time of set timer is to be displayed, press **SLEEP** button again. The TV set will switch off automatically at the preset time, press CH+/- button to turn on again.

4 If to cancel sleep time, press **SLEEP** button repeatedly to set as 0.

Picture Still

Press **Still** button, the picture will be still; if to cancel, press Still button again, the picture will resume.

Note:
The Time On setup and the SLEEP setup is absolute one another.

Teletext functions

Teletext is an information system, broadcast by certain channels, which can be read like a newspaper . It also provides subtitles for people with hearing difficulties or those who are unfamiliar with the language in which a particular programme is being broadcast (cable networks, satellite channels, etc.).

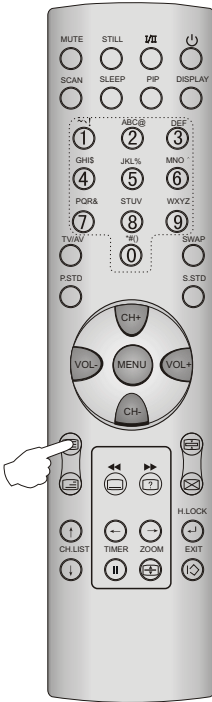

Teletext function operation

You can press  button into TEXT mode, press again to leave TEXT mode. All menu related functions are not available in TEXT mode. Only a few direct button control functions are available in TEXT mode, they are:

1 Page up/down

Result: Use the CH+/- buttons to browse next or previous page.

2 Page number entering

Result: To select a teletext page either directly enter the page number using the numeric button pad on the remote control or use CH+/- buttons, or the colored Fast Text buttons.

Teletext functions

(MIX)

While in Teletext mode press the  button will show the teletext data superimposed on top of the TV picture. Press the button again to revert back to Full text.

(HOLD)

Pressing the  button will stop the teletext page automatically updating. This feature is very useful where there are several teletext pages or data on the same page number.

(ZOOM)

Pressing the  button to change from different screen display size. This feature is very useful as it magnifies the image making the characters easier to read.

(REVEAL)

Pressing the  button will reveal hidden text. This feature is used to reveal information such as answers to Teletext on-line interactive puzzles.

(TIMER)

While in normal TV mode only, pressing the button **TIMER** will display the teletext time in the top right corner for a few seconds.

(TEXT)

Press the  button on the remote control to turn teletext On/Off.

(SUBTITLE)

Pressing the  button will get the teletext decoder to automatically search for the subtitle page. In NZ the subtitle is usually page 801.

(CH.LIST)

Press the  button to show the list of teletext contents

(Fast text colored buttons)

Fast text automatically displays the four most commonly used pages that the broadcaster thinks that you may want to choose next. Press the same coloured button on the remote control as the coloured link at the bottom of the teletext page to go directly to that page.

Maintenance

- Early malfunctions can be prevented. Careful and regular cleaning can extend the amount of time you will have your new TV. Be sure to turn the power off and unplug the power cord before you begin any cleaning.

Cleaning the Screen

1. Here's a great way to keep the dust off your screen for a while. Wet a soft cloth in a mixture of lukewarm water and a little fabric softener or dish washing detergent. Wring the cloth until it's almost dry, and then use it to wipe the screen.

2. Make sure the excess water is off the screen, and then let it air-dry before you turn on your TV.

Cleaning the Cabinet

To remove dirt or dust, wipe the cabinet with a soft, dry, lint-free cloth. Please be sure not to use a wet cloth.

Extended Absence

If you expect to leave your TV dormant for a long time (such as a vacation), it's a good idea to unplug the power cord to protect against possible damage from lightning or power surges.

Specifications and functions

| MODEL | L26A16 L26A18 | L32A16 L32A18 | L37A16 L37A18 | L42A16 L42A18 |
|-----------------------------------|--------------------------|------------------|------------------|------------------|
| Resolution | 1366X768(Dot) | | | |
| Power requirement | ~150-240V , 50/60Hz | | | |
| Color System | PAL, SECAM, NTSC | | | |
| Sound System | D/K,I,B/G,L,L' | | | |
| External Antenna Impedance | 75 ohm | | | |
| Operating Temperature Range | 5°C ~ 35°C | | | |
| Operating Humidity Range | 20% ~ 80% | | | |
| Storage Temperature | -15°C ~ 45°C | | | |
| Storage Humidity | 5% ~ 90%, non-condensing | | | |

| Model | L26A16 L26A18 | L32A16 L32A18 | L37A16 L37A18 | L42A16 L42A18 |
|--|------------------|------------------|------------------|------------------|
| Size (WxDxH) unit: mm main component | 679X230X527 | 810X256X635 | 950X330X735 | 1075X330X824 |
| Net Weight(Kg) | 12.6kg | 17kg | 30kg | 38kg |

Troubleshooting

For the sake of time and cost, it is strongly recommended that you check out the problem by yourself according to the instructions listed hereunder before contacting the after-sales service for technical assistance.

| | |
|---|--|
| No picture, no sound | Verify if the television is properly plugged. Verify if the television is properly supplied power. Verify if electricity is available. |
| Blank screen | Verify if correct signals are input. Press TV/AV button to change signal input to TV input. Restart the television if power supply is interrupted. |
| No sound | Press Mute button and verify if Mute mode is set. Switch to other channel and verify if the same problem happens. Press VOL+ button to see if the problem can be solved. |
| Poor sound | Verify if sound system is correct. Refer to some chapter for adjust. |
| No picture in some channel | Verify if correct channel is selected. Adjust the antenna. Make adjustments by Fine Tune and Manual Search. |
| No color for some channel program (black and white) | Verify if the same problem exists in other channels. Check out of picture and sound systems. Refer to relative instructions in the Manual for color adjust. |
| Spots with some or all pictures | Verify if the antenna is correctly connected. Verify if the antenna is in good condition. Make fine adjustment of channel. |
| Horizontal/vertical bars or picture shaking | Check for local interference such as an electrical appliance or power tool. |
| Television out of control | Disconnect the television from power supply and, 10 seconds later, connect the television to the power supply. If the problem still exists, contact authorized after-sales service for technical assistance. |

Note: Do not leave the television with static picture in an extended period as it may result in residual image on your television screen.

Note: Production of the screen requires high and precision technologies. However, there might be some dark or bright (red, blue or green) spots, or some anomalous stripes or spots. This is not defect. If the TV set is used in an area 2,400 meters above the sea level where the air pressure is below 750hpa, the picture on the screen may be affected and a muffled sound might be produced. These phenomena might happen in the area 1,500 meters above the sea level. This is resulted from difference between air pressures inside and outside the display. This is not a defect covered by the limited warranty.

NOTE: Design and specifications are subject to change without notice.
The dimension in this manual is a approximation.

Haier

Haier

0090500952B (01)

Free Manuals Download Website

<http://myh66.com>

<http://usermanuals.us>

<http://www.somanuals.com>

<http://www.4manuals.cc>

<http://www.manual-lib.com>

<http://www.404manual.com>

<http://www.luxmanual.com>

<http://aubethermostatmanual.com>

Golf course search by state

<http://golfingnear.com>

Email search by domain

<http://emailbydomain.com>

Auto manuals search

<http://auto.somanuals.com>

TV manuals search

<http://tv.somanuals.com>