

Haier

LCD TV
OWNER'S MANUAL
MODELS: LE32A650
LE32F600

Haier

Please READ this manual carefully
before operating the TV, and keep
it for future reference.

Haier

Contents

Safety Warnings	2	Using Your TV	11
Welcome	2	Adjusting the Channel Settings	11
Important Information	2	Adjusting the Picture Settings.....	12
About Your LED LCD TV	5	Adjusting the Sound Settings	12
Installing the Stand	5	Adjusting the Time Settings.....	13
Installing a Wall-Mount Bracket.....	5	Adjusting the Option Settings.....	13
Side Control	5	Adjusting the PC Settings	14
Rear Terminals.....	6	Other Features	14
Making Connections	7	USB Media Player	14
Connecting to Antenna/Cable.....	7	Browse Mode.....	15
Connecting an External A/V Device	7	Photo Mode	16
Connecting a PC	7	Music Mode	16
Connecting Headphones.....	7	Movie Mode	17
Connecting a Digital Audio System	7	Text Mode.....	18
Using Your Remote Control	8	Teletext	18
Getting Started	9	Using MHL Device (LE32A650 only).....	19
Preparing Your Remote Control	9	Appendix	20
Installing the Batteries	9	Troubleshooting.....	20
Remote Control and Battery Cautions... ..	9	Specification	21
Initial Setup.....	9		
Understanding the Basics	10		
Turning the TV On or Off	10		
Selecting the Input Source	10		
Selecting a Channel.....	10		
Using Favourite List.....	10		
Adjusting the Volume	10		
Displaying Channel Information	10		
Navigating the On-Screen Menu.....	10		

Safety Warnings

Welcome



Thank you for choosing this 32" LED Backlit Flat TV. This manual will help you to set up and begin using your TV. Firstly, check the package contents before installing your new TV.

- 32" LED Backlit Flat TV
- Remote control
- AAA battery x 2
- Instruction manual
- Warranty card
- TV stand and screws
- AC power cord (LE32F600 only)

! When you open the box of LE32A650, take out the TV stand first to prevent it from falling off the top cushion while unpacking the components.

Important Information

Read the following safety instructions before operating your TV. Keep these instructions for future reference.

	WARNING RISK OF ELECTRIC SHOCK DO NOT OPEN	
<p>WARNING TO REDUCE THE RISK OF ELECTRIC SHOCK, DO NOT REMOVE COVER (OR BACK). NO USER SERVICEABLE PARTS INSIDE. REFER TO QUALIFIED SERVICE PERSONNEL.</p> <ul style="list-style-type: none"> • To avoid electric hazards, it is strongly suggested that the back cover not be opened, as there is no any accessory inside the casing. • If necessary, please contact authorized after-sales services. • The lightning flash with arrowhead symbol within an equilateral triangle is intended to alert the user to the presence of uninsulated DANGEROUS VOLTAGE within the product's enclosure that may be of sufficient magnitude to constitute a risk of electrical shock to persons. • The exclamation point within an equilateral triangle is intended to alert the user to the presence of important operating and maintenance (servicing) instructions in the literature accompanying the appliance. 		

WARNING: To avoid fires and electrical hazards, never place your television receiver in a humid area. Take care to avoid accidental scratches or impacts on the screen.

Do not cover the ventilation openings with items such as newspaper, table cloth, curtains, and etc.

- CAUTION:**
- The main plug is used as a disconnection device and must remain readily accessible.
 - Please read this manual carefully before using your television, and keep this manual to hand for future reference.
 - To achieve the best performance from your television, read this manual carefully and keep to hand for future reference.
 - Information in the Instruction Manual regarding screen displays and figures may vary due to technical innovations.
 - Unauthorised disassembly of this product is prohibited.



WARNING: To prevent the spread of fire, keep candles or other open flames away from this product at all times.

The product should be tightly secured to table/wall in accordance with the installation instructions to prevent injury or damage caused by dropping.

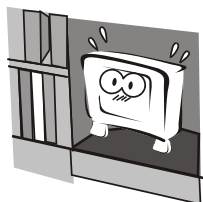

To avoid fire hazards, do not connect multiple sockets in parallel and do not connect multiple plugs to the same socket.

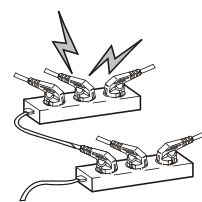

Do not position the product close to water or oil (e.g. cooking oil or lubricating oil), as this may cause a fire hazard.

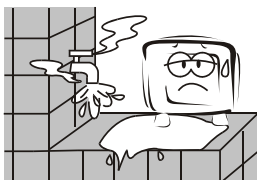

To avoid electric shocks or fire hazards, unauthorised disassembly of the television is prohibited. Contact an authorised after-sales service provider if technical servicing is required.

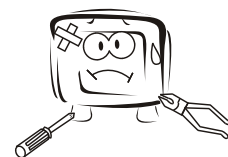

Do not use damaged or worn electrical plugs and keep cables away from heat sources to avoid electric shocks and fire hazards.

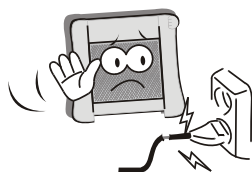

Disconnect the product from the power supply and contact an authorised after-sales service provider if the product starts to make abnormal sounds.

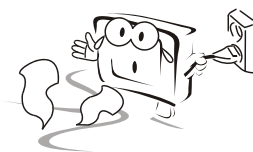

To avoid collapsing, the product must be placed on a solid and stable surface.

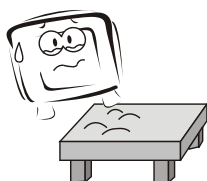

To avoid explosions and fire hazards, don't use or store inflammable materials near the product.

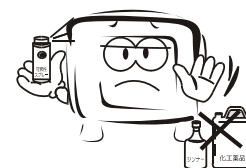

To avoid fire hazards, keep the product away from transformers or heat sources.

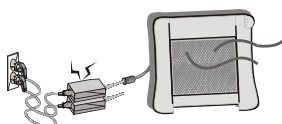

To avoid electric shocks, the antenna of the product should be away from electrical cables.

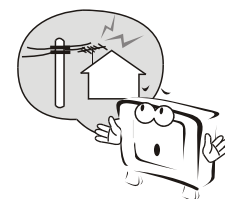

To avoid fire hazards, do not use this product in direct sunlight or close to heat sources.

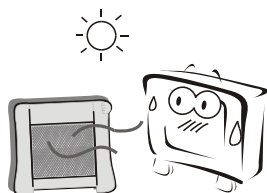

Always make sure that the television is firmly plugged in, as a poor electrical connection might cause a fire.



Unplug the power supply and antenna of the product during a rainstorm and particularly during a thunderstorm.

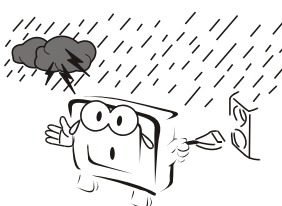

Before cleaning the product, unplug the television, and use soft fabric, not chemicals. Make sure that no water comes into contact with the product.



To avoid electric shocks or fire hazards, disconnect the television from the power supply and the antenna during a rainstorm or thunderstorm.



When an antenna is used, measures should be taken to prevent water from flowing down through the cable and into the television.



To reduce the risk of fire or electric shock, do not place the product in a humid area or expose it to rain or moisture.

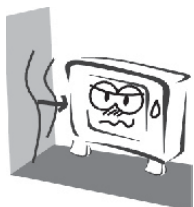

The plug and electric cable must be kept clean to avoid electric shocks or fire hazards.

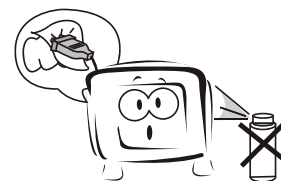

Never touch the plug with wet hands, as this might cause electric shocks.

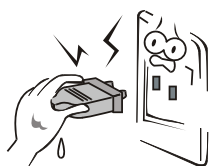

To avoid electric shocks or fire hazards, if you are not using the television for long periods of time, disconnect it from the power supply.

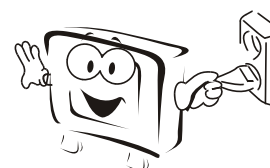

About Your LED LCD TV

Installing the Stand

1. Carefully place your TV screen face-down on a cushioned, clean surface to protect the screen from damages and scratches.
2. Carefully align and insert the stand to the bottom of the TV.
3. Secure the stand to the TV with the provided screws. (3 screws for LE32F600, 4 screws for LE32A650)

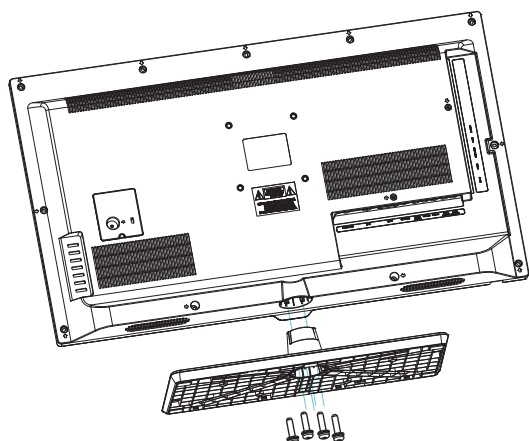

Installing a Wall-Mount Bracket

1. Carefully place your TV screen face-down on a cushioned, clean surface to protect the screen from damages and scratches.
2. If the stand is attached, remove the screws that secure the stand to the TV screen, then remove the stand.
3. Attach the wall-mount bracket (sold separately) to the mounting holes on the back of your TV using the screws supplied with the bracket. See the instructions that came with the wall-mount bracket for information about how to correctly hang your TV.

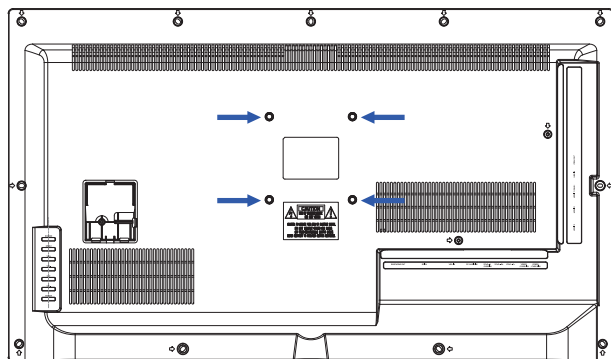

Note

- Contact technical assistance when installing the wall mount bracket. Haier Electronics is not responsible for any damage to the product or injury to yourself or others if you install the TV on your own.

Side Control

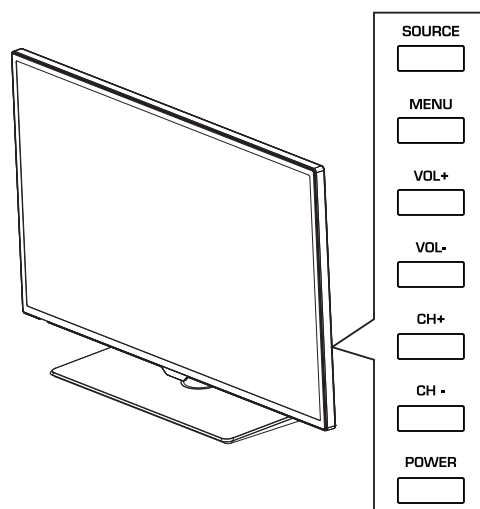

Button	Description
SOURCE	Press to select the input source.
MENU	Press to open the on-screen menu.
VOL+	Press to increase the volume level.
VOL-	Press to decrease the volume level.
CH+	Press to go to the next channel in the channel list.
CH-	Press to go to the previous channel in the channel list.
POWER	Press to turn the TV on or off.

Note

- For LE32F600, the side control panel is on the left side of the TV.

NOTE:

- Unless otherwise indicated, the TV and OSD illustrations used throughout this manual are based on LE32A650.
- The TV and OSD illustrations are for reference only and may differ from actual display.

Rear Terminals

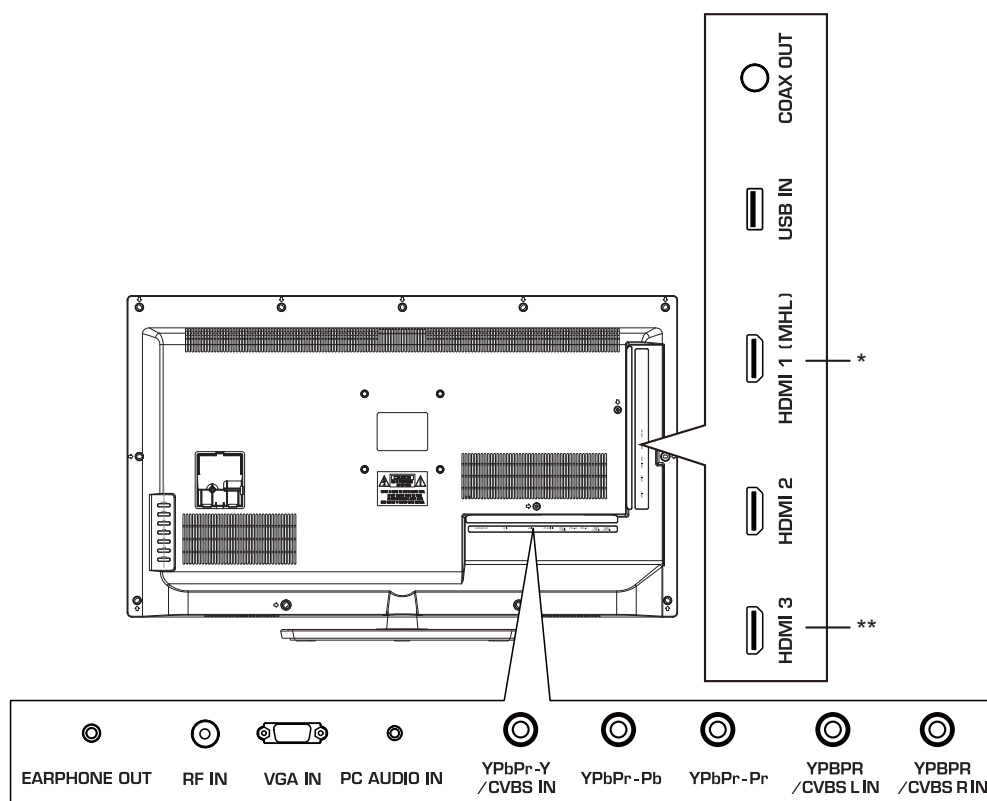

* MHL function is not available for LE32F600.

** HDMI 3 jack is not available for LE32F600.

Connector	Descriptions
COAX OUT	Connect a coaxial digital audio system to this jack.
USB IN	Insert a USB storage device to the USB port to view photos, listen to music or watch videos. (See "USB Media Player" on page 14 for more information.)
HDMI 1 (MHL) HDMI 2 HDMI 3	Connect HDMI device to this jack. When connecting a MHL-enabled device, such as a smart phone, use HDMI 1 (MHL) jack.
YPBPR/CVBS R/L IN	Connect the audio cables for a component or composite device.
YPbPr-Y/CVBS IN YPbPr-Pb YPbPr-Pr	Connect the video cables for a component or composite device. When connecting a composite video source, connect the yellow video wire to the YPbPr-Y/CVBS IN jack.
PC AUDIO IN	Connect the audio cable from a computer.
VGA IN	Connect the video cable from a computer.
RF IN	Connect an antenna or cable TV to this jack.
EARPHONE OUT	Connect headphones to this jack. When headphones are inserted, the TV speakers will be muted.

Making Connections

Connecting to Antenna/Cable

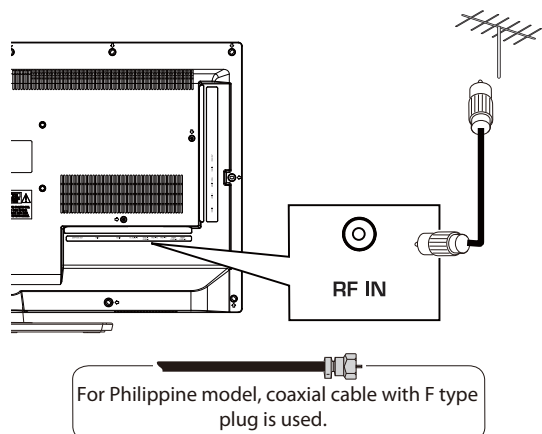

Note

- The component and composite jacks are shared. You can connect only one component or composite device at a time.

Connecting a PC

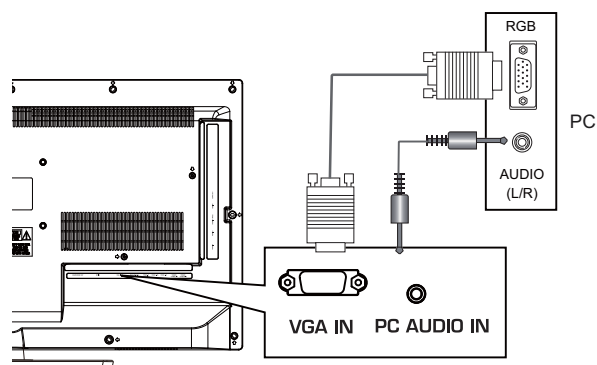

EN

Connecting an External A/V Device

Using HDMI cable

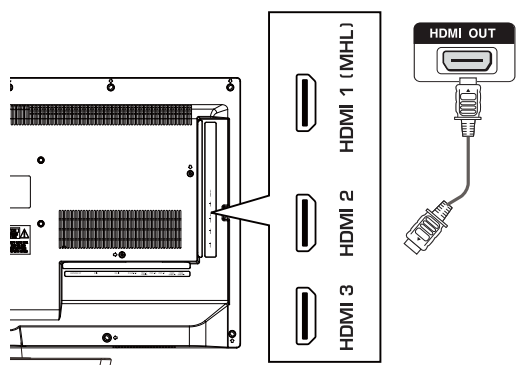

Connecting Headphones

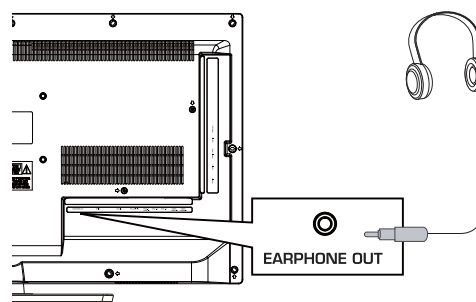

Using Component cable

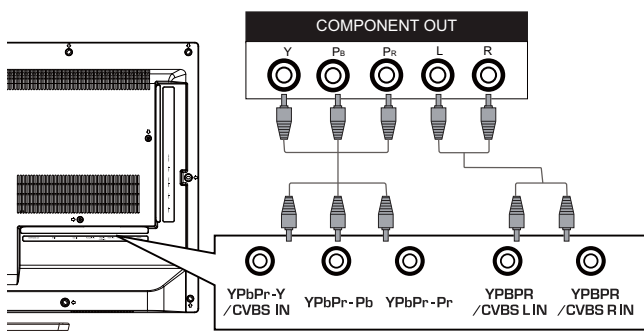

Connecting a Digital Audio System

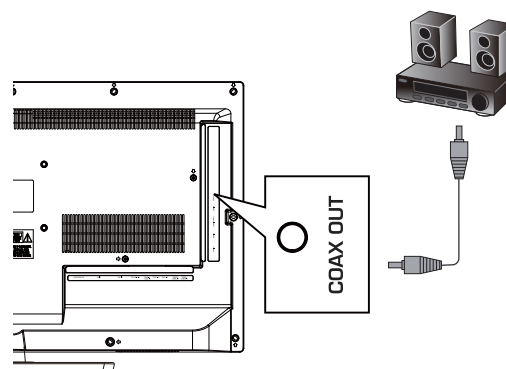

Using Composite cable

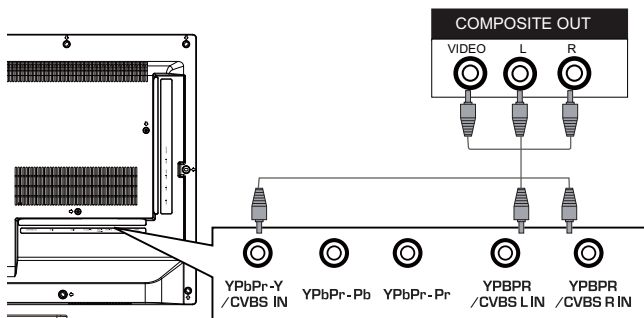

Note

- Turn off the TV and the device before making connections.
- MHL function is not available for LE32F600.
- HDMI 3 jack is not available for LE32F600.

Using Your Remote Control

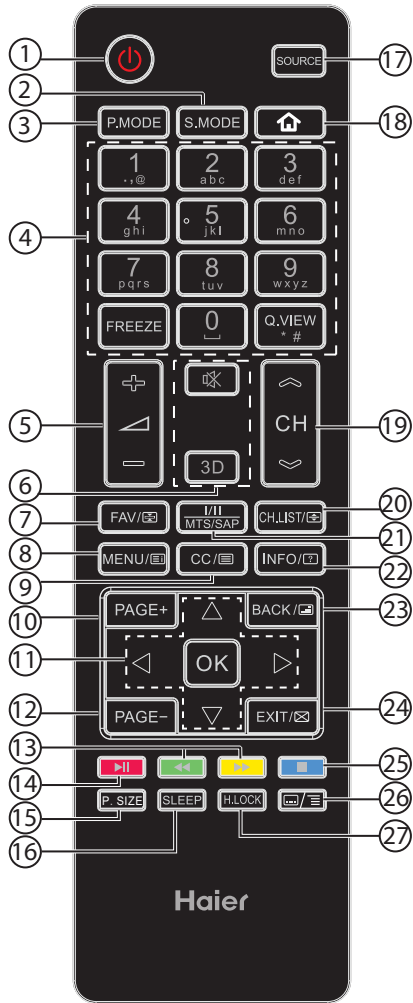

#	Button	Descriptions
1	(Power)	Press to turn the TV on or off.
2	S.MODE	Press to select the sound mode.
3	P.MODE	Press to select the picture mode.
4	0-9	Press to enter a channel number or password.
	Q.VIEW	Press to switch to the last viewed channel.
	FREEZE	Press to freeze the picture.
5		Press to adjust the volume level.
6	(Mute)	Press to turn the sound on or off.
	3D	These models do not support 3D feature.
7	FAV/	Press to add a favorite channel. In teletext mode, press to hold a page.
8	MENU/	Press to open the on-screen menu.
9	CC/	Press to open the teletext.

10	PAGE +	Press to go to the next page in teletext mode.
11		Press to navigate the on-screen menu.
	OK	Press to confirm a selection.
12	PAGE -	Press to go to the previous page in teletext mode.
13	(reverse) (forward)	Press to fast forward or reverse playback in multimedia mode.
14	(play/pause)	Press to play/pause in multimedia mode.
15	P.SIZE	Press to change the screen display mode.
16	SLEEP	Press to set the sleep timer.
17	SOURCE	Press to open the input source list.
18		Press to open the home menu of the MHL device.
19	CH	Press to change the channel.
20	CH.LIST/	Press to open the channel list. In teletext mode, press to switch the image to top, bottom or full.
21	I/II/MTS/SAP	Press to select the audio mode (depending on broadcast signal).
22	INFO/	Press to display the channel information. In teletext mode, press to reveal the hidden information.
23	BACK/	In multimedia mode, press to return to the previous screen. In teletext mode, press to enter mix mode.
24	EXIT/	Press to close the on-screen menu. In teletext mode, press to hide the text.
25	(stop)	Press to stop multimedia playback.
26		In teletext mode, press to enter a secondary page.
27	H.LOCK	Press to open the Hotel mode menu.

Note

- MHL function is not available for LE32F600.
- Teletext function is not available for Philippines NTSC system.

Getting Started

Preparing Your Remote Control

Installing the Batteries

1. Open the battery cover.

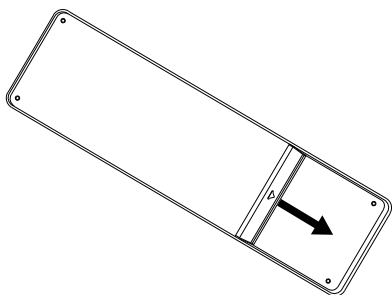

2. Install two AAA batteries. Make sure that you match the + and – symbols on the batteries with the + and – symbols in the battery compartment.

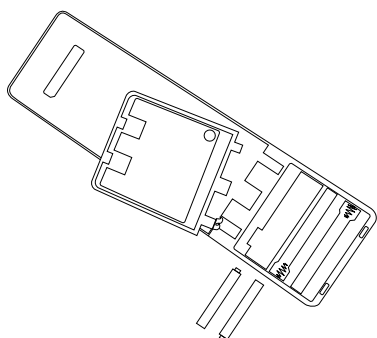

3. Replace the battery cover.

Remote Control and Battery Cautions

- Ensure that there is nothing between the remote control and the remote sensor of the TV set.
- Use the remote control carefully. Do not drop the remote control on the floor.
- Sunlight, or other strong light, will interfere with the signal from the remote control. Avoid using near fluorescent lights or neon signs.
- Do not place the remote control in direct heat or in a damp place as you may damage the remote.
- Danger of explosion if battery is incorrectly replaced. Replace only with the same or equivalent type. The batteries (battery pack or batteries installed) shall not be exposed to excessive heat such as sunshine, fire or the like.
- If your TV is not to be used for a long period of time, remove the batteries from the remote control.
- Do not dispose of the batteries with standard household waste. Do not throw them in a fire. Dispose of the battery according to local regulations.

Initial Setup

The first time you turn on your TV, the setup wizard guides you through setting up basic settings including the menu language and auto tuning.

1. Make sure that you have:
 - Installed the remote control batteries. (See page 9 for details)
 - Connected an antenna or cable TV. (See page 7 for details)
 - Connected the power cord on the back of the TV to a working power outlet.
For LE32F600, connect the supplied power cord to the **AC IN** jack on the back of the TV and to a working power outlet.
2. Press **⏻** to turn on the TV. The setup wizard screen opens.
3. Press **▲/▼/◀/▶** to highlight your OSD language, then press **OK**.
4. The channel tuning starts. Wait a few minutes for the tuning to complete.
5. When the tuning is finished, the TV will tune to the first channel stored on the channel list.

Note

- The initial setup process may vary depending on different systems. Follow the on-screen instructions to complete the setup.

Understanding the Basics

Turning the TV On or Off

1. Press **⏻** to turn on the TV. It may take a few seconds for an image to appear on the screen.
2. Press **⏻** to turn off the TV. The TV enters standby mode.

Note

- When the TV is off, power still flows into it. To disconnect power, unplug the power cord.

Selecting the Input Source

1. Press **SOURCE**. The input source list opens.



2. Press **▲/▼** to highlight the input source, then press **OK**.

Note

- HDMI3 input is not available for LE32F600.

Selecting a Channel

- Press **CH** **↶**/**CH** **↷** to go to the next or previous channel in the channel list.
- Press the number buttons to directly select a channel.
- Press **CH.LIST**/**☰** to open the channel list, then press **▲/▼** and **OK** to select a channel.
- Press **Q.VIEW** to go to the last viewed channel.

Using Favourite List

To watch a favourite channel:

1. Press **FAV**/**☰** to open the favourite list.
2. Press **▲/▼** to highlight a favourite channel, then press **OK** to tune to the channel. (See "Programme Edit" on page 11 for information about adding a favourite channel.)

Adjusting the Volume

- Press **↶+ / ↶-** to increase or decrease the volume.
- Press **🔇** to turn off the sound. Press **🔇** again to restore the sound.

Displaying Channel Information

- Press **INFO**/**ℹ** to display channel information such as channel number, channel name, audio information, etc. Press **INFO**/**ℹ** again to close the information banner.

Navigating the On-Screen Menu

1. Press **MENU**/**☰**. The on-screen menu opens.
2. Press **▲/▼** to highlight a main menu (CHANNEL/PICTURE/SOUND/TIME/OPTION), then press **OK** to access the sub-menu.
3. Press **▲/▼** to highlight a sub-menu item, then press **OK** to access the menu, or press **◀/▶** to adjust the setting or select a setting option.
4. Press **MENU**/**☰** to return to the previous menu, or press **EXIT**/**✖** to close the on-screen menu.

Using Your TV

Adjusting the Channel Settings

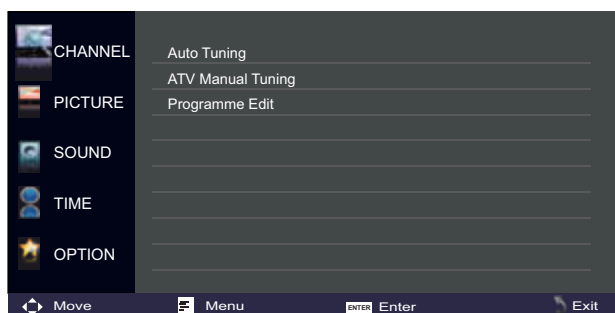

❖ Auto Tuning

To perform auto channel tuning.

📌 Note

- For Philippines NTSC system, before performing auto tuning, select your tune type first (Air/Cable).
- During the channel tuning, press **MENU**/ or **EXIT**/ to stop tuning. When the confirmation screen appears, select **Yes** to stop tuning, or select **No** to continue tuning.

❖ ATV Manual Tuning

To perform manual channel tuning.

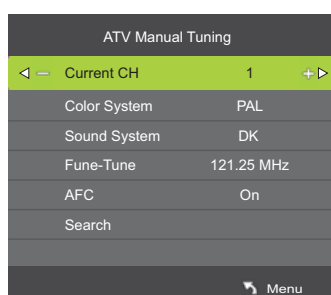

■ Current CH

Press / to select the channel number.

■ Color System

Press / to select the color system.

■ Sound System

Press / to select the sound system.

■ Fine-Tune

Press / to fine tune the frequency.

■ AFC (Auto Frequency Control)

Turn AFC on to automatically fine tune the frequency.

■ Search

Press to start channel tuning up from the selected frequency. Press to start channel tuning down from the selected frequency.

📌 Note

- When you perform searching, **AFC** setting will automatically change to **Off**.
- ATV Manual Tuning is not available for Philippines NTSC system.

❖ Programme Edit

To edit the channel list.



1. Press / to highlight the channel that you want to edit.

2. Use the shortcut buttons to edit the channel:

- Press red button to delete the selected channel.
- Press green button to rename the selected channel.

Press / to select the entry field, then press / to select the desired characters. When you have finished entering the channel name, press **OK**.

- Press yellow button to move the selected channel, then press / to select the preferred position and press yellow button again to move the channel to the selected position.
- Press blue button to skip the selected channel.

The channel will be skipped when you press the **CH** / **CH** buttons, but you can still tune to a skipped channel using the number buttons on the remote control.

- Press **FAV**/ to add the selected channel to the favorite list.

📌 Note

- For Philippines NTSC system, channel delete, rename and move functions are not available.

Adjusting the Picture Settings

CHANNEL	Picture Mode	User
PICTURE	Contrast	50
	Brightness	50
	Color	50
SOUND	Tint	50
	Sharpness	50
TIME	Color Temperature	Medium
OPTION		

❖ Picture Mode

To select the picture mode. You can select **Dynamic/Standard/Mild/User** according to the programme.

✎ Note

- You can also press **P.MODE** button to select the picture mode.
- Contrast, Brightness, Color, Tint, and Sharpness** are adjustable only when **Picture Mode** is set to **User**.

❖ Contrast

To adjust the intensity of the white level of the picture.

❖ Brightness

To brighten or darken the picture.

❖ Color

To adjust the color intensity of the picture.

❖ Tint

To adjust the color balance of the picture.

❖ Sharpness

To sharpen or soften the picture.

❖ Color Temperature

To select the colour temperature. You can select:

- Cool** – Give the white colour a bluish tint.
- Medium** – Give the white colour a neutral tint.
- Warm** – Give the white colour a reddish tint.

❖ Noise Reduction

To reduce the image noise and improve the picture quality.

Adjusting the Sound Settings

CHANNEL	Sound Mode	User
PICTURE	Treble	50
	Bass	50
	Balance	0
SOUND	Auto Volume	Off
	SPDIF Mode	Off
TIME		
OPTION		

❖ Sound Mode

To select the sound mode. You can select **Standard/Music/Movie/Sports/User** to suit your personal preference.

✎ Note

- You can also press **S.MODE** button to select the sound mode.
- Treble, and Bass** are adjustable only when **Sound Mode** is set to **User**.

❖ Treble

To adjust the high frequency sound.

❖ Bass

To adjust the low frequency sound.

❖ Balance

To adjust the balance between the left and right speakers.

❖ Auto Volume

Turn this setting on to keep the volume level consistent when switching channels or when switching from a TV show to a commercial.

❖ SPDIF Mode

To select the SPDIF digital audio output type.

Adjusting the Time Settings

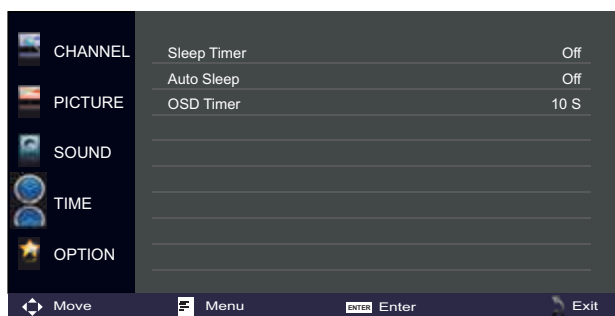

❖ Sleep Timer

To automatically turn the TV off after a set amount of time.

❖ Auto Sleep

To automatically turn the TV off if there is not any operation after a set amount of time.

❖ OSD Timer

To automatically close the on-screen menu if there is not any operation after a set amount of time.

Adjusting the Option Settings

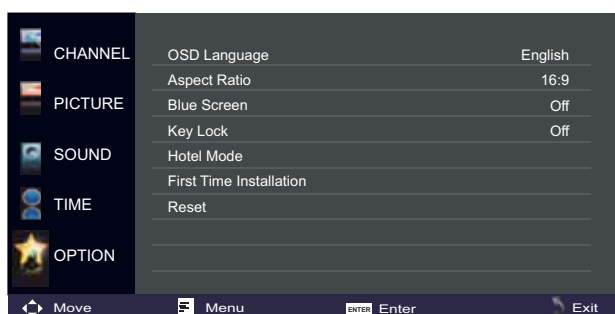

❖ OSD Language

To select the on-screen menu language.

❖ Aspect Ratio

To select the screen display mode.

❖ Blue Screen

Turn this setting on to display a blue screen when there is no input signal.

❖ Key Lock

Turn this setting on to lock the control buttons on the side of the TV.

❖ Caption (Philippines only)

To select the closed captioning mode.

Note

- You can also press the **CC**/ button to select the closed captioning mode.

❖ Hotel Mode

Hotel mode allows user to set certain default settings, limit access to certain controls and

adjustments so that settings cannot be altered by other people.

To access the hotel mode, you have to enter the 4-digit password. Default password is "0000". If your password is lost, enter universal password "9443".

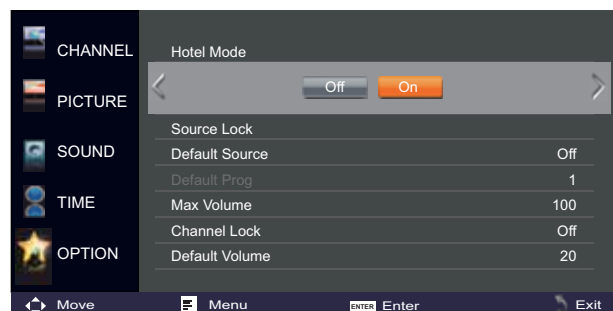

■ Hotel Mode

To turn hotel mode on or off.

Note

- Hotel mode settings will be grayed out and cannot be adjusted if **Hotel Mode** is set to **Off**.

■ Source Lock

To lock input sources.

- Press **▲/▼** to highlight the input source that you want to lock, then press **OK** to lock the source (On).
- Repeat above step until all the locked sources are set.

Note

- The locked input source will not be displayed on the Input Source list when you press **SOURCE** button.

■ Default Source

To select the default input source.

- Press **▲/▼** to highlight the input source that you want to set as the default input source, then press **OK**.

Note

- Those locked input sources will not be displayed on the Default Source list.
- If you select **Off**, the TV will turn on with the input source when it was last turned off.

■ Default Prog

To select the default channel if **Default Source** is set to **TV**.

- Press **◀/▶** to select the preferred default channel.

■ Max Volume

To set the maximum volume limit.

■ Channel Lock

To disable channel tuning and editing function.

■ Default Volume

To set the default volume level.

■ Clear Lock

To reset all the hotel mode settings to the factory defaults.

■ Set Password

To set a new password.

1. Use the number buttons on the remote control to enter your old 4-digit password.
2. Use the number buttons on the remote control to enter your new 4-digit password twice.
3. The new password is set and previous menu screen will be displayed.

❖ First Time Installation

To perform initial setup, including OSD language selection and channel tuning.

✎ Note

- First Time Installation setting is only available when the input source is TV.

❖ Reset

To reset all the settings to the factory defaults.

❖ Software Update (USB)

To perform software update using a USB device.

1. Insert the USB device with the update software file to the **USB IN** port on the back of the TV.
2. Select **Software Update (USB)**, then press ◀ to select **Yes** and start updating. When the update is completed, the TV will restart.

Adjusting the PC Settings

1. Press **SOURCE**, then press ▲/▼ to highlight **PC** and press **OK**.
2. Press **MENU** to open the on-screen menu.
3. Press **OK** to enter the PC menu.

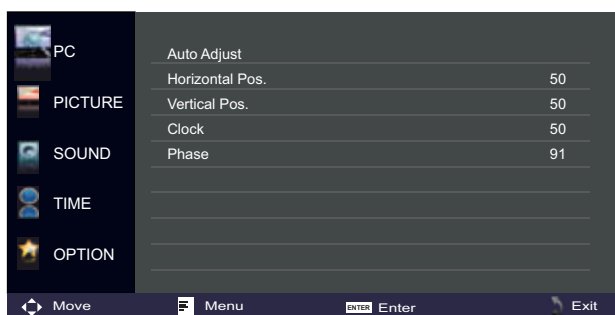

❖ Auto Adjust

Automatically adjust the image settings.

❖ Horizontal Pos.

Adjust the picture's horizontal position.

❖ Vertical Pos.

Adjust the picture's vertical position.

❖ Clock

Adjust the sample frequency.

❖ Phase

Adjust the focus of stable images.

Other Features

USB Media Player

The USB Media Player allows you to connect a USB thumb drive to your TV and play photos, music, videos and display text.

✎ Note

- The USB thumb drive must be formatted as FAT32.
- Files on the USB thumb drive must end in a supported file extension (*.mp3, *.jpg, *.mp4, etc).
- Files that are not supported will not be displayed.
- Some files may be unreadable due to individual file setting.
- The player is not designed to play media from external hard drives or mp3 players.

Supported file formats

Video file format		
File extension	Container	Video Decoder
*.avi	AVI	XviD/MPEG1/MPEG2 MP@HL/H.264 BP LV 4.0/H.264 MP LV 4.0/H.264 HP LV 4.0/MPEG-4 SP@HL 3.0/MPEG-4 ASP@HL 4.0/Motion JPEG
*.mp4 *.mov *.m4v	MP4	H.264 BP LV 4.0/H.264 MP LV 4.0 / H.264 HP LV 4.0/MPEG-4 SP@HL 3.0/MPEG-4 ASP@HL 4.0 /Motion JPEG (*.mov)
*.mkv	MKV	H.264 BP LV 4.0/H.264 MP LV 4.0/H.264 HP LV 4.0/MPEG-4 SP@HL 3.0/MPEG-4 ASP@HL 4.0
*.mpg *.mpeg	PS (Program)	MPEG-1/MPEG-2 MP@HL
*.ts	TS	MPEG-2 MP@HL/H.264 BP LV 4.0/H.264 MP LV 4.0 / H.264 HP LV 4.0

✎ Note

- For MPEG4 ASP profile, BVOP and 4MV are supported.
- For H.264 BP profile, FMO, ASO and redundant slice are not supported.

Audio file format		
File extension	Container	Audio Decoder
*.avi	AVI	MPEG1 Layer 1/2/ MP3 (MPEG1 Layer3)/MPEG2 AAC(AAC-LC)/ MPEG4 AAC-LC/ MPEG4 HE-AAC
*.wmv *.asf	ASF	MP3 (MPEG1 Layer3)
*.mp4 *.mov *.m4v	MP4	MPEG1 Layer 1/2/ MP3 (MPEG1 Layer3)/MPEG2 AAC(AAC-LC)/ MPEG4 AAC-LC/ MPEG4 HE-AAC
*.mpg *.mpeg *.vro *.vob	PS	MPEG1 Layer 1/2/ MP3 (MPEG1 Layer3)
*.ts	TS	MPEG1 Layer 1/2/ MPEG2 AAC(AAC- LC) (H.264)/MPEG4 AAC-LC (H.264)/ MPEG4 HE-AAC (H.264)
*.rm	RM	dnet: AC3 (RealAudio3)/cook: COOK (RealAudio6)/ raac: MPEG4 AAC-LC (RealAudio10)
*.FLV	FLV	PCM/MP3 (MPEG1 Layer3)/MPEG4 AAC-LC (H.264)/ MPEG4 HE-AAC (H.264)

Photo file format		
File extension	Container	Image Decoder
*.jpg	JPEG	Baseline/Progressive
*.bmp	BMP	-
*.png	PNG	Non-Interlaced/ Interlaced

Text file format	
File extension	Code
*.txt	ANSI/UNICODE GB/UTF8

 Note

- Supported maximum text file size is 1MB.

Using USB media player

1. Connect your USB thumb drive to the USB port on the back of the TV.

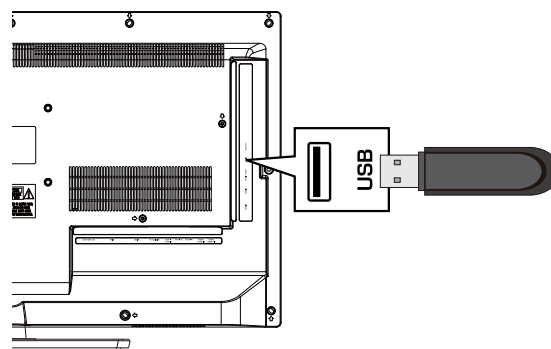

2. Press **SOURCE**, then **▲/▼** to highlight **Media** and press **OK** to switch to media mode.

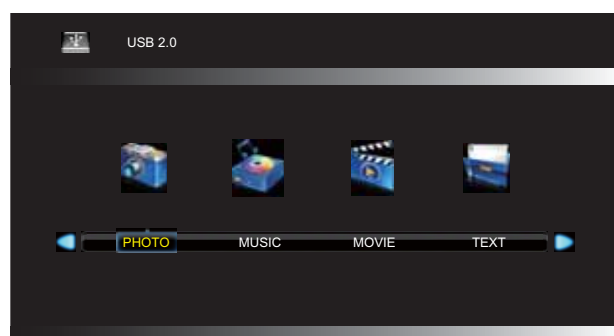

3. Press **◀/▶** to highlight the media type: **PHOTO**, **MUSIC**, **MOVIE**, or **TEXT** then press **OK**.
4. Press **◀/▶** to highlight the disk **C**, then press **OK**.
5. Thumbnails of the USB contents will be displayed. Use **▲/▼/◀/▶** and **OK** buttons to browse.

Browse Mode

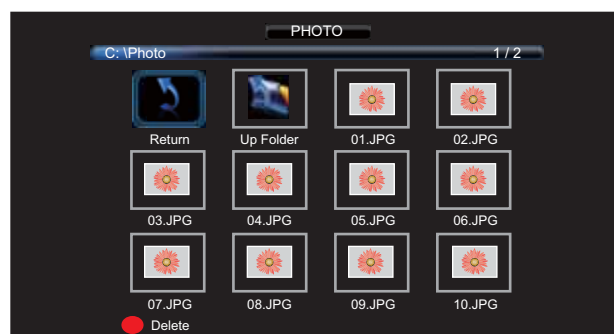

- Press **▲/▼/◀/▶** to highlight a file or folder, then press **OK** to play the file or open the folder.
- To return to the upper directory (if available), highlight **Up Folder**, then press **OK**.
- To return to the disk selection, highlight **Return**, then press **OK**.
- To delete a highlighted file, press the red button, then press **◀**.

Photo Mode



1. Press **OK** to open the operation banner.
2. Press **◀/▶** to highlight an option, then press **OK** to execute or toggle settings.

❖ Play/Pause

To play or pause the slide show.

❖ Prev.

To display the previous photo.

❖ Next

To display the next photo.

❖ Stop

To stop slide show and return to the thumbnail display.

❖ Repeat

To select the repeat mode of playing the files in the current folder.

❖ Music

To play the music in the current folder.

❖ Playlist

To display the photo file list of the current folder. Press **▲/▼** to highlight the desired file, then press **OK** to display the photo. Press **EXIT/☒** or press **▶** to highlight **Cancel** then press **OK** to close the list.

❖ Info.

To show the information of the displayed photo. Press **OK** again to close the information window.

❖ Rotate

Press **OK** repeatedly to rotate the photo 90° clockwise at a time.

❖ Rotate

Press **OK** repeatedly to rotate the photo 90° counterclockwise at a time.

❖ Zoom In

Press **OK** repeatedly to zoom in on the displayed photo.

❖ Zoom Out

Press **OK** repeatedly to zoom out on the displayed photo.

❖ Move View

To view a zoomed photo. Press **▲/▼/◀/▶** on the remote control to move and view the photo in detail. Press **EXIT/☒** to exit.

3. Press **EXIT/☒** or **▼** to close the operation banner.

Music Mode

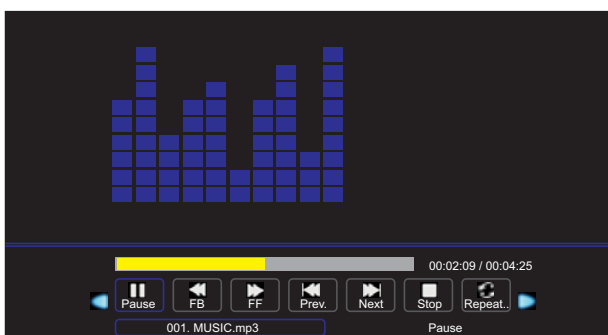

1. Press **◀/▶** to highlight an option, then press **OK** to execute or toggle settings.

❖ Play/Pause

To play or pause the music.

❖ FB

To fast reverse the music playback.

❖ FF

To fast forward the music playback.

❖ Prev.

To play the previous music file.

❖ Next

To play the next music file.

❖ Stop

To stop the music playback.

❖ Repeat

To select the repeat mode of playing the files in the current folder.

❖ MUTE

To turn the sound on or off.

❖ Playlist

To display the music file list of the current folder. Press **▲/▼** to highlight the desired file, then press **OK** to play the music. Press **EXIT/☒** or press **▶** to highlight **Cancel** then press **OK** to close the list.

❖ Info.

To show the information of the playing music file. Press **OK** again to close the information window.

❖ Goto Time

To jump to a specific playback time of the music.

Use ◀/▶ and number buttons on the remote control to enter the specific time, then highlight **OK** and press **OK** to jump to the specific point.

2. Press **EXIT/⊠** or ▼ to close the operation banner.

Movie Mode



1. Press **OK** to open the operation banner.
2. Press ◀/▶ to highlight an option, then press **OK** to execute or toggle settings.

❖ Play/Pause

To play or pause the video.

❖ FB

To fast reverse the video playback.

❖ FF

To fast forward the video playback.

❖ Prev.

To play the previous video file.

❖ Next

To play the next video file.

❖ Stop

To stop the video playback.

❖ Repeat

To select the repeat mode of playing the files in the current folder.

❖ Set A-B

To create a playback loop.

1. During playback, press **OK** at the point where you would like the playback loop to begin. This sets an "A" point.
2. Press **OK** again when the playback reaches the point where you would like the playback loop to stop. The sets a "B" point.

The section between points A and B will be played repeatedly in a loop until you press **OK** again.

❖ Playlist

To display the video file list of the current folder. Press ▲/▼ to highlight the desired file, then press **OK** to play the video. Press **EXIT/⊠** or press ▶ to highlight **Cancel** then press **OK** to close the list.

❖ Info.

To show the information of the playing video file. Press ▲/▼ to highlight **Close**, then press **OK** to close the information window.

❖ Slow Forward

To slow forward the video playback.

❖ Step Forward

Press **OK** repeatedly to step forward the video playback.

Press ◀/▶ to highlight **Play**, then press **OK**, or press ▶|| on the remote control to resume normal playback.

❖ Goto Time

To jump to a specific playback time of the video.

Use ◀/▶ and number buttons on the remote control to enter the specific time, then highlight **OK** and press **OK** to jump to the specific point.

❖ Zoom In

Press **OK** repeatedly to zoom in on the playing video.

❖ Zoom Out

Press **OK** repeatedly to zoom out on the playing video.

❖ Aspect Ratio

To select the display mode.

❖ Move View

To view a zoomed video. Press ▲/▼/◀/▶ on the remote control to move and view the video in detail. Press **EXIT/⊠** to exit.

3. Press **EXIT/⊠** or ▼ to close the operation banner.

Text Mode

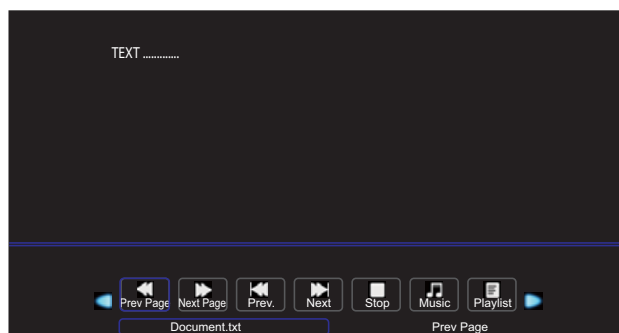

1. Press **OK** to open the operation banner.
2. Press **◀/▶** to highlight an option, then press **OK** to execute or toggle settings.

❖ Prev. Page

To display previous page of the file.

❖ Next Page

To display next page of the file.

📌 Note

- You can also press **◀/▶** to display the previous or next page of the file.

❖ Prev.

To display previous text file.

❖ Next

To display next text file.

❖ Stop

To stop text display.

❖ Music

To play the music in the current folder.

❖ Playlist

To display the text file list of the current folder. Press **▲/▼** to highlight the desired file, then press **OK** to display the text. Press **EXIT/☒** or press **▶** to highlight **Cancel** then press **OK** to close the list.

❖ Info.

To show the information of the displayed text file. Press **OK** again to close the information window.

3. Press **EXIT/☒** or **▼** to close the operation banner.

Teletext (Not available for Philippines NTSC system)

Teletext is an information system broadcast by certain channels, offering a range of text-based information, typically including national, international and sporting news, weather and TV schedules. It also provides subtitles for people with hearing difficulties or those who are unfamiliar with the language in which a particular programme is being broadcast.

❖ Teletext

To turn on teletext, press **CC/☒** button. To switch off teletext, press **CC/☒** button again.



❖ Page up/down

To display next or previous teletext page, press the **PAGE+/PAGE-** buttons.



❖ Page number entering

To select a teletext page, enter the page number using the number buttons on the remote control.

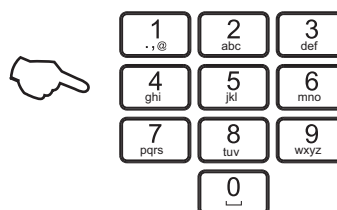

❖ Mix mode

To view the TV picture in teletext mode, press the **☒** button. This will superimpose the teletext data on top of the TV picture. Press **☒** button again to return to full text.



❖ Hold

To stop updating teletext page automatically, press the **FAV/☒** button. This feature is very useful when there are several teletext pages or lots of data on the same page number.



❖ Size

To switch the teletext image to Top, Bottom or Full, press the  button. This feature is very useful as it magnifies the image and makes the characters easier to read.



❖ Reveal

To reveal hidden information such as an answer to a quiz, press the  button.



❖ Subcode

To enter a secondary page, press  button and enter the 4-digit number.



❖ Hide

To hide the text, press the  button.



❖ Fast text coloured buttons

Fast text automatically displays the four most commonly used pages that the broadcaster thinks that you may want to choose next. Press the same coloured button on the remote control as the coloured link at the bottom of the teletext page to go directly to that page.







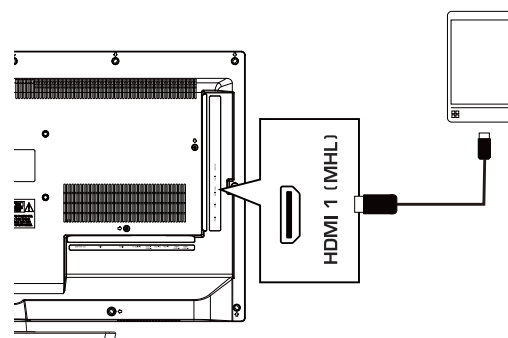

Using MHL Device (LE32A650 only)

Connect your MHL-enabled device, such as a cell phone or tablet, and view your device's screen on your TV. (MHL cable or HDMI cable with HDMI-to-MHL adapter are required)

1. Connect an MHL cable (not provided) to the micro USB port on the device, then connect the other end of the cable to the **HDMI 1 (MHL)** jack on the back of your TV.





2. The TV will switch to HDMI1 source automatically. The home menu of the device will be displayed on TV screen.
3. To navigate your device using the remote control:
 - Press /// to navigate up/down/left/right on the device.
 - Press 0-9 to enter numbers.
 - Press **OK** to confirm a selection or play a file.
 - Press **BACK**/ to return to the previous menu.
 - Press **EXIT**/ to return to the home menu of the device.
 - Press  to open the home menu of the device.

Note

- The buttons you use to navigate on your device may vary depending on the device.

Appendix

Troubleshooting

Symptoms	Items to Check and Actions to Follow
No power	<ul style="list-style-type: none"> • Check if the TV's AC power cord is plugged into a working power outlet. • Unplug the TV, and wait 60 seconds. Then reinsert plug into the working power outlet and turn on the TV again.
No picture	<ul style="list-style-type: none"> • Make sure correct input source is selected. • Check antenna connection on the back of the TV to see if it is properly connected. • Possible broadcast station trouble. Try another channel. • Adjust the picture contrast and brightness settings.
Good picture but no sound	<ul style="list-style-type: none"> • Increase the volume level by pressing  + button on the remote control or VOL+ button on TV side control panel. • Press  button on the remote control to ensure mute is off.
Good sound but poor color	<ul style="list-style-type: none"> • Adjust the contrast, color and brightness settings.
Poor picture	<ul style="list-style-type: none"> • Poor picture quality may occur when an activated S-VHS camera or camcorder is connected to your TV and the other peripheral at the same time. Switch off one of the peripherals.
Snowy picture and noise	<ul style="list-style-type: none"> • Check the antenna connection.
TV not responding to remote control	<ul style="list-style-type: none"> • Check whether the batteries are working. Replace if necessary. • Make sure the remote control batteries are installed correctly. • You can still use the control buttons on the side of your TV.
TV not working	<ul style="list-style-type: none"> • Disconnect the TV from the power supply for 10 seconds, then reconnect the TV. If the problem persists, contact authorised service personnel for technical assistance.
No file displayed in USB mode	<ul style="list-style-type: none"> • Make sure you select correct media type. • Make sure the stored files are in supported format.

Note

- If the problem is not solved by following these troubleshooting instructions, consult your local authorised service centre.
- The TV set must only be repaired by qualified, registered service personnel. Never attempt to remove the back cover, as the TV set contains dangerous voltage that may cause injury or fire.

Specification

Specifications are subject to change without notice.

Model	LE32A650	LE32F600
Picture/sound system	PAL/SECAM - B/G, I, D/K (For Philippines, NTSC-M only)	
Power consumption	60W	45W
Audio output	10W + 10W	10W + 10W
Rear connectors	Component In (YPbPr) Composite In (CVBS, share Y input) YPbPr/CVBS Audio In USB HDMI 1/HDMI 2/HDMI 3 In Earphone Out Digital Audio Out (Coaxial) Antenna (RF IN) VGA In (PC) PC Audio In	Component In (YPbPr) Composite In (CVBS, share Y input) YPbPr/CVBS Audio In USB HDMI 1/HDMI 2 In Earphone Out Digital Audio Out (Coaxial) Antenna (RF IN) VGA In (PC) PC Audio In
Temperature	Working: +5°C ~ +35°C Storage: -15°C ~ +45°C	
Humidity	Working: 20% ~ 80% Storage: ≤80%	
Accessories	Remote control/AAA battery x 2/Instruction manual/Warranty card/TV stand with screws/Power cord (LE32F600 only)	
Dimensions (with stand) (W x H x D)	728.26 x 467.86 x 181.31 mm	731.87 x 477.17 x 207.15 mm
Dimensions (w/o stand) (W x H x D)	728.26 x 434.26 x 77.07 mm	731.87 x 440.96 x 75.00 mm
Weight (with stand)	7.5 kg	5.8 kg
Weight (w/o stand)	7.12 kg	5.4 kg
Wall mounting (H x V)	100 x 100 mm	100 x 100 mm



HDMI, the HDMI logo, and High-Definition Multimedia Interface are trademarks or registered trademarks of HDMI Licensing LCC in the United States and other countries.

MHL™ (Mobile High-Definition Link) (LE32A650 only)



MHL and the MHL logo are a trademark, registered trademark or service mark of MHL, LLC in the United States and/or other countries.

Haier

Free Manuals Download Website

<http://myh66.com>

<http://usermanuals.us>

<http://www.somanuals.com>

<http://www.4manuals.cc>

<http://www.manual-lib.com>

<http://www.404manual.com>

<http://www.luxmanual.com>

<http://aubethermostatmanual.com>

Golf course search by state

<http://golfingnear.com>

Email search by domain

<http://emailbydomain.com>

Auto manuals search

<http://auto.somanuals.com>

TV manuals search

<http://tv.somanuals.com>