

**Hamilton
Beach®**

Slow Cooker
慢炖锅

型号：SCO-25H
货号：C33130
容量：2.5升

READ BEFORE USE

使用前请阅读

此说明书中图片仅供参考，
产品以实物为准。

中国大陆免费客服热线：
400-852-2655
官方网站：
<http://www.hamiltonbeach.cn>
840225500

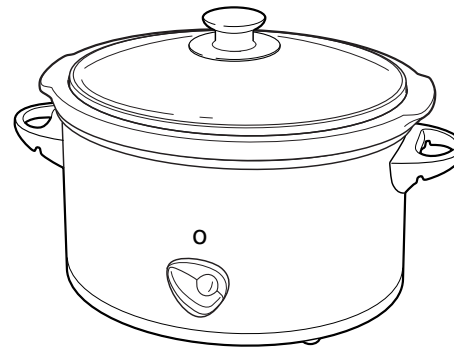

English 2

中文 9

IMPORTANT SAFEGUARDS

When using electrical appliances, basic safety precautions should always be followed to reduce the risk of fire, electric shock, and/or injury to persons, including the following:

1. Read all instructions.
2. Do not touch hot surfaces. Use handles or knobs.
3. To protect against electrical shock do not immerse cord, plug, or base in water or other liquid.
4. Close supervision is necessary when any appliance is used by or near children.
5. Unplug from outlet when not in use and before cleaning. Allow to cool before putting on or taking off parts.
6. Do not operate any appliance with a damaged cord or plug, or after the appliance malfunctions or is dropped or damaged in any manner. Call our toll-free customer service number for information on examination, repair, or adjustment.
7. The use of accessory attachments not recommended by the appliance manufacturer may cause injuries.
8. Do not use outdoors.
9. Do not let cord hang over edge of table or counter, or touch hot surfaces, including stove.
10. Do not place on or near hot gas or an electric burner, or in a heated oven.
11. Extreme caution must be used when moving an appliance containing hot oil or other hot liquids.
12. To disconnect slow cooker, turn control knob to OFF then remove plug from wall outlet.
13. Caution: To prevent damage or shock hazard do not cook in base. Cook only in removable crock.
14. Avoid sudden temperature changes, such as adding refrigerated foods into a heated crock.
15. Do not use appliance for other than intended use.

SAVE THESE INSTRUCTIONS!

OTHER CONSUMER SAFETY INFORMATION

This product is intended for household use only.

This product is only intended for the preparation, cooking, and serving of foods. This product is not intended for use with any non-food materials or products.

WARNING! Shock Hazard: This appliance has a polarized plug that reduces the risk of electric shock. The plug fits only one way into a polarized outlet. Do not defeat the safety purpose of the plug by modifying the plug in any way or using an adaptor. If the plug does not fit, reverse the plug. If it still does not fit, have an electrician replace the outlet.

The length of the cord used on this appliance was selected to reduce the hazards of becoming tangled in, or tripping over a longer cord. If a longer cord is necessary an approved extension cord may be used. The electrical rating of the extension cord must be equal to or greater than the rating of the appliance. Care must be taken to arrange the extension cord so that it will not drape over the counter-top or tabletop where it can be pulled on by children or accidentally tripped over.



CROCK AND LID: PRECAUTIONS AND INFORMATION

- Please handle crock and lid carefully to ensure long life.
- Avoid sudden, extreme temperature changes. For example, do not place a hot lid or crock into cold water, or onto a wet surface.
- Avoid hitting crock or lid against faucet or other hard surfaces.
- Do not use crock or lid if chipped, cracked, or severely scratched.
- Do not use abrasive cleansers or metal scouring pads.
- The bottom of crock is very rough and can damage countertop. Use caution.
- The crock and lid can become very hot. Use caution. Do not place directly on any unprotected surface or countertop.
- The crock is microwave safe and oven proof, but never heat crock when empty. Never place lid on a burner or stove top. Do not place lid in a microwave oven, conventional oven, or on stove top.

REMOVING LID AND CROCK

When removing lid, tilt so that opening faces away from you to avoid being burned by steam.

The sides of the slow cooker's base get very warm because the heating elements are located here. Use handles on base if necessary. Use hot mitts to remove crock.

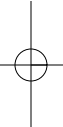

Parts and Features

Crock Capacity

For best results, fill the crock at least half-full but no more than one inch from the rim. If only half-filled, check for doneness 1 to 2 hours earlier than recipe.

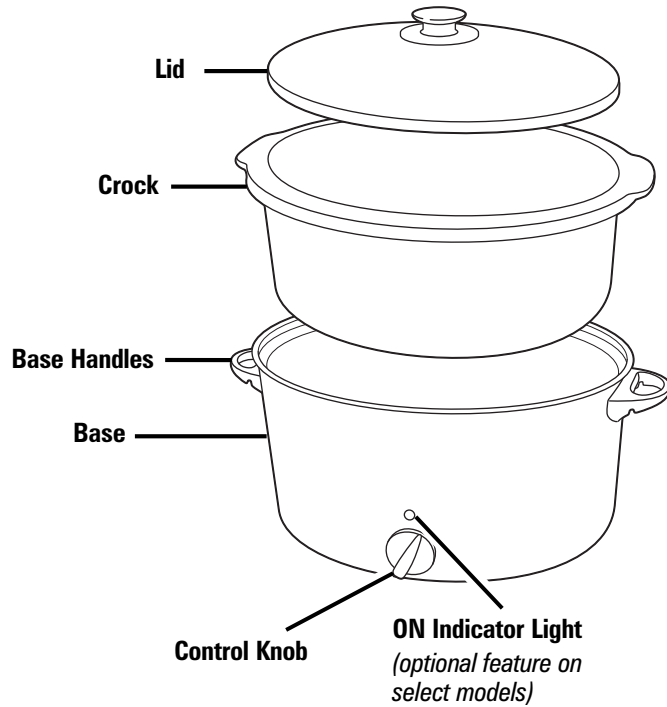

Specifications

Model No.	SCO-25H
Power	AC220V, 50Hz
Capacity	2.5L
Low Setting Power	115w
High Setting Power	155w
Keep Warm Power	40w

How to Use Your Slow Cooker

Before First Use: Wash lid and crock in hot, soapy water. Rinse and dry.

⚠ WARNING Food Safety Hazard. Food must be hot enough to prevent bacterial growth before using Keep Warm setting. The Keep Warm setting should only be used after a recipe has been thoroughly cooked. Do not reheat food on Keep Warm setting. If food has been cooked and then refrigerated, reheat it on Low or High, then switch to Keep Warm.

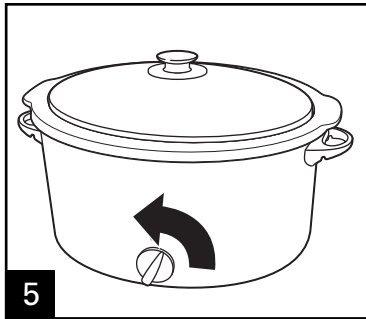
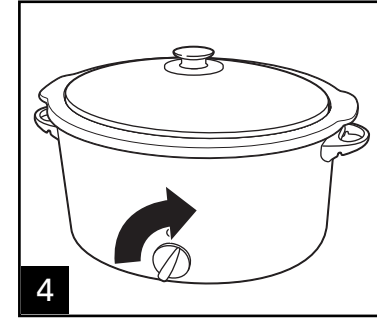
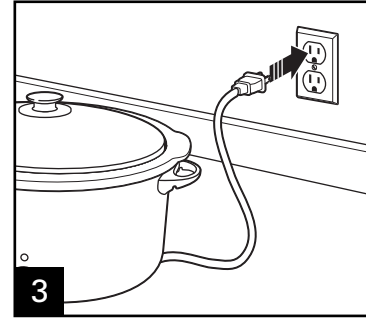
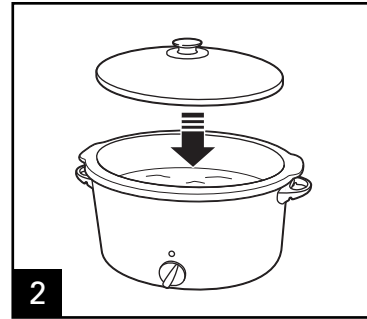
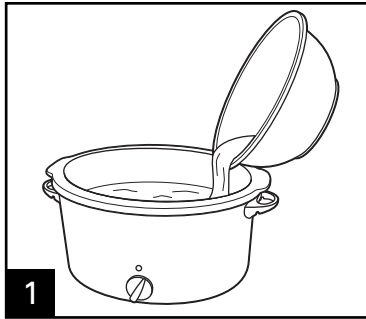

When cooking is finished, turn OFF.

Cleaning and Care

⚠ WARNING

Electrical Shock Hazard.

Disconnect power before cleaning. Do not immerse cord, plug, or base in any liquid.

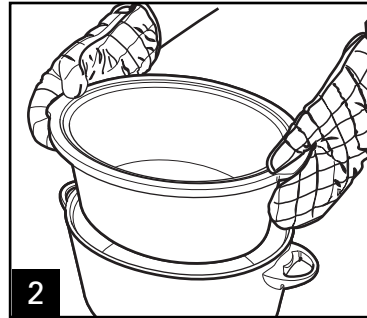
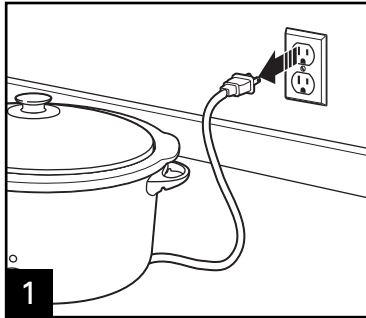

Remove crock and let cool.

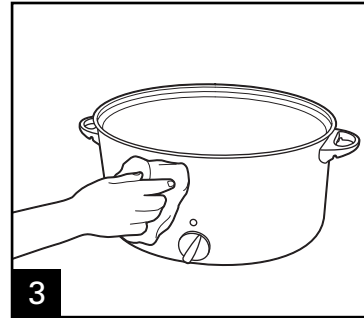

How to Use Lid Latch™ (optional feature on some models)

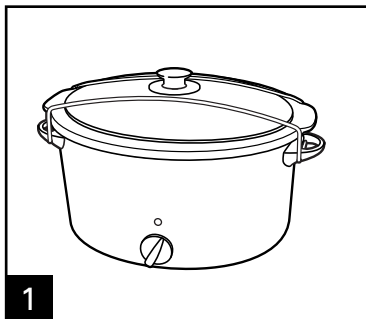

Place latch into groove under one handle. Stretch to other side and secure in groove under other handle.

6

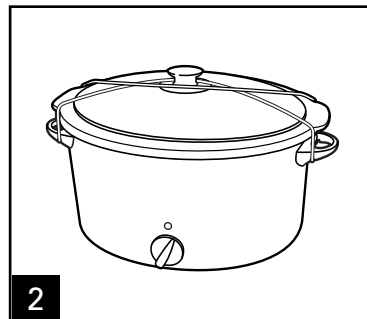

Once attached, latch can also be crossed over knob to further secure lid.

The Lid Latch™ helps secure lid while moving, transporting, or storing slow cooker.

Tips for Slow Cooking

- The crock should be at least half-filled for best results. If only half-filled, check for doneness 1 to 2 hours earlier than recipe.
- Stirring is not necessary when slow cooking and removing glass lid results in major heat loss and the cooking time may need to be extended. However, if cooking on High, you may want to stir occasionally.
- If cooking soups or stews, leave a 2-inch (5 cm) space between the top of the crock and the food so that the recipe can come to a simmer.
- Many recipes call for cooking all day. If your morning schedule doesn't allow time to prepare a recipe, do it the night before. Place all ingredients in crock, cover with lid and refrigerate overnight. In the morning, simply place crock in slow cooker.
- Do not use frozen, uncooked meat in slow cooker. Thaw any meat or poultry before slow cooking.
- Some foods are not suited for extended cooking in a slow cooker. Pasta, seafood, milk, cream, or sour cream should be added 2 hours before serving. Evaporated milk or condensed soups are perfect for slow cooking.
- The higher the fat content of meat, the less liquid is needed. If cooking meat with a high fat content, place thick onion slices underneath so meat will not sit on (and cook in) fat.
- Slow cookers allow for very little evaporation. If making your favorite soup, stew, or sauce, reduce liquid called for in original recipe. If too thick, liquid can be added later.
- If cooking a vegetable-type casserole, there will need to be liquid in the recipe to prevent scorching on the sides of crock.

Troubleshooting

POTENTIAL PROBLEM

PROBABLE CAUSE

Food is undercooked.

- Was food cooked on the Keep Warm setting? Do not cook on Keep Warm; always cook on Low or High heat settings.
- Was power interrupted?
- Did you select the Low heat setting, but use a cooking time based on the High heat setting?
- Did you have the lid placed correctly on the slow cooker?

The food isn't done after cooking the amount of time recommended in my recipe.

- This can be due to voltage variations (which are commonplace everywhere) or altitude. The slight fluctuations in power do not have a noticeable effect on most appliances. However, it can alter the cooking times in the slow cooker by extending the cooking times. Allow sufficient time and select the appropriate heat setting. You will learn through experience if a shorter or longer time is needed.

My meal was overcooked. Why?

- Was the crock at least half-full? The slow cooker has been designed to thoroughly cook food in a filled crock. If the crock is only half-filled, check for doneness 1 to 2 hours earlier than recipe time.
- Did you select correct number of hours based on cooking temperature (Low or High)?
- Foods will continue to increase in temperature after desired temperature has been reached.

Lid gasket collapsed.

- This can be caused by sudden temperature change, like running cold water over a warm lid. Allow lid to sit at room temperature. It will return to the original shape within 24 hours.
- To help maintain the shape of the gasket, do not cook with clips latched and do not store empty unit with clips latched.

重要安全说明

当使用带电设备时，为降低火灾、电击风险以及对个人造成的伤害，请注意基本的安全预防措施，具体如下：

1. 阅读所有说明。
2. 请勿接触设备热表面，请使用把手或者旋钮。
3. 为防止电击危险，请勿将设备的线缆、插头、或底座浸入水或其他液体中。
4. 当设备由儿童使用、或在其附近使用时，应予以密切监护。
5. 在设备不工作时及清理前，请从插座中拔出插头。待设备冷却后，方能增加或移除部件。
6. 请勿使用任何损坏的线缆或插头操作设备，或在设备故障、跌落或因任何方式损坏后使用。请拨打我们的免费客户服务电话以获取检查、修理或调整的相关信息。
7. 使用非本产品制造商推荐的配套附件有可能造成危害。
8. 请勿在室外使用。
9. 请勿将电源线缆悬挂在桌子或柜台边缘，或接触包括炉子在内的热表面。
10. 请勿将设备放置于热燃气、电炉、热烤箱之上或附近。
11. 当设备内盛有热油或其他热液体时，在移动设备时更需格外谨慎。
12. 如果要断开慢炖锅电源，请将控制旋钮转至关(OFF)档并将插头从插座中拔出。
13. 注意：为防止危害或电击，请勿使用底座直接烹饪，仅在可移动内胆内烹饪。
14. 避免突然的温度改变，如将冷冻食物放入已加热的内胆中。
15. 请勿将设备作设计之外功能使用。

请保留这些说明！

其他用户安全信息

此设备仅供家庭使用。

此设备仅用于食物的准备、烹饪及服务。此设备不能使用非食物类的材料和产品。

警告！电击危险：此设备带有地线插头以降低电击危险。此插头仅适用于地线插座。请勿以任何方式改造此插头或使用转换接头，而使其丧失安全功能。如果插头无法插入，请尝试翻转插头。如果仍然无法插入，请找电工更换插座。

此设备使用的电源线缆长度经过设计挑选，以降低线缆缠结或过长导致误绊的危害。如需使用更长的线缆，可使用经过认可的加长线缆。加长线缆的电性能需等同或优于此慢炖锅的电性能。加长线缆需谨慎安置以免其挂于橱柜面或桌面而因此可能被儿童拉扯或导致误绊。

陶制内胆及玻璃盖：预防措施及信息

- * 请小心使用内胆和玻璃盖，以保证长使用寿命。
- * 避免突然或极端的温度改变。例如，请勿将灼热内胆或玻璃盖置于冷水中，或放置于潮湿的表面上。
- * 避免内胆或玻璃盖与水龙头或其他硬表面发生碰撞。
- * 如内胆或玻璃盖缺损、开裂或严重刮伤时，请勿使用。
- * 请勿使用具有腐蚀作用的清洁剂和金属清洁用品。

- * 内胆底部非常粗糙，有可能损坏厨台。请谨慎使用。
- * 内胆和玻璃盖在使用时会变得非常灼热，请谨慎使用。请勿将其直接放置于任何未经保护的表面或厨台上。
- * 内胆可微波加热且耐热，但请勿空烧。勿将玻璃盖和内胆置于电炉或燃气灶上。请勿将玻璃盖置于微波炉、传统烤箱内或火炉上。

移走玻璃盖和内胆

移走玻璃盖时，适度倾斜远离打开锅面以避免蒸汽烫伤。

因加热单元置于慢炖锅底座侧面，此处在使用时会变热。如有必要请使用底座把手。请使用隔热手套移除内胆。

部件及特征

内胆容积

为保证最佳烹饪效果，请至少将内胆装至半满，但不能超过内胆口2.5厘米。如果内胆仅半满，请比原定食谱时间提前一到两小时检查食物煮熟程度。

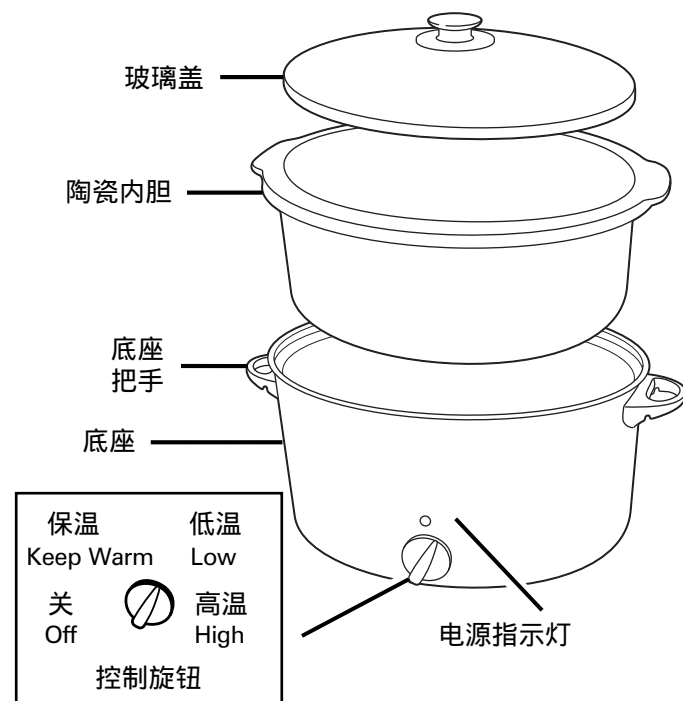

产品规格

型号	SCO-25H
电源	AC220V, 50Hz
容量	2.5L
低温功率	115w
高温功率	155w
保温功率	40w

如何使用您的慢炖锅

第一次使用前：请用热肥皂水清洗内胆，清洗后弄干。

警告

食品安全危害：在使用保温档时，食物应当彻底热透以防细菌滋生。只有在食材被彻底烹饪后方能使用保温档。请勿使用保温档再次加热食物。如果食物已经被煮熟或者冷藏过，请用高/低两档重新加热后再使用保温档。

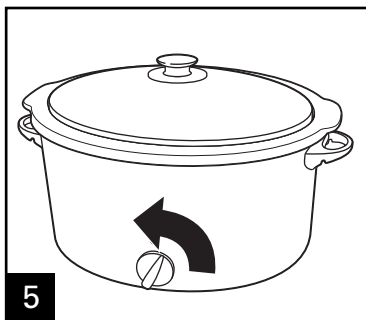
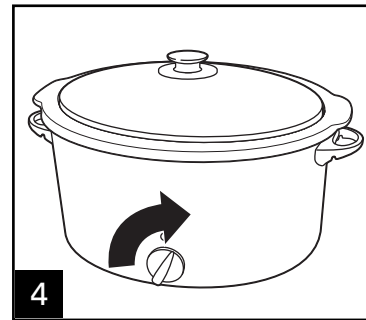
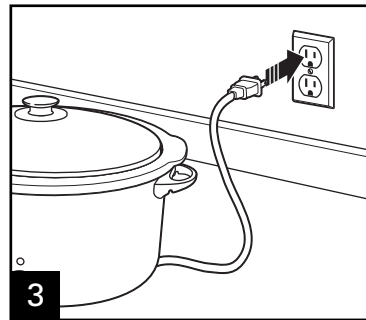
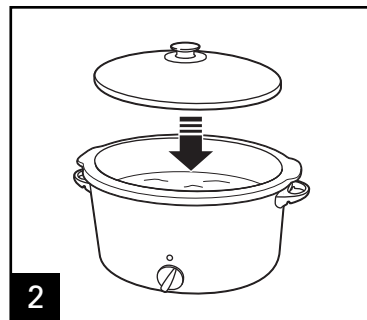
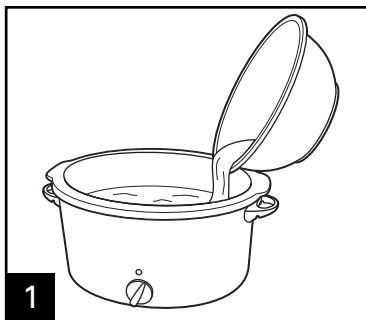

烹饪结束后，请将旋钮拧至关(OFF)档。

12

接通电源后，将旋钮拧至高(HIGH)档或者低(LOW)档进行烹饪。炖好食物后，可将旋钮拧至保温(KEEP WARM)档进行保温。

* 请勿使用保温(KEEP WARM)档烹饪。

* 烹饪时间：

高(HIGH)档：6小时左右。

低(LOW)档：12小时左右。

妥善放置及清理

警告

电击危险。

在清理前请断开电源。请勿将电源线、插头或底座浸入任何液体中。

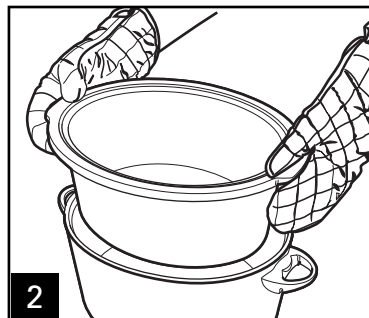
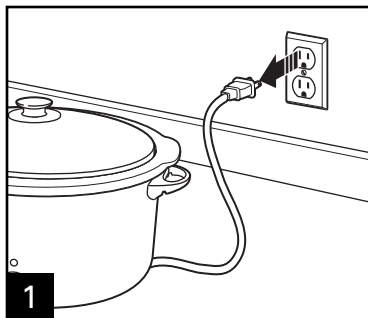

取出内胆并让其自然冷却。

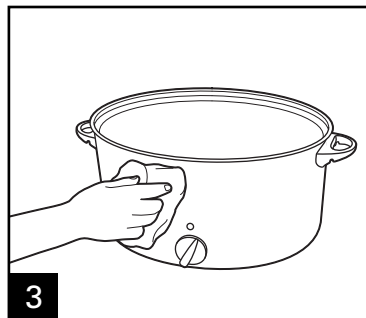

如何使用玻璃盖扣紧绳 (指定型号可选)

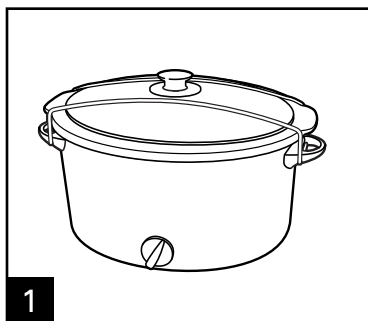

将扣紧绳一端扣在底座把手下的卡口内，将另一端扣在另一边把手卡口内。

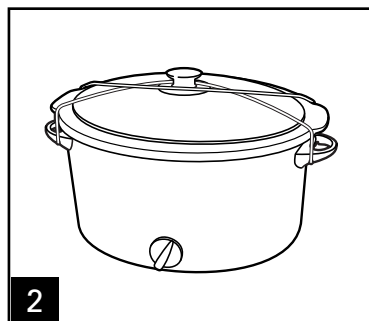

扣紧绳扣好后，可将其交叉扣在玻璃盖把手上以保证更加紧固。

玻璃盖扣紧绳可在慢炖锅移动、运输或储存时保证玻璃盖不移动。

慢炖贴士

- * 内胆中至少要装满一半食物方能达到最佳烹饪效果。当内胆中只装满一半时，请按照食谱时间提前1至2小时检查食物煮熟程度。
- * 慢炖食物时不需要搅拌，打开玻璃盖会造成大量热量损失，因此可能会导致烹饪时间加长。尽管如此，当在高(High)档烹饪时，可以适当偶尔搅拌食物。
- * 在烹饪汤或者炖菜时，请在内胆顶部与食材之间留出5厘米的空间以便能够煮沸食材。
- * 许多食谱需要烹饪一整天。如果你早上无瑕准备食谱，可在前夜准备。将所有食材放入内胆盖上盖子整夜冷藏，第二天早上只需将内胆放入慢炖锅中烹饪即可。
- * 有些食物不适宜在慢炖锅中长时间烹饪。意大利面、海鲜、牛奶、奶油或者酸奶油应在上菜前2小时加入慢炖锅。脱水牛奶或者浓缩汤最适合慢炖锅烹饪。
- * 肉类的脂肪含量越高，慢炖时需要的水越少。若慢炖的肉脂肪含量很高，可在底部放些厚洋葱片，这样可防止油煎。
- * 慢炖锅基本没有蒸发效果。若烹饪汤、炖菜或酱类食物，可根据原始食谱规定的液量稍作减少。若液量较大，可稍后添加。
- * 若烹饪蔬菜类砂锅，食谱中应包含液体以避免内胆侧烧焦食材。
- * 若食材内包含根茎类蔬菜，请将其放在内胆底部。

故障排除

故障现象

可能原因

炖出的食物半生不熟。

- * 是不是保温档炖的食物？请勿使用保温档烹饪，只用高温或低温档烹饪。
- * 电源是否中断过？
- * 您是不是选择了低温档，但是按照高温档设定的时间烹饪的？
- * 玻璃盖是否正确盖在慢炖锅上？

用菜谱建议的烹饪时间没有炖好食物。

- * 可能因电压不稳(在各地都常见)或海拔的缘故。此类电源起伏变化对大多数电器影响并不显著。然而，此种现象会影响慢炖锅的烹饪时间。低于额定的电压将需要更长时间来烹饪，反之高于额定电压则需时较短。具体请根据您的实际使用经验调整。

为什么食物会煮过头？

- * 内胆是否至少半满？此慢炖锅设计用于彻底煮熟满锅食物。若内胆中半满，请将食谱时间提前1至2小时检查食物煮熟程度。
- * 根据烹饪温度(高温或低温)您是否正确选择了烹饪时间？
- * 达到需求温度后，食物温度仍然会持续上升。

玻璃盖垫圈变形

- * 为保持垫圈的形状不变，请勿在烹饪时扣上玻璃盖扣具，而且请勿在慢炖锅空置时扣上扣具。
- * 此种情形有可能因突然的温度改变而引起，如灼热玻璃盖突遇冷水。请将玻璃盖放置于室温下。垫圈将在24小时内恢复原状。

以上内容如有改动，恕不预先通知。

Free Manuals Download Website

<http://myh66.com>

<http://usermanuals.us>

<http://www.somanuals.com>

<http://www.4manuals.cc>

<http://www.manual-lib.com>

<http://www.404manual.com>

<http://www.luxmanual.com>

<http://aubethermostatmanual.com>

Golf course search by state

<http://golfingnear.com>

Email search by domain

<http://emailbydomain.com>

Auto manuals search

<http://auto.somanuals.com>

TV manuals search

<http://tv.somanuals.com>