

HASHIMA

ハシマコンパクトプレス

HASHIMA COMPACT PRESS

HP-400C(CS)

取扱い説明書

INSTRUCTION MANUAL

この度はハシマ製品をご購入頂き、誠に有難うございます。
本機の性能を生かし、安全に使って頂くために、御使用前にこの取扱い
説明書を必ずお読み下さい。
お読みになった後は、必ず保管して頂き、必要に応じてお読み下さい。

Thank you very much for having brought our products .
Don't fail to fulfil the matters that dememand special attention to be menioned
below so that you could put this machine to use for a long time with safety .
Don't fail ti read the user's manual first of all when you've come to hand
the machine .
Keep this user's manual with care and read it as occation demands .



HASHIMA CO.,LTD.

Prior to use

Thank you very much for having brought our products.

Don't fail to fulfil the matters that demand special attention to be mentioned below so that you could put this machine to use for a long time with safety.

Don't fail to read the user's manual first of all when you've come to hand the machine.

Ensure the machine type you've brought prior to use, as this user's manual is the one for the

HP-400C (CS)

Ensure ration table of the main unit of the machine as well as style and design of the manipulation panel or those of the whole unit, referring to the illustrations on the user's manual or the catalogue.

Don't use the machine and bring into contact with the store you had bought it as early as possible when you've found your machine to be different from the very one you had ordered and so forth.

Keep this user's manual with care and read it as occasion demands.

Ensure the accessoried things

T-Type box wrench M13



Driver



Hex wrench (M2 3 4 5)



Spanner (10-13)





Magnet 2







You should fulfil following explanations for the prevention of the user and the others from being hurt and the proprieties from being damaged.

- We divide and explain you the degrees of peril and damage to be taken place when you'll neglect the contents of the display and use the machine erroneously.

 DANGER	: This display tells you the contents that imagine "the imminence of the danger that might result in death or a serious injury".
 WARNING	: This display tells you the contents that imagine "the possibility of death or a serious injury".
 CAUTION	: This display tells you the contents that imagine "the possibility of resulting in to be handicapped or material damages exclusively".

- We divide and explain you the contents you should fulfil in accordance with the following illustrations. (Following is an example of the illustrations.)

	: This illustration tells you the contents "that demand attention" you must pay.
	: This illustration tells you the contents of "prohibition" you should not do at all.
	: This illustration tells you the contents of "enforcement" you should excute without fail.

 **DANGER**

Don't get the children to use alone and don't use where the infants can make contact with.

 For fear of burn, electric shock and injury.

Never reform at all.

 For fear of fire and injury due to unusual movement.

Disassembly prohibited.

 **WARNING**

Don't disassemble and repair absolutely except the repair technician.

 Disassembly prohibited.

For fear of fire and injury due to unusual movement. (Contact to the dealers for repair in the case of damage and troubles)

Connect with the power source with ratio consumption suitable to the machine and don't fail to ground.

 Unusual heat might result in fire or electric leak, when you put the machine to use along with other apparatus. (Contact to the electric construction work shops nearestby.)

Disconnet the power source (the pulg and installed breaker) out of the origin.

 For fear of burn as well as electric shock and leak that might result in fire.

WARNING

Don't fail to disconnect such power source breaker and the wait for the time when the temperature of the machine would have cooled down completely prior to the operation.



For fear of burn, and injury.

Don't make contact directly to the interior of the main body nor to the belt.

For fear of burn.



Contact prohibited

Pay sufficient attention when you insert the material.



Contact prohibited

Some part of your body and your clothes would be caught in the machine, resulting in injuries.

Don't mount nor put things on the main unit.



For fear of burn, and injury. (For fear of high temperature might result in burn and fire, and there is a possibility of falling down to be injured. Due to electric shock and unusual movement.)

Install the machine on the robust stand or onto the floor horizontally.



For fear of overturning or falling down resulting in injury.

Don't put things easy to burn around the machine.



For fear of causing fire and so on.

CAUTION

- Don't install the machine to the site with high humidity. (For fear of causing electric leaks.)
- Don't bend nor crush the power source cord. (For fear of electric shock and shortage, resulting in fire.)
- Don't fail to disconnect the power source. When you put the manual handle to use. And, don't fail to put the hole cover except when you will put the manual handle to use for fear that the emergency handle might start turning resulting in injuries.
- Don't get the human being to go near by except the personnels.

PETITION

- There might be a case when the covers will be very hot, depending on the temperature, as this is the machine to be used in high temperature. Pay attention to your clothes not to be burned.
- Ensure using the timer that the machine has stopped and don't fail to disconnect the power source breaker.
- When you take away the material wound onto the strip off device, and when you clean the rotary strip off feather and the scraper, don't fail to disconnect the power source breaker and wait for the time when the temperature of the machine would have cooled down completely prior to the operation. Moreover, when you take the finished material out of the exit, pay sufficient attention not to be caught in the strip off device.
- Clean the belt with a well dried floorcloth when the operation is over. But, reduce the belt speed with sufficient attentions at the exit side of the finished material of the machine for feat of such accidents as burn and caught-in.
- Inspect the belt cleaner every day. And lubricate to every part once a month. By the way, don't fail to disconnect the power source breaker and wait for the machine to be cooled completely, before the excution for fear of such accidents as burn and caught-in.
- Manipulate the machine when you've understood well the operation of the switches.
- Prepare a space necessary for the maintenance around this machine.
- This machine is equipped with the emergency stop runction in view of the warping on the part of the belt. If the material is within the machine when it has stoped because of an emergency stop or the electric failure, don't fail to disconnect the power source, before you'll unload the material using the accessoried manual handle.

By putting "warning label" onto every part of the machine, we prevent the user and others From being hurt and proprieties from being damaged.

- Ensure the position and contents in regard to the "warning label" prior to the use.
- Neither remove nor reform the "warning label".
- Put a new one immediatly when the old "warning label" is hard to read or when it is come off.

Attention to be paid
at the time of using seal
Holding's pick

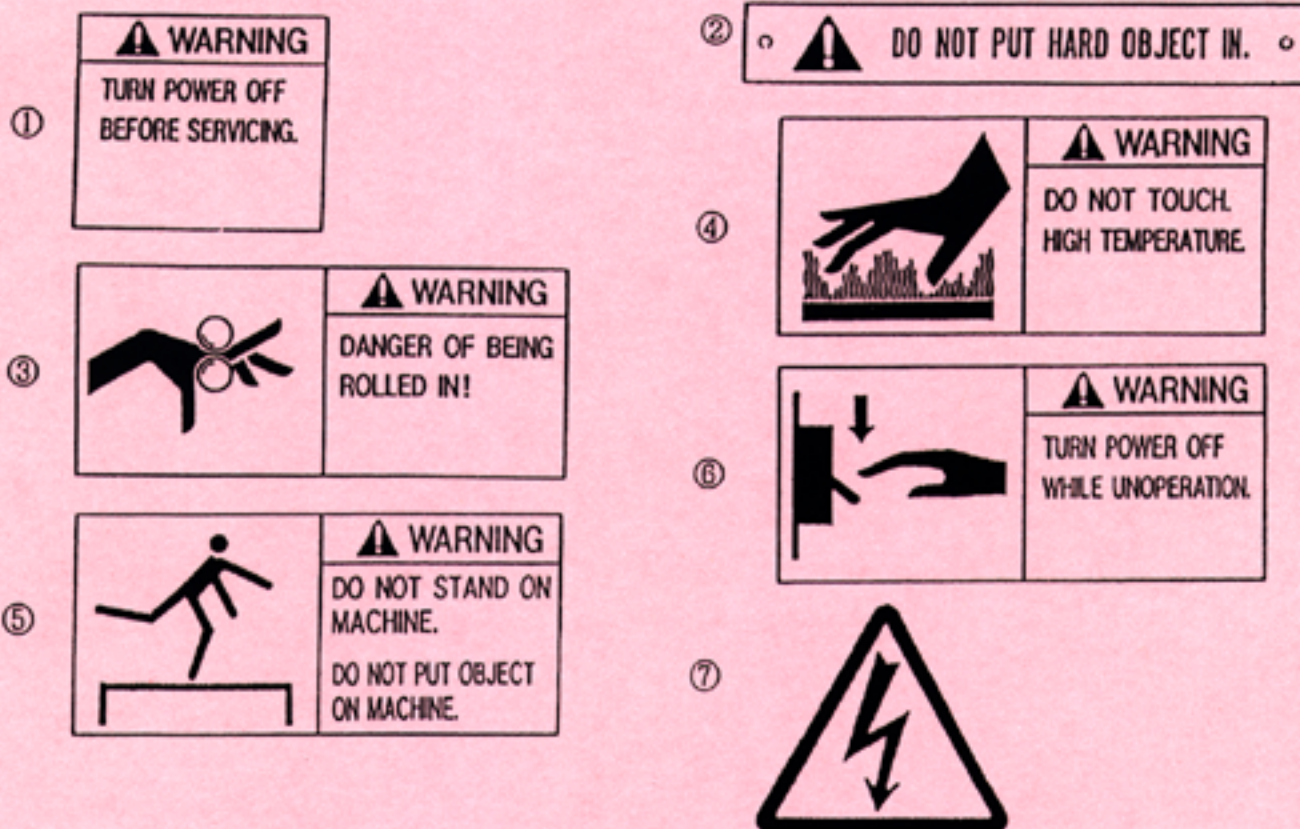
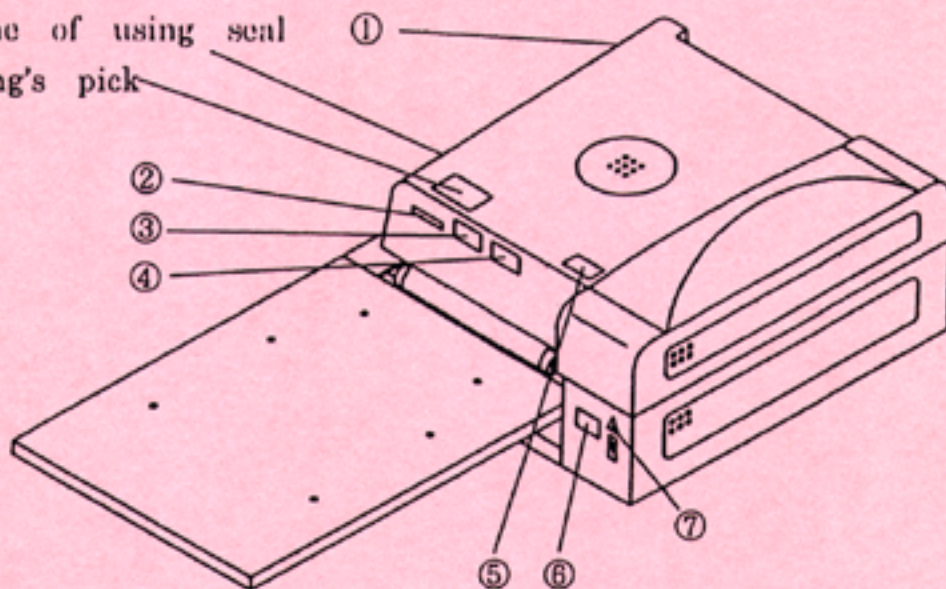

- By the way, the repair technicians should pay attention to the fact that "warning label"s are put on even additionally inside machines.

《SPECIFICATIONS》

Model		HP-400C/CS
Power supply		Single phase
Rated output	Heater	3.6 KW
	Motor	0.4 KW
Current		17 A
Temperature (max)		200°C
Pressure (max)		1 kg/cm ²
Belt speed (max)		8.7 m/min.
Heating time (max)		4~∞/sec.
Fusing width		400 mm
Dimensions	W	1,660 mm
	H	460 mm
	L	830 mm
Net weight		125 kg

Attention to be paid at the time of installation

1. Install this machine, which weights 125kg, in regard to the 400C/CS, respectively, on the robust fundation horizontally.
2. Don't install this machine near the object easy to burn, as it generates high temperature when it has been put into use. Exclude, in addition, dusts and others stuck onto this machine periodically.
3. Connect the machine to an exclusive power source corresponding with the ratio consumption power by referring to the specifications.
4. Don't fail to the ground. By the way , it has no relations to the rotary direction of the belt.
5. In the case where you change the power source plug or lengthen the power source cord, make contact with the electric construction shop near by.
6. When the machine has been brought in or when it has been transfered, don't fail to remove the main unit's cover, before ensuring that the upper and lower warp prevention limit switches place correctly the belt between them from both sides. (Refer to next page.)

Attention to be paid at the time of using

1. Don't fail to read the User's Manual prior to the usage.
2. Don't fail to remove the main unit's cover and ensure that the upper and lower warp prevention limit switches place correctly the belt between them from both sides, before connecting the power source. (Refer to next page.)
3. Wipe off dusts using a dry floormat , before inserting the material.
4. Pay sufficient attention not to make contact with the belt and the upper cover whose temperature rises high nor mount things on them.

5. Don't absolutely put your hands on to the roller inside the machine beyond the necessity at the time you insert the material for fear that they might be caught in.
6. Don't put any things to the main unit of the press except the materials to be inserted.
7. Disconnect the power source breaker immediately and insert the manual handle (an accessory) to the emergency screw, then, turn it to the arrow marked direction in order to remove the unusual things before the operation, if they have been inserted.
8. When the material, has twined round the strip off device at the exit of the material, don't fail to disconnect the power source breaker, before removing it.
9. Don't fail to pull the power source plug off when you inspect the inside.
10. This machine is an exclusive use for fusing and folding the clothes. Don't put it to use for other purposes, otherwise resulting in troubles.
11. After the operation ensure that the machine has stopped completely, before disconnecting the power source breaker without fail.

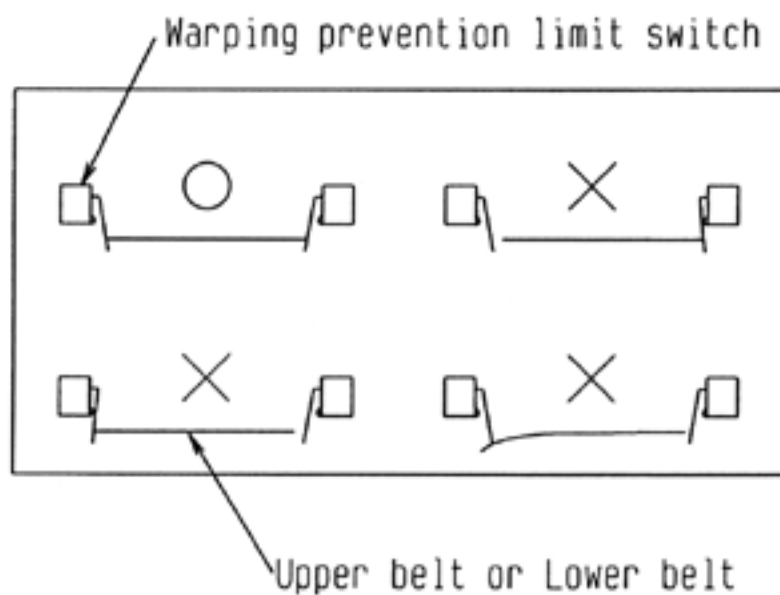
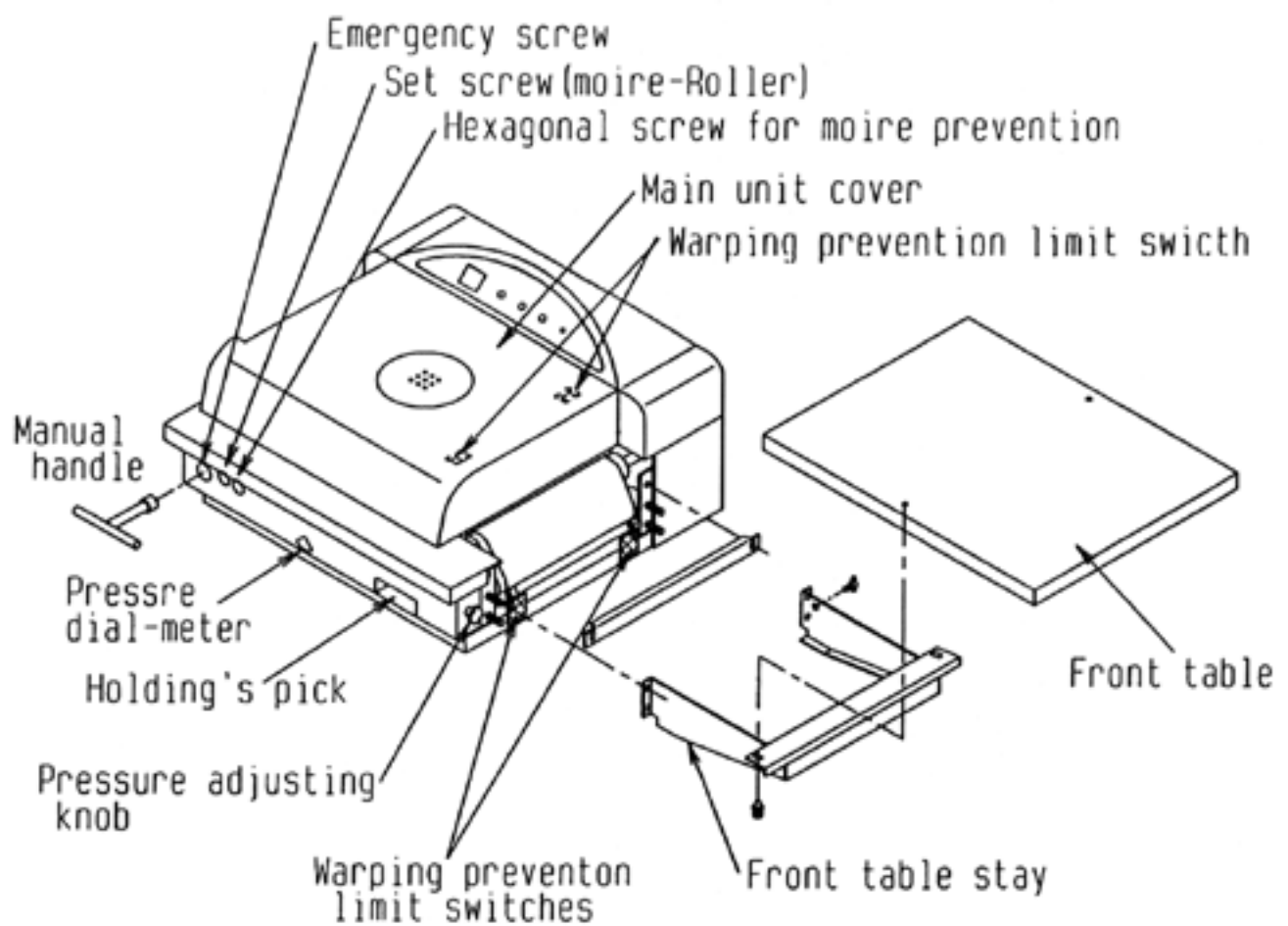

Procedure of usage

1. Set the power source breaker to 'ON'.
(Ensure the 'off' condition of the timer switch.)
2. Press the start button. The lamp will light up and the machine will start moving.
3. Set pressure to the designated by using the pressure adjust knob.
4. Set the fuing time by using the speed pick. Use it within the limit between 5 and 20 seconds for the warp prevention.
5. Set the designated temperature by using the thermostat pick. It takes about 15 minutes before you'll get the usable temperature. When temperature has come to the stable, the thermo-lamp will start blinking.
6. Here, you are able to start the operation.

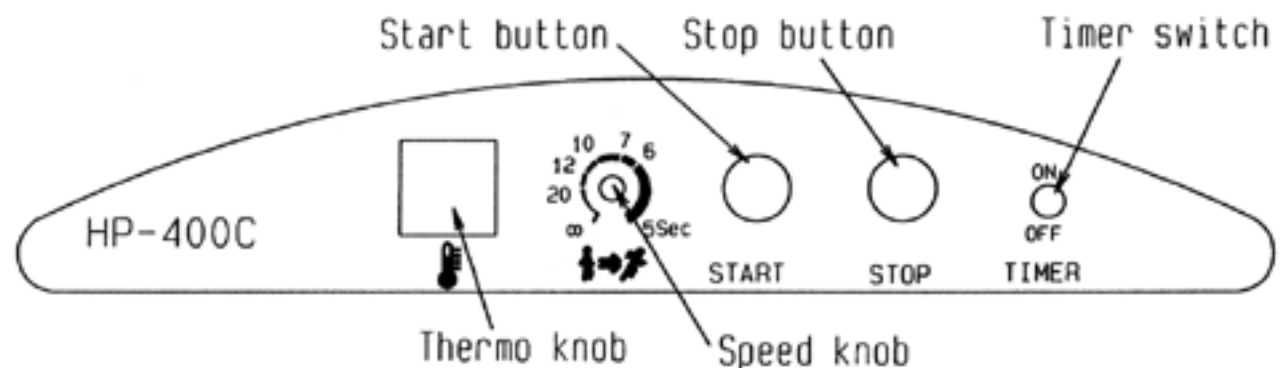

At the time the operation is over.

1. Set the pressre to 0(zero).
2. Set the timer switch to 'ON'.The machine stop automatically and the surface temperature of the belt is below 100 degrees.
3. When the machine has stopped, set the power source breaker to 'OFF'

The holding's adjustment

In the case where you want to strengthen the holding at the injecting entrance of the machine when you've put the inbell scale, pocket folding and others to use, turn the holding's handle to the right. Set the holding's adjustment to 0(zero), when you try to fuse the interlinig.

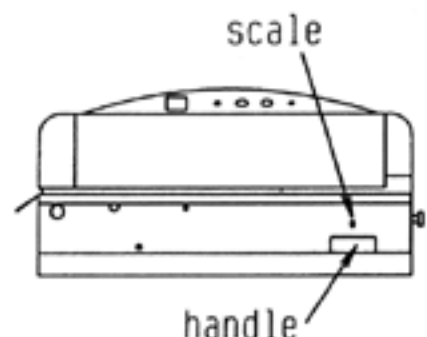

How to prevent and adjust roller moire (pucker)

In the case where roller moire (pucker) has taken place on the fused material, fuse it by lowering heat and pressure as low as possible. Even when the prevention is impossible in spite of the efforts, adjustments to be shown below will be necessary.

1. Remove the main unit's cover.
2. Remove the rear cover.
3. You'll find a screw for securing the moire adjust roller on the side of the machine. And you will find another when you open the rear cover of the machine.

Loosen both of the stop screws and raise right and left equally.

4. The moire is hard to appear when you bring up the roller.
5. Tighten both of the stop screws.

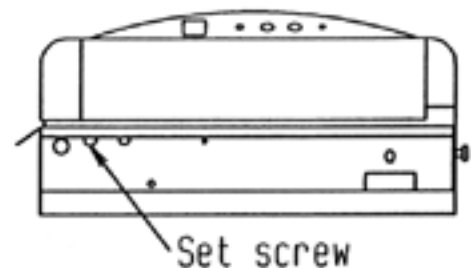

How to move the machine by hand at the emergency

Press the stop switch in order to stop the machine before setting the pressure to 0 (zero), when you've put other things to the belt's injecting entrance by mistake. Put the T-typed wrench (an accessory) on to the screw for emergency on the side of the main unit and turn it to the arrow marked direction, before you will unload the finished material.

In the case where a hard thing has been put in the machine, ensure the safety before resuming the operation for fear that the tafron belt and rubber parts of the pressure roller might be damaged. And in the case of an electric failure, put the T-typed wrench (an accessory) on to the screw for emergency use on the side of the main unit and turn it to the arrow marked direction, before you'll unload the finished material.

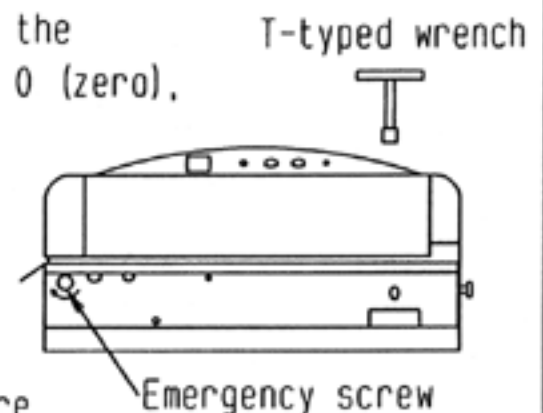

Daily maintenance (Pay attention to fear of such accidents as burn and caught-in.)

Cleaning belts

Clean the belt while it is hot. Use the Hashima New Ace or the New Clean Spray to clean the belt. In the case where you put the latter to use, pay attention not to spray such electric parts as the warp prevention limit switch and others, resulting in troubles. Moreover, don't use the powdered New Cleaning except when dirt is remarkable. Wipe with sure the powders which have a character to be hardened when it is cool. Apply the Hashima New Ace on the belt for the prevention of dirt.

Cleaning the cleaner

The cleaner is provided at the rear part of the machine. At the start of the cleaning, don't fail to pay attention so that the clean surface could make contact with the belt. And observe it about twice a day to change the dirty surface if necessary. The cleaner is to be removed when you push it to the manipulation panel's side. When you wind a new cloth, make it coincide with the rotary direction of the belt and, then, wind it, not being caught in.

Cleaning the brush scraper, (C)

The brush, too, is provided at the rear part of the main unit of the machine. Raise the scraper three or four times a day in order to clean.

Cleaning the rotary strip off blade (CS)

Pick the blade, using a piece of the cloth and move it left to right and right to left in order to take the fusing resin and others away. Here, if the blade remains lying, raise it before cleaning it.

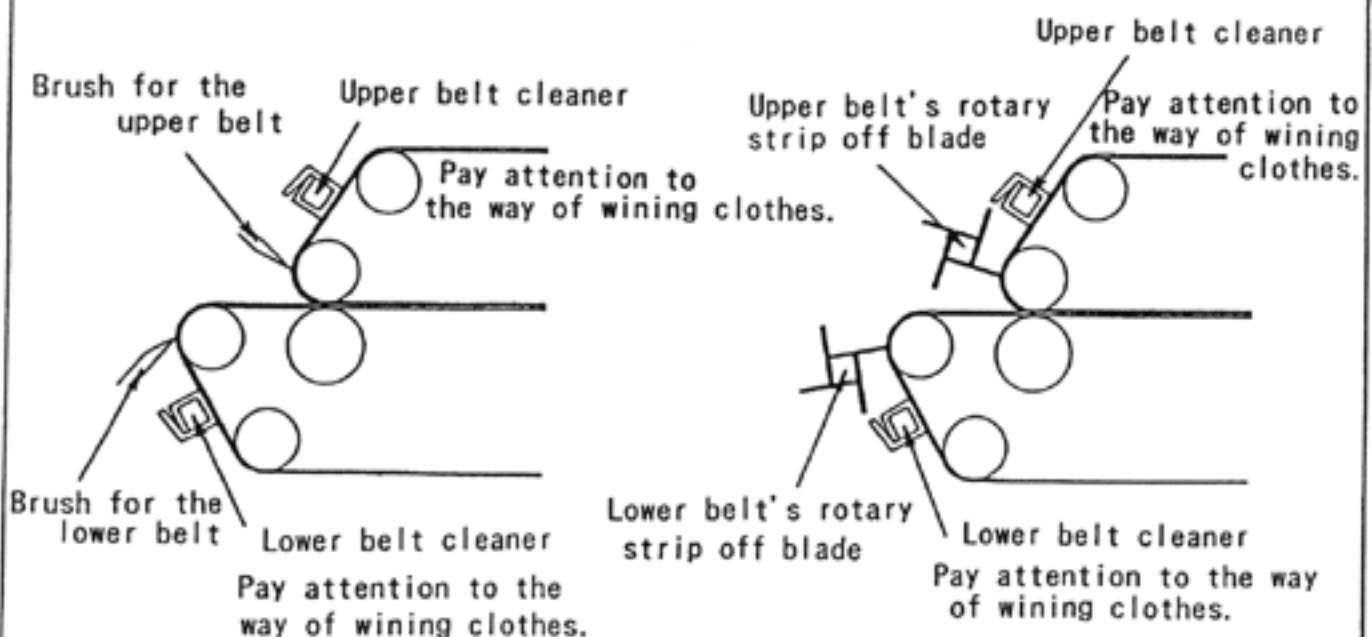

Free Manuals Download Website

<http://myh66.com>

<http://usermanuals.us>

<http://www.somanuals.com>

<http://www.4manuals.cc>

<http://www.manual-lib.com>

<http://www.404manual.com>

<http://www.luxmanual.com>

<http://aubethermostatmanual.com>

Golf course search by state

<http://golfingnear.com>

Email search by domain

<http://emailbydomain.com>

Auto manuals search

<http://auto.somanuals.com>

TV manuals search

<http://tv.somanuals.com>