

# HITACHI

Inspire the Next

## LCD REAR PROJECTION TELEVISION

### Operating Guide for 50V720

IMPORTANT SAFETY INSTRUCTIONS.....	2-3
FIRST TIME USE .....	4-19
THE REMOTE CONTROL.....	20-31
ON-SCREEN DISPLAY .....	32-55
LAMP REPLACEMENT .....	56-59
USEFUL INFORMATION.....	59-62
LICENSE AGREEMENT.....	64
APPENDIXES .....	65
INDEX.....	66



*As an Energy Star<sup>®</sup> Partner,  
Hitachi, Ltd. has determined  
that this product meets the  
Energy Star<sup>®</sup> guidelines for  
energy efficiency.*

# Important Safety Instructions



## SAFETY POINTS YOU SHOULD KNOW ABOUT YOUR HITACHI LCD REAR PROJECTION TELEVISION

Our reputation has been built on the quality, performance, and ease of service of **HITACHI** televisions.

Safety is also foremost in our minds in the design of these units. To help you operate these products properly, this section illustrates safety tips which will be of benefit to you. Please read it carefully and apply the knowledge you obtain from it to the proper operation of your **HITACHI** television.

Please fill out your warranty card and mail it to **HITACHI**. This will enable **HITACHI** to notify you promptly in the improbable event that a safety problem should be discovered in your product model.

**Follow all warnings and instructions marked on this television.**



 The lightning flash with arrowhead symbol, within an equilateral triangle, is intended to alert the user to the presence of uninsulated "dangerous voltage" within the product's enclosure that may be of a sufficient magnitude to constitute a risk of electric shock to a person.

 The exclamation point within an equilateral triangle, is intended to alert the user to the presence of important operating and maintenance (servicing) instructions in the literature accompanying the appliance.

## READ BEFORE OPERATING EQUIPMENT

Follow all warnings and instructions marked on this television.

1. Read these instructions.
2. Keep these instructions.
3. Heed all warnings.
4. Follow all instructions.
5. Do not use this apparatus near water.
6. Clean only with a dry cloth.
7. Do not block any ventilation openings. Install in accordance with the manufacturer's instructions.
8. Do not install near any heat sources such as radiators, heat registers, stoves, or other apparatus (including amplifiers) that produce heat.
9. Do not defeat the safety purpose of the polarized or grounding-type plug. A polarized plug has two blades with one wider than the other. A grounding

type plug has two blades and a third grounding prong. The wide blade or the third prong are provided for your safety. If the provided plug does not fit into your outlet, consult an electrician for replacement of the obsolete outlet.

10. Protect the power cord from being walked on or pinched particularly at plugs, convenience receptacles, and the point where they exit from the apparatus.
11. Only use the attachments/accessories specified by the manufacturer.
12.  Use only with the cart, stand, tripod, bracket, or table specified by the manufacturer, or sold with the apparatus. When a cart is used, use caution when moving the cart/apparatus combination to avoid injury from tip-over.
13. Unplug this apparatus during lightning storms or when unused for long periods of time.
14. Refer all servicing to qualified service personnel. Servicing is required when the apparatus has been damaged in any way, such as power-supply cord or plug is damaged, liquid has been spilled or objects have fallen into apparatus, the apparatus has been exposed to rain or moisture, does not operate normally, or has been dropped.
15. Televisions are designed to comply with the recommended safety standards for tilt and stability. Do not apply excessive pulling force to the front, or top, of the cabinet which could cause the product to overturn resulting in product damage and/or personal injury.
16. Follow instructions for wall, shelf or ceiling mounting as recommended by the manufacturer.
17. An outdoor antenna should not be located in the vicinity of overhead power lines or other electrical circuits.
18. If an outside antenna is connected to the receiver be sure the antenna system is grounded so as to provide some protection against voltage surges and built up static charges. Section 810 of the National Electric Code, ANSI/NFPA No. 70-1984, provides information with respect to proper grounding for the mast and supporting structure, grounding of the lead-in wire to an antenna discharge unit, size of grounding connectors, location of antenna-discharge unit, connection to grounding electrodes and requirements for the grounding electrode.

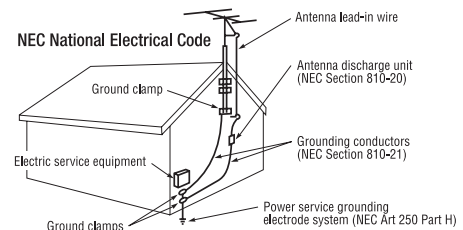

Note to the CATV system installer: This reminder is provided to call the CATV system installer's attention to Article 820-44 of the NEC that provides guidelines for proper grounding and, in particular, specifies that the cable ground shall be connected to the grounding system of the building, as close to the point of cable entry as practical.

# Important Safety Instructions



## Power source

This television is designed to operate on 120 volts 60 Hz, ac current. Insert the power cord into a 120 volt 60 Hz outlet.

To prevent electric shock, do not use the television's (polarized) plug with an extension cord, receptacle, or other outlet unless the blades and ground terminal can be fully inserted to prevent blade exposure.

Never connect the television to 50 Hz, direct current, or anything other than the specified voltage.

## Caution



Never remove the back cover of the television as this can expose you to very high voltages and other hazards. If the television does not operate properly, unplug the television and call your authorized dealer or service center.

## Caution

Adjust only those controls that are covered in the instructions, as improper changes or modifications not expressly approved by **HITACHI** could void the user's warranty.

## Warning

- To reduce the risk of fire or electric shock, do not expose this apparatus to rain or moisture.
- The television should not be exposed to dripping or splashing and objects filled with liquids, such as vases, should not be placed on the television.



## Warning

- Do not place any objects on the top of the television which may fall or cause a child to climb to retrieve the objects.

## Modifications

The FCC requires the user to be notified that any changes or modifications made to this device that are not expressly approved by Hitachi America, Ltd. Home Electronics Division may void the user's authority to operate the equipment.

## Note

This television receiver will display television closed captioning, ( or ), in accordance with paragraph 15.119 and 15.122 of the FCC rules.

## Public viewing of copyrighted material

Public viewing of programs broadcast by TV stations and cable companies, as well as programs from other sources, may require prior authorization from the broadcaster or owner of the video program material.

This product incorporates copyright protection technology that is protected by U.S. patents and other intellectual property rights. Use of this copyright protection technology must be authorized by Macrovision Corporation, and is intended for home and other limited consumer uses only unless otherwise authorized by Macrovision. Reverse engineering or disassembly is prohibited.

## Note

This digital television is capable of receiving analog basic, digital basic and digital premium cable television programming by direct connection to a cable system providing such programming. A CableCARD provided by your cable operator is required to view encrypted digital programming. Certain advanced and interactive digital cable services such as video-on-demand, a cable operator's enhanced program guide and data-enhanced television services may require the use of a set-top box. For more information call your local cable company.

## Note

- There are no user serviceable parts inside the television.
- Model and serial numbers are indicated on back side of the television.

## Lead Notice

This product contains lead and a lamp that contains mercury. Dispose of this product and its lamp in accordance with applicable environmental laws. For lamp recycling and disposal information, go to [www.lamprecycle.org](http://www.lamprecycle.org). For product recycling and disposal information contact your local government agency or [www.eRecycle.org](http://www.eRecycle.org) (in California), the Electronic Industries Alliance at [www.eiae.org](http://www.eiae.org) (in the US) or the Electronic Product Stewardship Canada at [www.epsc.ca](http://www.epsc.ca) (in Canada).

**FOR MORE INFORMATION, CALL 1-800-HITACHI.**

# Accessories

Check to make sure you have the following accessories before disposing of the packing material.

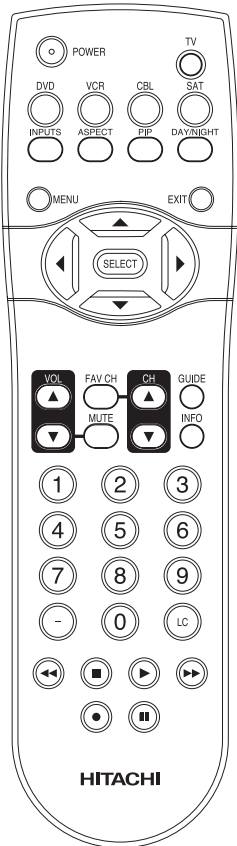
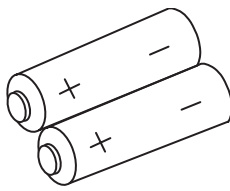
<p><b>1 Remote Control</b></p> 	<p><b>2 Two "AA" size, 1.5V batteries</b></p> 
<p><i>For US models: For optional accessories, please access our website at <a href="http://www.hitachi.us/tv">www.hitachi.us/tv</a></i></p>	

- 1 Remote Control Unit CLU-4352UG2 (Part No. HL02073).
- 2 Two "AA" size, 1.5V batteries (For Remote Control Unit).

## REMOTE CONTROL BATTERY INSTALLATION AND REPLACEMENT

1. Open the battery cover of the remote control by pushing down and sliding the back cover off.
2. Insert two new "AA" size batteries for the remote control. When replacing old batteries, push them towards the springs and lift them out.
3. Match the batteries to the (+) and (-) marks in the battery compartment.
4. Insert the bottom of the battery, the (-) side, into the battery compartment first, push towards the springs and insert the top of the battery, the (+) side, into place. Do not force the battery into the battery compartment.
5. Replace the cover.

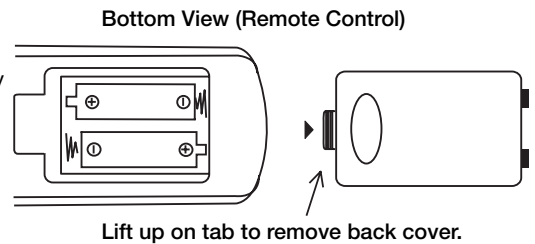

# How to set up your new HITACHI Projection Television

## ANTENNA

Unless your LCD Rear PTV is connected to a cable TV system or to a centralized antenna system, a good outdoor TV antenna is recommended for best performance. However, if you are located in an exceptionally good signal area that is free from interference and multiple image ghosts, an indoor antenna may be sufficient.

## LOCATION

Select an area where sunlight or bright indoor illumination will not fall directly on the picture screen. Also, be sure that the location selected allows a free flow of air to and from the perforated back cover of the set. To avoid cabinet warping, cabinet color changes, and increased chance of set failure, do not place the TV where temperatures can become excessively hot, for example, in direct sunlight or near a heating appliance, etc. When using your LCD Rear PTV against a wall, keep it at least 10cm (4 inches) from the wall.

**NOTE:** Your new HDTV has a built-in high definition television signal processor. This television includes a fan to cool the processor. The sound of moving air from the fan is normal and may be noticeable in very quiet environments.

## VIEWING

The major benefit of the **HITACHI** LCD Rear PTV is its large viewing screen. To see this large screen at its best, test various locations in the room to find the optimum spot for viewing.

The best picture is seen by sitting directly in front of the TV and about 10 to 18 feet from the screen. Picture brightness decreases as the viewer moves to the left and right of the receiver.

During daylight hours, reflections from outside light may appear on the screen. If so, drapes or screens can be used to reduce the reflection or the TV can be located in a different section of the room.

If the TV's audio output will be connected to a Hi-Fi system's external speakers, the best audio performance will be obtained by placing the speakers equidistant from each side of the receiver cabinet and as close as possible to the height of the picture screen center. For best stereo separation, place the external speakers at least four feet from the side of the TV, place the surround speakers to the side or behind the viewing area. Differences in room sizes and acoustical environments will require some experimentation with speaker placement for best performance.

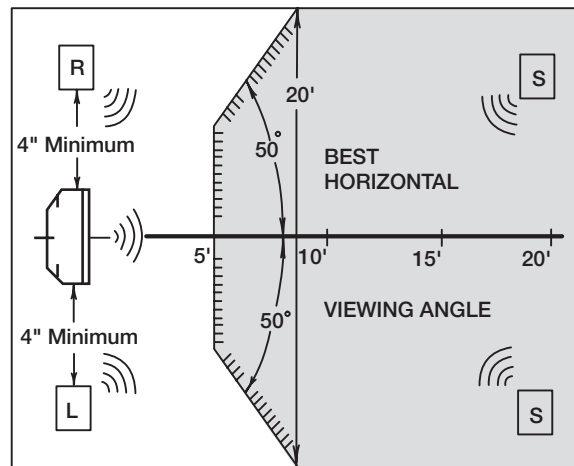
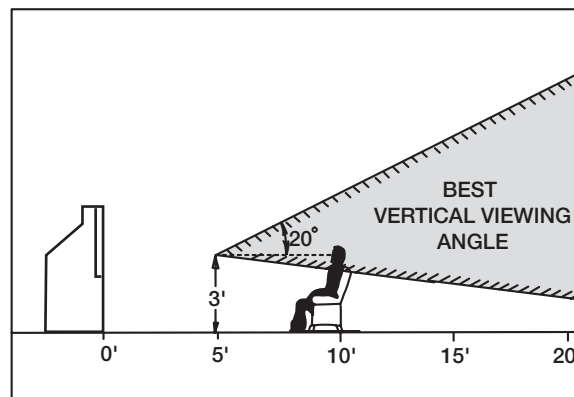

## IMPORTANT NOTES:

1. Since LCD Rear PTV incorporates a high pressure lamp to display an image, it may take about one minute for the picture to become stable, after the power has been turned on. After extended use, the picture may darken, the color may look unusual, or the lamp "goes out," (burns out). You may hear a "pop" sound when the lamp "goes out." These are common characteristics of the lamp, and should not be considered defective.
2. LCD Rear PTV incorporates an advanced cooling fan system to prevent from overheating. If you hear the cooling fan, it should not be considered defective.
3. If you hear a "cracking" sound from the TV cabinet, it is due to the TV's cabinet expanding and contracting due to room temperature changes. It has no effect on the TV's functions.
4. The LCD Rear PTV cabinet is constructed with all plastic. Make sure to place it on a flat surface. An uneven surface might warp the cabinet and reduce the picture quality.

# Hook-up Cables and Connectors

Most video/audio connections between components can be made with shielded video and audio cables that have phono connectors. For best performance, video cables should use 75-Ohm coaxial shielded wire. Cables can be purchased from most stores that sell audio/video products. Below are illustrations and names of common connectors. Before purchasing any cables, be sure of the output and input connector types required by the various components and the length of each cable.

## 300-Ohm Twin Lead Connector

This outdoor antenna cable must be connected to an antenna adapter (300-Ohm to 75-Ohm).

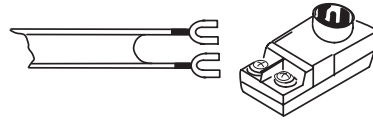

## Phono Connector

Used on all standard video and audio cables which connect to inputs and outputs located on the television's rear jack panel and side control panel.



## "F" Type 75-Ohm Coaxial Antenna Connector

For connecting RF signals (antenna or cable TV) to the antenna jack on the television.



## S-Video (Super Video) Connector

This connector is used on camcorders, VCRs and laser-disc players with an S-Video feature in place of the standard video cable to produce a high quality picture.



## Optical Cable

This cable is used to connect to an audio amplifier with an Optical Audio In jack. Use this cable for the best sound quality.

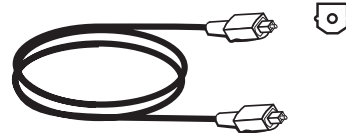

## HDMI Cable

This cable is used to connect your external devices such as Set-Top-Boxes or DVD players equipped with an HDMI output connection to the TV's HDMI input.

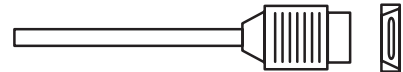

## ANTENNA CONNECTIONS TO REAR JACK PANEL

### VHF (75-Ohm) antenna/CATV (Cable TV)

When using a 75-Ohm coaxial cable system, connect **CATV** coaxial cable to the **CABLE** (75-Ohm) terminal. If you have an antenna, connect the coaxial cable to the **AIR** terminal.

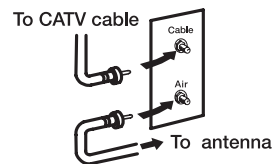

### VHF (300-Ohm) antenna/UHF antenna

When using a 300-Ohm twin lead from an outdoor antenna, connect the **VHF** or **UHF** antenna leads to screws of the **VHF** or **UHF** adapter. Plug the adapter into the antenna terminal on the TV.

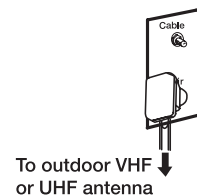

### When both VHF and UHF antennas are connected

Attach an optional antenna cable mixer to the TV antenna terminal, and connect the cables to the antenna mixer. Consult your dealer or service store for the antenna mixer.

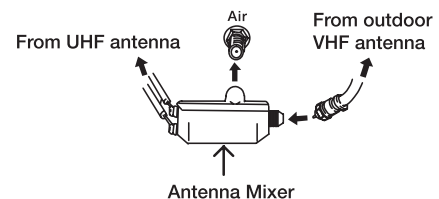

# Quick Reference Remote Control Buttons and Functions

In addition to controlling all of the functions on your HITACHI LCD Rear Projection TV, the new remote control is designed to operate different types of devices, such as, DVD Players, CBL (Cable Boxes), set-top-boxes, satellite receivers, and VCRs. The remote control must be programmed to control the chosen device. Please see pages 20-31 for a complete description of all features and programming of the Remote Control.

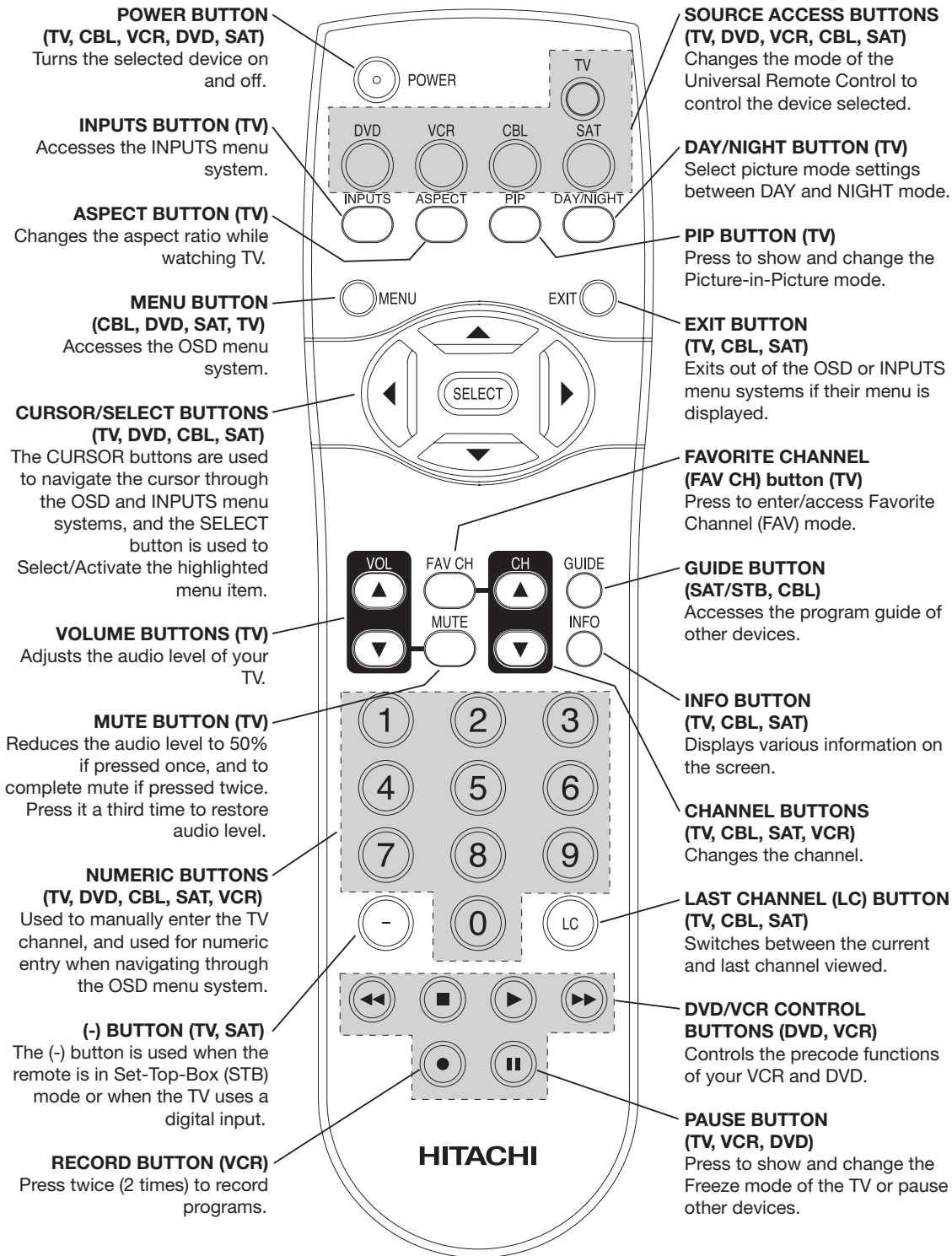

## LEGEND

**TV** — Television  
**CBL** — Cable Box  
**STB** — Set-Top-Box  
**VCR** — Video Cassette Recorder/Player  
**DVD** — Digital Video Disc Player  
**SAT** — Satellite Receiver

**NOTE:** STB precode is included in the SAT mode.

# Front Panel Controls

First time use

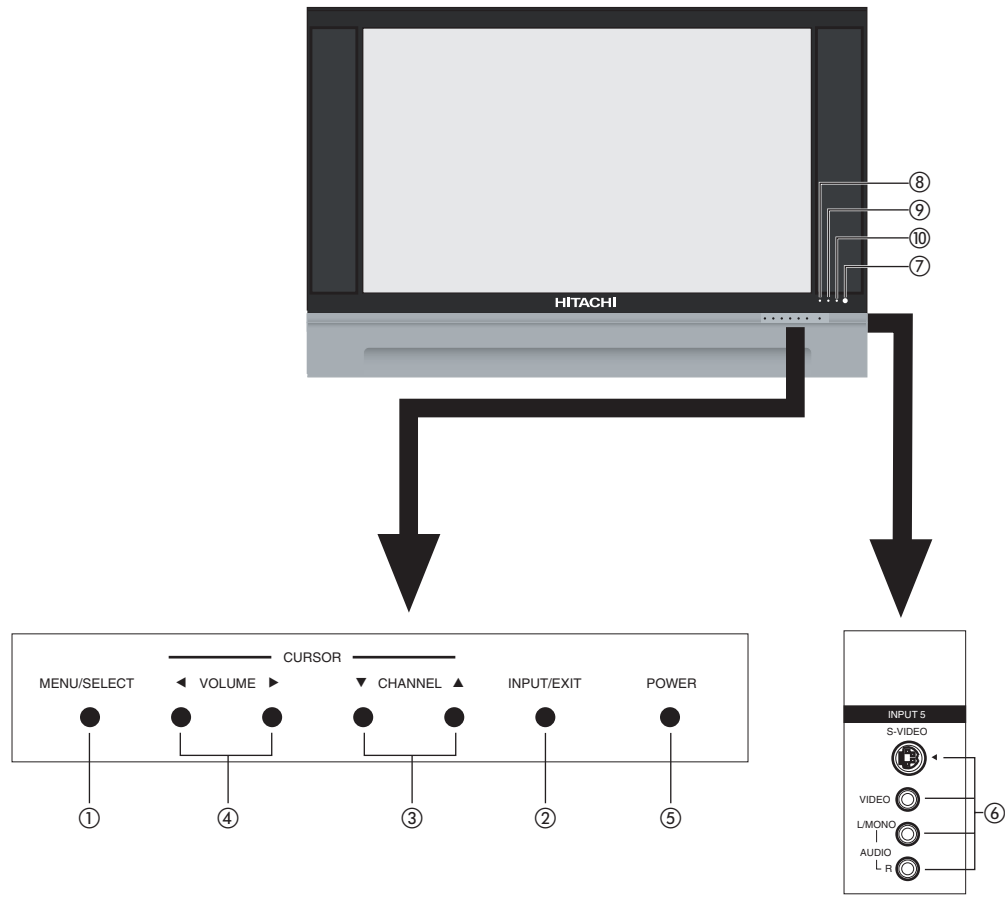

- 1 MENU/SELECT button**  
 This button allows you to enter the **MENU**, making it possible to set TV features to your preference without using the remote. This button also serves as the **SELECT** button when in **MENU** mode.
- 2 INPUT/EXIT button**  
 Press this button to display the input menu selections of **CABLE, AIR, INPUT: 1, 2, 3, 4** and **5**. This button also serves as the **EXIT** button when in **MENU** mode.
- 3 CHANNEL selector**  
 Press these buttons until the desired channel appears in the top right corner of the TV screen. These buttons also serve as the cursor down (**▼**) and up (**▲**) buttons when in **MENU** mode.
- 4 VOLUME level**  
 Press these buttons for your desired sound level. The volume level will be displayed on the TV screen. These buttons also serve as the cursor left (**◀**) and right (**▶**) buttons when in **MENU** mode. When the TV power is turned OFF at a volume level 31 or greater, the volume level will default to 30 when the TV is turned ON. However, if it is set to a level 30 or less, the volume level will be at the level it was set when the TV is turned ON.
- 5 POWER button**  
 Press this button to turn the TV ON or OFF.
- 6 SIDE INPUT JACKS (INPUT 5)**  
 Use these audio/video jacks for a quick hook-up from a camcorder or VCR to instantly view your favorite show or new recording. Press the **INPUT** button and select **INPUT 5**. If you have mono sound, insert the audio cable into the left audio jack.
- 7 IR RECEIVER Sensor**  
 Point the remote control at this area when selecting channels, adjusting volume, etc.



# Front Panel Controls

## 8 POWER Light

When the TV is turned ON, the Power Light will first blink to indicate that the television lamp is warming up. This light will be ON during normal operation. When the TV is turned OFF, the Power Light will blink to indicate that the television lamp will be cooling down and the light will eventually turn off.

## 9 TEMP Indicator

This light is off during normal operation. If this indicator is lit, the optic unit is too hot. If this indicator is blinking, the cooling fan has stopped. Please call service. The optic unit has an air filter that may become clogged over time. The internal temperature will increase which will trigger the temperature sensor to display an On-Screen warning. After 6 minutes, the lamp will turn off, then the TV will turn off with the TEMP LED On.

## 10 LAMP Indicator

This light is off during normal operation. If light is lit, the lamp has failed. See page 56-59 for lamp replacement procedure. Consult your Hitachi dealer for proper part. If light is blinking, lamp cover is not assembled securely after replacement.

NOTES:

INDICATOR	INDICATION	MEANING	ACTION
LAMP LED	LIGHT ON	NO LAMP LIGHT or BROKEN LAMP	Need to replace if LAMP still does not light by Power On " again. Check assembly condition of LAMP UNIT
	BLINKING	WRONG LAMP UNIT ASSEMBLY / LAMP DOOR OPEN	
TEMP LED	LIGHT ON	Too hot inside the OPTIC unit	Call for Service
	BLINKING	COOLING FAN STOPPED	
POWER LED	INTERMEDIATE BLINKING (0.5 SEC CYCLE)	BEGINNING OF WARM UP AFTER THE POWER ON.	
	LIGHT ON	NORMAL OPERATION	
	SHORT BLINKING (0.3 SEC CYCLE)	BEGINNING OF COOL DOWN (FOR 20 SEC.)  (TV CANNOT ACCEPT ANY CODE IN THIS PERIOD EXCEPT WITHIN THE BEGINNING 5 SEC.)	
	LONG BLINKING (1 SEC CYCLE)	COOL DOWN (FOR 6 MINUTES)  (TV CAN ACCEPT REMOTE CONTROL AND SIDE BUTTONS)	

2. If the LAMP, TEMP, and POWER LED are blinking in the order below, the television is warming up.



3. Your Hitachi LCD Rear Projection Television may appear to be OFF when it is set to input 1 ~ input 5 and the video signal is not received from the input jacks. Please make sure the Blue Power light indicator is not lit (OFF) when you are not watching for long lasting performance.

4. Your Hitachi LCD Rear Projection Television has an internal lamp that lights up the TV screen. Make sure to turn off the Power when you do not watch the LCD Rear Projection Television for longer lamp life

## Side Panel Jacks and Connections

The side panel jacks are provided as a convenience to allow you to easily connect a camcorder or VCR as shown in the following examples:

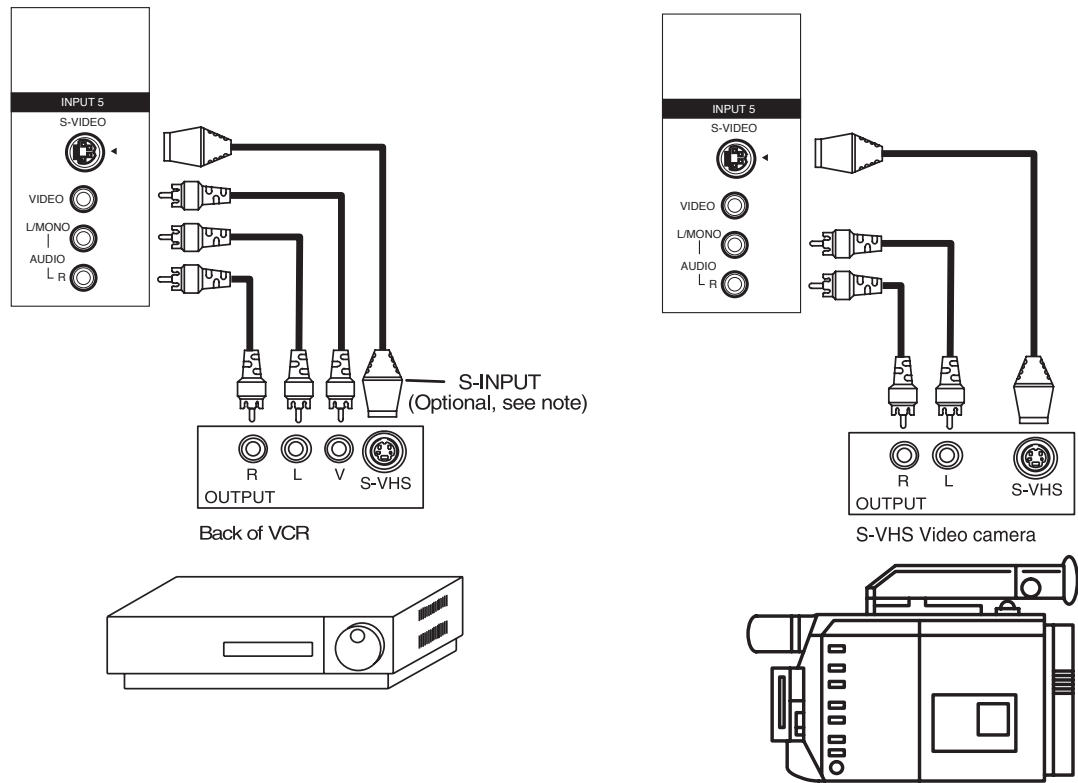

- NOTE:**
1. Completely insert connection cord plugs when connecting to side panel jacks. If you do not, the played back picture may be abnormal.
  2. If you have a S-VHS VCR, use the S-INPUT cable in place of the standard video cable.
  3. If you have a mono VCR, insert the audio cable into the left audio jack of your TV.

# Rear Panel Connections

## 1 Antenna Input

**CABLE** – CATV (Cable TV) input.  
**AIR** – RF antenna input.

**NOTE:** You may ask your local cable company whether DTV services are available.

## 2 Audio/Video Inputs 1, 2, 3 and 4

By using the **INPUTS** button, **CURSOR** buttons and **SELECT** button of the remote control you can select each video source. Use the audio and video inputs to connect external devices, such as VCRs, camcorders, laserdisc players, DVD players etc. (If you have mono sound, insert the audio cable into the left audio jack.)

**NOTE:** You may use **VIDEO** or **S-VIDEO** inputs to connect to **INPUT 1** and **2**, but only one of these inputs may be used at a time.

## 3 Monitor Out

These jacks provide fixed or variable audio and video signals which are used for recording. Use the S-Video Output for high quality video output (see page 53).

## 4 S-Video Inputs 1 and 2

**INPUTS 1** and **2** provide S-Video (Super Video) jacks for connecting equipment with S-Video output capability.

## 5 Component: Y-PbPr Inputs

**INPUTS 3** and **4** provide Y-PbPr jacks for connecting equipment with this capability, such as a DVD player or Set Top Box. You may use composite video signal for both inputs.

- NOTE:**
1. Do not connect composite **VIDEO** and **S-VIDEO** to **INPUT 1, 2** or **5** at the same time. **S-VIDEO** has priority over **VIDEO** input.
  2. Your component outputs may be labeled **Y, B-Y, and R-Y**. In this case, connect the components **B-Y** output to the TV's **Pb** input and the components **R-Y** output to the TV's **Pr** input.
  3. Your component outputs may be labeled **Y-CbCr**. In this case, connect the component **Cb** output to the TV's **Pb** input and the component **Cr** output to the TV's **Pr** input.
  4. It may be necessary to adjust **TINT** to obtain optimum picture quality when using the **Y-PbPr** inputs (see page 34).
  5. To ensure no copyright infringement, the **MONITOR OUT** output will be abnormal, when using the **Y-PbPr** jacks.
  6. **INPUT 3** and **INPUT 4 (Y/VIDEO)** can be used for composite video and component video input.

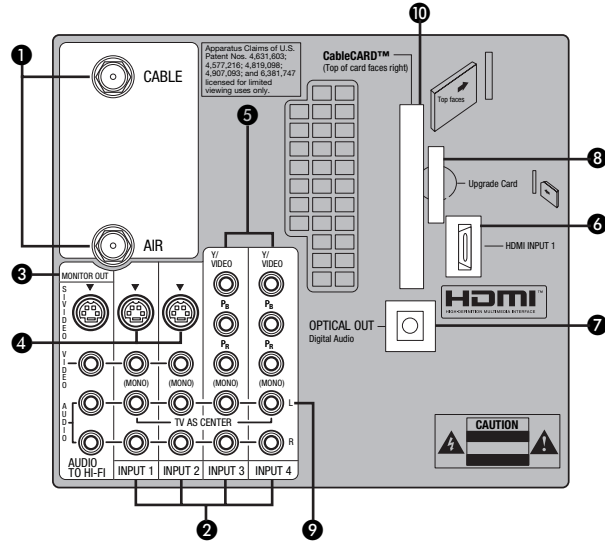

## 6 HDMI (High Definition Multimedia Interface)

**ABOUT HDMI** – HDMI is the next-generation all digital interface for consumer electronics. **HDMI** enables the secure distribution of uncompressed high-definition video and multi-channel audio in a single cable. Because digital television (DTV) signals remain in digital format, **HDMI** assures that pristine high-definition images retain the highest video quality from the source all the way to your television screen.

Use the **HDMI** input for your external devices such as Set-Top-Boxes or DVD players equipped with an **HDMI** output connection.

**HDMI**, the **HDMI** logo and High-Definition Multimedia Interface are trademarks or registered trademarks of **HDMI** Licensing LLC.

- NOTE:**
1. The **HDMI** input is not intended for use with personal computers.
  2. Only DTV formats such as **1080I, 720P, 480I** and **480P** are available for **HDMI**.

## 7 Optical Out (Digital Audio)

This jack provides Digital Audio Output for your audio device that is Dolby® Digital and PCM compatible, such as an audio amplifier.

Manufactured under license from Dolby Laboratories. **DOLBY** and the **DOUBLE-D** symbol are trademarks of Dolby Laboratories.

## 8 Upgrade Card

This card slot is for future software upgrades. Hitachi will notify you if a software upgrade is required for your TV. In order to receive written notification, please complete and return your warranty card.

# Rear Panel Connections

## 9 TV AS CENTER (INPUTS 1-4)

These jacks are for stereo amplifiers with center signal output capability. This feature allows the TV speakers to be used as a center speaker. The TV must be set as a center channel by selecting **TV AS CENTER** on the Internal Speakers Settings of the Audio Menu (see page 38).

## 10 CableCARD Slot

This slot is for the CableCARD that will be provided by your local cable operator to gain access to chosen cable channels. The CableCARD will allow you to tune digital and high definition cable channels. Please call your local cable operator if this service is available before requesting a CableCARD (also known as Point of Deployment (POD) module).

1. Connect a coaxial cable to cable terminal of the Rear Panel Jacks.
2. Insert the CableCARD into the slot (Top of card should be facing right as shown below).

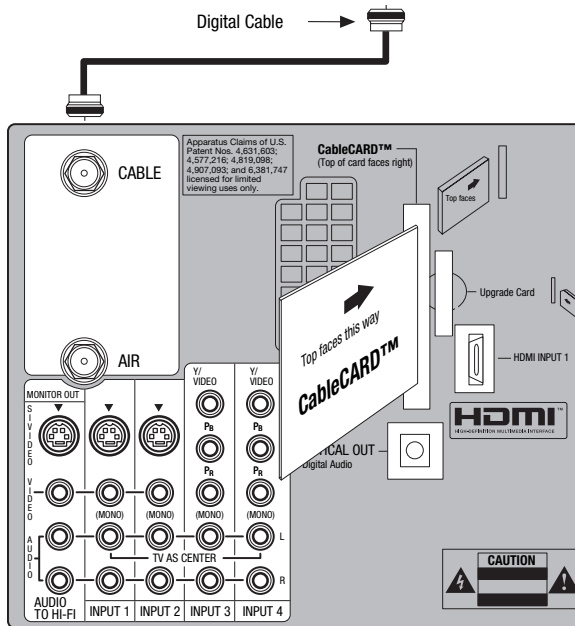

**NOTE:** 1. A digital cable subscription is required.  
2. Do not insert a PCMCIA card into the CableCARD slot.

If the CableCARD is properly installed or not installed, the TV will display the following respective screens.

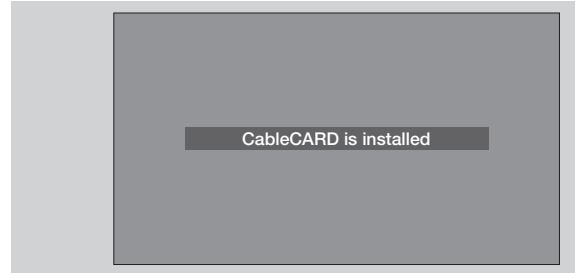

OR



After the CableCARD is installed, wait until the second screen below appears. The third screen below will appear if a channel is not authorized for viewing. Press the **EXIT** button to exit the second screen.

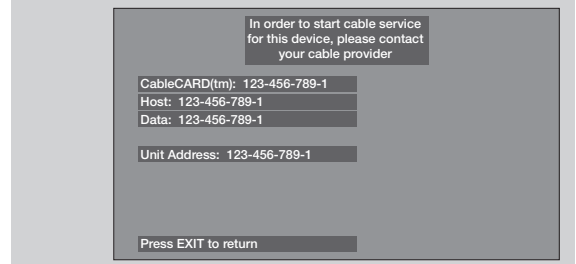

OR

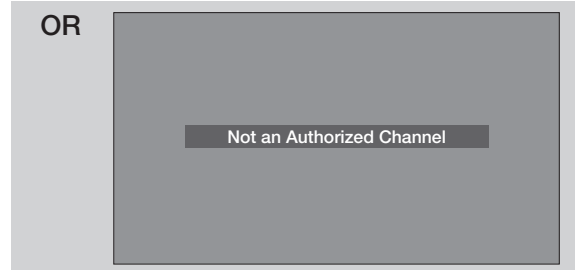

Please take note of all information on the screen (you will provide this information to your cable operator). Call your cable operator and give them the information from the card to start your cable service.

# Rear Panel Connections

## Additional CableCARD Information

After the CableCARD has been successfully installed, a CableCARD Information menu appears in the **SETUP** menu of the On-Screen Display.

Follow the instructions below to access the CableCARD Information menu.

1. Press the **MENU** button on the Remote Control to access the Main Menu screen.



2. Use the **CURSOR** button ▼ to highlight **SETUP** in the Main Menu and press the **SELECT** button.

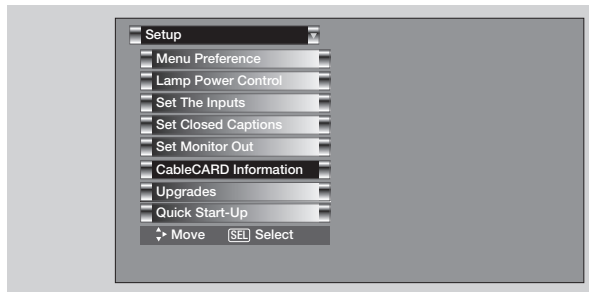

3. Use the **CURSOR** button ▼ to highlight **CableCARD Information** and press the **SELECT** button.

4. To view the CableCARD ID and Host ID, use the **CURSOR** button ▼ to highlight **CableCARD Info** and press the **SELECT** button.

**NOTE:** The **Diagnostics Info.** window is for Service use only.

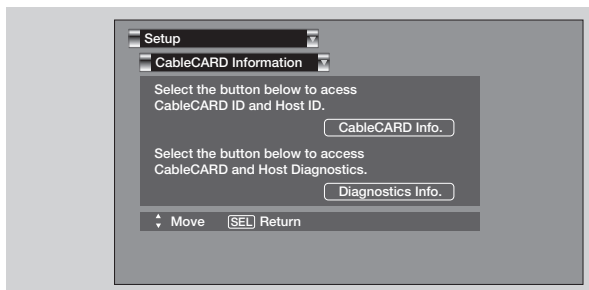

# Rear Panel Connections

First time use

## TIPS ON REAR PANEL CONNECTIONS

- **S-VIDEO, Y-PbPr** and **HDMI** connections are provided for high performance laserdisc players, VCRs etc. that have this feature. Use these connections in place of the standard video connection if your device has this feature.
- If your device has only one audio output (mono sound), connect it to the left audio jack on the television.
- Refer to the operating guide of your other electronic equipment for additional information on connecting your hook-up cables.
- A single VCR can be used for VCR #1 and VCR #2, but note that a VCR cannot record its own video or line output (**INPUT 1** in the example on this page). Refer to your VCR operating guide for more information on line input-output connections.
- You may use **VIDEO** or **S-VIDEO** inputs to connect to **INPUT 1**, **INPUT 2** or **INPUT 5**, but only one of these may be used at a time.
- Connect only one component (VCR, DVD player, camcorder, etc.) to each input jack.
- **COMPONENT: Y-PbPr (INPUT 3 and INPUT 4)** connections are provided for high performance components, such as DVD players and set-top-boxes. Use these connections in place of the standard video connection if your device has this feature. **INPUT 3 and INPUT 4** accepts both composite and component video signals.
- Your component outputs may be labeled **Y, B-Y**, and **R-Y**. In this case, connect the components **B-Y** output to the TV's **Pb** input and the components **R-Y** output to the TV's **Pr** input.
- Your component outputs may be labeled **Y-CbCr**. In this case, connect the components **Cb** output to the TV's **Pb** input and the components **Cr** output to the TV's **Pr** input.
- You may use composite and component video signals for **INPUT 3 and INPUT 4**.
- It may be necessary to adjust **TINT** to obtain optimum picture quality when using the **Y-PbPr** inputs (see page 34).

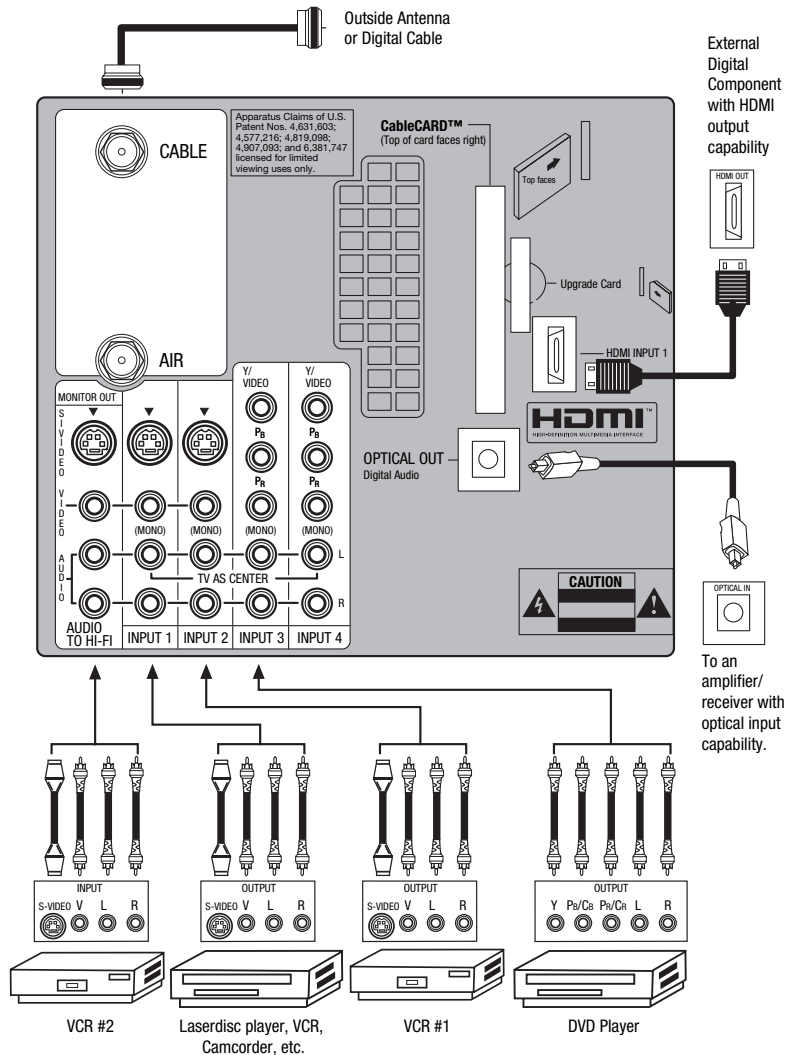

- To ensure no copyright infringement, the **MONITOR OUT** output may be abnormal, when using the **Y-PbPr** jacks.
- When using an **HDMI** input from a Set-Top-Box, it is recommended that a **1080i** or **720p** input signal is used.

**NOTE:**

1. Connect only one component to each input jack.
2. Follow connections that pertain to your personal entertainment system.
3. **INPUT 3 and INPUT 4** can accommodate Composite and Component video signals.
4. Cables are not included with the purchase of this TV, except when noted as "provided".

**MACROVISION NOTES:**

1. Video signals fed through a VCR may be affected by copyright protection systems and the picture will be distorted on the television.
2. Connecting the television directly to the Audio /Video output of a Set-Top-Box will assure a more normal picture.

# Connecting External Video Sources

Match the numbers below to the diagram for speaker placement.

- ❶ The television's internal speakers will act as center speaker (select **AUDIO - INTERNAL SPEAKERS - TV AS CENTER**).
- ❷ These FRONT left and right speakers are connected to the FRONT output of a separate audio amplifier.
- ❸ These REAR left and right speakers are connected to the Rear output of a separate audio amplifier.
- ❹ This subwoofer is connected to the LFE/SUB Out output of a separate audio amplifier.

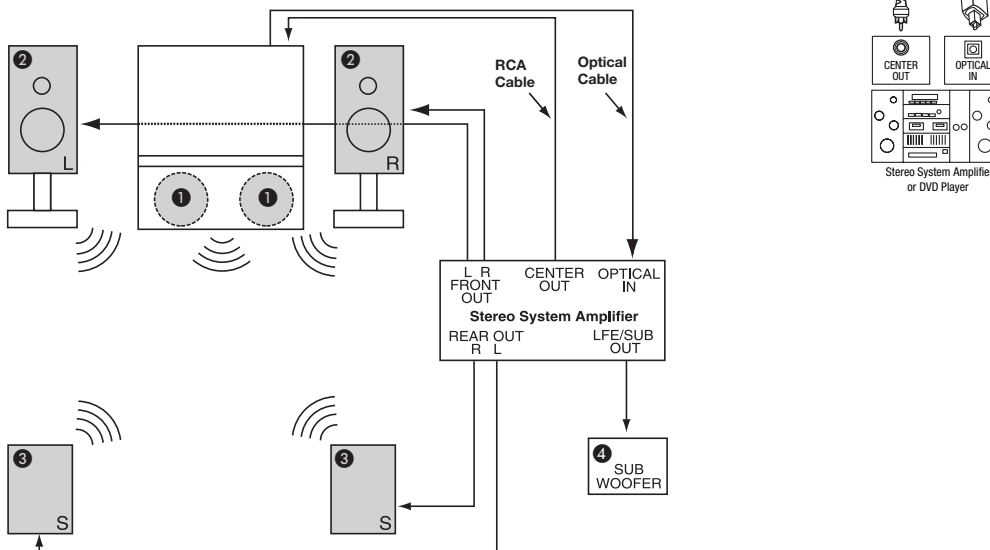
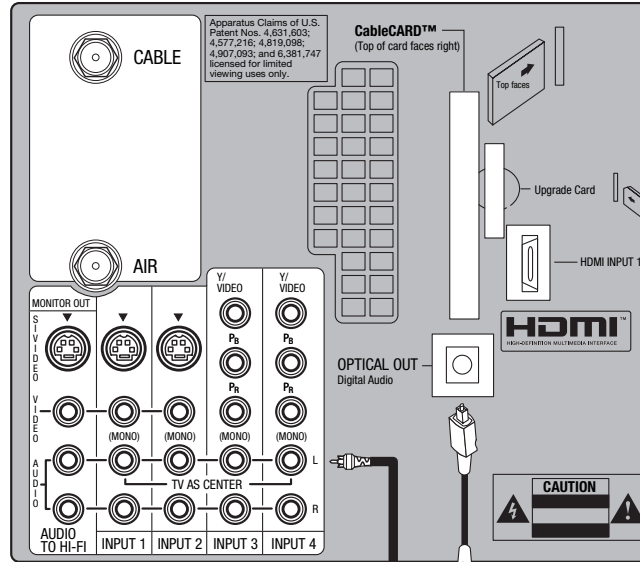

**NOTE:** 1. The Optical Out (Digital Audio) provides a fixed digital audio output to your external component such as an A/V receiver with optical input capability. The audio level can only be controlled through the volume control of the external audio amplifier.  
 2. See page 39 for AUDIO-Digital Output.

# Connecting External Video Sources

The exact arrangement you use to connect the VCR, camcorder, laserdisc player, DVD player, or HDTV Set Top Box to your TV set is dependent on the model and features of each component. Check the owner's manual of each component for the location of video and audio inputs and outputs.

The following connection diagrams are offered as suggestions. However, you may need to modify them to accommodate your particular assortment of components and features. For best performance, video and audio cables should be made from coaxial shielded wire.

## BEFORE OPERATING EXTERNAL VIDEO SOURCE

Connect an external source to the INPUT terminal, then press the **INPUTS** button to show the **INPUTS** menu. Use the **CURSOR PAD** to select the **CABLE**, **AIR** or **INPUT** of your choice. Then press the **SELECT** button to confirm your choice (see page 23).

**NOTE:** When the TV is set to **VIDEO** and a video signal is not received from the **VIDEO INPUT JACK** on the back panel of the TV (i.e., VCR/laserdisc player, etc. is not connected or the video device is **OFF**), the set will appear to be **OFF**.

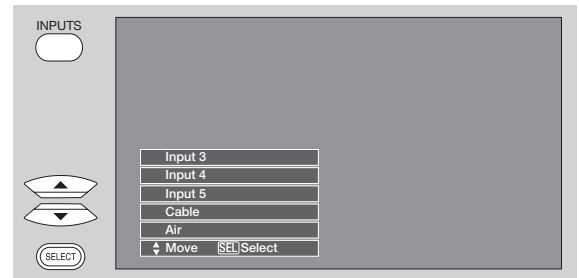

## CONNECTING A COMPOSITE VIDEO AND MONAURAL AUDIO SOURCE TO INPUT1 - INPUT5

1. Connect the cable from the VIDEO OUT of the VCR or the laserdisc player to the INPUT (VIDEO) jack, as shown on the TV set on the right.
2. Connect the cable from the AUDIO OUT of the VCR or the laserdisc player to the INPUT (MONO)/L(AUDIO) jack.
3. Press the **INPUTS** button, then select **INPUT 4** from the **INPUTS** menu to view the program from the VCR or the laserdisc player. The VIDEO OSD label disappears automatically after approximately four seconds.
4. Select **CABLE** from the **INPUTS** menu to return to the previous channel.

**NOTE:** The Input 3 can be used in the same manner as Input 4.

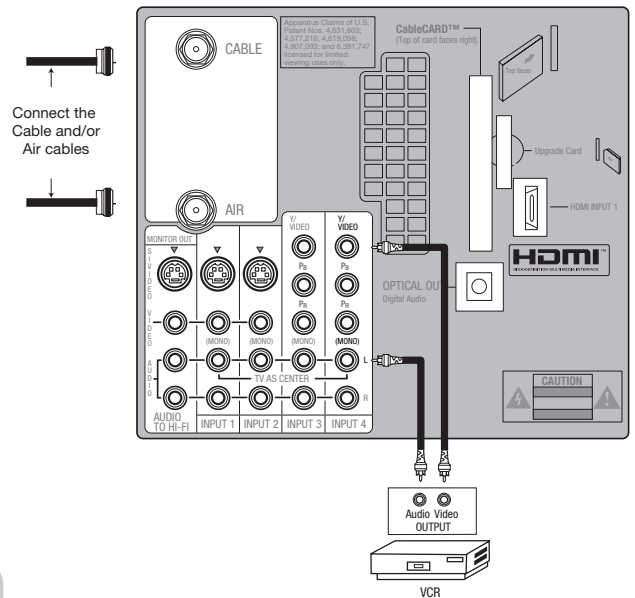



# Connecting External Video Sources

## CONNECTING A COMPOSITE VIDEO AND STEREO AUDIO SOURCE TO INPUT 1 - INPUTS

1. Connect the cable from the VIDEO OUT of the VCR or the laserdisc player to the INPUT (VIDEO) jack, as shown on the TV set on the right.
2. Connect the cable from the AUDIO OUT R of the VCR or the laserdisc player to the INPUT (AUDIO/R) jack.
3. Connect the cable from the AUDIO OUT L of the VCR or the laserdisc player to the INPUT (AUDIO/L) jack.
4. Press the **INPUTS** button, then select **INPUT 2** from the **INPUTS** menu to view the program from the VCR or laserdisc player. The VIDEO OSD label disappears automatically after approximately four seconds.
5. Select **CABLE** from the **INPUTS** menu to return to the previous channel.

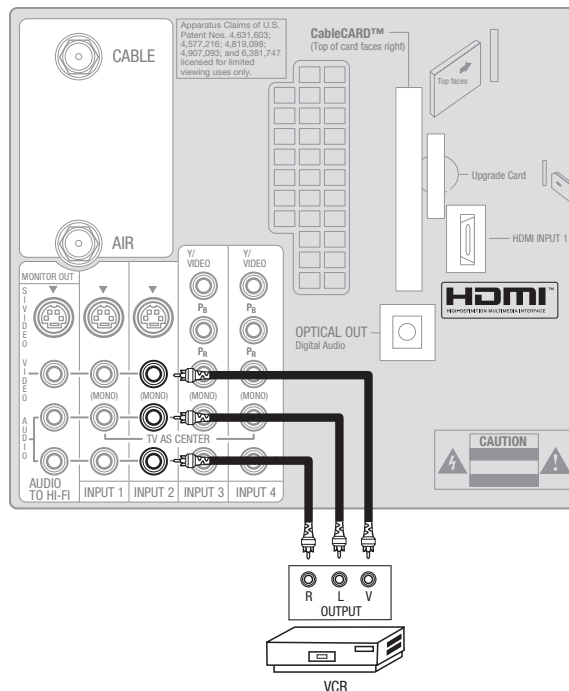

- NOTE:**
1. Completely insert the connection cord plugs when connecting to rear panel jacks. The picture and sound that is played back will be abnormal if the connection is loose.
  2. A single VCR can be used for VCR #1 and VCR #2 (see page 14), but note that a VCR cannot record its own video or line output. Refer to your VCR operating guide for more information on line input-output connections.
  3. When Input 3 or 4 are used, it's necessary to connect the video output from the device to the Y/Video input jack of the TV.

## CONNECTING AN S-VIDEO SOURCE TO INPUT 1, 2 AND 5

1. Connect the cable from the S-VIDEO OUT of the VCR or the laserdisc player to the INPUT (S-VIDEO) jack, as shown on the TV set on the right.
2. Connect the cable from the AUDIO OUT R of the VCR or the laserdisc player to the INPUT (AUDIO/R) jack.
3. Connect the cable from the AUDIO OUT L of the VCR or the laserdisc player to the INPUT (AUDIO/L) jack.
4. Press the **INPUTS** button, then select **INPUT 2** from the **INPUTS** menu to view the program from the VCR or laserdisc player. The VIDEO OSD label disappears automatically after approximately four seconds.
5. Select **CABLE** from the **INPUTS** menu to return to the previous channel.

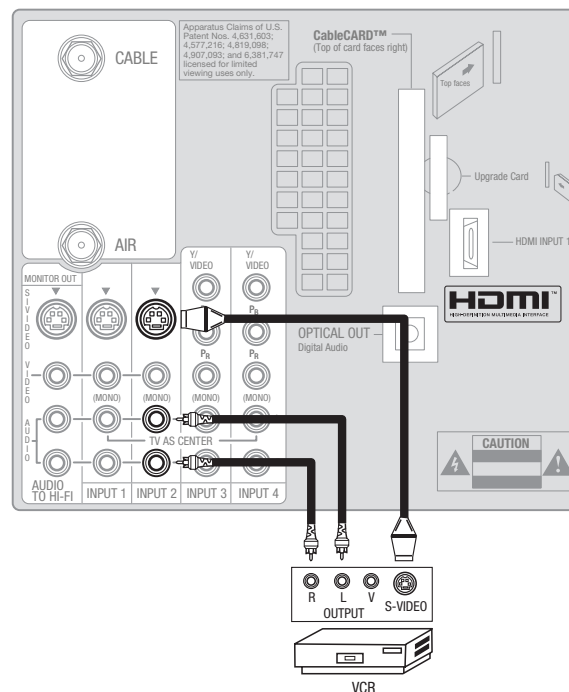

- NOTE:**
1. Completely insert the connection cord plugs when connecting to rear panel jacks. The picture and sound that is played back will be abnormal if the connection is loose.
  2. A single VCR can be used for VCR #1 and VCR #2 (see page 14), but note that a VCR cannot record its own video or line output. Refer to your VCR operating guide for more information on line input-output connections.

First time use

# Connecting External Video Sources

First time use

## CONNECTING A COMPONENT SOURCE WITH HDMI OR DVI CAPABILITY TO INPUT 1

1. Connect the HDMI or DVI to HDMI connection cable from the output of the HDTV set top box or DVD player to the HDMI input as shown on the TV set on the right. When using a component with DVI output, you also have to connect the AUDIO OUT (R/L) of the component to the AUDIO IN (R/L) of INPUT 1.
2. Press the **INPUTS** button, then select **INPUT 1** from the **INPUTS** menu to view the program from the HDTV set top box or DVD player. The VIDEO OSD label disappears automatically after approximately four seconds.
3. Select **CABLE** from the **INPUTS** menu to return to the previous channel.

**NOTE:**

1. Completely insert the connection cord plugs when connecting to rear panel jacks. The picture and sound that is played back will be abnormal if the connection is loose.
2. The HDMI input on INPUT 1 contains the copy protection system called High-bandwidth Digital Content Protection (HDCP). HDCP is a cryptographic system that encrypts video signals when using HDMI connections to prevent illegal copying of video contents.
3. HDMI is not a "NETWORK" technology. It establishes a one-way point-to-point connection for delivery of uncompressed video to a display.
4. The connected digital output device controls the HDMI interface so proper set-up of device user settings determines final video appearance.

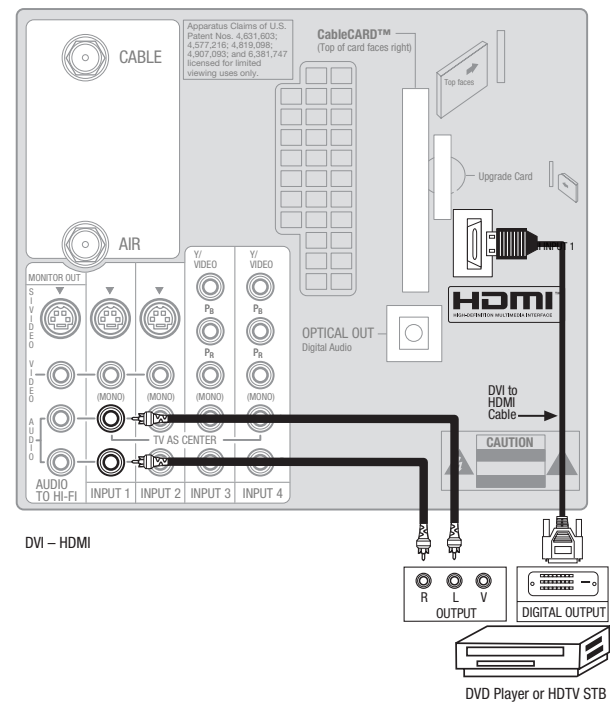
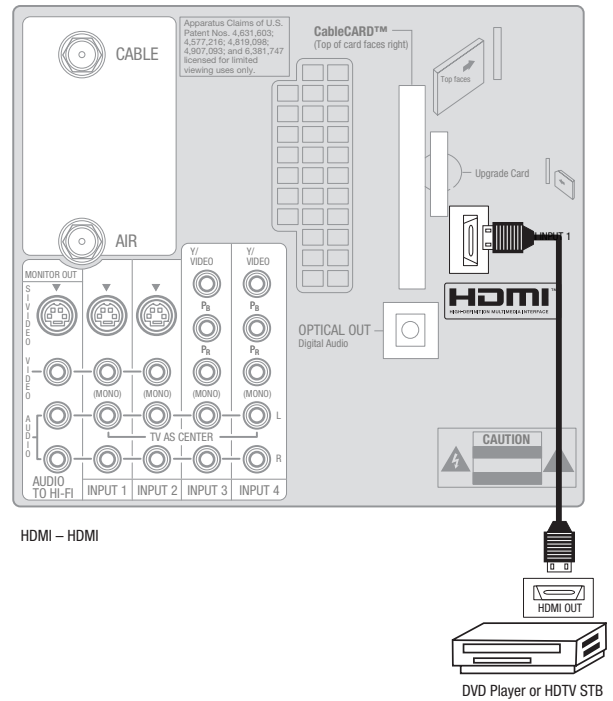

# Connecting External Video Sources

## CONNECTING A COMPONENT SOURCE TO INPUT 3 OR 4: Y-PbPr.

1. Connect the cable from the Y OUT of the Laserdisc/DVD player or HDTV set top box to the INPUT (Y) jack, as shown on the TV set on the right.
2. Connect the cable from the C<sub>B</sub>/P<sub>B</sub> OUT or B-Y OUT of the Laserdisc/DVD player or HDTV set top box to the INPUT (P<sub>B</sub>) jack.
3. Connect the cable from the C<sub>R</sub>/P<sub>R</sub> OUT or R-Y OUT of the laserdisc/DVD player or HDTV set top box to the INPUT (P<sub>R</sub>) jack.
4. Connect the cable from the AUDIO OUT R of the Laserdisc/DVD player or HDTV set top box to the INPUT (AUDIO/R) jack.
5. Connect the cable from the AUDIO OUT L of the Laserdisc/DVD player or HDTV set top box to the INPUT (AUDIO/L) jack.
6. Press the the **INPUTS** button, then select **INPUT 3** from the **INPUTS** menu to view the program from the Laserdisc/DVD player or HDTV set top box. The VIDEO OSD label disappears automatically after approximately four seconds.
7. Select **CABLE** from the **INPUTS** menu to return to the previous channel.

**NOTE:** 1. Completely insert the connection cord plugs when connecting to rear panel jacks. The picture and sound that is played back will be abnormal if the connection is loose.  
2. See page 14 for tips on REAR PANEL CONNECTIONS.

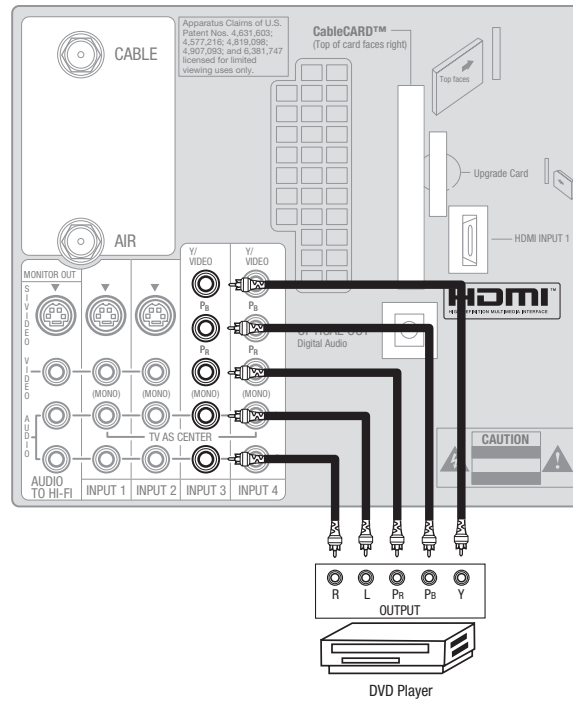

First time use

## The Remote Control

In addition to controlling all the functions on your **HITACHI** LCD Rear Projection TV, the new remote control is designed to operate different types of VCRs, CATV (Cable TV) converters, set-top-boxes, satellite receivers (SAT) and DVD players with one touch. Basic operation keys are grouped together in one area.

To operate your TV, point the remote control at the screen of the TV and press the **TV** button. The remote will now control your television.

To operate your VCR, point the remote at the remote sensor of the VCR and press the **VCR** button. The remote will now control your VCR (see page 31 for instructions on how to program the remote to control your VCR).

To operate your cable box, point the remote at the remote sensor of the cable box and press the **CABLE** (CBL) button. The remote will now control your cable box (see page 28 for instructions on how to program the remote to control your cable box).

To operate your set-top-box or satellite receiver, point the remote at the remote sensor of the set-top-box or satellite receiver and press the **SAT** button. The remote will now control your set-top-box or satellite receiver. If you have a satellite receiver, use this button to program your satellite receiver (see page 29 for instructions on how to program the remote to control your SAT).

To operate your DVD player, point the remote at the remote sensor of the DVD player and press the **DVD** button. The remote will now control your DVD player (see page 30 for instruction on how to program the remote to control your DVD player).

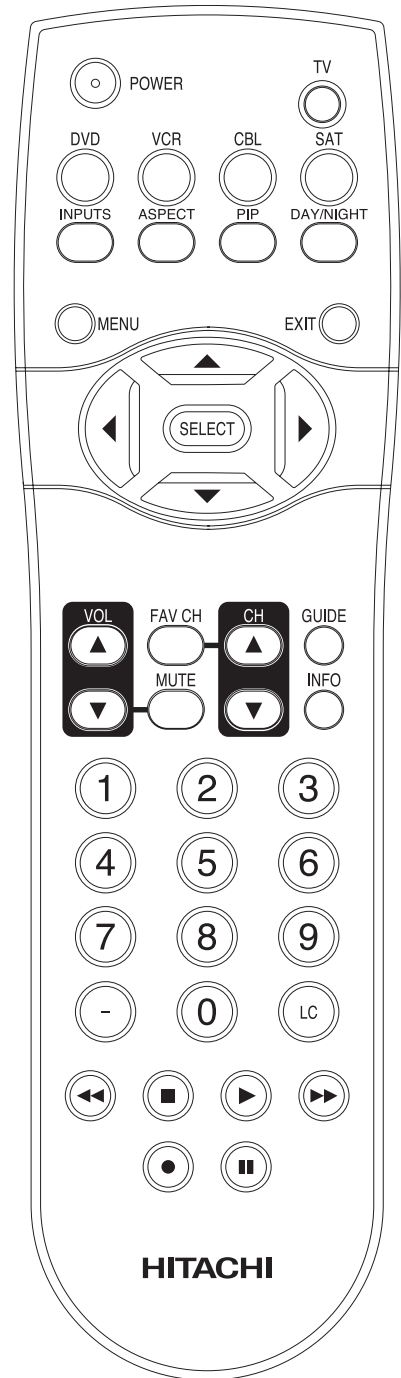

# How to Use the Remote to Control Your TV

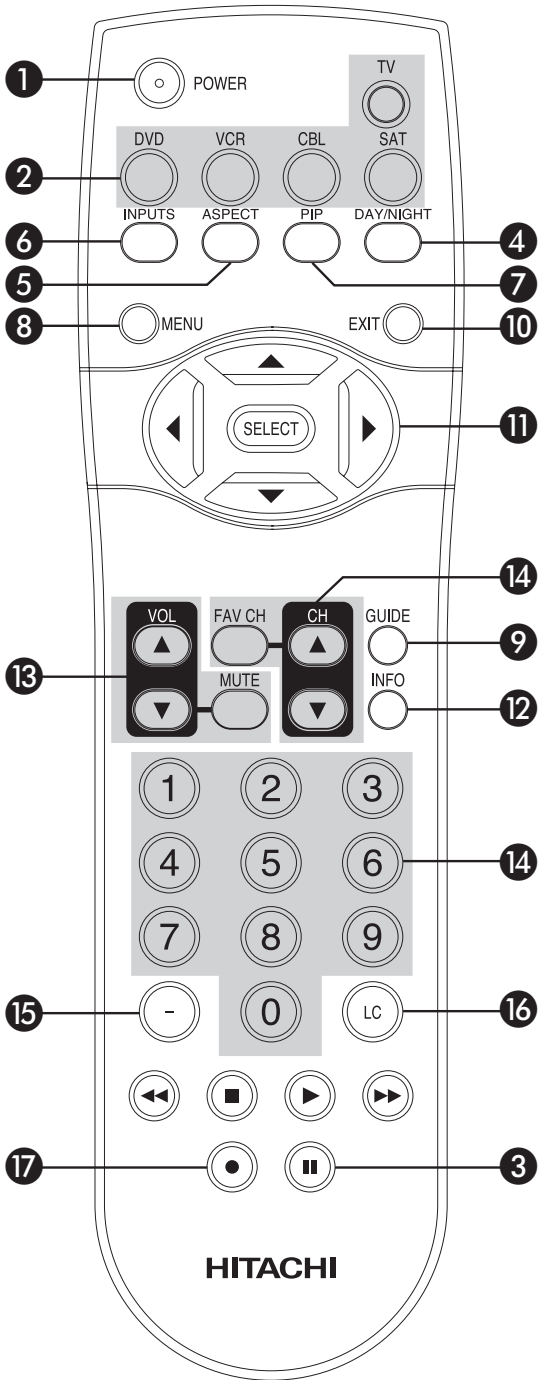

## 1 POWER button

Press this button to turn the TV set on or off when the remote is in TV mode.

## 2 MODE buttons

These buttons allow the remote to control your TV, VCR, DVD, Cable box/Satellite box depending on which button is pressed. Refer to page 20 for how to change between each of these modes.

## 3 PAUSE button

Press the **PAUSE** button to freeze the picture. Press the **EXIT** button to return the picture to motion. Press the **PAUSE** button repeatedly to cycle through the three different freeze modes (see page 26).

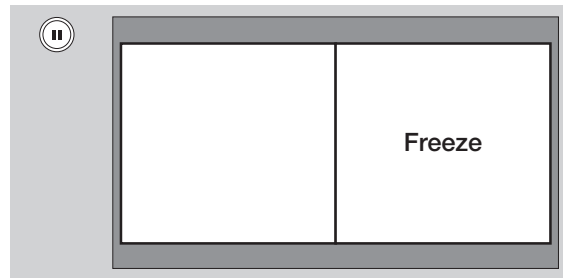
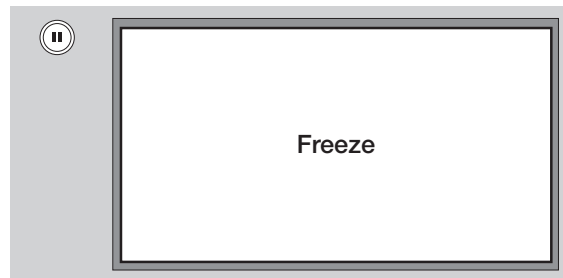

## 4 DAY/NIGHT button

Press this button to toggle between Day and Night picture mode settings. Select **DAY** for day time viewing with more brightness and contrast to compete with room light. Select **NIGHT** for night time viewing with less brightness and contrast for a more detailed picture (see page 34 for settings changes).

# How to Use the Remote to Control Your TV

## 5 ASPECT button

Press this button to quickly change the picture format ASPECT ratio. Depending on the input signal format received, the picture format ratio allows you to adjust the images through the following options.

### 4:3 STANDARD

Use this aspect mode to display conventional (4:3) images. Side panels (gray areas) are placed to the left and right of the image to preserve the original aspect ratio of the source.

### 4:3 EXPANDED

Use this aspect mode to display conventional (4:3) sources by linearly increasing image expansion from the center towards the edges of the display area in order to fill it.

### 4:3 ZOOM1/ZOOM2

Use these aspect modes to zoom in on conventional (4:3) sources.

### 16:9 STANDARD

Use this aspect mode to display 16:9 sources like HDTV and DVD's preserving the original 16:9 aspect ratio.

### 16:9 ZOOM

Use this aspect to Zoom-in once while in 16:9 aspect.

- Antenna-Analog
- S-Video/Video Input (Auto Aspect: Off)
- HDMI-480i/480p Input (Auto Aspect: Off)
- Component-480i/480p Input (Auto Aspect: Off)

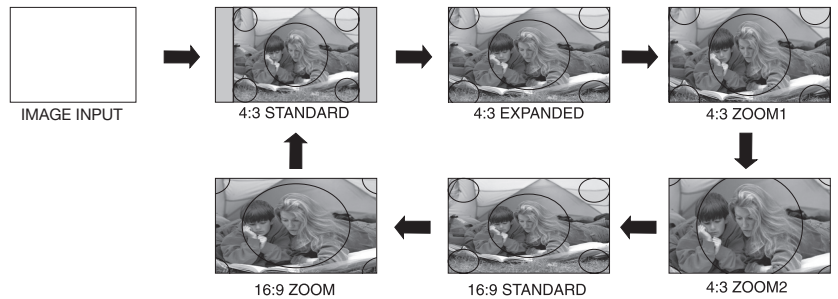

Note: Please see Appendix A on page 65.

- Antenna-Digital (4:3)
- S-Video/Video 4:3/Letter Input (Auto Aspect: On)
- HDMI-480i/480p 4:3/Letter Input (Auto Aspect: On)
- Component-480i/480p 4:3/Letter Input (Auto Aspect: On)

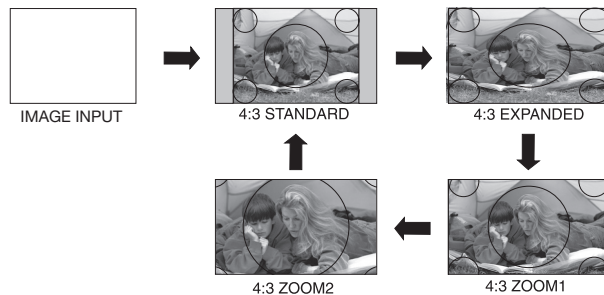

Note: Please see Appendix B on page 65.

- S-Video/Video 16:9 Input (Auto Aspect: On)
- HDMI-480i/480p 16:9 Input (Auto Aspect: On)
- Component-480i/480p 16:9 Input (Auto Aspect: On)

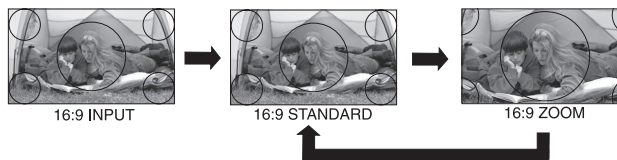

Note: Please see Appendix C on page 65.

- Antenna-Digital (16:9)
- HDMI-720p/1080i Input
- Component-720p/1080i Input

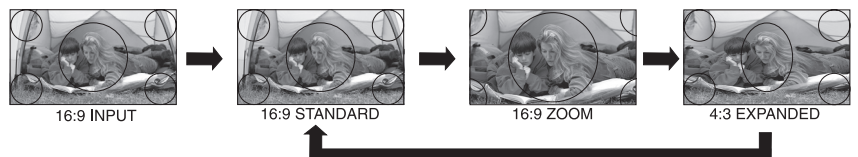

Note: Please see Appendix D on page 65.

**NOTE:** 1. The Aspect Style setting you select for an ANT input will automatically be set for the other ANT input. However, all five video inputs have independent Aspect Style settings.  
2. Vertical position adjustments are directly available when you choose 4:3 EXPANDED/ZOOM1/ZOOM2 or 16:9 ZOOM aspect style (see also page 36).

# How to Use the Remote to Control Your TV

## 6 INPUTS button

When the remote control is in TV mode, press this button to access the **INPUTS** menu. Use the **CURSOR** and **SELECT** buttons to scroll and select the inputs that are being used. Pressing the **INPUTS** button repeatedly will also cycle through the Inputs menu items. Then press the **SELECT** button to select.

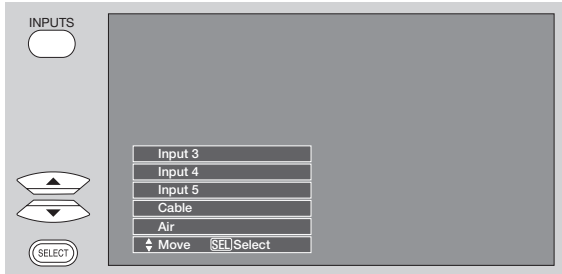

**INPUT 1** Select to choose INPUT 1.

**INPUT 2** Select to choose INPUT 2.

**INPUT 3** Select to choose INPUT 3.

**INPUT 4** Select to choose INPUT 4.

**INPUT 5** Select to choose INPUT 5.

**CABLE** Select to choose Cable.

**AIR** Select to choose Air.

## 7 PICTURE-IN-PICTURE button

See separate section on pages 25-27 for a description.

## 8 MENU button

The **MENU** button will start the On-Screen Display.

## 9 GUIDE button

**[Cable Box (CBL), Satellite Receiver (SAT)/Set-Top-Box (STB) mode only]**

The use of this button is only applicable when the remote control is in (CBL) and (SAT/STB) mode. Press this button to access the Channel Guide of the (CBL), and (SAT/STB).

## 10 EXIT button

This button will exit all On-Screen Displays.

## 11 CURSOR buttons/SELECT button

All the On-Screen Display features can be set or adjusted by using the **CURSOR** buttons and the **SELECT** button, except for numeric entries. Press the **CURSOR** buttons toward desired direction and press the **SELECT** button to select.

## 12 INFO button

Press this button when you want to check the channel being received, the picture source, if the channel has stereo (ST) or second audio program (SA), the time, CHANNEL ID and if the TIMER is set.

### INFO button display for Analog Channels

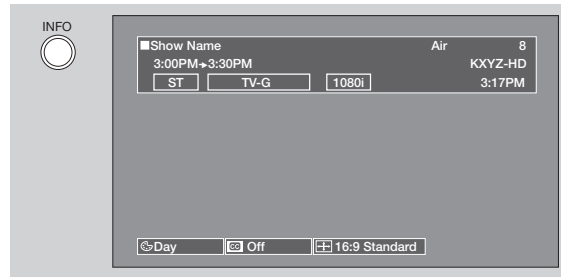

### INFO button display for Digital Channels

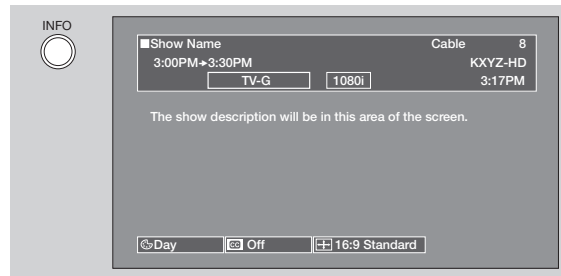
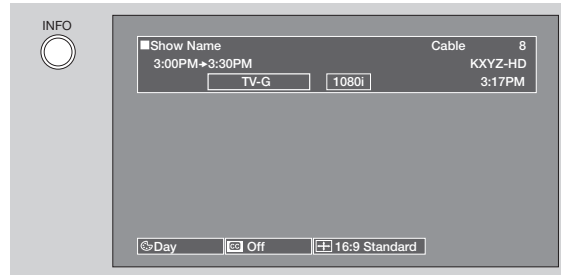

### INFO button display when an S-VIDEO Input is connected to INPUT 1

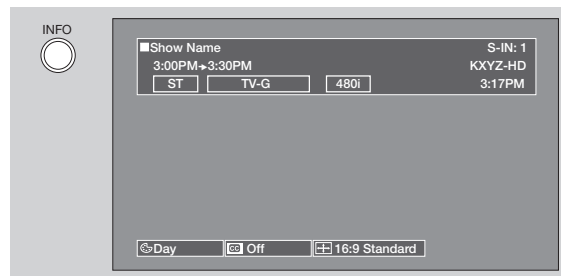

### INFO button display for when a COMPONENT VIDEO: Y-PbPr Input is connected to INPUT 3

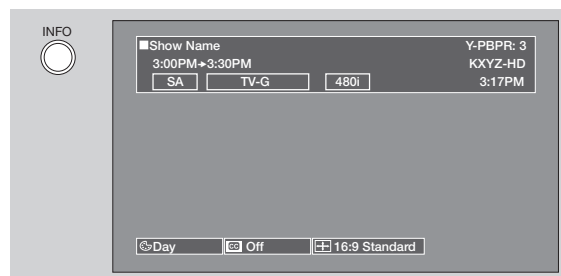

- NOTE:**
1. Press the **INFO** button again or the **EXIT** button to return to normal viewing.
  2. The Aspect setting will not be shown if the channel is locked.



## How to Use the Remote to Control Your TV

### 13 VOLUME (VOL), MUTE button

Press the **VOLUME** button (▲ or ▼) until you obtain the desired sound level.

To reduce the sound to one half of normal volume (SOFT MUTE) to answer the telephone, etc., press the **MUTE** button. Press the **MUTE** button again to turn the sound off completely (MUTE). To restore the sound, press the **MUTE** button one more time, or **VOL UP** (▲).

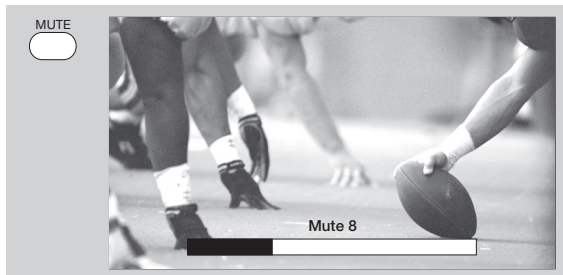
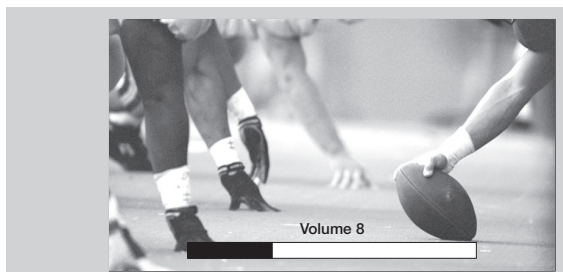

Closed Captioning will display automatically when MUTE/SOFT MUTE is on and Closed Caption is set to **AUTO** (see page 52).

When the TV power is turned off at a volume level 31 or greater, the volume level will default to 30 when the TV is turned on. However, if it is set to a level 30 or less, the volume level will be at the level it was set when the TV is turned on.

### 14 CHANNEL SELECTOR/FAVORITE CHANNEL (FAV CH) buttons

The **CHANNEL SELECTOR** buttons are used to select channels, lock access code, etc. Use the **CHANNEL SELECTOR** buttons to enter one, two, or three numbers to select channels. Enter **0** first for channels **1** to **9**, or simply press the single digit channel you wish to tune then wait a few seconds for the TV to tune. Channel selection may also be performed by **CHANNEL (CH) UP** (▲) or **CHANNEL (CH) DOWN** (▼).

Press the **FAV CH** button to switch to Favorite (FAV) channel mode. You will know you are in Favorite Channel mode when (FAV) is displayed and the displayed channel is **GREEN**. Press it again to return to your regular tuned channels. You can add any channel to your Favorite channel list by pressing and holding down the **FAV CH** button until the displayed channel turns from **WHITE** to highlighted **GREEN**. You can also delete a channel from your favorite channel list by pressing and holding down the **FAV CH** button until the displayed channel turns highlighted **GREEN** to **WHITE**.

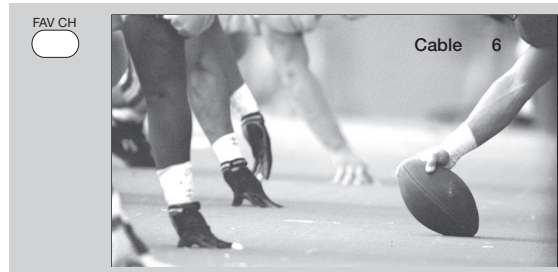
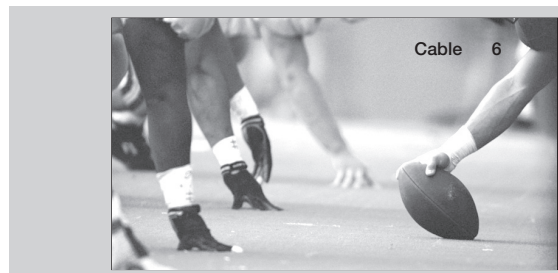

### 15 (-) DASH button

The **(-) DASH** button can only be used when the remote control is in Satellite (SAT) mode.

### 16 LAST CHANNEL (LC) button

Press this button to toggle between the current and last channel viewed.

### 17 RECORD button

Press twice (two times) to record programs when the remote is in VCR mode.



# Picture-in-Picture (PIP)

Your **HITACHI** LCD Rear Projection TV incorporates Two Tuner technology designed for improved viewing enjoyment. This Two Tuner feature allows you to view antenna inputs on both the main picture and sub-picture simultaneously, with separate tuning control for each. When a **DIGITAL** channel is viewed as the main picture, a **DIGITAL** channel can not be viewed as a sub picture. When an **ANALOG** channel or **INPUT** is viewed as the main picture, an **ANALOG** channel or **INPUT** can not be viewed as a sub picture.

To select between main picture and PIP sub-picture tuning, use the **CURSOR** buttons on the remote. The green highlighted channel display will move with every press of the **CURSOR** buttons (◀ or ▶).

The Picture-in-Picture feature is convenient when you want to watch more than one program at the same time. You can watch a TV program while viewing other programs from any of the video inputs.

Use the connection diagram to the right to view VCR program (from Input 1-5) as a sub-picture while viewing another program as main picture (**CABLE**, **AIR**). You may also view the VCR program (from Input 1-5) as a main picture while viewing another program as a sub-picture (**CABLE** or **AIR**).

When installing a CableCARD, connect your coaxial cable to **CABLE** (see page 12). **AIR** will not be available while using a CableCARD.

## 1 PIP button

Press the **PIP** button and a sub-picture will appear in one of the four different modes (**POP**, **PIP**, **SPLIT** or **SURF**), depending on the **INPUT** signal. To change the PIP mode, use the **PIP** button to cycle through the four different modes.

### POP Mode Picture-in-Picture

**POP MODE PIP** displays the sub-picture outside of the main picture. Use the **CURSOR** buttons (▲ or ▼) to move the sub-picture. This feature is not available with a Digital 16:9, 720p and 1080i signal. Please refer to the Picture-in-Picture Modes Table (see page 26).

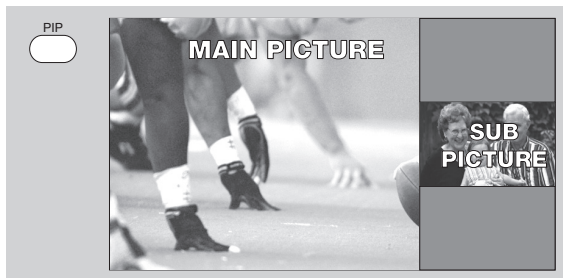

- NOTE:**
1. Press the **CURSOR** buttons (◀ or ▶) to enable the sub-picture sound.
  2. Sub-picture channel availability depends on the channel list.
  3. Two **INPUTS** can't be viewed in PIP mode. Only one **INPUT** (1-5) and one antenna (**CABLE** or **AIR**).

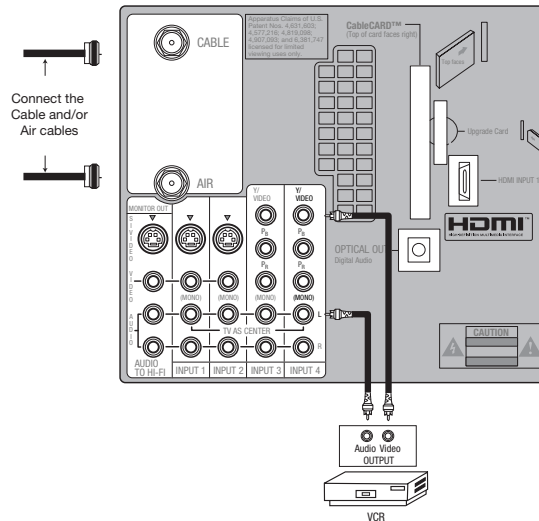

# Picture-in-Picture (PIP)

## PIP Mode Picture-in-Picture

This feature is only available with a Digital 16:9, 720p and 1080i signal. To prevent a pattern burn, occasionally move the sub-picture using the **CURSOR** buttons.



## SPLIT Mode Picture-in-Picture

Split Mode PIP displays the main picture and sub-picture evenly on the screen.



## SURF Mode Picture-in-Picture

Surf Mode PIP automatically scans all active channels (those set in memory) and displays them as PIP sub-pictures or Thumbnail channels. Press the **SELECT** button to stop on a chosen channel. Use the remote **CURSOR** buttons (◀, ▶, ▲ and ▼) to navigate the Thumbnail. Press the **EXIT** button to enable your chosen channel and return to normal viewing.



**NOTE:** Press the **SELECT** button to stop the Surf mode or channel scan. Press the **SELECT** button again to resume Surf mode or channel scan.

Picture-In-Picture (PIP) Modes

PIP Mode	MAIN PICTURE		SUB-IMAGE				
			Digital Tuner		1080i / 720p	480p / 480i Analog Tuner / Video / S-Video	
	Format	Aspect	16 : 9	4 : 3	16 : 9	16 : 9	4 : 3
POP	ANT Digital	4 : 3	-	-	YES	YES	YES
	480p/480i	16 : 9	YES	YES	-	-	-
	ANT Analog Video / S-Video	4 : 3	YES	YES	-	-	-
PIP 4 : 3	ANT Digital	16 : 9	-	-	-	YES	YES
	1080i / 720p	16 : 9	-	YES	-	-	-
PIP 16 : 9	ANT Digital	16 : 9	-	-	YES	YES	YES
	1080i / 720p	16 : 9	YES	-	-	-	-
SPLIT	ANT Digital	16 : 9	-	-	YES	YES	YES
		4 : 3	-	-	YES	YES	YES
	1080i / 720p	16 : 9	YES	YES	-	-	-
	480p / 480I ANT Analog Video / S-Video	4 : 3	YES	YES	-	-	-
SURF 12 PIX	---	---	YES	YES	-	-	YES

# Picture-in-Picture (PIP)

## 2 PAUSE button

If you wish to freeze the sub-picture, press the **PAUSE** button. This is convenient when trying to write down the address for a mail order company, recording statistics for a sporting event, etc. To return the picture to motion, press the **EXIT** button. Press the **PAUSE** button repeatedly to toggle between **FREEZE** modes (Main Freeze, SPLIT and STROBE).



## MAIN FREEZE

Press the **PAUSE** button to freeze one frame of the picture you are currently viewing and the frozen frame will show in the Main Picture. Press the **EXIT** button to return to normal viewing. This feature is useful for freezing a picture frame with addresses.

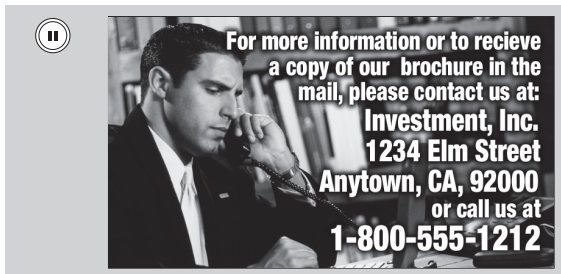

## SPLIT FREEZE

Press the **PAUSE** button to freeze the picture you are currently viewing (only the right sub-picture will freeze). Press the **EXIT** button to return to normal viewing.

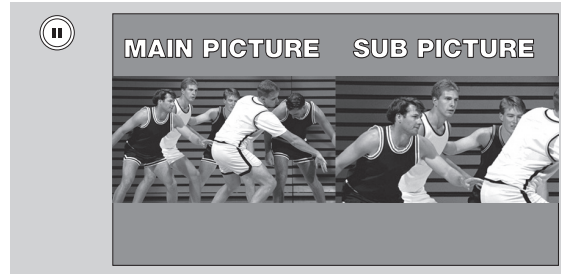

## STROBE FREEZE

Press the **PAUSE** button to freeze three frames of the picture you are currently viewing (only the 3 sub-pictures will freeze). Press the **EXIT** button to return to normal viewing. This feature is useful for viewing a moving picture that has many details, for example, a close play in a sporting event or a golf swing.

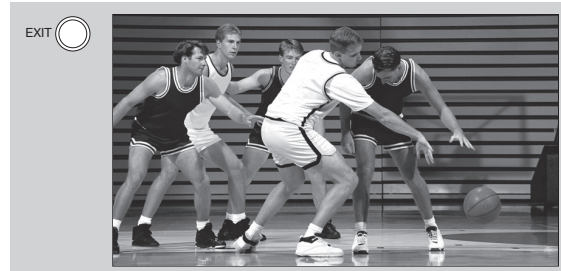
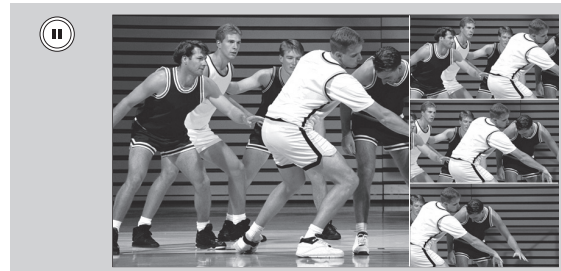

- NOTE:**
1. The default **FREEZE** mode is the **MAIN** freeze followed by the **SPLIT** freeze and then the **STROBE** freeze. The last Freeze mode you selected before you pressed the **EXIT** button will be the one that comes up after pressing the **PAUSE** button again.
  2. Each freeze frame is delayed about 0.1 (1/10) second.

# The Remote Control for Cable Box Functions

## OPERATING THE PRECODED FUNCTION FOR YOUR CABLE BOX.

This remote is designed to operate different types of cable boxes. You must first program the remote to match the remote system of your cable box (refer below for pre-codes).

1. Turn **ON** your cable box.
2. Aim the remote control at the front of your cable box.
3. To switch to Cable (CBL) pre-coded mode, press and release the **CABLE (CBL)** button.
4. Hold down the **CBL** button on the remote and enter the two digit preset code that matches your cable box, as shown below. Release the **CBL** button.
5. Aim the remote at the cable box and press the **POWER** button. The remote will turn off your cable box when the correct two digit preset code is entered. When this occurs, the remote control is programmed for your cable box. If the cable box does not turn off, try a different two digit preset code.
6. The remote will now control your Cable box.

**NOTE:** 1. If your cable box cannot be operated after performing the above procedures, your cable box code has not been precoded into the remote.  
 2. In the unlikely event that your cable box cannot be operated after performing the above procedures, please consult your cable box operating guide.  
 3. The remote control will remember the codes you have programmed until the batteries are removed from the remote control. After replacing the batteries repeat the entire programming procedure as stated above.

- ❶ **CABLE (CBL) button**  
This button allows the remote to control your cable box by setting it to CABLE mode.
- ❷ **PRECODED CABLE BOX buttons**  
These buttons transmit the chosen precoded cable codes.
- ❸ **EXCLUSIVE TV buttons**  
These buttons are for operating the TV.

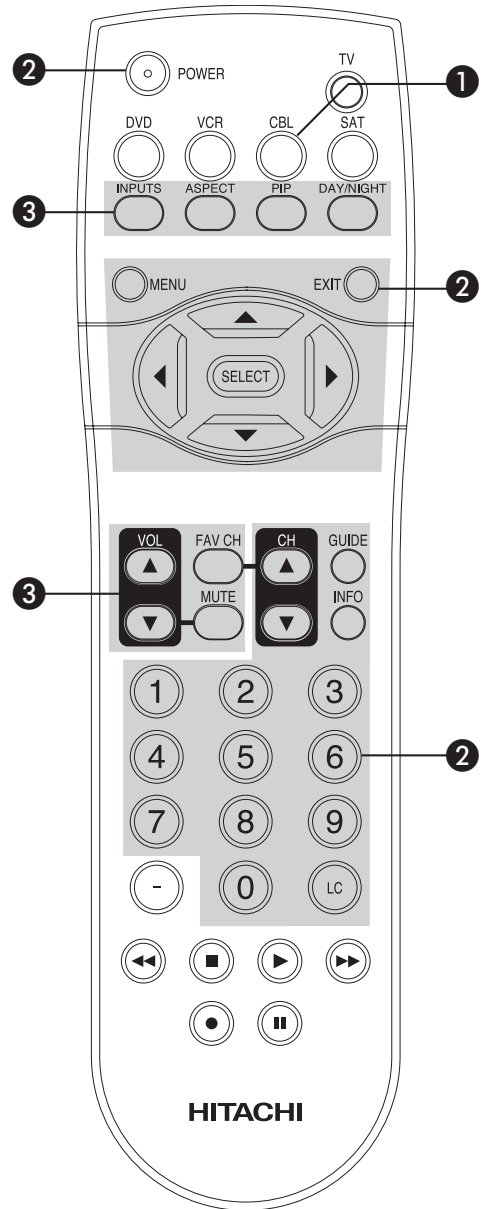

CABLE BRAND	CODES
HAMLIN.....	22, 23, 24, 25
JERROLD .....	00, 01, 02, 03, 04, 05, 06, 07
OAK.....	26, 27, 28
PANASONIC.....	18, 19, 20
PIONEER.....	13, 14
SCIENTIFIC ATLANTA.....	08, 09, 10
TOCOM .....	15, 16
ZENITH.....	11, 12

**MY CABLE BOX CODE IS:** \_\_\_\_\_

**NOTE:** Refer to instruction manual of the Cable Box for operation of the buttons exclusively for the Cable Box.



# The Remote Control for Set-Top Box/Satellite Receiver Functions

## OPERATING THE PRECODED FUNCTION FOR YOUR SET-TOP-BOX/SATELLITE RECEIVER.

This remote is designed to operate different types of set-top-box/satellite systems. You must first program the remote to match the remote system of your set-top-box/satellite systems (refer below for pre-codes).

1. Turn **ON** your set-top-box/satellite systems.
2. Aim the remote control at the front of your set-top-box/satellite systems.
3. To switch to set-top-box/satellite (STB) pre-coded mode, press and release the **SAT** button.
4. Hold down the **SAT** button on the remote and enter the two digit preset code that matches your set-top-box/satellite receiver, as shown below. Release the **SAT** button.
5. Aim the remote at the set-top-box/satellite receiver and press the **POWER** button. The remote will turn off your set-top-box/satellite receiver when the correct two digit preset code is entered. When this occurs, the remote control is programmed for your set-top-box/satellite receiver. If the set-top-box/satellite receiver does not turn off, try a different two digit preset code.
6. The remote will now control your set-top-box/satellite receiver.

**NOTE:**

1. If your set-top-box/satellite receiver cannot be operated after performing the above procedures, your set-top-box/satellite receiver code has not been precoded into the remote.
2. In the unlikely event that your set-top-box/satellite receiver cannot be operated after performing the above procedures, please consult your set-top-box/satellite receiver operating guide.
3. The remote control will remember the codes you have programmed until the batteries are removed from the remote control. After replacing the batteries repeat the entire programming procedure as stated above.

### ① SAT (Set-Top-Box/Satellite) button

This button allows the remote to control your set-top-box/satellite receiver by setting it to SET-TOP-BOX/SATELLITE mode.

### ② PRE-CODED SET-TOP-BOX/SATELLITE RECEIVER buttons

These buttons transmit the chosen pre-coded set-top-box/satellite codes.

### ③ EXCLUSIVE TV buttons

These buttons are for operating the TV.

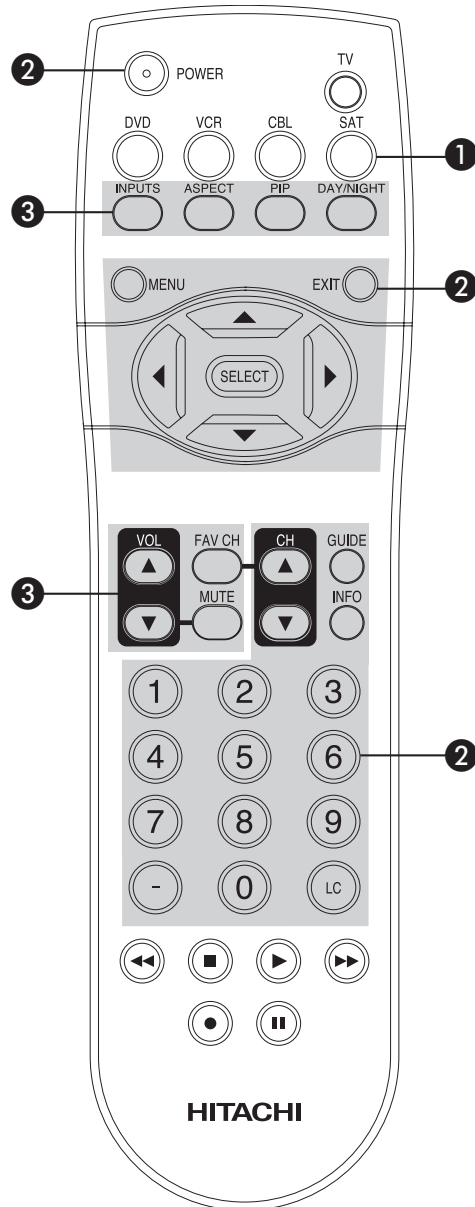

SATELLITE BRAND	CODES
ECOSTAR .....	03
HITACHI.....	00
HUGHES .....	04
RCA .....	01
SONY .....	02

SET TOP BOX BRAND	CODES
PANASONIC .....	05
RCA .....	06
SAMSUNG .....	07
ZENITH.....	08

### MY SATELLITE RECEIVER/ SET TOP BOX CODE IS: \_\_\_\_\_

**NOTE:** Refer to instruction manual of the set-top-box/satellite receiver for operation of the buttons exclusively for the set-top-box/satellite receiver.

# The Remote Control for DVD Functions

## OPERATING THE PRECODED FUNCTION FOR YOUR DVD PLAYER.

This remote is designed to operate different types of DVD players. You must first program the remote to match the remote system of your DVD player (refer below for pre-codes).

1. Turn **ON** your DVD player.
2. Aim the remote control at the front of your DVD player.
3. To switch to DVD pre-coded mode, press and release the **DVD** button.
4. Hold down the **DVD** button on the remote and enter the two digit preset code that matches your DVD player, as shown below. Release the **DVD** button.
5. Aim the remote at the DVD player and press the **POWER** button. The remote will turn off your DVD player when the correct two digit preset code is entered. When this occurs, the remote control is programmed for your DVD player. If the DVD player does not turn off, try a different two digit preset code.
6. The remote will now control your DVD player.
7. You will need to set the display type of your DVD player to **16:9 WIDESCREEN**.

**NOTE:** 1. If your DVD player cannot be operated after performing the above procedures, your DVD player's code has not been precoded into the remote.  
 2. In the unlikely event that your DVD player cannot be operated after performing the above procedures, please consult your DVD player operating guide.  
 3. The remote control will remember the codes you have programmed until the batteries are removed from the remote control. After replacing the batteries repeat the entire programming procedure as stated above.

- 1 DVD button**  
This button allows the remote to control your DVD player by setting it to DVD mode.
- 2 PRECODED DVD Buttons**  
These buttons transmit the chosen precoded DVD codes.
- 3 EXCLUSIVE TV Buttons**  
These buttons are for operating the TV.

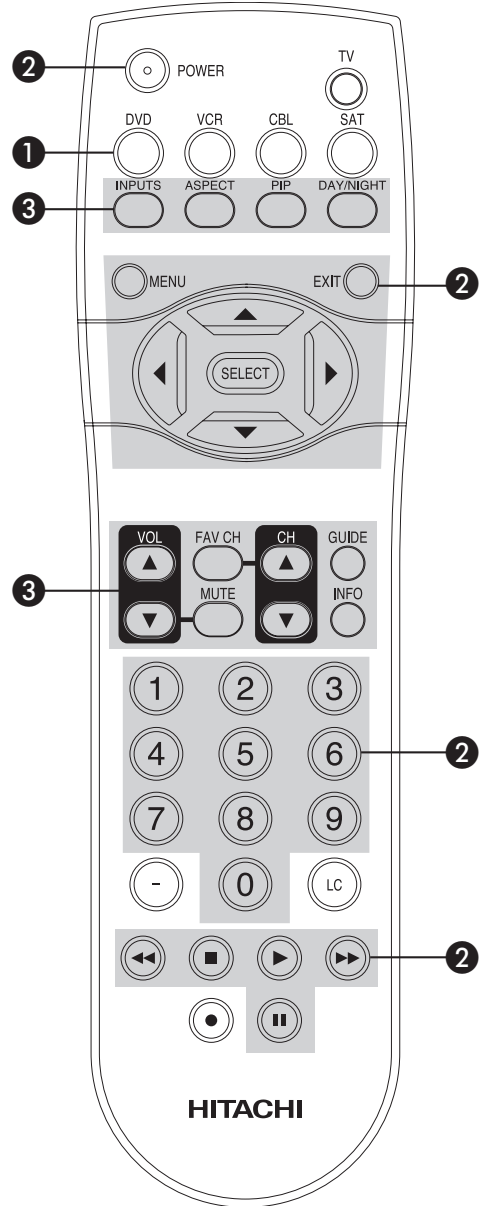

DVD BRAND	CODES
APEX .....	10
GO VIDEO .....	09
HITACHI .....	00
KENWOOD .....	11
PANASONIC .....	02
PIONEER .....	03
RCA .....	04
SAMSUNG .....	06
SANYO .....	07
SONY .....	01
TOSHIBA .....	05

**MY DVD PLAYER CODE IS:** \_\_\_\_\_

**NOTE:** Refer to instruction manual of the DVD player for operation of the buttons exclusively for the DVD player.

# The Remote Control for VCR Functions

## OPERATING THE PRECODED FUNCTION FOR YOUR VCR.

This remote is designed to operate different types of VCRs. You must first program the remote to match the remote system of your VCR (refer below for pre-codes).

1. Turn **ON** your VCR.
2. Aim the remote control at the front of your VCR.
3. To switch to VCR pre-coded mode, press and release the **VCR** button.
4. Hold down the **VCR** button on the remote and enter the two digit preset code that matches your VCR, as shown below. Release the **VCR** button.
5. Aim the remote at the VCR and press the **POWER** button. The remote will turn off your VCR when the correct two digit preset code is entered. When this occurs, the remote control is programmed for your VCR. If the VCR does not turn off, try a different two digit preset code.
6. The remote will now control your VCR.

**NOTE:** 1. If your VCR cannot be operated after performing the above procedures, your VCR's code has not been precoded into the remote.

2. In the unlikely event that your VCR cannot be operated after performing the above procedures, please consult your VCR operating guide.

3. The remote control will remember the codes you have programmed until the batteries are removed from the remote control. After replacing the batteries repeat the entire programming procedure as stated above.

4. Press the Record button twice to record.

### ❶ VCR button

This button allows the remote to control your VCR player by setting it to VCR mode.

### ❷ PRECODED VCR Buttons

These buttons transmit the chosen precoded VCR codes.

### ❸ EXCLUSIVE TV Buttons

These buttons are for operating the TV.

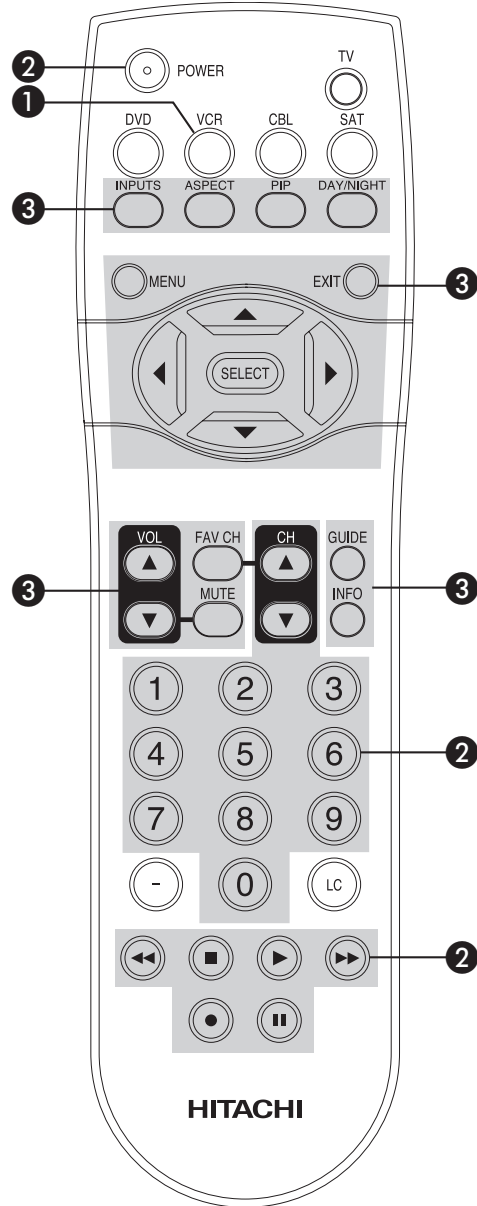

### VCR BRAND

### CODES

EMERSON .....	20, 21, 22, 23, 24
FISHER .....	34, 37, 38, 39
HITACHI .....	00, 01, 02, 03, 04, 05, 06
JVC .....	49, 50, 51
MAGNAVOX .....	12, 13
MITSUBISHI .....	27, 28, 29, 30
NEC .....	40, 41
PANASONIC .....	10, 11
SAMSUNG .....	25, 26
SHARP .....	31, 32
SONY .....	07, 08, 09

**MY VCR PLAYER CODE IS:** \_\_\_\_\_

**NOTE:** Refer to instruction manual of the VCR for operation of the buttons exclusively for the VCR.

# On-Screen Display

1. Press **MENU** on the remote control to display the different features on your **HITACHI** LCD Rear Projection TV.
2. Press the **CURSOR** buttons to navigate and highlight a different feature of the On-Screen Display menu. Press the **SELECT** button to select.
3. Press **EXIT** on the remote control to quickly exit from a menu.

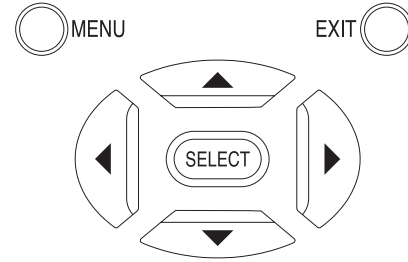

This part of the screen shows which selections are available.

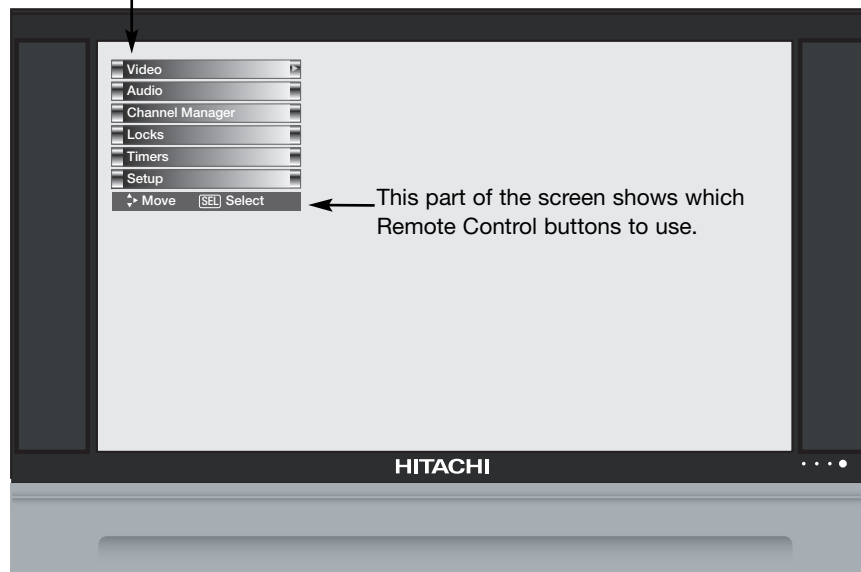



# On-Screen Display

## Video

Picture Mode	Select between the two picture modes; Day and Night.
Contrast	Adjust contrast.
Brightness	Adjust brightness.
Color	Adjust color.
Tint	Adjust tint.
Sharpness	Adjust sharpness.
Color Temperature	Set this to High for less intense color with more blue, set to Medium for natural color, set to Standard for standard colors or Black and White for more reddish color.
Black Enhancement	Enhance picture brightness in light scenes.
Contrast Mode	Choose Automatic Contrast settings.
Noise Reduction	Reduces conspicuous noise in the picture.
Auto Movie Mode	Turn ON/OFF the 3:2 Pull-down detection feature.
Aspect	Choose the picture format aspect ratio.
Black Side Panel	Set the gray side bars on/off when watching 4:3 signals in standard mode.
Reset Video Settings	Choose the Reset Video settings.

## Audio

Treble	Adjust the treble.
Bass	Adjust the bass.
Balance	Adjust the balance.
SRS	Select SRS settings (Off, Wide, Normal)
BBE	Select BBE settings (Off, Soft, Hard)
Audio Source	Select between three Audio Sources.
Internal Speakers	Select internal or external speakers.
Auto Noise Cancel	Eliminates the noise between stations.
Perfect Volume	Adjust volume in fixed setting.
Loudness	Adjust Loudness.
Language	Select Language options if available.
Digital Output	Select Optical Output options.
DRC	Select Dynamic Range Compression to ON or OFF.

## Channel Manager

Signal Meter	Access Signal Meter.
Auto Channel Scan	Set Auto Channel Scan.
Channel List	Set Channel List.

## Locks

Change Access Code	Change Lock access code.
Engage Lock	Choose to lock channel or front panel.
Movie Ratings	Block various types of movies and video types based on motion picture ratings.
TV Ratings	Block various types of movies and television programming based on a parental guide ratings.
Canadian Ratings (ENG)	Block various types of movies and television programming based on the Canadian ratings system.
Canadian Ratings (FRN)	Block various types of movies and television programming based on the Canadian French ratings system.

## Timers

Set the Clock	Set Clock Settings.
Set Sleep Timer	Set Sleep Timer intervals (30 min. intervals, 00:30-3:00).
Set Day/Night Timer	Set Day/Night picture mode settings.
Set Event Timer	Set viewing reservation for TV programs.

## Setup

Menu Preference	Choose English, French, or Spanish text.
Lamp Power Control	Automatic Power Saving Feature.
Set The Inputs	Label Video Inputs, VCR, DVD, etc.
Set Closed Captions	Feature to display dialogue/text.
Set Monitor Out	Set Monitor Out source.
Upgrades	Select to upgrade TV software.
Quick Start Up	Select the TV Quick Start Up options.

**NOTES:**

1. The Signal Meter feature of the Channel Manager OSD is only available for Digital signals.
2. The Language, Digital Output, and the Dynamic Range Compression feature of the Audio OSD are only available for Digital channels.

## Video

Select VIDEO to adjust picture settings and improve picture quality. You can independently customize each of the Video Inputs to your preference to increase viewing performance and pleasure depending upon the video program being viewed. If RESET is selected, only the selected input will reset to initial conditions.

### Picture Mode

Use this function to choose from automatic picture settings to optimize your TV's performance.

1. Use the **CURSOR** buttons ◀ or ▶ to highlight and select **PICTURE MODE** settings.
2. Press **EXIT** to quit menu or select **PICTURE MODE** to return to previous menu.

Function	Day	Night
Contrast	100%	90%
Brightness	50%	50%
Color	50%	30%
Tint	50%	50%
Sharpness	50%	20%
Color Temperature	High	Standard
Black Enhancement	Middle	Off
Contrast Mode	Dynamic	Normal
Noise Reduction	Low	Low
Black Side Panel	On	On

1. Use the **CURSOR** buttons ▲ or ▼ to highlight the function to be adjusted.
2. Press the **CURSOR** buttons ◀ or ▶ to adjust the function. Press the **SELECT** button to select the function settings.
3. Press **MENU** to return to main menu or select **PICTURE MODE** to return to previous menu.
4. Press **EXIT** to quit menu.

### Contrast

Use this function to change the contrast between black and white levels in the picture.

### Brightness

Use this function to adjust overall picture brightness.

### Color

Use this function to adjust the level of color in the picture.

### Tint

Use this function to adjust flesh tones so they appear natural.

### Sharpness

Use this function to adjust the amount of fine detail in the picture. Sharpness function will be disabled when Noise Reduction is set to High.

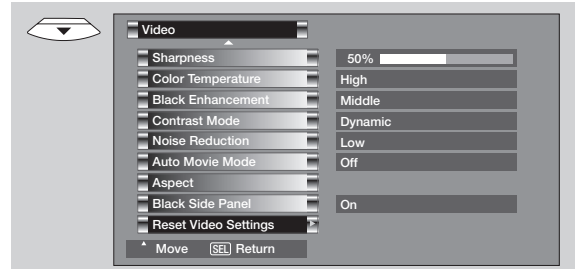
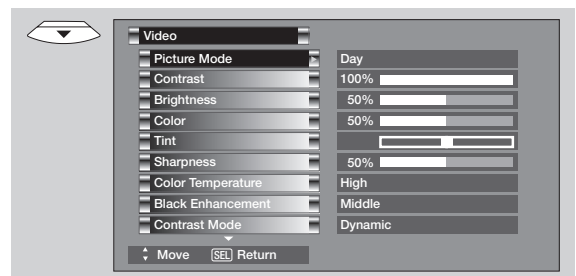
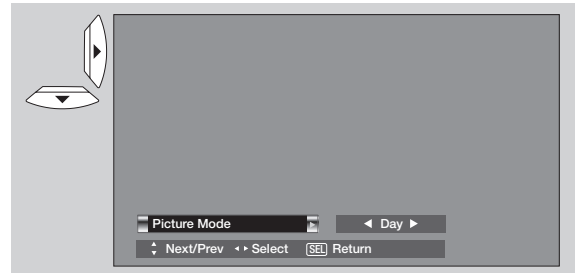
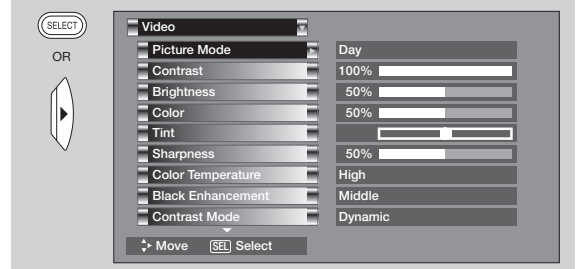

# Video

## Color Temperature

Set this to High for cooler color with more blue, set to Medium for more natural color, set to Standard for accurate color or set to Black/White for more reddish color.

## Black Enhancement

Use this function to enhance Picture brightness in light scenes using the settings off, low, middle and high.

## Contrast Mode

Use this function to choose between 2 Contrast Mode settings. Set to Dynamic for darker images more in the level of Black and set to Normal for a balanced White to Black level.

- NOTE:**
1. If **CONTRAST** is selected, you are adjusting **CONTRAST**. The additional menu items **BRIGHTNESS**, **COLOR**, **TINT**, and **SHARPNESS** can be selected and adjusted in the same manner.
  2. It may be necessary to adjust **TINT** to obtain optimum picture quality when using the **COMPONENT VIDEO Y-PbPr** input jacks.
  3. **CABLE** and **AIR** share a Video setting. Also, each of the video inputs have their own independent settings.
  4. If **CONTRAST** is set to minimum level, the OSD will be difficult to see.

## Noise Reduction

The **NOISE REDUCTION** function automatically reduces conspicuous noise in the picture without degrading picture quality. Set **NOISE REDUCTION** to **OFF** if the TV experiences picture blocking. When Noise Reduction is set to High, Sharpness function is disabled (grayed out).

## Auto Movie Mode

The Auto Movie Mode turns the 3:2 PULLDOWN DETECTION SPECIAL FEATURE ON or OFF. Theatrical movies are shot on film at 24 frames or still pictures per second, instead of 30 frames or 60 fields like video. When film is transferred to video for television viewing, the disparity between the two frame rates must be reconciled. This involves a process known as 3:2 pulldown.

When Auto Movie Mode is turned ON from the VIDEO menu, your Hitachi LCD Rear Projection Television will activate the circuitry for this special feature to improve video performance when watching film based sources.

- NOTE:**
1. When using Progressive Scan Component, HDMI or DVI input (ex. 480p, 740p, 1080i), Auto Movie Mode will not be available (grayed out).
  2. All video settings are independent of each other based on it's input (Cable, Air, Input 1-5, Photo Input).

## Aspect

Use this function to select the Picture Format Aspect Ratio.

1. Use the **CURSOR** buttons ▲ or ▼ to highlight the function to be adjusted.
2. Press the **CURSOR** buttons ◀ or ▶ to select **ON** or **OFF**.
3. Press the **CURSOR** buttons ◀ or ▶ to select **ASPECT MODE**.

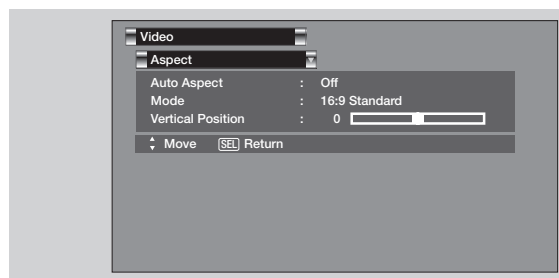

## Auto Aspect

Automatically adjust the Aspect Ratio depending on the input signal to fill the screen.

- NOTE:**
1. The Auto Aspect function is recommended on an input signal with **VIDEO ID**.
  2. The Auto Aspect function is best used on **COMPOSITE VIDEO**, **S-VIDEO**, **480i** and **480p COMPONENT/HDMI** signals.
  3. See page 22 for **ASPECT MODE** availability.

4. Press the **CURSOR** buttons ◀ or ▶ to select **VERTICAL POSITION**.

# Video

## Vertical Position

This function allows you to select when aspect style is either **4:3 EXPANDED/ZOOM1/ZOOM2** or **16:9 ZOOM**. Vertical position can be changed with these modes. For example, it will be useful for centering the picture area at both the top and bottom of the picture with 480i/480P signal. Adjustable range is -10 (video center is toward bottom of screen) to +10 (video center is toward top of screen).

**NOTE:** Vertical Position will not be available in 4:3 STANDARD and 16:9 STANDARD MODES.

5. Press **MENU** to return to main menu or select **PICTURE MODE** to return to previous menu.
6. Press **EXIT** to quit menu.

## Black Side Panel

The BLACK SIDE PANEL function turns the gray side bars on/off when watching 4:3 signals in Standard mode. The top/bottom gray bar will appear in SPLIT MODE PIP and SPLIT FREEZE. The TV set will always return to "Set Black Side Panel - OFF" setting every time the TV is powered "OFF".

**NOTE:** To maximize operating life of the TV's picture tubes when watching 4:3 signal, Black Side Panel is cancelled at Power OFF. It is recommended to watch 4:3 signal with gray side bar.

## Reset Video Settings

This function allows you to Reset the Video Menu Settings of the present input and return it to the Day VIDEO mode.

1. Use the **CURSOR** buttons ▲ or ▼ to highlight the function to be adjusted.
2. Press the **SELECT** button to select **RESET VIDEO SETTINGS**.
3. Use the **CURSOR** button ▼ to access other video settings.

You can customize each of the Video Inputs to your preference to increase viewing performance and pleasure, depending upon the video program being viewed. If **RESET** is selected, only the selected Input will reset to the initial conditions as explained above.

If **RESET** is selected in Input 1, only Input 1 will return to factory conditions.

- NOTE:**
1. If YES is selected, the VIDEO MENU SETTINGS will be reset to the original factory settings on all modes during the next power on/off
  2. Channel List, Volume level and Last-CH selection remains unchanged.

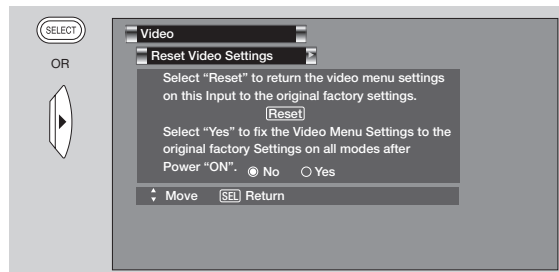
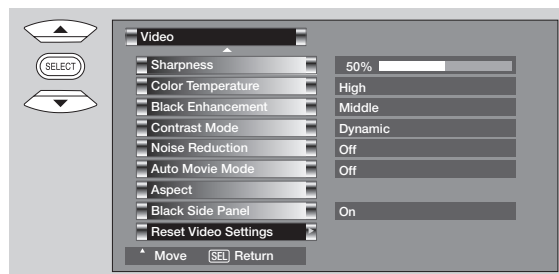

# Audio

## Audio

Select AUDIO to adjust the TV to your preference and to improve the sound quality.

1. Use the **CURSOR** buttons ▲ or ▼ to highlight the function to be adjusted.
2. Press the **CURSOR** buttons ◀ or ▶ to adjust the function.
3. Press **EXIT** to quit the menu or select **AUDIO** to return to the main menu.

**NOTE:** If **TREBLE** is selected you are adjusting **TREBLE**. The additional menu items **BASS** and **BALANCE** can be selected and adjusted in the same manner.

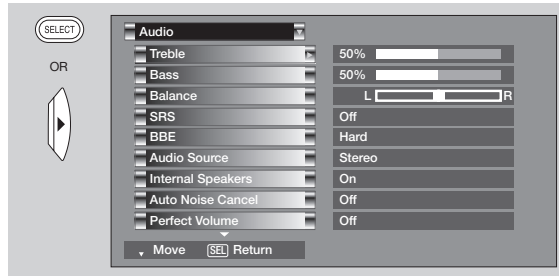

### Treble

This function controls the high frequency audio to all speakers.

### Bass

This function controls the low frequency audio to all speakers.

### Balance

This function will control the left to right balance of the Projection TV internal speakers.

### SRS

Based on the principles of the human hearing system, **SRS** technology delivers an exciting and realistic 3D Sound experience from just two external speakers (or) the two internal speakers of your **HITACHI** Television. If your **HITACHI** Television is connected to an external audio system, **SRS** will also create an incredible 3D sound experience from two speakers and even enhance a complete multi-speaker surround sound system.



*SRS and the (●) symbol are trademarks of SRS Labs, Inc. SRS technology is incorporated under license from SRS Labs, Inc.*

### BBE

Sound reproduction quality enhancement system. The **BBE** technology produces sound that is natural and crisp from just two speakers or the two internal speakers found in your **HITACHI** television. If your **HITACHI** television is connected to an external audio system, **BBE** will also create an incredible crisp sound experience from two speakers. **BBE** brings to the listener's ear a more complete and accurate reproduction of the original performance. Each voice, speaking or singing, each instrument or sound effect is presented with its attendant harmonics or partials more clearly audible. The ear can then more easily recognize the unique tonal colors of each sound as though the sound was being produced live.



*Licensed by BBE Sound, Inc. under USP5510752 and 5736897. BBE and BBE symbol are registered trademarks of BBE Sound, Inc. Manufactured under license from BBE Sound, Inc.*

# Audio

## Audio Source

Multi-Channel Television Sound will allow you to select **STEREO** (a stereo broadcast), **MONO** (monaural sound) used when receiving a weak stereo broadcast or **SECOND AUDIO PROG (SA)** which may be a secondary language, weather report, etc.

The sources received will be displayed at the top left edge of the TV. The source you select will be displayed above the sources received. See example to the right for each selection when both stereo and second audio are received (monaural is always received).

1. Press the **INFO** button to display your settings.

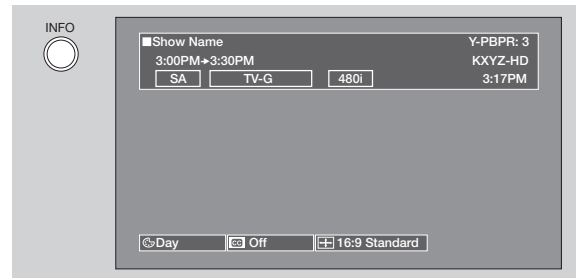
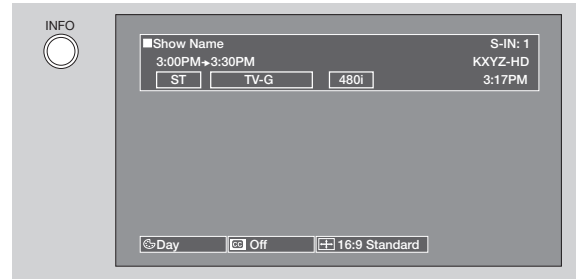

## Internal Speakers

This function is useful when setting up the external speakers.

ON	Select this feature if using the internal speakers only.
TV as Center	Select this feature when setting up external speakers from a separate stereo system. The TV's speakers will work as the center speaker.
OFF	Select this feature if you prefer to use only speakers from a separate stereo system.

## Auto Noise Cancel

This function eliminates the noise between stations. If a channel is tuned and is noisy, this function will automatically eliminate the audio for that channel.

## Perfect Volume

This function will automatically adjust volume so each channel and input has the same average volume level.

## Loudness

This function turns loudness **ON** or **OFF**. It will improve the quality of both low and high frequency sounds when listening at low volume levels.

# Audio

Use the functions below if your TV is connected to an amplifier/receiver with **OPTICAL DIGITAL INPUT** with Dolby Digital or PCM decoder capabilities.

1. Use the **CURSOR** buttons ▲ or ▼ to highlight the function to be adjusted.
2. Press the **CURSOR** buttons ◀ or ▶ to adjust the function.
3. Press **EXIT** to quit the menu or select **AUDIO** to return to the main menu.

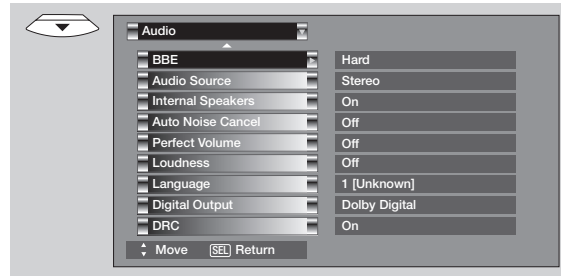
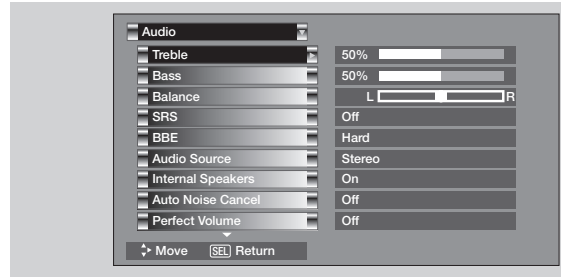

## Language

Some programs transmit more than one DTV language option. Most will have English as a default language. The language function will allow you to select up to 4 language options (if available).

## Digital Output

This function allows you to select between Dolby® Digital and PCM.

Dolby® Digital	Select this feature if the TV is connected to an amplifier/ receiver with a Dolby® Digital only decoder; it will provide six independent soundtrack channels through the optical output jack (Digital Audio).
PCM	Select this feature if the TV is connected to an amplifier/ receiver with a PCM only decoder; it will provide two independent soundtrack channels through the optical output jack (Digital Audio).

*Manufactured under license from Dolby Laboratories. Dolby and the double-D symbol are trademarks of Dolby Laboratories.*

## DRC

Dynamic Range Compression - Use this function to compress the range of sound volume. By compressing the range of sound volume, it is possible not only to suppress the output of loud sound at night but also to raise the volume of low sound. This is only effective when the TV is connected via the optical out (digital audio) to an amplifier/receiver with a Dolby® Digital decoder. The default setting is ON. Use the **CURSOR** buttons ◀ or ▶ to select the chosen options.

**NOTE:** These functions are only available when viewing digital programs.

# Channel Manager

## Channel Manager

Select **CHANNEL MANAGER** to set your Antenna options, run Auto Channel Scan, Check Signal Meter and Set Channel List.

1. Use the **CURSOR** buttons ▲ or ▼ to highlight the function to be adjusted.
2. Press the **SELECT** button or **CURSOR** button ► to select.

### Signal Meter

Select **SIGNAL METER** when using an indoor or outdoor antenna. This feature will show the signal strength and peak values of the Antenna signal to help you adjust your antenna to optimize signal reception.

1. Use the **CURSOR** buttons ▲ or ▼ to highlight **SIGNAL METER**.
2. Press the **SELECT** button to select.

**NOTE:** The Signal Meter will not be available (grayed out) when watching analog channels.

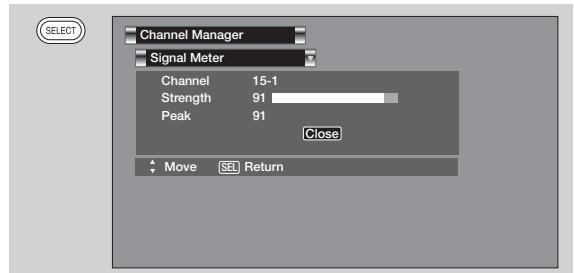
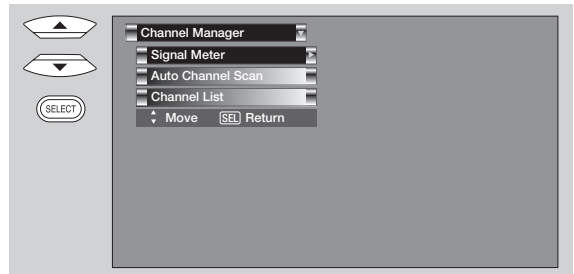
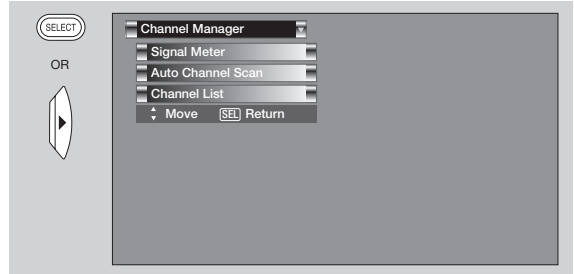



# Channel Manager

## Auto Channel Scan

This feature will automatically store active TV channels in Auto Channel Scan memory.

1. Use the **CURSOR** buttons ▲ or ▼ to highlight **CABLE** or **AIR**.
2. Press the **CURSOR** buttons ◀ or ▶ to highlight the **START** or **RESET** option.
3. Press the **SELECT** button to select.

**NOTE:** 1. When a CableCARD is installed, Auto Channel Scan for **CABLE** will not be available.  
2. If certain channels are poor or not possible in Cable (1) mode, set cable source to Cable (2) by using the **CURSOR** buttons ◀ or ▶.

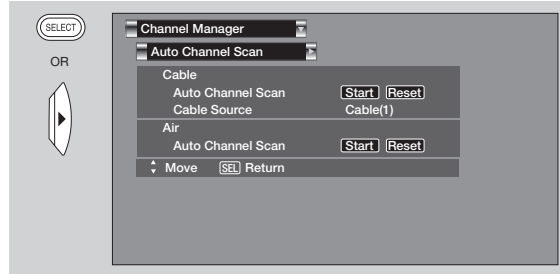
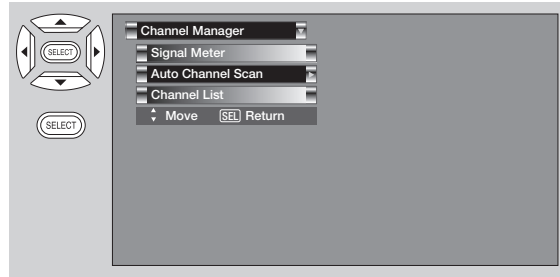

## Channel List

This function allows you to review which channels are labeled (**CH ID**), which have been added to **CHANNEL MEMORY (SCAN)**, which are protected by **LOCK** and which are your **FAVORITE (FAV) CHANNELS**.

1. Use the **CURSOR** buttons navigate the Channel List.
2. Press the **SELECT** button to select **ON** or **OFF** on the **SCAN** and **LOCK** Columns.
3. To select the **LOCK** column, input the access code. (Default access code: 0000)
4. Press the **FAV** button to set or remove the **FAVORITES** settings.
5. Press the **EXIT** button to return to normal viewing.

**NOTE:** 1. When a CableCARD is installed, the Channel List will be dependent on channels agreed upon by you and your cable operator.  
2. The Channel List cannot be updated by only changing the Cable Source. Auto Channel Scan must also be performed for the Channel List to be updated.

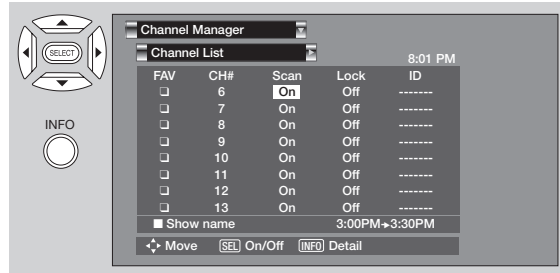
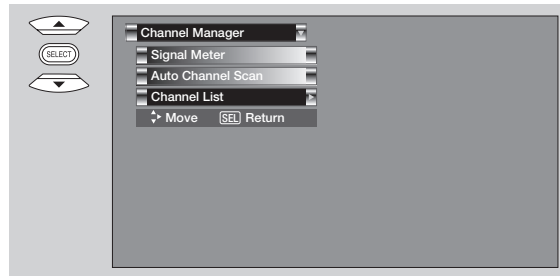

## Locks

This function will block out the picture and sound of the selected channel or video input. It can also be used to keep the TV from being viewed for a scheduled time period that you set.

The code to enter the Locks feature is a four digit access code number. The factory preset code is **0000**. Use the **NUMBER** buttons to enter the access code.

1. Use the **CURSOR** buttons ▲ or ▼ to highlight the function.
2. Press the **SELECT** button to select.

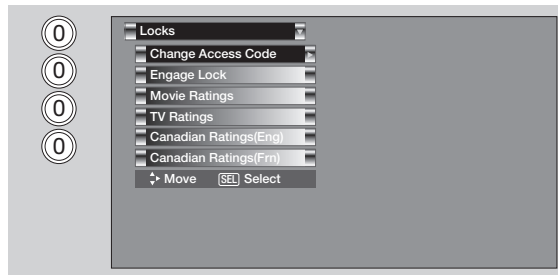
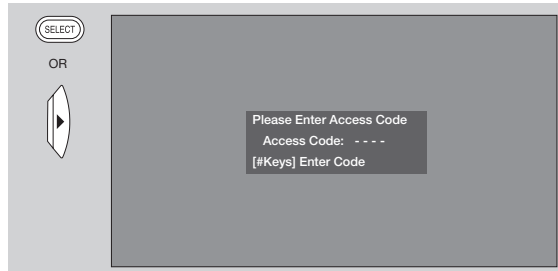
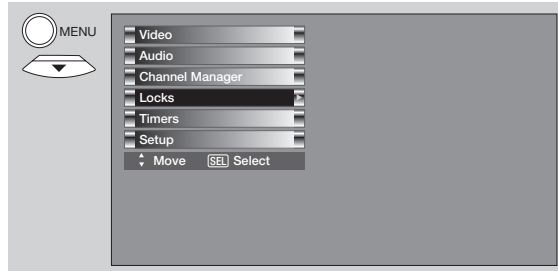

### Change Access Code

1. To change the **ACCESS CODE NUMBER**, select **CHANGE ACCESS CODE** to change the factory preset code (**0000**) to your preference.

If you forget your **ACCESS CODE NUMBER**, use the factory code **7777** to erase your key number. This will reset the access code number back to the factory preset (**0000**).

2. Enter a new four digit number.
3. Press **EXIT** to quit the menu or select **CHANGE ACCESS CODE** to return to the previous menu.

### Engage Lock

When **ENGAGE LOCK** is selected, **SET CHANNEL LOCK** and **SET FRONT PANEL LOCK** can be set individually.

When **SET CHANNEL LOCK** is turned on, the picture and sound for the chosen channel will be blocked out.

When **SET FRONT PANEL LOCK** is turned on, all buttons on the Front Panel will be deactivated, except the **POWER** button.

When **MOVIE RATINGS** is selected, you can block various types of movies and video tapes based on motion picture ratings. Picture-in-Picture will also be blocked automatically (see page 43).

When **TV RATINGS** is selected, various types of television programming based on a parental guide ratings will be blocked. Picture-in-Picture will also be blocked automatically (see page 44).

Use **CANADIAN RATINGS** to block various types of movies and television programs based on the two rating systems used in Canada that you feel may be inappropriate due to its content (see pages 45-46).

**NOTE:** If **MOVIE/TV RATINGS LOCK** function settings are **ON**, **SURF** will be deactivated.

# Locks

## Movie Ratings

Use Movie Ratings to prevent viewing of any movie that you feel may be inappropriate due to its content.

1. Use the CURSOR buttons ▲ or ▼ to select the **MOVIE RATING** category that you want to block.
2. Press **SELECT** to block the **MOVIE RATING** that you have selected. Once rating is selected, for example PG-13, all movies rated PG-13 and higher (R, NC-17, and X) will be blocked.
3. Press **EXIT** to quit the menu or select **MOVIE RATING** to return to the previous menu.

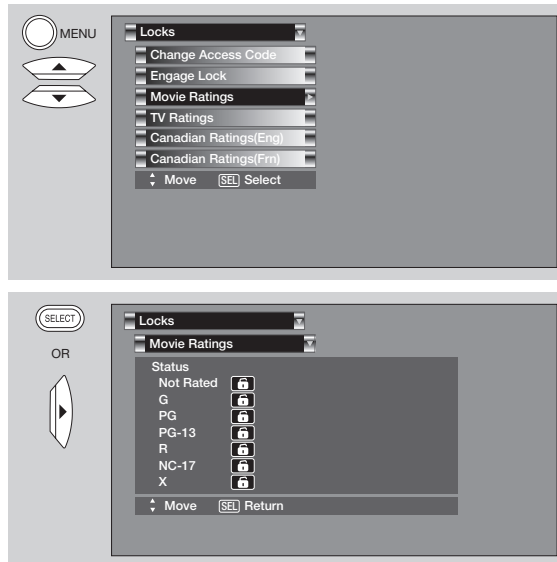

## Motion Picture Ratings Table

NOT RATED	Contains no rating. Not Rated (NR) and Not Applicable (NA) programs. Movie has not been rated or ratings do not apply.
G	General audiences. All ages admitted.
PG	Parental guidance suggested. Some material may not be suitable for children.
PG-13	Parents strongly cautioned. Some material may be inappropriate for children under 13.
R	Restricted. Under 17 requires accompanying parent or adult guardian.
NC-17	No one 17 and under admitted.
X	Adults only

- NOTE:**
1. A movie rating is dependent upon the movie that is viewed. If the movie does not carry a rating, the TV will not block it.
  2. Blocking **NOT RATED** programs may block emergency programming, sports, news, public service announcements, religious programs and weather.
  3. If a CableCARD is installed, your cable operator may provide an Emergency Alert System (EAS) message in the event of a local or national emergency with the purpose of alerting the general public. When you receive such messages, the Projection Television will immediately tune to an EAS channel as directed by the EAS message. Please be advised that if the EAS channel is blocked using the LOCKS feature, you will not be able to tune to that channel.

# Locks

## TV Ratings

Use **TV RATINGS** to prevent the viewing of any TV program that you feel may be inappropriate due to its content.

1. Use the **CURSOR** buttons ▲ or ▼ to select the **TV RATING** category that you want to block.
2. Press **SELECT** to block the **TV RATING** that you have selected.
3. Press **EXIT** to quit the menu or select **TV RATING** to return to the previous menu.

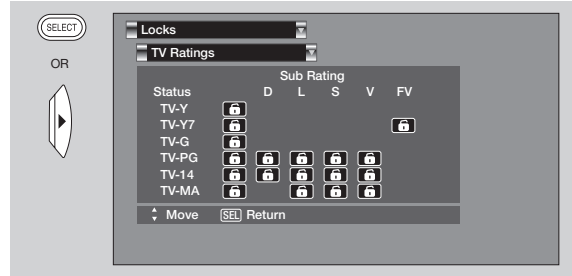
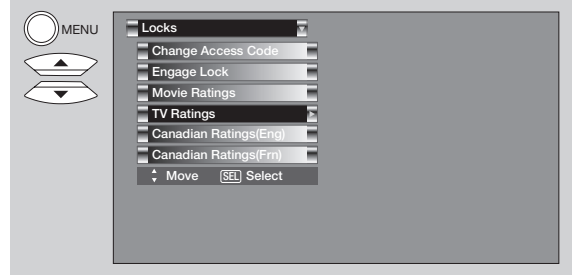

## TV Parental Guide Ratings Table

TV-Y	All children. The themes and elements in this program are specifically designed for a very young audience, including children from ages 2-6.
TV-Y7	Directed to older children. Themes and elements in this program may include mild physical or comedic violence, or may frighten children under the age of 7.
TV-G	General audience. It contains little or no violence, no strong language, and little or no sexual dialogue or situations.
TV-PG	Parental guidance suggested. The program may contain infrequent coarse language, limited violence, some suggestive sexual dialogue and situations.
TV-14	Parents strongly cautioned. This program may contain sophisticated themes, intense sexual situation, more intense violence and intensely suggestive dialogue.
TV-MA	Mature audiences only. This program may contain mature themes, indecent language, graphic violence, and explicit sexual content.
FV	Fantasy Violence
V	Violence
S	Sexual Situation
L	Adult Language
D	Sexually Suggestive Dialogue

**NOTE:** 1. If you Block **TV-14D**, you will still permit **TV-MA** programs; If you block **TV-14V**, you will automatically block **TV-MAV** programs, but you will still permit **TV-MALS** programs. This means that the TV will block violence in **TV-14** and higher (**TV-MA**), but not language and sex.

2. TV program ratings are dependent on the broadcaster. If the program is not rated, the TV will not block it.

3. If a CableCARD is installed, your cable operator may provide an Emergency Alert System (EAS) message in the event of a local or national emergency with the purpose of alerting the general public. When you receive such messages, the Projection Television will immediately tune to an EAS channel as directed by the EAS message. Please be advised that if the EAS channel is blocked using the LOCKS feature, you will not be able to tune to that channel.

# Locks

## Canadian Ratings (Eng)

Use **CANADIAN RATINGS (ENG)** to block any type of movie and television program in Canada that you feel might be inappropriate in its content.

1. Use the CURSOR buttons ▲ or ▼ to select the **CANADIAN RATINGS (ENG)** category that you want to block.
2. Press **SELECT** to block the **CANADIAN RATINGS (ENG)** that you have selected. Once rating is selected, for example **C8+**, all movies and television programs rated **C8+** and higher (**G**, **PG**, **14+** and **18+**) will be blocked automatically.
3. Press **EXIT** to quit the menu or select **CANADIAN RATINGS (ENG)** to return to the previous menu.

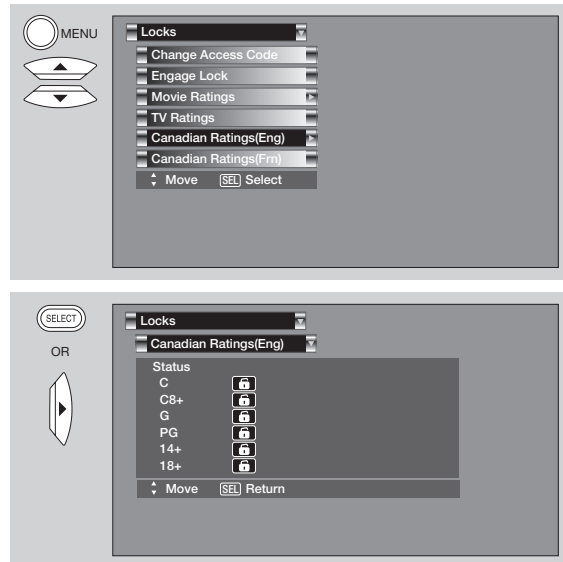

## Canadian Ratings English Table

C	Programming intended for children under age 8 - Violence Guidelines; Careful attention is paid to themes, which could threaten children's sense of security and well-being. There will be no realistic scenes of violence. Depictions of aggressive behaviour will be infrequent and limited to portrayals that are clearly imaginary, comedic or unrealistic in nature. Other Content Guidelines: There will be no offensive language, nudity or sexual content.
C8+	Programming generally considered acceptable for children 8 years and over to watch on their own - Violence Guidelines: Violence will not be portrayed as the preferred, acceptable, or only way to resolve conflict; or encourage children to imitate dangerous acts which they may see on television. Any realistic depictions of violence will be infrequent, discreet, of low intensity and will show the consequences of the acts. Other Content Guidelines: There will be no profanity, nudity or sexual content.
G	General Audience - Violence Guidelines: Will contain very little violence, either physical or verbal or emotional. Will be sensitive to themes which could frighten a younger child, will not depict realistic scenes of violence which minimize or gloss over the effects of violent acts. Other Content Guidelines: There may be some inoffensive slang, no profanity and no nudity.
PG	Parental Guidance - Programming intended for a general audience but which may not be suitable for younger children. Parents may consider some content inappropriate for unsupervised viewing by children ages 8-13. Violence Guidelines: Depictions of conflict and/or aggression will be limited and moderate; may include physical, fantasy, or supernatural violence. Other Content Guidelines: May contain infrequent mild profanity, or mildly suggestive language. Could also contain brief scenes of nudity.
14+	Programming contains themes or content which may not be suitable for viewers under the age of 14 - Parents are strongly cautioned to exercise discretion in permitting viewing by pre-teens and early teens. Violence Guidelines: May contain intense scenes of violence. Could deal with mature themes and societal issues in a realistic fashion. Other Content Guidelines: May contain scenes of nudity and/or sexual activity. There could be frequent use of profanity.
18+	Adult - Violence Guidelines: May contain violence integral to the development of the plot, character or theme, intended for adult audiences. Other Content Guidelines: May contain graphic language and explicit portrayals of nudity and/or sex.

# Locks

## Canadian Ratings (Frn)

Use **CANADIAN RATINGS (FRN)** to block Canadian French programs according to various program ratings that you feel might be inappropriate in its content.

1. Use the CURSOR buttons ▲ or ▼ to select the **CANADIAN RATINGS (FRN)** category that you want to block.
2. Press **SELECT** to block the **CANADIAN RATINGS (FRN)** that you have selected. Once rating is selected, for example **8 ANS+**, all movies and television programs rated **8 ANS+** and higher will be blocked automatically.
3. Press **EXIT** to quit the menu or select **CANADIAN RATINGS (FRN)** to return to the previous menu.

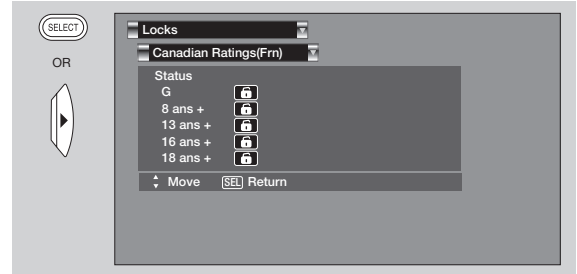
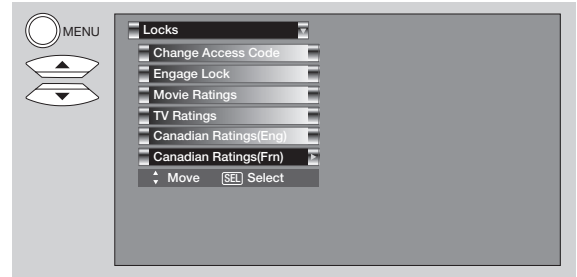

## Canadian Ratings French Chart

G	General - Programming intended for audiences of all ages. Contains no violence, or the violence content is minimal or is depicted appropriately with humor or caricature or in an unrealistic manner.
8 ans +	8 + General - Not recommended for young children - Programming intended for a broad audience but contains light or occasional violence that could disturb young children. Viewing with an adult is therefore recommended for young children (under the age of 8) who cannot differentiate between real and imaginary portrayals.
13 ans +	Programming may not be suitable for children under the age of 13 - Contains either a few violent scenes or one or more sufficiently violent scenes to affect them. Viewing with an adult is therefore strongly recommended for children under 13.
16 ans +	Programming is not suitable for children under the age of 16 - Contains frequent scenes of violence or intense violence.
18 ans +	Programming restricted to adults - Contains constant violence or scenes of extreme violence.

# Timers

## Timers

Select **TIMERS** to set your Clock, Sleep Timer, Event Timer and Day/Night Timer Recordings.

1. Use the **CURSOR** buttons ▲ or ▼ to highlight the function to be adjusted.
2. Press the **SELECT** button or **CURSOR** button ► to select.

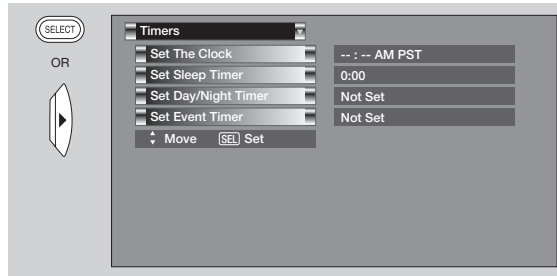

### Set The Clock

The Clock must be adjusted before you can use the **SET EVENT TIMER** or **DAY/NIGHT TIMER** feature.

1. Use the **CURSOR** button ▼ to highlight the chosen **TIME ZONE** settings. Use CURSOR buttons ◀ or ► to set TIME ZONE and press SELECT to set.
2. Press CURSOR button ▼ to select Date. Use CURSOR buttons ◀, ▶, ▲ or ▼ to set Month, Day and Year. Press SELECT to set.
3. Press CURSOR button ▼ to select Time. Use CURSOR buttons ◀, ▶, ▲ or ▼ to set Hour, Minute, AM or PM. Press SELECT to set.
4. If you observe Daylight Saving Time, press CURSOR button ▼ to select **AUTOMATICALLY ADJUST CLOCK FOR DAYLIGHT SAVINGS CHANGES** and press SELECT to set.
5. Press **EXIT** to quit the menu or select **SET THE CLOCK** to return to the previous menu.

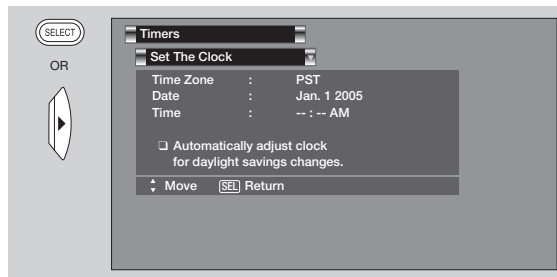
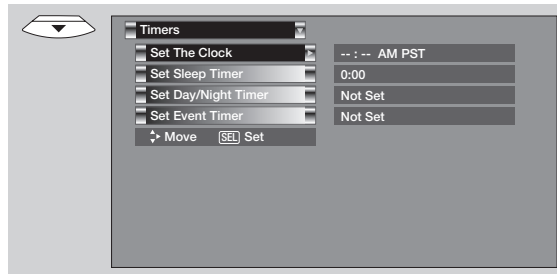

- NOTE:**
1. When **AUTOMATICALLY ADJUST CLOCK FOR DAYLIGHT SAVING CHANGES** is checked ✓, the TV will automatically calculate the clock adjustment for Daylight Saving.
  2. When the CableCARD is used, the TV will **SET THE CLOCK** automatically.
  3. The TV counts electrical pulses for regulating the **TIMERS**. When the power cord is unplugged then plugged in quickly, the clock is stopped momentarily and the **TIME** indication will become slow.



# Timers

## Set Sleep Timer

Select this feature to set your **SLEEP TIMER** from 30 minutes to 3 hours (30 minute increments).

1. Press the **CURSOR** buttons ◀ or ▶ repeatedly to set your Timer from **0:00, 0:30, 1:00, 1:30, 2:00, 2:30** and **3:00**.

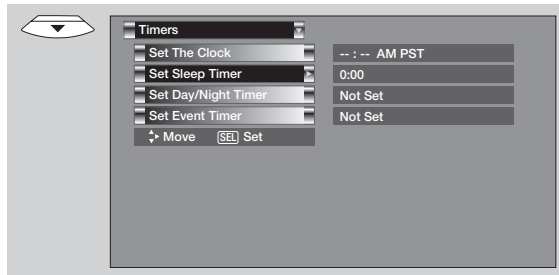

## Set Day/Night Timer

Select this feature to activate and set your TV's **DAY/NIGHT PICTURE MODE** automatically.

1. Use the **CURSOR** buttons ▼ to select **ACTIVATE**. Press **SELECT** button to set (a check mark will appear in the box).
2. Use the **CURSOR** button ▼ to select **DAY MODE ON**. Using **CURSOR** buttons ◀, ▶, ▲ or ▼, set the **ON TIMER**. Press the **SELECT** button to set.
3. Use the **CURSOR** button ▼ to select **DAY MODE OFF**. Using **CURSOR** buttons ◀, ▶, ▲ or ▼, set the **OFF TIMER**. Press the **SELECT** button to set.
4. Press **EXIT** to quit the menu or select **SET DAY/NIGHT TIMER** to return to the previous menu.

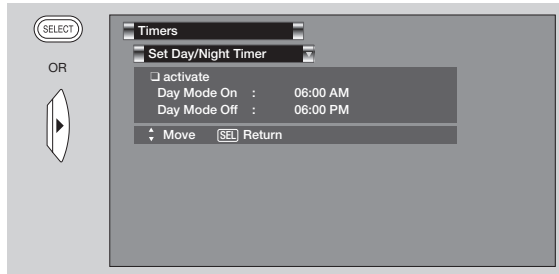
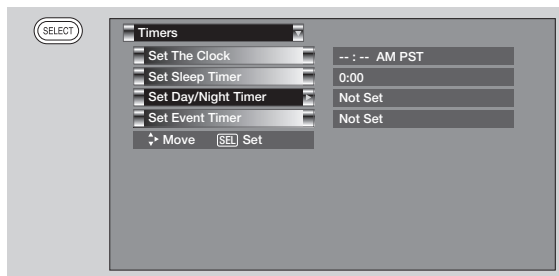

**NOTE:** When the clock is changed in the **SET THE CLOCK** function, this feature is disabled.

# Timers

## Set Event Timer

This function will automatically operate the Projection TV viewing reservation of a program. If the clock is not set, you can not use this function and the screen below will appear. The message on the screen will disappear after 3 seconds, then the screen automatically goes to the clock setup mode (see page 47).

1. Use the **CURSOR** buttons ▲ or ▼ to highlight **EVENT 1, EVENT 2, EVENT 3, EVENT 4** and then press the **SELECT** button to select. A  in the box means the selected event is enabled.
2. Use the **CURSOR** buttons ►, ▲ or ▼ to highlight and select **START TIME HOUR/MINUTE, AM OR PM**.
3. Use the **CURSOR** buttons ►, ▲ or ▼ to highlight and select **FINISH TIME HOUR/MINUTE, AM or PM**.
4. Use the **CURSOR** buttons ▲ or ▼ to set **MONTH, DAY and YEAR**.
5. Use the **CURSOR** buttons ►, ▲ or ▼ to highlight and select **CABLE or AIR**.
6. Use the **CURSOR** buttons ►, ▲ or ▼ to set the channel the TV will tune to.

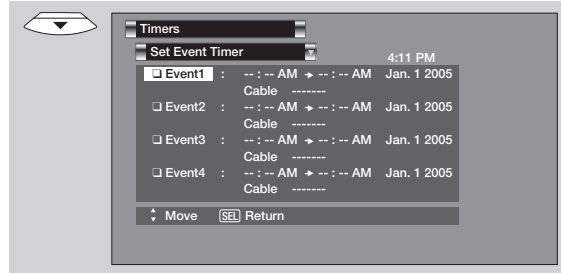
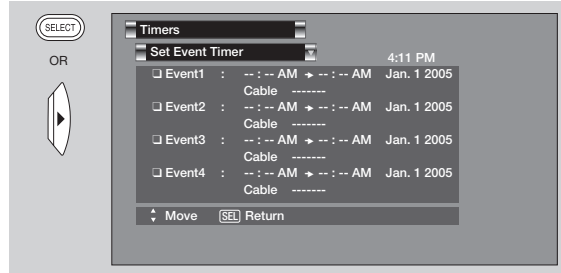
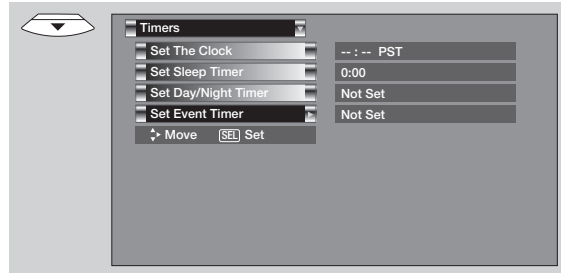

- NOTE:**
1. When the **INFO** button is pressed, the **Event Timer Icon** in the bottom right corner of the screen will display the start time.
  2. The **OFF TIMER** will only activate if the TV was turned on by the **ON TIMER** and no channel selection was made after this time. If you change the channel after the **ON TIMER** has been activated, the **OFF TIMER** will deactivate.
  3. If no remote control button is pressed after viewing reservation is activated, the TV will automatically turn off after three hours. Therefore, do not **SET EVENT TIMER** for more than three hours if you do not plan to control your television with the remote control.
  4. When a **CableCARD** is installed or removed, **EVENT SETTINGS** of the **CABLE** mode are cancelled.
  5. When the **CLOCK** is changed in the **SET THE CLOCK** function, events are disabled and the check mark is removed



**CAUTION:** Do not use your TV as a deterrent when away from home by using the **ON** and **OFF TIMERS**. For safety, the TV should be turned off when you are away from home.

## Setup

Select **SETUP** when setting your TV up for the first time.

1. Use the **CURSOR** buttons ▲ or ▼ to highlight the function to be adjusted.
2. Press the **SELECT** button or **CURSOR** button ► to select.

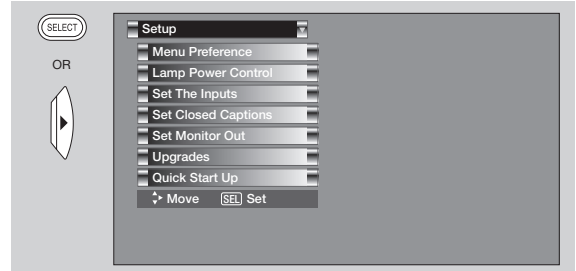

### Menu Preference

This feature will allow you to select any one of three different languages for all on-screen displays.

#### Set the Language

This function allows you to choose from three menu languages.

1. Use the **CURSOR** buttons ◀ or ▶ to highlight the language of your choice.
2. Press **EXIT** to quit menu or select **MENU PREFERENCE** to return to previous menu.

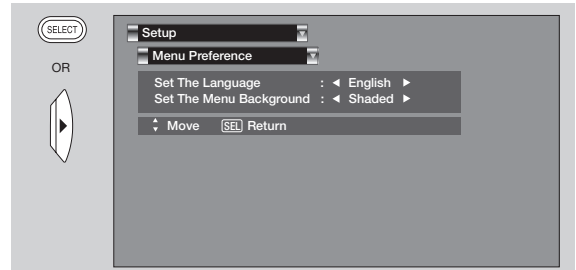
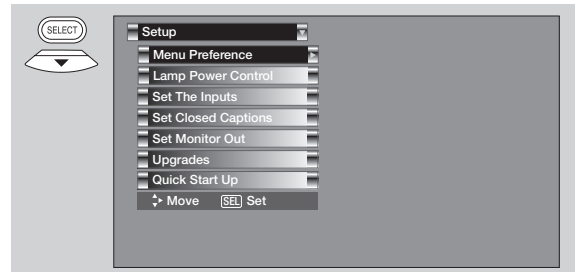

### Set the Menu Background

This function allows you to choose from two menu backgrounds.

1. Use the **CURSOR** buttons ◀ or ▶ to highlight **SET THE MENU BACKGROUND (SHADED OR SOLID)**.
2. Press **EXIT** to quit menu or **CURSOR** button ◀ to return to previous menu.
3. Select **SOLID** for a black background (no picture can be seen behind menu screen), or select **SHADED** for a light background.

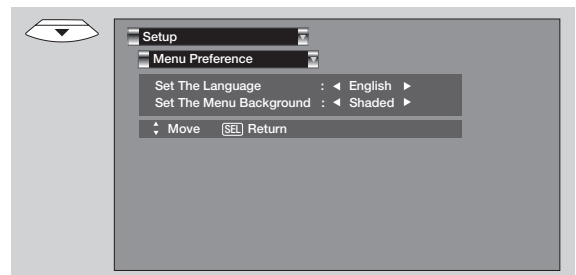

# Setup

## Lamp Power Control

Use this feature to have the TV turned OFF automatically when a video signal is not detected for 15 minutes.

1. Press the **CURSOR** buttons ◀ or ▶ to highlight Yes or No.

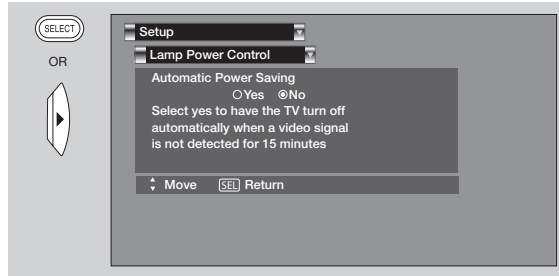
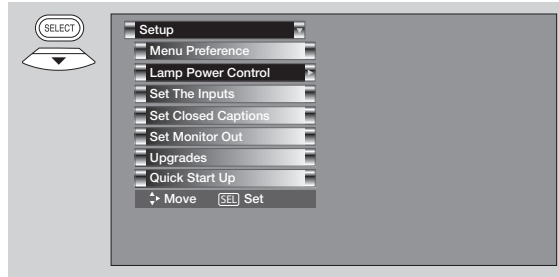

## Set The Inputs

Use this feature to give a name to any of the five video inputs. A named input is shown in the **INPUTS** menu.

1. Press the **CURSOR** buttons ◀, ▶, ▲ or ▼ to highlight the name of the video inputs.
2. Select from one of the following choices to set an input name:  
A/V Receiver, DVD, DVD2, VCR, VCR2, Cable (STB), Satellite, PVR, DVD Recorder, CAM, LB, Gray out (Skip), Hide (Skip)

**Note:** The inputs labeled Gray out (Skip) or Hide (Skip) are disabled in the **INPUTS** selection.

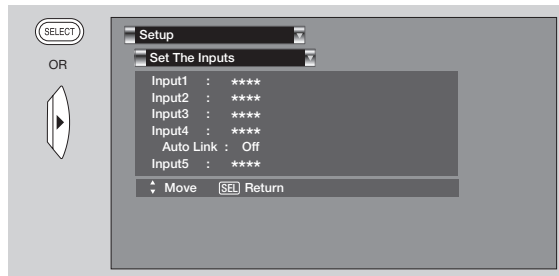
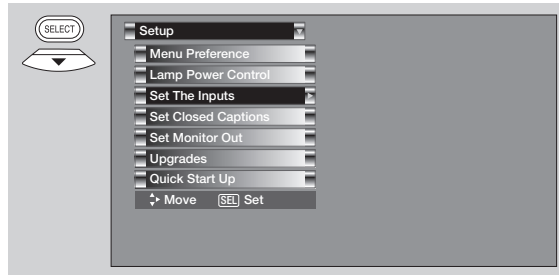

## INPUT 4 Auto Link

Use this function to automatically turn the TV on and tune to INPUT 4 when it detects a video signal to INPUT 4.

1. Use the **CURSOR** buttons ◀ or ▶ to highlight the **AUTO LINK** setting of your choice.
2. When **AUTO** is selected, the TV will turn on and tune to INPUT 4 automatically, when the Input 4 input device is turned on. This is convenient when you want to watch a movie with your VCR, laserdisc player or DVD player.
3. When **REMOTE** is selected, the TV will turn on and switch to Input 4 automatically when the INPUT 4 input device is turned on and the VCR, laserdisc, or DVD play button on your remote control is pressed. This is convenient when you want to record a movie with your VCR and watch it later.
4. Select **OFF** to disable this function.
5. Press **EXIT** to quit menu or select **AUTO LINK** to return to previous menu.

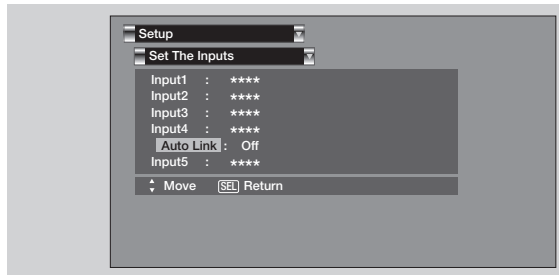

**NOTE:**

1. Once the TV has been turned on using the **AUTO LINK** feature, it must be reset before **AUTO LINK** is used again. To do this, turn your VCR, laserdisc or DVD player OFF. This feature is now reset and will turn on your TV as described above.
2. When using **REMOTE** mode, any remote control button will substitute for your video input device play button. However, intended operation is for use with your VCR, laserdisc, or DVD play button.
3. If no remote control button is pressed after the TV is turned on by **AUTO LINK**, the TV will automatically turn off after three hours.

## Set Closed Caption

Closed Captions are the dialogue, narration, and/or sound effects of a television program or home video which are displayed on the TV screen. Your local TV program guide denotes these programs as **CC** or .

1. Use the **CURSOR** buttons ◀, ▶, ▲ or ▼ to highlight and select the function to change.
2. Press **EXIT** to quit menu or **CURSOR** button ◀ to return to previous menu.

### Caption Display:

**ON/OFF** will turn the **CC** display on or off.  
**AUTO** will turn the **CC** display on when Mute/Soft Mute is on.

### Analog Captions:

Set **CAPTIONS** for Analog programs. This function will help choose and set available mode and channel.

### Caption Mode:

**CAPTIONS** is for the program you are viewing.

**TEXT** is for additional information such as news reports or a TV program guide. This information covers the entire screen and viewing the TV program is not possible. Text may not be available with every **CC** program.

### Channel:

- 1 is used for the primary language (usually English).
- 2 is sometimes used for a second language (may vary by region).
- 3 is sometimes used for a third language (may vary by region).
- 4 is sometimes used for a fourth language (may vary by region).

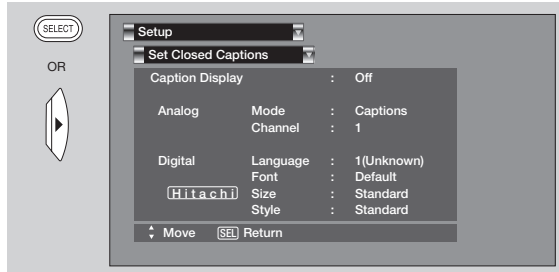
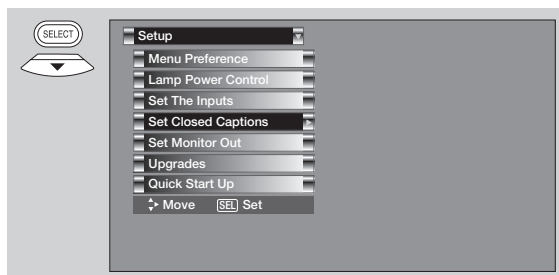

# Setup

## Digital Captions

Set captions for digital programs. This function will help choose and set available language, font, size and style of digital captions.

1. Use the **CURSOR** buttons ◀, ▶, ▲ or ▼ to highlight and select **DIGITAL CAPTIONS** feature.
2. Press **EXIT** to quit menu or **CURSOR** button ◀ to return to previous menu.

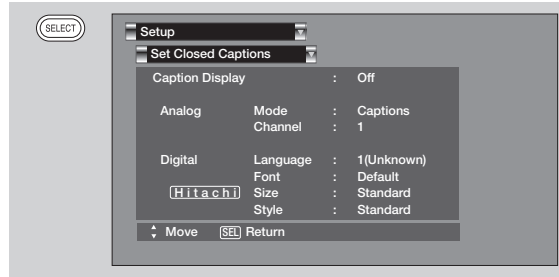

- NOTE:**
1. Some types of digital closed captions will not work with this TV.
  2. Caption Display will not work when viewing a 480p, 720p or 1080i input via the **COMPONENT: Y-PbPr** inputs.
  3. When **PIP SURF** is on, Closed Caption will not work.
  4. Digital Captions Font Style are sometimes different from the Font Style of Analog Captions.
  5. Closed Caption and Digital Captions availability and content depends on the broadcaster. Closed Caption is available when Closed Caption icon is displayed on screen.
  6. Digital Captions will not be available (grayed out) when using analog channels.

## Set Monitor Out

This feature will select the source of the Monitor Output.

### Monitor:

Select **MONITOR** to output the audio and video signals of the chosen input source (**CABLE, AIR, INPUT 1-5**) to a VCR or other A/V device.

### TV Tuner Out:

Select **TV TUNER OUT** to output the audio and video signals of the last watched Antenna Source (**CABLE, AIR**).

### Fixed

Select **AUDIO OUT FIXED** to have the Audio at fixed volume.

### Variable

Select **AUDIO OUT VARIABLE** to have Audio volume that can be controlled by the LCD Rear Projection TV Volume Up/Down.

Video Out	Audio Out	Use
Monitor	Fixed	To record currently viewed Video and Audio.
Monitor	Variable	When an external device like a monitor or Hi-Fi audio system is connected to the audio and video output of the TV. You can control the volume output by changing the volume of the TV.
TV Tuner Out	Fixed	To record currently viewed Video and Audio from either Cable or Air.

1. Use **CURSOR** button ▲ or ▼ to highlight the function to change
2. Use the **CURSOR** button ◀ or ▶ to select the function.
3. Press **EXIT** to quit menu or select **SET MONITOR OUT** to return to previous menu.

- NOTE:**
1. When **TV TUNER OUT** is selected, **VARIABLE AUDIO OUT** will not be available (grayed out).
  2. When using **MONITOR OUT** for recording, set the **VIDEO OUT** to **MONITOR**.

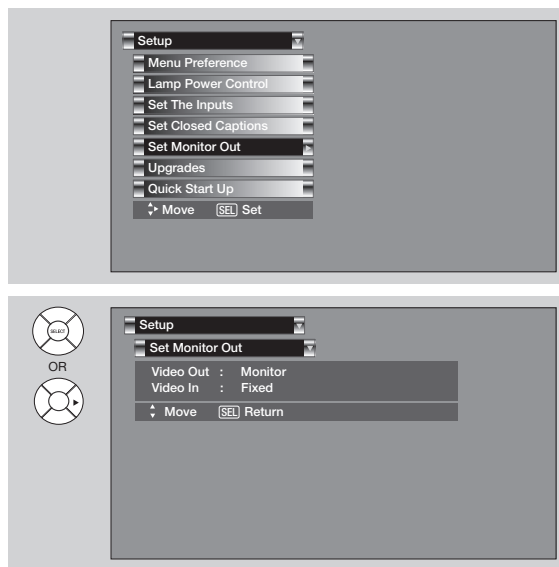

## MONITOR: Available Monitor Out Signals

Input Mode				Monitor Out			
				S-Video	Video	L/R	HiFi
ANT (Air or Cable)	Digital Channel	No Macrovision	S-Video	YES	YES	YES	YES
		Macrovision	S-Video	-	-	-	YES
	Analog Channel		Video	-	YES	YES	YES
Input 1	HDMI_1			-	-	-	YES
	S-Video_1			YES	YES	YES	YES
	Video_1			-	YES	YES	YES
Input 2	S-Video_2			YES	YES	YES	YES
	Video_2			-	YES	YES	YES
Input 3	Y-PbPr_3			-	-	-	YES
	Video_3			-	YES	YES	YES
Input4	Y-PbPr_4			-	-	-	YES
	Video_4			-	YES	YES	YES
Input5	S-Video_5			YES	YES	YES	YES
	Video_5			-	YES	YES	YES

## TV TUNER OUT: Available Monitor Out Signals

Input Mode				Monitor Out (TV Tuner Out)			
				S-Video	Video	L/R	HiFi
ANT (Air or Cable)	Digital Channel	No Macrovision	S-Video	YES	YES	YES	YES
		Macrovision	S-Video	ANT	ANT	ANT	ANT
	Analog Channel		Video	-	-	-	YES
Input 1	HDMI_1		Y-PbPr	YES	YES	YES	YES
	S-Video_1			ANT	ANT	ANT	ANT
	Video_1			digital ONLY			
Input 2	S-Video_2						
	Video_2						
Input 3	Y-PbPr_3						
	Video_3						
Input4	Y-PbPr_4						
	Video_4						
Input5	S-Video_5						
	Video_5						



# Setup

## Upgrades

It shows software information and easy upgrade procedure. This function allows the TV software to be upgraded by using a flash card (**MMC CARD**). If a future software upgrade is required for your TV, **HITACHI** will notify and provide you with a flash card. In order to receive written notification and the flash card, please complete and return the warranty card.

1. Insert **MMC CARD**
2. Press the **CURSOR** buttons ▲ or ▼ to highlight **UPGRADE NOW**.
3. Press the **SELECT** button to select and start upgrading.
4. Unplug the power cord when the upgrade is complete.

**NOTE:** Any power interruption during the upgrade process will cancel the upgrade. When this happens, repeat the upgrade procedure.

## Quick Start Up

This feature will select **QUICK START UP** options. Set this feature to **ON** to have the TV tune channels (both Analog and Digital) quickly when first turning the TV on. Set this feature to **OFF** to save electricity. Selecting **ON** for the **QUICK START UP** feature will activate the TV tuners circuits when the TV is in “standby mode” which is commonly referred to as “off”. This will allow you to quickly tune to channels when first turning the TV on. Digital signals often change and this feature will monitor any changes and prepare the television to quickly present a picture. A small amount of electricity is used to continually monitor signals when this feature is selected.

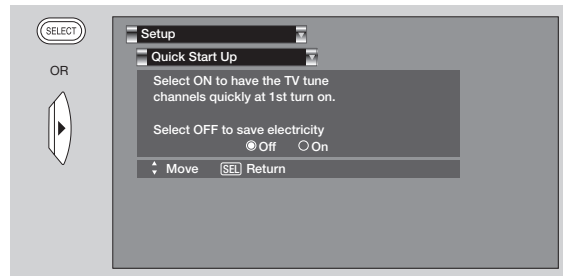
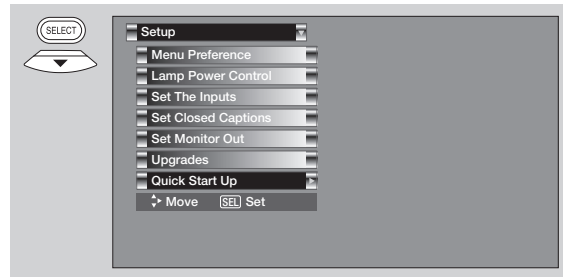
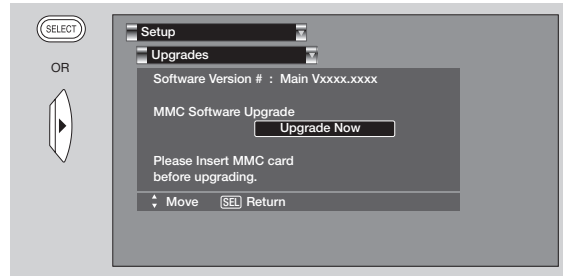
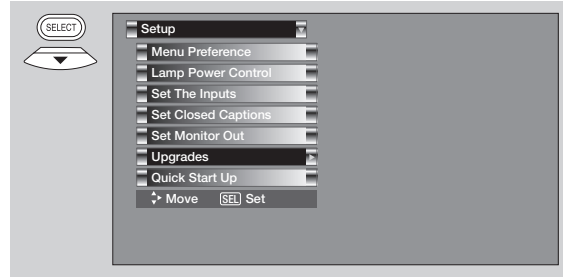

# Lamp Replacement

## Lamp Life

The lamp life may vary based on usage of the LCD Rear PTV. Turning on and off frequently may shorten the life of the lamp.

## Lamp Replacement

After extended use, if the TV picture turns dark, the color looks unusual or LAMP INDICATOR light turns on, then it is time to replace the lamp with a new lamp.

### WARNING:

*The lamp gets very hot! The lamp may explode if improperly handled. To avoid injury, please observe the following precautions.*

- *Do not open lamp compartment or attempt to remove lamp assembly unless the lamp assembly is being replaced.*
- *Unplug the product's power cord from the AC outlet before attempting to replace the lamp assembly.*
- *If the lamp is in use when failure occurs or if the lamp has exploded, wait at least 30-45 minutes for the lamp to cool before opening the lamp compartment or touching the lamp assembly or any broken pieces.*
- *Broken lamp pieces can cause injury. Handle with gloves to avoid cuts.*
- *Do not place any foreign objects inside the lamp compartment.*
- *When installing a new lamp, follow handling instruction included with the new lamp. Do not touch glass surface of new lamp.*
- *This product contains lead and a lamp that contains mercury. Dispose of this product and its lamp in accordance with applicable environmental laws. For lamp recycling and disposal information, go to [www.lamprecycle.org](http://www.lamprecycle.org). For product recycling and disposal information, contact your local government agency or [eRecycle.org](http://eRecycle.org) (in California), the Electronic Industries Alliance at [www.eiae.org](http://www.eiae.org) (in the US) or the Electronic Product Stewardship Canada at [www.epsc.ca](http://www.epsc.ca) (in Canada). For more information, call "1-800-HITACHI."*

### CAUTION!

*A "LAMP" indicator will light when lamp becomes hot. Unplug product's power cord from the AC outlet and allow lamp to cool for at least 30-45 minutes. If "LAMP" indicator is still lit, please contact your authorized service center (see page 63).*

### NOTES:

- *Contact your Hitachi dealer for a new lamp unit. Using other lamps may cause damage to the TV Set.*

<u>MODEL#</u>	<u>LAMP TYPE</u>	<u>PART#</u>
50V720	LM520	UX21517

- *When replacing the lamp, let it cool down completely, for approximately 30 to 45 minutes after the power has been switched off and A.C. cord has been unplugged.*
- *Do not touch the glass of the new lamp or make it dirty which can shorten the life of the lamp and reduce the picture quality.*
- *Keep the lamp out of the reach of children and away from flammable materials.*
- *Do not pour water onto the removed lamp or put any object inside the lamp.*
- *Once the lamp is removed, do not put flammable materials and metal objects inside the lamp receptacle on the TV set. Do not touch the receptacle.*
- *Install the new lamp securely, otherwise the picture may become dark or it may cause severe overheating.*
- *Install the lamp cover correctly, otherwise power will not come on.*

# Lamp Replacement

## Lamp Replacement

1. Turn off the main power switch and unplug the power cord. Wait at least 30 minutes to allow the lamp to cool down before replacing it.



**CAUTION:** The lamp is very hot and may cause fire or severe burns. Wait at least 30~45 minutes to allow the lamp to cool before proceeding with lamp removal.

2. Remove the front cover from the TV set. This is held by snap on. Pull the cover outwards until the quick snap on disengages.

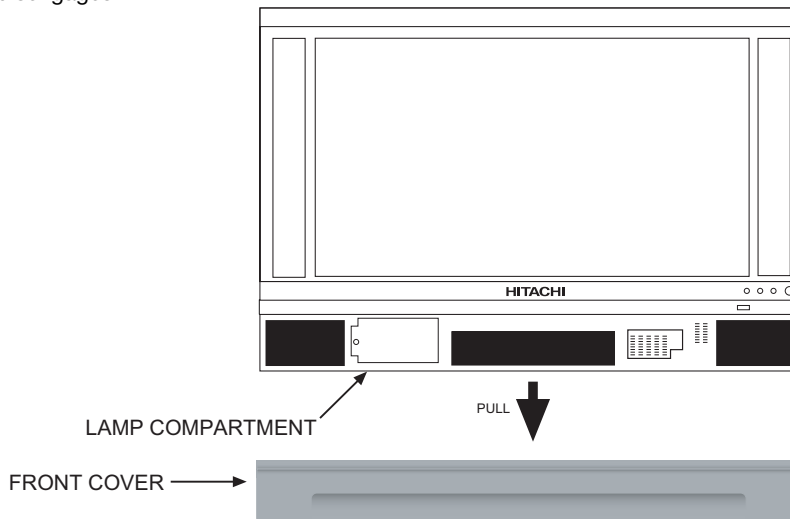

**NOTE:** This product contains lead and a lamp that contains mercury. Dispose of this product and its lamp in accordance with applicable environmental laws. For lamp recycling and disposal information, go to [www.lamprecycle.org](http://www.lamprecycle.org). For product recycling and disposal information, contact your local government agency or the Electronic Industries Alliance at [www.eiae.org](http://www.eiae.org) (in the US) or the Electronic Product Stewardship Canada at [www.epsc.ca](http://www.epsc.ca) (in Canada). For more information, call "1-800-HITACHI."

# Lamp Replacement

3. Remove the screw securing the lamp cover with a Phillips head screw driver as shown. Remove the lamp cover.

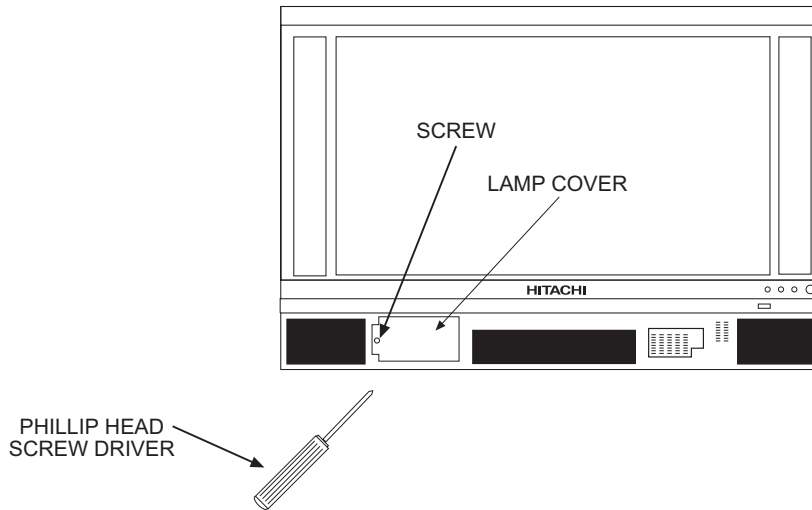

**CAUTION:** The lamp is very hot and may cause fire or severe burns. Wait at least 30–45 minutes to allow the lamp to cool before proceeding with lamp removal.

4. Remove the two screws that hold the lamp in place. Remove the lamp unit by holding the lamp handle, then pulling outwards. Exercise caution when removing the lamp unit to avoid injury to your fingers.

**NOTE:** Do not put your hand in the Lamp Storage area after the Lamp Unit is removed, your may get burned.

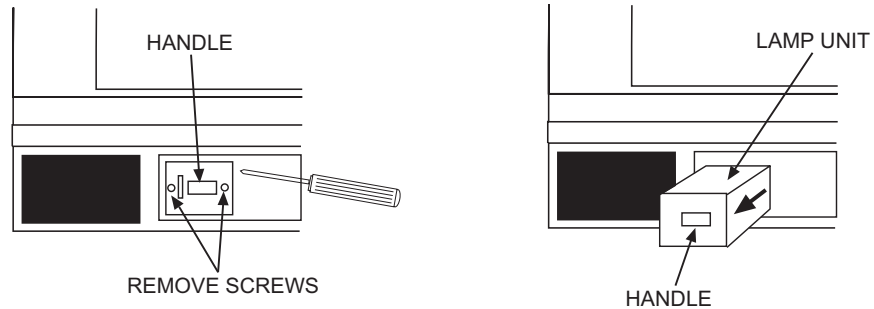

5. Replace with the new lamp.  
Place the removed lamp into the empty box of the replacement lamp. Do not touch the front glass of the new lamp or its receptacle. This may shorten the life of the lamp and reduce the picture quality.
  - Push the lamp unit back to its original position.
  - Tighten the screws firmly on the lamp unit. If they are loose, the TV may not operate correctly.

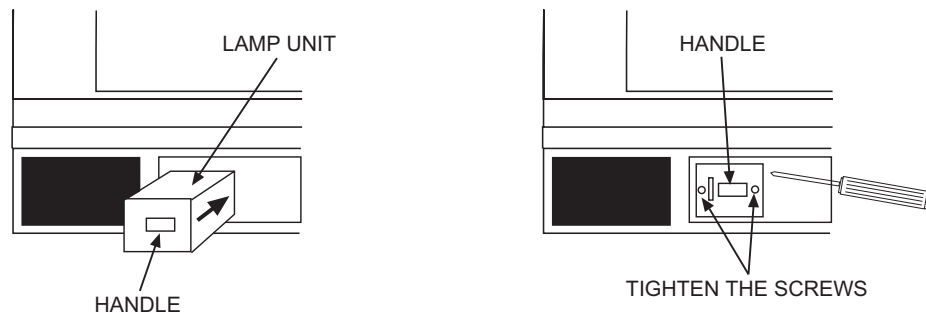

## Lamp Replacement

- Without installing the lamp cover, the power will be off and the Lamp Indicator will flash (see page 9). Be sure to install the lamp cover by re-engaging the two clips and tighten the screws before turning the power on, otherwise it may cause unusual colors.

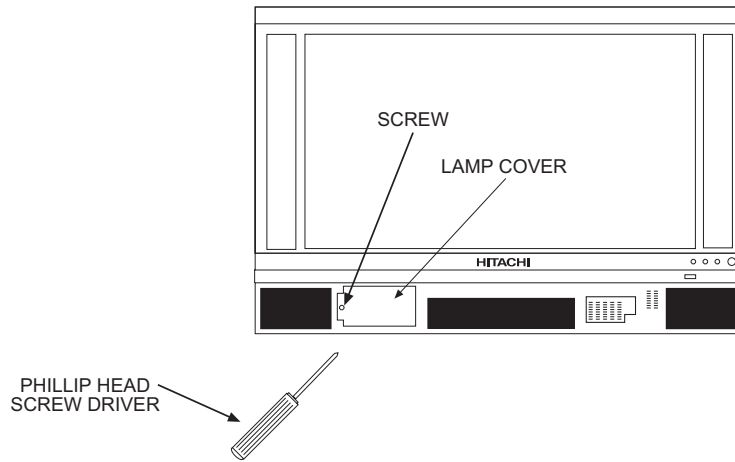

**NOTE:** If power is connected before the Lamp Cover is installed, the power will be off and the Lamp Indicator will flash (see page 9).

- Install the front cover as shown below. Put the front cover back in and align the snap on quick connect then push inwards holding the left and right side of the front cover until you hear a snap. Push the other snap on gently to make a good fit.
- Plug power cord into AC outlet and turn on the main power switch.



**NOTE:** This product contains lead and a lamp that contains mercury. Dispose of this product and its lamp in accordance with applicable environmental laws. For lamp recycling and disposal information, go to [www.lamprecycle.org](http://www.lamprecycle.org). For product recycling and disposal information, contact your local government agency or [eRecycle.org](http://eRecycle.org) (in California), the Electronic Industries Alliance at [www.eiae.org](http://www.eiae.org) (in the US) or Electronic Product Stewardship Canada at [www.epsc.ca](http://www.epsc.ca) (in Canada). For more information, call "1-800-Hitachi".

# Equipment Care and Troubleshooting

## DO

- Dust the screen and cabinet with a soft cloth.
- Clean the screen with a soft cloth moistened in warm water and dry with a soft cloth. A mild soap may be used if the screen is extremely dirty.
- Place your Television away from extreme heat, humidity, and extremely dusty places.
- Remove the plug from the wall outlet if your Television will not be used for a long period of time, for instances, when you go on vacation.

## DO NOT

- Do not clean your screen or cabinet with strong cleaners, polishes or a chemically treated cloth.
- Do not place rubber or vinyl products or cellophane tape on your Television.
- Do not touch the screen too often.
- Do not subject the remote control to shocks such as dropping it on the floor, etc. Physical damage to the precision parts may result.
- Avoid placing the remote control in a high humidity place or getting it wet. Do not leave it on or near a heater. Excessive heat or moisture may cause the unit to cease operation.
- When the batteries run down, remote control operation will become erratic or possibly stop altogether. Replace the old batteries with two new "AA" size batteries as soon as possible to preserve the remote control precodes that were set for the devices. Pressing a remote control button with a "DEAD" battery might erase all precodes in memory. Do not use an old battery with a new battery.
- Exposure of the viewing screen to prolonged direct sunlight or heat may cause the screen to permanently warp, resulting in a distorted picture..

## TROUBLESHOOTING

HITACHI LCD Rear Projection Television incorporates advanced power surge protection technology designed to protect against component or circuit damage due to external or internal voltage power surges.

### IF YOUR TELEVISION SHOULD APPEAR TO HAVE A LOSS OF POWER, PLEASE FOLLOW THIS PROCEDURE:

1. Press the **POWER SWITCH (ON/OFF SWITCH)** once.
2. If there is still no power, wait 30 seconds and press the **POWER SWITCH** again.
3. If there is still no power, unplug the power cord from the wall. Wait 30 seconds and plug the power cord back in. Press the **POWER SWITCH** again.

This protective technology should provide for years of lasting entertainment from your **HITACHI** LCD Rear Projection Television.

SYMPTOMS	CHECK THESE ITEMS AND TRY THESE ADJUSTMENTS										
	Be sure external connection is correct	Be sure power cord is plugged in	Be sure TV is switched "ON"	Try another channel (station trouble)	Check antenna connections (back of TV)	Check antenna for broken lead-in wire	Adjust Contrast control	Adjust Brightness control	Adjust Color control	Adjust Tint control	Adjust Volume control
No Picture, no sound	●	●	●	●	●	●					
Sound OK, picture poor	●			●	●	●	●	●			
Picture OK, sound poor	●			●	●	●	●				●
Picture blurred	●			●	●	●	●				
Lines or streaks in picture				●	●	●	●				
Poor reception on some channels				●	●	●	●				
Picture rolls vertically				●			●				
No color	●			●	●	●	●			●	
Poor color	●			●	●	●	●			●	●

## Reception Problems

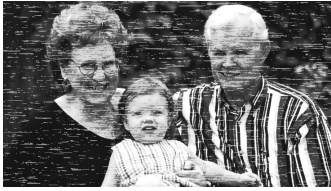

### **IGNITION NOISE:**

Black spots or horizontal streaks may appear, picture may flutter or drift. Usually caused by interference from automobile ignition systems, neon lamps, electrical drills, and other electrical appliances.



### **GHOSTS:**

Ghosts are caused by the television signal following two paths. One is the direct path and the other is reflected from tall buildings, hills or some other objects. Changing the direction or position of the antenna may improve reception. Ghosting may also be caused by defects in the antenna system such as unshielded leads or connecting several sets to the same antenna without using multiple antenna couplers.



### **SNOW:**

If your receiver is located in the fringe area of a television station where the signal is weak, your picture may be marred by the appearance of small dots. When the signal is extremely weak, it may be necessary to install a special antenna to improve the picture.

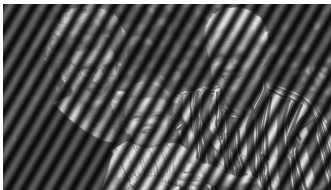

### **RADIO FREQUENCY INTERFERENCE:**

The interference produces moving ripples or diagonal streaks, and in some cases, causes loss of contrast in the picture.



### **BLOCK NOISE (DIGITAL INPUT):**

Fuzzy blocks may appear in some area or the whole area of the screen. This is usually caused by interference from automobile ignition systems, neon lamps, electrical drills, ghosting of the image and weak signals.

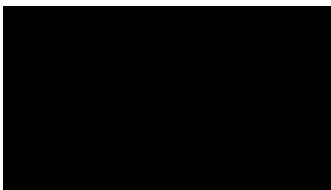

### **BLACK SCREEN:**

When using an antenna, weak signals will display a black screen. It may be necessary to upgrade your antenna.

**NOTE:** The TV set can generate sound distortion in external devices such as a radio. Please separate radio equipment from the TV set to a considerable distance.



# Features and Specifications

## FEATURES:

- Superfine Picture Quality; 1280 Line Horizontal Resolution
- Remote (Controls many PVR/VCR brands, cable boxes, satellite boxes, and other audio equipment).
- New Easy-to-Use (3-Language) On-Screen Menu
- Full Set of Input Jacks, including S-Video
- COMPONENT VIDEO: Y-P<sub>B</sub>/P<sub>R</sub>
- Six Aspect Modes
- Closed Caption Decoder
- 2-Tuner Picture in Picture
- 2 Antenna Inputs (Either for Analog/Digital)
- Video Input Sensor
- HDMI (High Definition Multimedia Interface) (High Bandwidth Digital Content Protection V1.1 compatible).
- Digital Audio Output (Dolby® Digital and PCM)
- 3 Dimensional Y/C Comb Filter
- Compatible with 1080i, 720p, 480p and 480i input signals.
- CableCARD™ compatible - Contact your local cable operator for more information.
- **BBE** Technology.  
*Licensed by BBE Sound, Inc. under USP5510752 and 5736897. BBE and BBE symbol are registered trademarks of BBE Sound, Inc. Manufactured under license from BBE Sound, Inc.*
- **SRS** Technology.  
*SRS and SRS symbol are trademarks of SRS Labs, Inc. SRS technology is incorporated under license from SRS Labs, Inc.*
- **DOLBY DIGITAL** Technology.  
*Manufactured under license from Dolby Laboratories. Dolby and the double-D symbol are trademarks of Dolby Laboratories.*
- **HDMI** Technology  
*HDMI, the HDMI logo and High-Definition Multimedia Interface are trademarks or registered trademarks of HDMI Licensing LLC.*

## INPUTS:

- Power Input.....AC 120V, 60Hz
- Stand-by Power.....Less than 1 Watt
- Power Consumption - Refer to rear panel at the back of the T.V.
- Antenna input impedance .....75 Ohm
- Channel coverage  
VHF-Band .....2 – 13  
UHF-Band.....14 – 69  
CATV Band .....1 – 135, A – I
- Video .....1.0Vp-p, 75 Ohm
- S-Video  
Luminance (Y) .....1.0Vp-p, 75 Ohm  
Chrominance (C) .....0.286Vp-p, 75 Ohm
- Component Video  
Luminance (Y) .....1.0Vp-p, 75 Ohm  
Chrominance (P<sub>B</sub>/P<sub>R</sub>) .....0.7Vp-p, 75 Ohm
- Audio input Impedance.....47k Ohm
- Average input level .....470mVrms
- HDMI.....HDMI 19 PIN

## OUTPUTS:

- Video .....1.0Vp-p, 75 Ohm
- Audio (Fixed) .....470mVrms, 1k Ohm
- S-Video  
Luminance (Y) .....1.0Vp-p, 75 Ohm  
Chrominance (C) .....0.286Vp-p, 75 Ohm
- Optical Out (Digital Audio) .....1 optical connector

## DIMENSIONS:

	50V720
Height (in.)	35 1/2
(mm)	901.0
Width (in.)	54 5/8
(mm)	1,387.0
Depth (in.)	16 3/8
(mm)	415.0
Weight (lbs.)	90
(kg.)	40.8

**NOTE:** Due to improvements, specifications in this operating guide are subject to change without notice.

# HITACHI

## Inspire the Next

### Service Hotline

To locate an authorized **HITACHI** service facility in the continental U.S.A. and Canada,

**DIAL TOLL FREE**

**7 days a week, 24 hours a day**

**1-800-HITACHI**  
(1-800-448-2244)



**HITACHI AMERICA, LTD.**  
**HOME ELECTRONICS DIVISION**

**HITACHI** has made every effort to assure you hours of trouble free operation from your unit. However, should you require service, a network of **HITACHI** Authorized Service Facilities has been established in all 50 states and Puerto Rico. Each facility will provide you with convenient and expedient assistance. Our service hotline operator will direct you to the **HITACHI** Authorized Service Facility nearest you. Just present proof of purchase and/or delivery receipts to the Hitachi Authorized Service Facility, and service will be rendered in accordance with the terms of the limited warranty as stated on your warranty card or operating guide.

Should you have any questions regarding warranty, service, operation, or technical assistance, please contact:

**Hitachi America, LTD.**  
**Home Electronics Division**  
**900 Hitachi Way**  
**Chula Vista, CA 91914-3556**

**HITACHI CANADA, LTD.**  
**DIGITAL MEDIA DIVISION**

Should you have any questions regarding warranty, service, operation, or technical assistance, please contact:

**In Canada: 1-800-HITACHI (1-800-448-2244)**

Monday – Friday (EST).....9:00am – 7:00pm  
Saturday (EST) .....9:00am – 5:00pm

Look for your French Manual on the outside of the box. If the manual is missing, call **1-800-HITACHI (1-800-448-2244)** for a copy.

Pour de plus amples renseignements sur le service durant la période couverte par la garantie, sur le fonctionnement ou pour de l'assistance technique communiquez avec:

**Au Canada: 1-800-HITACHI (1-800-448-2244)**

Lundi - Vendredi L'EST .....9:00am – 7:00pm  
Samedi L'EST.....9:00am – 5:00pm

La version français de votre manuel se trouve a l'exterieur de la boîte. Si le manuel est manquant, coposez le **1-800-HITACHI (1-800-448-2244)** pour obenir votre copie.

**HITACHI CANADA, LTD.**  
**2495 Meadowpine Blvd.**  
**Mississauga, Ontario L5N 6C3**

# End User Licence Agreement for HITACHI DTV Software

## END USER LICENSE AGREEMENT FOR HITACHI DTV SOFTWARE

**IMPORTANT – READ CAREFULLY:** This End User License Agreement for **HITACHI** DTV Software (this “Agreement”) is a legal agreement between you (“you” or “your”), in your capacity as the owner of a **HITACHI** brand digital television (the “DTV”), and **HITACHI** America, Ltd., Home Electronics Division (“**HITACHI**”). By using the DTV or the operating system software installed on the DTV (the “System Software”) or any Upgrade (as defined below, and together with the System Software, the “Software”), you agree to be bound by the terms and conditions of this Agreement. IF YOU DO NOT AGREE TO BE BOUND BY THIS LICENSE AGREEMENT, DO NOT USE THE DTV OR THE SOFTWARE.

1. **LICENSE GRANT.** **HITACHI** grants to you, for the life of the DTV, a non-exclusive, non-transferable, revocable license to install and use one copy of the Software on the DTV, subject to the following limitations and restrictions:
  - a. You may not share, duplicate, republish or redistribute the Software;
  - b. You may not resell, rent, lease, sublicense, gift, loan, assign or otherwise transfer the Software or any of your rights under this Agreement;
  - c. You may not modify, adapt, translate, reverse engineer, decompile, disassemble or make derivative works from the Software or use the Software in combination with any non-Hitachi software; and
  - d. You may not use the Software for any commercial purpose.
2. **VIOLATIONS; INDEMNITY.** You understand and agree that your use of the Software in any manner except as permitted under this Agreement could constitute a serious crime and could subject you to damages and an award to **HITACHI** of attorneys’ fees in connection with your violation of this Agreement. You further understand that you may be held legally responsible for any copyright infringement or other violation of intellectual property rights caused or facilitated by your failure to abide by the terms of this Agreement. You agree to defend, indemnify and hold **HITACHI** and its parent and affiliate companies harmless from and against any and all liability resulting from any breach by you of this Agreement.
3. **INTELLECTUAL PROPERTY.** The Software is protected by federal copyright laws, international copyright treaties and other intellectual property laws and treaties. The Software is licensed, not sold, to you. All right, title and interest in and to the Software and any intellectual property associated therewith, including any accompanying printed materials, shall belong to **HITACHI** and its licensors and suppliers. Except as expressly provided herein, neither **HITACHI** nor any of its licensors or suppliers grants to you under this Agreement any express or implied right in or to any patents, copyrights, trademarks, trade secrets or other intellectual property. All right, title and interest in and to the intellectual property rights associated with any content that is accessible through use of the Software shall belong to the applicable content owners and may be protected by copyright or other intellectual property laws and treaties. This Agreement grants you no rights to use such content. Any rights of **HITACHI** not expressly granted to you hereunder are reserved expressly by Hitachi.
4. **SOFTWARE UPGRADES.** In the future, **HITACHI** may release or make available one or more upgrades to the System Software (each, an “Upgrade”). You understand and agree that if you decide to install or use any Upgrade, your installation and use of such Upgrade and/or any other software or intellectual property **HITACHI** may provide in connection therewith shall be governed by the terms and conditions of this Agreement, except to the extent that **HITACHI** provides different or supplementary license terms or conditions that accompany such Upgrade or other software or intellectual property. In the event **HITACHI** provides you with a “flash card” or other media to effect or facilitate an Upgrade, you understand and acknowledge that your failure to return such flash card or other media to **HITACHI** as **HITACHI** may require could result in **HITACHI** placing your name and your DTV’s serial number on a “No Further Upgrades” list, which will prohibit you from receiving any subsequent Upgrades **HITACHI** may later release or make available. IF YOU DO NOT AGREE WITH ALL THE TERMS AND CONDITIONS OF THIS AGREEMENT OR ALL THE TERMS AND CONDITIONS OF ANY DIFFERENT OR SUPPLEMENTARY LICENSE THAT MAY ACCOMPANY SUCH UPGRADE, (A) DO NOT USE ANY HITACHI-PROVIDED FLASH CARD OR OTHER MEDIA, (B) DO NOT PERFORM INSTALL ANY HITACHI-PROVIDED UPGRADE SOFTWARE ON YOUR DTV, AND (C) PROMPTLY RETURN SUCH FLASH CARD OR OTHER MEDIA TO HITACHI.
5. **EXPORT RESTRICTIONS.** **HITACHI** is licensing the Software for use within North America only. You agree that you will not export or re-export the Software. You specifically agree not to export or re-export the Software: (i) to any country to which the U.S. has embargoed or restricted the export of goods or services, which currently include, but are not necessarily limited to Cuba, Iran, Libya, North Korea, Sudan and Syria, or to any national of any such country, wherever located, who intends to transmit or transport the Software back to such country; (ii) to any person or entity who you know or have reason to know will utilize the Software in the design, development, or production of nuclear, chemical, or biological weapons; or (iii) to any person or entity who has been prohibited from participating in U.S. export transactions by any federal agency of the U.S. government. You warrant and represent that neither the U.S. Bureau of Industry and Security nor any other U.S federal Agency has suspended, revoked, or denied your export privileges.
6. **NO WARRANTIES.** The software is provided to you in “as is” condition and **HITACHI** makes no warranties of any kind whatsoever regarding the software and, to the maximum extent permitted by law, hereby expressly disclaims all warranties of any kind whatsoever, express or implied, with respect to the software. All implied warranties, including without limitation, the implied warranties of non-infringement, merchantability and fitness for a particular purpose are hereby expressly disclaimed by hitachi to the maximum extent permitted by law.
7. **LIMITATION OF LIABILITY.** To the maximum extent permitted by applicable law, **HITACHI**, its licensors, suppliers, parent companies, affiliates, subsidiaries, employees and agents shall not under any circumstances be liable to you or any third parties for any damages of any nature arising in any way from this agreement, your use of the software or otherwise, whether indirect, special, incidental, consequential or otherwise, including, without limitation, any claims for lost profits, lost good will, lost data, business interruption, procurement of substitute goods or services, or expenditures made or committed for in reliance on the continuation of this agreement, even if advised in advance of the possibility of such damages.
8. **NO FAILURE OF ESSENTIAL PURPOSE.** You agree that neither **HITACHI**’s breach of this agreement nor its failure to repair a defect, error or bug in the software shall constitute a failure of the essential purpose of this agreement.
9. **CRYPTOGRAPHIC SOFTWARE.** The software contains software developed by the openssl project, including cryptographic software written by eric young (the “cryptographic software”). The cryptographic software is provided by the openssl project in “as is” condition and any express or implied warranties, including but not limited to, the implied warranties of merchantability and fitness for a particular purpose are hereby expressly disclaimed to the maximum extent permitted by law. In no event shall the openssl project, its contributors, **HITACHI** or any of its parent or affiliate companies be liable for any direct, indirect, incidental, special, exemplary, or consequential damages (including, but not limited to, procurement of substitute goods or services; loss of use, data, or profits; or business interruption) however caused and on any theory of liability, whether in contract, strict liability, or tort (including negligence or otherwise) arising in any way out of the use of the software or the cryptographic software, even if advised in advance of the possibility of such damages.
10. **TERMINATION.** **HITACHI** may terminate this Agreement immediately at any time by providing notice to you.
11. **GOVERNING LAW; SEVERABILITY.** This Agreement will be governed by the laws of the State of New York, and you consent to the exclusive jurisdiction and venue in the federal courts sitting in the Southern District of New York, unless no federal subject matter jurisdiction exists, in which case you consent to the exclusive jurisdiction and venue in the Borough of Manhattan, New York, USA.

# Appendixes

## Appendix A:

IMAGE INPUT					
INPUT	TYPE	FORMAT	ASPECT	VIDEO ID	AUTO ASPECT
Air or Cable (Analog Channels)	Video	NTSC	4:3	--	On/Off
Inputs 1 & 2	HDMI	480i/480p	16:9	16:9	Off
			Letter	Letter	Off
			4:3	4:3	Off
			--	No Info.	On/Off
Inputs 1, 2, 3 & 5	S-Video <sup>1</sup> Video	NTSC	16:9	16:9	Off
			Letter	Letter	Off
			4:3	4:3	Off
			--	No Info.	On/Off
Inputs 3 & 4	Y-P <sub>b</sub> P <sub>r</sub>	480i/480p	16:9	16:9	Off
			Letter	Letter	Off
			4:3	4:3	Off
			--	No Info.	On/Off

<sup>1</sup>S-Video = Not available in Input 3

## Appendix B:

IMAGE INPUT					
INPUT	TYPE	FORMAT	ASPECT	VIDEO ID	AUTO ASPECT
Air or Cable (Digital Channels)	Y-P <sub>b</sub> P <sub>r</sub>	1080i	4:3	--	On/Off
Inputs 1 & 2	HDMI	480i/480p	Letter	Letter	On
			4:3	4:3	On
Inputs 1, 2, 3 & 5	S-Video <sup>2</sup> Video	NTSC	Letter	Letter	On
			4:3	4:3	On
Inputs 3 & 4	Y-P <sub>b</sub> P <sub>r</sub>	480i/480p	Letter	Letter	On
			4:3	4:3	On

<sup>2</sup>S-Video = Not available in Input 3

## Appendix C:

IMAGE INPUT					
INPUT	TYPE	FORMAT	ASPECT	VIDEO ID	AUTO ASPECT
Inputs 1 & 2	HDMI	480i/480p	16:9	16:9	On
Inputs 1, 2, 3 & 5	S-Video <sup>3</sup>	NTSC	16:9	16:9	On
Inputs 3 & 4	Y-P <sub>b</sub> P <sub>r</sub>	480i/480p	16:9	16:9	On

<sup>3</sup>S-Video = Not available in Input 3

## Appendix D:

IMAGE INPUT					
INPUT	TYPE	FORMAT	ASPECT	VIDEO ID	AUTO ASPECT
Air or Cable (Digital Channels)	Y-P <sub>b</sub> P <sub>r</sub>	1080i	16:9	--	On/Off
Inputs 1 & 2	HDMI	1080i/720p	16:9	--	On/Off
Inputs 3 & 4	Y-P <sub>b</sub> P <sub>r</sub>	1080i/720p	16:9	--	On/Off

<b>A</b>	Accessories .....4	<b>I</b>	Input button.....7, 23
	Antennas (Connecting) .....6	<b>L</b>	Lamp Replacement.....56-59
	Aspect Ratio .....22		Language
	Audio		Menu Language.....50
	Languages .....39		Audio Language .....39
	Dolby Digital .....39		Locks
	DRC (Dynamic Range Compression) .....39		Change Access Code.....42
	SRS.....37		Channel Lock .....42
	BBE.....37		Front Panel Lock .....42
	Audio Settings .....37		Movie Ratings.....43
	Audio Source .....38		TV Ratings .....44
	Auto Noise Cancel .....38		TV Ratings (Canadian - English).....45
			TV Ratings (Canadian - French) .....46
<b>B</b>	Balance.....37		Loudness .....38
	Bass.....37	<b>M</b>	
	Black Enhancement .....35		Menu Preference
	Brightness .....37		Language.....50
<b>C</b>			Background .....50
	CableCARD .....12		Monitor Out .....53
	Channel Manager .....40	<b>P</b>	
	Auto Channel Scan.....41		Pause (Freeze) Button.....7, 21, 26
	Channel List.....41		Perfect Volume .....38
	Signal Meter .....40		Picture Mode .....34
	Clock		Picture-in-Picture (PIP).....25-27
	Time .....47		Picture-outside-Picture (POP) .....25
	Time Zone.....47	<b>R</b>	
	Date .....47		Remote Control
	Closed Captions		Functions.....20-31
	Analog Captions .....52		Programming Codes .....28-31
	Digital Captions .....53		Installing Batteries .....4
	Color Temperature.....35	<b>S</b>	
	Color .....34		Sharpness .....34
	Contrast.....34		Speakers .....15
	Contrast Mode .....35	<b>T</b>	
<b>D</b>			Timers .....47-49
	Date .....47		Time.....47
	Daylight Saving Correction.....47		Tint.....34
<b>E</b>			Treble.....37
	Event Timer .....49	<b>U</b>	
<b>G</b>			Upgrades.....55
	Guide Button .....7, 23	<b>V</b>	
<b>H</b>			Video Settings.....34-36
	HDMI .....11, 14, 18		Volume.....7, 24



## Notes





## Notes



# HITACHI

Inspire the Next

## Free Manuals Download Website

<http://myh66.com>

<http://usermanuals.us>

<http://www.somanuals.com>

<http://www.4manuals.cc>

<http://www.manual-lib.com>

<http://www.404manual.com>

<http://www.luxmanual.com>

<http://aubethermostatmanual.com>

Golf course search by state

<http://golfingnear.com>

Email search by domain

<http://emailbydomain.com>

Auto manuals search

<http://auto.somanuals.com>

TV manuals search

<http://tv.somanuals.com>