

LCD REAR PROJECTION TELEVISION
Operating Guide for 50VX915,
60VX915, 70VX915

IMPORTANT SAFETY INSTRUCTIONS	2-3
FIRST TIME USE	4-26
THE REMOTE CONTROL	27-50
ON-SCREEN DISPLAY	51-79
LAMP REPLACEMENT	80-83
CARE OF YOUR HITACHI TV & REMOTE CONTROL	84
RECEPTION PROBLEMS	85
USEFUL INFORMATION / INDEX	86-92



IMPORTANT SAFETY INSTRUCTIONS

SAFETY POINTS YOU SHOULD KNOW ABOUT YOUR HITACHI LCD REAR PROJECTION TELEVISION

Our reputation has been built on the quality, performance, and ease of service of HITACHI televisions.

Safety is also foremost in our minds in the design of these units. To help you operate these products properly, this section illustrates safety tips which will be of benefit to you. Please read it carefully and apply the knowledge you obtain from it to the proper operation of your HITACHI television.

Please fill out your warranty card and mail it to HITACHI. This will enable HITACHI to notify you promptly in the improbable event that a safety problem should be discovered in your product model.

Follow all warnings and instructions marked on this television.

	<p>CAUTION</p> <p>RISK OF ELECTRIC SHOCK DO NOT OPEN</p>			<p>The lightning flash with arrowhead symbol, within an equilateral triangle, is intended to alert the user to the presence of uninsulated "dangerous voltage" within the product's enclosure that may be of a sufficient magnitude to constitute a risk of electric shock to persons.</p>
<p>CAUTION: TO REDUCE THE RISK OF ELECTRIC SHOCK, DO NOT REMOVE COVER (OR BACK). NO USER SERVICEABLE PARTS INSIDE. REFER SERVICING TO QUALIFIED SERVICE PERSONNEL.</p>				<p>The exclamation point within an equilateral triangle, is intended to alert the user to the presence of important operating and maintenance (servicing) instructions in the literature accompanying the appliance.</p>

WARNING:

- TO REDUCE THE RISK OF FIRE OR ELECTRIC SHOCK, DO NOT EXPOSE THIS APPARATUS TO RAIN OR MOISTURE.
- THE TELEVISION SHOULD NOT BE EXPOSED TO DRIPPING OR SPLASHING AND OBJECTS FILLED WITH LIQUIDS, SUCH AS VASES, SHOULD NOT BE PLACED ON THE TELEVISION.

NOTE:

- There are no user serviceable parts inside the television.
- Model and serial numbers are indicated on back side of the television.

CAUTION: Adjust only those controls that are covered in the instructions, as improper changes or modifications not expressly approved by HITACHI could void the user's authority to operate the television.



MODIFICATIONS: The FCC requires the user to be notified that any changes or modifications made to this device that are not expressly approved by Hitachi America, Ltd. Home Electronics Division may void the user's authority to operate the equipment.

POWER SOURCE

THIS TELEVISION IS DESIGNED TO OPERATE ON 120 VOLTS 60Hz, AC CURRENT. INSERT THE POWER CORD INTO A 120 VOLT 60Hz OUTLET.

TO PREVENT ELECTRIC SHOCK, DO NOT USE THE TELEVISION'S (POLARIZED) PLUG WITH AN EXTENSION CORD, RECEPTACLE, OR OTHER OUTLET UNLESS THE BLADES AND GROUND TERMINAL CAN BE FULLY INSERTED TO PREVENT BLADE EXPOSURE.

NEVER CONNECT THE TELEVISION TO 50Hz, DIRECT CURRENT, OR ANYTHING OTHER THAN THE SPECIFIED VOLTAGE.

NOTE: This television receiver will display television closed captioning, ( or ) , in accordance with paragraph 15.119 of the FCC rules.

 **CAUTION:** Never remove the back cover of the television as this can expose you to very high voltages and other hazards. If the television does not operate properly, unplug the television and call your authorized dealer or service center.



IMPORTANT SAFETY INSTRUCTIONS

Read before operating equipment

Follow all warnings and instructions marked on this television.

1. Read these instructions.
2. Keep these instructions.
3. Heed all warnings.
4. Follow all instructions.
5. Do not use this apparatus near water.
6. Clean only with a dry cloth.
7. Do not block any ventilation openings. Install in accordance with the manufacturer's instructions.
8. Do not install near any heat sources such as radiators, heat registers, stoves, or other apparatus (including amplifiers) that produce heat.
9. Do not defeat the safety purpose of the polarized or grounding-type plug. A polarized plug has two blades with one wider than the other. A grounding type plug has two blades and a third grounding prong. The wide blade or the third prong are provided for your safety. If the provided plug does not fit into your outlet, consult an electrician for replacement of the obsolete outlet.
10. Protect the power cord from being walked on or pinched particularly at plugs, convenience receptacles, and the point where they exit from the apparatus.
11. Only use the attachments/accessories specified by the manufacturer.

12.  Use only with the cart, stand, tripod, bracket, or table specified by the manufacturer, or sold with the apparatus. When a cart is used, use caution when moving the cart/apparatus combination to avoid injury from tip-over.

13. Unplug this apparatus during lightning storms or when unused for long periods of time.
14. Refer all servicing to qualified service personnel. Servicing is required when the apparatus has been damaged in any way, such as power-supply cord or plug is damaged, liquid has been spilled or objects have fallen into apparatus, the apparatus has been exposed to rain or moisture, does not operate normally, or has been dropped.

15. Televisions are designed to comply with the recommended safety standards for tilt and stability. Do not apply excessive pulling force to the front, or top, of the cabinet which could cause the product to overturn resulting in product damage and/or personal injury.
16. Follow instructions for wall, shelf or ceiling mounting as recommended by the manufacturer.
17. An outdoor antenna should not be located in the vicinity of overhead power lines or other electrical circuits.
18. If an outside antenna is connected to the receiver be sure the antenna system is grounded so as to provide some protection against voltage surges and built up static charges. Section 810 of the National Electric Code, ANSI/NFPA No. 70-1984, provides information with respect to proper grounding for the mast and supporting structure, grounding of the lead-in wire to an antenna discharge unit, size of grounding connectors, location of antenna-discharge unit, connection to grounding electrodes and requirements for the grounding electrode.

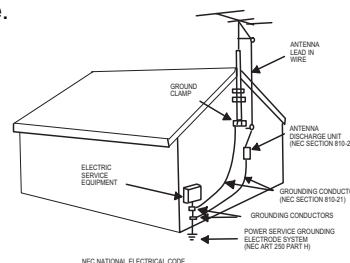

Note to the CATV system installer: This reminder is provided to call the CATV system installer's attention to Article 820-40 of the NEC that provides guidelines for proper grounding and, in particular, specifies that the cable ground shall be connected to the grounding system of the building, as close to the point of cable entry as practical.

Do not place any objects on the top of the television which may fall or cause a child to climb to retrieve the objects.



- **This product contains lead and a lamp that contains mercury. Dispose of this product and its lamp in accordance with applicable environmental laws. For lamp recycling and disposal information, go to www.lamprecycle.org. For product recycling and disposal information, contact your local government agency or the Electronic Industries Alliance at www.eiae.org (in the US) or the Electronic Product Stewardship Canada at www.epsc.ca (in Canada). For more information, call "1-800-HITACHI."**

PUBLIC VIEWING OF COPYRIGHTED MATERIAL
Public viewing of programs broadcast by TV stations and cable companies, as well as programs from other sources, may require prior authorization from the broadcaster or owner of the video program material.

- This digital television is capable of receiving analog basic, digital basic and digital premium cable television programming by direct connection to a cable system providing such programming. A CableCARD provided by your cable operator is required to view encrypted digital programming. Certain advanced and interactive digital cable services such as video-on-demand, a cable operator's enhanced program guide and data-enhanced television services may require the use of a set-top box. For more information call your local cable company.
- This product incorporates copyright protection technology that is protected by U.S. patents and other intellectual property rights. Use of this copyright protection technology must be authorized by Macrovision Corporation, and is intended for home and other limited consumer uses only unless otherwise authorized by Macrovision. Reverse engineering or disassembly is prohibited.

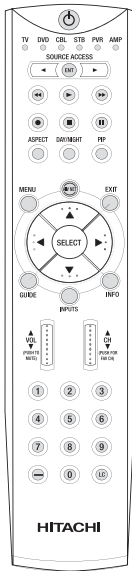
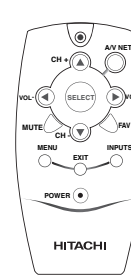
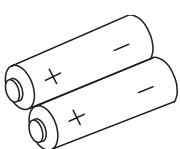

Check to make sure you have the following accessories before disposing of the packing material.

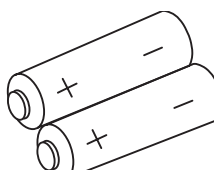
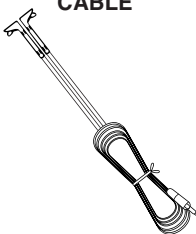
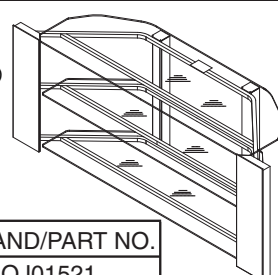
<p>REMOTE CONTROL</p>  <p>1.</p>	<p>SIMPLE REMOTE</p>  <p>2.</p>	<p>BATTERIES ("AAA")</p>  <p>4.</p>	<p>CLEANING CLOTH</p>  <p>6.</p>								
<p>BATTERIES ("AA")</p>  <p>3.</p>		<p>IR MOUSE CABLE</p>  <p>5.</p>	<p>OPTIONAL LCD REAR PTV STAND (NOT INCLUDED, ORDER SEPARATELY)</p>  <table border="1" data-bbox="933 735 1388 871"> <thead> <tr> <th>LCD TV MODEL</th> <th>LCD STAND/PART NO.</th> </tr> </thead> <tbody> <tr> <td>50VX915</td> <td>SPF50 / QJ01521</td> </tr> <tr> <td>60VX915</td> <td>SPF60 / QJ01581</td> </tr> <tr> <td>70VX915</td> <td>SPF70 / QJ01591</td> </tr> </tbody> </table> <p>CUSTOM HITACHI TELEVISION STAND Excellent for VCR and video tape storage.</p>	LCD TV MODEL	LCD STAND/PART NO.	50VX915	SPF50 / QJ01521	60VX915	SPF60 / QJ01581	70VX915	SPF70 / QJ01591
LCD TV MODEL	LCD STAND/PART NO.										
50VX915	SPF50 / QJ01521										
60VX915	SPF60 / QJ01581										
70VX915	SPF70 / QJ01591										

- CAUTION:**
1. This SPF50 LCD stand for use only with Hitachi 50VX915. Use with other apparatus is capable of resulting in instability causing possible injury.
 2. This SPF60 LCD stand for use only with Hitachi 60VX915. Use with other apparatus is capable of resulting in instability causing possible injury.
 3. This SPF70 LCD stand for use only with Hitachi 70VX915. Use with other apparatus is capable of resulting in instability causing possible injury.



1. Remote Control Unit CLU-3841WL (Part No. HL02061) or CLU-3843WL (Part No. HL02063).
2. Simple Remote Control Unit CLU-122S (P# HLO1863).
3. Two "AA" size, 1.5V batteries (P# FQ00021).
4. Two "AAA" size, 1.5V batteries (P# FR00061).
5. Two IR Mouse cables (P# EY01641).
6. Cleaning Cloth (P# MS00931).

REMOTE CONTROL BATTERY INSTALLATION AND REPLACEMENT

1. Open the battery cover of the remote control by pushing the notched part of the cover with your fingers and pulling the cover off.
2. Insert two new "AA" and "AAA" size batteries for the remote control and Simple Remote Control respectively. When replacing old batteries, push them towards the springs and lift them out.
3. Match the batteries to the (+) and (-) marks in the battery compartment.
4. Replace the cover.

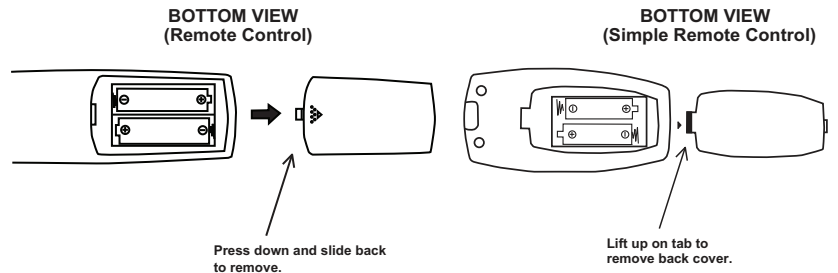

CAUTION: Danger of explosion if battery is incorrectly replaced. Replace with the same or equivalent type.



HOW TO SET UP YOUR NEW HITACHI LCD REAR PTV

FIRST TIME USE

ANTENNA

Unless your LCD Rear PTV is connected to a cable TV system or to a centralized antenna system, a good outdoor TV antenna is recommended for best performance. However, if you are located in an exceptionally good signal area that is free from interference and multiple image ghosts, an indoor antenna may be sufficient.

LOCATION

Select an area where sunlight or bright indoor illumination will not fall directly on the picture screen. Also, be sure that the location selected allows a free flow of air to and from the perforated back cover of the set.

To avoid cabinet warping, cabinet color changes, and increased chance of set failure, do not place the TV where temperatures can become excessively hot, for example, in direct sunlight or near a heating appliance, etc.

When installing your LCD Rear PTV against a wall, keep it at least 10 cm (4 inches) from the wall.

VIEWING

The major benefit of the HITACHI LCD Rear PTV is its large viewing screen. To see this large screen at its best, test various locations in the room to find the optimum spot for viewing.

The best picture is seen by sitting directly in front of the TV and about 10 to 18 feet from the screen. Picture brightness decreases as the viewer moves to the left and right of the receiver.

During daylight hours, reflections from outside light may appear on the screen. If so, drapes or screens can be used to reduce the reflection or the TV can be located in a different section of the room.

If the TV's audio output will be connected to a Hi-Fi system's external speakers, the best audio performance will be obtained by placing the speakers equidistant from each side of the receiver cabinet and as close as possible to the height of the picture screen center. For best stereo separation, place the external speakers at least four feet from the side of the TV, place the surround speakers to the side or behind the viewing area. Differences in room sizes and acoustical environments will require some experimentation with speaker placement for best performance.

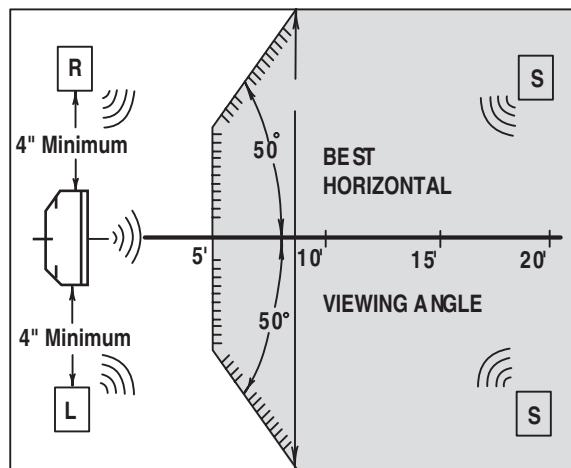
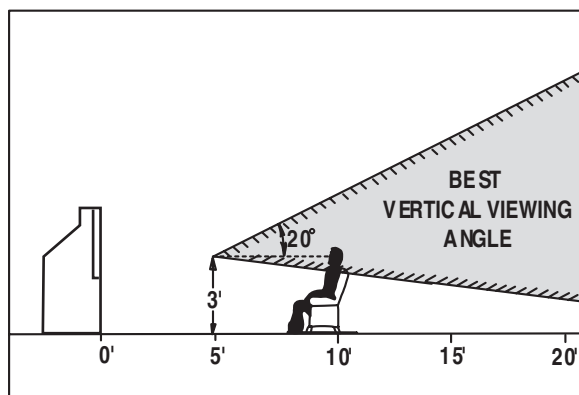

IMPORTANT NOTES:

1. Since LCD Rear PTV incorporates a high pressure lamp to display an image, it may take about one minute for the picture to become stable, after the power has been turned on. After extended use, the picture may darken, the color may look unusual, or the lamp "goes out," (burns out). You may hear a "pop" sound when the lamp "goes out." These are common characteristics of the lamp, and should not be considered defective.
2. LCD Rear PTV incorporates an advanced cooling fan system to prevent from overheating. If you hear the cooling fan, it should not be considered defective.
3. If you hear a "cracking" sound from the TV cabinet, it is due to the TV's cabinet expanding and contracting due to room temperature changes. It has no effect on the TV's functions.
4. The LCD Rear PTV cabinet is constructed with all plastic. Make sure to place it on a flat surface. An uneven surface might warp the cabinet and reduce the picture quality.



HOOK-UP CABLES AND CONNECTORS

FIRST TIME USE

Most video/audio connections between components can be made with shielded video and audio cables that have phono connectors. For best performance, video cables should use 75-Ohm coaxial shielded wire. Cables can be purchased from most stores that sell audio/video products. Below are illustrations and names of common connectors. Before purchasing any cables, be sure of the output and input connector types required by the various components and the length of each cable.

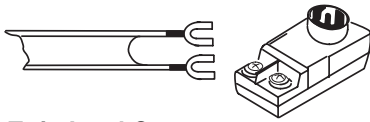

300-Ohm Twin Lead Connector

This outdoor antenna cable must be connected to an antenna adapter (300-Ohm to 75-Ohm).



"F" Type 75-Ohm Coaxial Antenna Connector

For connecting RF signals (antenna or cable TV) to the antenna jack on the television.



Phono Connector

Used on all standard video and audio cables which connect to inputs and outputs located on the television's rear jack panel and front control panel.



S-Video (Super Video) Connector

This connector is used on camcorders, VCRs and laser-disc players with an S-Video feature in place of the standard video cable to produce a high quality picture.

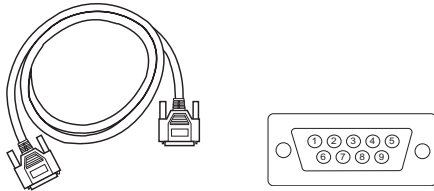

D-SUB MINI 9-Pin Cable

This cable is used to connect to the RS232C input located on the rear panel so you can control some of your TV functions from an external home control system.

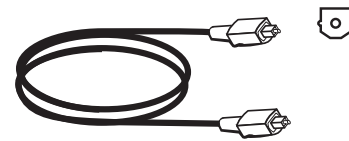

Optical Cable

This cable is used to connect to an audio amplifier with an Optical Audio In jack. Use this cable for the best sound quality.

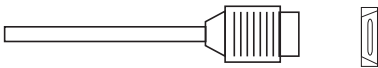

USB Cable

This cable is used to connect your digital camera to the Photo Input.

HDMI Cable

This cable is used to connect your external devices such as Set-Top-Boxes or DVD players equipped with an HDMI output connection to the TV's HDMI input.



IEEE1394 Cable

This cable is used to connect your digital television to external digital devices. This cable will carry both the video and audio information.

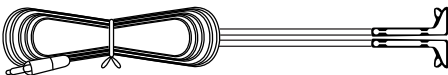

IR Mouse Cable (Provided)

Connect the IR Mouse Cable to the IR BLASTER output of your TV when using the A/V Network feature. You must place the IR mouse transmitter in front of the IR sensor of your external components. This connection allows your TV to control your external components without using your external component's remote control.



HOOK-UP CABLES AND CONNECTORS

ANTENNA CONNECTIONS TO REAR JACK PANEL

VHF (75-Ohm) antenna/CATV (Cable TV)

When using a 75-Ohm coaxial cable system, connect CATV coaxial cable to the ANT A (75-Ohm) terminal. If you have an antenna, connect the coaxial cable to the ANT B terminal.

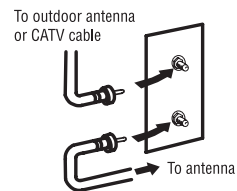

VHF (300-Ohm) antenna/UHF antenna

When using a 300-Ohm twin lead from an outdoor antenna, connect the VHF or UHF antenna leads to screws of the VHF or UHF adapter. Plug the adapter into the antenna terminal on the TV.

To outdoor VHF or UHF antenna



When both VHF and UHF antennas are connected

Attach an optional antenna cable mixer to the TV antenna terminal, and connect the cables to the antenna mixer. Consult your dealer or service store for the antenna mixer.

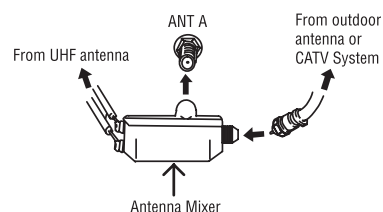

FIRST TIME USE



SIDE PANEL CONTROLS

FIRST TIME USE

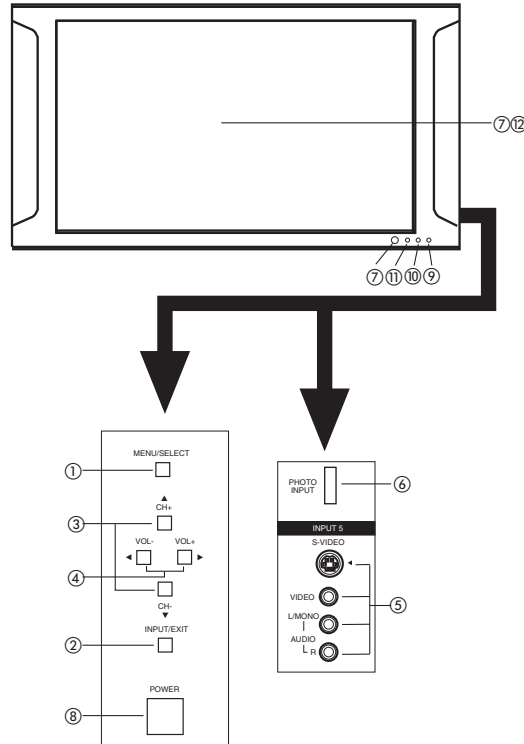

① MENU/SELECT button

This button allows you to enter the MENU, making it possible to set TV features to your preference without using the remote. This button also serves as the SELECT button when in MENU mode.

② INPUT/EXIT button

Press this button to display the input menu, Ant A/B, INPUT:1,2,3,4,5 or Photo Input. This button also serves as the EXIT button when in MENU mode.

③ CHANNEL selector

Press these buttons until the desired channel appears in the top right corner of the TV screen. These buttons also serve as the cursor down (▼) and up (▲) buttons when in MENU mode.

④ VOLUME level

Press these buttons for your desired sound level. The volume level will be displayed on the TV screen. These buttons also serve as the cursor left (◀) and right (▶) buttons when in MENU mode. When the TV power is turned OFF at a volume level 31 or greater, the volume level will default to 30 when the TV is turned ON. However, if it is set to a level 30 or less, the volume level will be at the level it was set when the TV is turned ON.

⑤ SIDE INPUT JACKS (INPUT 5)

Use these audio/video jacks for a quick hook-up from a camcorder or VCR to instantly view your favorite show or new recording. Press the INPUT/EXIT button on the front control panel until VIDEO: 5 appears in the top right corner of the TV screen. If you have mono sound, insert the audio cable into the left audio jack.

⑥ PHOTO INPUT

Insert USB cable from your Digital Camera to view your digital still pictures (see pages 10 and 33-35).

⑦ IR RECEIVER sensor

The screen area acts as the IR receiver (remote sensor). When using the remote control, point it towards the screen for best response.

⑧ POWER button

Press this button to turn the TV on or off.



SIDE PANEL CONTROLS

FIRST TIME USE

⑨ POWER light

This light is on during normal operation.

Light Blinking Slowly (2 seconds): television lamp is cooling down. It takes 12-15 seconds to warm up and about 2 minutes to cool down.

NOTES:

INDICATOR	INDICATION	MEANING		ACTION
LAMP LED	LIGHT ON	NO LAMP LIGHT or BROKEN LAMP		Need to replace if LAMP still does not light by "Power On" again. Check assembly condition of LAMP UNIT
	BLINKING	WRONG LAMP UNIT ASSEMBLY / LAMP DOOR OPEN		
TEMP LED	LIGHT ON	Too hot inside the OPTIC unit		Call for Service
	BLINKING	COOLING FAN STOPPED		
POWER LED	LIGHT ON	NORMAL OPERATION		
	SHORT BLINKING	TV CAN'T RECEIVE ANY REMOTE CONTROL BUTTONS BY POWER OFF SEQUENCE	(EXCEPT DURING 5 SEC AFTER POWER OFF)	
	LONG BLINKING	COOL DOWN		
	INTERMEDIATE BLINKING (AFTER POWER ON)	TV EXECUTING THE INITIAL DIGITAL TUNING		

2. If the LAMP, TEMP, and POWER LED are blinking in the order below, the television is warming up.

POWER → TEMP → LAMP



3. Your Hitachi LCD Rear Projection Television may appear to be OFF when it is set to input 1 ~ input 5 and the video signal is not received from the input jacks. Please make sure the Blue Power light indicator is not lit (OFF) when you are not watching for long lasting performance.

4. Your Hitachi LCD Rear Projection Television has an internal lamp that lights up the TV screen. Make sure to turn off the Power when you do not watch the LCD Rear Projection Television for longer lamp life.

⑩ TEMP indicator

This light is off during normal operation.

If this indicator is lit, the optic unit is too hot. If this indicator is blinking, the cooling fan has stopped. Please call service.

⑪ LAMP indicator - NORMAL OPERATION INDICATOR IS OFF

If light is lit, the lamp has failed. See page 80-83 for lamp replacement procedure. Consult your Hitachi dealer for proper part. If light is blinking, lamp cover is not assembled securely after replacement.

⑫ LEARNING AV NET Sensor

Point your equipment's remote control at this area while using the AV NET Learning Wizard.

IMPORTANT NOTES:

A small number of missing, discolored, or lit all the time dots or pixels is characteristic of TFT LCD technology due to the manufacturing process irrespective of manufacturer.



SIDE PANEL JACKS AND CONNECTORS

FIRST TIME USE

The side panel jacks are provided as a convenience to allow you to easily connect a camcorder or VCR as shown in the following examples:

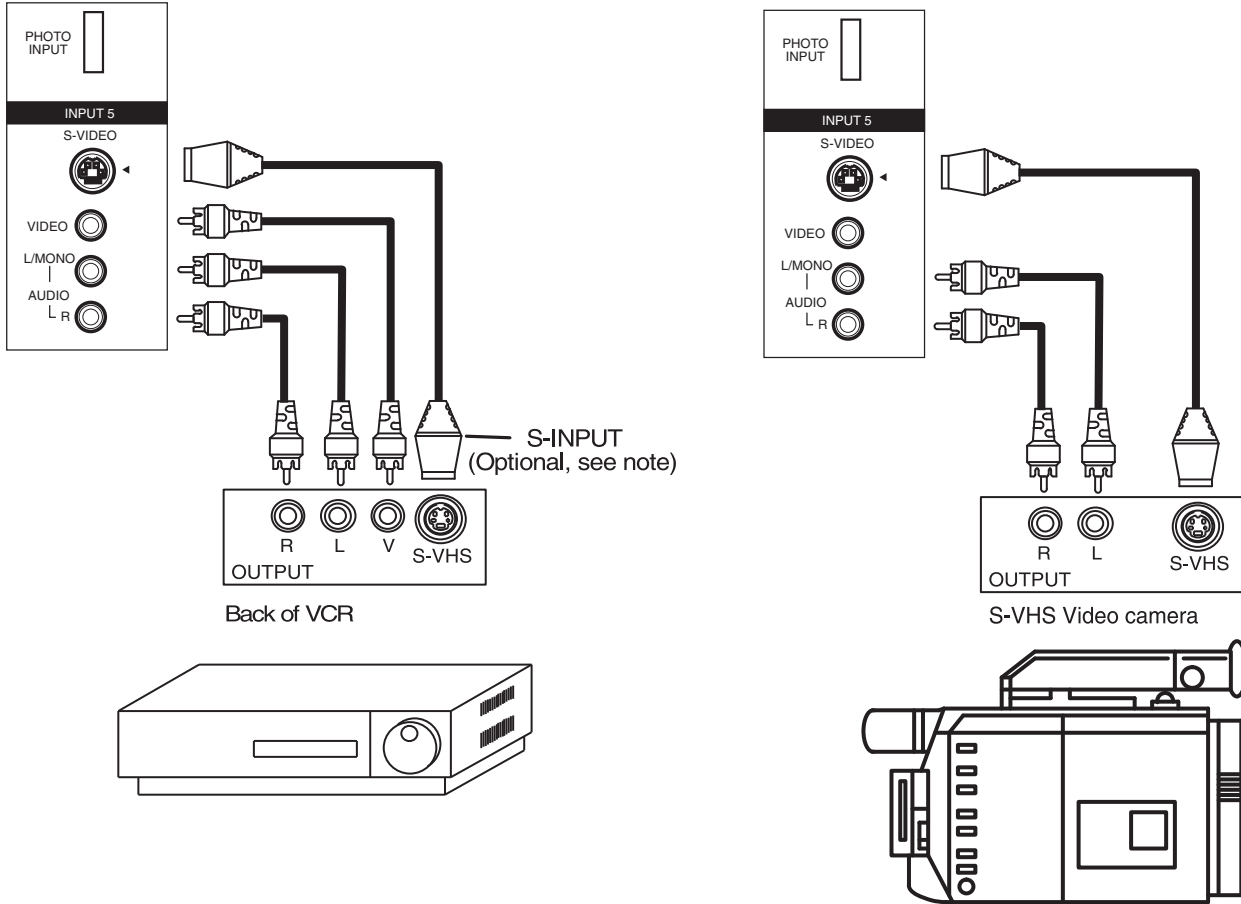

- NOTE:**
1. Completely insert connection cord plugs when connecting to front panel jacks. If you do not, the played back picture may be abnormal.
 2. If you have a S-VHS VCR, use the S-INPUT cable in place of the standard video cable.
 3. If you have a mono VCR, insert the audio cable into the left audio jack of your TV.

PHOTO INPUT

The front panel Photo Input Jack is provided to view digital still pictures from your digital camera using a USB cable and displaying them on the TV screen.

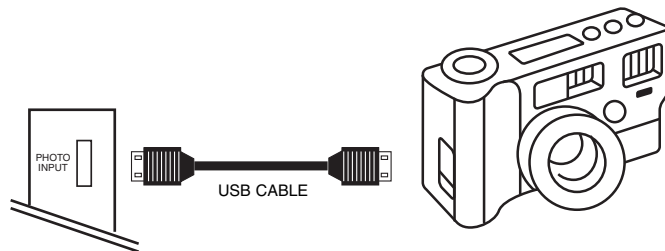

First, connect your digital camera to the Photo Input using a USB cable. Turn on the power of your digital camera. Press the INPUTS button and select Photo Input (see pages 33-35).

REAR PANEL JACKS



FIRST TIME USE

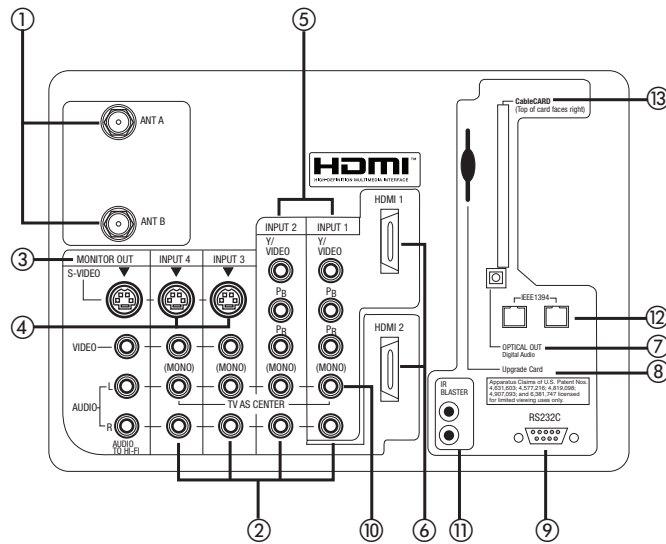

① Antenna Input

- ANT A-** A 75-Ohm RF antenna or CATV (Cable TV) input. ANT A can be displayed as a main picture or sub-picture.
ANT B- A 75-Ohm RF antenna input. ANT B can only be displayed as a main picture. ANT B cannot be displayed as a sub-picture.

NOTE: You may ask your local cable company whether DTV services are available.

② Audio/Video Inputs 1, 2, 3 and 4

By using the **INPUTS** button and **CURSOR PAD** of the remote control you can select each video source. Use the audio and video inputs to connect external devices, such as VCRs, camcorders, laserdisc players, DVD players etc. (If you have mono sound, insert the audio cable into the left audio jack.)

NOTE: You may use VIDEO or S-VIDEO inputs to connect to INPUT 3 and 4, but only one of these inputs may be used at a time.

③ MONITOR OUT

These jacks provide fixed or variable audio and video signals which are used for recording. Use the S-VIDEO Output for high quality video output (see page 78).

④ S-VIDEO Inputs 3 and 4

Inputs 3 and 4 provide S-VIDEO (Super Video) jacks for connecting equipment with S-VIDEO output capability.

⑤ Component: Y-P_BP_R Inputs

Inputs 1 and 2 provide Y-P_BP_R jacks for connecting equipment with this capability, such as a DVD player or Set Top Box. You may use composite video signal for both inputs.

- NOTES:**
- Do not connect composite VIDEO and S-VIDEO to Input 3, 4 or 5 at the same time. S-VIDEO has priority over VIDEO input.
 - Your component outputs may be labeled Y, B-Y, and R-Y. In this case, connect the components B-Y output to the TV's P_B input and the components R-Y output to the TV's P_R input.
 - Your component outputs may be labeled Y-C_BC_R. In this case, connect the component C_B output to the TV's P_B input and the component C_R output to the TV's P_R input.
 - It may be necessary to adjust TINT to obtain optimum picture quality when using the Y-P_BP_R inputs (see page 55).
 - To ensure no copyright infringement, the MONITOR OUT output will be abnormal, when using the Y-P_BP_R jacks.
 - Input 1 and Input 2 (Y/VIDEO) can be used for composite video and component video input.



⑥ HDMI1 (High Definition Multimedia Interface) (INPUT 1)

About HDMI

HDMI is the next-generation all digital interface for consumer electronics. HDMI enables the secure distribution of uncompressed high-definition video and multi-channel audio in a single cable. Because digital television (DTV) signals remain in digital format, HDMI assures that pristine high-definition images retain the highest video quality from the source all the way to your television screen.

HDMI 2 (INPUT 2)

Extra HDMI input.

Use the HDMI input for your external devices such as Set-Top-Boxes or DVD players equipped with an HDMI output connection.



HDMI, the HDMI logo and High-Definition Multimedia Interface are trademarks or registered trademarks of HDMI Licensing LLC.

- NOTES:**
1. The HDMI input is not intended for use with personal computers.
 2. Only DTV formats such as 1080i, 720p, 480i and 480p are available for HDMI input.

⑦ Optical Out (Digital Audio)

This jack provides Digital Audio Output for your audio device that is Dolby® Digital and PCM compatible, such as an audio amplifier.

NOTE: *Manufactured under license from Dolby Laboratories. “Dolby” and the double-D symbol are trademarks of Dolby Laboratories.

⑧ Upgrade Card

This card slot is for future software upgrades. Hitachi will notify you if a software upgrade is required for your TV. In order to receive written notification, please complete and return your warranty card.

⑨ RS232C Input

For use with third party home Audio/Video control systems which are commercially available. Please see your dealer regarding these “non Hitachi” home control systems (see page 78 to activate this input).

⑩ TV AS CENTER (INPUTS 1-4)

These jacks are for stereo amplifiers with center signal output capability. This feature allows the TV speakers to be used as a center speaker. The TV must be set as a center channel by selecting “TV as Center” on the Internal Speakers Settings of the Audio Menu (see page 59).

⑪ IR Blaster

This jack provides IR output to your external components (VCR, Cable box, DVD player, etc.). With this connection, your external components can automatically be controlled by the A/V network feature. This connection will allow you to control the external components with your LCD Rear PTV's remote control in TV mode.

⑫ IEEE1394

These jacks provide a digital interface for your external digital devices, such as a Digital VCR (D-VHS or Set-Top-Box) by means of a single cable (see page 22). When using IEEE1394 connections, you enable video and audio digital data exchange between a compatible device. This connection also enables you to control basic equipment functions (such as VCR play, rewind, fast forward, stop, etc.) from your TV On-Screen Display.



REAR PANEL JACKS

FIRST TIME USE

13 CableCARD Slot

This slot is for the CableCARD that will be provided by your local cable operator to gain access to chosen cable channels. The CableCARD will allow you to tune digital and high definition cable channels. Please call your local cable operator if this service is available before requesting a CableCARD (also known as Point of Deployment (POD) module).

Connect a coaxial cable to ANT A terminal of the Rear Panel Jacks.
Insert the CableCARD into the slot (Top of card should be facing right as shown).

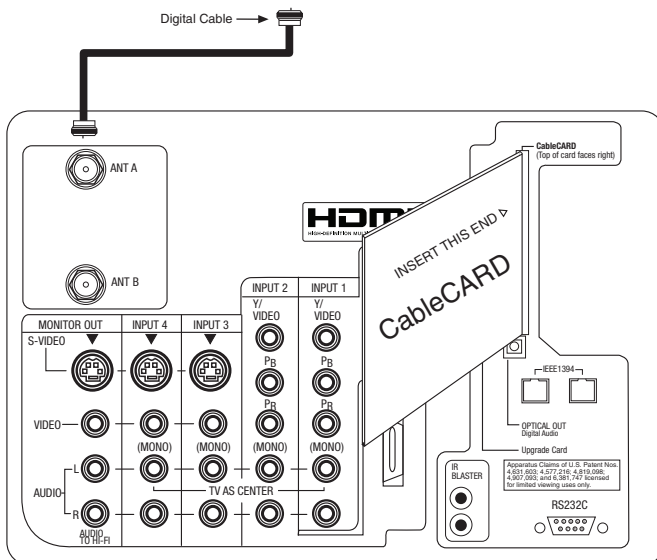

If the CableCARD is properly installed or not installed, the TV will display the following respective screens.

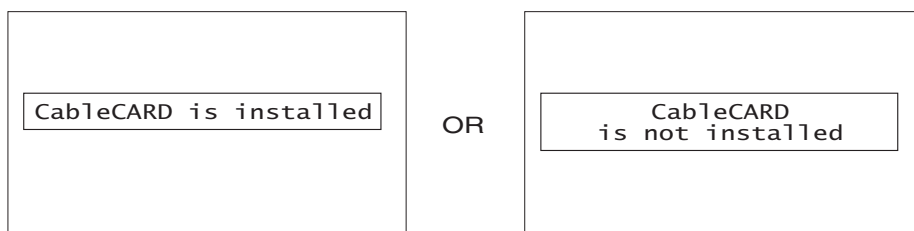

After the CableCARD is installed, wait until the second screen below appears. The third screen below will appear if a channel is not authorized for viewing. Press the EXIT button to exit the second screen.

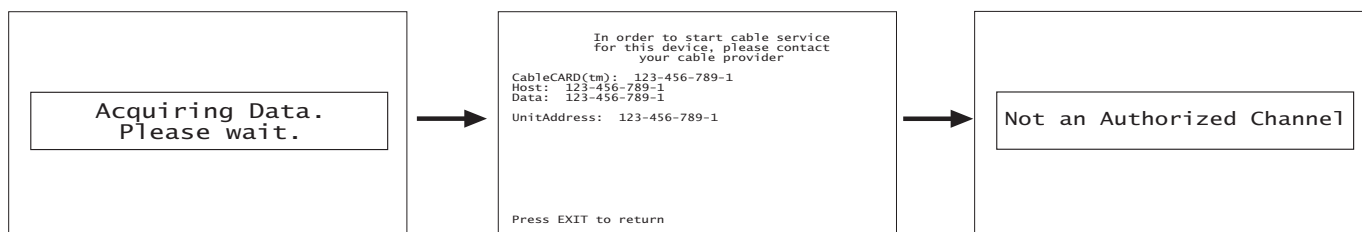

Please take note of all information on the screen (you will provide this information to your cable operator). Call your cable operator and give them the information from the card to start your cable service.

- NOTES:**
1. A digital cable subscription is required.
 2. Antenna B will not be available when CableCARD is inserted.
 3. Do not insert a PCMCIA card into the CableCARD slot.



REAR PANEL CONNECTIONS

TYPICAL FULL-FEATURE SETUP

FIRST TIME USE

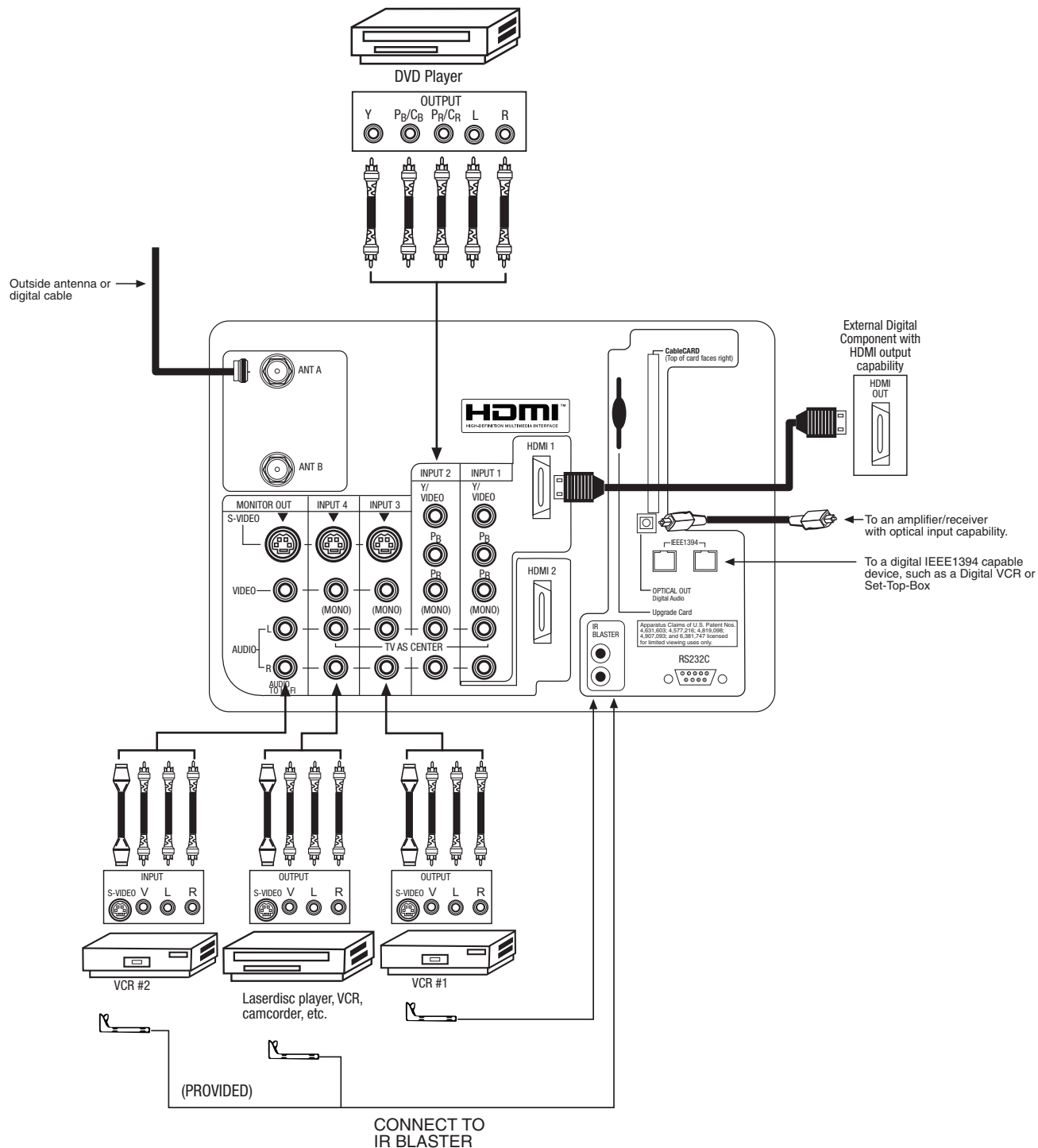

- NOTES:**
1. Connect only 1 component to each input jack.
 2. Follow connections that pertain to your personal entertainment system.
 3. Inputs 1 and 2 can accommodate Composite and Component video signals.
 4. Cables are not included with the purchase of this TV, except when noted as "provided".



TIPS ON REAR PANEL CONNECTIONS

- S-VIDEO, HDMI, IEEE1394 and component connections are provided for high performance laserdisc players, VCRs etc. that have this feature. Use these connections in place of the standard video connection if your device has this feature.
- If your device has only one audio output (mono sound), connect it to the left audio jack on the television.
- Refer to the operating guide of your other electronic equipment for additional information on connecting your hook-up cables.
- A single VCR can be used for VCR #1 and VCR #2, but note that a VCR cannot record its own video or line output (INPUT: 3 in the example on page 14). Refer to your VCR operating guide for more information on line input-output connections.
- You may use VIDEO or S-VIDEO inputs to connect to Input 3, Input 4 or Input 5, but only one of these may be used at a time.
- Connect only 1 component (VCR, DVD player, camcorder, etc.) to each input jack.
- COMPONENT: Y-P_BP_R (Input 1 & 2) connections are provided for high performance components, such as DVD players and set-top-boxes. Use these connections in place of the standard video connection if your device has this feature. Input 1 and 2 accepts both composite and component video signals.
- Your component outputs may be labeled Y, B-Y, and R-Y. In this case, connect the components B-Y output to the TV's P_B input and the components R-Y output to the TV's P_R input.
- Your component outputs may be labeled Y-C_BC_R. In this case, connect the components C_B output to the TV's P_B input and the components C_R output to the TV's P_R input.
- You may use composite video signal for Input 1~Input 5.
- It may be necessary to adjust TINT to obtain optimum picture quality when using the Y-P_BP_R inputs. (See page 55)
- To ensure no copyright infringement, the MONITOR OUT output may be abnormal, when using the Y-P_BP_R jacks.
- When using HDMI or DVI input from a Set-Top-Box, it is recommended to use a 1080i or 720p input signal.
- Input 1 or 2 can accept HDMI Signal.



CONNECTING EXTERNAL AUDIO DEVICES

FIRST TIME USE

Match the numbers below to the diagram for speaker placement.

- ① The television's internal speakers will act as center speaker (select Audio-Internal Speakers-TV as Center see page 59).
- ② These FRONT left and right speakers are connected to the FRONT output of a separate audio amplifier.
- ③ These REAR left and right speakers are connected to the REAR output of a separate audio amplifier.
- ④ This subwoofer is connected to the LFE/Sub Out output of a separate audio amplifier.

REAR PANEL OF TELEVISION

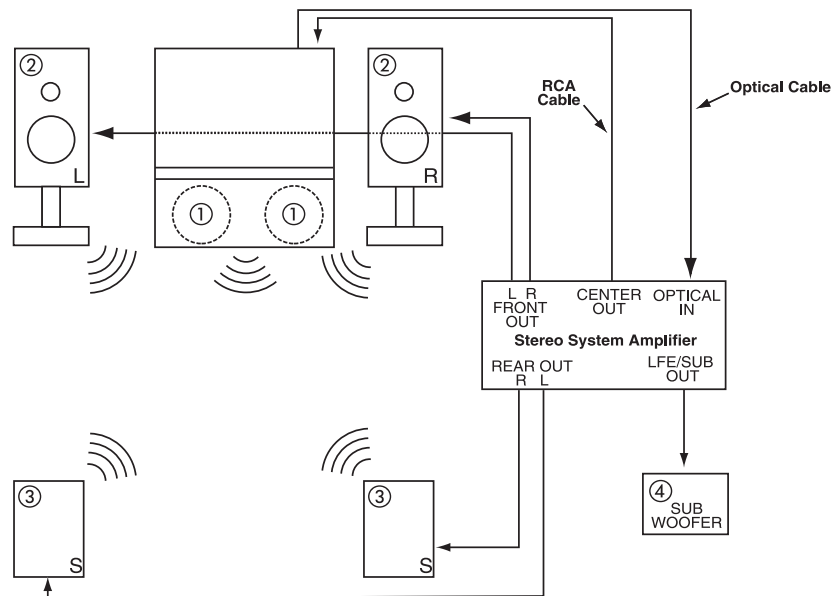
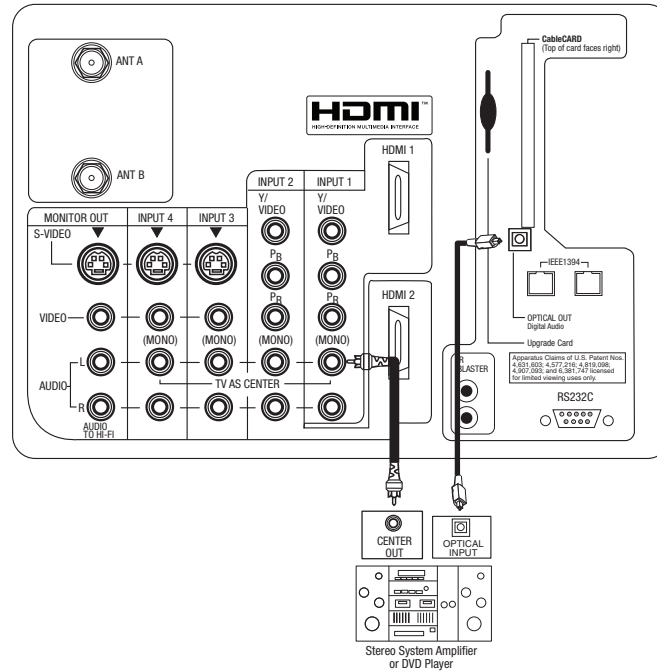

- NOTES:**
1. The Optical Out (Digital Audio) provides a fixed digital audio output to your external component such as an A/V receiver with optical input capability. The audio level can only be controlled through the volume control of the external audio amplifier.
 2. See page 60 for AUDIO-Digital Output.



CONNECTING EXTERNAL VIDEO DEVICES

The exact arrangement you use to connect the VCR, camcorder, laserdisc player, DVD player, or HDTV Set Top Box to your TV set is dependent on the model and features of each component. Check the owner's manual of each component for the location of video and audio inputs and outputs.

The following connection diagrams are offered as suggestions. However, you may need to modify them to accommodate your particular assortment of components and features. For best performance, video and audio cables should be made from coaxial shielded wire.

Before Operating External Video Source

Connect an external source to the INPUT terminal, then press the INPUTS button to show the INPUTS menu. Use the CURSOR PAD to select the Antenna and Input of your choice. Then press the SELECT button to confirm your choice (see page 33).

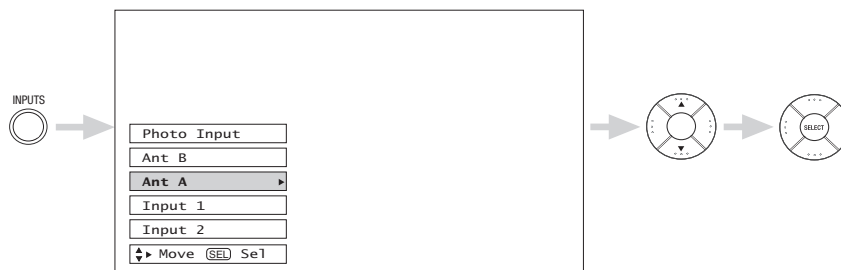

NOTE: When the TV is set to VIDEO and a video signal is not received from the VIDEO INPUT JACK on the back panel of the TV (i.e., VCR/laserdisc player, etc. is not connected or the video device is OFF), the set will appear to be OFF.

CONNECTING A MONAURAL AUDIO SOURCE TO INPUT1-INPUT5

1. Connect the cable from the VIDEO OUT of the VCR or the laserdisc player to the INPUT (VIDEO) jack, as shown on the TV set below.
2. Connect the cable from the AUDIO OUT of the VCR or the laserdisc player to the INPUT (MONO)/L(AUDIO) jack.
3. Press the INPUTS button, then select INPUT 1 from the INPUTS menu to view the program from the VCR or the laserdisc player. The VIDEO OSD label disappears automatically after approximately four seconds.
4. Select Antenna from the INPUTS menu to return to the previous channel.

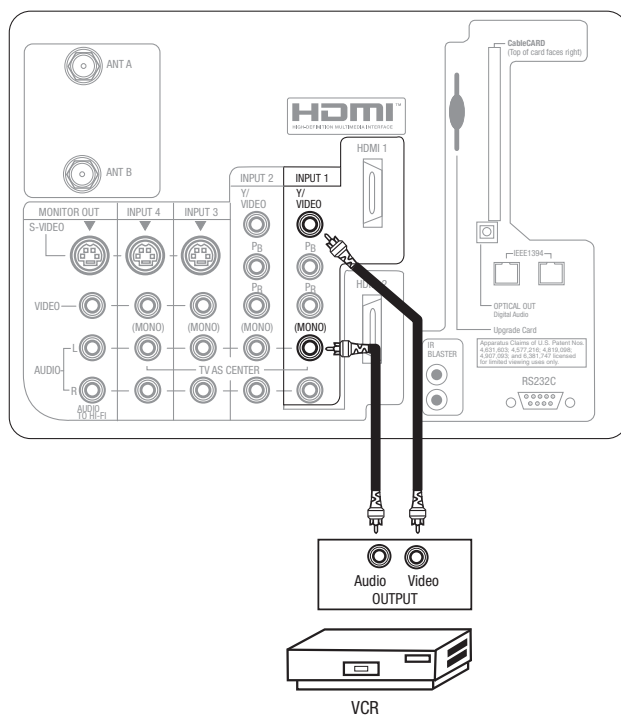



CONNECTING EXTERNAL VIDEO DEVICES

FIRST TIME USE

CONNECTING A STEREO SOURCE TO INPUT1-INPUT5

1. Connect the cable from the VIDEO OUT of the VCR or the laserdisc player to the INPUT (VIDEO) jack, as shown on the TV set below.
2. Connect the cable from the AUDIO OUT R of the VCR or the laserdisc player to the INPUT (AUDIO/R) jack.
3. Connect the cable from the AUDIO OUT L of the VCR or the laserdisc player to the INPUT (AUDIO/L) jack.
4. Press the INPUTS button, then select INPUT 3 from the INPUTS menu to view the program from the VCR or laserdisc player. The VIDEO OSD label disappears automatically after approximately four seconds.
5. Select Antenna from the INPUTS menu to return to the previous channel.

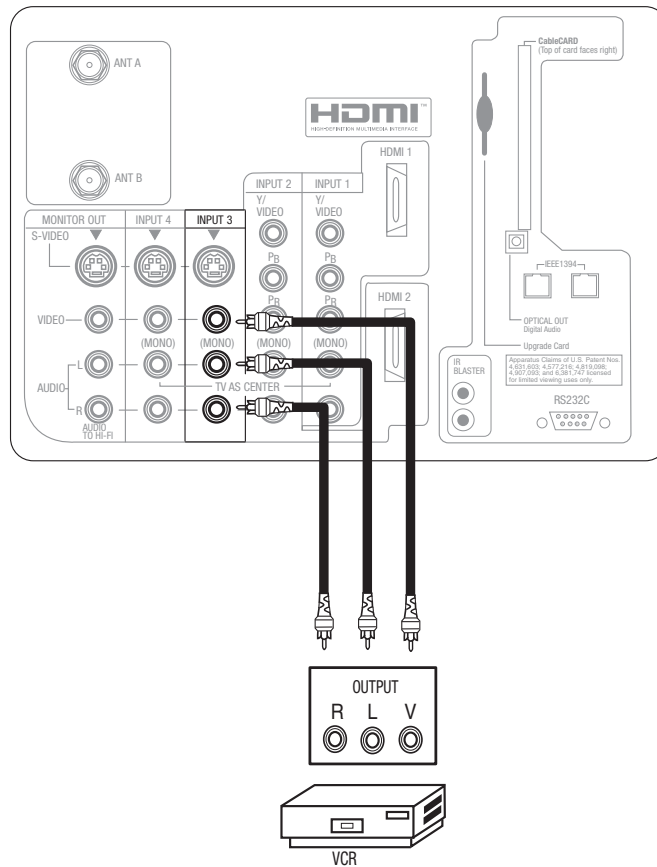

NOTES:

1. Completely insert the connection cord plugs when connecting to rear panel jacks. The picture and sound that is played back will be abnormal if the connection is loose.
2. A single VCR can be used for VCR #1 and VCR #2 (see page 14), but note that a VCR cannot record its own video or line output. Refer to your VCR operating guide for more information on line input-output connections.



CONNECTING EXTERNAL VIDEO DEVICES

FIRST TIME USE

CONNECTING AN S-VIDEO SOURCE TO INPUT 3, 4 AND 5

1. Connect the cable from the S-VIDEO OUT of the VCR or the laserdisc player to the INPUT (S-VIDEO) jack, as shown on the TV set below.
2. Connect the cable from the AUDIO OUT R of the VCR or the laserdisc player to the INPUT (AUDIO/R) jack.
3. Connect the cable from the AUDIO OUT L of the VCR or the laserdisc player to the INPUT (AUDIO/L) jack.
4. Press the INPUTS button, then select INPUT 3 from the INPUTS menu to view the program from the VCR or laserdisc player. The VIDEO OSD label disappears automatically after approximately four seconds.
5. Select Antenna from the INPUTS menu to return to the previous channel.

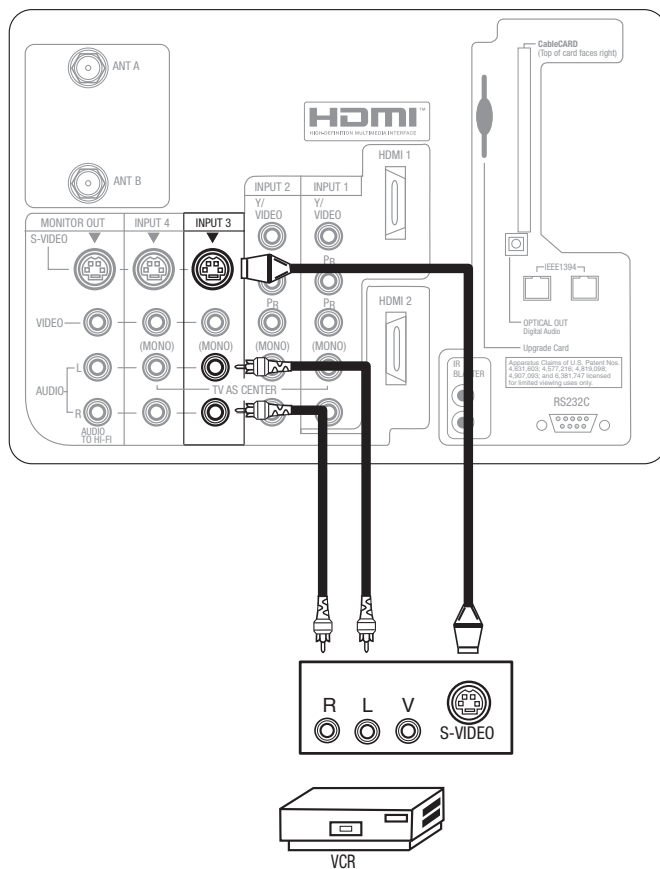

NOTES:

1. Completely insert the connection cord plugs when connecting to rear panel jacks. The picture and sound that is played back will be abnormal if the connection is loose.
2. A single VCR can be used for VCR #1 and VCR #2 (see page 14), but note that a VCR cannot record its own video or line output. Refer to your VCR operating guide for more information on line input-output connections.



CONNECTING EXTERNAL VIDEO DEVICES

FIRST TIME USE

CONNECTING A COMPONENT SOURCE WITH HDMI or DVI CAPABILITY TO INPUT 1 or INPUT 2

1. Connect the HDMI or DVI to HDMI connection cable from the output of the HDTV set top box or DVD player to the HDMI input as shown on the TV set below. When using a component with DVI output, you also have to connect the AUDIO OUT (R/L) of the component to the AUDIO IN (R/L) of INPUT 1.
2. Press the INPUTS button, then select INPUT 1 from the INPUTS menu to view the program from the HDTV set top box or DVD player. The VIDEO OSD label disappears automatically after approximately four seconds.
3. Select Antenna from the INPUTS menu to return to the previous channel.

HDMI-HDMI

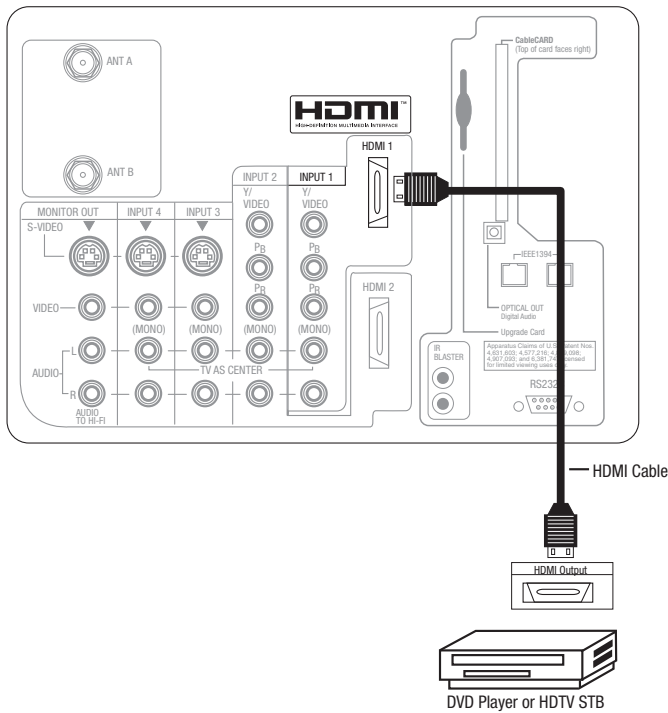

DVI-HDMI

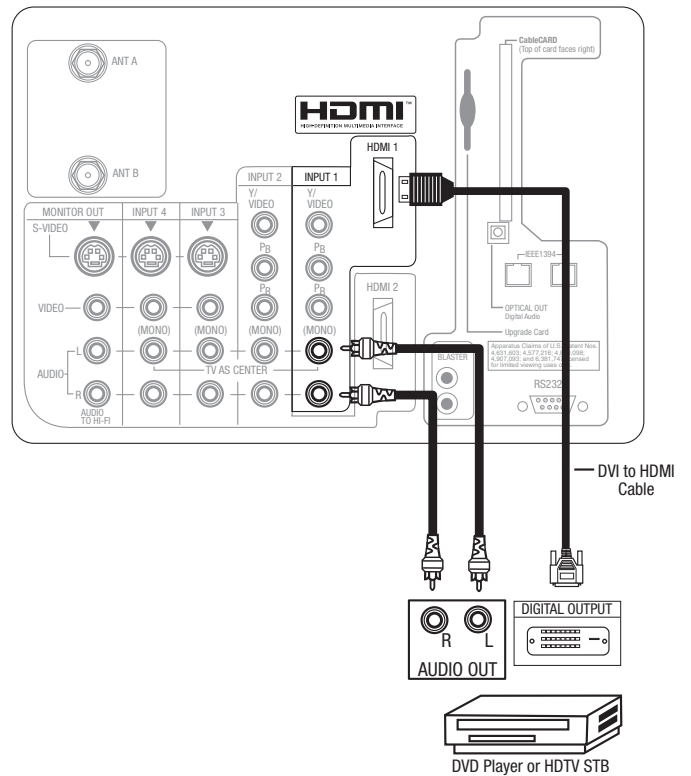

- NOTES:**
1. Completely insert the connection cord plugs when connecting to rear panel jacks. The picture and sound that is played back will be abnormal if the connection is loose.
 2. The HDMI input on INPUT 1 contains the copy protection system called High-bandwidth Digital Content Protection (HDCP). HDCP is a cryptographic system that encrypts video signals when using HDMI connections to prevent illegal copying of video contents.
 3. HDMI is not a "NETWORK" technology. It establishes a one-way point-to-point connection for delivery of uncompressed video to a display.
 4. The connected digital output device controls the HDMI interface so proper set-up of device user settings determines final video appearance.



CONNECTING EXTERNAL VIDEO DEVICES

FIRST TIME USE

CONNECTING A COMPONENT SOURCE TO INPUT 1 OR 2: Y-P_BP_R.

1. Connect the cable from the Y OUT of the Laserdisc/DVD player or HDTV set top box to the INPUT (Y) jack, as shown on the TV set below.
2. Connect the cable from the C_B/P_B OUT or B-Y OUT of the Laserdisc/DVD player or HDTV set top box to the INPUT (P_B) jack.
3. Connect the cable from the C_R/P_R OUT or R-Y OUT of the laserdisc/DVD player or HDTV set top box to the INPUT (P_R) jack.
4. Connect the cable from the AUDIO OUT R of the Laserdisc/DVD player or HDTV set top box to the INPUT (AUDIO/R) jack.
5. Connect the cable from the AUDIO OUT L of the Laserdisc/DVD player or HDTV set top box to the INPUT (AUDIO/L) jack.
6. Press the the INPUTS button, then select INPUT 2 from the INPUTS menu to view the program from the Laserdisc/DVD player or HDTV set top box. The VIDEO OSD label disappears automatically after approximately four seconds.
7. Select Antenna from the INPUTS menu to return to the previous channel.

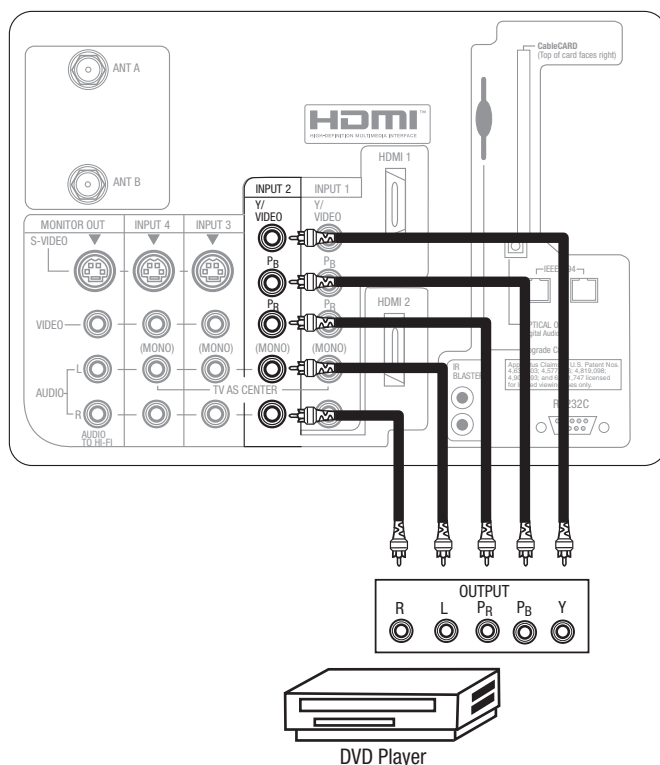

NOTES:

1. Completely insert the connection cord plugs when connecting to rear panel jacks. The picture and sound that is played back will be abnormal if the connection is loose.
2. See page 15 for tips on REAR PANEL CONNECTIONS.



CONNECTING EXTERNAL VIDEO DEVICES

FIRST TIME USE

CONNECTING A COMPONENT SOURCE WITH DIGITAL INTERFACE CAPABILITY TO IEEE1394 TERMINALS

1. Connect the IEEE1394 cable from the output of the component with IEEE1394 capability, such as a Set-Top-Box or Digital VCR, to the IEEE1394 input terminals shown on the Rear Panel below. IEEE 1394 allows the LCD Rear PTV and the external device to communicate with one another. When using IEEE1394 connections, you enable video and audio digital data exchange between a compatible device. This connection also enables you to control basic equipment functions (such as VCR play, rewind, fast forward, stop, etc.) from your TV On-Screen Display.
2. Press the INPUTS button on the Remote Control.
3. Select the IEEE1394 option (see page 36).

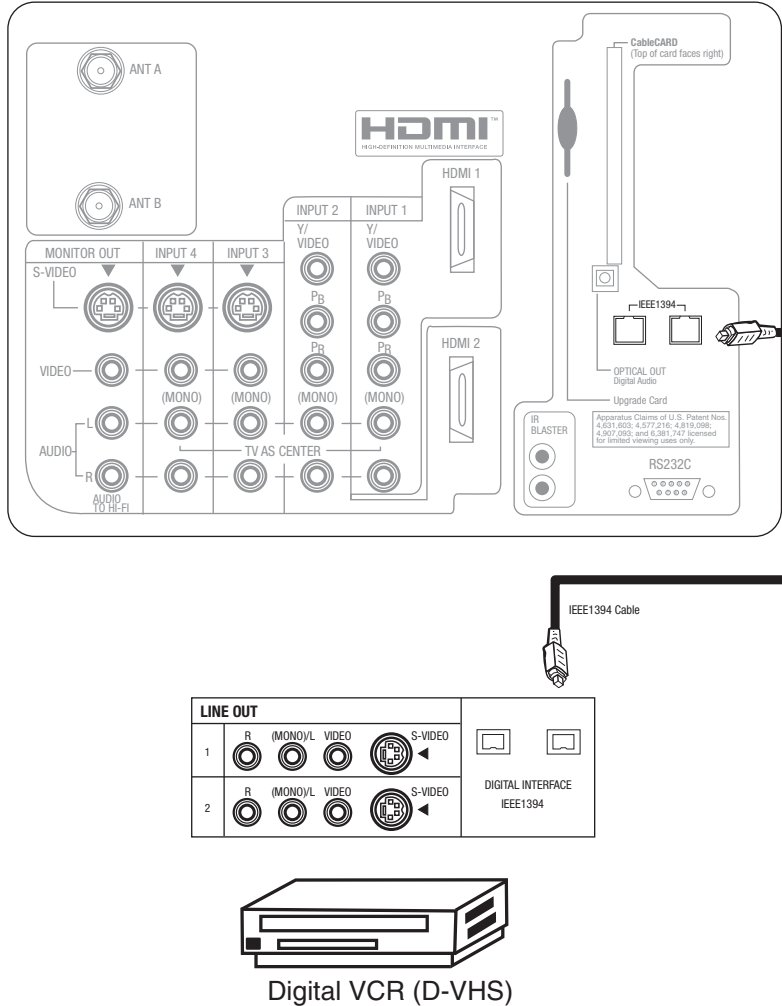

NOTES:

1. This LCD Rear PTV's IEEE1394 connection is not compatible with a DV camcorder (Digital Video camcorder) and a PC.
2. With IEEE1394 connection, video and audio will be received by the TV. It will enable you to control the D-VHS from the TV IEEE1394 menu (see page 36).
3. The IEEE1394 interface contains the copy protection standard called 5C or Digital Transmission Content Protection (DTCP).
4. See page 15 for tips on Rear Panel Connections.



CONNECTING AV NETWORK

Your Hitachi LCD Rear PTV is equipped with an AV Network feature. This feature helps to control your external Audio/Video equipment (VCR, Set Top Box, DVD, etc.). Once this is setup, it allows your IR Mouse connector to control your equipment using your Hitachi LCD PTV Remote Control. You can use your Hitachi remote control to control the Audio/Video equipment command without the equipment's remote control.

The LCD Rear PTV Rear Panel has 2 IR BLASTER jacks. Each IR Mouse cable can connect up to 2 external Audio/Video components. Therefore, you can connect the LCD Rear PTV with up to four components. Please see the following example of an AV Network setup between your Hitachi LCD Rear PTV and external Audio/Video equipment (VCR and DVD Player).

CONNECTING EXTERNAL AUDIO/VIDEO COMPONENTS TO IR BLASTER FOR AV NETWORK

1. Connect your external Audio/Video components to the Rear Panel shown on pages 16-22.
2. Connect the IR Mouse cable to the IR BLASTER output of the Rear Panel.
3. Place the IR mouse in front of the infrared sensor of the external components you wish to control.

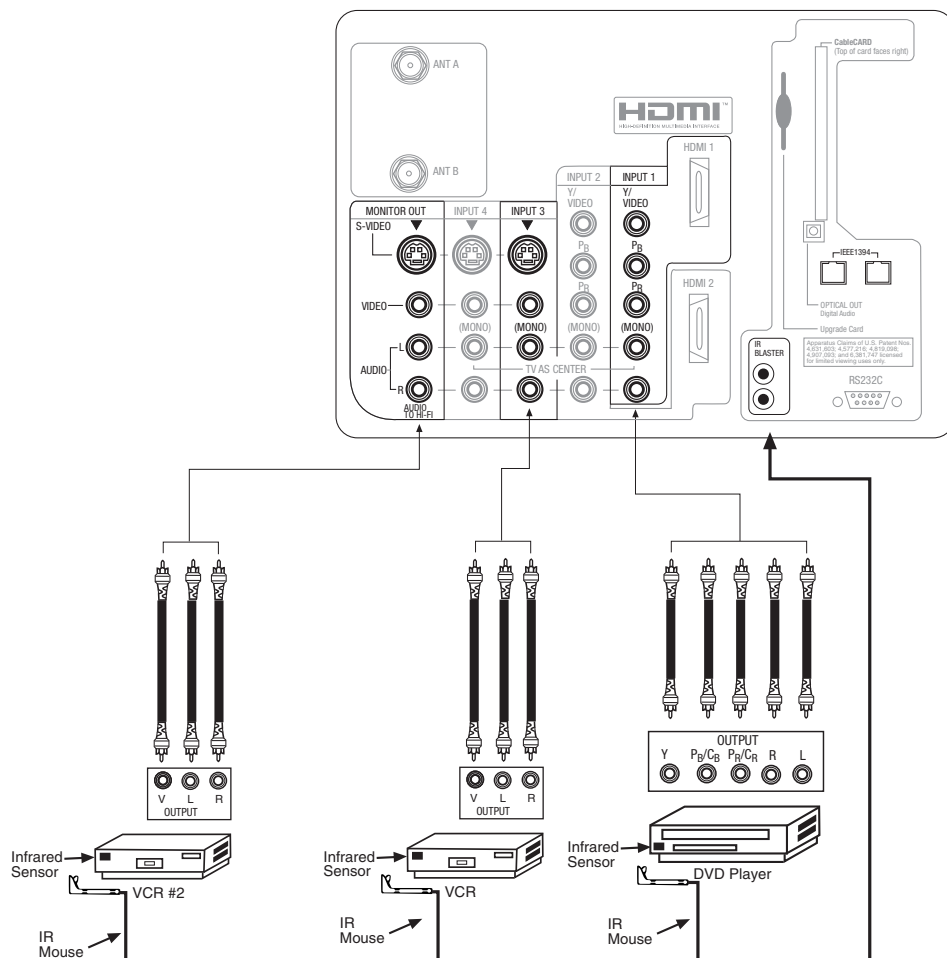

4. Press the AV NET button on the remote control. Use CURSOR PAD ▲ or ▼ to select and highlight the Device Setup

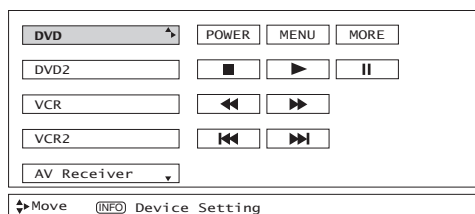

- NOTES:**
1. The Rear Panel has two IR BLASTER outputs which can control up to a total of four external components.
 2. The IR Mouse must be placed in front of the external components infrared sensor for the AV Network to work.
 3. The correct codes must be entered for each of the Audio/Video components for the AV Network to function properly.
 4. Audio/Video component codes for AV network are on page 25-26.
 5. When using the Timer Recording function, AV Network setting for VCR #2 is needed.



AV NETWORK SETUP WIZARD

FIRST TIME USE

5. Follow the steps below to setup your AV network (See page 25-26 for AV Network Codes).

SETUP PROCEDURE (DVD setup example below).

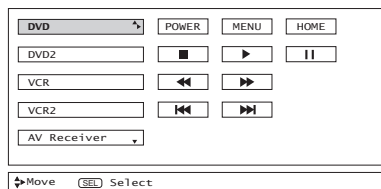

1. Press the A/V Net button on the remote control.

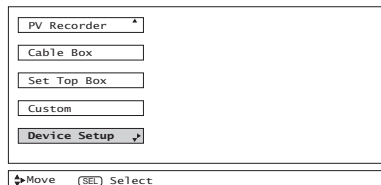

1. Use CURSOR PAD ▲, ▼ to select Device Setup.
2. Press the SELECT button on the remote control.

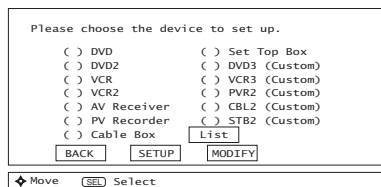

1. Use the CURSOR PAD ▲, ▼ to choose DVD and press the SELECT button on the remote control.
2. Cursor down to SETUP and press the SELECT button on the remote control.
LIST: Select to view the list of devices that are setup.

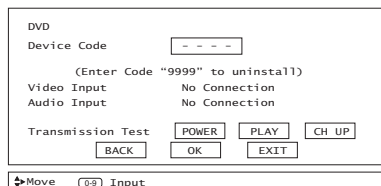

1. Using the remote, enter the four digit Device Code for your equipment, found on pages 25 and 26.
2. Using the CURSOR PAD, set the Video and Audio Inputs to the INPUT to which your device is connected.
3. Perform a Transmission Test by selecting Power, Play, or CH UP softkeys. If the device responds, then it is properly set up. Select OK. (If the Transmission Test failed, try another code.)

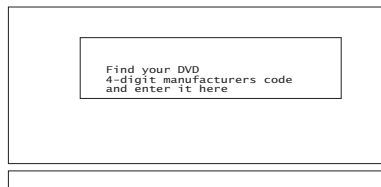

1. If "OK" was selected, and the 4 digit code was invalid, the screen on the left appears, then goes back to the device entry screen.



1. Select CONTINUE to setup another device.
2. Select DONE to finish and the following screen appears.

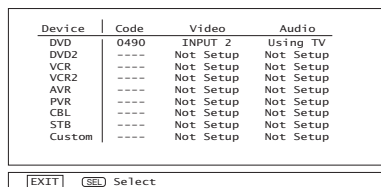

1. Select EXIT to quit.

6. See Remote Control AV NET button usage on pages 31 and 32.

AUDIO/VIDEO CODES FOR AV NETWORK (not for remote control)

VCR BRAND CODE 0104, 0432, 0454, 1048, 1162, 1262	Emerson 0591	Torx 0003
Admiral 0048, 0209	Orion 0184, 0209, 0002, 0479, 1479	Enterprise 0591	Toshiba 0000
Adventura 0000	Panasonic 1062, 0035, 0225, 0454, 0616, 1035, 1162, 1262	Fisher 0670	Zenith 0000, 0525, 0899
Aiko 0278	Penney 0035, 0037, 0240, 0042, 0038, 1035, 1237	GE 0522, 0717, 0815	
Aiwa 0000, 0037	Pentax 0042	GPX 0769	SATELLITE BRAND (Set-Top-Box) CODE
Akai 0041	Philco 0035, 0209, 0479	Go Video 0715	AlphaStar 0772
America Action 0278	Philips 0081, 0035, 0618, 1081, 1181	Gradiente 0651	Chapparral 0216
American High 0035	Pilot 0037	Greenhill 0717	Crossdigital 1109
Asha 0240	Pioneer 0067	Harman/Kardon 0582, 0702	DishPro 1005, 0775
Audiovox 0037, 0278	Polk Audio 0081	Hitachi 0490, 0573, 0664	Echostar 1005, 0775
Beaumont 0240	Profitronic 0240	Hiteker 0672	Expressvu 0775
Bell & Howell 0104	Proscan 0060, 0760, 1060	JBL 0702	GE 0566
Broksonic 0121, 0184, 0002, 0209, 0479, 1479, 0278	Protac 0072	JVC 0623, 0558, 0867	GOI 0775
CCE 0072, 0278	Pulsar 0039	Kenwood 0490, 0534, 0682	General Instrument 0869
Calix 0037	Quasar 0035, 0162, 0454, 1035, 1162	Konka 0711, 0719, 0721	HTS 0775
Canon 0035	RCA 0060, 0240, 0042, 0149, 0760, 1035, 1060	Koss 0651	Hitachi 0819
Carver 0081	Radio Shack 0000, 1037	Lasonic 0798	Hughes Network Systems 1142, 0749, 1749
Carver 0081	Radix 0037	Magnavox 0503, 0675	JVC 0775
Cineral 0278	Randex 0037	Malata 0782	Magnavox 0724, 0722
Citizen 0278, 0037, 1278	Realistic 0035, 0037, 0048, 0047, 0000, 0104	Marantz 0539	Memorex 0724
Colt 0072	ReplayTV 0614, 0616	Microsoft 0522	Mitsubishi 0749
Craig 0037, 0072, 0047, 0240	Runco 0039	Mintek 0717	Motorola 0869
Curtis Mathes . 0035, 0041, 0060, 0162, 0760, 1035	STS 0042	Mitsubishi 0521	Next Level 0869
Cybernex 0240	Samsung 0045, 0240	Nesa 0717	Panasonic 0247, 0701
Daewoo 0278, 1278, 0045	Sanky 0039, 0048	Onkyo 0627, 0503	Paysat 0724
Denon 0042	Sansui . 0000, 0067, 0209, 0041, 0479, 1479	Oritron 0651	Philips 1142, 0749, 0724, 1076, 0722, 1749
Dynatech 0000	Sanyo 0047, 0240, 0104	Panasonic 0490, 1362, 0632	Proscan 0392
Electrohome 0037	Scott 0184, 0045, 0121, 0043	Philips 0503, 0539, 0646, 0854	RCA 0392, 0566, 0855, 0143
Electrosonic 0037	Sears 0035, 0037, 0047, 0000, 0042, 0104, 1237	Pioneer 0525, 0571, 0632	Radioshack 0869
Emerex 0032	Semp 0045	Polk Audio 0539	SKY 0856
Emerson 0184, 0002, 0209, 0121, 0000, 0037, 0043	Sharp 0048, 0848	Princeton 0674	Samsung 1109
Fisher 0104, 0047	Shintom 0072	Proscan 0522	Sony 0639
Fuji 0033, 0035	Shogun 0240	RCA 0522, 0571, 1022, 0717	Star Choice 0869
Funai 0000	Singer 0072	Rowa 0823	Toshiba 0749, 0790, 1749
GE 0035, 0060, 0240, 0760, 0807, 1035, 1060	Sonic Blue 0614, 0616	Sampo 0698	Uniden 0724, 0722
Garrard 0000	Sony 0035, 0032, 0000, 0033, 0636, 1032, 1232	Samsung 0573, 0820	Zenith 0856, 1856
Go Video 0432	Sylvania 0035, 0081, 0000, 0043, 1781	Sansui 0695	
GoldStar 0037, 0038, 1237	Symphonic 0000	Sanyo 0670	
Gradiente 0000	TMK 0240	Sharp 0630	AMPLIFIER BRAND. CODE
Hi-Q 0047	Tatung 0041	Sherwood 0633	Aiwa 0406
Harley Davidson 0000	Teac 0000, 0041	Sony 0533	Bose 0674
Harman/Kardon 0038, 0081	Technics 0035, 0162	Sylvania 0675	Carver 0269
Harwood 0072	Teknika 0000, 0035, 0037	Technics 0490	Curtis Mathes 0300
Hitachi 0000, 0041, 0042	Thomas 0000	Techwood 0692	Denon 0160
Hughes Network Systems 0042	Tivo 0618, 0636	Theta Digital 0571	GE 0078
JVC 0067, 0041	Toshiba 0045, 0043	Toshiba 0503, 0695	Harman/Kardon 0892
Jensen 0041	Totevision 0037, 0240	Urban Concepts 0503	JVC 0331
KEC 0037, 0278	Unitech 0240	Yamaha 0490, 0545, 0539	Left Coast 0892
KLH 0072	Vector 0045	Zenith 0591, 0503	Linn 0269
Kenwood 0041, 0067, 0038	Vector Research 0038		Luxman 0165
Kodak 0035, 0037	Video Concepts 0045	CABLE BRAND CODE	Magnavox 0269
LXI 0037	Videomagic 0037	ABC 0003, 0008, 0014, 0017	Marantz 0269, 0321, 0892
Lloyd's 0000	Videosonic 0240	Americast 0899	NEC 0264
Logik 0072	Wards 0060, 0035, 0048, 0047, 0081, 0240, 0000, 0042, 0072, 0149, 0760	Bell & Howel 0014	Nakamichi 0321
MEI 0035	White Westinghouse . 0072, 1278, 0209	Bell South 0899	Optimus 0395, 0300
MGA 0043, 0240	XR-1000 0072, 0000, 0035	Director 0476	Panasonic 0308, 0521
MGN Technology 0240	Yamaha 0038	General Instrument 0003, 0476, 0276, 0810	Parasound 0246
MTC 0000, 0240	Zenith 0039, 0000, 0209, 0033, 0479, 1479, 0033, 0209, 0479	GoldStar 0144	Philips 0269, 0892
Magnasonic 1278		Hamlin 0009, 0273	Pioneer 0013, 0300
Magnavox 0035, 0081, 0563, 0000, 0039, 0149, 1781		Jerrold 0476, 0003, 0276, 0012, 0014, 0810	Polk Audio 0269, 0892
Magnin 0240	DVD BRAND CODE	Memorex 0000	RCA 0300
Marantz 0081, 0035	Aiwa 0641	Motorola 0476, 1106, 0276, 0810	Realistic 0395
Marta 0037	Apex 0672, 0717, 0755, 0794, 0795, 0796, 0797, 0830	Pace 0237	Sansui 0321
Matsushita 0035, 0162, 0454	Audiologic 0736	Panasonic 0107, 0000	Shure 0264
Memorex 0047, 0037, 0104, 0209, 0454, 0048, 0039, 0240, 0000, 0479, 1037, 1162, 1237, 1262	B & K 0655, 0662	Philips 0305, 0317	Sony 0689, 0220
	Blue Parade 0571	Pioneer 0144, 0533, 0877, 1877	Soundesign 0078, 0211
	Brooksonic 0695	Pulsar 0000	Technics 0308, 0521
	DVD2000 0521	Quasar 0000	Victor 0331
	Daewoo 0784	Regal 0273, 0279	Wards 0013, 0078, 0211
	Denon 0490, 0634	Runco 0000	Yamaha 0354, 0133
		Samsung 0144	
		Scientific Atlanta 0877, 0008, 0017, 0477, 1877	RECEIVER BRAND (Amplifier) CODE
		Sony 1006	ADC 0531
		Starcom 0003	Adcom 0616
		Supercable 0276	Aiwa 1089, 1405, 0121, 0158, 0189, 0405, 1321, 1388
		Tocorn 0012	Akai 0076, 0224
			Alco 1390

AUDIO/VIDEO CODES FOR AV NETWORK (not for remote control)

FIRST TIME USE

Anam 1074, 1609
 Apex Digital 1257
 Arcam 1120
 Audiotronic 1189
 Audiovox 1390
 Bose 1229
 Capetronic 0531
 Carver 1089, 1189, 0008, 0042, 0189,
 0360
 Casio 0195
 Celestion 1264
 Clarinette 0195
 Compaq 1136
 Curtis Mathes 0080
 Denon 1104, 0004, 0273, 0771, 1311,
 1360
 Emerson 0424
 Fisher 0042, 0219, 0360
 GPX 1299
 Garrard 0424, 0463
 Glory Horse 1263
 Harman/Kardon 0891, 0110, 0189
 Hewlett Packard 1181
 Inkel 0062
 JBL 0110, 1306
 JVC 0074, 1263, 1374
 Kenwood 1313, 1027, 1570, 1569, 0027,
 0042, 0077, 0186, 0313, 0314, 0569,
 1051, 1052
 Koss 0424, 1366
 LXI 0181
 Lexicon 1076
 Linn 0189
 Lloyd's 0195
 MCS 0039, 0346
 Magnavox 1089, 1189, 0128,
 0189, 0195, 0391, 0531
 Marantz 1089, 1189, 0039, 0128, 0189
 Modulaire 0195
 Musicmagic 1089
 NAD 0320
 NEC 0235
 Nakamichi 0097, 0347
 Onkyo 0100, 0135, 0380, 0842, 1298
 Optimus 1023, 0042, 0080, 0177, 0181,
 0186, 0219, 0531, 0670, 0738, 0801,
 1074
 Panasonic 1518, 0039, 0309,
 0367, 0518, 1288, 1350
 Penney 0195
 Philips 1089, 1189, 1269, 0189,
 0391, 1120, 1268, 1283
 Pioneer 1023, 0014, 0080, 0150,
 0244, 0531, 0630, 1343, 1384
 Polk Audio 0189
 Proscan 1254
 Quasar 0039
 RCA 1023, 1254, 0054, 0080, 0346,
 0360,
 0530, 0531, 1074, 1154, 1390, 1609
 Radio Shack 1263
 Realistic 0163, 0181, 0195
 Samsung 1295
 Sansui 0189, 1089, 0193, 0346
 Sanyo 0219, 0801, 1251
 Scott 0163, 0322
 Sharp 1286, 0186
 Sherwood 0062, 0491, 0502
 Sony 1058, 1258, 1158, 0158,
 0168, 0474, 1042, 1458
 Soundesign 0670
 Stereophonics 1023
 Sunfire 1313, 0313, 0314, 1052
 Teac 0463, 0163, 1074
 Technics 1308, 1309, 1518,
 0039, 0208, 0309, 0518
 Thorens 1189
 Victor 0074
 Wards 0014, 0054, 0080, 0158, 0189
 Yamaha 0176, 0186, 1176

Yorx 0195
 Zenith 0857

AUDIO BRAND CODE

Aiwa 0010, 0404
 AudioSource 0351
 Cambridge Soundworks 0351
 Carver 0351
 Fisher 0052
 Fosgate 0259
 Harmon/Kardon 0477
 JBL 0477
 JVC 0073
 KLH 0351
 Magnavox 0325
 Nikko 0376
 Paramount Pictures 0317, 0351
 RCA 0056
 SSI 0317
 Sansui 0325
 Schneider 0376
 Sony 0010, 0576
 Soundesign 0376
 Yorx 0376

SET TOP BOX BRAND CODE

Panasonic 1120
 Pioneer 1010
 Princeton 0113, 0295
 Samsung 1190
 Sensory Science 1126
 Sharp 1010
 Sony 0639

PERSONAL VIDEO RECORDER

BRAND CODE

EchoStar 0775, 1005
 Hughes 1142
 Panasonic 0616
 Philips 0618
 Proscan 0392
 ReplayTV 0614, 0616
 SonicBlue 0614, 0616
 Sony 0639, 0636
 Tivo 0618, 0636



THE REMOTE CONTROL

In addition to controlling all the functions on your HITACHI Projection TV, the new remote control is designed to operate different types of VCRs, CATV (Cable TV) converters, set-top-box, satellite receiver, DVD players, and other audio/video equipment with one touch. Basic operation keys are grouped together in one area.

To operate your TV, point the remote control at the screen of the TV and select the TV by pressing the ◀ or ▶ button of the Source Access on the remote.

To operate your VCR, point the remote at the remote sensor of the VCR and select PVR by pressing the ◀ or ▶ button of the Source Access on the remote (see page 45 for instructions on how to program the remote to control your VCR).

To operate your cable box, point the remote at the remote sensor of the cable box and select the CABLE (CBL) by pressing the ◀ or ▶ button of the Source Access on the remote (see page 42 for instructions on how to program the remote to control your cable box).

To operate your set-top-box or satellite receiver point the remote at the remote sensor of the set-top-box and select the SET-TOP-BOX (STB) by pressing the ◀ or ▶ button of the Source Access on the remote. If you have a satellite receiver, use this button to program your satellite receiver (see page 43 for instructions on how to program the remote to control your set-top-box).

To operate your DVD player, point the remote at the remote sensor of the DVD player and select DVD by pressing the ◀ or ▶ button of the Source Access on the remote (see page 44 for instruction on how to program the remote to control your DVD player).

To operate your PVR (Personal Video Recorder), point the remote at the remote sensor of the PVR and select PVR by pressing the ◀ or ▶ button of the Source Access on the remote (see page 45 for instruction on how to program the remote to control your PVR).

To operate additional audio equipment, point the remote at the remote sensor of the component you wish to control and select AMP by pressing the ◀ or ▶ button of the Source Access on the remote (see page 46 for instructions on how to program the remote to control additional Audio/Video equipment).

THE REMOTE CONTROL

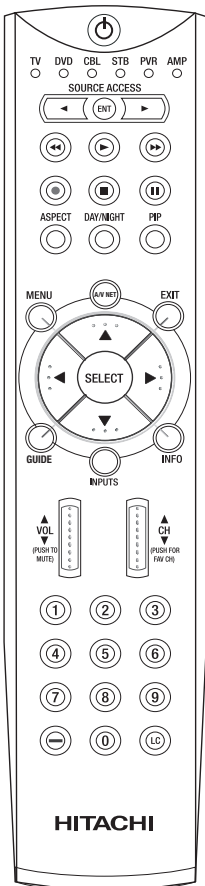

NOTE: When you are in a dark room, press any button on the remote to light up the buttons. The illumination will light for a few seconds during this time. The current mode indicator will flash one time. These buttons will not appear to light if the room is too bright.

HOW TO USE THE REMOTE TO CONTROL YOUR LCD REAR PTV



THE REMOTE CONTROL

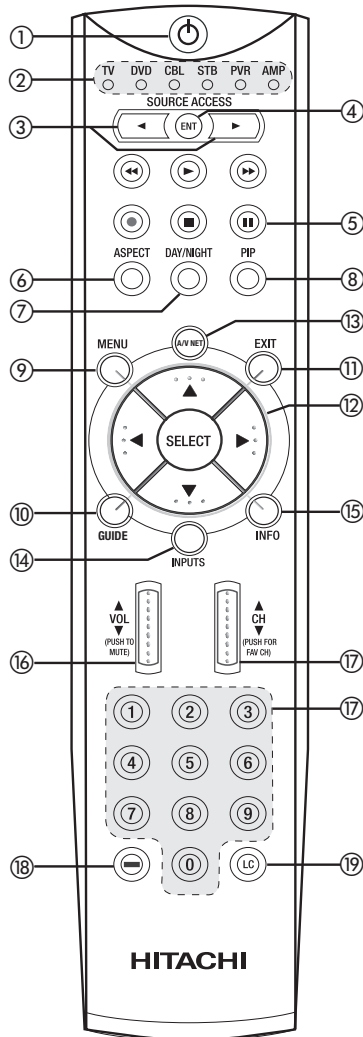

- ① **POWER button**
Press this button to turn the TV set on or off when the remote is in TV mode. (See page 27 for instructions on how to set the remote control to TV mode.)
- ② **MODE Indicator**
Turns on or blinks to show remote control mode.
- ③ **SOURCE ACCESS (◀, ▶) buttons**
Press these buttons to select remote control mode.
- ④ **SOURCE ACCESS (ENT) button**
Hold down this button while entering your device code to program the remote (see pages 42-50). You can also use this button in an optional Input access feature (see page 47).
- ⑤ **PAUSE button**
Press the PAUSE button to freeze the picture. Press the EXIT button to return the picture to motion. Press the PAUSE button repeatedly to cycle through the three different freeze modes (see page 41).

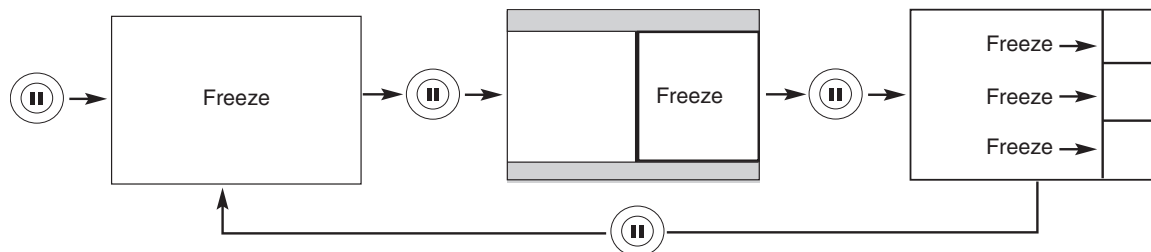

HOW TO USE THE REMOTE TO CONTROL YOUR LCD REAR PTV



⑥ ASPECT button

Press this button to quickly change the picture format ASPECT ratio.

Depending on the input signal format received, the picture format ratio allows you to adjust the images through the following options.

- 4:3 STANDARD Use this aspect mode to display conventional (4:3) images. Side panels (gray areas) are placed to the left and right of the image to preserve the original aspect ratio of the source.
- 4:3 EXPANDED Use this aspect mode to display conventional (4:3) sources by linearly increasing image expansion from the center towards the edges of the display area in order to fill it.
- 4:3 Zoom1/Zoom2 Use these aspect modes to zoom in on conventional (4:3) sources.
- 16:9 STANDARD Use this aspect mode to display 16:9 sources like HDTV and DVD's preserving the original 16:9 aspect ratio.
- 16:9 Zoom Use this aspect to Zoom-in once while in 16:9 aspect.

(1) NTSC/480i/480P Input

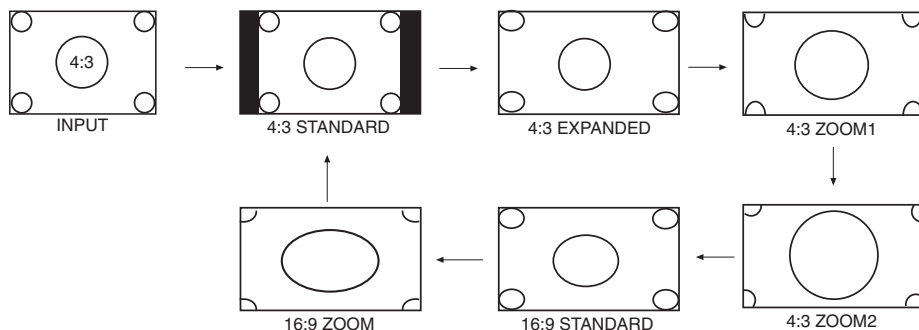

(2) 480i/480P Input

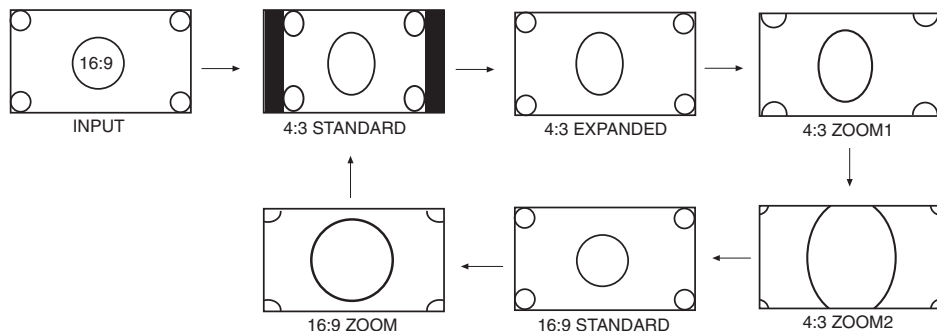

(3) HDMI/720P/1080i Input

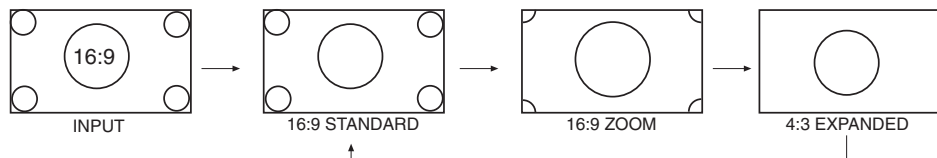

THE REMOTE CONTROL

- NOTES:**
1. The Aspect Style setting you select for an ANT input will automatically be set for the other ANT inputs. However, all five video inputs have independent Aspect Style settings.
 2. Vertical position adjustments are directly available when you choose 4:3 EXPANDED/ZOOM1/ZOOM2 or 16:9 ZOOM aspect style (see also page 61).

HOW TO USE THE REMOTE TO CONTROL YOUR LCD REAR PTV



⑦ DAY/NIGHT button

Press this button to toggle between Day and Night picture mode settings. Select Day for day time viewing with more brightness and contrast to compete with room light. Select Night for night time viewing with less brightness and contrast for a more detailed picture (see page 54 for settings changes).

NOTE: For automatic DAY/NIGHT picture mode settings, see page 70.

⑧ PICTURE-IN-PICTURE button

See separate section on pages 39-41 for a description.

⑨ MENU button

The MENU button will start the On-Screen Display.

⑩ GUIDE button

Press this button to access the Channel Guide. Press the GUIDE button again to return to normal viewing.

Select CHANNEL GUIDE to display available program information. Only scanned programs that are available at the present time will show in the Channel Guide (see Auto Channel Scan on page 62).

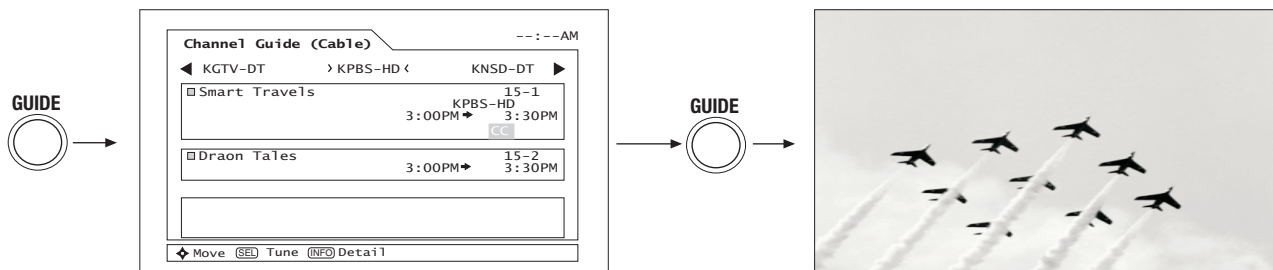

Use the CURSOR PAD ▲, ▼, ◀, ▶ to highlight the channel of choice (example: KPBS-HD). Press the CURSOR PAD ▲, ▼, to highlight the subchannel of choice (example: 15-1). Press the SELECT button to tune the subchannel of choice.

NOTE: The availability of Channel Guide Information will depend on the type of Antenna input (Analog, Digital) and Cable subscription.

⑪ EXIT button

This button will exit all On-Screen Displays.

⑫ CURSOR PAD/SELECT button

All the On-Screen Display features can be set or adjusted by using the CURSOR PAD, except for numeric entries. The CURSOR PAD will highlight functions or adjust and set different features. Press the CURSOR PAD toward desired direction and press the SELECT button to select.

HOW TO USE THE REMOTE TO CONTROL YOUR LCD REAR PTV



13 AV NET button

Press this button to access the Audio/Video network (AV Net) menu. The AV Net allows the user to control external components with the LCD PTV remote control. When you press the AV NET button, the following window will pop up within the Display Monitor screen. The window will disappear after 30 seconds if you don't press any buttons.

Select Device Setup to start.

Use CURSOR PAD ▲, ▼, ◀, ▶ to navigate and SELECT to select button. The command on the button is passed through the IR mouse and onto the AUDIO/VIDEO equipment. These on-screen buttons are called "Soft Keys".

Customize your Audio/Video equipment list and soft keys by selecting the Custom options and following the instructions of the AV NET learning wizard (see page 32).

This window shows the available Audio/Video equipment soft keys. The equipment list will scroll up or down.

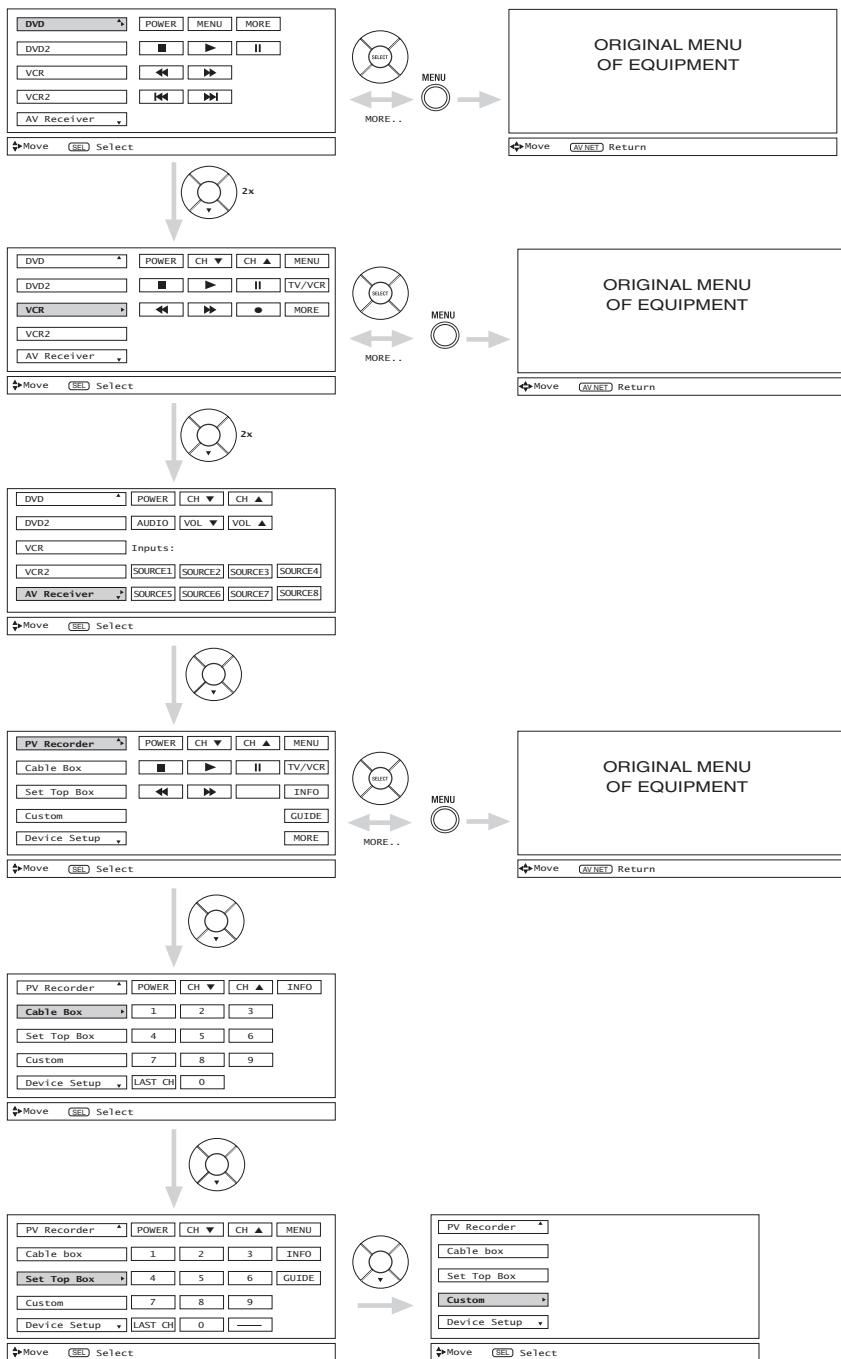

THE REMOTE CONTROL

- NOTES:**
1. Devices will not be available until Device Setup is completed (see pages 23-26).
 2. The "Custom" option will not be available until the Custom device Setup is learned and completed. After completion, the "Custom" tag will be replaced with the device tag.
 3. The Custom option only accepts one device at a time. The second Custom device setup will replace the first device.



HOW TO USE THE REMOTE TO CONTROL YOUR LCD REAR PTV

AV NET LEARNING WIZARD

This function of the AV NET makes it more expandable because it allows the user to use equipment that is not supported by the pre-code library, listed on page 25-26. For example, after programming your equipment to the AV NET and the soft keys do not work, the user just has to follow the steps below. The AV NET Learning Wizard will transfer any remote button IR code of your equipment to the soft keys of your AV NET. If all remote button transfers are successful, the user can now control their equipment by using the LCD Rear PTV remote control.

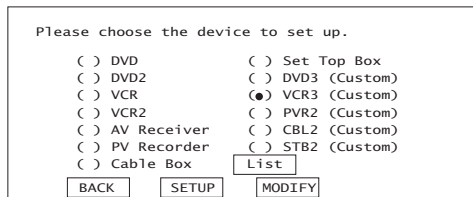

1. Press A/V NET button on the remote control.
2. Use the CURSOR PAD to select DEVICE SETUP, press the SELECT button.
3. Use the CURSOR PAD/SELECT button to choose CUSTOM option (Ex. VCR3).
4. Use the CURSOR PAD to select Setup, press the SELECT button.

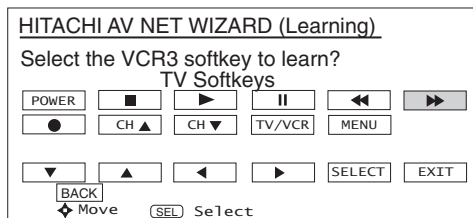

1. Select TV Softkeys to learn, press the SELECT button.

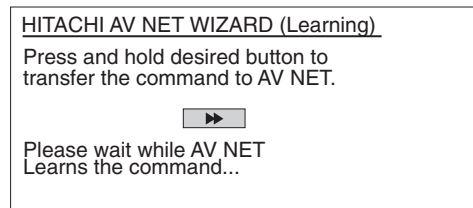

1. Press and hold the ►► button of the VCR remote control while pointing directly at the learning AV NET sensor of the LCD Rear PTV (see pages 8-9) at a distance of 2 to 3 meters.

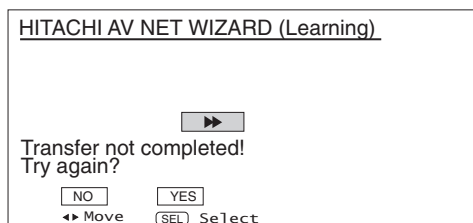

1. Select OK to continue.

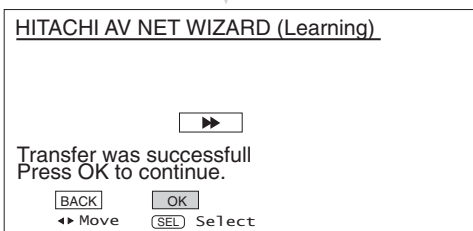

THE REMOTE CONTROL

- NOTES:**
1. To access the Menu function of a specific equipment, select the "MENU" soft key on OSD, then press the MENU button of the LCD Rear PTV remote control. In order to use CURSOR PAD and EXIT button of the LCD Rear PTV remote control, "arrows, select, and EXIT" button must be learned. Then the menu of the programmed equipment can be controlled with the LCD Rear PTV remote control.
 2. When using the Learned device with the Timer Recording function, the Power, Stop and Record soft Keys should be learned first.

HOW TO USE THE REMOTE TO CONTROL YOUR LCD REAR PTV



⑭ INPUTS button

When the remote control is in TV mode, press this button to access the INPUTS menu. Use the CURSOR PAD and SELECT button to select the inputs that are being used. Pressing the INPUTS button repeatedly will also cycle through the Inputs menu items. Then press the SELECT button to select.

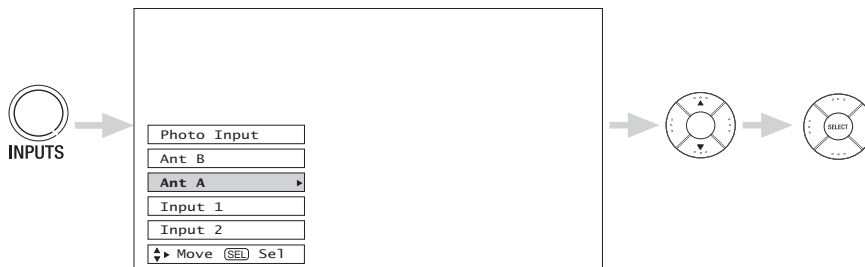

Photo Input	Select to access your pictures from a digital camera connected to the Photo Input in the front panel of the TV (see page 34).
Ant B	Select to choose Antenna B.
Ant A	Select to choose Antenna A.
Input 1	Select to choose Input 1 for Video 1.
Input 2	Select to choose Input 2 for Video 2.
Input 3	Select to choose Input 3 for Video 3.
Input 4	Select to choose Input 4 for Video 4.
Input 5	Select to choose Input 5 for Video 5.
IEEE1394	Select to choose for IEEE1394 Input (see page 36).



HOW TO USE THE REMOTE TO CONTROL YOUR LCD REAR PTV

PHOTO INPUT

This feature is useful for viewing digital still pictures from your digital camera using the Photo Input in the side panel of the TV.

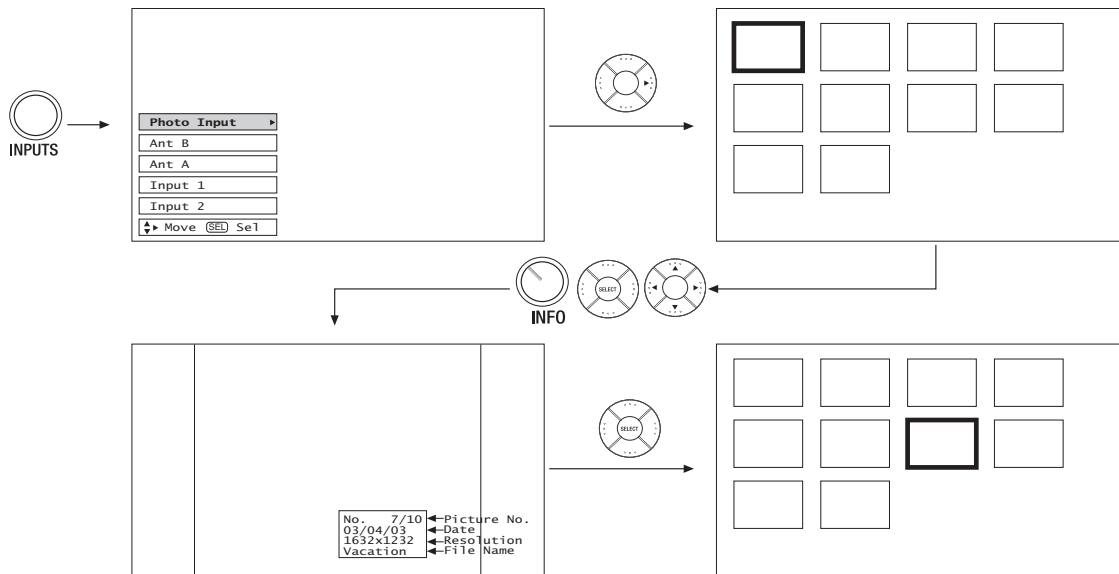

JUMP

Select this menu item to view the chosen picture number.

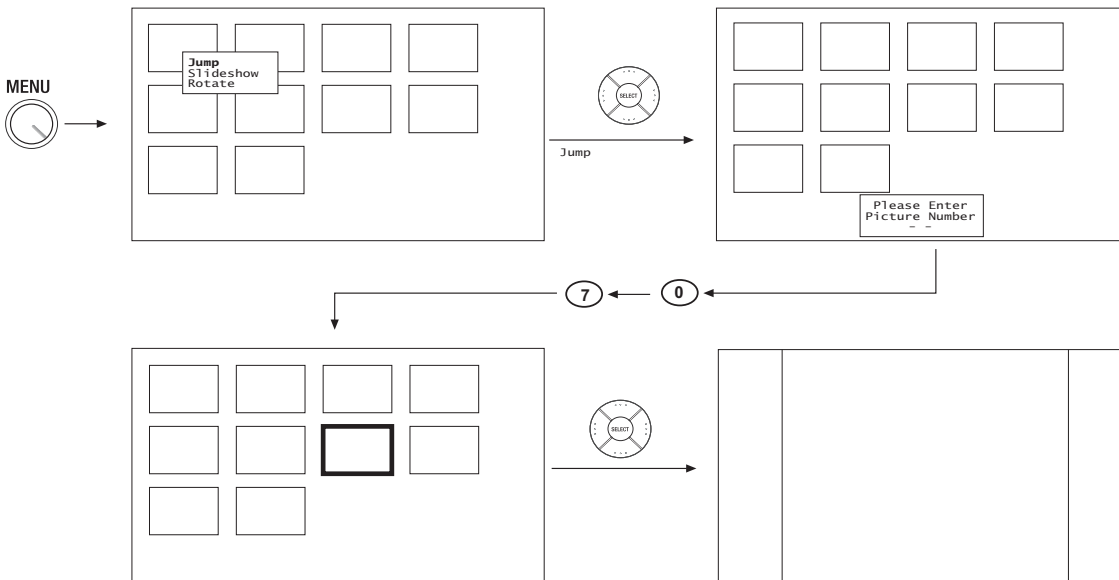

THE REMOTE CONTROL

- NOTES:**
1. The maximum number of digital Photos that can be displayed is 999.
 2. Press INFO button to show Picture Numbers in Thumbnail view, plus other information in individual photos.
 3. Digital photos recorded on a DVD-RAM disc may not work with this Photo Input.
 4. Certain types of digital cameras may not work with this Photo Input.
 5. Digital cameras with low battery power may not properly display your photos in this input.
 6. The screen may show "Input device not detected" if the digital camera's large capacity memory is fully loaded. Please wait 1 or 2 minutes before checking your Photo Input connections.
 7. The screen may show "Input device not detected" due to slow access time on some digital cameras. Please wait 1 or 2 minutes before checking your Photo Input connections.

HOW TO USE THE REMOTE TO CONTROL YOUR LCD REAR PTV



SLIDESHOW

Select this menu item to start a slideshow of the Photos in your digital camera. Time interval selections can be set from 5, 10 and 30 seconds.

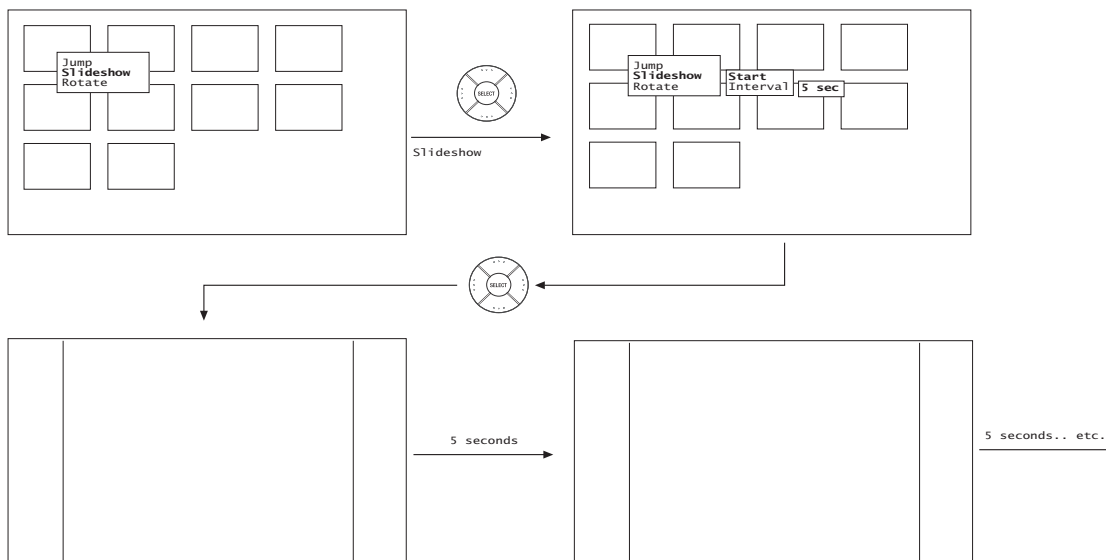

Use CURSOR PAD ▲, ▼ to highlight Slideshow item.

While interval is highlighted, press SELECT to change interval time from 5, 10 and 30 seconds. Each press will change interval time from the three mentioned choices.

Press SELECT to stop on a chosen picture of the slideshow. After 30 seconds, the slideshow will resume, or press SELECT again to continue the slideshow.

Press EXIT to exit the slideshow.

ROTATE

Select this menu item to rotate selected photos either clockwise (CURSOR PAD ►) and counterclockwise (CURSOR PAD ◀). Rotate menu item is also available in THUMBNAIL view.

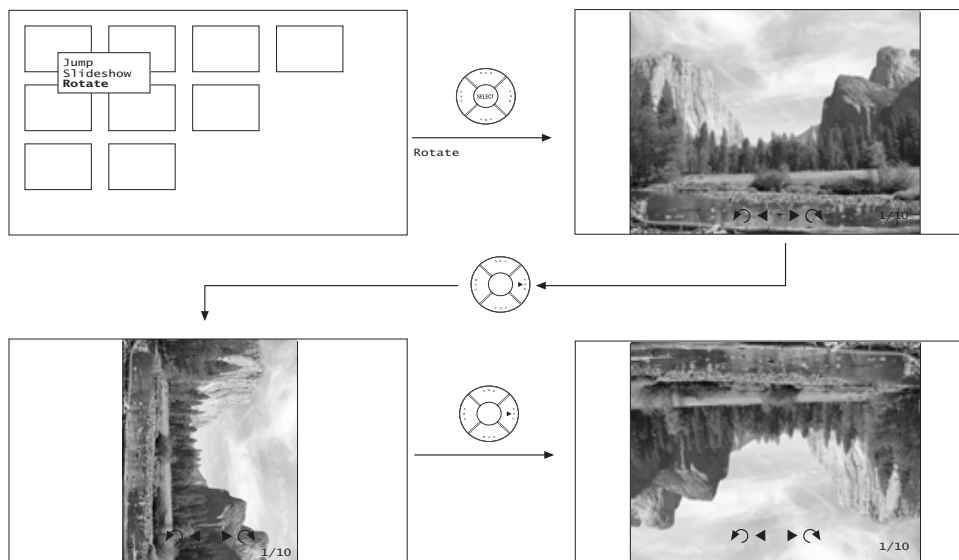

- NOTES:**
1. Photo file names modified on a computer should be 8 characters (Ex. ABCD1234.jpg). 1st character: letters; 2nd to 4th: letters or numbers; 5th to 8th: numbers. Photo files should be first placed on a sub directory name with 8 characters (Ex. 123ABCDE). 1st to 3rd: number; 4th to 8th: letters. The sub directory then should be placed on a main directory with a "dcim" file name format.
 2. Supported image types are up to 3072 x 2304; JPEG format should conform with DCF Standard (Design rule for Camera File System).
 3. This TV set displays only digital pictures from digital cameras which meet DCF Standard. Pictures that were copied, edited or modified on a computer may not be displayed on the TV set.



HOW TO USE THE REMOTE TO CONTROL YOUR LCD REAR PTV

IEEE1394 Use this function to control your devices with digital interface capability. Press the INPUTS button, CURSOR PAD and SELECT button to select IEEE 1394.

(When an IEEE1394 device is not connected)

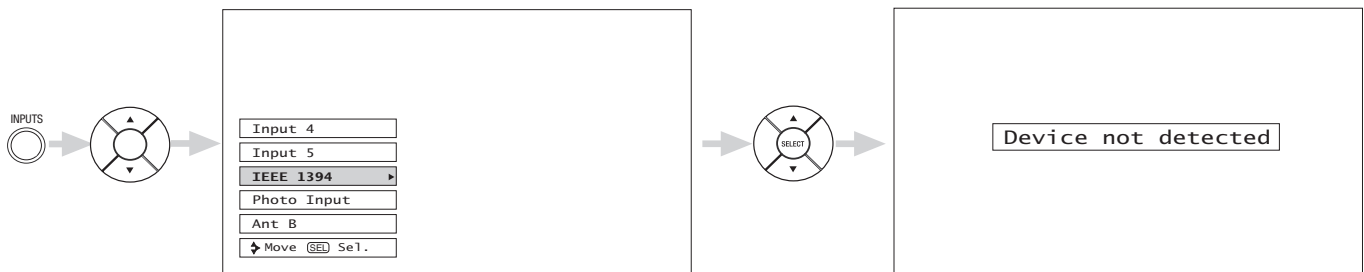

(When an IEEE1394 device is connected)

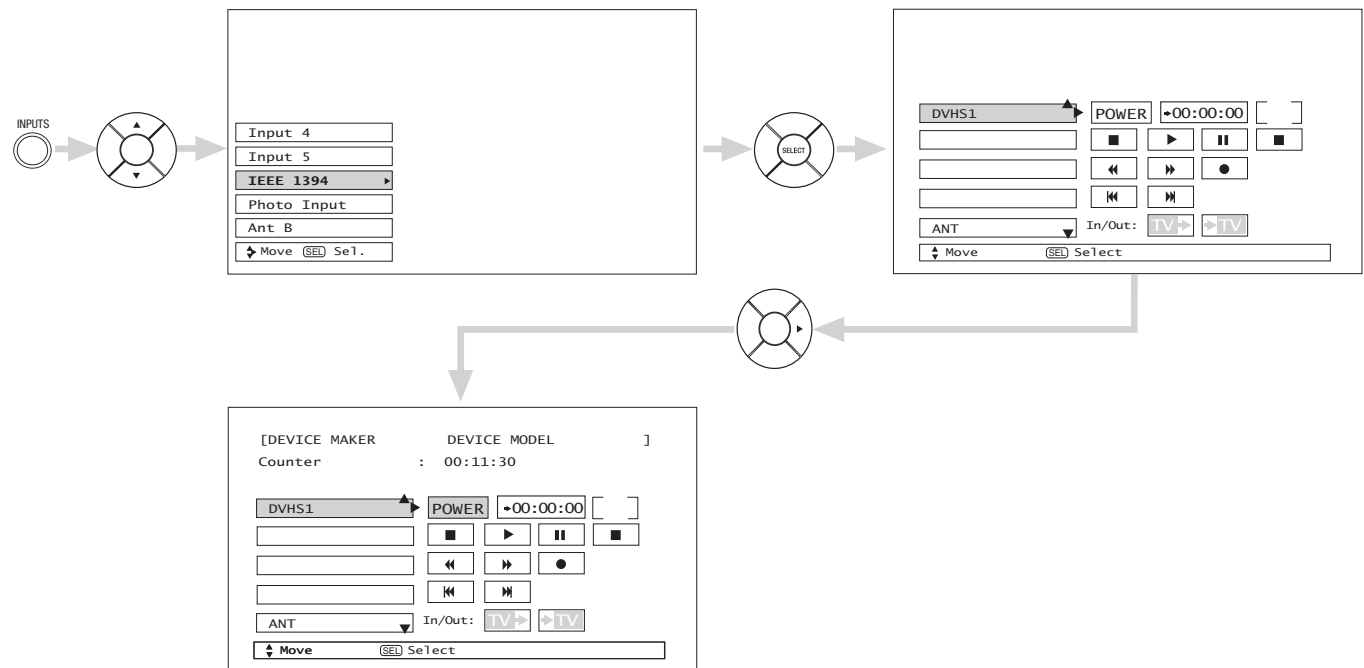

THE REMOTE CONTROL

Use CURSOR PAD ▲, ▼ to highlight connected device (example D-VHS1).
 Use CURSOR PAD ► to select connected device (example D-VHS1).
 Use CURSOR PAD cursors to highlight POWER.
 Press the SELECT button to power on the device.
 Use CURSOR PAD cursors to select D-VHS operation.
 Press down on the CURSOR PAD to enable the selected operation.
 Use CURSOR PAD cursors to highlight the TV IN/OUT operation.
 Press down on CURSOR PAD to select: TV IN is DVHS
 TV OUT is ANT A

- NOTES:**
1. The digital device will be automatically recognized if properly connected.
 2. Four (4) IEEE1394 devices can be listed on the menu, but only 1 device at a time can be used. If a fifth device is connected, it will replace the first device on the menu list.
 3. This TV's IEEE1394 connection is not compatible with a DV camcorder (Digital Video Camcorder) or a PC.
 4. The On-Screen-Display will not disappear until the EXIT button is pressed.
 5. Not all devices with IEEE1394 capability are compatible with this TV. Any compatibility problems with other manufacturers devices should be brought to the attention of those manufacturers.
 6. TV IN/OUT functions are not available when DVHS is in playback or recording.

HOW TO USE THE REMOTE TO CONTROL YOUR LCD REAR PTV



15 INFO button

Press this button when you want to check the channel being received, the picture source, if the channel has stereo (ST) or second audio program (SAP), the time, CHANNEL ID and if the TIMER is set.

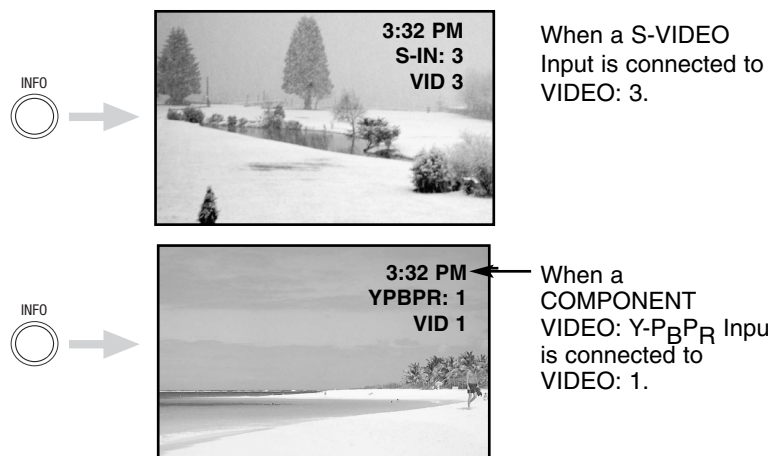
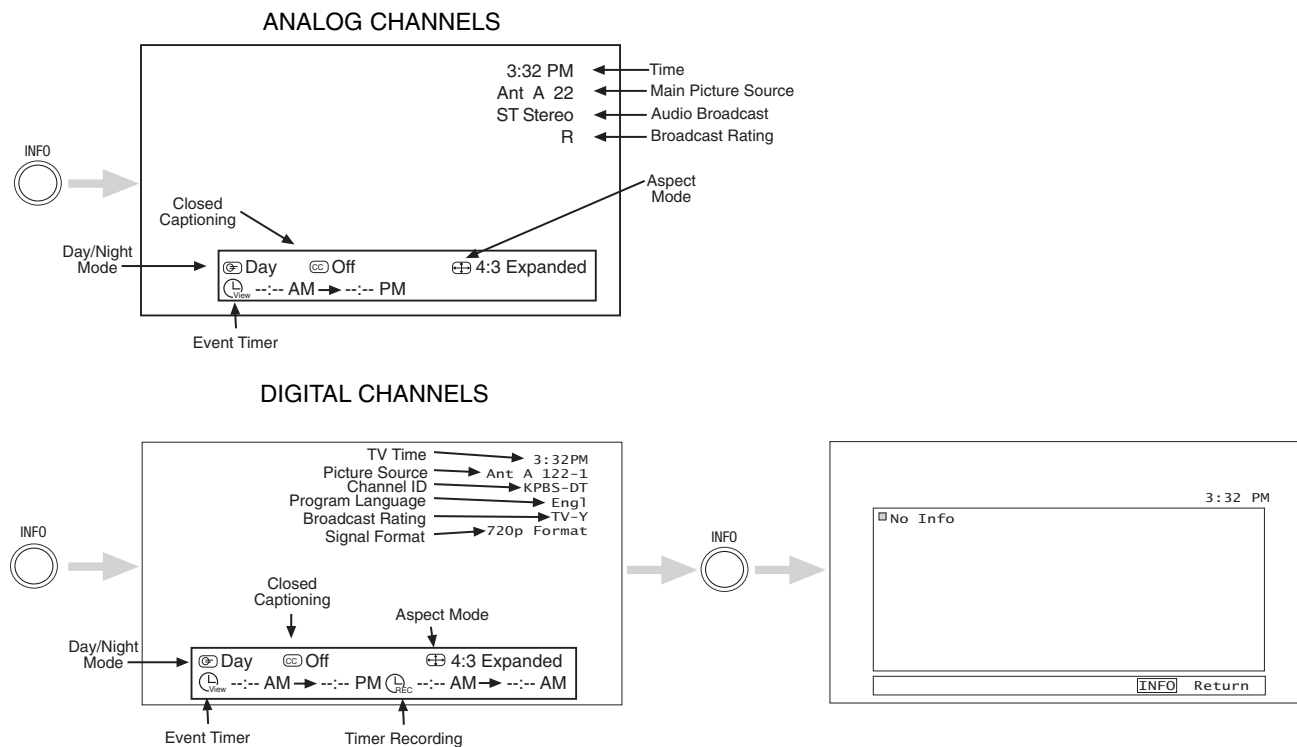

NOTES:

1. The Sleep Timer info will show momentarily after releasing INFO button.
2. Press the INFO button again or the EXIT button to return to normal viewing.

THE REMOTE CONTROL

HOW TO USE THE REMOTE TO CONTROL YOUR LCD REAR PTV



16 VOLUME (VOL) WHEEL, MUTE button

Use the VOL WHEEL (▲ or ▼) until you obtain the desired sound level.

To reduce the sound to one half of normal volume (SOFT MUTE) to answer the telephone, etc., press the VOL wheel down. Press the VOL wheel again to turn the sound off completely (MUTE). To restore the sound, press the VOL wheel one more time, or VOL Up (▲).



Closed Captioning will display automatically when MUTE/SOFT MUTE is on and Closed Caption is set to AUTO (see page 77).

When the TV power is turned off at a volume level 31 or greater, the volume level will default to 30 when the TV is turned on. However, if it is set to a level 30 or less, the volume level will be at the level it was set when the TV is turned ON.

17 CHANNEL (CH) WHEEL/CHANNEL SELECTOR buttons

The CHANNEL wheel or the CHANNEL SELECTOR buttons are used to select channels, lock access code, etc. Use the CHANNEL WHEEL (▲ or ▼) to select the desired channel. Use the CHANNEL SELECTOR buttons to enter one, two, or three numbers to select channels. Enter "0" first for channels 1 to 9, or simply press the single digit channel you wish to tune then wait a few seconds for the TV to tune. For channels 100 and above, use the CHANNEL SELECTOR buttons with the (-) DASH button. Channel selection may also be performed by CHANNEL WHEEL up (▲) or CHANNEL WHEEL down (▼).

Press the channel (CH) wheel to switch to Favorite (FAV) channel mode. You will know you are in Favorite Channel mode when (FAV) is displayed and the displayed channel is GREEN. Press it again to return to your regular tuned channels. You can add any channel to your Favorite channel list by pressing and holding down the Channel (CH) wheel until the displayed channel turns from WHITE to highlighted GREEN. You can also delete a channel from your favorite channel list by pressing and holding down the Channel (CH) wheel until the displayed channel turns highlighted GREEN to WHITE.



18 (-) DASH button

Use the (-) DASH button with the CHANNEL SELECTOR buttons to enter Digital Channels that have subchannel numbers indicated by (-) DASH (example 15-1).

19 LAST CHANNEL (LC) button

Press this button to toggle between the current and last channel viewed.



PICTURE-IN-PICTURE (PIP)

Your HITACHI LCD Rear PTV incorporates Two Tuner technology designed for improved viewing enjoyment. This Two Tuner feature allows you to view antenna inputs on both the main picture and sub-picture simultaneously, with separate tuning control for each.

ANT A input can be viewed as both the main picture and the sub-picture simultaneously. ANT B can only be viewed as a main picture. To select between main picture and PIP sub-picture tuning, use the CURSOR PAD on the remote. The green highlighted channel display will move with every press of the CURSOR PAD (◀, ▶).

The Picture-in-Picture feature is convenient when you want to watch more than one program at the same time. You can watch a TV program while viewing other programs from any of the video inputs.

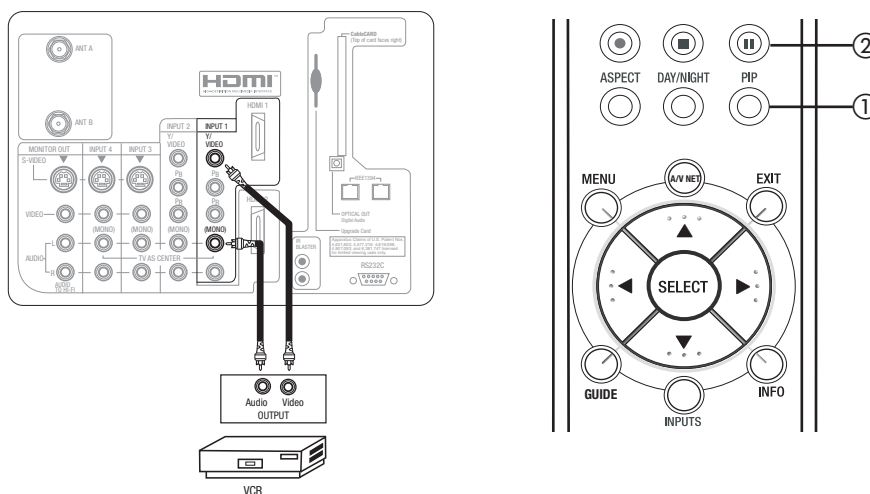

Use above connection to view VCR program as a sub-picture while viewing another program as main picture (ANT A, ANT B, INPUT:2, INPUT:3, INPUT:4, or INPUT:5). You may also view the VCR program as a main picture while viewing another program as a sub-picture (ANT A, INPUT:2, INPUT:3, INPUT:4 or INPUT:5).

When installing a CableCARD, connect your coaxial cable to ANT A (see page 13). ANT B will not be available while using a CableCARD.

① PIP button

Press the PIP button and a sub-picture will appear in one of the four different modes (POP, PIP, SPLIT or SURF), depending on the INPUT signal. To change the PIP mode, use the PIP button to cycle through the four different modes.

POP MODE PICTURE-IN-PICTURE

POP Mode PIP displays the sub-picture outside of the main picture. Use the CURSOR PAD (▲, ▼) to move the sub-picture. This feature is not available with a 1080i component input or Digital signal 16x9 Format. Please refer to the PICTURE-IN-PICTURE MODES Table (see page 40).

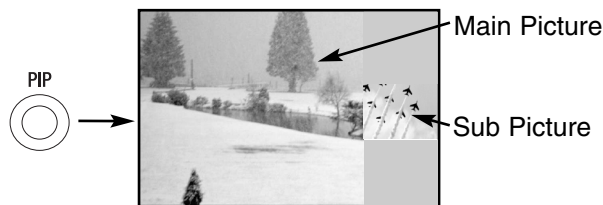

- NOTES:**
1. Digital Channels cannot be viewed as a sub-picture.
 2. PIP MODE Picture-in-Picture is only available with a 1080i component or digital signal 4x3 Format.
 3. Press the CURSOR PAD (◀, ▶) to enable the sub-picture sound.
 4. Sub-picture channel availability depends on the channel list.

THE REMOTE CONTROL



PICTURE-IN-PICTURE (PIP)

PIP MODE PICTURE-IN-PICTURE

This feature is only available with a 1080i component input or Digital signal 16x9 Format.

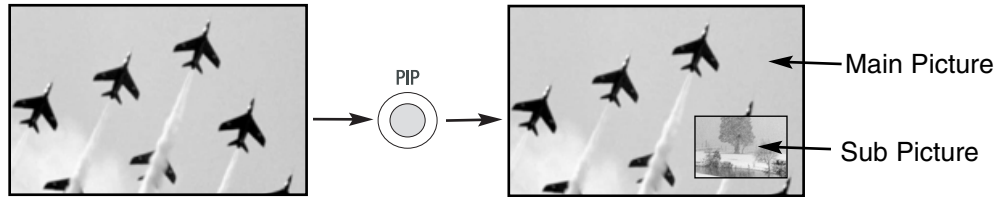

SPLIT MODE PICTURE-IN-PICTURE

Split Mode PIP displays the main picture and sub-picture evenly on the screen.



THE REMOTE CONTROL

SURF MODE PICTURE-IN-PICTURE

Surf Mode PIP automatically scans all active channels (those set in memory) and displays them as PIP sub-pictures or Thumbnail channels. Press the SELECT button to stop on a chosen channel. Use the remote CURSOR PADS (◀, ▶, ▲, ▼) to navigate the Thumbnail. Press the EXIT button to enable your chosen channel and return to normal viewing.



NOTE: Press the SELECT button to stop the Surf mode or channel scan. Press the SELECT button again to resume Surf mode or channel scan.

PICTURE-IN-PICTURE (PIP) MODES

PIP Mode	Sub		NTSC	480i	480p	720p	1080i
	Main						
POP	NTSC		Yes	Yes	-	-	Yes
	480i		Yes	Yes	-	-	Yes
	Digital		Yes	Yes	-	-	Yes
PIP 4x3	1080i		Yes	Yes	-	-	-
PIP 16x9	1080i Digital		Yes	Yes	-	-	Yes
SPLIT	NTSC		Yes	Yes	Yes	Yes	Yes
	480i		Yes	Yes	Yes	Yes	Yes
	480p		Yes	Yes	Yes	Yes	Yes
	720p		Yes	Yes	Yes	Yes	Yes
	1080i Digital		Yes	Yes	Yes	Yes	Yes
12 Pix	-	Ant A/B	-	-	-	-	-



PICTURE-IN-PICTURE (PIP)

② PAUSE button

If you wish to freeze the sub-picture, press the PAUSE button. This is convenient when trying to write down the address for a mail order company, recording statistics for a sporting event, etc. To return the picture to motion, press the EXIT button. Press the PAUSE button repeatedly to toggle between FREEZE modes (Main Freeze, SPLIT and STROBE).

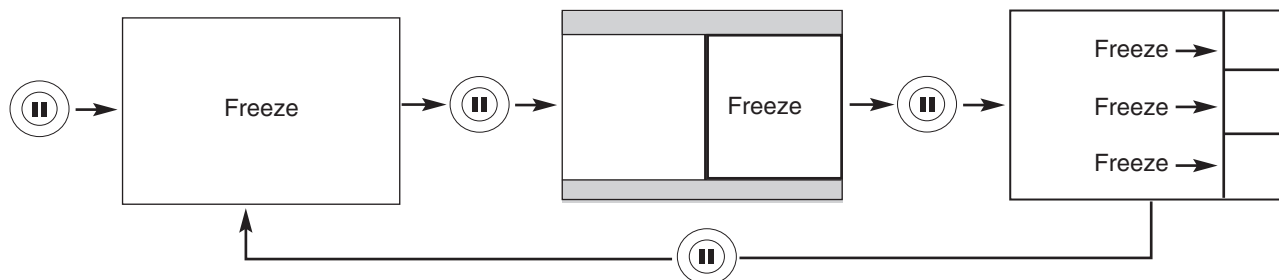

MAIN FREEZE

Press the PAUSE button to freeze one frame of the picture you are currently viewing and the frozen frame will show in the Main Picture. Press the EXIT button to return to normal viewing. This feature is useful for freezing a picture frame with addresses.

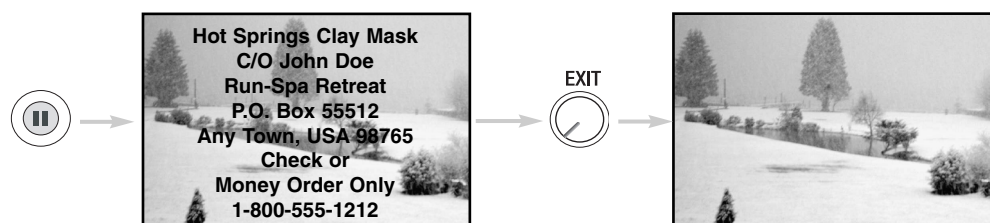

SPLIT FREEZE

Press the PAUSE button to freeze the picture you are currently viewing (only the right sub-picture will freeze). Press the EXIT button to return to normal viewing.

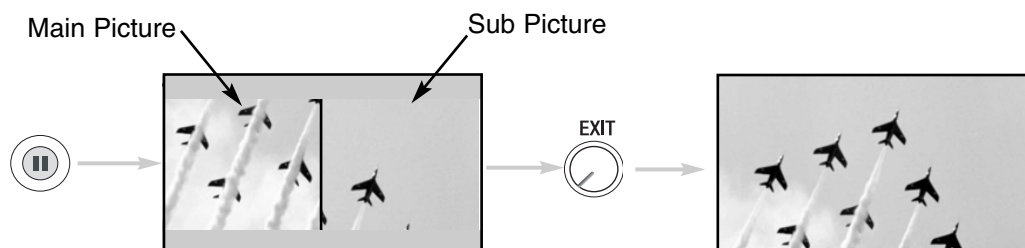

STROBE FREEZE

Press the PAUSE button to freeze three frames of the picture you are currently viewing (only the 3 sub-pictures will freeze). Press the EXIT button to return to normal viewing. This feature is useful for viewing a moving picture that has many details, for example, a close play in a sporting event or a golf swing.

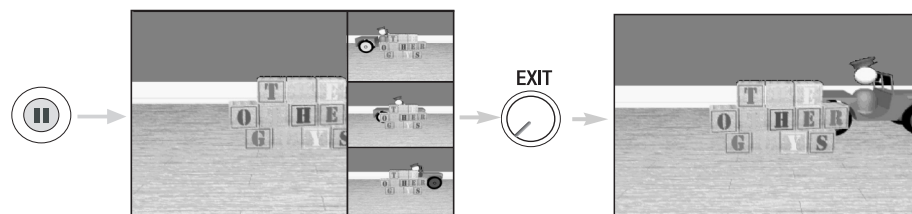

- NOTES:**
1. The default FREEZE mode is the MAIN freeze followed by the SPLIT freeze and then the STROBE freeze. The last Freeze mode you selected before you pressed the EXIT button will be the one that comes up after pressing the PAUSE button again.
 2. Each freeze frame is delayed about 0.1 (1/10) second.
 3. Strobe Freeze is not available in 480p/720p/1080i inputs.

THE REMOTE CONTROL



USING THE REMOTE TO CONTROL CABLE BOX FUNCTIONS

Operating the precoded function for your cable box.

This remote is designed to operate different types of cable boxes. You must first program the remote to match the remote system of your cable box (refer to pages 49-50 for pre-codes).

1. Turn ON your cable box.
2. Aim the remote control at the front of your cable box.
3. To switch to Cable (CBL) pre-coded mode, use the SOURCE ACCESS buttons (◀, ▶) on the remote control to position the LED light to the corresponding selection.
4. Hold down the ENT button on the remote and enter the four digit preset code that matches your cable box as shown on pages 49-50. Release the ENT button. The indicator light will flash 3 times if the code was accepted.
5. Aim the remote at the cable box and press the POWER button. The remote will turn off your cable box when the correct four digit preset code is entered. When this occurs, the remote control is programmed for your cable box. If the cable box does not turn off, try a different four digit preset code.
6. The remote will now control your Cable box.

THE REMOTE CONTROL

NOTES:

1. If your cable box cannot be operated after performing the above procedures, your cable box code has not been precoded into the remote.
2. In the unlikely event that your cable box cannot be operated after performing the above procedures, please consult your cable box operating guide.
3. The remote control will remember the codes you have programmed until the batteries are removed from the remote control. After replacing the batteries repeat the entire programming procedure as stated above.

- ① **PRECODED CABLE BOX buttons**
These buttons transmit the chosen precoded cable codes.
- ② **EXCLUSIVE TV buttons**
These buttons are for operating the TV.

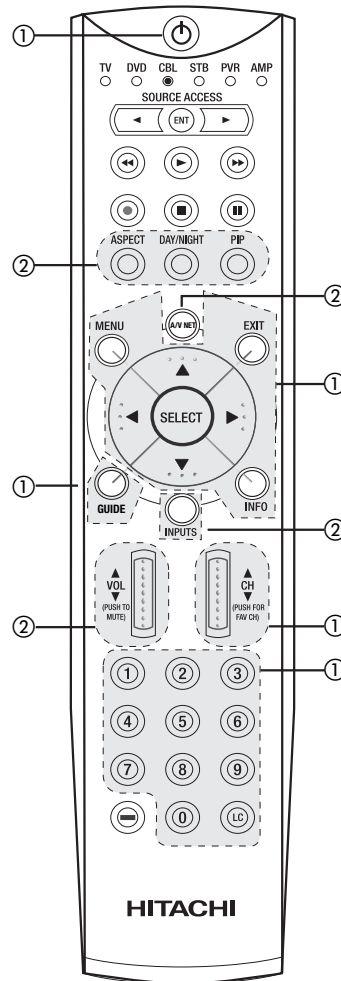

MY CABLE BOX CODE IS: _____

NOTE: Refer to instruction manual of the Cable Box for operation of the buttons exclusively for the Cable Box.

USING THE REMOTE TO CONTROL SET-TOP-BOX/SATELLITE RECEIVER FUNCTIONS



Operating the precoded function for your set-top-box/satellite receiver.

This remote is designed to operate different types of set-top-box/satellite systems. You must first program the remote to match the remote system of your set-top-box/satellite systems (refer to pages 49-50 for pre-codes).

1. Turn ON your set-top-box/satellite systems.
2. Aim the remote control at the front of your set-top-box/satellite systems.
3. To switch to set-top-box/satellite (STB) pre-coded mode, use the SOURCE ACCESS buttons (◀, ▶) on the remote control to position the LED light to the corresponding selection.
4. Hold down the ENT button on the remote and enter the four digit preset code that matches your set-top-box/satellite receiver as shown on page 49-50. Release the ENT button. The indicator light will flash 3 times if the code was accepted.
5. Aim the remote at the set-top-box/satellite receiver and press the POWER button. The remote will turn off your set-top-box/satellite receiver when the correct four digit preset code is entered. When this occurs, the remote control is programmed for your set-top-box/satellite receiver. If the set-top-box/satellite receiver does not turn off, try a different four digit preset code.
6. The remote will now control your set-top-box/satellite receiver.

NOTES:

1. If your set-top-box/satellite receiver cannot be operated after performing the above procedures, your set-top-box/satellite receiver code has not been precoded into the remote.
2. In the unlikely event that your set-top-box/satellite receiver cannot be operated after performing the above procedures, please consult your set-top-box/satellite receiver operating guide.
3. The remote control will remember the codes you have programmed until the batteries are removed from the remote control. After replacing the batteries repeat the entire programming procedure as stated above.

① PRE-CODED SET-TOP-BOX/SATELLITE RECEIVER buttons

These buttons transmit the chosen pre-coded set-top-box/satellite codes.

② EXCLUSIVE TV buttons

These buttons are for operating the TV.

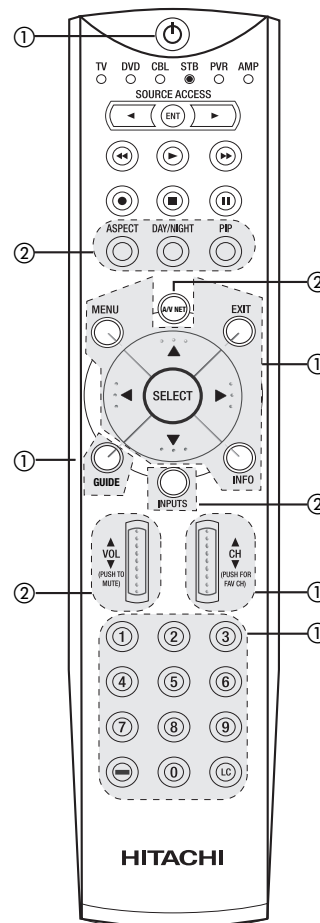

THE REMOTE CONTROL

MY SATELLITE RECEIVER/STB CODE IS: _____

NOTE: Refer to instruction manual of the set-top-box/satellite receiver for operation of the buttons exclusively for the set-top-box/satellite receiver.



USING THE REMOTE TO CONTROL DVD FUNCTIONS

Operating the precoded function for your DVD player.

This remote is designed to operate different types of DVD players. You must first program the remote to match the remote system of your DVD player (refer to pages 49-50 for pre-codes).

1. Turn ON your DVD player.
2. Aim the remote control at the front of your DVD player.
3. To switch to DVD pre-coded mode, use the SOURCE ACCESS buttons (◀, ▶) on the remote control to position the LED light to the corresponding selection.
4. Hold down the ENT button on the remote and enter the four digit preset code that matches your DVD player, as shown on pages 49-50. Release the ENT button. The indicator light will flash 3 times if the code was accepted.
5. Aim the remote at the DVD player and press the POWER button. The remote will turn off your DVD player when the correct four digit preset code is entered. When this occurs, the remote control is programmed for your DVD player. If the DVD player does not turn off, try a different four digit preset code.
6. The remote will now control your DVD player.
7. You will need to set the display type of your DVD player to 16:9 widescreen.

THE REMOTE CONTROL

NOTES:

1. If your DVD player cannot be operated after performing the above procedures, your DVD player's code has not been precoded into the remote.
2. In the unlikely event that your DVD player cannot be operated after performing the above procedures, please consult your DVD player operating guide.
3. The remote control will remember the codes you have programmed until the batteries are removed from the remote control. After replacing the batteries repeat the entire programming procedure as stated above.

- ① **PRECODED DVD Buttons**
These buttons transmit the chosen precoded DVD codes.
- ② **EXCLUSIVE TV Buttons**
These buttons are for operating the TV.

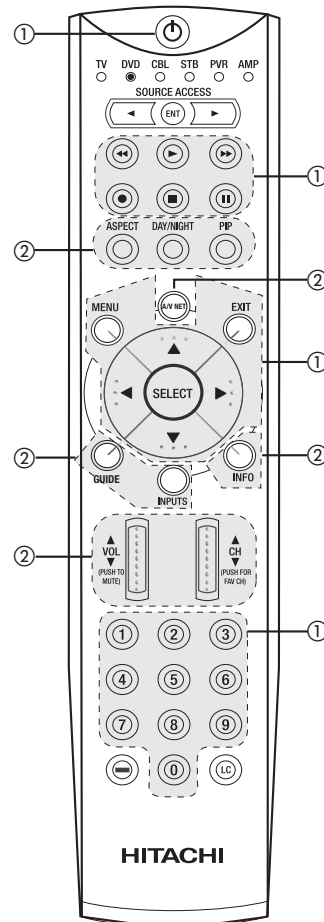

MY DVD PLAYER CODE IS: _____

NOTE: Refer to instruction manual of the DVD player for operation of the buttons exclusively for the DVD player.

USING YOUR REMOTE TO CONTROL VCR/PVR FUNCTIONS



Operating the precoded function for your VCR/PVR (Personal Video Recorder).

This remote is designed to operate different types of VCRs/PVRs. You must first program the remote to match the remote system of your VCR/PVR (refer to pages 49-50 for pre-codes).

1. Turn ON your VCR/PVR.
2. Aim the remote control at the front of your VCR/PVR.
3. To switch to VCR/PVR pre-coded mode, use the SOURCE ACCESS buttons (◀, ▶) on the remote control to position the LED light to the corresponding selection.
4. Hold down the ENT button on the remote and enter the four digit preset code that matches your VCR/PVR, as shown on pages 49-50. Release the ENT button. The indicator light will flash 3 times if the code was accepted.
5. Aim the remote at the VCR/PVR and press the POWER button. The remote will turn off your PVR when the correct four digit preset code is entered. When this occurs, the remote control is programmed for your VCR/PVR. If the VCR/PVR does not turn off, try a different four digit preset code.
6. The remote will now control your VCR/PVR.

NOTES:

1. If your PVR cannot be operated after performing the above procedures, your PVR's code has not been precoded into the remote.
2. In the unlikely event that your PVR cannot be operated after performing the above procedures, please consult your PVR operating guide.
3. The remote control will remember the codes you have programmed until the batteries are removed from the remote control. After replacing the batteries repeat the entire programming procedure as stated above.
4. VCR precode library is included in the PVR mode. Default device for this mode is Hitachi VCR.
5. INFO, GUIDE and LC (Last Channel) buttons are for PVR devices, not for VCR.

① **PRECODED VCR/PVR Buttons**
These buttons transmit the chosen precoded VCR/PVR codes.

② **EXCLUSIVE TV Buttons**
These buttons are for operating the TV.

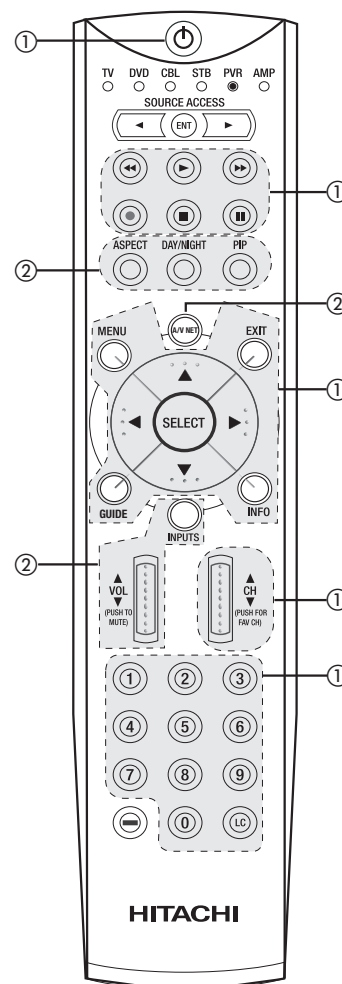

THE REMOTE CONTROL

MY VCR/PVR CODE IS: _____

NOTE: Refer to instruction manual of the VCR/PVR for operation of the buttons exclusively for the VCR/PVR.



USING YOUR REMOTE TO CONTROL ADDITIONAL AUDIO EQUIPMENT

Operating the precoded function for your Audio component.

This remote is designed to operate different types of Audio component. You must first program the remote to match the remote system of your Audio component (refer to pages 49-50 for pre-codes).

1. Turn ON your Audio component you wish to control with the Remote.
2. Aim the remote control at the front of your Audio component.
3. To switch to Audio (AMP) component pre-coded mode, use the SOURCE ACCESS buttons (◀, ▶) on the remote control to position the LED light to the corresponding selection.
4. Hold down the ENT button on the remote and enter the four digit preset code that matches your Audio component, as shown on pages 49-50. Release the ENT button. The indicator light will flash 3 times if the code was accepted.
5. Aim the remote at the Audio component and press the POWER button. The remote will turn off your Audio component when the correct four digit preset code is entered. When this occurs, the remote control is programmed for your Audio component. If the Audio component does not turn off, try a different four digit preset code.
6. The remote will now control your Audio component.
7. Repeat steps 1 - 6 if you wish to program the remote to control another Audio component.

THE REMOTE CONTROL

NOTES:

1. If your Audio component cannot be operated after performing the above procedures, your Audio component's code has not been precoded into the remote.
2. In the unlikely event that your Audio component cannot be operated after performing the above procedures, please consult your Audio equipment operating guide.
3. The remote control will remember the codes you have programmed until the batteries are removed from the remote control. After replacing the batteries repeat the entire programming procedure as stated above.
4. CD precode library is included in the AMP mode. Default device for this mode is Hitachi Audio/Video Receiver (AVR/AMP).
5. INPUT, GUIDE, Channel (up/down), Volume (up/down) and REC button are not for CD devices.

- ① **PRECODED AUDIO Buttons**
These buttons transmit the chosen precoded Audio component codes.
- ② **EXCLUSIVE TV Buttons**
These buttons are for operating the TV.

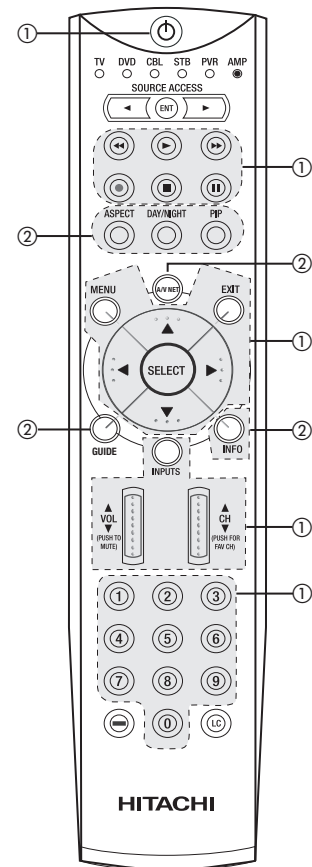

MY AUDIO EQUIPMENT CODE IS:

CD _____

AMP/RCVR _____

- NOTES:**
1. The REC (Record) button only applies to some precoded amplifier/receiver codes.
 2. Refer to instruction manual of the Audio equipment for operation of the buttons exclusively for the Audio equipment.

USING YOUR REMOTE “ENT” BUTTON TO ACCESS THE SPECIFIED INPUT OF THE TV



INPUT ACCESS

This optional feature allows the user of the remote control to setup its ENTER (ENT) button to access the specified input of the TV. Setup for this feature is applicable to the remote control's normal mode only and only applies to the DVD, CBL, STB, PVR and AMP modes.

1. Select the desired device mode (DVD, CBL, STB, PVR, or AMP) by using your SOURCE ACCESS buttons (◀, ▶) to position the LED indicator to the corresponding selection.
2. Hold down the ENTER (ENT) button on the remote and enter the four digit preset code that matches your device as shown on pages 49-50.
3. Then enter the assigned input number (1-5) that the device is related to.
4. Release ENTER (ENT) button.
5. If done correctly, the device LED indicator will flash 3 times to confirm proper setup.
6. The remote will now control the desired device.
7. Pressing the ENTER (ENT) button will now access the video input (1-5) of the desired device.

SETUP EXAMPLE (Hitachi DVD with precode 0573 connected to INPUT 1 of the TV)

- ① Select DVD mode by using your SOURCE ACCESS buttons (◀, ▶) to position the LED indicator to DVD.
- ② Hold down the ENTER (ENT) button and press the numbers 0, 5, 7 and 3.
- ③ Then press the number 1 for the assigned input number of the DVD player.
- ④ Release ENTER (ENT) button.
- ⑤ If done correctly, the device LED indicator will flash 3 times to confirm proper setup.
- ⑥ The remote will now control the DVD player.
- ⑦ Press the ENTER (ENT) button to instantly access the video input of your DVD on Input 1.

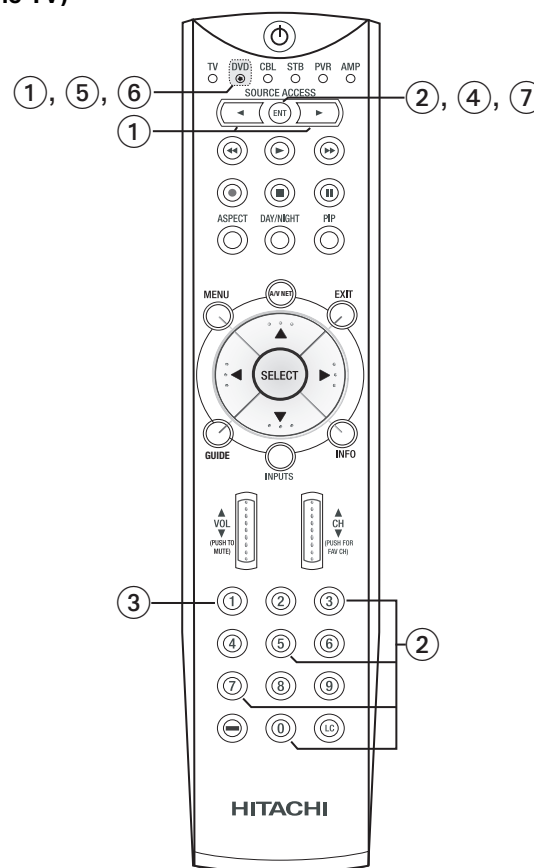

THE REMOTE CONTROL

- NOTES:**
1. This feature is optional.
 2. Assigned input numbers can be used more than once if applicable.



HITACHI has provided a second remote control for your convenience. The Simple Remote Control has the basic features that are most often used.

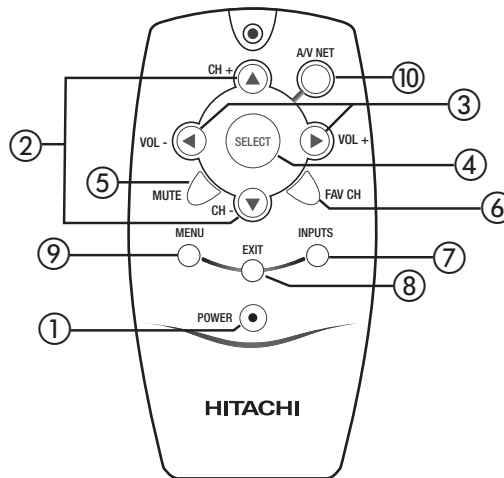

(Patent Pending)

THE REMOTE CONTROL

- ① **POWER button**
Press Power button to turn the LCD Rear PTV ON or OFF.
- ② **CH+ (▲), CH- (▼)**
Press the CH+ (▲) up or CH- (▼) down buttons to select desired channel or to navigate the on screen display features when in AV NET mode.
- ③ **VOL- (◀), VOL+ (▶)**
Press the VOL- (◀) down or VOL+ (▶) up buttons to select desired sound level or to navigate the on screen display features when in AV NET mode.
- ④ **SELECT button**
Press SELECT button to Select when in MENU and AV NET mode.
- ⑤ **MUTE button**
To reduce the sound to one half of normal volume (SOFT MUTE) to answer the telephone, etc., press the MUTE button. Press the MUTE button again to turn the sound off completely (MUTE). To restore the sound, press the MUTE button one more time, or press the VOLUME Up (▶) button.
- ⑥ **FAV CH button**
Press FAV CH button to access your favorite channels.
- ⑦ **INPUTS button**
Pressing the INPUTS button repeatedly will cycle through the input items (see example on page 33).
- ⑧ **EXIT button**
When in MENU mode, this button will exit all On-Screen Displays.
- ⑨ **MENU button**
Press the MENU button to start the On-Screen Display.
- ⑩ **AV NET button**
Press this button to access the Audio/Video network (AV Net) menu. The AV Net allows the user to control external components with the TV's remote control. (See complete explanation and example on pages 31-32)

NOTE: The Simple Remote cannot be programmed to control external components.

ON-SCREEN DISPLAY (OSD)

1. Press MENU on the remote control to display the different features on your HITACHI LCD TV.
2. Press the CURSOR PAD to highlight a different feature.
3. Press EXIT on the remote control to quickly exit from a menu.

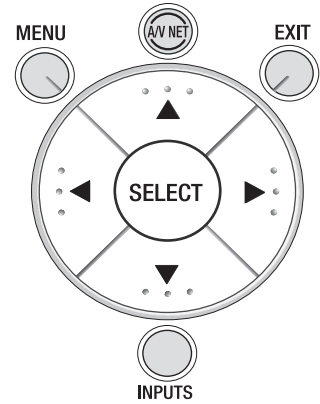

This part of the screen shows which selections are available.

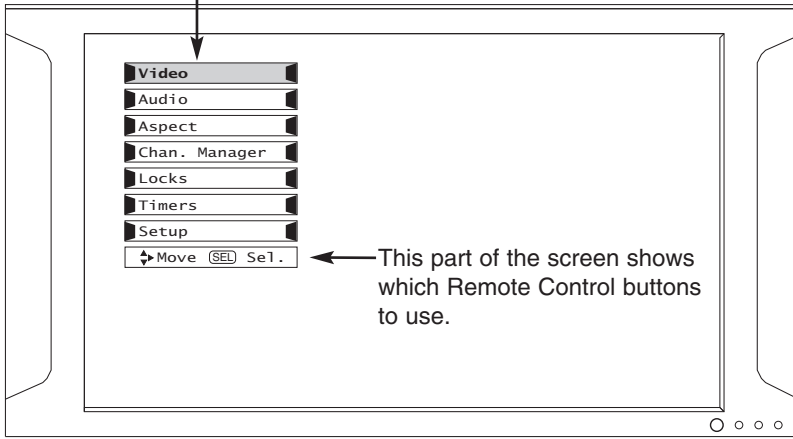

This part of the screen shows which Remote Control buttons to use.

ON-SCREEN DISPLAY (OSD)

Video

Picture Mode	Select between the two picture modes; Day and Night.
Contrast	Adjust contrast.
Brightness	Adjust brightness.
Color	Adjust color.
Tint	Adjust tint.
Sharpness	Adjust sharpness.
Color Temperature	Set this to High for less intense color with more blue, set to Medium for natural color, set to Standard for standard colors or Black and White for more reddish color.
Black Enhancement	Adjust shadow detail in dark screens.
Contrast Mode	Choose Automatic Contrast settings.
Reset Video Settings	Choose the Reset Video settings.
Color Management	Adjust and balance individual colors to make either deeper or more pure according to preference.
Color Decoding	Adjust the percentage of Red, Green and Color according to preference.
Auto Color	The AUTO COLOR function automatically monitors and adjusts the color to maintain constant color levels even after a program or channel changes. It also maintains natural flesh tones while preserving fidelity of background colors.
Noise Reduction	Reduces conspicuous noise in the picture.
Auto Movie Mode	Turn ON/OFF the 3:2 Pulldown detection feature.

Audio

Treble	Adjust the treble.
Bass	Adjust the bass.
Balance	Adjust the balance.
SRS	Select SRS settings (Off, Wide, Normal)
BBE	Select BBE settings (Off, Soft, Hard)
Audio Source	Select between three Audio Sources.
Internal Speakers	Select internal or external speakers.
Auto Noise Cancel	Eliminates the noise between stations.
Perfect Volume	Adjust volume in fixed setting.
Loudness	Adjust Loudness.
Language	Select Language options if available.
Digital Output	Select Optical Output options.
DRC	Select Dynamic Range Compression to ON or OFF.

Aspect

4:3 Standard	Choose the picture format aspect ratio.
4:3 Expanded	
4:3 Zoom 1	
4:3 Zoom 2	
16:9 Standard	
16:9 Zoom	

NOTE: The Language, Digital Output, and the Dynamic Range Compression feature of the Audio OSD are only available for Digital channels.

ON-SCREEN DISPLAY (OSD)

Channel Manager	Set the Antenna	Set Antenna settings.
	Auto Channel Scan	Set Auto Channel Scan.
	Signal Meter	Access Signal Meter.
	Channel List	Set Channel List.
Locks	Change Access Code	Change Lock access code.
	Engage Lock	Choose to lock channel, video input, and/or front panel.
	TV Time Lock	Set specific time to Lock TV.
	Movie Ratings	Block various types of movies and video types based on motion picture ratings.
	TV Ratings	Block various types of movies and television programming based on a parental guide ratings.
	Canadian Ratings (ENG)	Block various types of movies and television programming based on the Canadian ratings system.
Timers	Canadian Ratings (FRN)	Block various types of movies and television programming based on the Canadian French ratings system.
	Set the Clock	Set Clock Settings.
	Set Sleep Timer	Set Sleep Timer intervals (30 min. intervals, 00:30-3:00).
	Set Day/Night Timer	Set Day/Night picture mode settings.
	Set Event Timer	Set viewing reservation for TV programs.
	Set Timer Recording	Set Timer Recording for IEEE1394 devices.
Setup	Set Auto Power Off	Set TV to turn off automatically when a video signal is not detected for 15 minutes.
	Menu Preference	Choose English, French, or Spanish text.
	Screen Saver	Set the Screen Saver.
	Set The Inputs	Label Video Inputs , VCR, DVD, etc.
	Set Black Side Panel	Set the gray side bars on/off when watching 4:3 signals in standard mode.
	Set Closed Captions	Feature to display dialogue/text.
	Set Monitor Out	Set Monitor Out source.
	CableCARD Info	Select to access CableCARD information.
	Set AV Control	Select to set RS232C feature.
	Upgrades	Select to upgrade TV software.
Set Stand-By Mode	Set the IEEE1394 function in Stand-By.	

- NOTES:**
1. The Signal Meter feature of the Channel Manager OSD is only available for ATSC signals.
 2. The CableCARD information feature of the Setup OSD is only available when a CableCARD from your cable operator is installed in the rear panel of the TV.

Video

Select VIDEO to adjust picture settings and improve picture quality. You can independently customize each of the Video Inputs to your preference to increase viewing performance and pleasure depending upon the video program being viewed. If RESET is selected, only the selected input will reset to initial conditions.

Picture Mode

Use this function to choose from automatic picture settings to optimize your TV's performance.

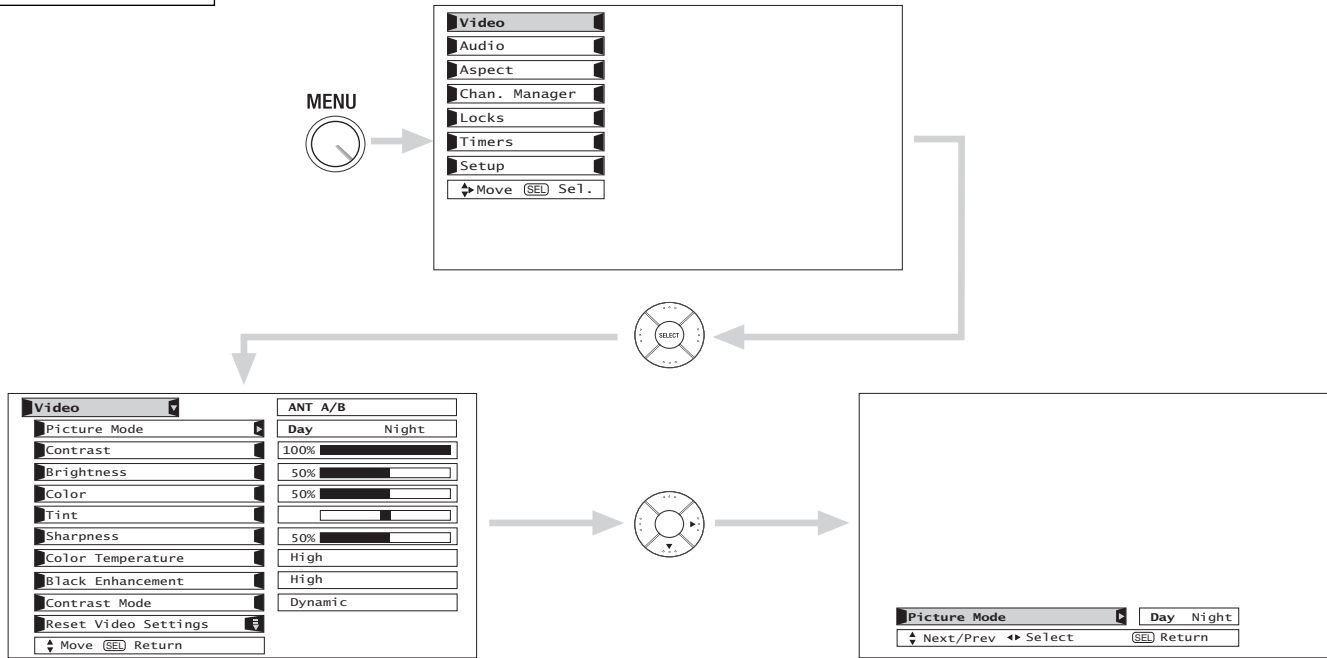

Use CURSOR PAD ◀ or ▶ to highlight and select Picture Mode settings.

Function	Day	Night	Reset
Contrast	100%	90%	Reset the video menu settings on current input to the Day or Night conditions depending on the selected VIDEO mode.
Brightness	50%	50%	
Color	50%	30%	
Tint	50%	50%	
Sharpness	50%	30%	
Color Temperature	High	Standard	
Black Enhancement	Middle	Off	
Contrast Mode	Normal	Normal	
Auto Color	Off	Off	
Noise Reduction	Low	Low	
Color Management (Set User Colors)	Off	Off	
Auto Movie Mode (TV/Cinema Detection)	Off	Off	

Press EXIT to quit menu or select PICTURE MODE to return to previous menu.

VIDEO

Use the CURSOR PAD ▲ or ▼ to highlight the function to be adjusted.
Press the CURSOR PAD ◀ or ▶ to adjust the function. Press the SELECT button to select the function settings.
Press MENU to return to main menu or select PICTURE MODE to return to previous menu.
Press EXIT to quit menu.

Contrast	Use this function to change the contrast between black and white levels in the picture.
Brightness	Use this function to adjust overall picture brightness.
Color	Use this function to adjust the level of color in the picture.
Tint	Use this function to adjust flesh tones so they appear natural.
Sharpness	Use this function to adjust the amount of fine detail in the picture.
Color Temperature	Set this to High for cooler color with more blue, set to Medium for more natural color, set to Standard for accurate color or set to Black/White for more reddish color.
Black Enhancement	Use this function to enhance the shadow detail in dark scenes using the settings off, low, middle and high.
Contrast Mode	Use this function to choose between 3 Contrast Mode settings. Set to Dynamic for darker images more in the level of Black, set to Normal for a balanced White to Black level, and set to Auto for automatic Contrast selection.

- NOTES:**
1. If CONTRAST is selected, you are adjusting CONTRAST. The additional menu items BRIGHTNESS, COLOR, TINT, and SHARPNESS can be selected and adjusted in the same manner.
 2. It may be necessary to adjust TINT to obtain optimum picture quality when using the COMPONENT VIDEO Y-PBPR input jacks.
 3. ANT A and B share a Video setting. Also, each of the video inputs have their own independent settings.

Reset Video Settings

This function allows you to Reset the Video Menu Settings of the present input and return it to the Day VIDEO mode.

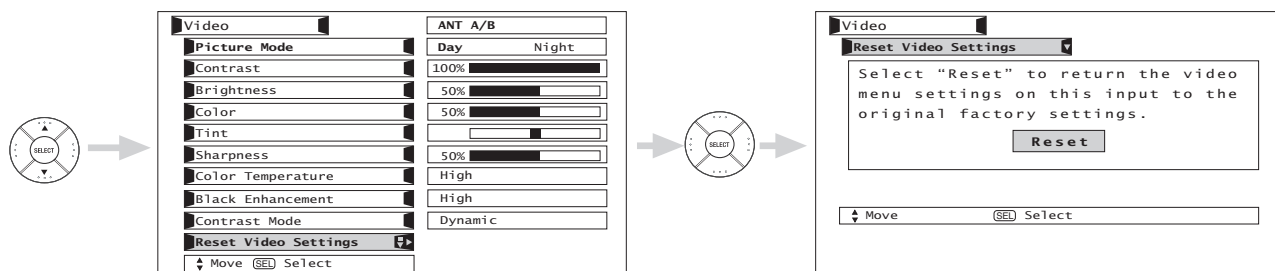

Use CURSOR PAD to highlight functions.
Press the SELECT button to select Reset Video Settings.

Use the CURSOR PAD ▼ to access other video settings.

You can customize each of the Video Inputs to your preference to increase viewing performance and pleasure, depending upon the video program being viewed. If RESET is selected, only the selected Input will reset to the initial conditions as explained above.

If RESET is selected in Video:1 Input, only Video:1 Input will return to factory conditions.

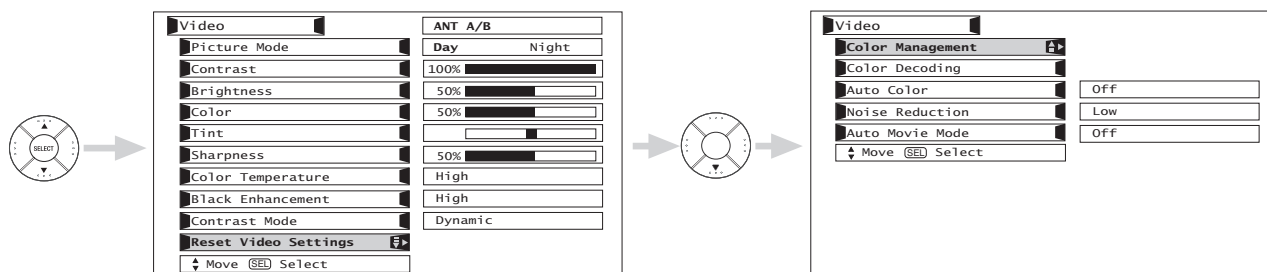

Color Management

Use this function to adjust and balance the listed individual colors to make them either deeper or more pure depending on the user's preference. Adjust the GAIN settings to make the color brighter (+) or darker (-). Adjust the PHASE settings to make the colors deeper (+) or normal (-) to match real life colors.

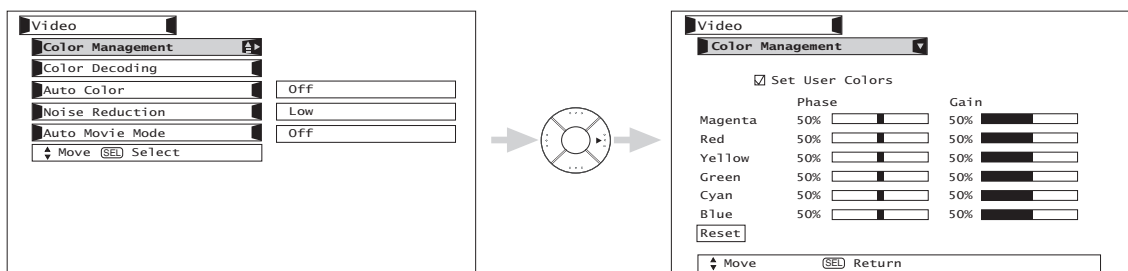

Use the CURSOR PAD to highlight function.
Press the SELECT button to select User Colors setting. When the function has a "✓" in the box, it is ON.
Press the CURSOR PAD ◀, ▶, ▼, ▲, to highlight and adjust individual colors.
Use the CURSOR PAD to highlight and select "Reset" to return all colors to default settings.

NOTE: When the Set User Colors box is not checked, the listed colors will be grayed out.

VIDEO

Color Decoding

Use this function to adjust and balance the percentage of Red, Green and Blue according to the user's preference in each of the four color temperature settings. Use TINT to adjust flesh tones so they appear natural.

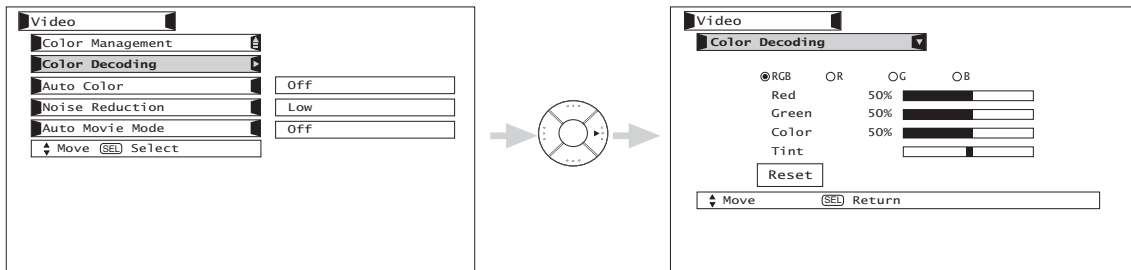

Use the CURSOR PAD to highlight function.

Press down to select from 4 menu items.

Press the CURSOR PAD ◀, ▶, ▼, ▲, to highlight and adjust Red, Green, Color and Tint.

Use the CURSOR PAD to highlight and select "Reset" to return all settings to default.

NOTE: Color Decoding settings are independently stored in each of the 4 Color Temperature settings.

Auto Color

The AUTO COLOR function automatically monitors and adjusts the color to maintain constant color levels even after a program or channel changes. It also maintains natural flesh tones while preserving fidelity of background colors.

NOTES: 1. When using Component, HDMI or DVI input, Auto Color will not be available (grayed out).
2. When using digital channels, Auto Color will not be available (grayed out).

Noise Reduction

The NOISE REDUCTION function automatically reduces conspicuous noise in the picture without degrading picture quality. Set NOISE REDUCTION to OFF if the TV experiences picture blocking.

Auto Movie Mode

The Auto Movie Mode function turns ON or OFF the 3:2 PULLDOWN DETECTION SPECIAL FEATURE. Theatrical movies are shot on film at 24 frames or still pictures per second, instead of 30 frames or 60 fields like video. When film is transferred to video for television viewing, the disparity between the two frame rates must be reconciled. This involves a process known as 3:2 pulldown.

When Auto Movie Mode is turned ON from the VIDEO menu, your Hitachi Projection Television will activate the circuitry for this special feature to improve video performance when watching film based sources.

NOTE: All Video settings are independent of each other based on it's input (ANT A/B, Input 1~5, Photo Input).

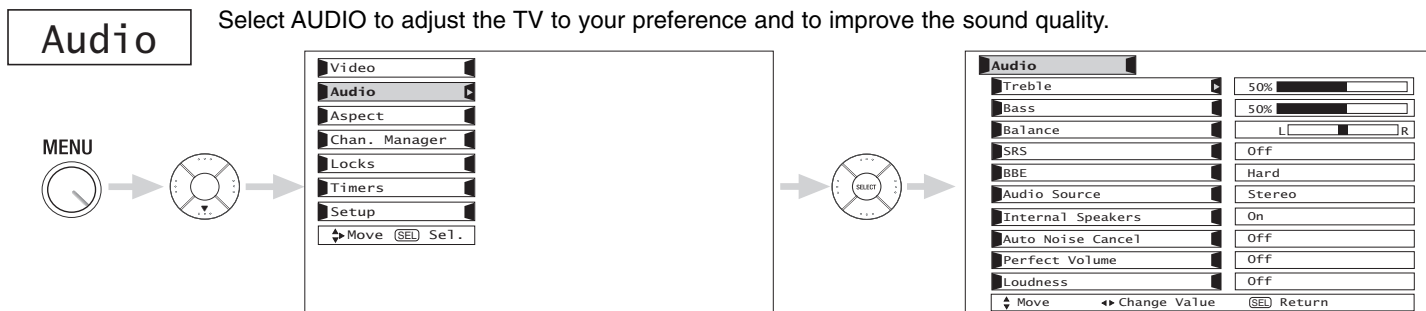

Press CURSOR PAD ▲, ▼, to select menu item.
 Press CURSOR PAD ◀ or ▶ to adjust the function.
 Press EXIT to quit the MENU, or select Audio to return to the main menu.

NOTE: If TREBLE is selected you are adjusting treble. The additional menu items Bass and Balance can be selected and adjusted in the same manner.

Treble

This function controls the high frequency audio to all speakers.

Bass

This function controls the low frequency audio to all speakers.

Balance

This function will control the left to right balance of the Projection TV internal speakers.

SRS



Based on the principles of the human hearing system, SRS 3D technology delivers an exciting and realistic 3D Sound experience from just two external speakers or the two internal speakers found in your HITACHI Television. SRS will also enhance a complete multi-speaker surround sound system.

NOTES: *SRS and the (●) symbol are registered trademarks of SRS Labs, Inc. SRS technology is incorporated under license from SRS Labs, Inc.

BBE

BBE Technology

Sound reproduction quality enhancement system. The BBE technology produces sound that is natural and crisp from just two speakers or the two internal speakers found in your HITACHI television. If your HITACHI television is connected to an external audio system, BBE will also create an incredible crisp sound experience from two speakers. BBE brings to the listener's ear a more complete and accurate reproduction of the original performance. Each voice, speaking or singing, each instrument or sound effect is presented with its attendant harmonics or partials more clearly audible. The ear can then more easily recognize the unique tonal colors of each sound as though the sound was being produced live.

NOTES: Licensed by BBE Sound, Inc. under USP4638258, 5510752 and 5736897. BBE and BBE symbol are registered trademarks of BBE Sound, Inc. Manufactured under license from BBE Sound, Inc.

AUDIO

Audio Source

Multi-Channel Television Sound will allow you to select STEREO (a stereo broadcast), MONO (monaural sound) used when receiving a weak stereo broadcast or 2nd Audio Prog (SAP) which may be a secondary language, weather report, etc.

The sources received will be displayed at the top right edge of the TV. The source you select will be displayed above the sources received. See example below for each selection when both stereo and second audio are received (monaural is always received).

STEREO SELECTED

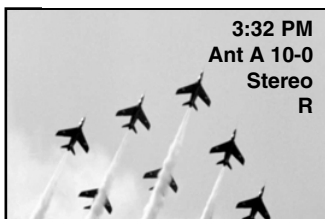

SAP SELECTED

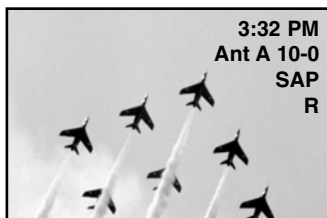

MONO SELECTED

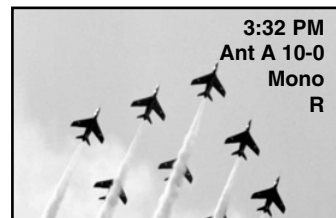

Internal Speakers

This function is useful when setting up the external speakers.

ON - Select this feature if using the internal speakers only.

TV as Center - Select this feature when setting up external speakers from a separate stereo system. The TV's speakers will work as the center speaker.

OFF - Select this feature if you prefer to use only speakers from a separate stereo system.

Auto Noise Cancel

This function eliminates the noise between stations. If a channel is tuned and is noisy, this function will automatically eliminate the audio for that channel.

Perfect Volume

This function will automatically adjust volume so each channel and input has the same average volume level.

Loudness

This function turns loudness ON or OFF. It will improve the quality of both low and high frequency sounds when listening at low volume levels.

Use the functions below if your TV is connected to an amplifier/receiver with optical digital input with Dolby Digital or PCM decoder capabilities.

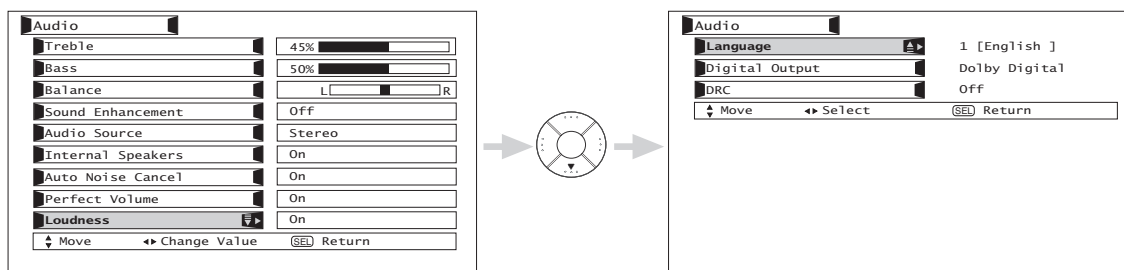

Language

Some programs transmit more than one DTV language option. Most will have English as a default language. The language function will allow you to select up to 4 language options (if available).

Digital Output

This function allows you to select between Dolby® Digital and PCM.

Dolby® Digital - Select this feature if the TV is connected to an amplifier/receiver with a Dolby® Digital only decoder; it will provide six independent soundtrack channels through the optical output jack (Digital Audio).

PCM - Select this feature if the TV is connected to an amplifier/receiver with a PCM only decoder; it will provide two independent soundtrack channels through the optical output jack (Digital Audio).

DRC

Dynamic Range Compression - Use this function to compress the range of sound volume. By compressing the range of sound volume, it is possible not only to suppress the output of loud sound at night but also to raise the volume of low sound. This is only effective when the TV is connected via the optical out (digital audio) to an amplifier/receiver with a Dolby® Digital decoder. The default setting is ON.

Use the CURSOR PAD ◀, ▶ to select the chosen options.

NOTE: *Manufactured under license from Dolby Laboratories. “Dolby” and the double-D symbol are trademarks of Dolby Laboratories.

NOTE: These functions are only available when viewing digital programs.

ASPECT

Aspect

Use this function to select the Picture Format Aspect Ratio.

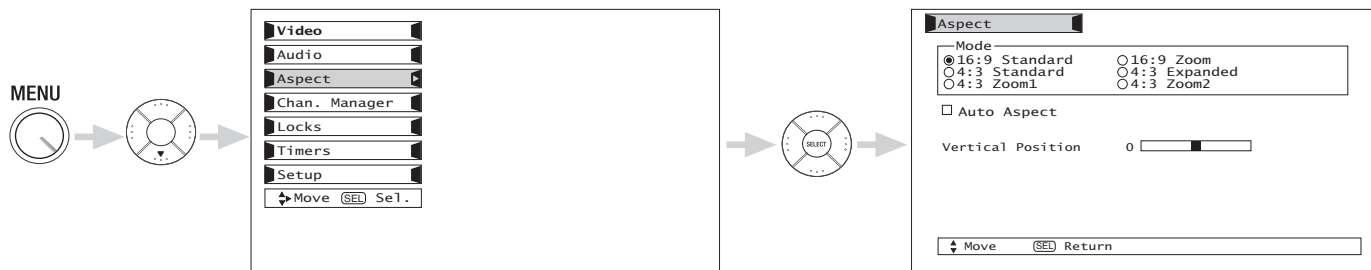

Auto Aspect

Automatically adjust the Aspect Ratio depending on the input signal to fill the screen.

Press THE CURSOR PAD ▲, ▼, ◀, ▶ to select menu item.

Press THE SELECT button to select. A “√” in the box indicates that the feature is ON.

- NOTES:**
1. The Auto Aspect function is recommended on an input signal with VIDEO ID.
 2. The Auto Aspect function is best used on composite video, S-Video, 480i and 480p component signals.
 3. See page 29 for Aspect Mode availability.

Vertical Position

This function allows you to select when aspect style is either 4:3 EXPANDED/ZOOM1/ZOOM2 or 16:9 ZOOM. Vertical position can be changed with these modes. For example, it will be useful for centering the picture area at both the top and bottom of the picture with 480i/480P signal. Adjustable range is -10 (video center is toward bottom of screen) to +10 (video center is toward top of screen).

Press the CURSOR PAD ▲, ▼, to select menu item.

Press the CURSOR PAD ◀ or ▶ to adjust the function.

Press EXIT to quit the MENU, or select Aspect to return to the main menu.

- NOTE:** Vertical Position will not be available in 4:3 Standard and 16:9 Standard modes.

Chan. Manager

Select Channel Manager to set your Antenna options, run Auto Channel Scan, Check Signal Meter and Set Channel List.

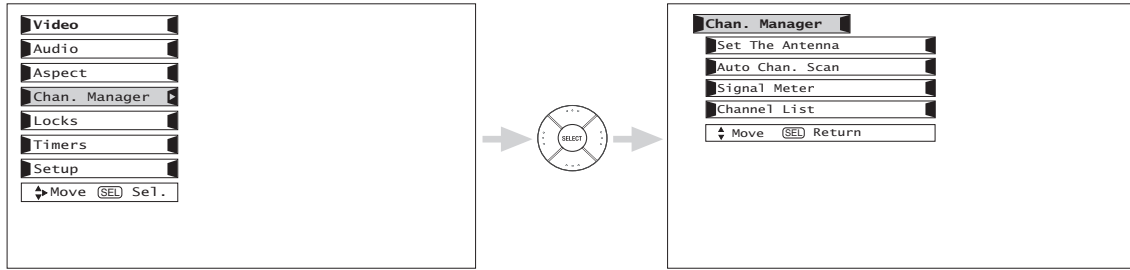

Press CURSOR PAD ▲, ▼ to highlight function, the press the SELECT button to select.

Set The Antenna

This feature will select Antenna options.

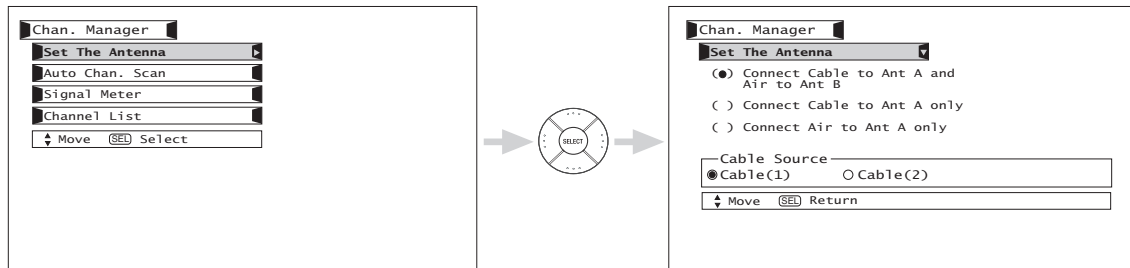

Press CURSOR PAD ▲, ▼ to highlight function, the press the SELECT button to select.

NOTES: 1. When a CableCARD is installed, antenna settings will be set automatically to "Connect Cable to Ant A only".
2. Channels 3 and 4 of Antenna A cannot be set to the Video and Audio inputs when using CableCARD.

Auto Channel Scan

This feature will automatically store active TV channels in Auto Channel Scan memory.

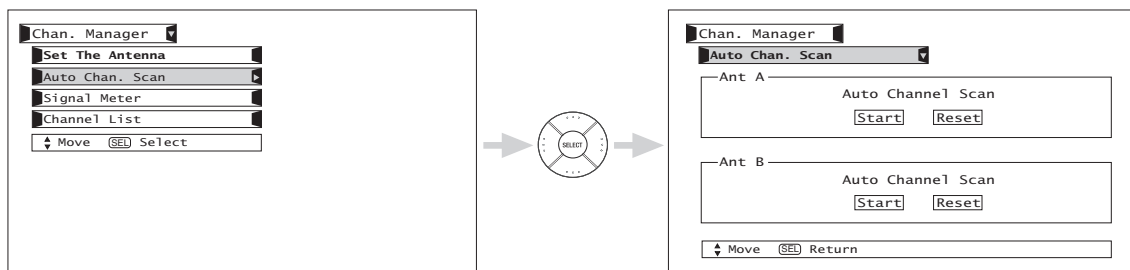

Press CURSOR PAD ▲, ▼, ◀, ▶ to highlight Ant A or Ant B.
Press CURSOR PAD ◀, ▶ to highlight the Start or Clear option.
Press the SELECT button to select.

NOTE: When a CableCARD is installed, Auto Channel Scan will not be available.

CHANNEL MANAGER

Signal Meter

Select Signal Meter when using an indoor or outdoor antenna. This feature will show the signal strength and peak values of the Antenna signal to help you adjust your antenna to optimize signal reception.

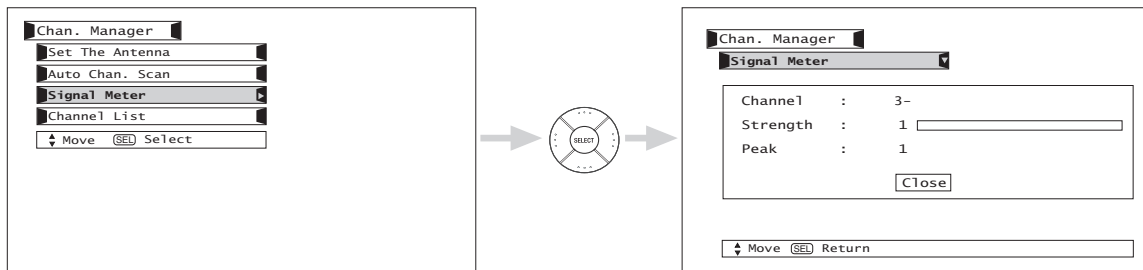

Use the CURSOR PAD and the SELECT button to highlight and select “close” to exit.

NOTE: The Signal Meter will not be available (grayed out) when watching analog channels.

Channel List

This function allows you to review which channels are labeled (CH ID), which have been added to Channel Memory (SCAN), which are protected by LOCK and which are your Favorite (FAV) Channels.

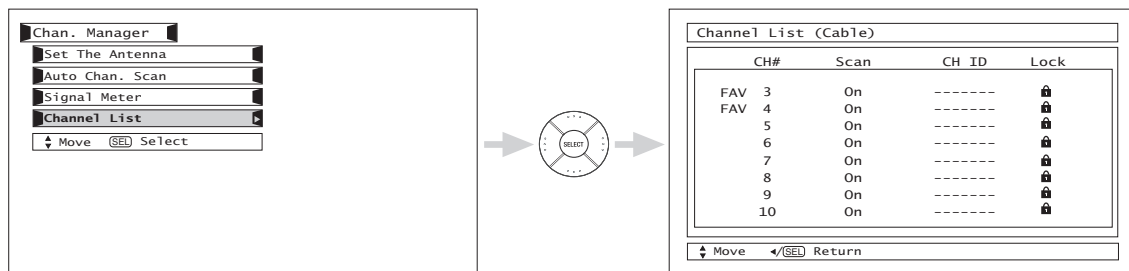

Use the CURSOR PAD to navigate the Channel List.
 Press the CURSOR PAD (▲, ▼) to select On or Off on the Scan column.
 Press the EXIT button to return to normal viewing.

NOTE: When a CableCARD is installed, the Channel List will be dependent on channels agreed upon by you and your cable operator.

Locks

This function will block out the picture and sound of the selected channel or video input. It can also be used to keep the TV from being viewed for a scheduled time period that you set.

The code to enter the Locks feature is a four digit access code number. The factory preset code is 0000. Use the number buttons to enter the access code.

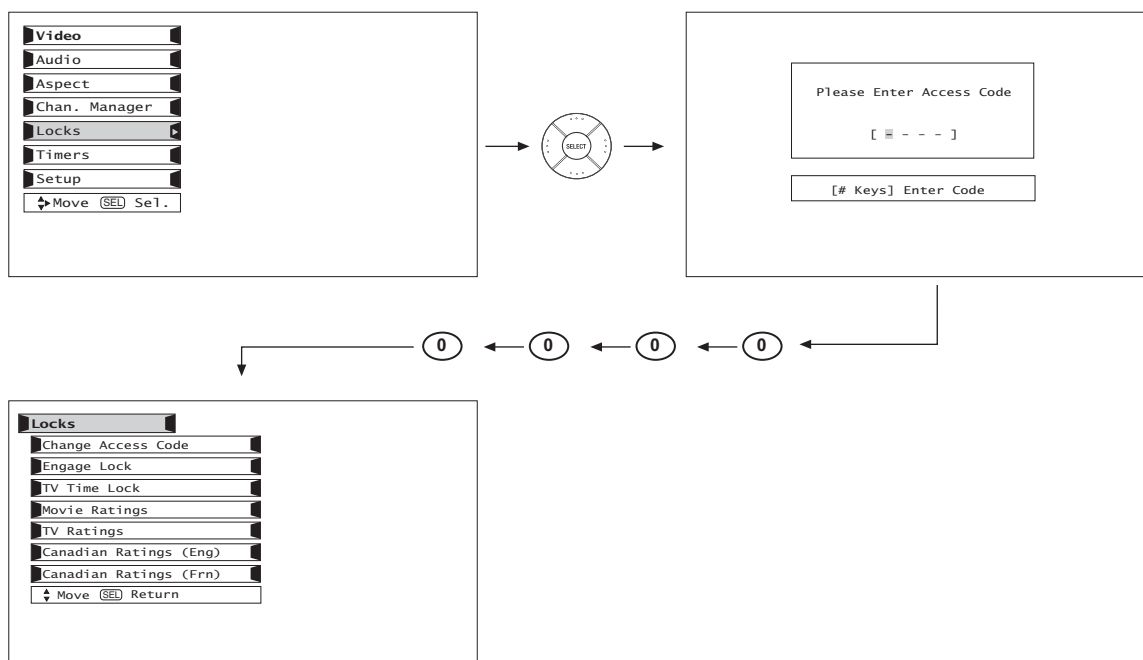

Use the CURSOR PAD ▲ or ▼ to highlight function and then press the SELECT button. To change the access code number, select Change Access Code. Enter a new four digit number.

Select CHANGE ACCESS CODE to change the factory preset code (0000) to your preference.

When ENGAGE LOCK is selected, SET CHANNEL LOCK, SET INPUT LOCK, and SET FRONT PANEL LOCK can be set individually.

When SET CHANNEL LOCK is turned on, the picture and sound for the chosen channel will be blocked out.

When SET INPUT LOCK is turned on, the picture and sound for all video inputs and the picture and sound for channels 3, 4 will be blocked out.

When FRONT PANEL LOCK is turned on, all buttons on the Front Panel will be deactivated, except the Power button.

When TV TIME LOCK is turned on (☑ TIME LOCK) you can set the BEGIN and END times (CURSOR PAD ►) and the TV cannot be viewed during that time period (Set clock first). Use CURSOR ▲ or ▼ to highlight ONCE (TV will time out one time only), DAILY (TV will time out every day), WEEKLY (TV will time out one time a week).

When MOVIE RATINGS is selected, you can block various types of movies and video tapes based on motion picture ratings. Picture-in-Picture will also be blocked automatically (see page 65).

When TV RATINGS is selected, various types of television programming based on a parental guide ratings will be blocked. Picture-in-Picture will also be blocked automatically (see page 66).

Use CANADIAN RATINGS to block various types of movies and television programs based on the two rating systems used in Canada that you feel may be inappropriate due to its content (see pages 67-68).

If you forget your access code, use the factory code 7777 to erase your key number. This will reset the access code number back to the factory preset 0000.

Press EXIT to quit the menu.

- NOTE:**
1. When using TV TIME LOCK make sure the clock is set (see page 69).
 2. Text appears on the screen to indicate that TV TIME LOCK is activated.
 3. If MOVIE/TV Ratings Lock function settings are ON, SURF will be deactivated.

LOCKS

Movie Ratings

Use MOVIE RATINGS to prevent viewing of any movie that you feel may be inappropriate due to its content.

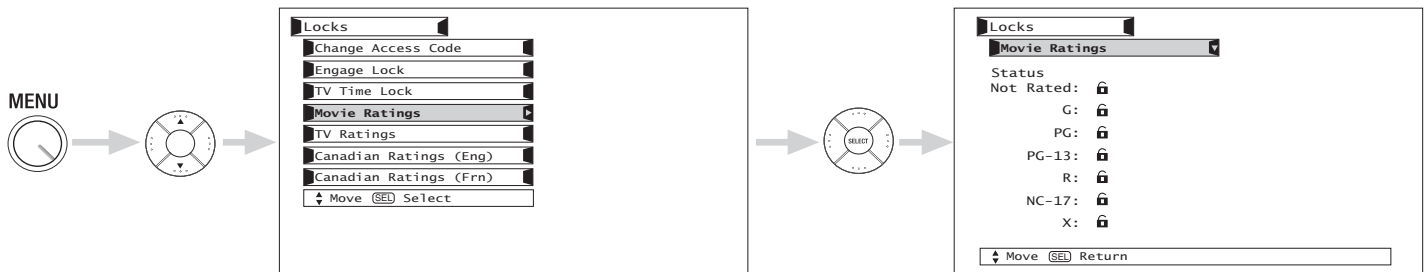

Use the CURSOR PAD ▲ or ▼ to select the MOVIE RATING category that you want to block. Press SELECT to block the MOVIE RATING that you have selected. Once rating is selected, for example PG-13, all movies rated PG-13 and higher (R, NC-17, and X) will be blocked. Press EXIT to quit the menu or select MOVIE RATING to return to the previous menu.

Motion Picture Ratings Chart

G	General audiences. All ages admitted.
PG	Parental guidance suggested. Some material may not be suitable for children.
PG-13	Parents strongly cautioned. Some material may be inappropriate for children under 13.
R	Restricted. Under 17 requires accompanying parent or adult guardian.
NC-17	No one 17 and under admitted.
X	Adults only
NOT RATED (NR)	Contains no rating. Not Rated (NR) and Not Applicable (NA) programs. Movie has not been rated or ratings do not apply.

- NOTES:**
1. A movie rating is dependent upon the movie that is viewed. If the movie does not carry a rating, the TV will not block it.
 2. Blocking "NOT RATED (NR)" programs may block emergency programming, sports, news, public service announcements, religious programs and weather.
 3. If a CableCARD is installed, your cable operator may provide an Emergency Alert System (EAS) message in the event of a local or national emergency with the purpose of alerting the general public. When you receive such messages, the LCD Rear Projection Television will immediately tune to an EAS channel as directed by the EAS message. Please be advised that if the EAS channel is blocked using the Locks feature, you will not be able to tune to that channel.

TV Ratings

Use TV RATINGS to prevent the viewing of any TV program that you feel may be inappropriate due to its content.

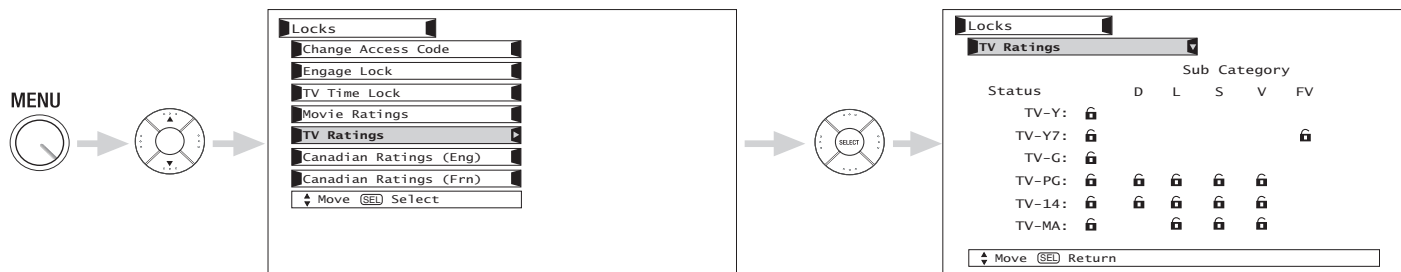

Use the CURSOR PAD ▲ or ▼ to highlight the category that you want to block. Press select to block the TV RATINGS that you have selected. Press EXIT to quit the menu or select TV RATINGS to return to the previous menu.

TV Parental Guide Ratings Chart

N/A	None.
TV-Y	All children. The themes and elements in this program are specifically designed for a very young audience, including children from ages 2-6.
TV-Y7	Directed to older children. Themes and elements in this program may include mild physical or comedic violence, or may frighten children under the age of 7.
TV-G	General audience. It contains little or no violence, no strong language, and little or no sexual dialogue or situations.
TV-PG	Parental guidance suggested. The program may contain infrequent coarse language, limited violence, some suggestive sexual dialogue and situations.
TV-14	Parents strongly cautioned. This program may contain sophisticated themes, intense sexual situation, more intense violence and intensely suggestive dialogue.
TV-MA	Mature audiences only. This program may contain mature themes, indecent language, graphic violence, and explicit sexual content.
FV	Fantasy Violence
V	Violence
S	Sexual Situation
L	Adult Language
D	Sexually Suggestive Dialogue.

NOTES:

1. If you Block TV-14D, you will still permit TV MA programs; If you block TV-14DV, you will automatically block TV-MAV programs, but you will still permit TV-MALS programs. This means that the TV will block violence in TV-14 and higher (TV-MA), but not language and sex.
2. TV program ratings are dependent on the broadcaster. If the program is not rated, the TV will not block it.
3. If a CableCARD is installed, your cable operator may provide an Emergency Alert System (EAS) message in the event of a local or national emergency with the purpose of alerting the general public. When you receive such messages, the LCD Rear Projection Television will immediately tune to an EAS channel as directed by the EAS message. Please be advised that if the EAS channel is blocked using the Locks feature, you will not be able to tune to that channel.

LOCKS

Canadian Ratings (Eng)

Use Canadian Ratings (Eng) to block any type of movie and television program in Canada that you feel might be inappropriate in its content.

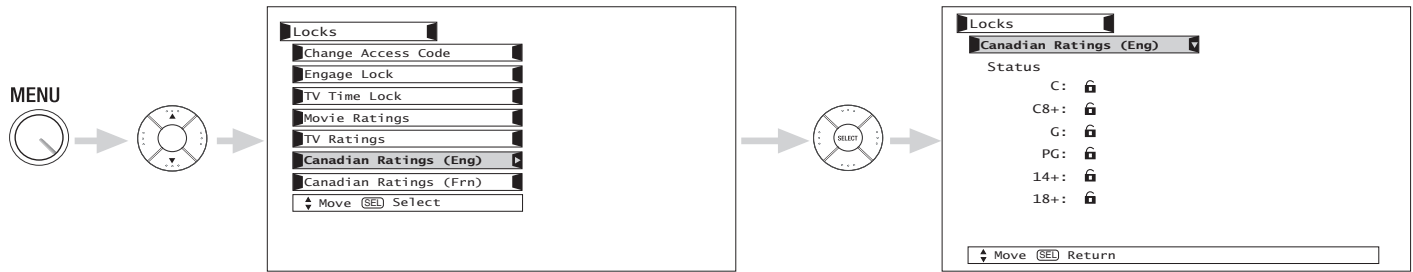

Use the CURSOR PAD ▲ or ▼ to select the CANADIAN RATINGS (Eng) category that you want to block. Press SELECT to set the CANADIAN RATINGS (Eng) that you have selected. Once rating is selected, for example C8+, all movies and television programs rated C8+ and higher (G, PG, 14+ and 18+) will be blocked automatically. Press EXIT to quit menu.

Canadian Ratings English Chart

C	Programming intended for children under age 8 - Violence Guidelines; Careful attention is paid to themes, which could threaten children's sense of security and well-being. There will be no realistic scenes of violence. Depictions of aggressive behaviour will be infrequent and limited to portrayals that are clearly imaginary, comedic or unrealistic in nature. Other Content Guidelines: There will be no offensive language, nudity or sexual content.
C8+	Programming generally considered acceptable for children 8 years and over to watch on their own - Violence Guidelines: Violence will not be portrayed as the preferred, acceptable, or only way to resolve conflict; or encourage children to imitate dangerous acts which they may see on television. Any realistic depictions of violence will be infrequent, discreet, of low intensity and will show the consequences of the acts. Other Content Guidelines: There will be no profanity, nudity or sexual content.
G	General Audience - Violence Guidelines: Will contain very little violence, either physical or verbal or emotional. Will be sensitive to themes which could frighten a younger child, will not depict realistic scenes of violence which minimize or gloss over the effects of violent acts. Other Content Guidelines: There may be some inoffensive slang, no profanity and no nudity.
PG	Parental Guidance - Programming intended for a general audience but which may not be suitable for younger children. Parents may consider some content inappropriate for unsupervised viewing by children ages 8-13. Violence Guidelines: Depictions of conflict and/or aggression will be limited and moderate; may include physical, fantasy, or supernatural violence. Other Content Guidelines: May contain infrequent mild profanity, or mildly suggestive language. Could also contain brief scenes of nudity.
14+	Programming contains themes or content which may not be suitable for viewers under the age of 14 - Parents are strongly cautioned to exercise discretion in permitting viewing by pre-teens and early teens. Violence Guidelines: May contain intense scenes of violence. Could deal with mature themes and societal issues in a realistic fashion. Other Content Guidelines: May contain scenes of nudity and/or sexual activity. There could be frequent use of profanity.
18+	Adult - Violence Guidelines: May contain violence integral to the development of the plot, character or theme, intended for adult audiences. Other Content Guidelines: May contain graphic language and explicit portrayals of nudity and/or sex.

Canadian Ratings (Frn)

Use CANADIAN RATINGS (FRN) to block Canadian French programs according to various program ratings that you feel might be inappropriate in its content.

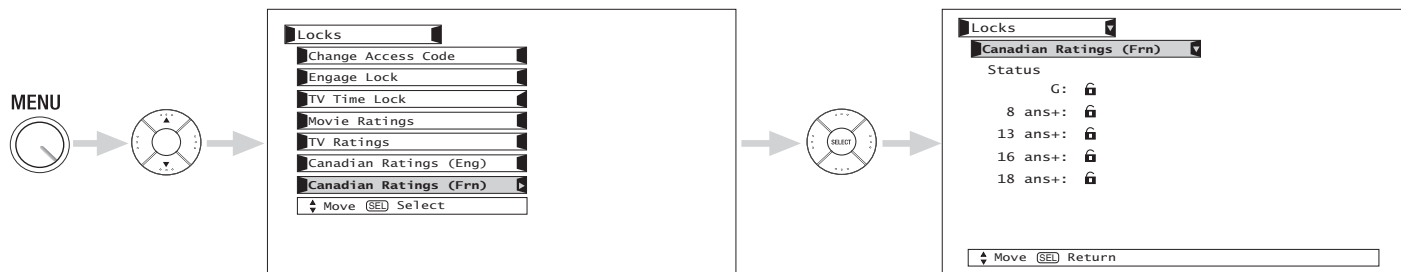

Use the CURSOR PAD ▲ or ▼ to highlight the category that you want to block. Press SELECT to set the CANADIAN RATINGS (FRN) that you have selected. Once rating is selected, for example 8 ans+, all movies and television programs rated 8 ans+ and higher will be automatically blocked.

Press EXIT to quit menu or select the CURSOR PAD ◀ to return to the previous menu.

Canadian Ratings French Chart

G	General - Programming intended for audiences of all ages. Contains no violence, or the violence content is minimal or is depicted appropriately with humor or caricature or in an unrealistic manner.
8 ans +	8 + General - Not recommended for young children - Programming intended for a broad audience but contains light or occasional violence that could disturb young children. Viewing with an adult is therefore recommended for young children (under the age of 8) who cannot differentiate between real and imaginary portrayals.
13 ans +	Programming may not be suitable for children under the age of 13 - Contains either a few violent scenes or one or more sufficiently violent scenes to affect them. Viewing with an adult is therefore strongly recommended for children under 13.
16 ans +	Programming is not suitable for children under the age of 16 - Contains frequent scenes of violence or intense violence.
18 ans +	Programming restricted to adults - Contains constant violence or scenes of extreme violence.

TIMERS

Timers

Select Timers to set your Clock, Sleep Timer, Event Timer and Day/Night Timer Recordings.

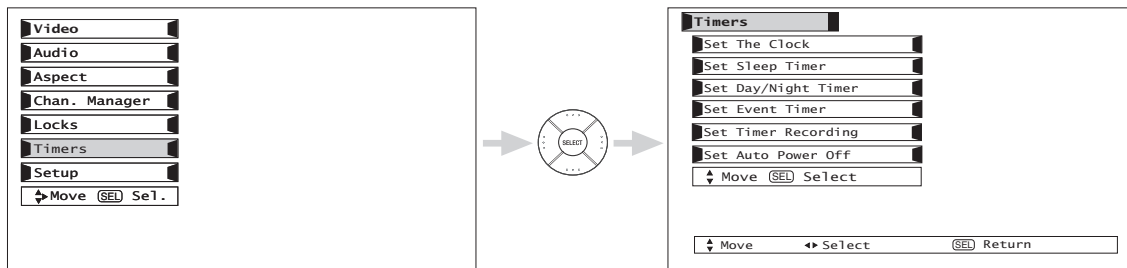

Set The Clock

The Clock must be adjusted before you can use the “Set Event Timer” or Day/Night Timer” feature.

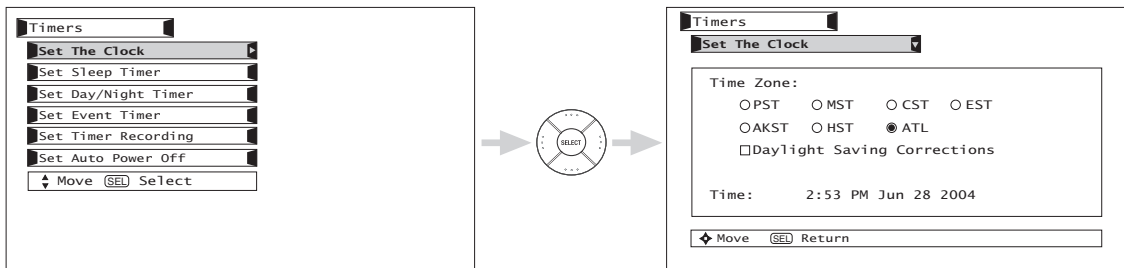

Use the CURSOR PAD ▲, ▼, ◀, ▶ to highlight the chosen Time Zone settings.

Press the SELECT button to select.

If you observe daylight savings, use CURSOR PAD to highlight “Daylight Saving Correction” and press the SELECT button to select.

Use the CURSOR PAD ▲, ▼, ◀, ▶ to highlight the current time (hour and minute), AM or PM, Month, Day, and Year.

Use the CURSOR PAD ▲, ▼ to adjust settings.

Press the SELECT button to set the Time and Date.

Press EXIT to quit the menu.

NOTES: When “Daylight Saving Correction” is checked “✓”, the TV will automatically calculate the clock adjustment for Daylight Saving.

Set Sleep Timer

Select this feature to set your Sleep Timer from 30 minutes to 3 hours (30 minute increments).

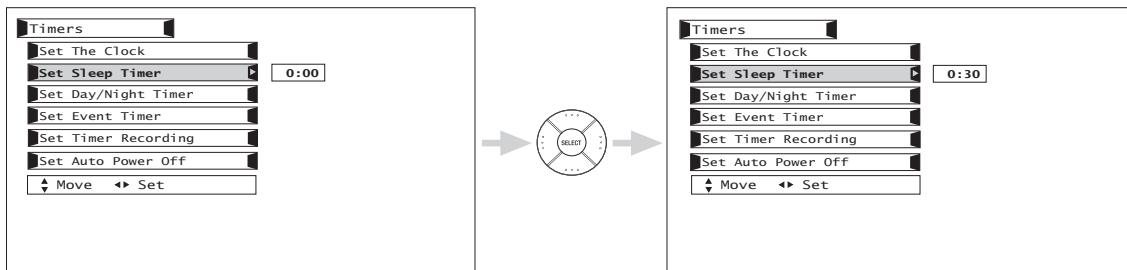

Press the CURSOR PAD ► repeatedly to set your Timer from 0:00, 0:30, 1:00, 1:30, 2:00, 2:30 and 3:00.

Set Day/Night Timer

Select this feature to activate and set your TV's Day/Night Picture Mode automatically.

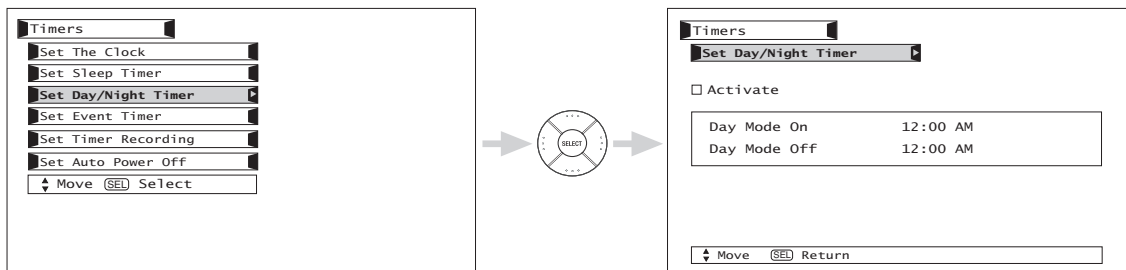

Use the CURSOR PADS and the SELECT button to activate the Day/Night Timer.
 Use the CURSOR PADS to select Day Mode On and to set its timer.
 Use the CURSOR PADS to select Day Mode Off and to set its timer.

TIMERS

Set Event Timer

This function will automatically operate the Projection TV viewing reservation of a program. If the clock is not set, you can not use this function and the screen below will appear. The message on the screen will disappear after 3 seconds, then the screen automatically goes to the clock setup mode (see page 69).

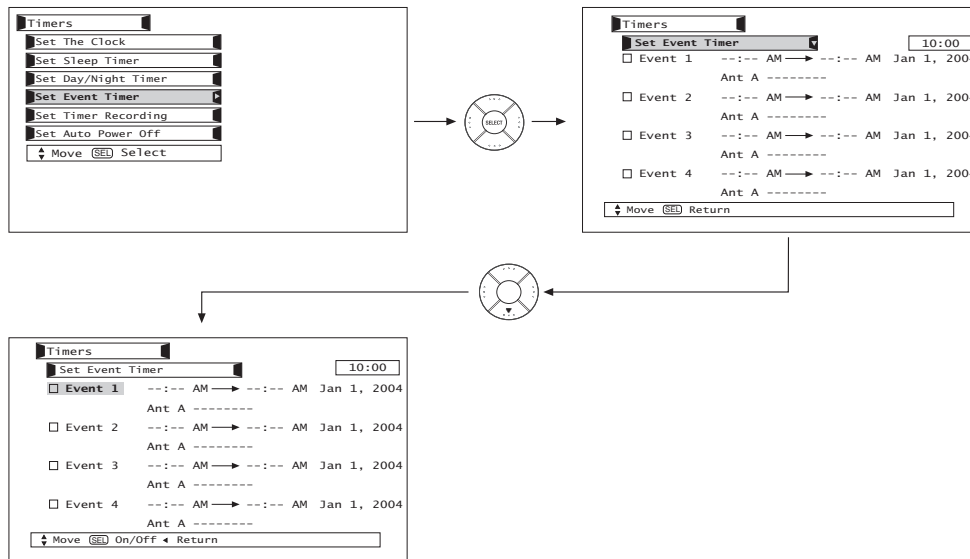
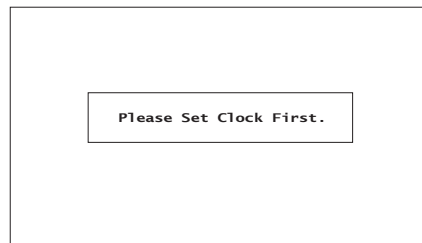

- Use CURSOR PAD ▲, ▼ to highlight Event 1, Event 2, Event 3, Event 4 and then press the SELECT button to select.
 - Use CURSOR PAD ►, ▲, ▼ to highlight and select START TIME Hour/Minute.
 - Use CURSOR PAD ►, ▲, ▼ to highlight and select START TIME AM/PM.
 - Use CURSOR PAD ►, ▲, ▼ to highlight and select FINISH TIME Hour/Minute.
 - Use CURSOR PAD ►, ▲, ▼ to highlight and select FINISH TIME AM/PM.
 - Use CURSOR PAD ► to highlight the MONTH.
 - Use CURSOR PAD ▲ to select a MONTH or CURSOR PAD ▼ to select Daily, Weekly - Sunday to Monday. Use CURSOR PAD ◀ to return to MONTH.
 - Use CURSOR PAD ►, ▲, ▼ to highlight and select the DAY of the MONTH.
 - Use CURSOR PAD ►, ▲, ▼ to highlight and select the YEAR.
 - Use CURSOR PAD ►, ▲, ▼ to highlight and select Ant A or Ant B.
 - Use CURSOR PAD ►, ▲, ▼ or NUMBER buttons to set the channel the TV will tune into.
- A "✓" in the box means it is enabled.

NOTE:

1. When the INFO button is pressed, the Event Timer Icon will only display the current date ON/OFF timer.
2. The Off Timer will only activate if the TV was turned on by the On Timer and no channel selection was made after this time. If you change the channel after the On Timer has been activated, the Off Timer will deactivate.
3. If no remote control button is pressed after viewing reservation is activated, the TV will automatically turn off after three hours. Therefore, do not Set Event Timer for more than three hours if you do not plan to control your television with the remote control.

CAUTION: Do not use your TV as a deterrent when away from home by using the On and Off Timers. For safety, the TV should be turned off when you are away from home.

Set Timer Recording

Select this feature to set and record digital channels using your device connected to the IEEE 1394 jacks (ex. D-VHS) or Monitor Out (ex. VCR).

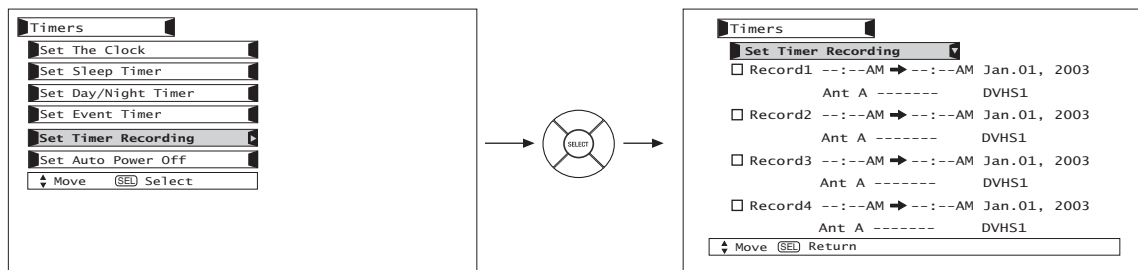

- Use CURSOR PAD ▲, ▼ to highlight Record 1, Record 2, Record 3 and then press CURSOR PAD to select.
- Use CURSOR PAD ►, ▲, ▼ to highlight and select START TIME Hour/Minute.
- Use CURSOR PAD ►, ▲, ▼ to highlight and select START TIME AM/PM.
- Use CURSOR PAD ►, ▲, ▼ to highlight and select FINISH TIME Hour/Minute.
- Use CURSOR PAD ►, ▲, ▼ to highlight and select FINISH TIME AM/PM.
- Use CURSOR PAD ► to highlight the MONTH.
- Use CURSOR PAD ▲ to select a MONTH or CURSOR PAD ▼ to select Daily, Weekly - Sunday to Monday. Use CURSOR PAD ▲ to return to MONTH.
- Use CURSOR PAD ►, ▲, ▼ to highlight and select the DAY of the MONTH.
- Use CURSOR PAD ►, ▲, ▼ to highlight and select the YEAR.
- Use CURSOR PAD ►, ▲, ▼ to highlight and select ANT A or B channel # to be recorded.
- Use CURSOR PAD ►, ▲, ▼ to highlight and select Device to be used.
- Press the SELECT button to return and highlight Record 1.
- A "✓" in the box means it is enabled.

- NOTES:**
1. Set the Time and connect the devices before using this feature.
 2. The Timer Recording has priority over the Event Timer. If the Timer Recording is set at the same time as the Event Timer or overlaps with each other, the TV will only perform the function of the Timer Recording.
 3. When you use the Monitor Out, AV Network Setting are needed (see pages 23-32).
 4. Antenna B is not available when using CableCARD.
 5. Refer to your device operating guide for more information.
 6. Turn off the device before recording. The television automatically turns on the device for recording.

TIMERS

Set Auto Power Off

This function will turn off the TV automatically when a video signal is not detected for 15 minutes.

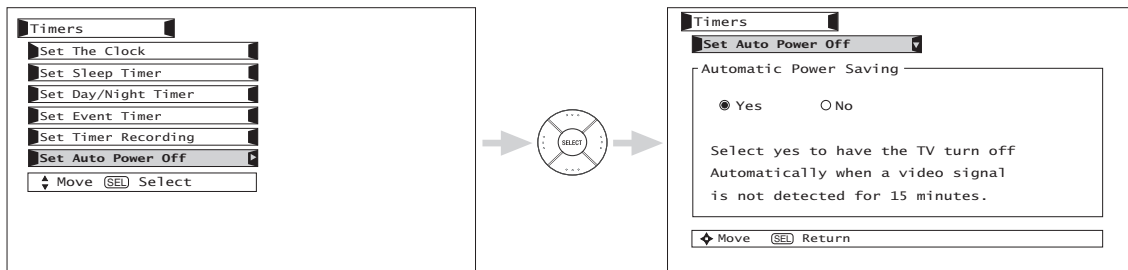

Use the CURSOR PAD to highlight the sub-menu of your choice.
Press the SELECT button to select.

- NOTE:**
1. If "Yes" is selected and no signal is detected on Antenna Mode, "Weak signal or channel not available" will be displayed.
 2. If "Yes" is selected and no signal is detected on Video Mode, "No Sync. Signal" will be displayed.
 3. If "Yes" is selected and it is 1 minute before the TV turns off automatically, the "OFF 0:01" icon will be displayed.
 4. The Auto Power OFF feature will be cancelled when an input change or channel operation is performed.

Setup

Select SETUP when setting your TV up for the first time. Use the CURSOR PAD ▲ or ▼ on the remote to highlight the function desired.

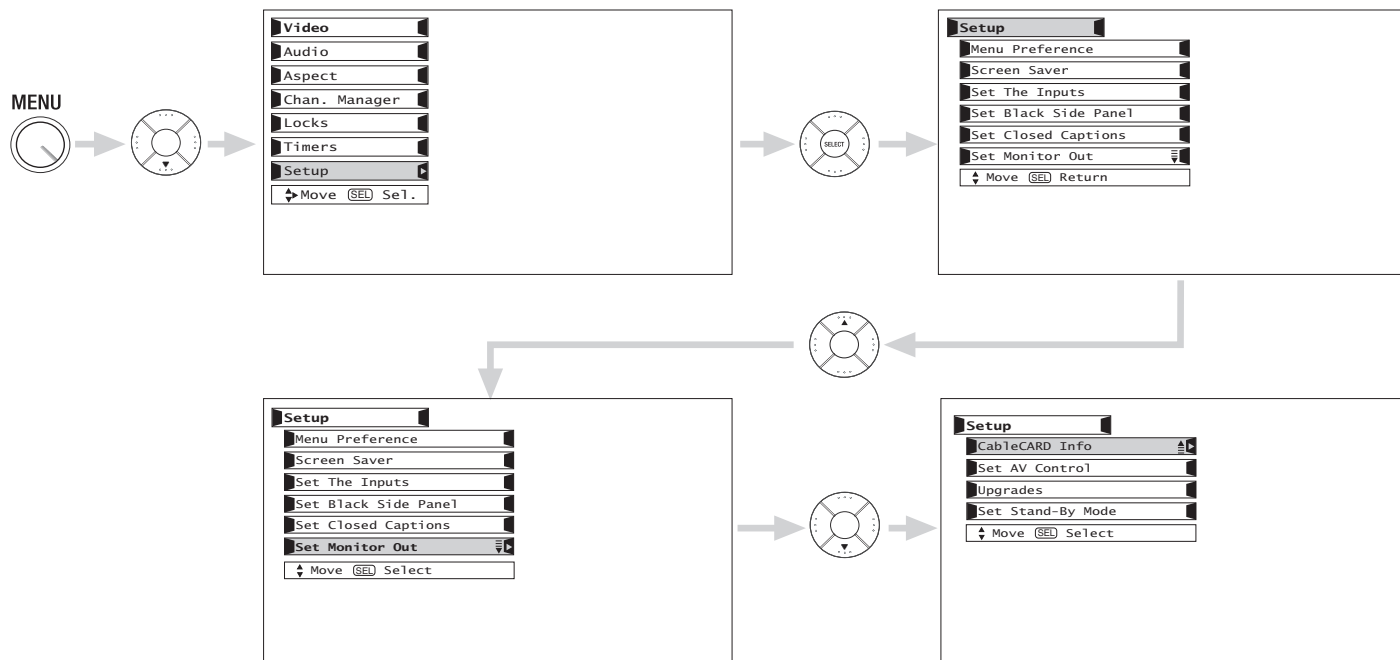

Use the CURSOR PAD ▲, ▼, ◀, ▶ to highlight the sub-menu of your choice. Press the SELECT button to select.

Menu Preference

This feature will allow you to select any one of three different languages for all on-screen displays.

ON-SCREEN DISPLAY

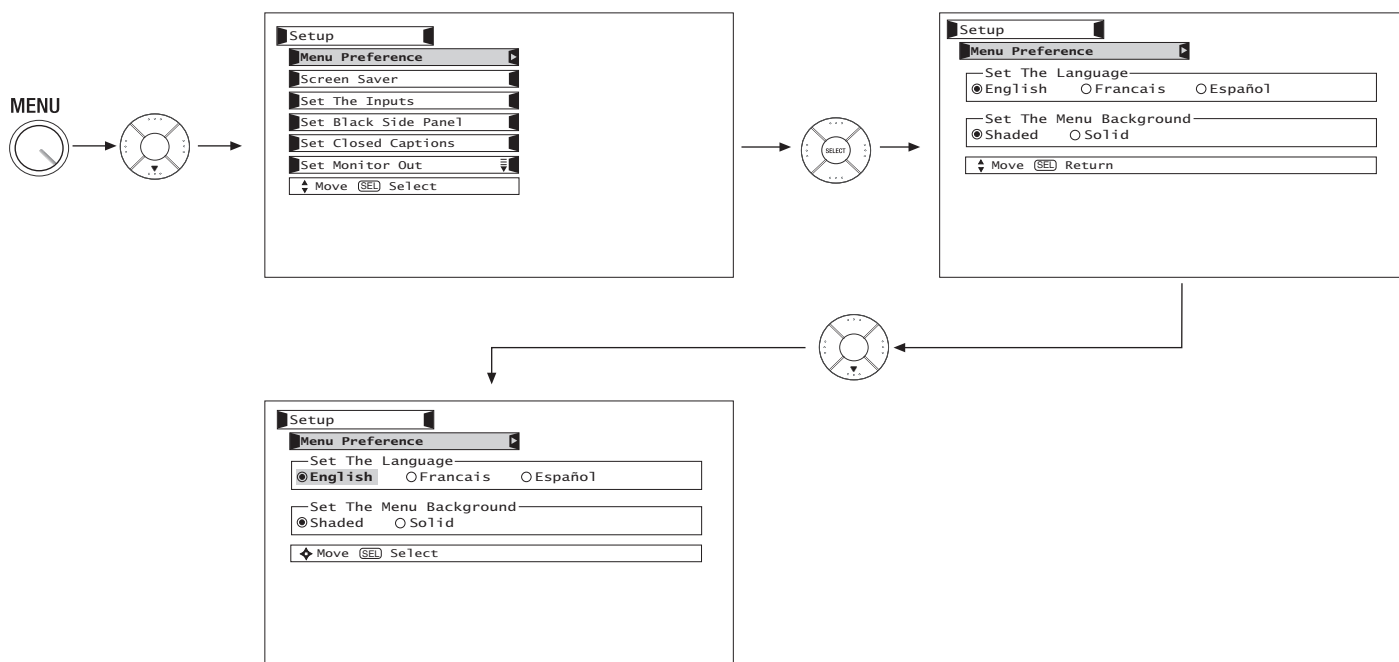

Use the CURSOR PAD ◀, ▶ to highlight the language of your choice. Press SELECT to select the highlighted language. Press EXIT to quit menu or select MENU PREFERENCE to return to previous menu.

SETUP

Set The Menu Background

This function allows you to choose from two menu backgrounds.

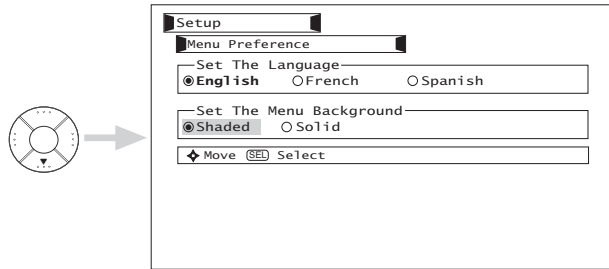

Use CURSOR PAD ◀, ▶ to highlight Set The Menu Background (shaded or solid), and press the SELECT button to select setting.

Press EXIT to quit menu or CURSOR PAD ◀ to return to previous menu.

Select Solid for a black background (no picture can be seen behind menu screen), or select Shaded for a light background.

Screen Saver

Continuous on-screen displays such as video games, stock market quotations, computer generated graphics, and other fixed (non-moving) patterns can cause “temporary image retention” to the LCD Rear PTV. Use the SCREEN SAVER feature to avoid any temporary image retention. Moving picture will clear up any temporary image retention.

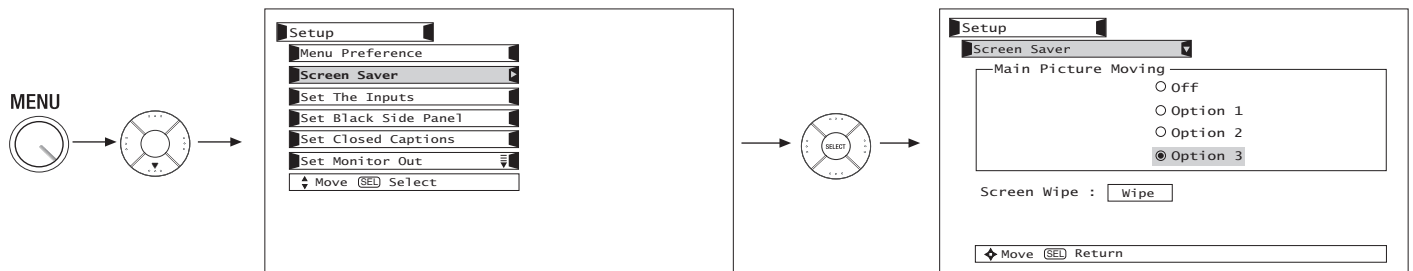

Use CURSOR PAD ▲, ▼ to highlight Screen Saver’s Main Picture Moving options.

Press the SELECT button to select and EXIT to quit.

Option 1

The whole picture will shift every 20 minutes by two pixels.

Option 2

The whole picture will shift every 40 minutes by two pixels.

Option 3

The whole picture will shift every 60 minutes by two pixels.

Screen Wipe

If temporary image retention occurs, use Screen Wipe (White Field Signal) for at least 10 minutes to refresh any temporary image retention that may have occurred.

Screen Saver Picture’s Movement

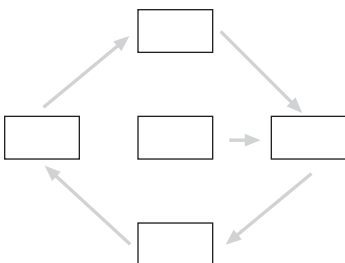

Set The Inputs

Use this feature to give a name to any of the five video inputs.

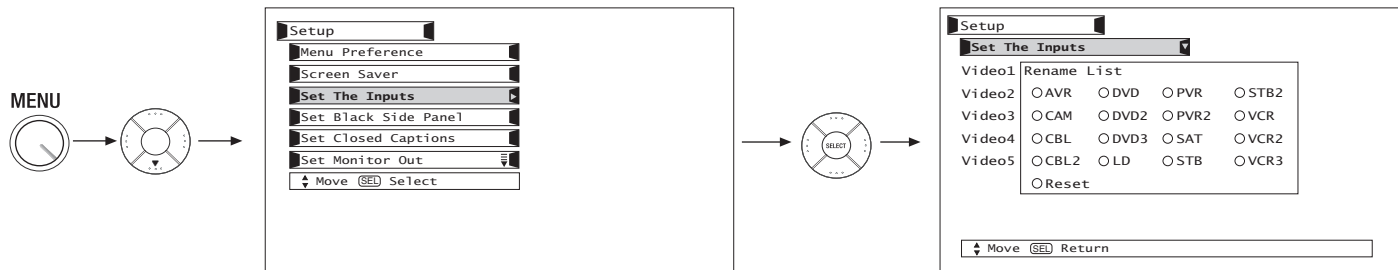

Use the CURSOR PAD to highlight the name of the video inputs.

Press the SELECT button to select desired input name.

Select Reset to set video names to original factory preset condition.

Video 2 Auto Link

Use this function to automatically turn the TV on and tune to Video2 when it detects a video signal to input 2.

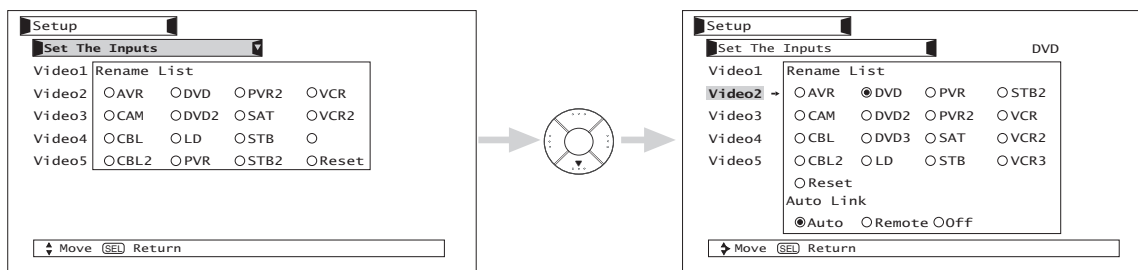

Use the CURSOR PAD, then press the SELECT button to change Auto Link setting.

When Auto is selected, the TV will turn on and tune to Video2 automatically, when the Video2 input device is turned on. This is convenient when you want to watch a movie with your VCR, laserdisc player, or DVD player.

When Remote is selected, the TV will turn on and switch to Video2 automatically when the Video2 input device is turned on and the VCR, laserdisc, or DVD play button on your remote control is pressed.

This is convenient when you want to record a movie with your VCR and watch it later.

Select Off to disable this function.

Press EXIT to quit menu.

- NOTES:**
1. Once the TV has been turned on using the Auto Link feature, it must be reset before Auto Link is used again. To do this, turn your VCR, laserdisc, or DVD player OFF. This feature is now reset and will turn on your TV as described above.
 2. When using Remote mode, any remote control button will substitute for your video input device play button. However, intended operation is for use with your VCR, laserdisc, or DVD play button.
 3. If no remote control button is pressed after the TV is turned on by Auto Link, the TV will automatically turn off after three hours.

Set Black Side Panel

The Black Side Panel function turns the gray side bars on/off when watching 4:3 signals in Standard mode. The top/bottom gray bar will appear in SPLIT MODE PIP and SPLIT FREEZE.

Set Closed Caption

Closed Captions are the dialogue, narration, and/or sound effects of a television program or home video which are displayed on the TV screen. Your local TV program guide denotes these programs as **CC** or

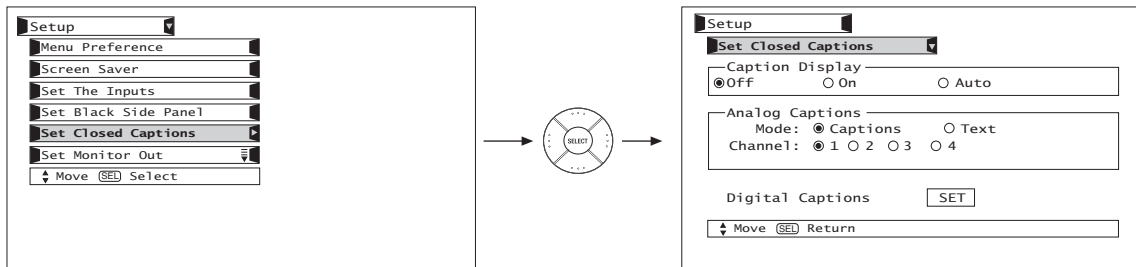

Caption Display: On/Off will turn the **CC** display on or off.

Auto will turn the **CC** display on when Mute/Soft Mute is on.

Caption Mode: **Captions** is for the program you are viewing.

Text is for additional information such as news reports or a TV program guide. This information covers the entire screen and viewing the TV program is not possible. Text may not be available with every **CC** program.

- CHANNEL:**
- 1 is used for the primary language (usually English).
 - 2 is sometimes used for a second language (may vary by region).
 - 3 is sometimes used for a third language (may vary by region).
 - 4 is sometimes used for a fourth language (may vary by region).

Use the CURSOR PAD ▲, ▼, ◀, ▶ to highlight the function to change then press the SELECT button to select the function. Press EXIT to quit menu or the CURSOR PAD ◀ to return to previous menu.

Digital Captions: Set captions for digital programs. This function will help choose and set available language, font, size and style of digital captions.

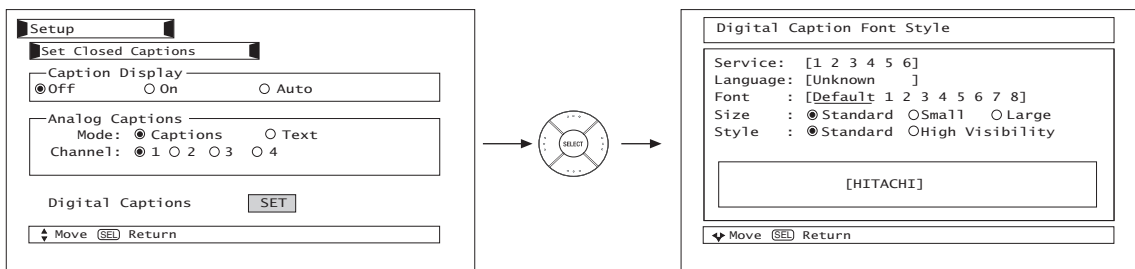

Use the CURSOR PAD ▲, ▼, ◀, ▶ to highlight desired Digital Captions feature. Press the SELECT button to select desired feature. Press EXIT to quit menu or the CURSOR PAD ◀ to return to previous menu.

- NOTES:**
1. Some types of digital closed captions may not work with this TV.
 2. CAPTION DISPLAY will not work when viewing a 480p, 720p, or 1080i input via the COMPONENT: Y-PBPR inputs.
 3. When PIP Surf is on, Closed Caption will not work.
 4. Digital Captions Font Style are sometimes different from the Font Style of Analog Captions.
 5. Closed Caption and Digital Captions availability and content depends on the broadcaster. Closed Caption is available when Closed Caption icon is displayed on screen.
 6. Digital Captions will not be available (grayed out) when using analog channels.

Set Monitor Out

This feature will select the source of the Monitor Output.

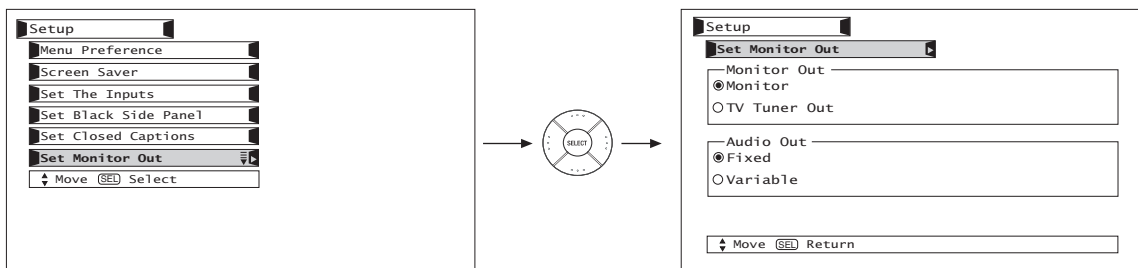

Monitor- Select Monitor to output the audio and video signals of the chosen input source (ANT A, ANT B, VID3-VID5) to a VCR or other A/V device.

TV Tuner Out- Select TV Tuner Out to output the audio and video signals of the last watched Antenna Source (ANT A, ANT B).

Fixed- Select Audio Out Fixed to have the Audio at fixed volume.

Variable- Select Audio Out Variable to have Audio settings that can be controlled.

Use CURSOR PAD ▲, ▼ to highlight the function to change then press the SELECT button to select the function.

Press EXIT to quit menu or CURSOR PAD ◀ to return to previous menu.

- NOTES:**
1. When TV Tuner Out is selected, Variable Audio Out will not be available (grayed out).
 2. Set Audio Out to fixed, when using Timer Recording function.

CableCARD Info

Select this feature to access your CableCARD ID and HOST ID. Please have this information ready when you call your cable operator (see also page 13).

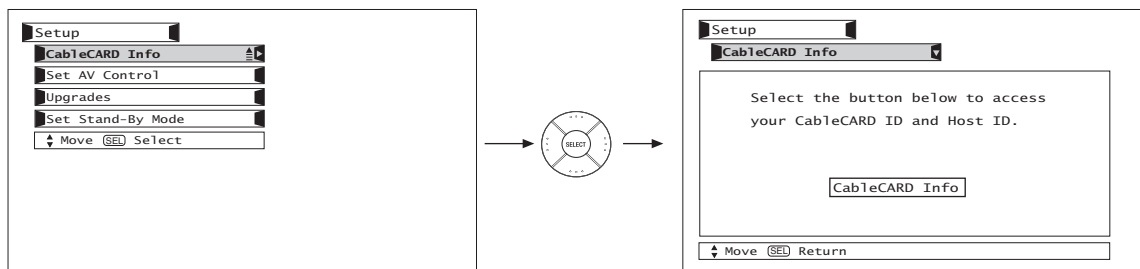

Set AV Control

This feature will select the AV Control feature. Set this feature if you want to control some of the TV functions from an external home control system.

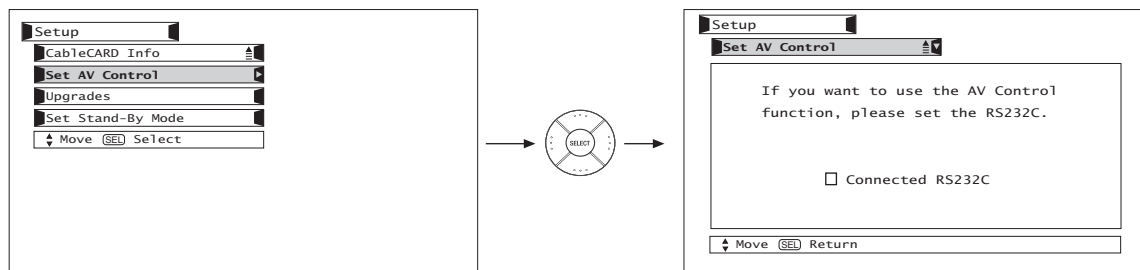

Use the CURSOR PADS and the SELECT button to check the Connected RS232C box.

- NOTE:** For use with third party home Audio/Video control systems which are commercially available. Please see your dealer regarding these "non Hitachi" home control systems.

SETUP

Upgrades

It shows software information and easy upgrade procedure. This function allows the TV software to be upgraded by using a flash card (MMC Card). If a future software upgrade is required for your TV, Hitachi will notify and provide you with a flash card. In order to receive written notification and the flash card, please complete and return the warranty card.

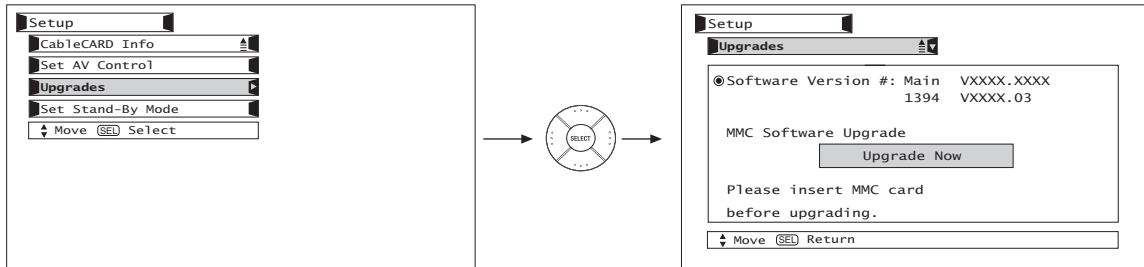

Insert MMC card, then press the CURSOR PAD ▲, ▼ to highlight “Upgrade Now”. Press the SELECT button to select and start upgrading.

NOTE: Any power interruption during the upgrade process will cancel the upgrade. When this happens, repeat the upgrade procedure.

Set Stand-By Mode

This function sets the IEEE1394 in Stand-By Mode to ON or OFF. Certain digital devices have a power save feature, in which the device automatically powers OFF when not in use (sleep mode). Only by setting the IEEE1394 function in Stand-By mode to ON, will the TV be able to control a device that is in sleep mode.

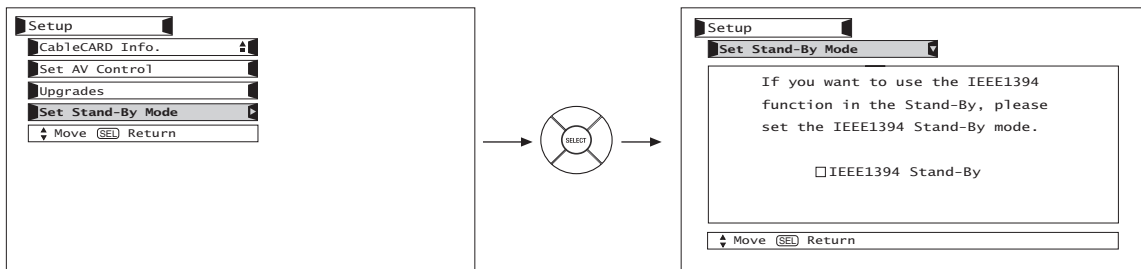

NOTE: By turning ON the IEEE1394 function, your TV set will no longer be set for power saving Stand-By mode. The IEEE1394 Stand-By function must be set to OFF to return your TV set to the power saving Stand-By mode.



LAMP REPLACEMENT

LAMP REPLACEMENT

Lamp Life

The lamp life may vary based on usage of the LCD Rear PTV. Turning on and off frequently may shorten the life of the lamp.

Lamp Replacement

After extended use, if the TV picture turns dark, the color looks unusual or LAMP INDICATOR light turns on, then it is time to replace the lamp with a new lamp.

WARNING:

The lamp gets very hot! The lamp may explode if improperly handled. To avoid injury, please observe the following precautions.

- Do not open lamp compartment or attempt to remove lamp assembly unless the lamp assembly is being replaced.
- Unplug the product's power cord from the AC outlet before attempting to replace the lamp assembly.
- If the lamp is in use when failure occurs or if the lamp has exploded, wait at least 30-45 minutes for the lamp to cool before opening the lamp compartment or touching the lamp assembly or any broken pieces.
- Broken lamp pieces can cause injury. Handle with gloves to avoid cuts.
- Do not place any foreign objects inside the lamp compartment.
- When installing a new lamp, follow handling instruction included with the new lamp. Do not touch glass surface of new lamp.
- This product contains lead and a lamp that contains mercury. Dispose of this product and its lamp in accordance with applicable environmental laws. For lamp recycling and disposal information, go to www.lamprecycle.org. For product recycling and disposal information, contact your local government agency or the Electronic Industries Alliance at www.eiae.org (in the US) or the Electronic Product Stewardship Canada at www.epsc.ca (in Canada). For more information, call "1-800-HITACHI."

CAUTION!

A "LAMP" indicator will light when lamp becomes hot. Unplug product's power cord from the AC outlet and allow lamp to cool for at least 30-45 minutes. If "LAMP" indicator is still lit, please contact your authorized service center (see page 86-87).

NOTES:

- Contact your Hitachi dealer for a new lamp unit. Using other lamps may cause damage to the TV Set.

MODEL#	LAMP TYPE	PART#
50VX915	LM700	UX21514
60VX915	LM700	UX21514
70VX915	LW700	UX21515

- When replacing the lamp, let it cool down completely, for approximately 30 to 45 minutes after the power has been switched off and A.C. cord has been unplugged.
- Do not touch the glass of the new lamp or make it dirty which can shorten the life of the lamp and reduce the picture quality.
- Keep the lamp out of the reach of children and away from flammable materials.
- Do not pour water onto the removed lamp or put any object inside the lamp.
- Once the lamp is removed, do not put flammable materials and metal objects inside the lamp receptacle on the TV set. Do not touch the receptacle.
- Install the new lamp securely, otherwise the picture may become dark or it may cause severe over-heating.
- Install the lamp cover correctly, otherwise power will not come on.

LAMP REPLACEMENT



1. Turn off the main power switch and unplug the power cord.

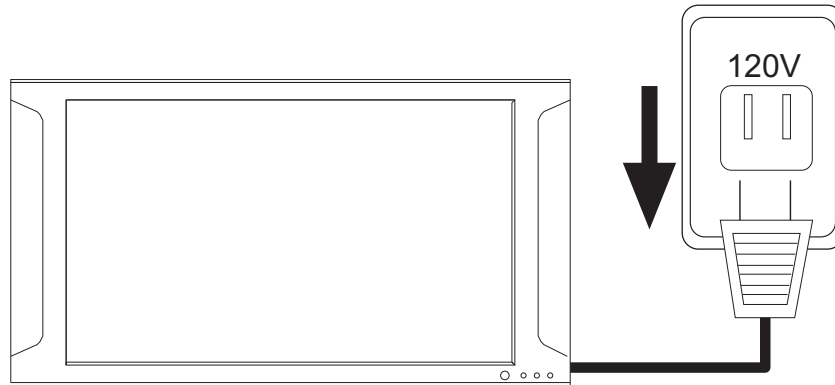

CAUTION: THE LAMP IS VERY HOT AND MAY CAUSE FIRE OR SEVERE BURNS. WAIT AT LEAST 30~45 MINUTES TO ALLOW THE LAMP TO COOL BEFORE PROCEEDING WITH LAMP REMOVAL.

2. Locate the Lamp Compartment on the left side of the LCD TV.

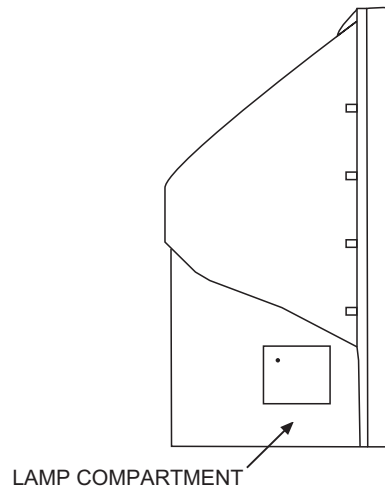

NOTE: This product contains lead and a lamp that contains mercury. Dispose of this product and its lamp in accordance with applicable environmental laws. For lamp recycling and disposal information, go to www.lamprecycle.org. For product recycling and disposal information, contact your local government agency or the Electronic Industries Alliance at www.eiae.org (in the US) or the Electronic Product Stewardship Canada at www.epsc.ca (in Canada). For more information, call "1-800-HITACHI."



LAMP REPLACEMENT

LAMP REPLACEMENT

3. Remove the screw securing the lamp cover with a Phillips head screw driver as shown. Remove the lamp cover.

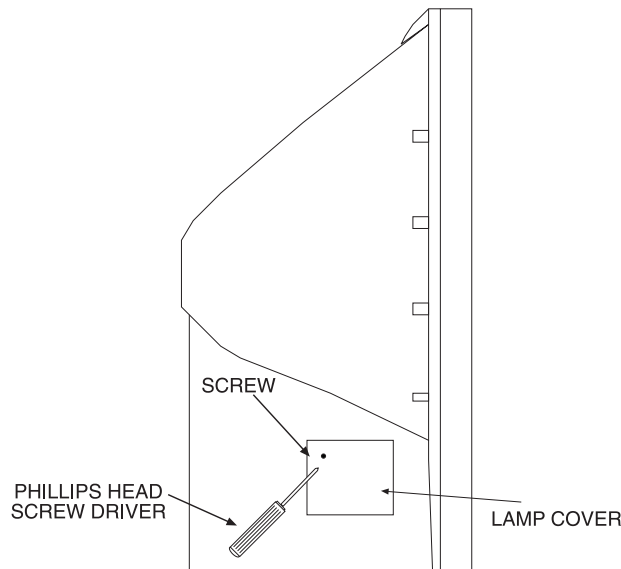

CAUTION: THE LAMP IS VERY HOT AND MAY CAUSE FIRE OR SEVERE BURNS. WAIT AT LEAST 30~45 MINUTES TO ALLOW THE LAMP TO COOL BEFORE PROCEEDING WITH LAMP REMOVAL.

4. Remove the two screws that hold the lamp in place. Remove the lamp unit by holding the lamp handle, then pulling outwards. Exercise caution when removing the lamp unit to avoid injury to your fingers.

NOTE: DO NOT PUT YOUR HAND IN THE LAMP STORAGE AREA AFTER THE LAMP UNIT IS REMOVED, YOU MAY GET BURNED.

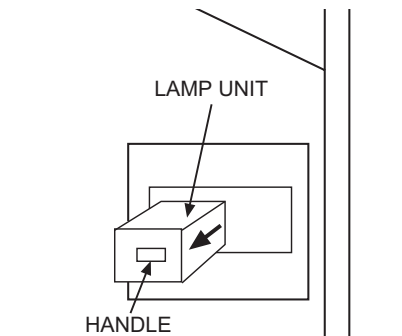
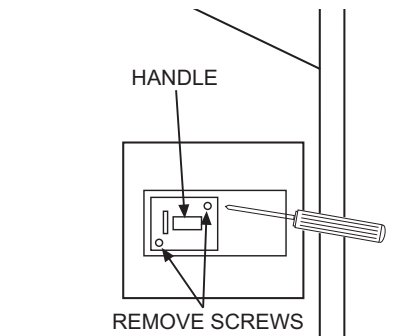

5. Replace with the new lamp.

Place the removed lamp into the empty box of the replacement lamp. Do not touch the front glass of the new lamp or its receptacle. This may shorten the life of the lamp and reduce the picture quality.

- Push the lamp unit back to its original position.
- Tighten the screws firmly on the lamp unit. If they are loose, the TV may not operate correctly.

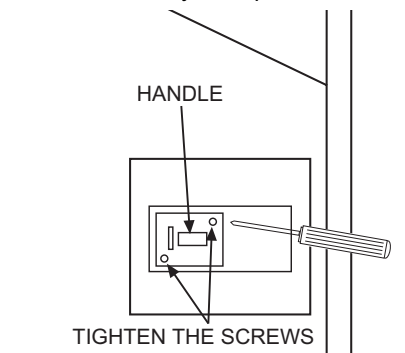
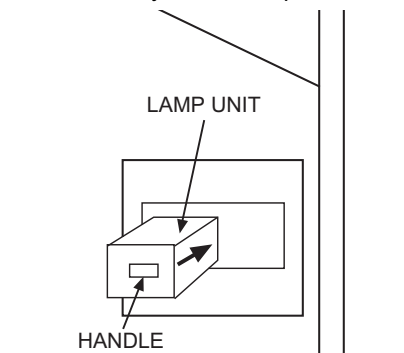



LAMP REPLACEMENT

LAMP REPLACEMENT

6. Without installing the lamp cover, the power will be off and the Lamp Indicator will flash (see page 9). Be sure to install the lamp cover by re-engaging the two clips and tighten the screws before turning the power on, otherwise it may cause unusual colors.

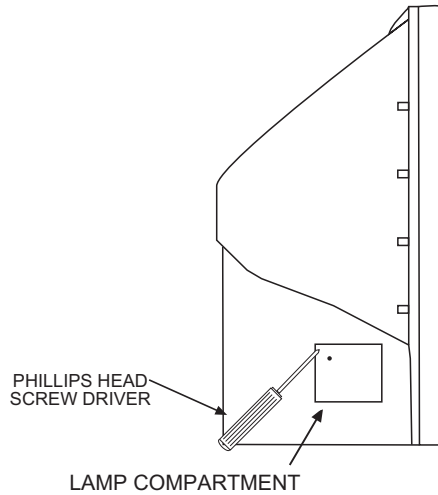

NOTE: IF POWER IS CONNECTED BEFORE THE LAMP COVER IS INSTALLED, THE POWER WILL BE OFF AND THE LAMP INDICATOR WILL FLASH (SEE PAGE 9).

7. Plug power cord into AC outlet and turn on the main power switch.

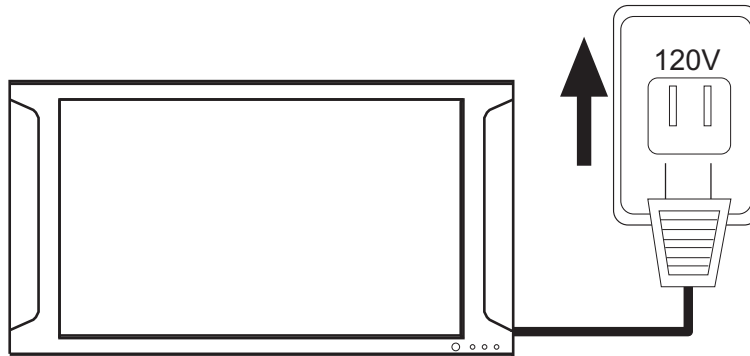

NOTE: This product contains lead and a lamp that contains mercury. Dispose of this product and its lamp in accordance with applicable environmental laws. For lamp recycling and disposal information, go to www.lamprecycle.org. For product recycling and disposal information, contact your local government agency or the Electronic Industries Alliance at www.eiae.org (in the US) or the Electronic Product Stewardship Canada at www.epsc.ca (in Canada). For more information, call "1-800-HITACHI."

IMPORTANT: To setup the New Lamp, please push simultaneously the Power button of the remote control and the Menu button in the control panel after the Lamp replacement.



CARE OF YOUR HITACHI TELEVISION AND YOUR REMOTE CONTROL

DO

Dust the screen and cabinet with a soft cloth.

Clean the screen with a soft cloth moistened in warm water and dry with a soft cloth. A mild soap may be used if the screen is extremely dirty.

Place your Television away from extreme heat, humidity, and extremely dusty places.

Remove the plug from the wall outlet if your Television will not be used for a long period of time, for instances, when you go on vacation.

DO NOT

Do not clean your screen or cabinet with strong cleaners, polishes or a chemically treated cloth.

Do not place rubber or vinyl products or cellophane tape on your Television.

Do not touch the screen too often.

Do not subject the remote control to shocks such as dropping it on the floor, etc. Physical damage to the precision parts may result.





Avoid placing the remote control in a high humidity place or getting it wet. Do not leave it on or near a heater. Excessive heat or moisture may cause the unit to cease operation.

When the batteries run down, remote control operation will become erratic or possibly stop altogether. Replace the old batteries with two new "AA" or "AAA" size batteries as soon as possible to preserve the remote control precodes that were set for the devices. Pressing a remote control button with a "DEAD" battery might erase all precodes in memory. Do not use an old battery with a new battery.

Exposure of the viewing screen to prolonged direct sunlight or heat may cause the screen to permanently warp, resulting in a distorted picture.

RECEPTION PROBLEMS



	<ul style="list-style-type: none">• IGNITION NOISE: Black spots or horizontal streaks may appear, picture may flutter or drift. Usually caused by interference from automobile ignition systems, neon lamps, electrical drills, and other electrical appliances.
	<ul style="list-style-type: none">• GHOSTS: Ghosts are caused by the television signal following two paths. One is the direct path and the other is reflected from tall buildings, hills or some other objects. Changing the direction or position of the antenna may improve reception. Ghosting may also be caused by defects in the antenna system such as unshielded leads or connecting several sets to the same antenna without using multiple antenna couplers.
	<ul style="list-style-type: none">• SNOW: If your receiver is located in the fringe area of a television station where the signal is weak, your picture may be marred by the appearance of small dots. When the signal is extremely weak, it may be necessary to install a special antenna to improve the picture.
	<ul style="list-style-type: none">• RADIO FREQUENCY INTERFERENCE: The interference produces moving ripples or diagonal streaks, and in some cases, causes loss of contrast in the picture.

NOTE: The TV set can generate sound distortion in external devices such as a radio. Please separate radio equipment from the TV set to a considerable distance.



SYMPTOMS	CHECK THESE ITEMS AND TRY THESE ADJUSTMENTS												
	Be sure external connection is correct	Be sure power cord is plugged in	Be sure TV is switched "ON"	Try another channel (station trouble)	Check antenna connections (back of TV)	Check antenna for broken lead-in wire	Check outside antenna	Adjust Contrast control	Adjust Brightness control	Adjust Color control	Adjust Tint control	Adjust Volume control	Replace Lamp
No Picture, no sound	●	●	●	●	●	●							
Sound OK, picture poor	●			●	●	●	●	●	●				
Picture OK, sound poor	●			●	●	●	●	●				●	
Picture blurred	●			●	●	●	●	●					
Lines or streaks in picture				●	●	●	●	●					
Poor reception on some channels				●	●	●	●	●					
Picture rolls vertically				●				●					
No color	●			●	●	●	●			●			
Poor color	●			●	●	●	●			●	●		
Dark Picture								●	●				●

HITACHI Liquid Crystal Display incorporates advanced power surge protection technology designed to protect against component or circuit damage due to external or internal voltage power surges.

IF YOUR TELEVISION SHOULD APPEAR TO HAVE A LOSS OF POWER, PLEASE FOLLOW THIS PROCEDURE:

1. Press the power switch (ON/OFF switch) once.
2. If there is still no power, wait 30 seconds and press the power switch again.
3. If there is still no power, unplug the power cord from the wall. Wait 30 seconds and plug the power cord back in. Press the power switch again.

This protective technology should provide for years of lasting entertainment from your HITACHI Liquid Crystal Display.



USEFUL INFO

Features:

- Superfine Picture Quality
1280 Line Horizontal Resolution
- Remote (Controls many PVR/VCR brands, cable boxes, satellite boxes, and other audio equipment).
- New AV Network System Control (Control up to 4 components with one remote, 2 IR Mouse Cables included).
- New Easy-to-Use (3-Language) On-Screen Menu
- Full Set of Input Jacks, including S-VIDEO
- COMPONENT VIDEO: Y-P_B/P_R
- Six Aspect Modes
- Closed Caption Decoder
- 2-Tuner Picture in Picture
- 2 Antenna Inputs (Either for Analog/Digital)
- Video Input Sensor
- 3 Dimensional Y/C Comb Filter
- Compatible with 1080i, 720p, 480p and 480i input signals.
- HDMI (High Definition Multimedia Interface) (High Bandwidth Digital Content Protection V1.1 compatible).
- Digital Audio Output (Dolby® Digital and PCM)
- Photo Input (for your digital camera).
- CableCARD™ compatible - Contact your local cable operator for more information.
- **BBE** Technology.
*Licensed by BBE Sound, Inc. under USP4638258, 5510752 and 5736897. BBE and BBE symbol are registered trademarks of BBE Sound, Inc. Manufactured under license from BBE Sound, Inc.
- **SRS** Technology.
*SRS and  symbol are trademarks of SRS Labs, Inc. SRS technology is incorporated under license from SRS Labs, Inc.
- **DOLBY DIGITAL** Technology.
*Manufactured under license from Dolby Laboratories. "Dolby" and the double-D symbol are trademarks of Dolby Laboratories.
- **HDMI** Technology
*HDMI, the HDMI logo and High-Definition Multimedia Interface are trademarks or registered trademarks of HDMI Licensing LLC.

Inputs:

- Power InputAC 120V, 60Hz
- Stand-by Power0.6W
- Power Consumption
- Refer to rear panel at the back of the T.V.
- Antenna input impedance75 Ohm
- Channel coverage181ch.
VHF-Band2 ~ 13
UHF-Band14 ~ 69
CATV Mid BandA-5 ~ A-1
.A-1
Super BandJ-W
Hyper BandW+1 - W+28
Ultra BandW+29 - W+84
- Video1.0Vp-p, 75 Ohm
- S-Video
Luminance (Y)1.0Vp-p, 75 Ohm
Chrominance (C)0.286Vp-p, 75 Ohm
- Component Video
Luminance (Y)1.0Vp-p, 75 Ohm
Chrominance (P_B/P_R)0.7Vp-p, 75 Ohm
- Audio input Impedance47k Ohm
- Average input level470mVrms
- HDMIHDMI 19pin
- IEEE 13942 Inputs

Outputs:

- Video1.0Vp-p, 75 Ohm
- Audio (Fixed)470mVrms, 1k Ohm
- S-Video
Luminance (Y)1.0Vp-p, 75 Ohm
Chrominance (C)0.286Vp-p, 75 Ohm
- Optical Out (Digital Audio)1 optical connector

Dimensions:

	50VX915	60VX915	70VX915
• Height (in.)	28 11/16	33 9/16	40 9/16
(mm)	728.0	853.0	1,030.0
• Width (in.)	55 3/8	64 1/8	73 9/16
(mm)	1,407.0	1,629.0	1,868.0
• Depth (in.)	16 6/16	19 1/16	23 7/8
(mm)	415.8	483.8	605
• Weight (lbs.)	110.2	132.3	182
(kg)	50.0	60.0	82.5

NOTE: Due to improvements, specifications in this operating guide are subject to change without notice.



HITACHI

*Service
hotline*

To locate an authorized
HITACHI service facility
in the continental U.S.A.
and Canada,

DIAL TOLL FREE

7 days a week, 24 hours a day

800 HITACHI

(1-800-448-2244)

Hitachi America, LTD. Home Electronics Division

Hitachi has made every effort to assure you hours of trouble free operation from your unit. However, should you require service, a network of Hitachi Authorized Service Facilities has been established in all 50 states and Puerto Rico. Each facility will provide you with convenient and expedient assistance. Our service hotline operator will direct you to the Hitachi Authorized Service Facility nearest you. Just present proof of purchase and/or delivery receipts to the Hitachi Authorized Service Facility, and service will be rendered in accordance with the terms of the limited warranty as stated on your warranty card or operating guide.

Should you have any questions regarding warranty, service, operation, or technical assistance, please contact:

**Hitachi America, LTD.
Home Electronics Division
900 Hitachi Way
Chula Vista, CA 91914-3556**



USEFUL INFO

Hitachi Canada, LTD. Digital Media Division

Should you have any questions regarding warranty, service, operation, or technical assistance, please contact:

**In Canada:
1-800-HITACHI
(1-800-448-2244)**

**Monday - Friday EST 9:00am - 7:00pm
Saturday EST 9:00am - 5:00pm**

*Look for your French Manual on the outside of the box.
If the manual is missing, call*

**1-800-HITACHI
(1-800-448-2244)**

for a copy.

Pour de plus amples renseignements sur le service durant la période couverte par la garantie, sur le fonctionnement ou pour de l'assistance technique communiquez avec:

**Au Canada:
1-800-HITACHI
(1-800-448-2244)**

**Lundi - Vendredi L'EST 9:00am - 7:00pm
Samedi L'EST 9:00am - 5:00pm**

*La version français de votre manual se trouve a l'exterieur de la boîte.
Si le manuel est manquant, coposez le*

**1-800-HITACHI
(1-800-448-2244)**

pour obtenir votre copie.

**HITACHI CANADA, LTD.
6740 Campobello Road
Mississauga, ON L5N 2L8**



A	
Accessories	4
Antennas (Connecting)	5,6
Aspect Ratio	29,61
Audio (Sound Enhancement)	
SRS	58
BBE	58
Digital Output	60
Audio Settings	58-60
Audio Source	59
Auto Color	57
Auto Noise Cancel	59
Audio Video Network (AV NET)	23-26, 31-32
B	
Balance	58
Bass	58
Black Enhancement	55
Brightness	55
C	
CableCARD	13, 78
Channel Manager	62-63
Auto Channel Scan	62
Antenna Setup	62
Clock	
Time	69
Date	69
Closed Captions	
Analog Captions	77
Digital Captions	77
Color Management	56
Color Temperature	55
Color	55
Contrast	55
D	
DVI Input	20
E	
Event Timer	71
H	
HDMI	12, 20
I	
IEEE1394	22, 36
Input Setup	76
Inputs Button	33
L	
Lamp	
Lamp Indicator	9
Lamp Replacement	80-83
Language	
Menu Language	74
Locks	
Change Access Code	64
Channel Lock	64
Input Lock	64
Front Panel Lock	64
TV Time Lock	64
Movie Ratings	65
TV Ratings	66
TV Ratings (Canadian - English)	67
TV Ratings (Canadian - French)	68
Loudness	59
M	
Menu Preference	
Language	74
Background	75
Monitor Out	11, 78
N	
Noise Reduction	57
P	
Perfect Volume	59
Photo Input	34-35
Picture Mode	54
Picture-in-Picture (PIP)	39-41
Picture-outside-Picture (POP)	39
Power Button	8
Power Indicator	9
R	
Remote Control	
Functions	27-50
Programming Codes	49-50
Installing Batteries	4
S	
Sharpness	55
Speakers	59
Connecting External Speakers	5, 16
T	
Temperature Indicator	9
Time	69
Timers	69-73
Tint	55
Treble	58
V	
Vertical Position	61
Video Settings	54-57

END USER LICENSE AGREEMENT FOR HITACHI DTV SOFTWARE

IMPORTANT – READ CAREFULLY: This License Agreement is a legal agreement between you and Hitachi America, Ltd., Home Electronics Division ("HAL-HED"). By using this Hitachi digital television (the "DTV") and its software (the "Software"), you agree to be bound by the terms of this License Agreement. IF YOU DO NOT AGREE TO BE BOUND BY THIS LICENSE AGREEMENT, DO NOT USE THIS DTV AND ITS SOFTWARE.

The Software is protected by copyright laws and international copyright treaties, as well as other intellectual property laws and treaties. The Software is licensed, not sold.

1. LICENSE GRANT. Subject to all of the terms, conditions and restrictions of this License Agreement, HAL-HED grants to you a limited, revocable, non-exclusive right to use one copy of the Software only on one Hitachi labeled DTV owned by you.

2. RIGHTS AND LIMITATIONS. Software Not for Resale. You may not resell or otherwise transfer for value the Software, except that you may transfer the Software as part of a resale of the entire DTV product only. Prohibition on Reverse Engineering, Decompilation, Disassembly and/or Modification. You may not reverse engineer, decompile, disassemble or modify the Software. Separation of Components. The Software is licensed as single product. Its component parts may not be separated for use on more than one DTV. No Transfers. You may not transfer, assign, rent, lease, lend or in any way sublicense the Software. Trademarks. This License Agreement does not grant you any rights to any trademarks. Third Party Software. You shall not use the Software in combination with any third party software.

3. VIOLATIONS; INDEMNITY. You understand that any use, copying or transfer of the Software, except as permitted pursuant to this License Agreement, constitutes a violation of legal rights and may subject you to damages and an award to HAL-HED of attorneys' fees in connection with any violation of this License. You further understand that you may be held legally responsible for any copyright infringement or other violation of intellectual property rights that is caused or encouraged by your failure to abide by the terms of this License Agreement. You agree to defend, indemnify and hold HAL-HED and its parent and affiliate companies harmless from and against any and all liability resulting from any breach by you of this License Agreement and/or any use by you of the Software in combination with third party software.

4. COPYRIGHT. All title and intellectual property rights in and to the Software (including but not limited to any images, photographs, animation, video, audio, music, text, and "applets" incorporated into the Software), and any accompanying printed materials are owned by HAL-HED. All title and intellectual property rights in and to the content which may be accessed through use of the Software is the property of the respective content owner and may be protected by applicable copyright or other intellectual property laws and treaties. This License Agreement grants you no rights to use such content. All rights not expressly granted are reserved by HAL-HED. This provision applies to U.S. Government end-users, who are granted only those rights expressly set forth herein.

5. EXPORT RESTRICTIONS. HAL-HED is licensing the Software for use within North America only. You agree that you will not export or re-export the Software. You specifically agree not to export or re-export the Software: (i) to any country to which the U.S. has embargoed or restricted the export of goods or services, which currently include, but are not necessarily limited to Cuba, Iran, Iraq, Libya, North Korea, Sudan, and Syria, or to any national of any such country, wherever located, who intends to transmit or transport the Software back to such country; (ii) to any person or entity who you know or have reason to know will utilize the Software in the design, development, or production of nuclear, chemical, or biological weapons; or (iii) to any person or entity who has been prohibited from participating in U.S. export transactions by any federal agency of the U.S. government. You warrant and represent that neither the Bureau of Export Administration (BXA) nor any other U.S. Federal Agency has suspended, revoked, or denied your export privileges.

6. NO WARRANTIES. THE SOFTWARE IS PROVIDED "AS-IS, WHERE-IS." HAL-HED MAKES NO WARRANTIES OF ANY KIND WHATSOEVER REGARDING THE SOFTWARE AND, TO THE MAXIMUM EXTENT PERMITTED BY LAW, HEREBY EXPRESSLY DISCLAIMS ALL WARRANTIES OF ANY KIND WHATSOEVER, EXPRESS OR IMPLIED, WITH RESPECT TO THE SOFTWARE. ALL IMPLIED WARRANTIES, INCLUDING WITHOUT LIMITATION, THE IMPLIED WARRANTIES OF NON-INFRINGEMENT, MERCHANTABILITY AND FITNESS FOR A PARTICULAR PURPOSE ARE HEREBY EXPRESSLY DISCLAIMED TO THE MAXIMUM EXTENT PERMITTED BY LAW.

END USER LICENSE AGREEMENT FOR HITACHI DTV SOFTWARE

7. LIMITATION OF LIABILITY. IN NO EVENT SHALL HAL-HED OR ANY OF ITS PARENT OR AFFILIATE COMPANIES BE LIABLE TO YOU OR ANY THIRD PARTY FOR ANY DIRECT, INDIRECT, INCIDENTAL, SPECIAL, EXEMPLARY, OR CONSEQUENTIAL DAMAGES (INCLUDING, BUT NOT LIMITED TO, PROCUREMENT OF SUBSTITUTE GOODS OR SERVICES; LOSS OF USE, DATA, OR PROFITS; LOSS OF GOODWILL, EXPENDITURES MADE OR COMMITTED FOR IN RELIANCE ON THE CONTINUATION OF THIS LICENSE AGREEMENT OR BUSINESS INTERRUPTION) HOWEVER CAUSED AND ON ANY THEORY OF LIABILITY, WHETHER IN CONTRACT, STRICT LIABILITY, OR TORT (INCLUDING NEGLIGENCE OR OTHERWISE) ARISING IN ANY WAY OUT OF THE USE OF THE SOFTWARE, EVEN IF ADVISED OF THE POSSIBILITY OF SUCH DAMAGE.

8. NO FAILURE OF ESSENTIAL PURPOSE. YOU AGREE THAT NO FAILURE TO REPAIR A DEFECT, ERROR OR BUG IN THE SOFTWARE SHALL CONSTITUTE A FAILURE OF THE ESSENTIAL PURPOSE OF THIS LICENSE AGREEMENT.

9. CRYPTOGRAPHIC SOFTWARE. THIS PRODUCT CONTAINS SOFTWARE DEVELOPED BY THE OpenSSL PROJECT INCLUDING CRYPTOGRAPHIC SOFTWARE WRITTEN BY ERIC YOUNG (THE "CRYPTOGRAPHIC SOFTWARE"). THE CRYPTOGRAPHIC SOFTWARE IS PROVIDED BY THE OpenSSL PROJECT "AS IS" AND ANY EXPRESSED OR IMPLIED WARRANTIES, INCLUDING BUT NOT LIMITED TO, THE IMPLIED WARRANTIES OF MERCHANTABILITY AND FITNESS FOR A PARTICULAR PURPOSE ARE HEREBY EXPRESSLY DISCLAIMED TO THE MAXIMUM EXTENT PERMITTED BY LAW. IN NO EVENT SHALL THE OpenSSL PROJECT, ITS CONTRIBUTORS, HAL-HED OR ANY OF ITS PARENT OR AFFILIATE COMPANIES BE LIABLE FOR ANY DIRECT, INDIRECT, INCIDENTAL, SPECIAL, EXEMPLARY, OR CONSEQUENTIAL DAMAGES (INCLUDING, BUT NOT LIMITED TO, PROCUREMENT OF SUBSTITUTE GOODS OR SERVICES; LOSS OF USE, DATA, OR PROFITS; OR BUSINESS INTERRUPTION) HOWEVER CAUSED AND ON ANY THEORY OF LIABILITY, WHETHER IN CONTRACT, STRICT LIABILITY, OR TORT (INCLUDING NEGLIGENCE OR OTHERWISE) ARISING IN ANY WAY OUT OF THE USE OF THE SOFTWARE OR THE CRYPTOGRAPHIC SOFTWARE, EVEN IF ADVISED OF THE POSSIBILITY OF SUCH DAMAGE.

10. TERMINATION. This License Agreement may be terminated at any time by HAL-HED effective immediately upon notice to you.

11. GOVERNING LAW; SEVERABILITY. This Agreement shall be governed and construed in accordance with the laws of the State of California, without regard to its conflict of laws rules, and any disputes hereunder shall be subject to the exclusive jurisdiction and venue of the U.S. Federal Courts in the Southern District of California. If any part of this License Agreement is unenforceable, the remainder shall be valid and binding to the maximum extent permitted by applicable law.

NOTES





NOTES



HITACHI

Free Manuals Download Website

<http://myh66.com>

<http://usermanuals.us>

<http://www.somanuals.com>

<http://www.4manuals.cc>

<http://www.manual-lib.com>

<http://www.404manual.com>

<http://www.luxmanual.com>

<http://aubethermostatmanual.com>

Golf course search by state

<http://golfingnear.com>

Email search by domain

<http://emailbydomain.com>

Auto manuals search

<http://auto.somanuals.com>

TV manuals search

<http://tv.somanuals.com>