

# HITACHI

## PROJECTION COLOR TV

**53UDX10B**  
**43FDX11B**

**61UDX10B**  
**43FDX10B**

## OPERATING GUIDE



**IMPORTANT SAFETY INSTRUCTIONS** 2-4



**FIRST TIME USE** 5-19



**THE GENIUS  
REMOTE CONTROL** 20-32



**ULTRATEC BIT-MAP  
ON-SCREEN DISPLAY** 33-60

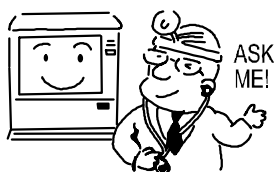

**USEFUL INFORMATION INDEX** 61-67





As an ENERGY STAR<sup>®</sup> Partner, Hitachi, Ltd. has determined that this product meets the ENERGY STAR<sup>®</sup> guidelines for energy efficiency.





## IMPORTANT

Follow all warnings and instructions marked on this projection television.

 <table border="1"><tr><td><b>WARNING</b></td></tr><tr><td>RISK OF ELECTRIC SHOCK DO NOT OPEN</td></tr></table> 	<b>WARNING</b>	RISK OF ELECTRIC SHOCK DO NOT OPEN	 <p>The lightning flash with arrowhead symbol, within an equilateral triangle, is intended to alert the user to the presence of uninsulated dangerous voltage within the product's enclosure that may be of a sufficient magnitude to constitute a risk of electric shock to persons.</p>
<b>WARNING</b>			
RISK OF ELECTRIC SHOCK DO NOT OPEN			
<p>CAUTION: TO REDUCE THE RISK OF ELECTRIC SHOCK, DO NOT REMOVE COVER (OR BACK). NO USER SERVICEABLE PARTS INSIDE. REFER SERVICING TO QUALIFIED SERVICE PERSONNEL.</p>	 <p>The exclamation point within an equilateral triangle, is intended to alert the user to the presence of important operating and maintenance (servicing) instructions in the literature accompanying the appliance.</p>		

**WARNING:**  
TO REDUCE THE RISK OF FIRE OR ELECTRIC SHOCK, DO NOT EXPOSE THIS APPARATUS TO RAIN OR MOISTURE.

**NOTE:** ¥There are no user serviceable parts inside the television.  
¥Model and serial numbers are indicated on back side of the television.  
¥This television is not intended for use in a computer room.

**CAUTION:** Adjust only those controls that are covered in the instructions, as improper changes or modifications not expressly approved by HITACHI could void the user's warranty.



**MODIFICATIONS:** The FCC requires the user to be notified that any changes or modifications made to this device that are not expressly approved by Hitachi America, Ltd. Home Electronics Division may void the user's warranty.

### POWER SOURCE

This projection television is designed to operate on 120 Volts 60Hz, AC current.  
Insert power cord into a 120 Volt 60Hz outlet.

**TO PREVENT ELECTRIC SHOCK, DO NOT USE THE TELEVISION'S (POLARIZED) PLUG WITH AN EXTENSION CORD, RECEPTACLE, OR OTHER OUTLET UNLESS THE BLADES AND GROUND TERMINAL CAN BE FULLY INSERTED TO PREVENT BLADE EXPOSURE.**

**NEVER CONNECT THE TELEVISION TO 50HZ, DIRECT CURRENT, OR ANYTHING OTHER THAN THE SPECIFIED VOLTAGE.**

**NOTE:** This television receiver will display television closed captioning, ( or ) , in accordance with paragraph 15.119 of the FCC rules.

 **CAUTION:** Never remove the back cover of the television as this can expose you to very high voltages and other hazards. If the television does not operate properly, unplug the television and call your authorized dealer or service shop.



## IMPORTANT SAFETY INSTRUCTIONS

- CAUTION:**
- ¥ Read these instructions.
  - ¥ Keep these instructions.
  - ¥ Heed all warnings.
  - ¥ Follow all instructions.

### SAFETY POINTS YOU SHOULD KNOW ABOUT YOUR HITACHI PROJECTION TELEVISION

Our reputation has been built on the quality, performance, and ease of service of HITACHI televisions.

Safety is also foremost in our minds in the design of these units. To help you operate these products properly, this section illustrates safety tips which will be of benefit to you. Please read it carefully and apply the knowledge you obtain from it to the proper operation of your HITACHI television.

Please fill out your warranty card and mail it to HITACHI. This will enable HITACHI to notify you promptly in the improbable event that a safety problem should be discovered in your product model.

### FOR YOUR PERSONAL SAFETY

1. Do not defeat the safety purpose of the polarized or grounding-type plug. A polarized plug has two blades with one wider than the other. A grounding type plug has two blades and a third grounding prong. The wide blade or the third prong are provided for your safety. If the provided plug does not fit into your outlet, consult an electrician for replacement of the obsolete outlet.

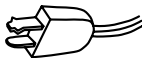

2. When the power cord or plug is damaged or frayed, unplug the television from the wall outlet and refer servicing to qualified service personnel.

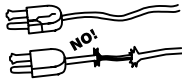

3. Do not overload wall outlets and extension cords as this can result in fire or electric shock.

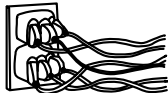

4. Protect the power cord from being walked on or pinched particularly at plugs, convenience receptacles, and the point where they exit from the apparatus.



5. Do not attempt to service the television yourself as opening or removing covers may expose you to dangerous voltage or other hazards. Refer all servicing to qualified service personnel.



6. Never push objects of any kind into the television's cabinet slots as they may touch dangerous voltage points or short out parts that could result in a fire or electric shock. Never spill liquid of any kind on the television.

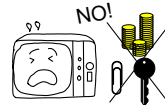

7. If the television has been dropped or the cabinet has been damaged, unplug the television from the wall outlet and refer servicing to qualified service personnel.



8. Refer all servicing to qualified service personnel. Servicing is required when the apparatus has been damaged in any way, such as power-supply cord or plug is damaged, liquid has been spilled or objects have fallen into the apparatus, the apparatus has been exposed to rain or moisture, does not operate normally, or has been dropped.



9. Do not subject your television to impact of any kind. Be careful not to damage the picture tube surface.



10. Clean only with dry cloth



11-1. Do not place the television on an unstable cart, stand, or table. The television may fall, causing serious injury to a child or an adult, and serious damage to the appliance. Use only with a cart or stand recommended by the manufacturer, or sold with the television. Wall or shelf mounting should follow the manufacturer's instructions, and should use a mounting kit approved by the manufacturer.



11-2. Use only with the cart, stand, tripod, bracket, or table specified by the manufacturer, or sold with the apparatus. When a cart is used, use caution when moving the cart/apparatus combination to avoid injury from tip-over.



### PROTECTION AND LOCATION OF YOUR TELEVISION

12. Do not use this apparatus near water.



¥ Never expose the television to rain or water. If the set has been exposed to rain or water, unplug television from wall outlet and refer to qualified service personnel.

13. Choose a place where light (artificial or sunlight) does not shine directly on the screen.

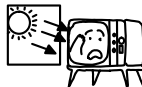

14. Avoid dusty places. Accumulated dust inside the chassis may cause failure of the television when high humidity persists.



15. The television has slots or openings in the cabinet for ventilation purposes which provide reliable operation of the receiver and protect the television from overheating. These openings must not be blocked or covered.

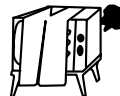

¥ Do not block any ventilation openings. Install in accordance with the manufacturer's instructions.

¥ Never cover the slots or openings with cloth or other material.

¥ Never block the bottom ventilation slots of the television by placing it on a bed, sofa, rug, etc.



¥ Do not install near any heat sources such as radiators, heat registers, stoves, or other apparatus (including amplifiers) that produce heat.



¥ Never place the television near or over a radiator or heat generator.



¥ Never place the television in a built-in enclosure unless proper ventilation is provided.



## PROTECTION AND LOCATION OF YOUR TELEVISION

16-1. If an outside antenna is connected to the television, be sure the antenna system is grounded so as to provide some protection against voltage surges and built-up static charges. Section 810 of the National Electrical Code, NFPA No. 70-1975, provides information with respect to proper grounding of the mast and supporting structure, grounding of the lead-in wire to an antenna discharge unit, size of grounding conductors, location of antenna discharge unit connection to grounding electrode, and requirements for the grounding electrode.

16-2. **Note to CATV system installer:** (Only for television with CATV reception). This reminder is provided to call the CATV system installer's attention to Article 820-40 of the NEC that provides guidelines for proper grounding and, in particular, specifies that the cable ground shall be connected to the grounding system of the building, as close to the point of cable entry as practical.

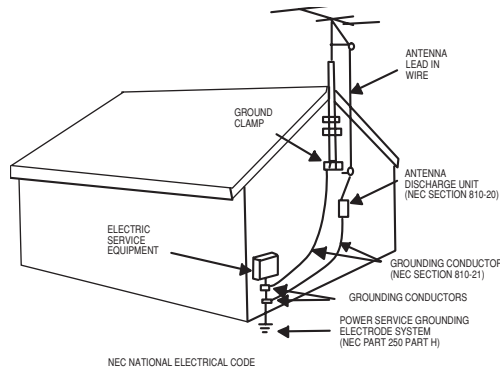

EXAMPLE OF ANTENNA GROUNDING AS PER NATIONAL ELECTRICAL CODE INSTRUCTIONS.

17. An outside antenna system should not be located in the vicinity of overhead power lines or other electrical lights or power circuits, or where it can fall into such power lines or circuits. When installing an outside antenna system, extreme care should be taken to keep from touching such power lines or circuits as contact with them might be fatal.

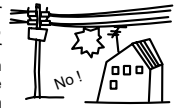

18. For added protection for the television during a lightning storm, or when it is unused for long periods of time, unplug it from the wall outlet and disconnect antenna. This will prevent damage due to lightning and power-line surges.



## OPERATION OF YOUR TELEVISION

19. This television should be operated only from the type of power source indicated on the marking label. If you are not sure of the type of power supply at your home, consult your dealer or local power company.



20. If the television does not operate normally by following the operating instructions, unplug the television from the wall outlet and refer servicing to qualified service personnel. Adjust only those controls that are covered in the instructions as improper adjustment of other controls may result in damage and will often require extensive work by a qualified service technician to restore the television to normal operation.



21. If your television is to remain unused for a period of time, (such as when going on a holiday), turn the television OFF and unplug it from the wall outlet.



## IF THE TELEVISION DOES NOT OPERATE PROPERLY

22. If you are unable to restore normal operation by following the detailed procedure in your operating instructions, do not attempt any further adjustments. Unplug the television and call your dealer or service technician.



23. Whenever the television is damaged or fails, or if there is a distinct change in performance that indicates a need for service, unplug the television and have it checked by a qualified service technician.

24. It is normal for some televisions to make occasional snapping or popping sounds, particularly when being turned on or off. If the snapping or popping is continuous or frequent, unplug the set and consult your dealer or service technician.

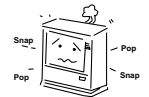

## FOR SERVICING AND MODIFICATION

25. Do not use attachments not recommended by the television manufacturer as they may cause hazards.



26. If replacement parts are required, be sure the service technician has used replacement parts specified by the manufacturer that have the same characteristics as the original part. Unauthorized substitutions may result in fire, electric shock, or other hazards.

27. Upon completion of any service or repairs to the television, ask the service technician to perform routine safety checks to determine that the television is in safe operating condition.

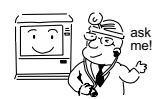

## PICTURE CAUTIONS

### Picture Burn Prevention

¥ Continuous on-screen displays such as video games, stock market quotations, computer generated graphics, and other fixed (non-moving) patterns can cause permanent damage to projection television receivers. Such PATTERN BURNS constitute misuse and are **NOT COVERED** by your HITACHI Factory Warranty.

¥ When using Picture-in-Picture function, the sub-picture should not be left permanently in one corner of the screen or a PATTERN BURN may develop over a long period of time.

### Public Viewing of Copyrighted Material

Public viewing of programs broadcast by TV stations and cable companies, as well as programs from other sources, may require prior authorization from the broadcaster or owner of the video program material.

# ACCESSORIES

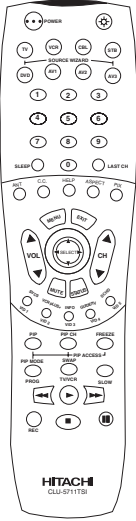
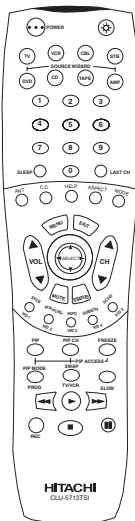
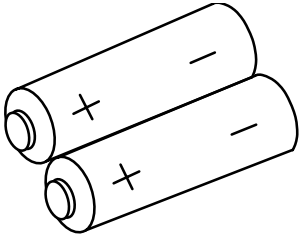
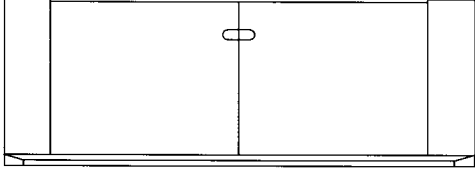

Check to make sure you have the following accessories before disposing of the packing material.

 <p>CLU-5711TSI 1.</p>	 <p>CLU-5713TSI 1.</p>	 <p>2.</p>
PART NAME	PART NO.	ILLUSTRATION
43" TELEVISION STAND SP-43H (Not included, order separately) OPTIONAL	H530047	
CUSTOM HITACHI TELEVISION STAND Excellent for VCR and video-tape storage. Special features include smoked glass doors and an adjustable shelf. Available in shark grey.		



**CAUTION:** Television stand model SP-43H is designed for use with a 43 inch or smaller television set. Use of a smaller stand, a non Hitachi recommended stand or a generic stand may result in instability, causing possible injury.

1. Remote Control Unit CLU-5711TSI (Part No. HL01641), or Remote Control Unit CLU-5713TSI (Part No. HL01643).
2. Two AA size, 1.5V batteries (For Remote Control Unit).

## REMOTE CONTROL BATTERY INSTALLATION AND REPLACEMENT

1. Open the battery cover of the remote control by pushing the notched part of the cover with your fingers and pulling the cover off.
2. Insert two new AA size batteries for the remote control. When replacing old batteries, push them towards the springs and lift them out.
3. Match the batteries to the (+) and (-) marks in the battery compartment.
4. Replace the cover.

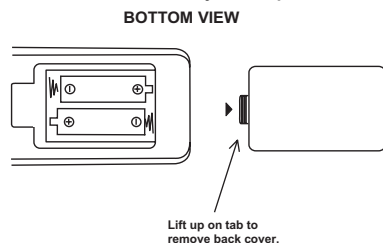

**CAUTION:** Danger of explosion if battery is incorrectly replaced. Replace with the same or equivalent type.



# HOW TO SET UP YOUR NEW HITACHI PROJECTION TV

## ANTENNA

Unless your TV is connected to a cable TV system or to a centralized antenna system, a good outdoor color TV antenna is recommended for best performance. However, if you are located in an exceptionally good signal area that is free from interference and multiple image ghosts, an indoor antenna may be sufficient.

## LOCATION

Select an area where sunlight or bright indoor illumination will not fall directly on the picture screen. Also, be sure that the location selected allows a free flow of air to and from the perforated back cover of the set.

To avoid cabinet warping, cabinet color changes, and increased chance of set failure, do not place the TV where temperatures can become excessively hot, for example, in direct sunlight or near a heating appliance, etc.

## VIEWING

The major benefit of the HITACHI Projection Television is its large viewing screen. To see this large screen at its best, test various locations in the room to find the optimum spot for viewing.

The best picture is seen by sitting directly in front of the TV and about 10 to 18 feet from the screen. Picture brightness decreases as the viewer moves to the left and right of the receiver.

During daylight hours, reflections from outside light may appear on the screen. If so, drapes or screens can be used to reduce the reflection or the TV can be located in a different section of the room.

If the TV's audio output will be connected to a Hi-Fi system's external speakers, the best audio performance will be obtained by placing the speakers equidistant from each side of the receiver cabinet and as close as possible to the height of the picture screen center. For best stereo separation, place the external speakers at least four feet from the side of the TV, place the surround speakers to the side or behind the viewing area. Differences in room sizes and acoustical environments will require some experimentation with speaker placement for best performance.

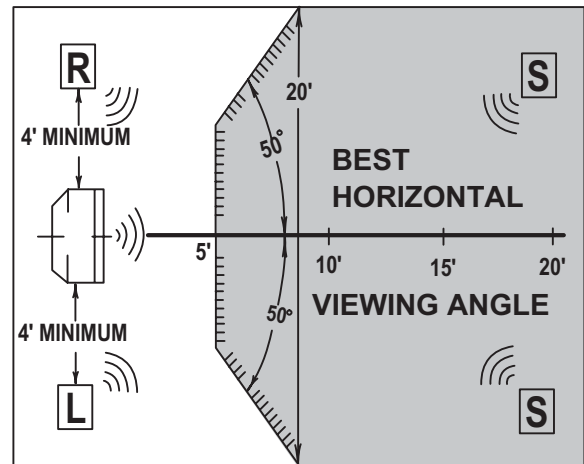
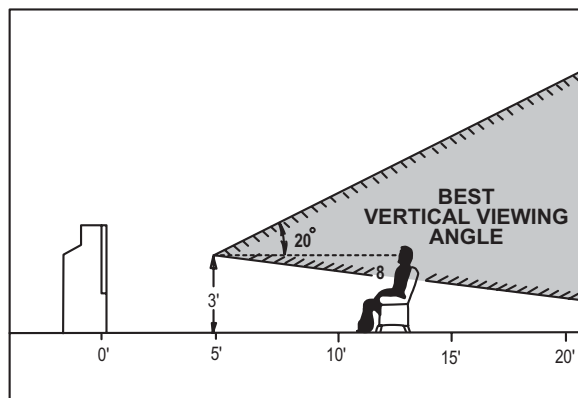

**CAUTION:** Magnetic fields, such as those of external speakers, may cause the picture to distort if they are placed too close to the television. Move the magnetic field source away from the television until there is no picture distortion.



# HOOK-UP CABLES AND CONNECTORS

Most video/audio connections between components can be made with shielded video and audio cables that have phono connectors. For best performance, video cables should use 75-Ohm coaxial shielded wire. Cables can be purchased from most stores that sell audio/video products. Below are illustrations and names of common connectors. Before purchasing any cables, be sure of the output and input connector types required by the various components and the length of each cable.

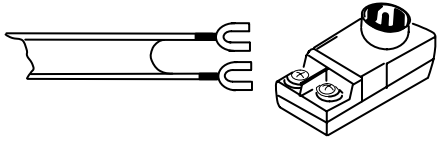

### 300-Ohm Twin Lead Connector

This outdoor antenna cable must be connected to an antenna adapter (300-Ohm to 75-Ohm).



### "F" Type 75-Ohm Coaxial Antenna Connector

For connecting RF signals (antenna or cable TV) to the antenna jack on the television.

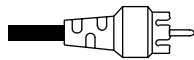

### Phono Connector

Used on all standard video and audio cables which connect to inputs and outputs located on the television's rear jack panel and front control panel.



### S-VIDEO (Super Video) Connector

This connector is used on camcorders, VCRs, and laserdisc players with an S-VIDEO feature in place of the standard video cable to produce a high quality picture.

## ANTENNA CONNECTIONS TO REAR JACK PANEL

### VHF (75-Ohm) antenna/CATV (Cable TV)

When using a 75-Ohm coaxial cable system, connect the outdoor antenna or CATV coaxial cable to the ANT A (75-Ohm) terminal. If you have a second antenna or cable TV system, connect the coaxial cable to the ANT B terminal.

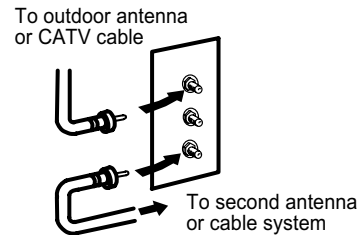

### VHF (300-Ohm) antenna/UHF antenna

When using a 300-Ohm twin lead from an outdoor antenna, connect the VHF or UHF antenna leads to screws of the VHF or UHF adapter. Plug the adapter into the antenna terminal on the TV.

To outdoor VHF or UHF antenna



### When both VHF and UHF antennas are connected

Attach an optional antenna cable mixer to the TV antenna terminal, and connect the cables to the antenna mixer. Consult your dealer or service store for the antenna mixer.

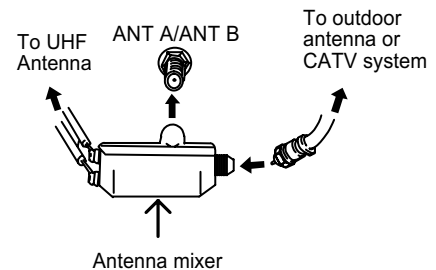



# FRONT PANEL CONTROLS

## FRONT VIEW

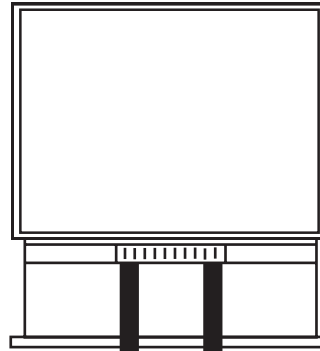

Models: 61UDX10B, 53UDX10B

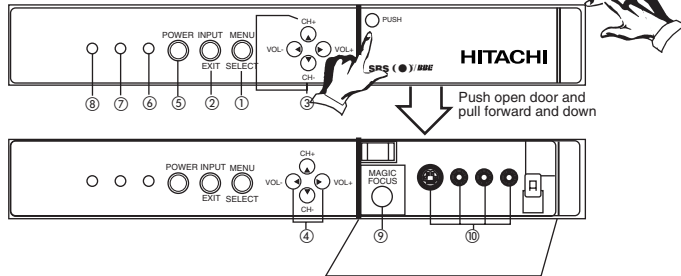

Models: 43FDX11B, 43FDX10B

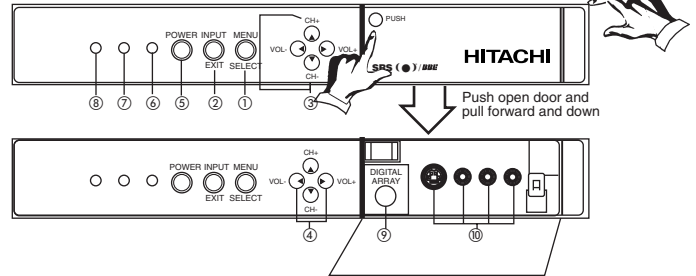

### ① MENU/SELECT button

This button allows you to enter the MENU, making it possible to set TV features to your preference without using the remote. This button also serves as the SELECT button when in MENU mode.

### ② INPUT/EXIT button

Press this button to select the current antenna source, VIDEO: 1, 2, 3, 4, 5 or alternate antenna source. Your selection is shown in the top right corner of the screen. This button also serves as the EXIT button when in MENU mode.

**NOTES:** Your remote control does not have an INPUT button. To change to video inputs, press VID1~VID5 buttons depending on your choice (see page 23).

### ③ CHANNEL selector

Press these buttons until the desired channel appears in the top right corner of the TV screen. These buttons also serve as the cursor down (▼) and up (▲) buttons when in MENU mode.

### ④ VOLUME level

Press these buttons for your desired sound level. The volume level will be displayed on the TV screen. These buttons also serve as the cursor left (◀) and right (▶) buttons when in MENU mode.

### ⑤ POWER button

Press this button to turn the TV on or off.

**NOTES:** 1. Your HITACHI Projection TV will appear to be turned OFF if there is no video input when VIDEO: 1, 2, 3, 4 or 5 is selected. Check the Power Light to make sure the TV is turned off when not in use.  
2. To see an auto-demonstration of the on-screen displays with HELP text displayed, press and hold the POWER button on the TV set for approximately five seconds. Press the POWER button on the TV again to end the auto-demonstration.





## FRONT PANEL CONTROLS

---

- ⑥ **POWER light**  
You will see a red light when the TV is turned on.
  
- ⑦ **PERFECT PICTURE sensor**  
The Perfect Picture sensor will make automatic picture adjustments depending on the amount of light in the room to give the best picture. (see page 54)
  
- ⑧ **REMOTE CONTROL sensor**  
Point your remote at this area when selecting channels, adjusting volume, etc.
  
- ⑨ **DIGITAL ARRAY (Model: 43FDX10B/43FDX11B)**  
**MAGIC FOCUS (Models: 53UDX10/61UDX10B)**  
Use this button to adjust your picture quality to optimum performance. (see pages 42 and 43)
  
- ⑩ **FRONT INPUT JACKS (for VIDEO: 3)**  
Use these audio/video jacks for a quick hook-up from a camcorder or VCR to instantly view your favorite show or new recording. Press the INPUT button until VIDEO: 3 appears in the top right corner of the TV screen. If you have mono sound, insert the audio cable into the left audio jack.



# FRONT PANEL JACKS AND CONNECTIONS

The front panel jacks are provided as a convenience to allow you to easily connect a camcorder or VCR as shown in the following examples:

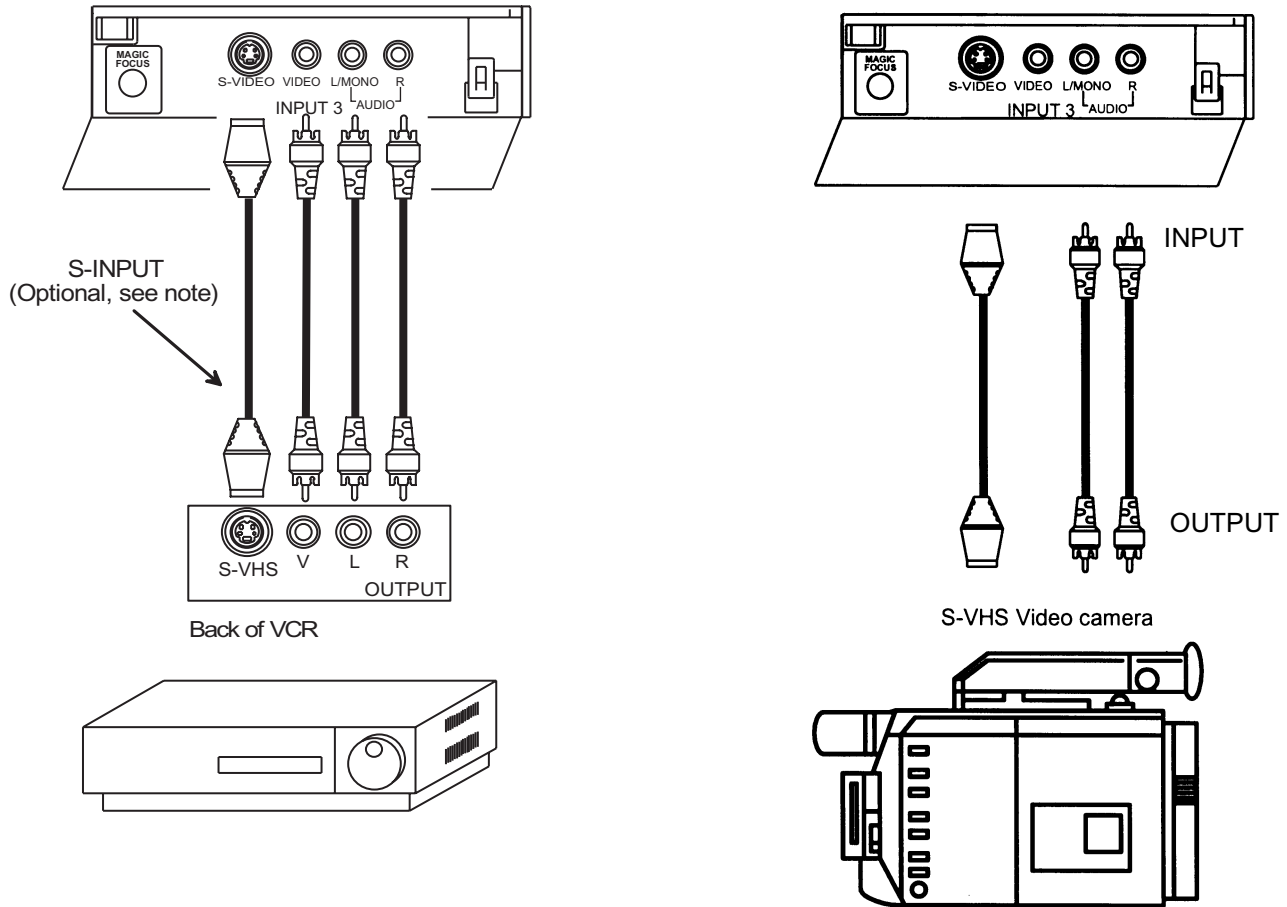

- NOTE:**
1. Completely insert connection cord plugs when connecting to front panel jacks. If you do not, the played back picture may be abnormal.
  2. If you have a S-VHS VCR, use the S-INPUT cable in place of the standard video cable.
  3. If you have a mono VCR, insert the audio cable into the left audio jack of your TV.

# REAR PANEL JACKS

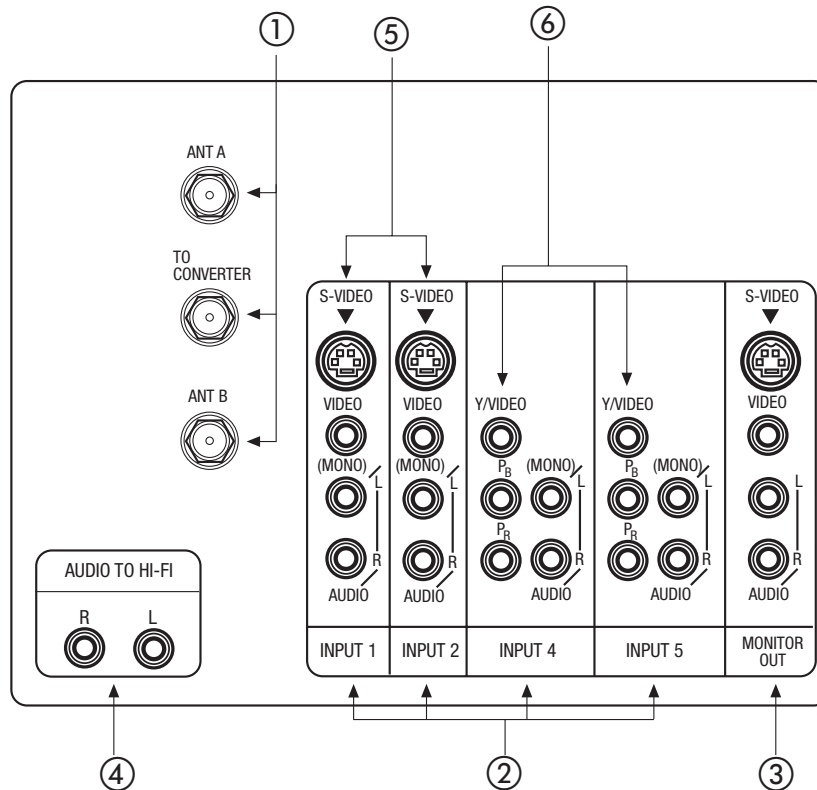

## ① Antenna Input/Output

The remote control allows you to switch between two separate 75-Ohm RF antenna inputs, ANT A and ANT B. ANT A input can be displayed as a main picture or sub-picture. ANT B can only be displayed as a main picture. (ANT B cannot be displayed as a sub-picture.) The antenna output labeled TO CONVERTER allows the ANT A connection to pass directly to a different source such as a cable box, only when ANT B is displayed as a main picture.

## ② Audio/Video Inputs 1, 2, 4 and 5

The VID1~VID5 buttons will select each video source each time it is pressed. Use the audio and video inputs to connect external devices, such as VCRs, camcorders, laserdisc players, DVD players etc. (If you have mono sound, insert the audio cable into the left audio jack.)

**NOTE:** You may use VIDEO or S-VIDEO inputs to connect to INPUT 1 and 2, but only one of these inputs may be used at a time.

## ③ MONITOR OUT

These jacks provide fixed audio and video signals which are used for recording. Use the S-VIDEO Output for high quality video output.

**NOTE:** S-VIDEO Output may be used for recording, only when the input is of S-VIDEO type.

## ④ AUDIO TO HI-FI Output

These jacks provide variable audio output to a separate stereo amplifier. With this connection, the audio to the stereo can be controlled by the television's main volume.

## ⑤ S-VIDEO Inputs 1 and 2

Inputs 1 and 2 provide S-VIDEO (Super Video) jacks for connecting equipment with S-VIDEO output capability.



### ⑥ Component: Y-P<sub>B</sub>P<sub>R</sub> Inputs

Inputs 4 and 5 provide Y-P<sub>B</sub>P<sub>R</sub> jacks for connecting equipment with this capability, such as a DVD player or Set Top Box. You may use standard video signal for INPUT:4 and 5.

- NOTES:**
1. Your component outputs may be labeled Y, B-Y, and R-Y. In this case, connect the components B-Y output to the TV's P<sub>B</sub> input and the components R-Y output to the TV's P<sub>R</sub> input.
  2. Your component outputs may be labeled Y-C<sub>B</sub>C<sub>R</sub>. In this case, connect the component C<sub>B</sub> output to the TV's P<sub>B</sub> input and the component C<sub>R</sub> output to the TV's P<sub>R</sub> input.
  3. It may be necessary to adjust TINT to obtain optimum picture quality when using the Y-P<sub>B</sub>P<sub>R</sub> inputs. (See pages 53 and 54)
  4. To ensure no copyright infringement, the MONITOR OUT output will be abnormal, when using the Y-P<sub>B</sub>P<sub>R</sub> jacks.
  5. When using Y-P<sub>B</sub>P<sub>R</sub> input, only 480i signal can be viewed as a sub-picture.
  6. Input 4 and 5 (Y/VIDEO) can be used for standard video input.

# REAR PANEL CONNECTIONS



## TYPICAL FULL-FEATURE SETUP

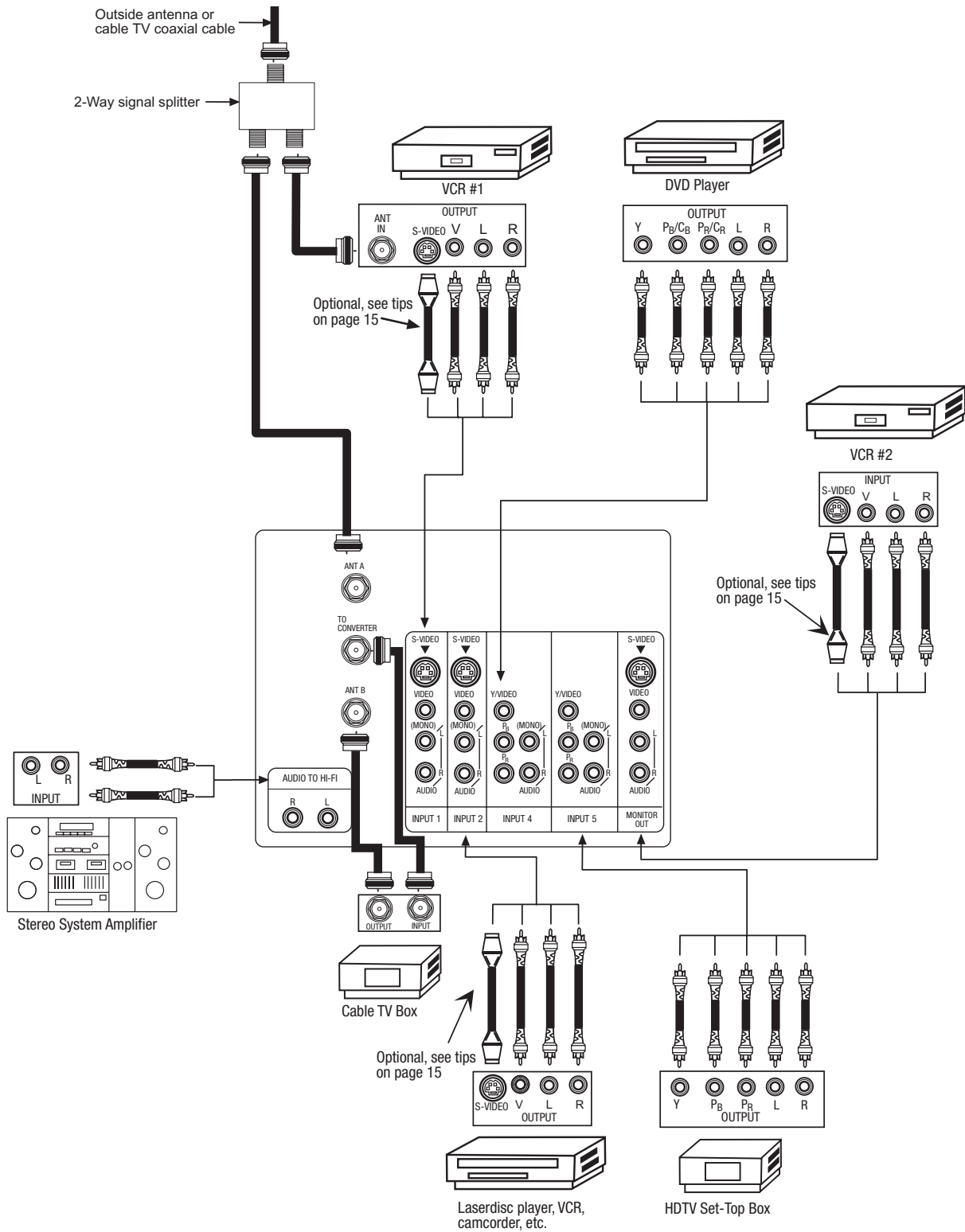

**NOTE:**

1. Connect only 1 component to each input jack.
2. Follow connections that pertain to your personal entertainment system.



# TIPS ON REAR PANEL CONNECTIONS

## TIPS ON REAR PANEL CONNECTIONS

S-VIDEO connections are provided for high performance laserdisc players, VCRs etc. that have this feature. Use these connections in place of the standard video connection if your device has this feature.

If your device has only one audio output (mono sound), connect it to the left audio jack on the television.

Refer to the operating guide of your other electronic equipment for additional information on connecting your hook-up cables.

A single VCR can be used for VCR #1 and VCR #2, but note that a VCR cannot record its own video or line output (INPUT: 1 in the example on page 13). Refer to your VCR operating guide for more information on line input-output connections.

You may use VIDEO or S-VIDEO inputs to connect to Input 1 or Input 2, but only one of these may be used at a time.

Connect only 1 component (VCR, DVD player, camcorder, etc.) to each input jack.

COMPONENT: Y-P<sub>B</sub>P<sub>R</sub> (Input 4 &5) connections are provided for high performance components, such as DVD players and set-top-boxes. Use these connections in place of the standard video connection if your device has this feature.

Your component outputs may be labeled Y, B-Y, and R-Y. In this case, connect the components B-Y output to the TV's P<sub>B</sub> input and the components R-Y output to the TV's P<sub>R</sub> input.

Your component outputs may be labeled Y-C<sub>B</sub>C<sub>R</sub>. In this case, connect the components C<sub>B</sub> output to the TV's P<sub>B</sub> input and the components C<sub>R</sub> output to the TV's P<sub>R</sub> input.

You may use standard video signal for INPUT:4 and 5.

It may be necessary to adjust TINT to obtain optimum picture quality when using the Y-P<sub>B</sub>P<sub>R</sub> inputs. (See pages 53 and 54)

To ensure no copyright infringement, the MONITOR OUT output will be abnormal, when using the Y-P<sub>B</sub>P<sub>R</sub> jacks.



# CONNECTING EXTERNAL AUDIO SOURCES

## CONNECTING EXTERNAL AUDIO AMPLIFIER

To control the audio level of an external audio amplifier with the remote control, connect the system as shown below.

### REAR PANEL OF TELEVISION

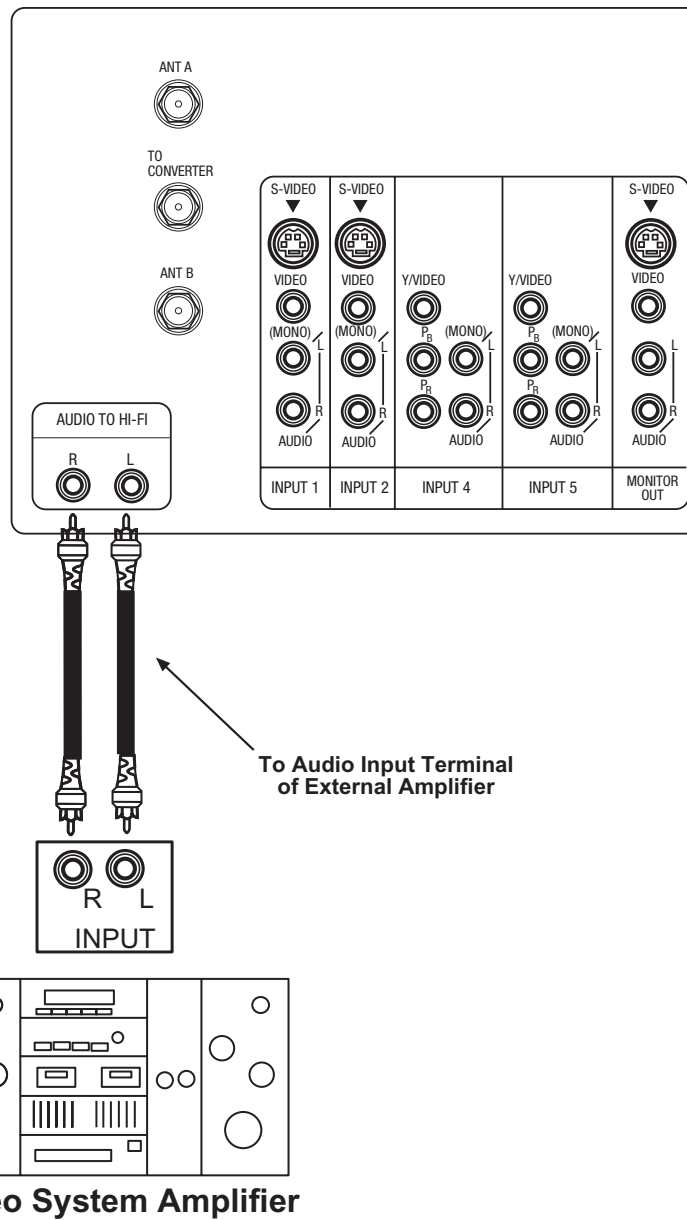

**NOTE:** To prevent damage to the speaker and distorted sound, set the volume control of the audio amplifier lower and adjust the sound using the remote control of the TV set.



# CONNECTING EXTERNAL VIDEO SOURCES

The exact arrangement you use to connect the VCR, camcorder, laserdisc player, DVD player, or HDTV Set Top Box to your TV set is dependent on the model and features of each component. Check the owner's manual of each component for the location of video and audio inputs and outputs.

The following connection diagrams are offered as suggestions. However, you may need to modify them to accommodate your particular assortment of components and features. For best performance, video and audio cables should be made from coaxial shielded wire.

## Before Operating External Video Source

The input mode is changed every time the VID1~VID5 button is pressed as shown below. Connect an external source to the INPUT terminal, then press the VID1~VID5 button as necessary to view the input source. (See page 27)

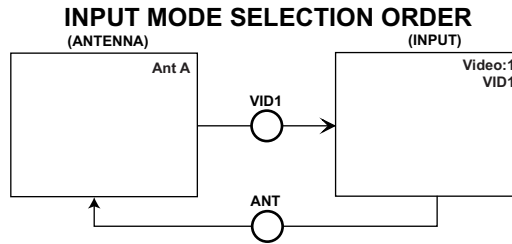

**NOTE:** When the TV is set to VIDEO and a video signal is not received from the VIDEO INPUT JACK on the back panel of the TV (i.e., VCR/laserdisc player, etc. is not connected or the video device is OFF), the set will appear to be OFF.

## CONNECTING A MONAURAL AUDIO SOURCE TO INPUT1~INPUT5

1. Connect the cable from the VIDEO OUT of the VCR or the laserdisc player to the INPUT (VIDEO) jack, as shown on the TV set below.
2. Connect the cable from the AUDIO OUT of the VCR or the laserdisc player to the INPUT (MONO)/L(AUDIO) jack.
3. Press the VID1~VID5 button to view the program from the VCR or the laserdisc player. The VIDEO mode disappears automatically after approximately eight seconds.
4. Press the ANT button to return to the previous channel.

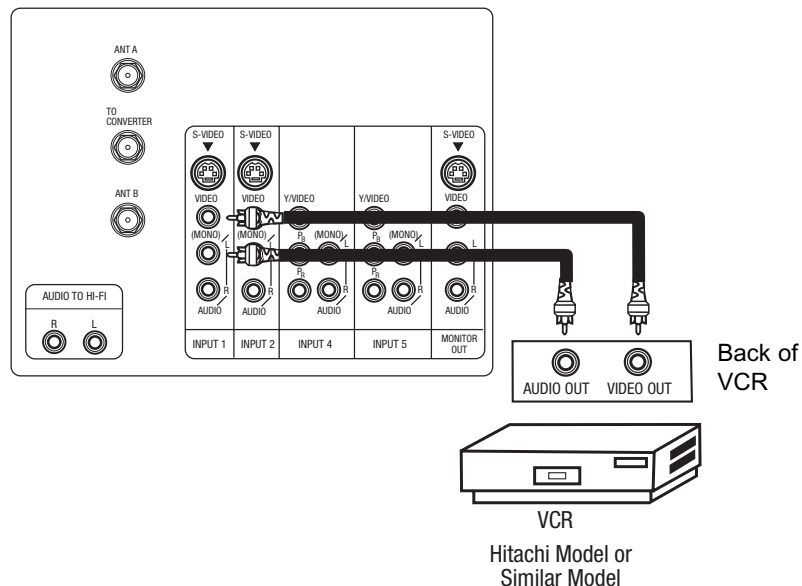





# CONNECTING EXTERNAL VIDEO SOURCES

## CONNECTING A STEREO SOURCE TO INPUT1~INPUT5

1. Connect the cable from the VIDEO OUT of the VCR or the laserdisc player to the INPUT (VIDEO) jack, as shown on the TV set below.
2. Connect the cable from the AUDIO OUT R of the VCR or the laserdisc player to the INPUT (AUDIO/R) jack.
3. Connect the cable from the AUDIO OUT L of the VCR or the laserdisc player to the INPUT (AUDIO/L) jack.
4. Press the VID1~VID5 button to view the program from the VCR or laserdisc player. The VIDEO icon disappears automatically after approximately eight seconds.
5. Press the ANT button to return to the previous channel.

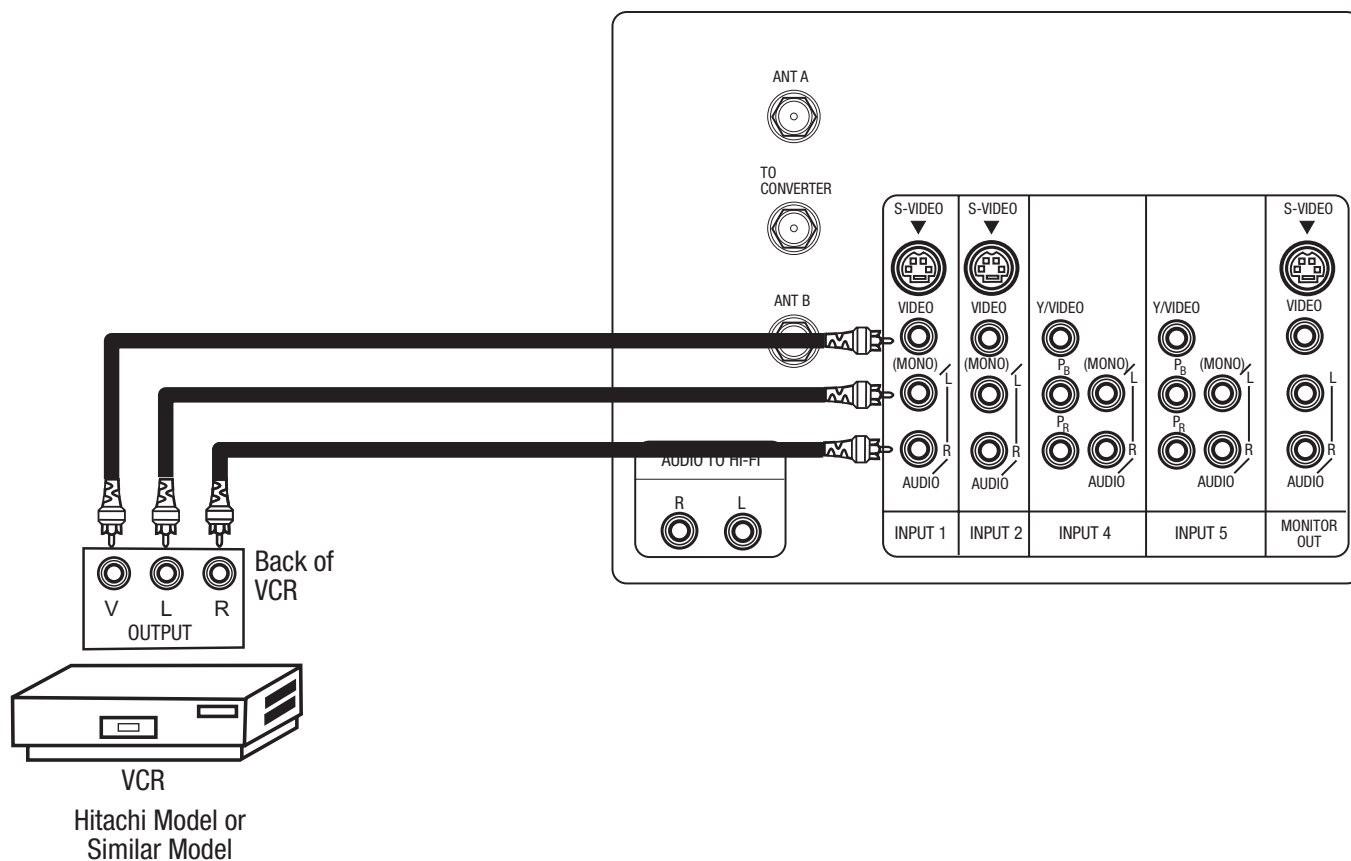

- NOTES:**
1. Completely insert the connection cord plugs when connecting to rear panel jacks. The picture and sound that is played back will be abnormal if the connection is loose.
  2. A single VCR can be used for VCR #1 and VCR #2, but note that a VCR cannot record its own video or line output. (INPUT: 1 in example on page 13) Refer to your VCR operating guide for more information on line input-output connections.



# CONNECTING EXTERNAL VIDEO SOURCES

## CONNECTING AN S-VIDEO SOURCE TO INPUT 1, 2 AND 3

1. Connect the cable from the S-VIDEO OUT of the VCR or the laserdisc player to the INPUT (S-VIDEO) jack, as shown on the TV set below.
2. Connect the cable from the AUDIO OUT R of the VCR or the laserdisc player to the INPUT (AUDIO/R) jack.
3. Connect the cable from the AUDIO OUT L of the VCR or the laserdisc player to the INPUT (AUDIO/L) jack.
4. Press the VID1~VID3 button to view the program from the VCR or laserdisc player. The VIDEO icon disappears automatically after approximately eight seconds.
5. Press the ANT button to return to the previous channel.

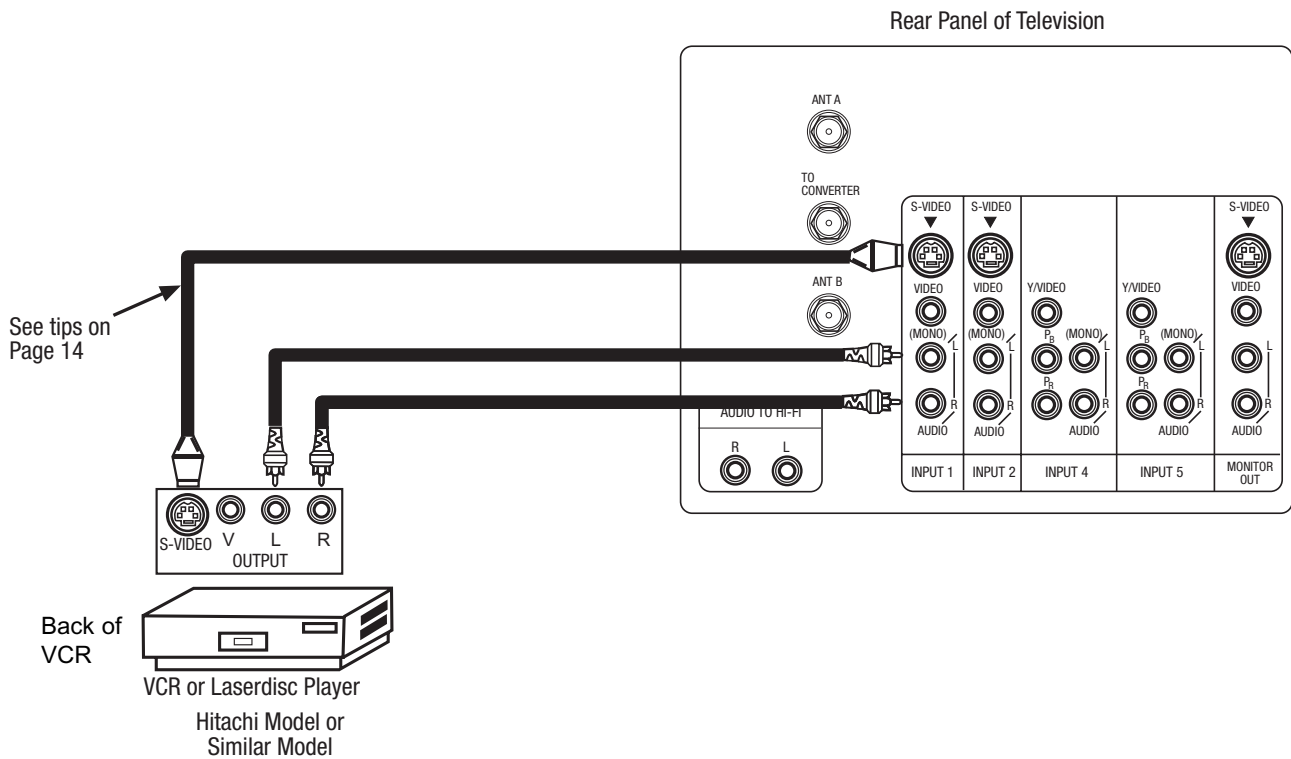

- NOTES:**
1. Completely insert the connection cord plugs when connecting to rear panel jacks. The picture and sound that is played back will be abnormal if the connection is loose.
  2. A single VCR can be used for VCR #1 and VCR #2, but note that a VCR cannot record its own video or line output. (INPUT: 1 in example on page 13) Refer to your VCR operating guide for more information on line input-output connections.



# CONNECTING EXTERNAL VIDEO SOURCES

## CONNECTING A COMPONENT SOURCE TO VIDEO 4 OR 5: Y-P<sub>B</sub>P<sub>R</sub>.

1. Connect the cable from the Y OUT of the Laserdisc/DVD player or HDTV set top box to the INPUT (Y) jack, as shown on the TV set below.
2. Connect the cable from the C<sub>B</sub>/P<sub>B</sub> OUT or B-Y OUT of the Laserdisc/DVD player or HDTV set top box to the INPUT (P<sub>B</sub>) jack.
3. Connect the cable from the C<sub>R</sub>/P<sub>R</sub> OUT or R-Y OUT of the Laserdisc/DVD player or HDTV set top box to the INPUT (P<sub>R</sub>) jack.
4. Connect the cable from the AUDIO OUT R of the Laserdisc/DVD player or HDTV set top box to the INPUT (AUDIO/R) jack.
5. Connect the cable from the AUDIO OUT L of the Laserdisc/DVD player or HDTV set top box to the INPUT (AUDIO/L) jack.
6. Press the VID4~VID5 button, to view the program from the Laserdisc/DVD player or HDTV set top box. The VIDEO icon disappears automatically after approximately eight seconds.
7. Press the ANT button to return to the previous channel.

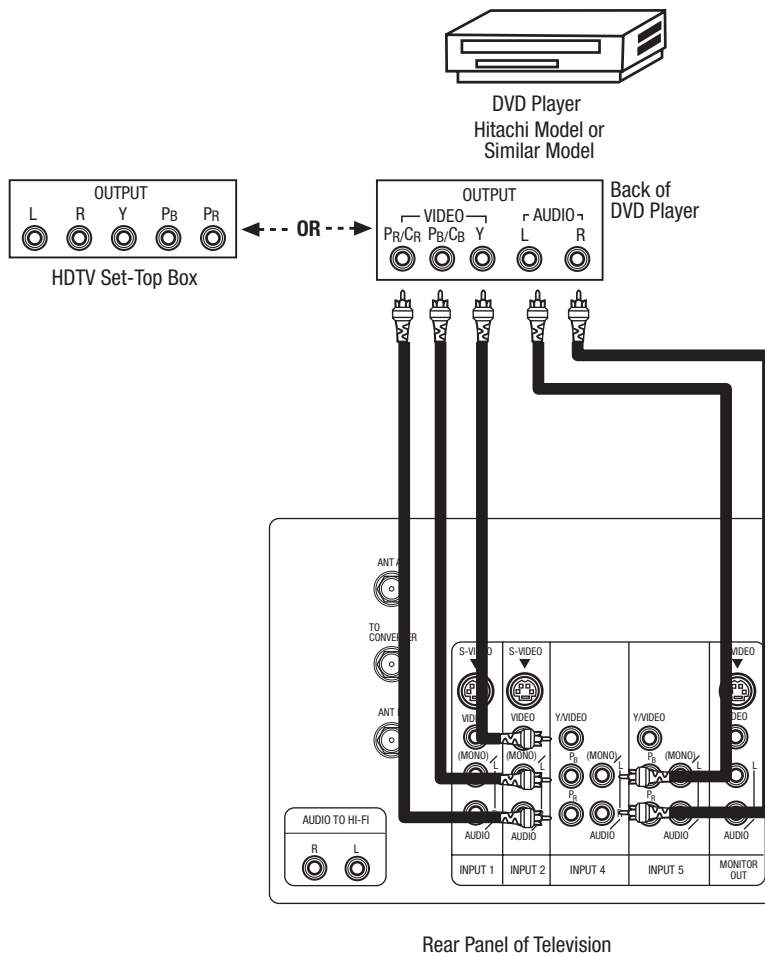

- NOTE:**
1. You may use standard video signal for INPUT:4 and 5.
  2. Completely insert the connection cord plugs when connecting to rear panel jacks. The picture and sound that is played back will be abnormal if the connection is loose.
  3. See page 14 for tips on REAR PANEL CONNECTIONS.



# THE GENIUS REMOTE CONTROL

In addition to controlling all the functions on your HITACHI Projection TV, the new remote control is designed to operate different types of VCRs, CATV (Cable TV) converters, set-top-box, satellite receiver, DVD players, and other audio/video equipment with one touch. Basic operation keys are grouped together in one area.

To operate your TV, point the remote control at the remote sensor of the TV and press the TV button. The TV button will blink, indicating that the remote will now control your television.

To operate your VCR, point the remote at the remote sensor of the VCR and press the VCR button. The VCR button will blink, indicating that the remote will now control your VCR. (See page 27 for instructions on how to program the remote to control your VCR.)

To operate your cable box, point the remote at the remote sensor of the cable box and press the CABLE (CBL) button. The CBL button will blink, indicating that the remote will now control your cable box. (See page 28 for instructions on how to program the remote to control your cable box.)

To operate your set-top-box, point the remote at the remote sensor of the set-top-box and press the SET-TOP-BOX (STB) button. The STB button will blink, indicating that the remote will now control your set-top-box. If you have a satellite receiver, use this button to program your satellite receiver. (See page 29 for instructions on how to program the remote to control your set-top-box.)

To operate your DVD player, point the remote at the remote sensor of the DVD player and press the DVD button. The DVD button will blink, indicating that the remote will now control your DVD player. (See page 30 for instruction on how to program the remote to control your DVD player.)

To operate additional audio/video equipment, point the remote at the remote sensor of the component you wish to control and press the AV1, AV2 or AV3 button. This button will blink, indicating that the remote will now control the desired component. (See page 31 for instructions on how to program the remote to control additional Audio/Video equipment.)

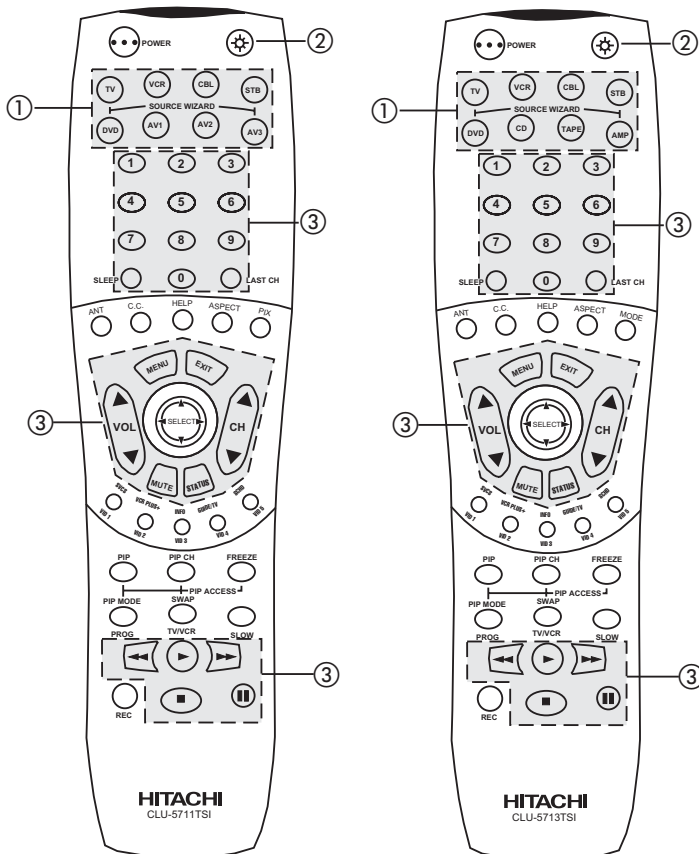

① These buttons allow the remote to control your TV, VCR, cable box, satellite receiver, DVD player, or other Audio/Video equipment depending on which mode is chosen, as explained above.

## ②,③ LIGHT BUTTON

When you are in a dark room, press the light button ② on the remote to light up the buttons shown in ③ and the source button will blink. The light will stay on for about 8 seconds if the light button is not pressed again. These buttons will not appear to light if the room is too bright.

**NOTE:** 1. Your remote control SOURCE WIZARD buttons are either labeled as AV1, AV2 and AV3, or CD, TAPE, and AMP. If your remote control SOURCE WIZARD buttons are labeled as AV1, AV2, and AV3, please program your Audio/Video components as follow for best performance. Use AV1 to program your CD brand. Use AV2 to program your TAPE brand, and use AV3 to program your AMPLIFIER/RECEIVER brand.

AV1-Use for CD brand  
AV2-Use for TAPE brand  
AV3-Use for AMPLIFIER/RECEIVER brand.

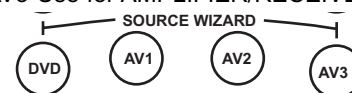

2. Your remote control button to directly access the THEATER MODE is either labeled as PIX or MODE.

# HOW TO USE THE GENIUS REMOTE TO CONTROL YOUR TV

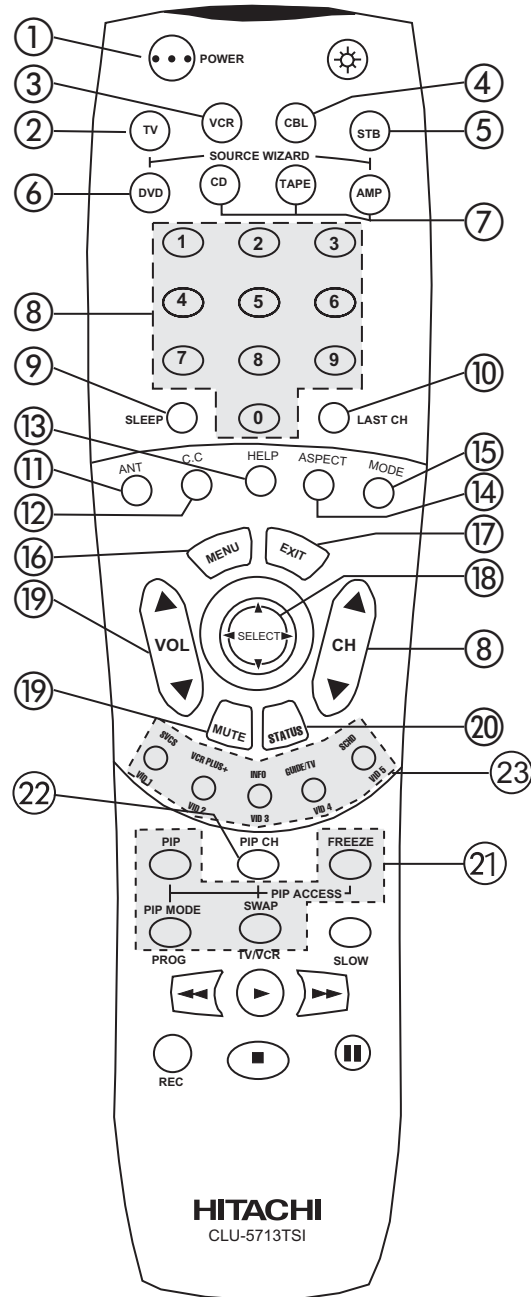
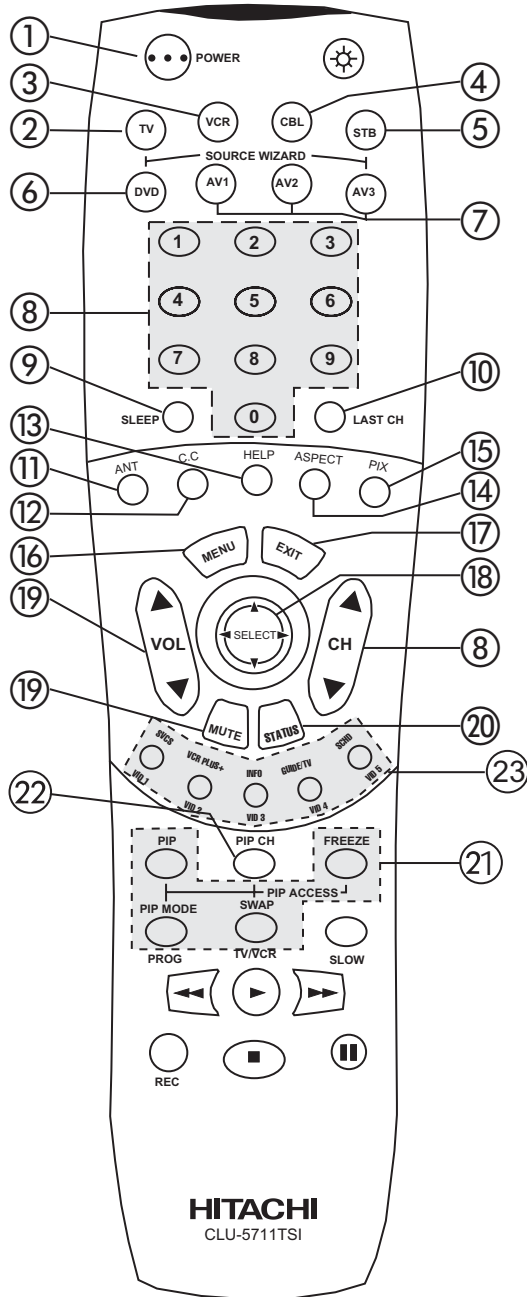

- ① **POWER button**  
Press this button to turn the TV set on or off when the remote is in TV mode. (See page 22 for instructions on how to set the remote control to TV mode.)
- ② **TV button**  
When the TV button is pressed, it will blink, to indicate the remote is in TV mode.
- ③ **VCR button**  
When the VCR button is pressed, it will blink to indicate the remote is in VCR mode. (see page 27)
- ④ **CABLE (CBL)**  
When the CABLE button is pressed, it will blink to indicate the remote is in CABLE mode. (see page 28)
- ⑤ **SET-TOP-BOX (STB)**  
When the STB button is pressed, it will blink to indicate the remote is in STB mode. (see page 29)  
If you have a Satellite receiver, use this button to program your Satellite receiver. (see page 29)
- ⑥ **DVD button**  
When the DVD button is pressed, it will blink to indicate the remote is in DVD mode. (see page 30)



# HOW TO USE THE GENIUS REMOTE TO CONTROL YOUR TV

## 7 AV1, AV2, AV3, or CD, TAPE, AMP buttons

When pressed, each of these buttons will blink to indicate the remote is in Audio/Video mode. (see page 31)

**NOTE:** Your remote control SOURCE WIZARD buttons are either labeled as AV1, AV2 and AV3, or CD, TAPE, and AMP. If your remote control SOURCE WIZARD buttons are labeled as AV1, AV2, and AV3, please program your Audio/Video components as follow for best performance. Use AV1 to program your CD brand. Use AV2 to program your TAPE brand, and use AV3 to program your AMPLIFIER/RECEIVER brand.

AV1-Use for CD brand  
AV2-Use for TAPE brand  
AV3-Use for AMPLIFIER/RECEIVER brand.

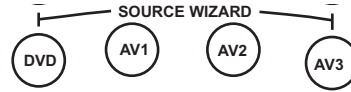

## 8 CHANNEL selector buttons

CHANNEL selector buttons are used to set FAVORITE CHANNELS, CHANNEL MEMORY, etc.

Enter one, two, or three numbers to select channels. Enter 0 first for channels 1 to 9, or simply press the single digit channel you wish to tune then wait a few seconds for the TV to tune. For channels 100 and above, press the 1 button, wait until two dashes appear next to the channel display on your TV, then enter the remaining two numbers using the number buttons.

Channel selection may also be performed by pressing CH up (▲) or down (▼).

**NOTE:** The TV may not receive some channels if you are not in the correct ANTENNA/CABLE mode. (see page 37)

## 9 SLEEP button

Press this button to display the sleep timer in the lower left corner of the screen. Every subsequent press of this button will add 15 minutes to this timer, up to a maximum of three hours. Once set, use STATUS when you want to view time remaining. If the SLEEP button is pressed while the timer is set, it will reset to the original condition.

## 10 LAST CHANNEL (LAST CH) button

Use this button to select between the last two channels viewed. (Good for watching two sporting events, etc.)

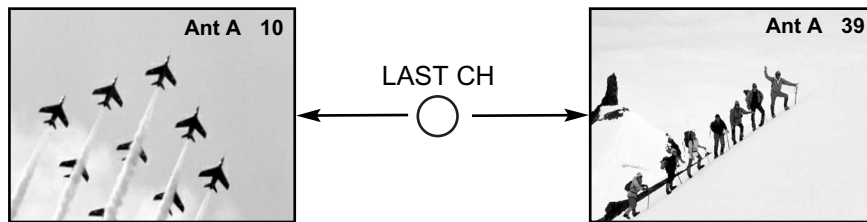

## 11 ANTENNA button

The ANT button will select between Antenna A and Antenna B each time the button is pressed.

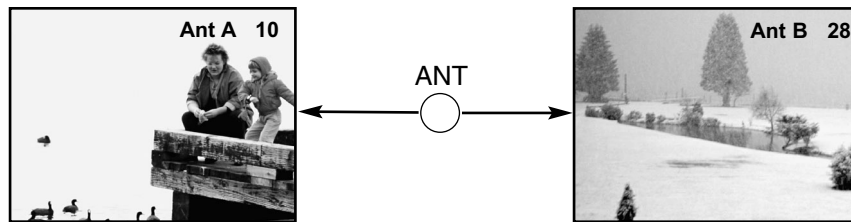

## 12 C.C. button

Press this button to quickly turn the Closed Caption feature on, off and auto (see page 52 for more information).

## 13 HELP button

Press this button when a menu is displayed to view HELP text, which gives a description of the displayed menu. The HELP text will be displayed every time a MENU is displayed, until this button is pressed again.

## 14 ASPECT button

Press this button to quickly change the PICTURE FORMATS aspect ratio. (See page 44 for more information)

## 15 PIX or MODE button

Press this button repeatedly to direct access THEATER MODE between Sport, News, Movie, and Music.

## 16 MENU button

The MENU button will start the On-Screen Display.

## 17 EXIT button

When in MENU mode, this button will exit all On-Screen Displays.

# HOW TO USE THE GENIUS REMOTE TO CONTROL YOUR TV



## 18 THUMB STICK/SELECT button

All the On-Screen Display features can be set or adjusted by using the THUMB STICK.

The THUMB STICK will highlight functions or adjust and set different features. Press the THUMB STICK toward desired direction and press down to SELECT.

## 19 VOLUME, MUTE button

Press the VOLUME up (▲) or down (▼) button until you obtain the desired sound level.

To reduce the sound to one half of normal volume (SOFT MUTE) to answer the telephone, etc., press the MUTE button. Press the MUTE button again to turn the sound off completely (MUTE). To restore the sound, press the MUTE button one more time, or press the VOLUME UP (▲) button.



Closed Captioning will display when MUTE/SOFT MUTE is on and Closed Caption is set to AUTO (See page 54).

## 20 STATUS button

Press this button when no menu is displayed when you want to check the channel being received, the picture source, if the channel has stereo (ST) or second audio program (SAP), the time, CHANNEL ID and if the SLEEP timer is set.

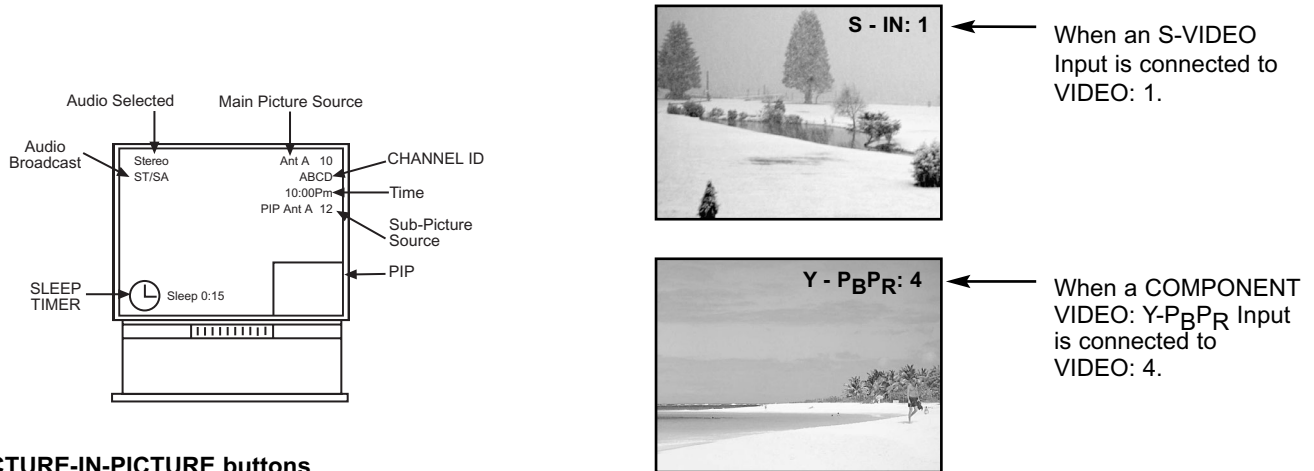

## 21 PICTURE-IN-PICTURE buttons

See separate section on pages 24 and 25 for a description.

## 22 PIP CH button

Use the PIP CH button to select between main picture and sub-picture tuning. The channel number which is highlighted indicates what channel is being controlled.

## 23 VID1 ~ VID5

When the remote control is in TV mode, PRESS these buttons to directly select the video input sources between the five video inputs. When the remote control is in Set-Top-Box mode (STB) these buttons will control the Set-Top-Box.

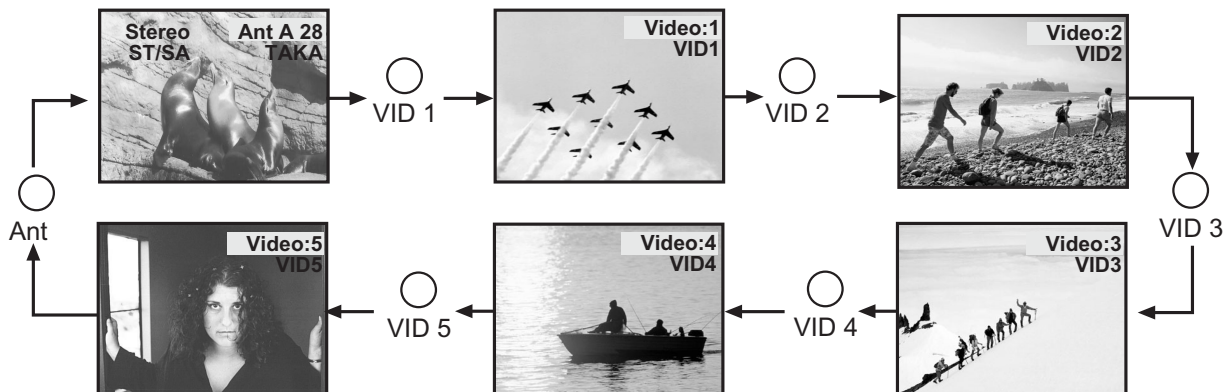



# PICTURE-IN-PICTURE (PIP)

Your HITACHI Projection TV incorporates Dual Tuner technology designed for improved viewing enjoyment. This Dual Tuner feature allows you to view antenna inputs on both the main picture and sub-picture simultaneously, with separate tuning control for each. The Dual Tuner can operate with only one input (ANT A only) or two inputs (ANT A and ANT B).

ANT A input can be viewed as both the main picture and the sub-picture simultaneously. ANT B can only be viewed as a main picture. To select between main picture and PIP sub-picture tuning, press the PIP CH button on the remote. The highlighted channel display will move with every press of the PIP CH button. When the top channel display is highlighted, channel tuning is for the main picture. When the lower channel display is highlighted, channel tuning is for the PIP sub-picture.

The Picture-in-Picture feature is convenient when you want to watch more than one program at the same time. You can watch a TV program while viewing other programs from the ANT A source or any of the video inputs.

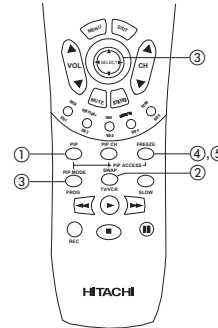
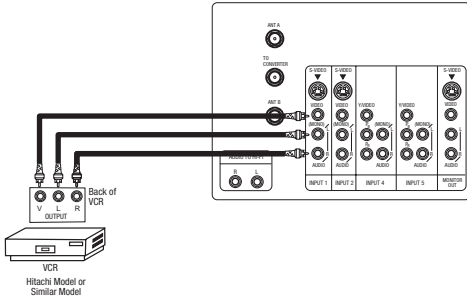

Use above connection to view VCR program as a sub-picture while viewing another program as main picture (ANT A, ANT B, V:2, V:3, V:4, or V:5). You may also view the VCR program as a main picture while viewing another program as a sub-picture (ANT A, V:2, V:3, V:4, or V:5).

## ① PIP button

Press the PIP button and a sub-picture will appear in one of the two different modes (SINGLE or SURF), depending on the last selection of the PIP mode. To change the PIP mode, use the PIP MODE button to cycle through the two different modes.

### SINGLE MODE PIP

Press the PIP button and a sub-picture appears in one corner of the screen. Press the PIP button again to remove the sub-picture from the screen. Use the PIP CH button to select between main and sub-picture tuning control (indicated by highlighted channel display.) Press the VID1, VID2, VID3, VID4 or VID5 button when sub-picture channel tuning is being controlled, to change between VIDEO: 1, VIDEO: 2, VIDEO: 3, VIDEO:4 and VIDEO:5 and ANT:A source. (ANT B source cannot be viewed as a sub-picture.)

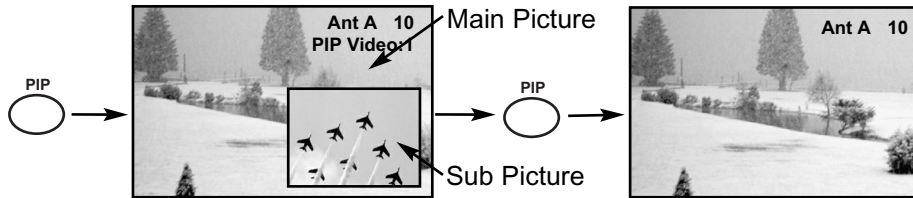

- NOTES:**
1. When using Y-P<sub>B</sub>P<sub>R</sub> input, only 480i signal can be viewed as a sub-picture.
  2. When ANT B is selected as the main channel, the SWAP feature is disabled.
  3. Only sound from the main picture can be heard.



# PICTURE-IN-PICTURE (PIP)



## PICTURE-IN-PICTURE CONT.

### SURF MODE PIP

This feature will automatically scan all active channel numbers (those set in memory) and display them as PIP sub-pictures, along the right edge of the screen. Press the PIP button a second time to remove the sub-pictures from the screen.



- NOTES:**
1. If no buttons are pressed when in SURF mode, auto-scanning will continuously scan channels in memory. (see pages 38 and 39)
  2. If a channel is tuned during this SURF scanning, sub-pictures will be removed from the screen.
  3. SURF MODE PIP is allowed only when ANT A is selected as the main channel.
  4. If PARENTAL CONTROL MOVIE/TV RATINGS setting is ON, PIP SURF mode will be deactivated.
  5. Closed Caption will not appear when PIP SURF mode is on.

### ② SWAP button

If you wish to switch what is being shown on the main picture to the sub-picture, press the SWAP button.

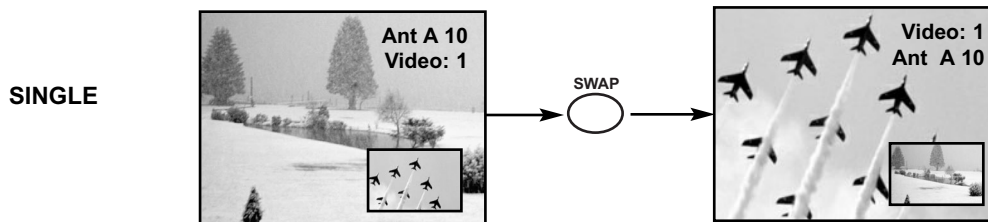

- NOTES:**
1. The SWAP button will only operate in SINGLE PIP mode.
  2. The SWAP function will not operate if ANT B input is set as the main channel (ANT B input cannot be displayed as a sub-picture.)

### ③ PIP MODE button

To change between the two different PIP modes (SINGLE or SURF) press the PIP MODE button when PIP is ON. Each press of this button will change PIP to a different mode. Pressing this button two times will cycle through both PIP modes.

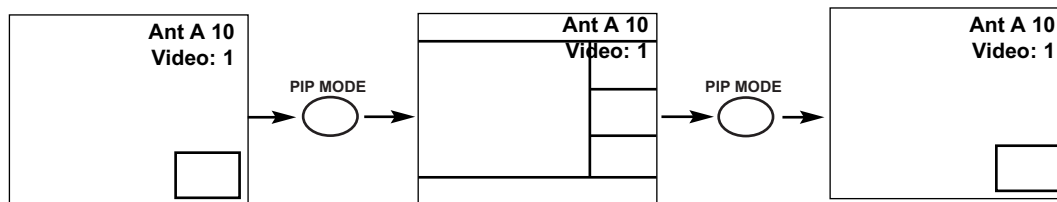

**NOTES:** SURF mode PIP is only allowed when ANT A is the main picture.



# PICTURE-IN-PICTURE (PIP)

## ④ FREEZE button (With PIP ON)

If you wish to freeze the sub-picture, press the FREEZE button. This is convenient when trying to write down the address for a mail order company, recording statistics for a sporting event, etc. To return the picture to motion, press the FREEZE button again.

**NOTE:** The FREEZE function will only operate when SINGLE PIP mode is chosen.

## ⑤ FREEZE button (With PIP OFF)

Press the FREEZE button to freeze the picture, depending on the mode selected (SINGLE or STROBE). To change FREEZE modes, use the PIP MODE button to cycle through the two different modes.

### SINGLE FREEZE

Press the FREEZE button to freeze one frame of the picture you are currently viewing. Press this button again or PIP to return to normal viewing.

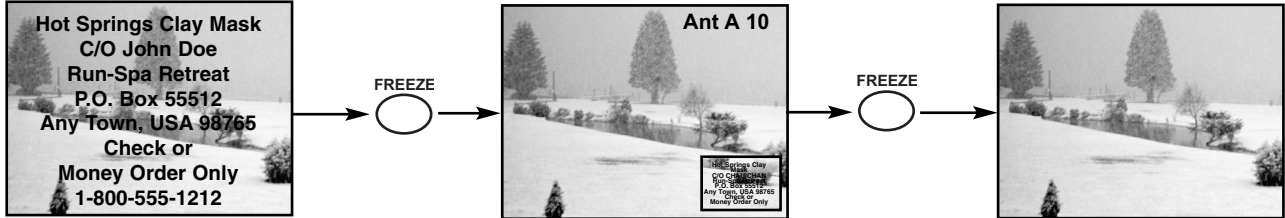

### STROBE FREEZE(with PIP off)

Press the FREEZE button to freeze three frames of the picture you are currently viewing. Press this button again or PIP to return to normal viewing. This feature is useful for viewing a moving picture that has many details, for example, a close play in a sporting event or a golf swing.

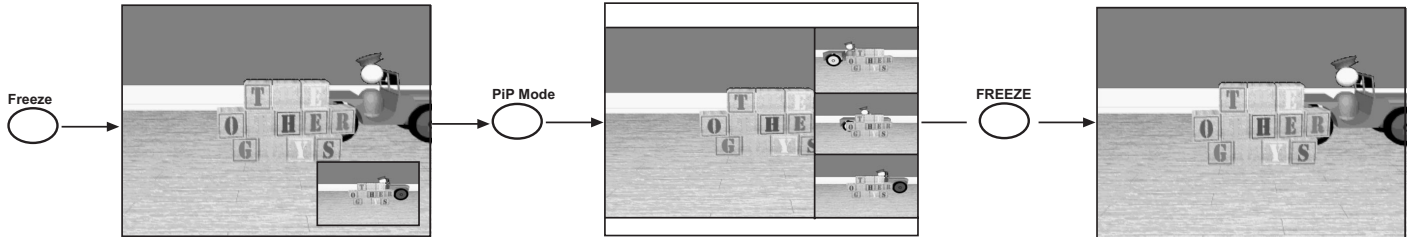

**CAUTION:** A pattern burn may develop if the sub-picture is left in the same corner permanently. If the PIP feature is used frequently, occasionally MOVE the sub-picture using the THUMB STICK ◀, ▶, ▲, or ▼.

**NOTES:** Each freeze frame is delayed about 0.1 (1/10) second.

# USING THE REMOTE TO CONTROL VCR FUNCTIONS



## Operating the pre-coded function for your VCR.

This remote is designed to operate different types of VCRs. You must first program the remote to match the remote system of your VCR. (refer to page 32 for pre-codes)

1. Turn ON your VCR.
2. Aim the remote control at the front of your VCR.
3. Press and release the VCR button to switch to VCR pre-coded mode.
4. Hold down the VCR button on the remote and enter the two digit preset code that matches your VCR, as shown on page 32. The indicator light will flash 3 times if the code was accepted.
5. Aim the remote at the VCR and press the POWER button. The remote will turn off your VCR when the correct two digit preset code is entered. When this occurs, the remote control is programmed for your VCR. If the VCR does not turn off, try a different two digit preset code.
6. The remote will now control your VCR.

### NOTES:

1. If your VCR cannot be operated after performing the above procedures, your VCR's code has not been pre-coded into the remote.
2. In the unlikely event that your VCR cannot be operated after performing the above procedures, please consult your VCR operating guide.
3. The remote control will remember the codes you have programmed until the batteries are removed from the remote control. After replacing the batteries repeat the entire programming procedure as stated above.
4. The MENU button will act as the VCR MENU button for HITACHI VCRs.
5. The LAST CH button will act as your VCR ENTER button if required.
6. The SLEEP button will act as your VCR 100 button if required.

- ① **VCR Button**  
This button allows the remote to control your VCR by setting it to VCR mode.
- ② **PRECODED VCR Buttons**  
These buttons transmit the chosen pre-coded VCR codes. For some VCRs, you must press the RECORD button twice to record a program.
- ③ **EXCLUSIVE TV Buttons**  
These buttons are for operating the TV.

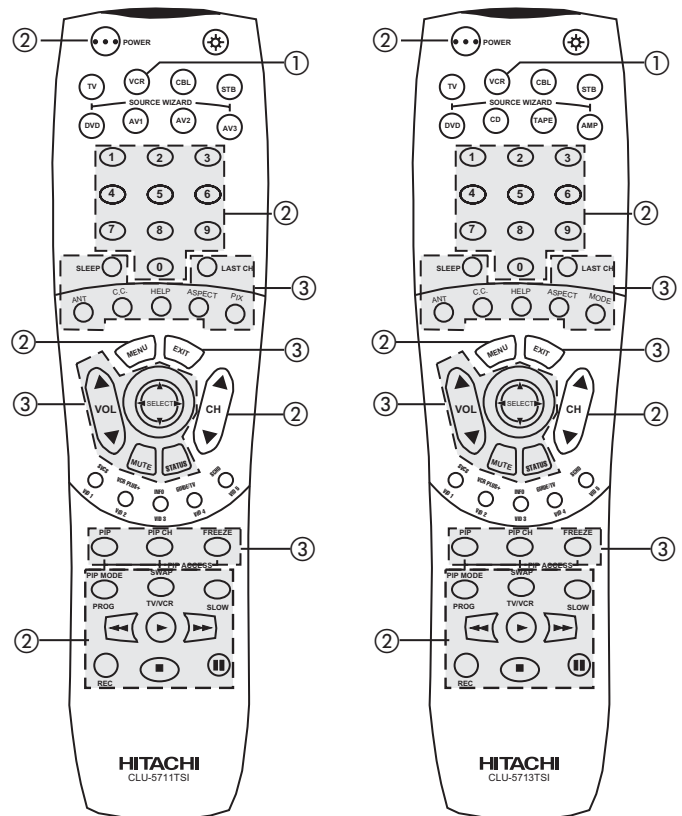

**MY VCR CODE IS: \_\_\_\_\_**

**NOTE:** Refer to instruction manual of the VCR for operation of the buttons exclusively for the VCR.



# USING THE REMOTE TO CONTROL CABLE BOX FUNCTIONS

## Operating the precoded function for your cable box.

This remote is designed to operate different types of cable boxes. You must first program the remote to match the remote system of your cable box. (refer to page 32)

1. Turn ON your cable box.
2. Aim the remote control at the front of your cable box.
3. Press and release the Cable (CBL) button to switch to Cable pre-coded mode.
4. Hold down the CBL button on the remote and enter the two digit preset code that matches your cable box as shown on page 32. The indicator light will flash 3 times if the code was accepted.
5. Aim the remote at the cable box and press the POWER button. The remote will turn off your cable box when the correct two digit preset code is entered. When this occurs, the remote control is programmed for your cable box. If the cable box does not turn off, try a different two digit preset code.
6. The remote will now control your Cable box.

**NOTES:**

1. If your cable box cannot be operated after performing the above procedures, your cable box code has not been precoded into the remote.
2. In the unlikely event that your cable box cannot be operated after performing the above procedures, please consult your cable box operating guide.
3. The remote control will remember the codes you have programmed until the batteries are removed from the remote control. After replacing the batteries repeat the entire programming procedure as stated above.
4. The LAST CH button will act as the cable box ENTER button if required.
5. The SLEEP button will act as your cable box 100 button if required.
6. The ANT button will act as the TV/STB button when in STB mode.

- ① **CABLE (CBL) button**  
This button allows the remote to control your cable box by setting it to CABLE mode.
- ② **PRECODED CABLE BOX buttons**  
These buttons transmit the chosen precoded cable codes.
- ③ **EXCLUSIVE TV buttons**  
These buttons are for operating the TV.

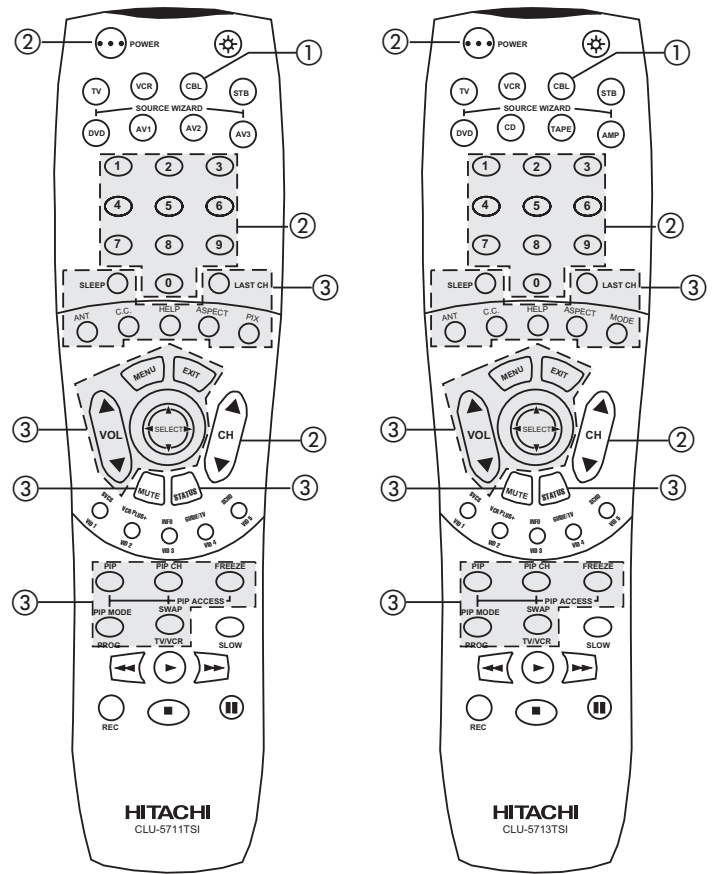

**MY CABLE BOX CODE IS: \_\_\_\_\_**

**NOTE:** Refer to instruction manual of the Cable Box for operation of the buttons exclusively for the Cable Box.

# USING THE REMOTE TO CONTROL SET-TOP-BOX/SATELLITE RECEIVER FUNCTIONS



## Operating the precoded function for your set-top-box/satellite receiver.

This remote is designed to operate different types of set-top-box/satellite systems. You must first program the remote to match the remote system of your set-top-box/satellite systems. (refer to page 32)

1. Turn ON your set-top-box/satellite systems.
2. Aim the remote control at the front of your set-top-box/satellite systems.
3. Press and release the SET-TOP-BOX (STB) button to switch to set-top-box/satellite pre-coded mode.
4. Hold down the STB button on the remote and enter the two digit preset code that matches your set-top-box/satellite receiver as shown on page 32. The indicator light will flash 3 times if the code was accepted.
5. Aim the remote at the set-top-box/satellite receiver and press the POWER button. The remote will turn off your set-top-box/satellite receiver when the correct two digit preset code is entered. When this occurs, the remote control is programmed for your set-top-box/satellite receiver. If the set-top-box/satellite receiver does not turn off, try a different two digit preset code.
6. The remote will now control your set-top-box/satellite receiver.

### NOTES:

1. If your set-top-box/satellite receiver cannot be operated after performing the above procedures, your set-top-box/satellite receiver code has not been precoded into the remote.
2. In the unlikely event that your set-top-box/satellite receiver cannot be operated after performing the above procedures, please consult your set-top-box/satellite receiver operating guide.
3. The remote control will remember the codes you have programmed until the batteries are removed from the remote control. After replacing the batteries repeat the entire programming procedure as stated above.
4. The ANT button will act as the TV/STB button when in STB mode.

#### ① SET-TOP-BOX (STB) button

This button allows the remote to control your satellite receiver by setting it to SET-TOP-BOX/SATELLITE mode.

#### ② PRECODED SET-TOP-BOX/SATELLITE RECEIVER buttons

These buttons transmit the chosen precoded set-top-box/satellite codes.

#### ③ EXCLUSIVE TV buttons

These buttons are for operating the TV.

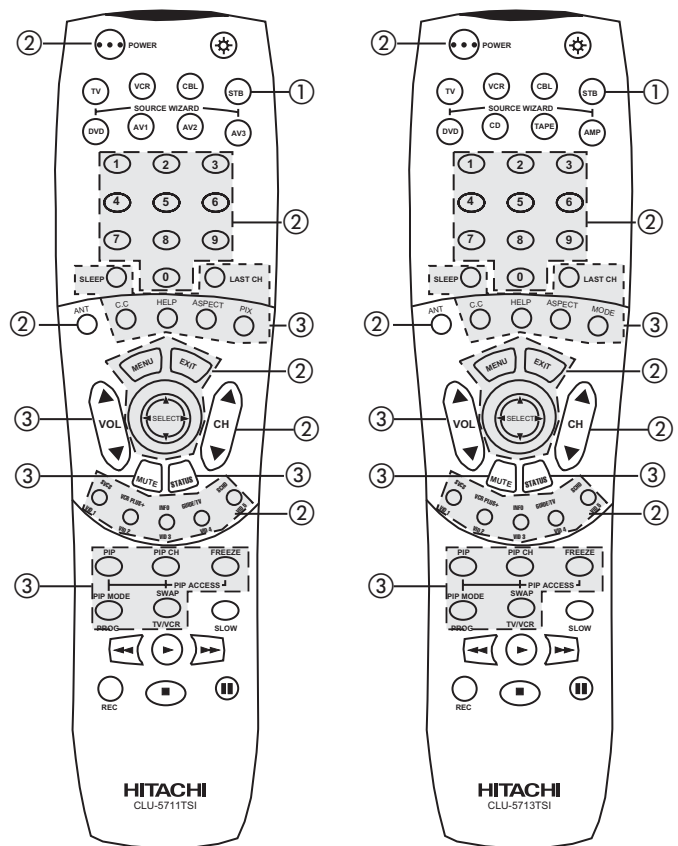

MY SATELLITE RECEIVER/STB CODE IS: \_\_\_\_\_

**NOTE:** Refer to instruction manual of the set-top-box/satellite receiver for operation of the buttons exclusively for the set-top-box/satellite receiver.



# USING THE REMOTE TO CONTROL DVD FUNCTIONS

## Operating the precoded function for your DVD player.

This remote is designed to operate different types of DVD players. You must first program the remote to match the remote system of your DVD player. (refer to page 32 for pre-codes)

1. Turn ON your DVD player.
2. Aim the remote control at the front of your DVD player.
3. Press and release the DVD button to switch to DVD pre-coded mode.
4. Hold down the DVD button on the remote and enter the two digit preset code that matches your DVD player, as shown on page 32. The indicator light will flash 3 times if the code was accepted.
5. Aim the remote at the DVD player and press the POWER button. The remote will turn off your DVD player when the correct two digit preset code is entered. When this occurs, the remote control is programmed for your DVD player. If the DVD player does not turn off, try a different two digit preset code.
6. The remote will now control your DVD player.

### NOTES:

1. If your DVD player cannot be operated after performing the above procedures, your DVD player's code has not been precoded into the remote.
2. In the unlikely event that your DVD player cannot be operated after performing the above procedures, please consult your DVD player operating guide.
3. The remote control will remember the codes you have programmed until the batteries are removed from the remote control. After replacing the batteries repeat the entire programming procedure as stated above.

- ① **DVD Button**  
This button allows the remote to control your DVD player by setting it to DVD mode.
- ② **PRECODED DVD Buttons**  
These buttons transmit the chosen precoded DVD codes.
- ③ **EXCLUSIVE TV Buttons**  
These buttons are for operating the TV.

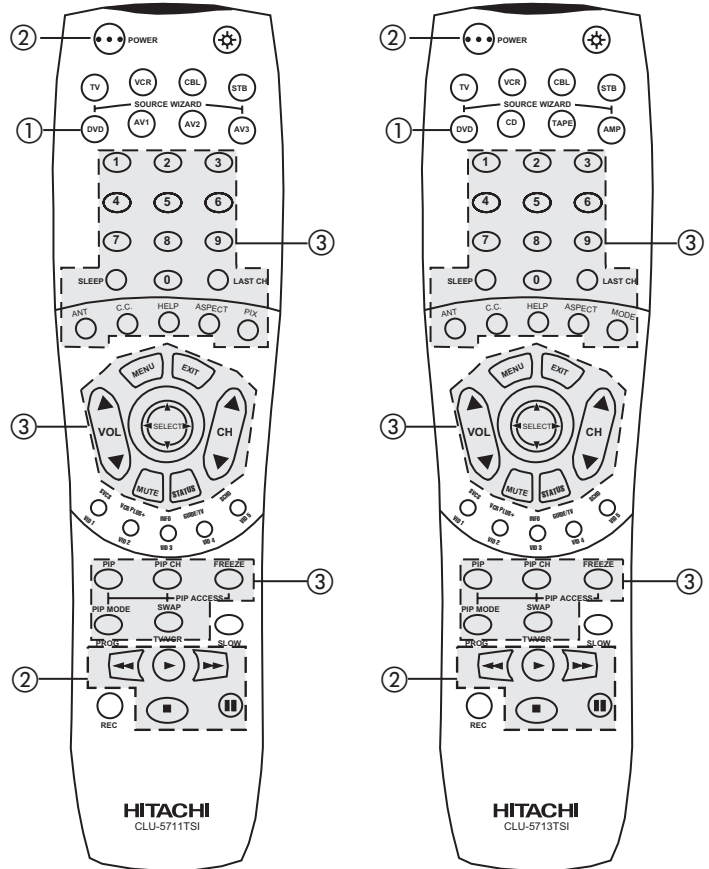

**MY DVD PLAYER CODE IS: \_\_\_\_\_**

**NOTE:** Refer to instruction manual of the DVD player for operation of the buttons exclusively for the DVD player.

# USING THE REMOTE TO CONTROL ADDITIONAL AUDIO/VIDEO EQUIPMENT



## Operating the precoded function for your Audio/Video component.

This remote is designed to operate different types of Audio/Video component. You must first program the remote to match the remote system of your Audio/Video component. (refer to page 32 for pre-codes)

1. Turn ON your Audio/Video component you wish to control with the Remote.
2. Aim the remote control at the front of your Audio/Video component.
3. Press and release the AV1, AV2 or AV3 button to switch to Audio/Video component pre-coded mode.
4. Hold down the AV1, AV2 or AV3 button on the remote and enter the two digit preset code that matches your Audio/Video component, as shown on page 32. The indicator light will flash 3 times if the code was accepted.
5. Aim the remote at the Audio/Video component and press the POWER button. The remote will turn off your Audio/Video component when the correct two digit preset code is entered. When this occurs, the remote control is programmed for your Audio/Video component. If the Audio/Video component does not turn off, try a different two digit preset code.
6. The remote will now control your Audio/Video component.
7. Repeat steps 1 - 6 if you wish to program the remote to control another Audio/Video component. Be sure to use a different AV/ button on the remote, since only one component can be programmed per button.

### NOTES:

1. Your remote control SOURCE WIZARD buttons are either labeled as AV1, AV2 and AV3, or CD, TAPE, and AMP. If your remote control SOURCE WIZARD buttons are labeled as AV1, AV2, and AV3, please program your Audio/Video components as follow for best performance. Use AV1 to program your CD brand. Use AV2 to program your TAPE brand, and use AV3 to program your AMPLIFIER/RECEIVER brand.
2. If your Audio/Video component cannot be operated after performing the above procedures, your Audio/Video component's code has not been precoded into the remote.
3. In the unlikely event that your Audio/Video component cannot be operated after performing the above procedures, please consult your Audio/Video equipment operating guide.
4. The remote control will remember the codes you have programmed until the batteries are removed from the remote control. After replacing the batteries repeat the entire programming procedure as stated above.

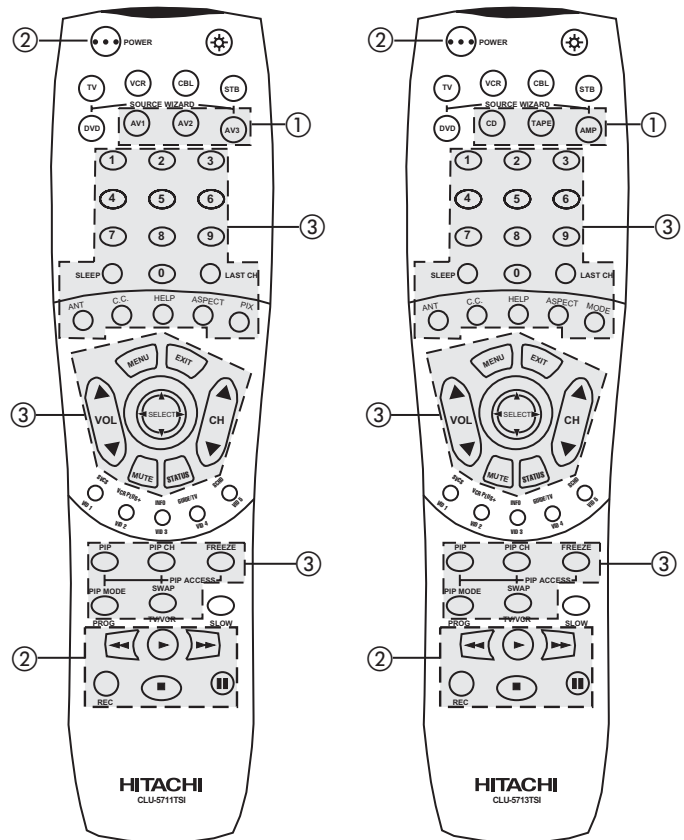

- ① **AV1, AV2, AV3 Buttons**  
These buttons allow the remote to control your Audio/Video equipment by setting it to Audio/Video mode.
- ② **PRECODED AUDIO/VIDEO Buttons**  
These buttons transmit the chosen precoded Audio/Video component codes.
- ③ **EXCLUSIVE TV Buttons**  
These buttons are for operating the TV.

### MY AUDIO/VIDEO EQUIPMENT CODE IS:

AV1 (CD) \_\_\_\_\_  
 AV2 (TAPE) \_\_\_\_\_  
 AV3 (AMP/RCVR) \_\_\_\_\_

**NOTE:** Refer to instruction manual of the Audio/Video equipment for operation of the buttons exclusively for the Audio/Video equipment.



# VCR, CABLE, SATELLITE, DVD and AUDIO/VIDEO CODES

VCR BRAND	CODE
Adventura	01
Aiko	09
Aiwa	01
Akai	02, 47, 48
American High	23
Asha	44
Audiovox	24
Beaumarck	44
Bell & Howell	32
Broksonic	33, 34, 41
Calix	24
Canon	23
Carver	31
CCE	09, 30
Citizen	09, 24
Colt	30
Craig	19, 24, 30, 44
Curtis Mathes	02, 23, 46
Cybernex	44
Daewoo	09, 17
Dynatech	01
Electroponic	24
Emerex	08
Emerson	01, 09, 13, 16, 24, 27, 28, 33, 34, 36, 41, 47
Fisher	19, 21, 32
Fuji	10, 23
Funai	01
Garrard	01
GE	04, 23, 40, 46
Goldstar	24, 25, 43
Gradiente	01
Harley Davidson	01
Harmon/Kardon	25
Harwood	30
Headquarter	18
Hi-Q	19
Hitachi	01, 02, 03, 04, 05
Jensen	02
JVC	02, 14, 26
KEC	09, 24
Kenwood	02, 25, 26
KLH	30
Kodak	23, 24
Lloyd	01
Lloyd s.	27
Logik	30
LXI	24
Magnavox	15, 23, 31, 35
Magnin	44
Marantz	23, 31
Marta	24
Matsushita	23
MEI	23
Memorex	01, 15, 18, 19, 20, 23, 24, 32, 44
MGA	16, 47
MGN Technology	44
Minolta	03, 05
Mitsubishi	16, 26, 39, 47, 48
Motorola	20, 23
MTC	01, 44
Multitech	01, 30
NEC	02, 25, 26, 32
Nikko	24
Noblex	44
Olympus	12, 23
Optimus	20, 24, 32
Panasonic	11, 12, 23, 38
Penney	03, 23, 24, 25, 44
Pentax	03, 04, 05
Philco	23
Phillips	23, 31
Pilot	24

Pioneer	26
Protec	30
Pulsar	15
Quarter	18
Quartz	18
Quasar	23
Radio Shack	01, 24
Radix	24
Randex	24
RCA	03, 04, 05, 35, 40, 46
Realistic	01, 18, 19, 20, 21, 23, 24, 32, 44
Ricoh	22
Runco	15
Samsung	17, 44
Sanky	15, 20
Sansui	02, 26
Sanyo	18, 19, 32, 44
Scott	16, 17, 33, 34, 36, 41
Sears	03, 05, 18, 19, 21, 23, 24, 32
Sharp	20
Shintom	30
Shogun	44
Singer	30
Sony	08, 10, 22, 23
STS	03
Sylvania	01, 16, 23, 31
Symphonic	01
Tatung	02
Teac	01, 02
Technics	23, 38
Teknika	01, 23, 24
TMK	27, 44
Toshiba	16, 17, 21, 36
Totvision	24, 44
Unitech	44
Vector	17
Vector Research	25
Video Concepts	17, 47
Videosonic	44
Wards	01, 03, 19, 20, 23, 30, 35, 36, 44, 46
XR-1000	01, 23, 30
Yamaha	25
Zenith	10, 15, 22

DVD BRAND	CODE
Denon	04
Hitachi	07, 12
JVC	01
Kenwood	04
Magnavox	05
Mitsubishi	10
Panasonic	04
Phillips	06
Pioneer	03
RCA (Proscan)	09
Samsung	12
Sony	02
Toshiba	05
Yamaha	08
Zenith	05, 11

CABLE BRAND	CODE
ABC	01, 07, 08, 17, 18, 20, 36, 37, 49
Antronix	39
Archer	11, 24, 39
Belcor	32
Cable Star	32
Century	11
Citizen	11
Colour Voice	30, 42
Comtronics	25, 28

Contec	21
Dae Ryung	20
Eastern	14
Electricord	31
Everquest	51
Focus	52
Garrard	11
GC Electronics	32, 39
Gemini	05, 38, 43, 51
General Instrument	01, 12
Goldstar	10, 25
Hamlin	04, 13, 22, 23
Hitachi	01
Hytex	36
Jasco	11
Jerrold	01, 08, 12, 37, 49, 50, 51
Macom	35
Magnavox	15
Memorex	03
Movie Time	29, 31, 33
NSC	29, 33, 38
Oak	21, 36, 46
Panasonic	02, 03, 09
Paragon	03
Phillips	11, 15, 16, 26, 30, 42, 43, 44
Pioneer	06, 10, 19
Popular Mechanics	52
Pulsar	03
RCA	02
Realistic	39
Recoton	52
Regal	04, 22, 34
Regency	14
Rembrandt	01, 38
Runco	03
Samsung	10, 25
Scientific Atlanta	17, 20, 41, 45
Signal	25, 51
Signature	01
SL Marx	25
Sprucer	02
Starcom	37, 49, 51
Stargate	25, 51
Starquest	51
Starsight	53, 54
Sylvania	18
Televue	25
Texscan	18
Tocom	07, 27, 50
Toshiba	03
Tusa	51
TV 86	29
Unika	11, 39
United Artists	36
United Cable	49
Universal	11, 24, 31, 32, 34, 39
Videoway	47
Viewstar	15, 28, 29, 40
Zenith	03, 48
Zentek	52

SATELLITE BRAND	CODE
Echostar	04
Hitachi	01
Hughes	05
RCA	02
Sony	03

SET-TOP-BOX	CODE
Panasonic	06
RCA	07
Samsung	08

AMPLIFIER BRAND	CODE
Aiwa	05, 06
Carver	01, 06, 08
Denon	10
Fisher	08, 11
Hitachi	12
JVC	13
Kenwood	14, 15, 17, 18
Magnavox	01, 06
Marantz	01, 06, 16
MCS	16
Optimus	03, 04, 11, 15, 20
Panasonic	16
Philips	01, 06
Pioneer	03, 04, 20, 21, 22
Quasar	16
Sansui	06
Sanyo	11
Sharp	15
Sony	05
Technics	02, 16, 23, 24, 25
Victor	13
Wards	03, 05, 06, 08, 20, 21
Yamaha	15, 26

CD BRAND	CODE
Adcom	01
Aiwa	02
California Audio Lab	03
Carver	02
Denon	04
DKK	05
Emerson	01
Fisher	06
Genexxa	07
Hitachi	01, 07, 08, 09, 10, 11, 12
JVC	13
Kenwood	06, 14, 15
Krell	02
Magnavox	02
Marantz	02, 03
MCS	03
Mission	03
NSM	02
Onkyo	16
Optimus	05, 07, 17
Panasonic	03
Phillips	02
Pioneer	07, 17
Proton	02
QED	02
Quasar	03
RCA	01, 21
Realistic	01
Rotel	02
SAE	02
Sansui	02
Scott	01
Sony	05, 18
Technics	03, 19, 20
Victor	13

TAPE BRAND	CODE
Aiwa	11, 12
Hitachi	01, 02, 03, 04
Hughes	05
Kenwood	06
Optimus	07
Pioneer	07
Sony	09, 10, 11, 12
Wards	07





1. Press MENU on the remote control to display the different features on your HITACHI Projection TV.
2. Press the THUMB STICK to highlight a different feature.
3. Press EXIT on the remote control to quickly exit from a menu.
4. Press HELP on the remote control when a menu is displayed, and text will appear giving a description of that menu.

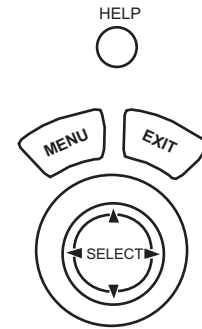

This part of the screen shows what selections are available.

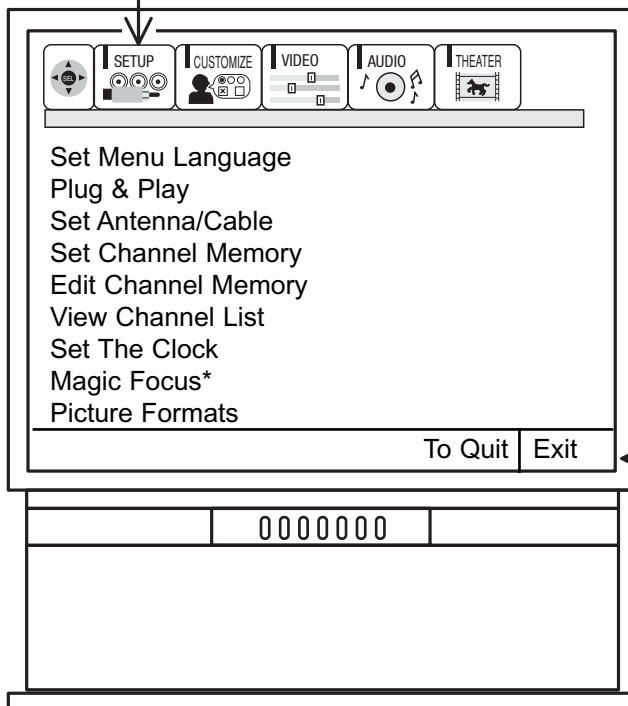

This part of the screen shows which remote control buttons to use.

\* 43FDX10B/43FDX11B Models use "Digital Array".

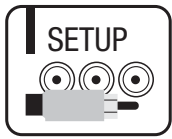

Set Menu Language
Plug & Play
Set Antenna/Cable
Set Channel Memory
Edit Channel Memory
View Channel List
Set The Clock
Magic Focus (53UDX10B/61UDX10B)
Digital Array (43FDX10B/43FDX11B)
Picture Formats

Choose English, French, or Spanish text.  
 Optimum hook up for your system.  
 Select Antenna or Cable TV.  
 First time set up for channel buttons.  
 Channel buttons, add or skip.  
 Check channel name, scan, and child lock.  
 Set before using timer features.  
 Automatically match red, green, and blue colors to make white.  
 Adjust red and blue to match green manually.  
 Select the Aspect Ratio.



Name The Channels
Name The Inputs
Set Favorite Ch.
Set Parental Locks
Set Program Timer
Video Input Sensor
Closed Caption
Menu Background

Label channels PAY1, ABC, etc.  
 Label video inputs VCR1, DVD1, etc.  
 Allows you to set and view favorite channels.  
 Block channel picture and sound.  
 Turn TV on and off once, daily, or weekly.  
 Automatically turn TV on to VIDEO:4 input.  
 Feature to display dialogue/text.  
 Select from two types of backgrounds.



Contrast
Brightness
Color
Tint
Sharpness
Reset
Advanced Settings

Adjust contrast.  
 Adjust brightness.  
 Adjust color.  
 Adjust tint.  
 Adjust sharpness.  
 Set VIDEO settings to factory preset.  
 Improve picture performance.



Bass
Treble
Balance
Reset
Advanced

Adjust Bass.  
 Adjust Treble.  
 Adjust Balance.  
 Set Audio Settings to Factory Preset.  
 Improve Sound Performance.



Theater Modes
Surround

Picture and sound are automatically set.  
 Special sound effects with **SRS** (●) and **BBE** technology.

# SET UP

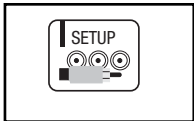

Select SETUP when setting your TV up for the first time. Use the THUMB STICK ▲ or ▼ on the remote to highlight the function desired.

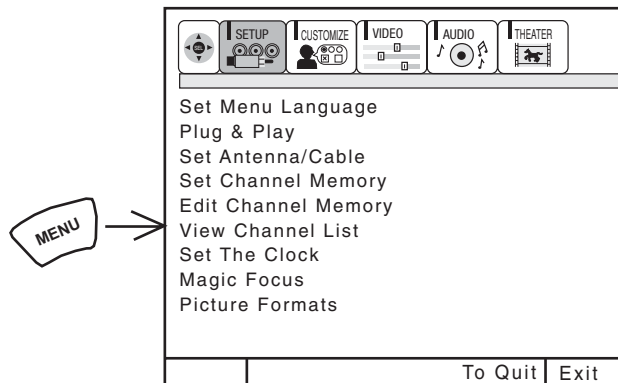

Use THUMB STICK ▲ or ▼ to select the sub-menu of your choice.

**NOTE:** To see an auto-demonstration of the on-screen displays with HELP text displayed, press and hold the POWER button on the TV set for approximately five seconds. Press the POWER button on the TV again to end the auto-demonstration.

## SET MENU LANGUAGE

This feature will allow you to select any one of three different languages for all on-screen displays.

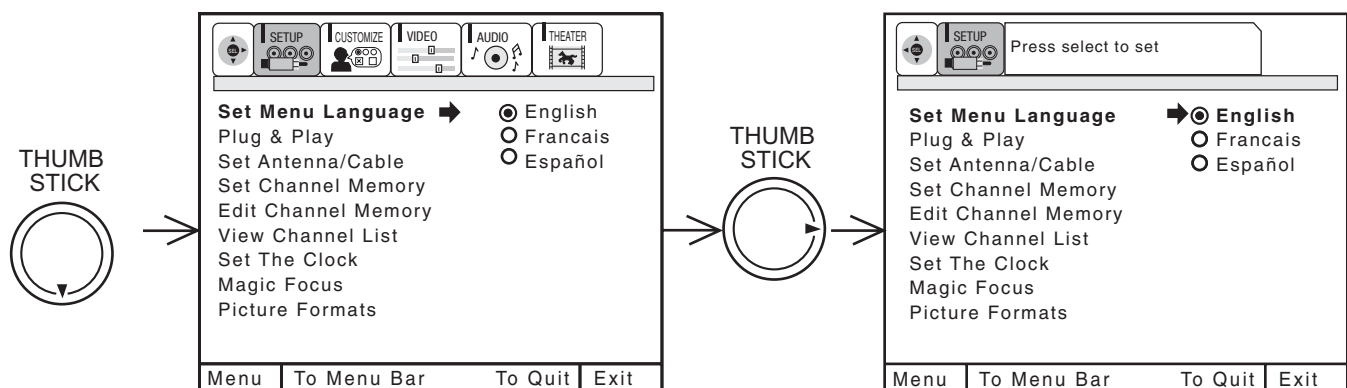

Use THUMB STICK ▲ or ▼ to highlight SET MENU LANGUAGE of your choice. Press down on THUMB STICK (SELECT) to select the highlighted language. Press EXIT to quit menu or THUMB STICK ◀ to return to previous menu.

## PLUG & PLAY

This graphic guide function will help you to properly set up your TV or Home Theater System. Simply answer three questions and a graphic will be displayed, showing you the optimum setup for your personalized system.

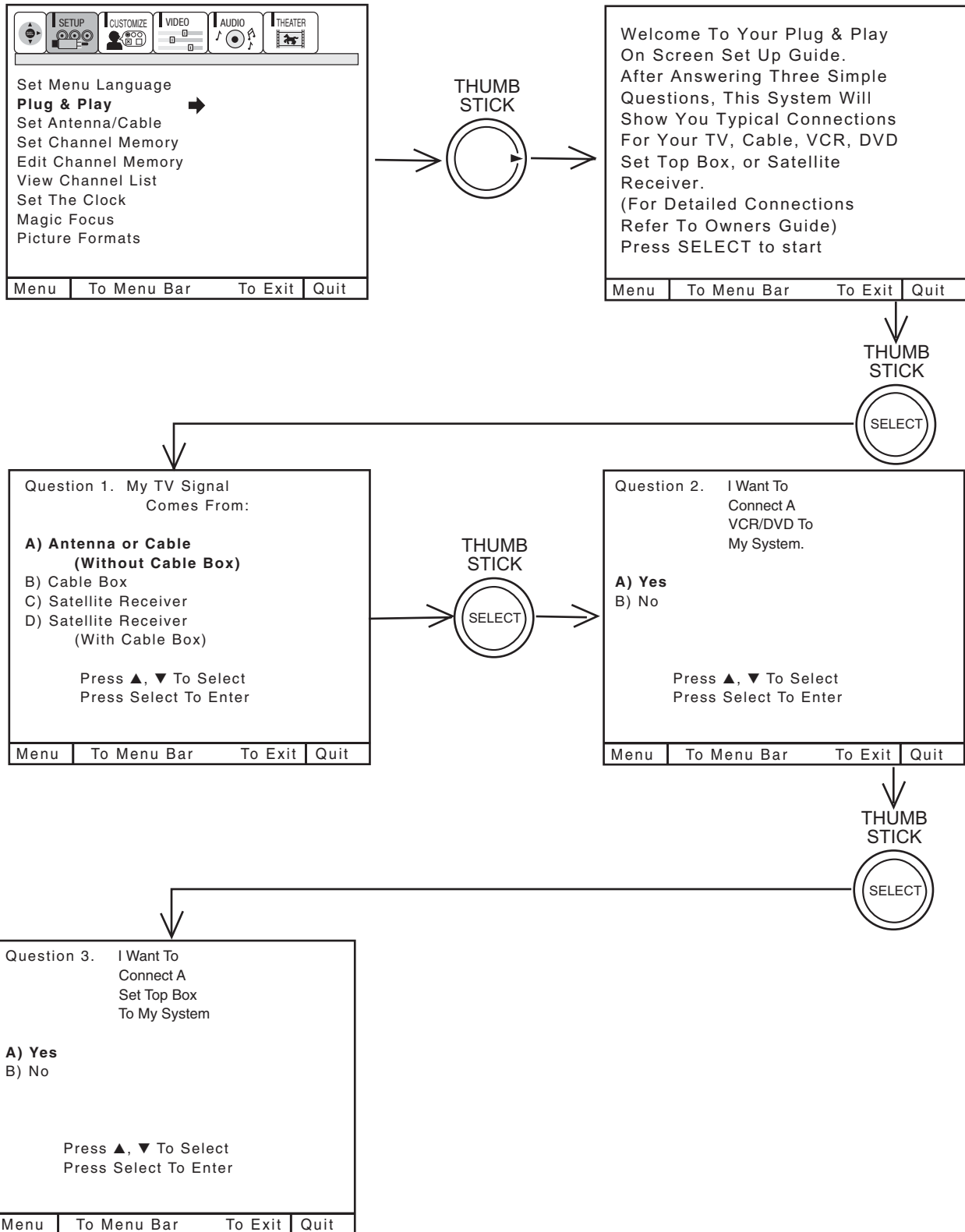

Press THUMB STICK ▲ or ▼ to highlight the correct answers to all three questions.  
 Press THUMB STICK ► to display the graphic guide.  
 Press EXIT to quit menu or THUMB STICK ► to begin SET CHANNEL MEMORY. (see page 38)



## SET ANTENNA/CABLE

Select ANTENNA if you are using an indoor or outdoor antenna. Select CATV if you have cable TV.

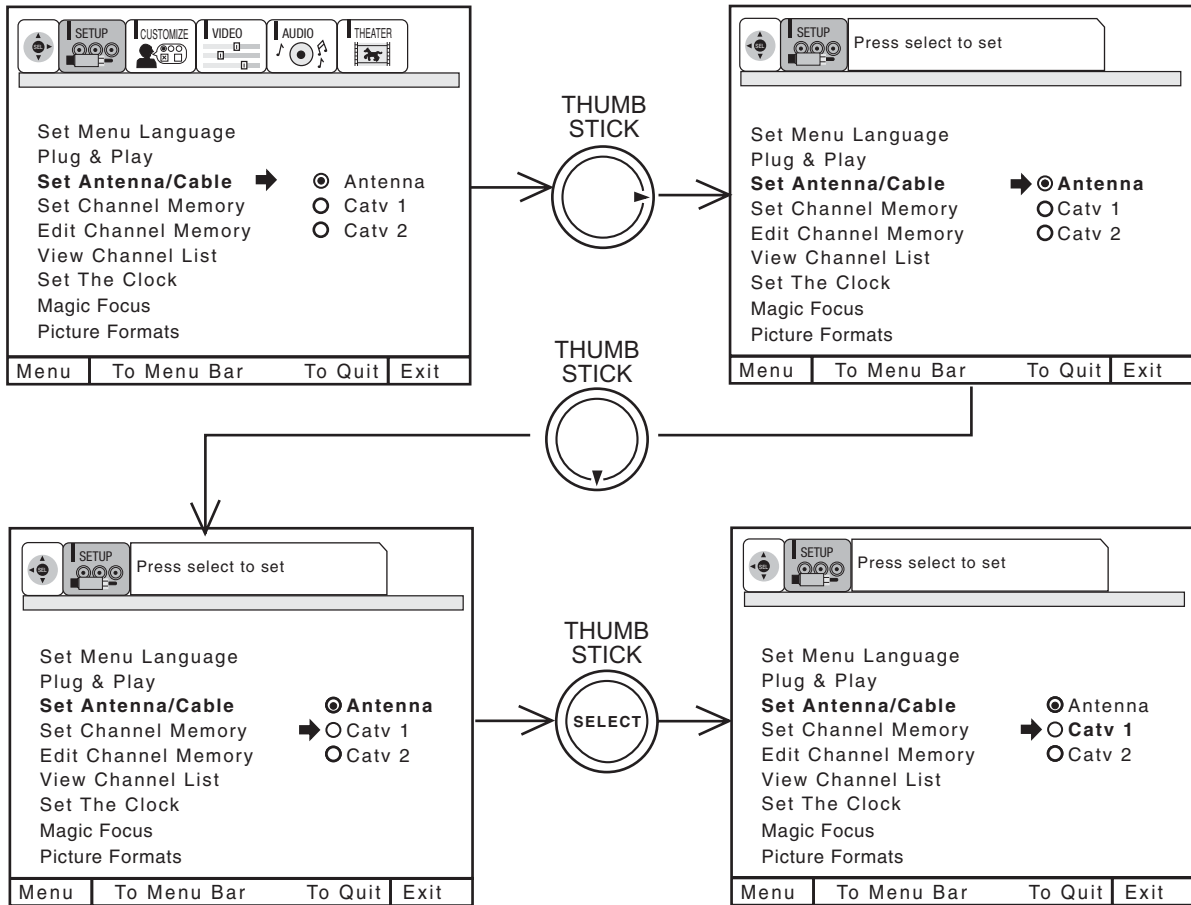

Use THUMB STICK ▲ or ▼ to highlight the correct signal mode.  
 Press down on THUMB STICK to select highlighted signal.  
 Press EXIT to quit MENU or THUMB STICK ◀ to return to previous menu.

RECEPTION BAND		
AIR	CATV 1 OR CATV 2	
	CATV CHANNEL	Indicated on the screen
VHF 2 ~ 13ch UHF 14 ~ 69ch	VHF 2~13	2 ~ 13
	Mid band A~1	14 ~ 22
	A-5 ~ A-1	95 ~ 99
	Super band J~W	23 ~ 36
	Hyper band W + 1 ~ W + 28	37 ~ 64
	Ultraband W + 29 ~ W + 84	65 ~ 125

Reception channels for each mode are shown at the left.

Refer to your cable or TV guide for channel identification standards.

If certain CATV channels are poor or not possible in CATV1 mode, select CATV2.

## SET CHANNEL MEMORY

This feature will automatically store active TV channels in SET CHANNEL MEMORY. This will allow you to skip unused channels when using CHANNEL UP (▲) or DOWN (▼).

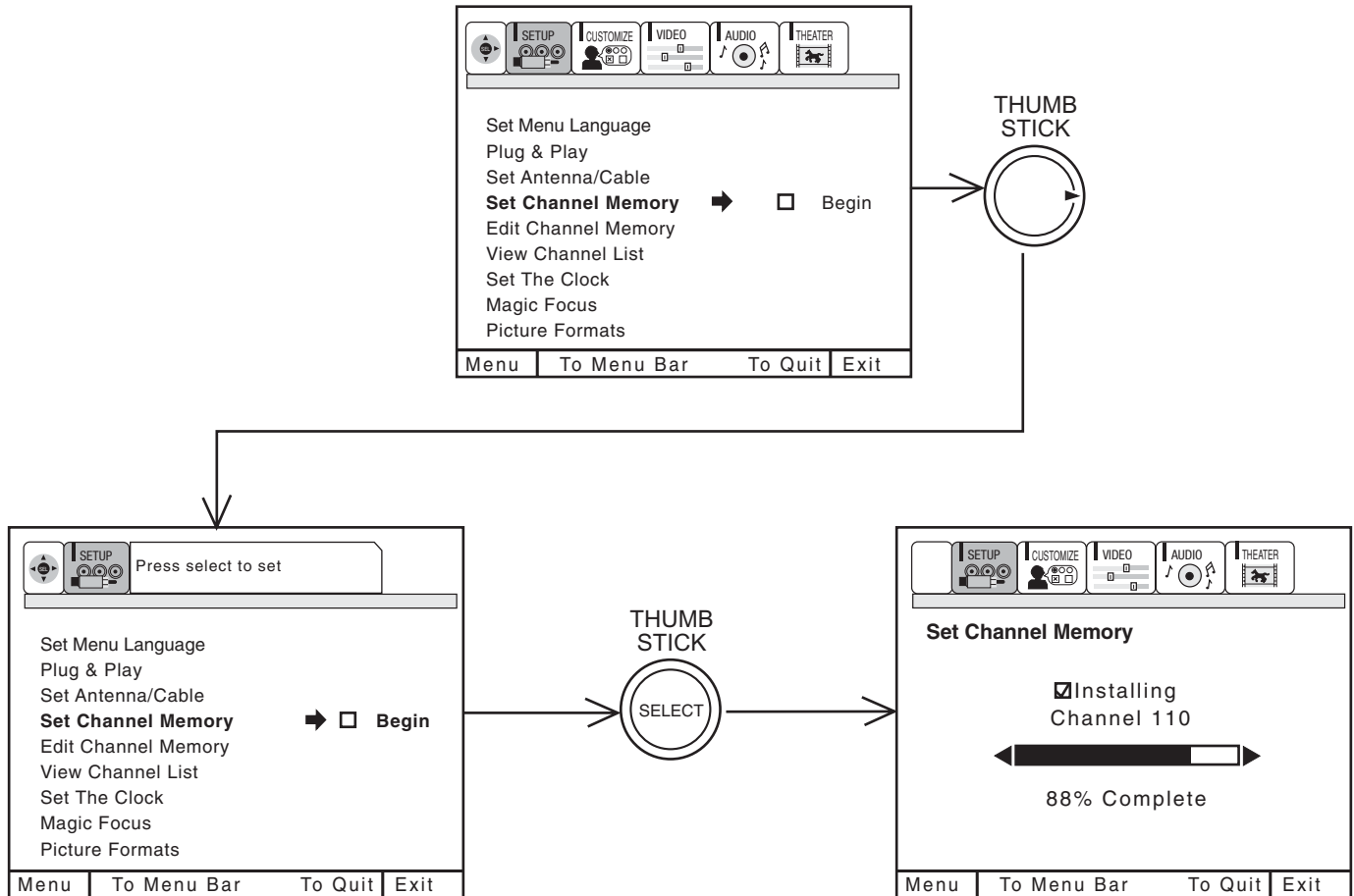

If the EXIT button is pressed while SET CHANNEL MEMORY function is engaged, programming will stop. If two antenna are connected, switch antenna inputs with the Ant button and repeat SET CHANNEL MEMORY for the second antenna input.

Remember to select the correct ANTENNA/CABLE mode before using SET CHANNEL MEMORY. See EDIT CHANNEL MEMORY to add or to erase additional channels.

## EDIT CHANNEL MEMORY

Use this function after SET CHANNEL MEMORY is completed to add or erase additional channels to the remote control CHANNEL ▲ or ▼ buttons.

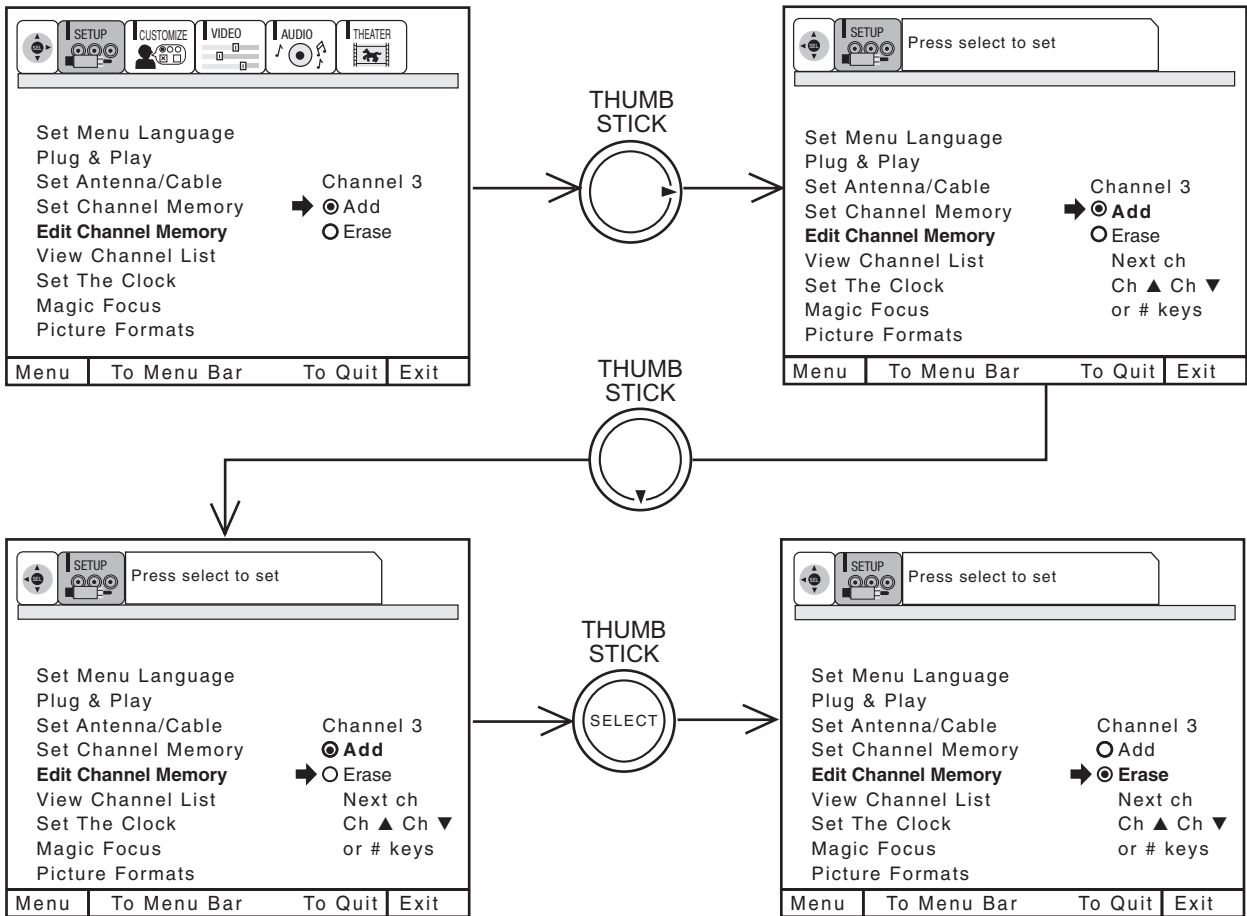

Add or erase additional channels while still in EDIT CHANNEL MEMORY using CHANNEL ▲ or ▼ or the number buttons to change the channel.

Press EXIT to quit menu or THUMB STICK ◀ to return to previous menu.

## VIEW CHANNEL LIST

This function allows you to review which channels are labeled in NAME THE CHANNEL, which have been added to EDIT CHANNEL MEMORY (SCAN), and which are protected by SET PARENTAL LOCKS.

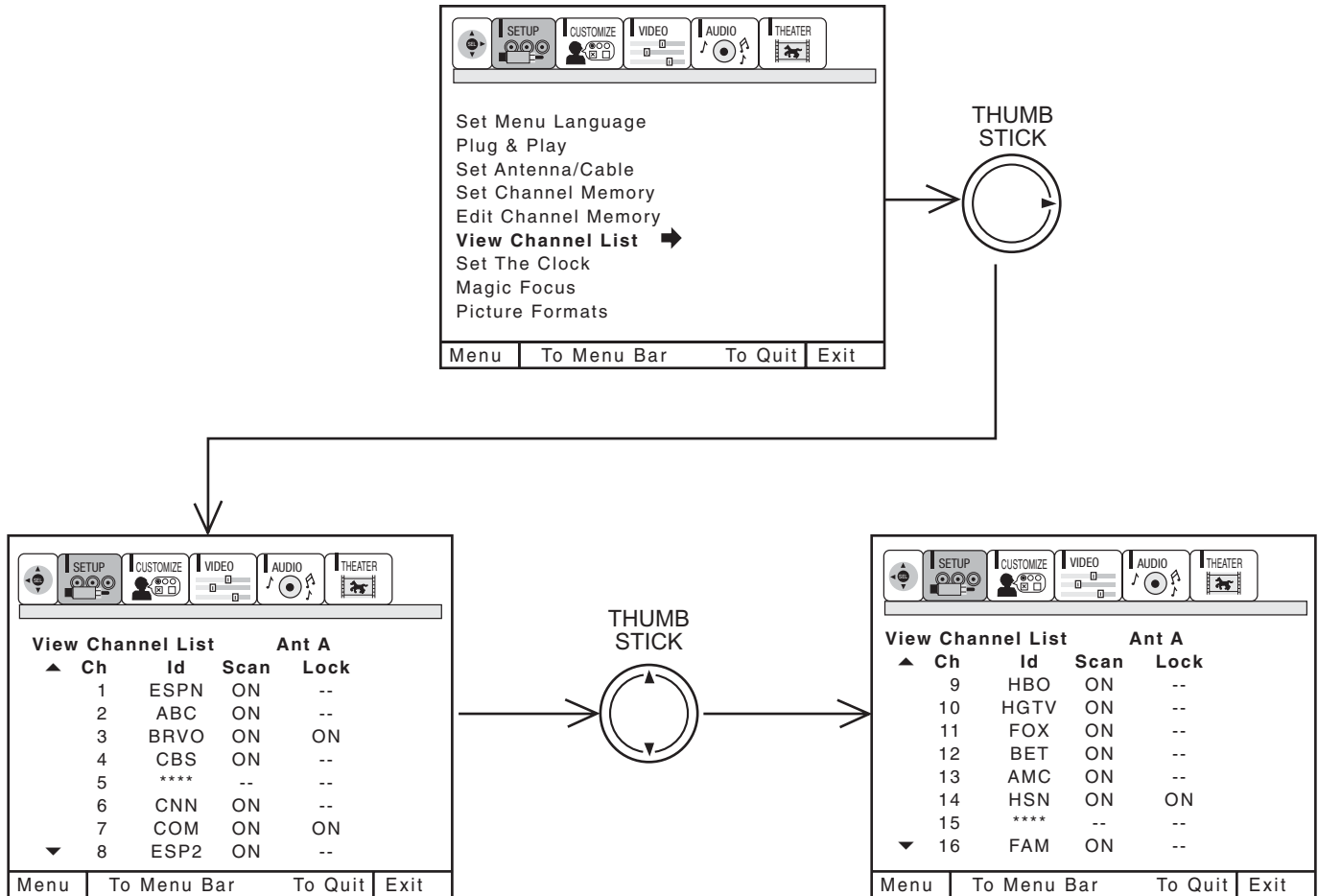

Press THUMB STICK ▲ or ▼ to review more channels.  
 Press EXIT to quit menu or THUMB STICK ◀ to return to previous menu.

**NOTE:** Each touch of THUMB STICK ▲ or ▼ will display the next eight channels.



# SET UP



## SET THE CLOCK

The time must be set before you can SET PROGRAM TIMER or TV TIME OUT.

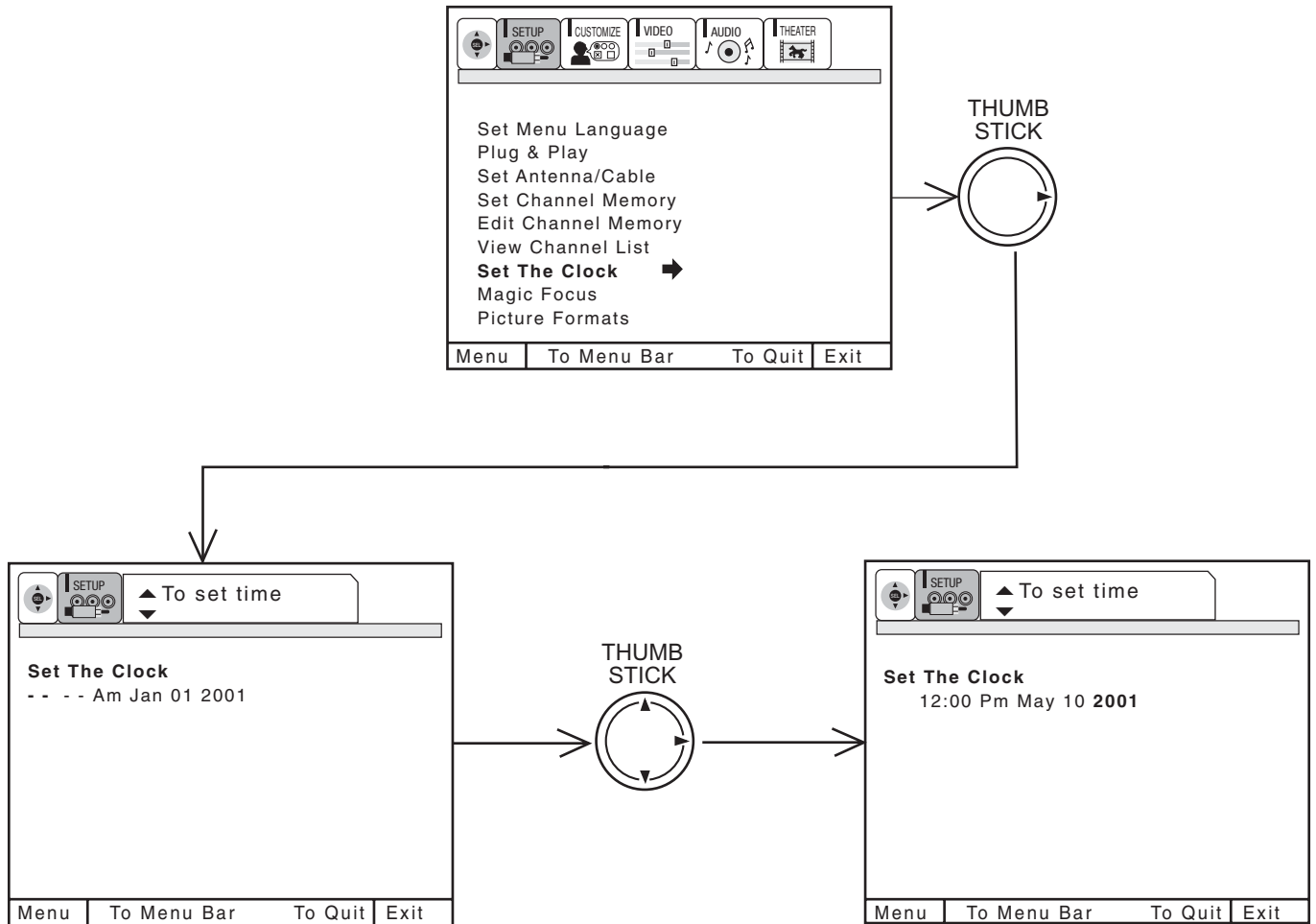

Use THUMB STICK ▲ or ▼ to set the time, date, and year.  
Press THUMB STICK ◀ or ▶ to change position.  
Press EXIT to quit menu or THUMB STICK ◀ to return to previous menu when the CURSOR is in the first position.

## MAGIC FOCUS

Model: 43FDX10B/43FDX11B - Please see Digital Array on page 43.

Your HITACHI Projection TV has three color projection tubes: one for red, one for green, one for blue. When mixed together in the proper proportion, the output of these three color tubes can produce any color. To produce these colors, however, the beams must be precisely aligned over each other so that the colors can be mixed. The process of aligning these picture beams is called convergence.

Over a period of time, the picture tubes can drift out of alignment due to normal bumps and vibrations or moving the TV. If you move your TV, or if, after a time, you notice color rings or halos around objects in the picture, you may want to converge (align) the colors.

Properly converged, the lines appear white, which is actually a combination of the outputs of the three color tubes. The output of the green tube is stationary. The outputs of the red and blue tubes can be adjusted. When properly aligned, the outputs of all three tubes should be directly over each other to produce the white lines.

To simplify convergence, HITACHI incorporates a function called MAGIC FOCUS located on the front control panel, which allows the TV to self-adjust. Press this MAGIC FOCUS button and the convergence self adjustment will start and this process will take approximately 15 seconds. If this button is pressed during this process, no change in picture quality will occur. After this 15 second self-adjust period, picture quality will be optimum. (Do not move the TV during self-adjust.)

You may also select MAGIC FOCUS from the SETUP Menu.

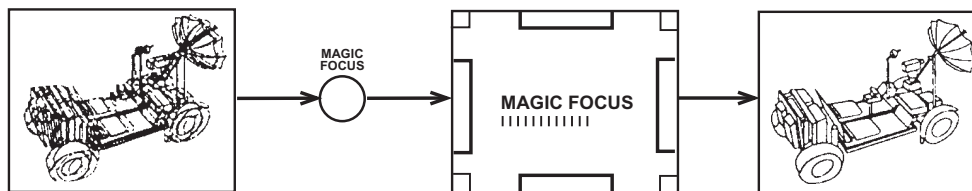

**NOTES:** Only a momentary press of the MAGIC FOCUS button is necessary to start AUTO DIGITAL CONVERGENCE. At anytime during this convergence correction process, you may press the MAGIC FOCUS button to exit the MAGIC FOCUS mode.

# SET UP

## DIGITAL ARRAY

### Model: 43FDX10B/43FDX11B

Your HITACHI Projection TV has three color projection tubes: one for red, one for green, one for blue. When mixed together in the proper proportion, the output of these three color tubes can produce any color. To produce these colors, however, the beams must be precisely aligned over each other so that the colors can be mixed. The process of aligning these picture beams is called convergence.

Over a period of time, the picture tubes can drift out of alignment due to normal bumps and vibrations or moving the TV. If you move your TV, or if, after a time, you notice color rings or halos around objects in the picture, you may want to converge (align) the colors.

Properly converged, the lines appear white, which is actually a combination of the outputs of the three color tubes. The output of the green tube is stationary. The outputs of the red and blue tubes can be adjusted. When properly aligned, the outputs of all three tubes should be directly over each other to produce the white lines.

To simplify convergence, HITACHI incorporates a feature to allow you to display a test pattern of horizontal and vertical lines at 9 different locations on the screen. Simply use the remote control to adjust the red and blue colors to match the green. When properly aligned, the outputs of all three tubes should be directly over each other to produce the white lines.

You may also select DIGITAL ARRAY from the Set Up menu.

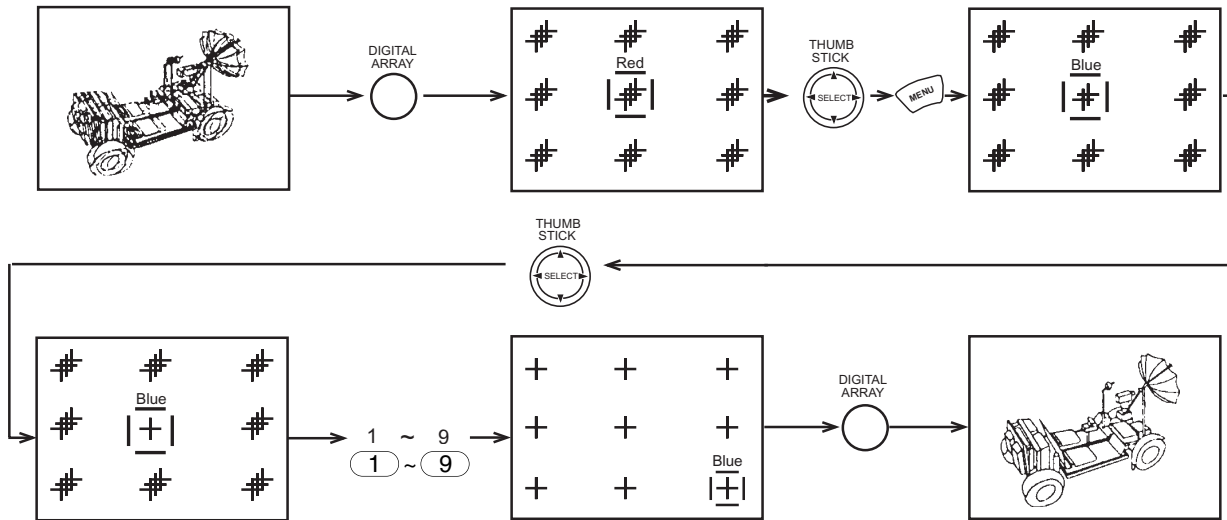

Use the number buttons to select which point to adjust: (1) - Upper Left, (2) - Upper Middle, (3) - Upper Right, 4 - Center Left, (5) - Center, (6) - Center Right, (7) - Bottom Left, (8) - Bottom Middle, (9) - Bottom Right.

Press the CURSOR buttons to move the displayed color up, down, left, or right.

Press MENU to change the color you want to adjust.

Press the front panel DIGITAL ARRAY button or the remote control PIP MODE button when adjustment is done. This will save your adjustment into memory.

**NOTE:** Only a momentary press of the DIGITAL ARRAY button is necessary to enter DIGITAL ARRAY convergence adjustment mode.

To save your adjustment data into memory, press the front panel DIGITAL ARRAY button or the remote control PIP MODE Button. If you do NOT wish to save your adjustment data into memory, turn the TV OFF or press the remote control PIP button. When the TV is turned ON again, your old convergence data will be restored.

When adjusting convergence, always start at the center of the screen.

## PICTURE FORMATS

The PICTURE FORMATS function is very useful when setting up reception High Definition, Standard Definition and NTSC signals.

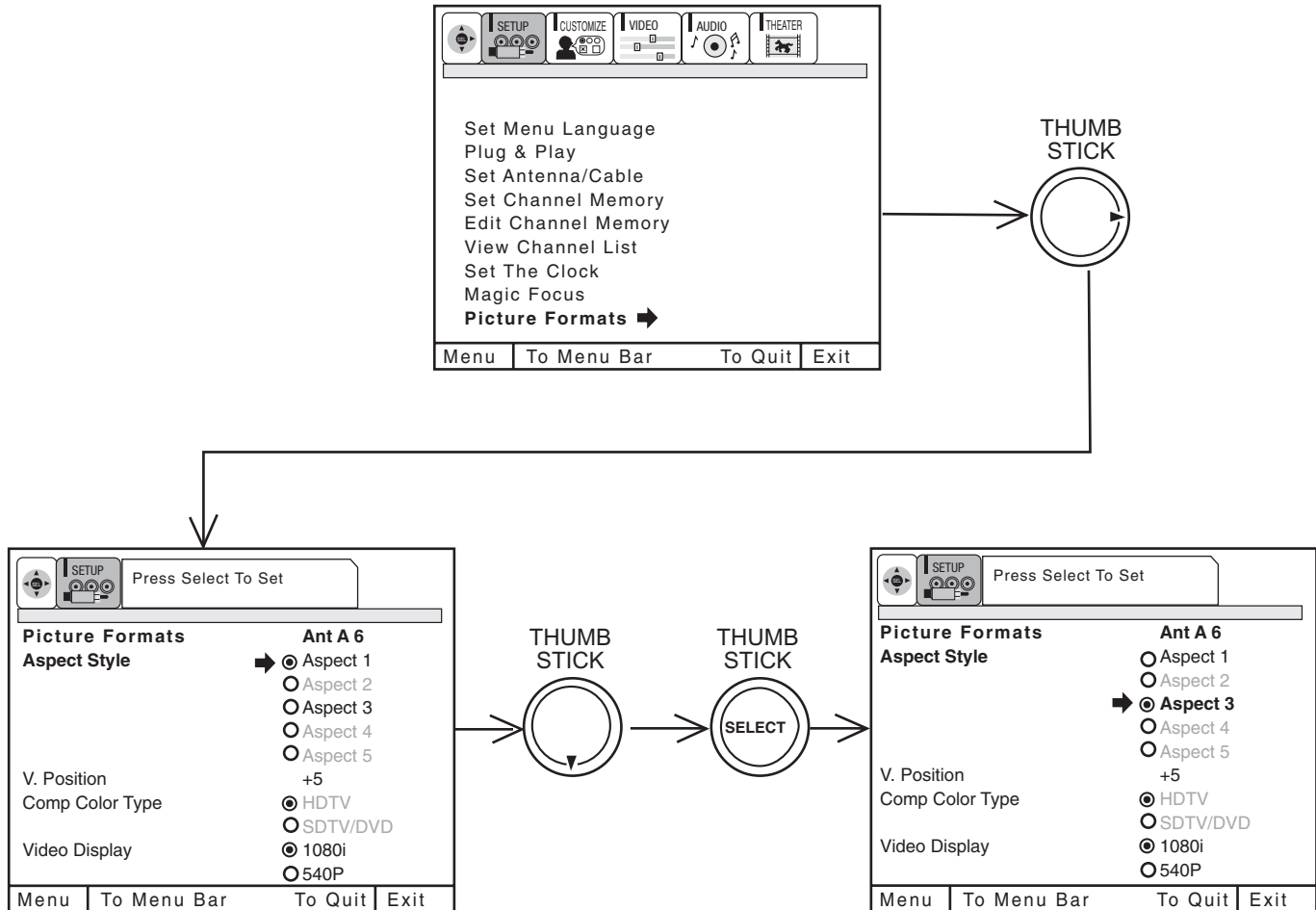

## V. Position

Adjust this when viewing a COMPONENT: Y-P<sub>B</sub>P<sub>R</sub> signal. This feature is used to center an HDTV video signal between the top and bottom gray bars. Adjustable range is -10 (video center is toward bottom of screen) to +10 (video center is toward top of screen).

Press THUMB STICK ▲ or ▼ to highlight then press down on THUMB STICK to select.  
Press EXIT to quit menu or THUMB STICK ◀ to return to previous menu.

### NOTE:

- Depending on the input signal, some of the Aspect features will be grayed out. This means that the feature is not available with the signal input.
- Set up a Component Signal (connect component to Y-P<sub>B</sub>P<sub>R</sub> inputs) and switch to VIDEO: 4 or 5 by pressing the Video:4 or 5 button on the Remote Control when planning to use all Picture Formats feature.

Aspect 1 - Display the actual (normal 4x3 or 16x9) inputted signal mode.

Aspect 2 - Stretch the signal to 16x9 format.

Aspect 3 - Zoom in on Aspect 1 mode.

Aspect 4 - Zoom in on Aspect 2 mode.

Aspect 5 - When 1080i signal is inputted, this is the true 1080i signal.

# SET UP

## Picture Formats

Depending on the input signal, the PICTURE FORMAT aspect ratio allows you to adjust the image through the following options.

(1) NTSC Input - ANT A/B, VID1 ~ VID5, - 4x3 Format

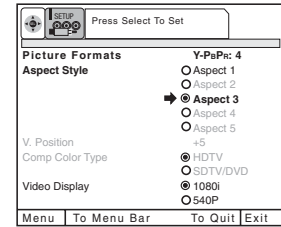
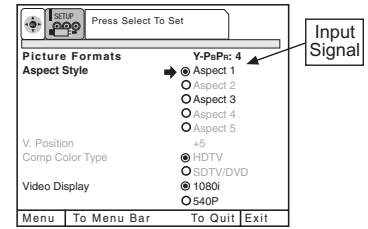
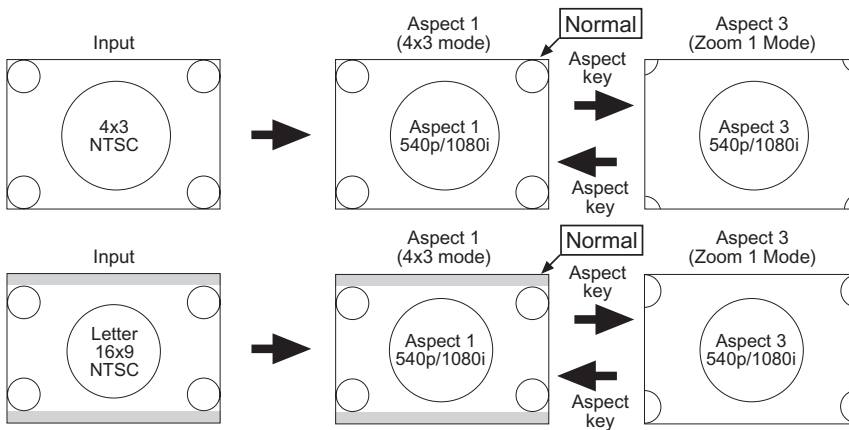

(2) 480i Input - ANT A/B, Input 4/5 (Component) - 4x3 Format

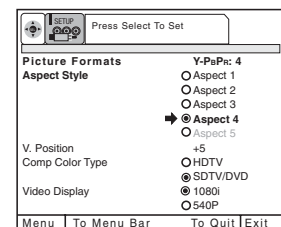
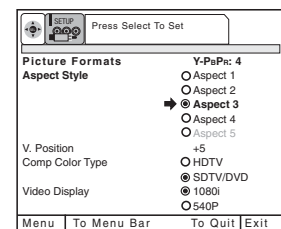
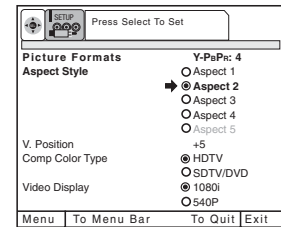
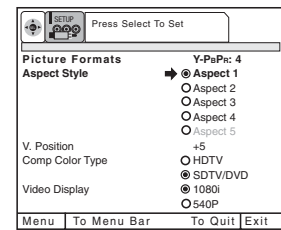
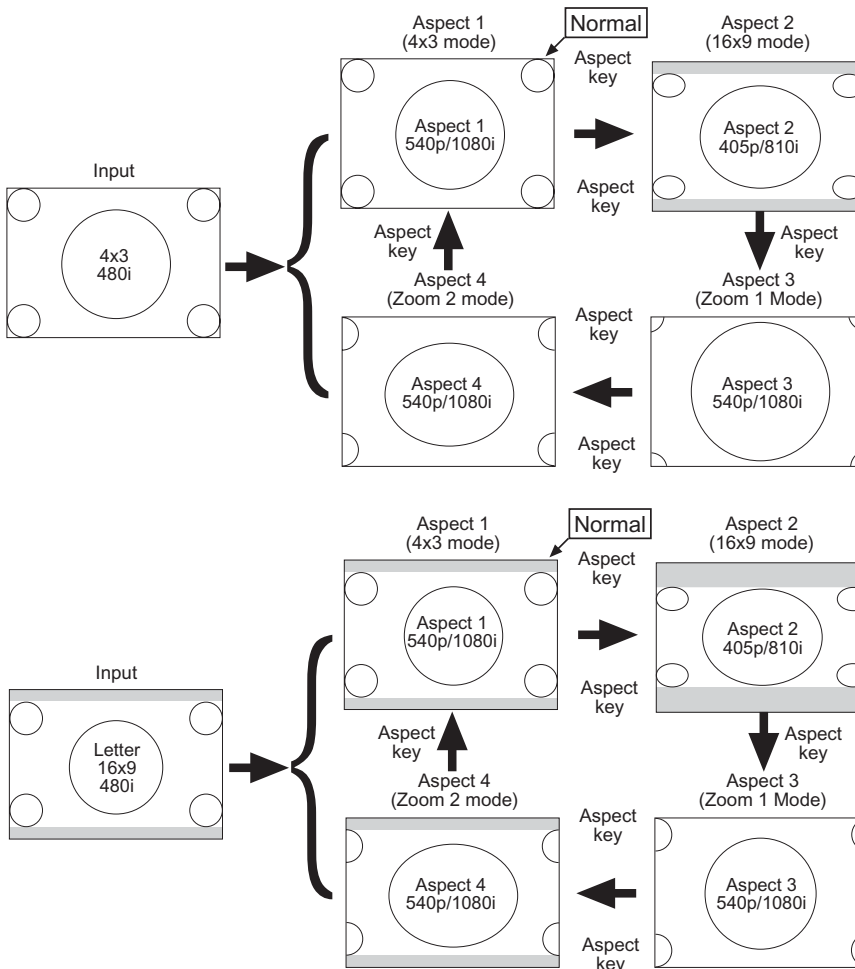

### (3) 480p Input - Input 4/5 (Component) - 4x3 Format

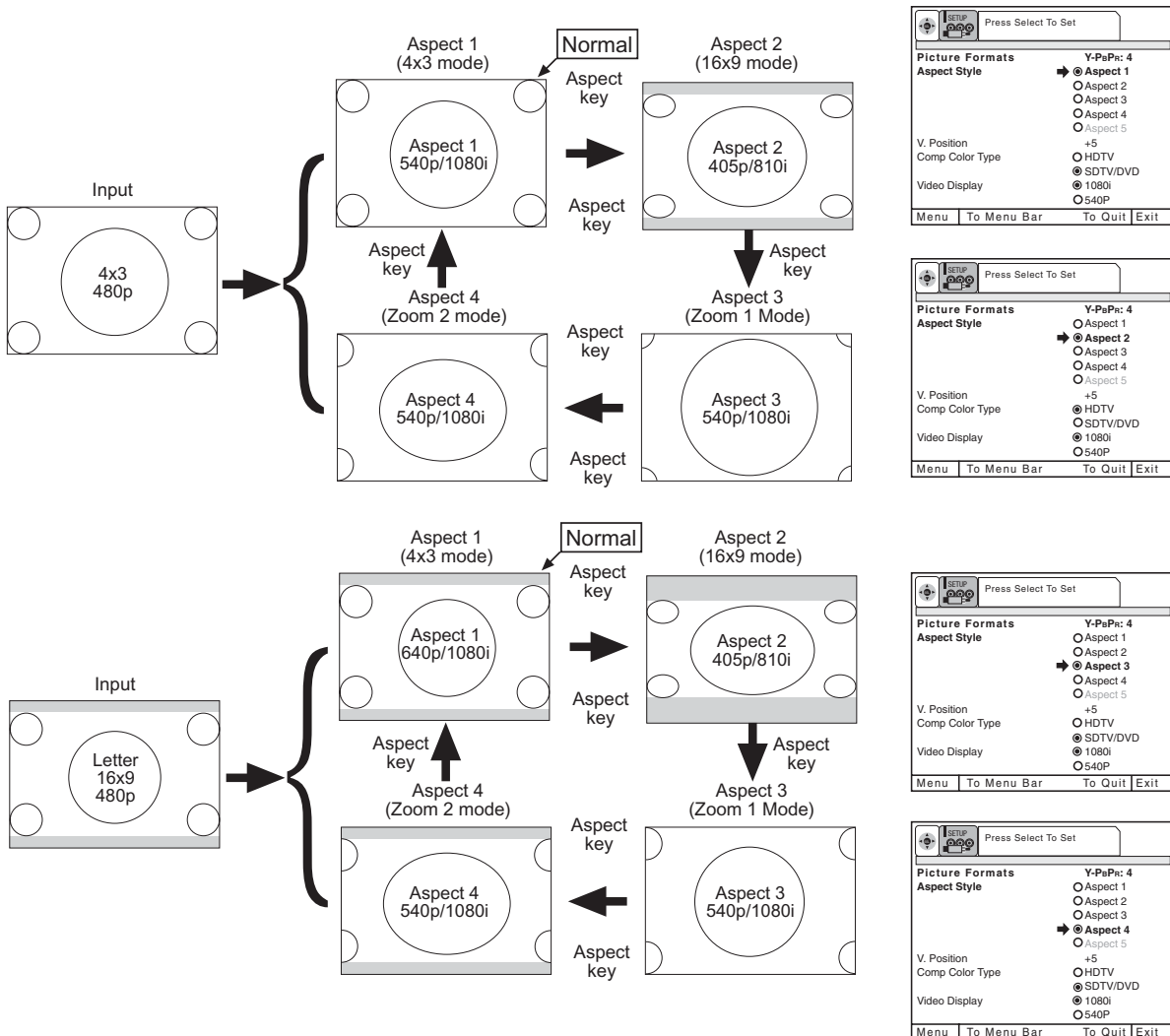

### Comp Color Type

The Comp Color Type function allows you to automatically change tint and color coordinate for DTV Programs.

HDTV - High Definition Television - Use for High Vision Signal Y-P<sub>B</sub>P<sub>R</sub> from HDTV Set-Top Box.

SDTV /DVD - Standard Definition Television or Digital Video Disc Y-C<sub>B</sub>C<sub>R</sub> such as DVD (Digital Video Disc Player).

### Video Display

The Video Display feature allows you to display 1080i or 540P signal mode. This feature is not available if Aspect 5 (1080i through mode) is selected.

- NOTE:**
1. If Comp Color Type is set improperly (does not match actual input signal), the color and tint of the main picture will be abnormal.
  2. You must be tuned to VIDEO: 4 or 5 input and have a component hooked up to the Y-P<sub>B</sub>P<sub>R</sub> input jacks to access all Picture Formats menu.
  3. All settings will affect only the component input you are currently viewing. If you are using both sets of component input jacks, be sure to set the Picture Formats feature for both inputs (set VIDEO:4 AND VIDEO:5).
  4. Aspect 5 is for 1080i signal format only. Selecting Aspect 5 allows the 1080i signals to appear on the TV screen as the broadcaster sends them. Aspect 5 does not allow the 1080i to go to the TV's internal flex converter.
  5. Aspect 5 must be selected from the OSD menu at all times. The aspect button on the remote control will skip the Aspect 5 feature.
  6. Using Aspect 5 will shorten the life of the PRT guns due to no gray panel at the top and bottom of the TV screen.

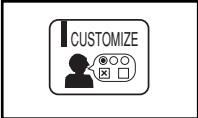

This selection contains advanced features which will make TV viewing easier and more enjoyable.

## NAME THE CHANNEL

Use this feature to give up to 20 channels a name when ANTENNA signal source is selected and up to 60 channels a name when CATV signal source is selected.

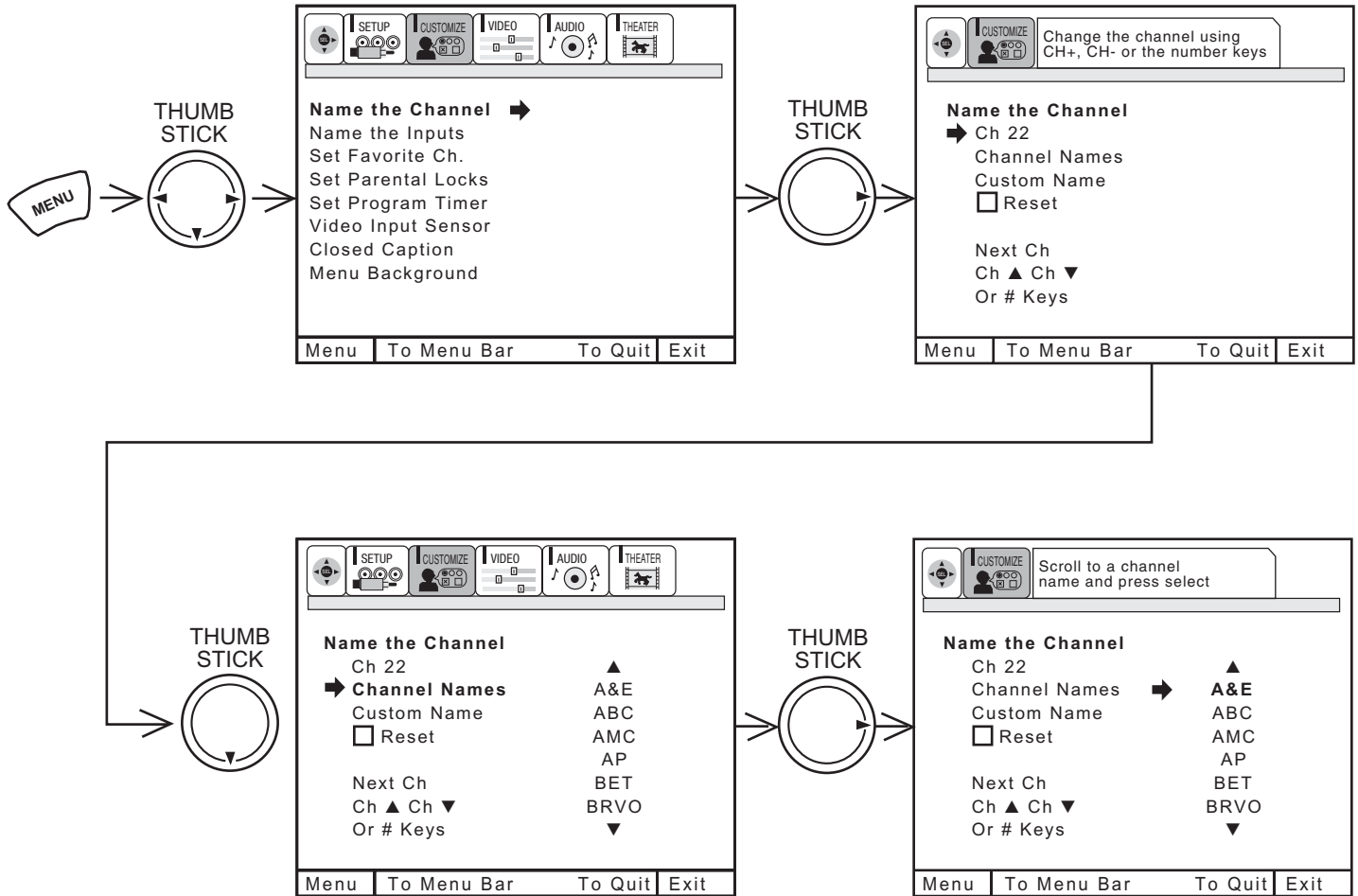

Press THUMB STICK ▼ to highlight CHANNEL NAMES.  
 Press THUMB STICK ► to select preset CHANNEL NAMES.  
 Press THUMB STICK ▼ to scroll through the preset CHANNEL NAMES.  
 Press down on THUMB STICK to select desired CHANNEL NAME.

To customize CHANNEL NAMES, select CUSTOM NAME.  
 Press THUMB STICK ▲ or ▼ to select letter.  
 Press THUMB STICK ◀ or ▶ to change character position.  
 (\*) represents a blank space.  
 Press CHANNEL ▲ or ▼ and the number buttons to label additional channels.  
 Press EXIT to quit menu or THUMB STICK ◀ to return to previous menu when the CURSOR is in the first position.

Select RESET to erase a CHANNEL NAMES.

- NOTES:**
1. If ANT A and ANT B are in the same ANTENNA/CABLE mode (see page 37), the CHANNEL NAMES for both antenna inputs will be the same.
  2. CHANNEL NAMES will be displayed only when channel is displayed as main picture.

**NAME THE INPUTS** Use this feature to give a name to any of the five video inputs.

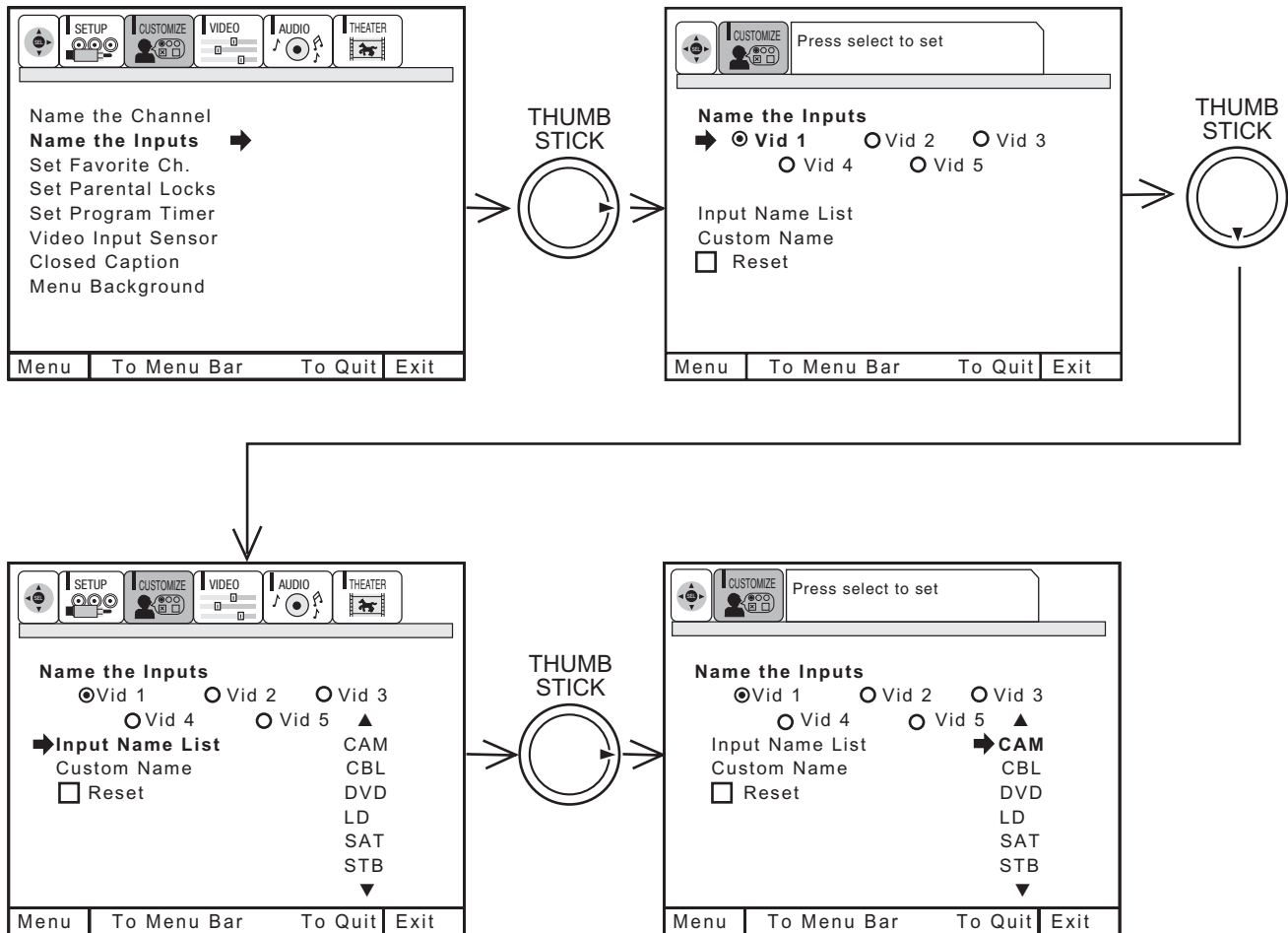

Press THUMB STICK ▼ to highlight NAME THE INPUTS.  
 Press THUMB STICK ► to select preset NAME THE INPUTS.  
 Press THUMB STICK ▲ or ▼ to scroll through the preset INPUT NAME LIST.  
 Press down on THUMB STICK to select desired INPUT NAME.

To customize INPUT NAME, select CUSTOM.  
 Press THUMB STICK ► to select the video input to be named.  
 Press THUMB STICK ▲ or ▼ to select letters.  
 Press THUMB STICK ► or ◀ to change position.  
 Press down on THUMB STICK to set.  
 Press EXIT to quit menu or THUMB STICK ◀ to return to previous menu when the CURSOR is in the first position.  
 (\*) represents a blank space.

Select RESET to set INPUT NAMES to original condition.

**NOTE:** INPUT NAME will be displayed only when video INPUT is displayed as main picture.



## SET FAVORITE CHANNELS

This function allows you to group your favorite channels into six personalized categories that you can rename. A total of 36 channels can be stored in the FAVORITE CHANNELS function.

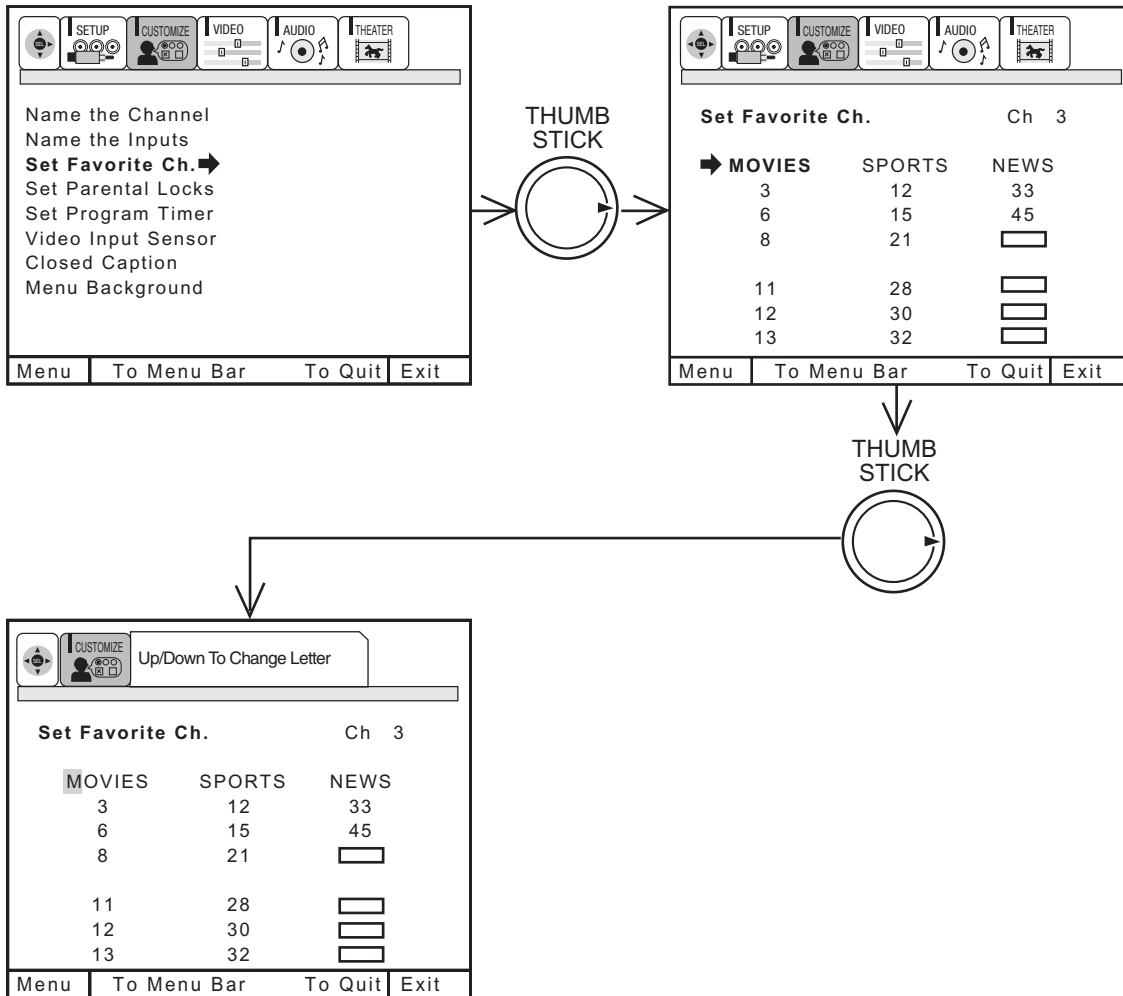

Channel stored with CHANNEL MEMORY will automatically be stored in FAVORITE CHANNELS.

To rename the categories, use the THUMB STICK to highlight the category you would like to rename. Use THUMB STICK ▲ or ▼ to change a letter and THUMB STICK ► to select the next character to change.

To enter a channel into a category, highlight the channel location to be stored. Press CHANNEL ▲ or ▼ or the number buttons to enter the desired channel. Repeat until category has been set with your favorite channels. The channel to be added is displayed in the top right corner of the screen. Enter channel 00 to erase a favorite channel.

To reset categories and channels back to original factory preset, press STATUS while you are renaming a category.

**NOTE:**

1. This function cannot be accessed when ANT B is the main channel.
2. When the input source is not ANT A, the message PLEASE SWITCH TO ANT A will appear.
3. Each category contains 2 groups of 3 channels, for a total of 6 channels per category.

## FAVORITE CHANNELS (OPERATION)

Use this function to display FAVORITE CHANNEL selections as sub-pictures or to tune the main picture to a desired favorite channel.

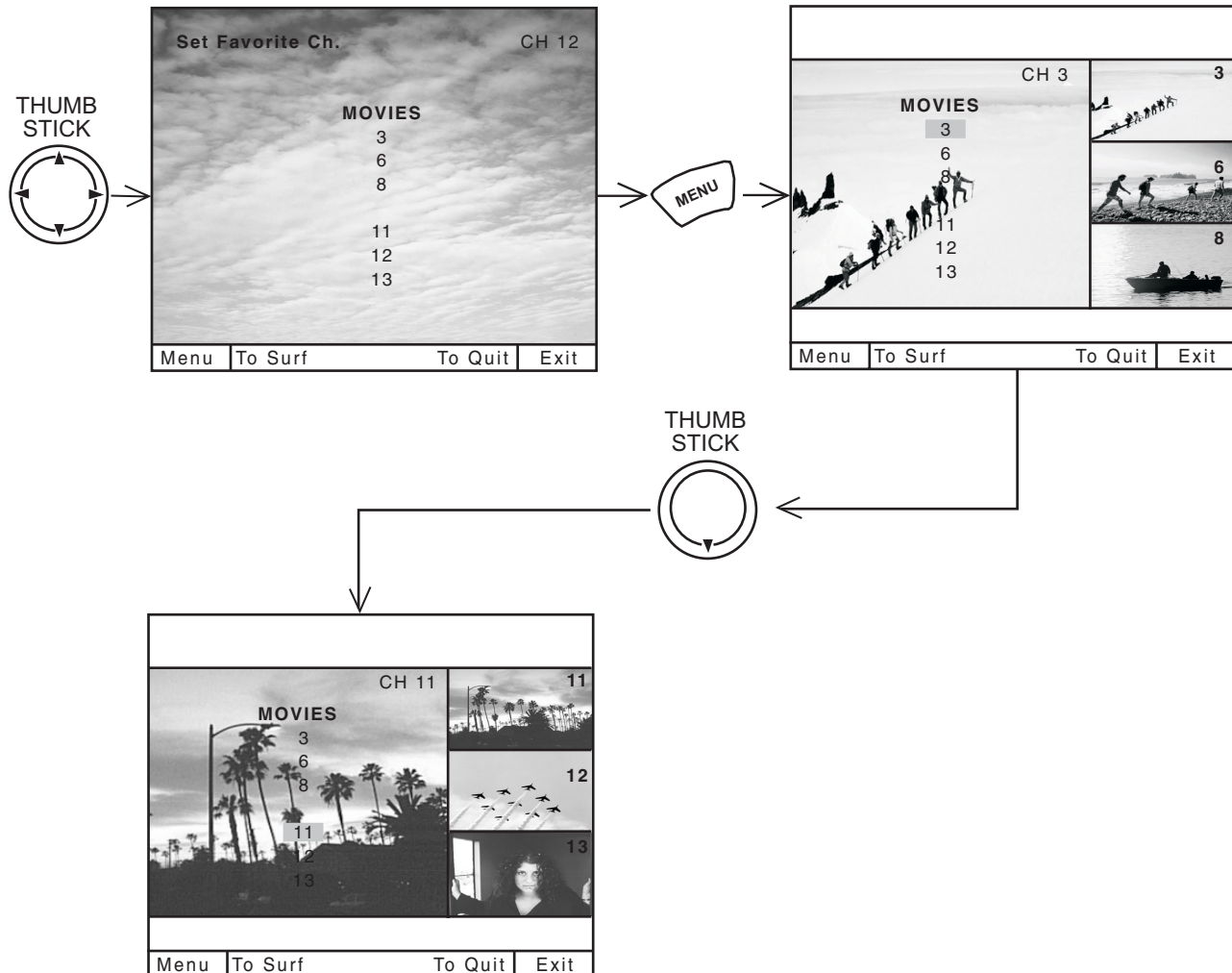

Select a category using THUMB STICK ◀ or ▶.

Press MENU and the category will be displayed as sub-pictures at the right edge of the screen. This is useful for previewing a category.

Use THUMB STICK ◀, ▶, ▲ or ▼ to highlight a favorite channel and the TV will automatically tune to that channel.

Press EXIT to remove FAVORITE CHANNELS OSD from the screen.

- NOTE:**
1. If a category has some blank channel entries, these channels will appear as black sub-pictures.
  2. Each category contains 2 groups of 3 channels. Pressing the MENU button will display only 1 group per category, depending on which group you select.
  3. When CLOSED CAPTION is set to AUTO and MUTE is ON, FAVORITE CHANNEL can not be accessed.

**SET PARENTAL LOCKS** This function will block out the picture and sound of the selected channel or video input. It can also be used to keep the TV from being viewed for a scheduled amount of time that you set.

The code to enter SET PARENTAL LOCKS is a four digit secret code number. The factory preset code is 0000. Use the number buttons to select secret code.

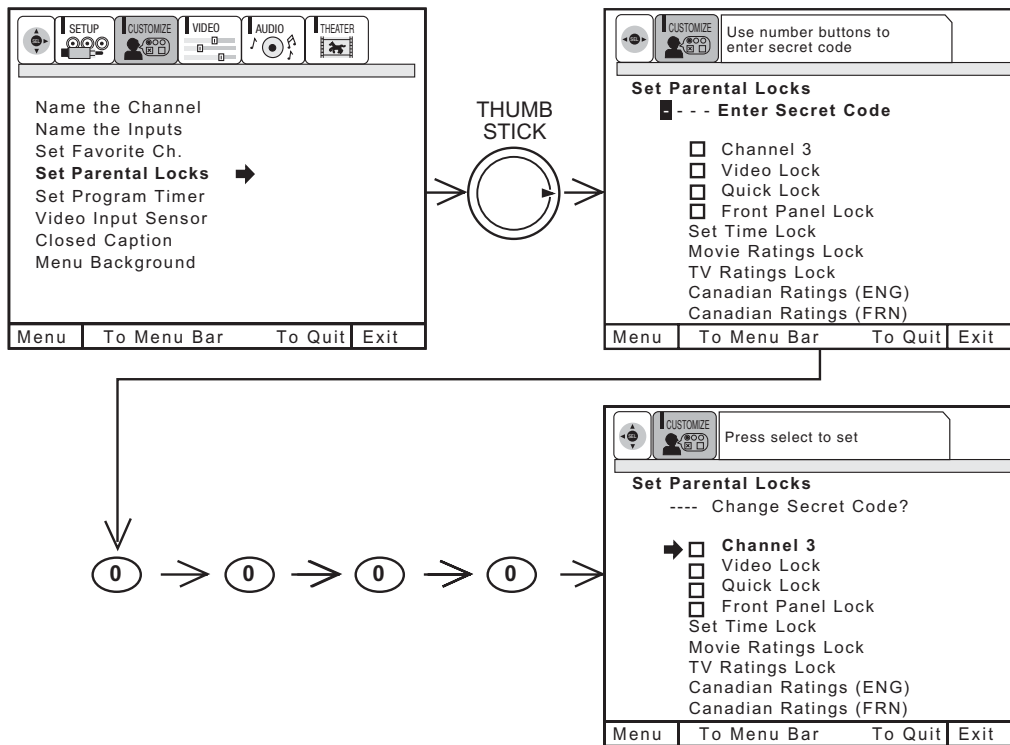

Use THUMB STICK ▲ or ▼ to highlight function and press down on the THUMB STICK to set ON or OFF.

When CHANNEL is turned on, the picture and sound for the chosen channel will be blocked out.

When VIDEO LOCK is turned on, the picture and sound for all video inputs will be blocked out. To lock the video inputs, you must be tuned to one of the video inputs.

When QUICK LOCK is turned on, the picture and sound for channels 3, 4 on both ANT A/B and all video inputs will be blocked out.

When FRONT PANEL LOCK is turned on, all buttons on the Front Panel will be deactivated, except the POWER button.

When SET TIME LOCK is turned on, you can set the BEGIN and END times and the TV cannot be viewed during that time period. (Set clock first.) Use THUMB STICK ▲ or ▼ to highlight ONCE (TV will time out one time only), DAILY (TV will time out every day), WEEKLY (TV will time out one time a week) or OFF (to disable this function) and then press down on THUMB STICK to SELECT your choice.

MOVIE RATINGS LOCK, TV RATINGS LOCK, and CANADIAN RATINGS are explained in detail in the Parental Control Movie/TV Ratings Reference Guide.

To change the secret code number, select CHANGE SECRET CODE. Enter a new four digit key number you prefer.

If you forget your secret code, use the factory code 7777 to erase your key number. This will reset the secret code number back to the factory preset 0000.

Press EXIT to quit menu or THUMB STICK ◀ to return to previous menu.

**NOTE:**

1. If ANT A and ANT B are in the same signal source mode (see page 37), when a channel is locked, it is locked on both antenna inputs.
2. When using SET TIME LOCK make sure the clock is set (see page 41).
3. Text appears on the screen to indicate that TV TIMED OUT (Set Parental Locks) is activated.

## SET PROGRAM TIMER

This function will automatically turn the TV on and off, one time only, every day, or once a week.

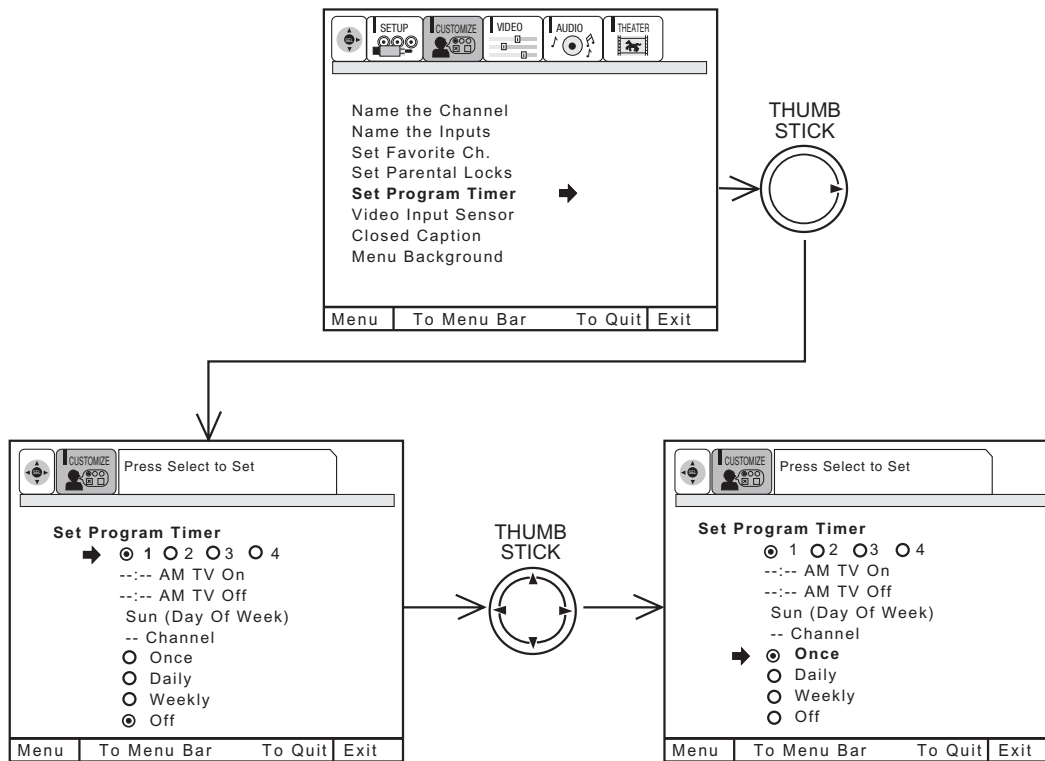

Use THUMB STICK ► to select PROGRAM 1, 2, 3, or 4.

Use THUMB STICK ▲ or ▼ to select the time the TV will turn on and off.

Use THUMB STICK ► to change position.

Use THUMB STICK ▲ or ▼ to select the day of the week you want the timer to turn on TV. (If you set timer to turn on DAILY, do not need to set DAY OF WEEK).

Use THUMB STICK ▲ or ▼, CHANNEL (▲) or (▼), or number buttons to set the channel the TV will tune to when it automatically turns on.

Use THUMB STICK ▲ or ▼ to highlight, then press down on the THUMB STICK to select mode ONCE (TV will turn on/off one time only), or mode DAILY (TV will turn on/off at the same time every day), WEEKLY (TV will turn on/off at same time every week) or OFF (to disable this function).

Press EXIT to quit menu or THUMB STICK ◀ to return to previous menu.

If the clock is not set, you can not use this function and the screen below will appear.

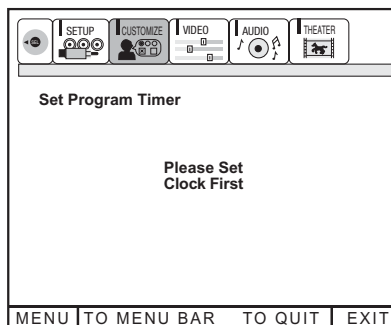

- NOTE:**
1. The OFF Timer will only activate if the TV was turned on or tuned with the ON Timer and no channel selection was made after this time. If you change the channel after the ON Timer has been activated, the OFF Timer will deactivate.
  2. If no remote control button is pressed after ON Timer is activated, the TV will automatically turn off after three hours.



**CAUTION:** Do not use your TV as a deterrent when away from home by using the ON and OFF TIMERS. For safety, the TV should be turned off when you are away from home.

## VIDEO INPUT SENSOR

Use this function to automatically turn the TV on and tune to VIDEO: 4 when it detects a VIDEO input.

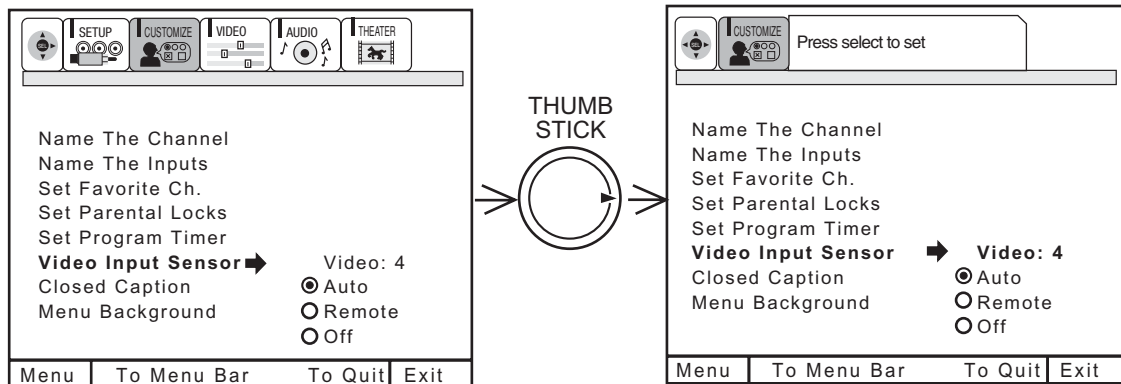

Use THUMB STICK ▲ or ▼, then press down on THUMB STICK to change VIDEO INPUT SENSOR setting.

When AUTO is selected, the TV will turn on and tune to VIDEO: 4 automatically, when the VIDEO: 4 input device is turned on. This is convenient when you want to watch a movie with your VCR, laserdisc player, or DVD player.

When REMOTE is selected, the TV will turn on and tune to VIDEO: 4 automatically, when the VIDEO: 4 input device is turned on and the VCR, laserdisc, or DVD play button on your remote control is pressed.

This is convenient when you want to record a movie with your VCR and watch it later.

Select OFF to disable this function.

Press EXIT to quit menu or THUMB STICK ◀ to return to previous menu.

- NOTES:**
1. Once the TV has been turned on using the VIDEO INPUT SENSOR feature, it must be reset before VIDEO INPUT SENSOR is used again. To do this, turn your VCR, laserdisc, or DVD player OFF. This feature is now reset and will turn on your TV as described above.
  2. When using REMOTE mode, any remote control button will substitute for your video input device play button. However, intended operation is for use with your VCR, laserdisc, or DVD play button.
  3. If no remote control button is pressed after the TV is turned on by VIDEO INPUT SENSOR, the TV will automatically turn off after three hours.

## CLOSED CAPTION

Closed Captions are the dialogue, narration, and/or sound effects of a television program or home video which are displayed on the TV screen. Your local TV program guide denotes these programs as **CC** or .

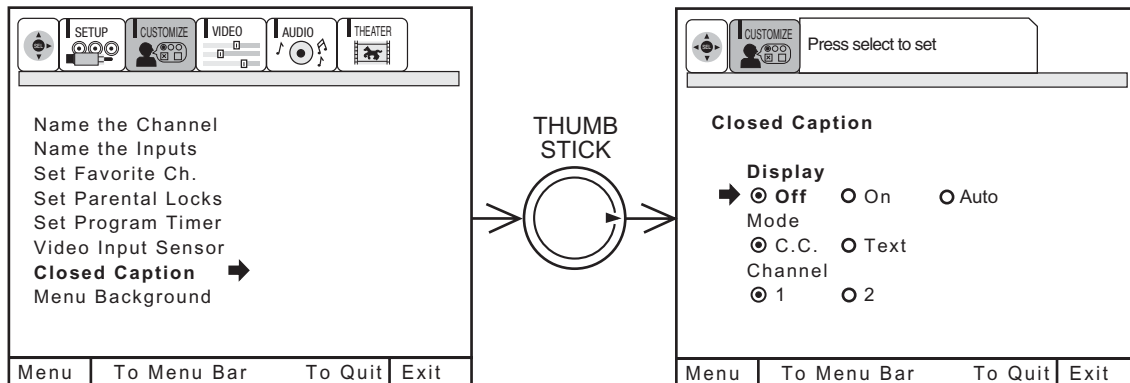

**DISPLAY:** **ON/OFF** will turn the **CC** display on or off.

**AUTO** will turn the **CC** display on when Mute/Soft Mute is on.

**MODE:** **C.C.** (Closed Caption) is for the program you are viewing.

**TEXT** is for additional information such as news reports or a TV program guide. This information covers the entire screen and viewing the TV program is not possible. **TEXT** may not be available with every **CC** program.

**CHANNEL:** **1** is used for the primary language (usually English).  
**2** is sometimes used for a second language (may vary by region).

Use THUMB STICK ▲, ▼ to highlight the function to change then press THUMB STICK to change the function. Press EXIT to quit menu or THUMB STICK ◀ to return to previous menu.

**NOTE:** 1. CLOSED CAPTION will not work when viewing a 480P, 720P, or 1080i input via the COMPONENT: Y-P<sub>B</sub>P<sub>R</sub> inputs.  
 2. When PIP Surf is on, Closed Caption will not work.

## MENU BACKGROUND

This function allows you to choose from two menu backgrounds.

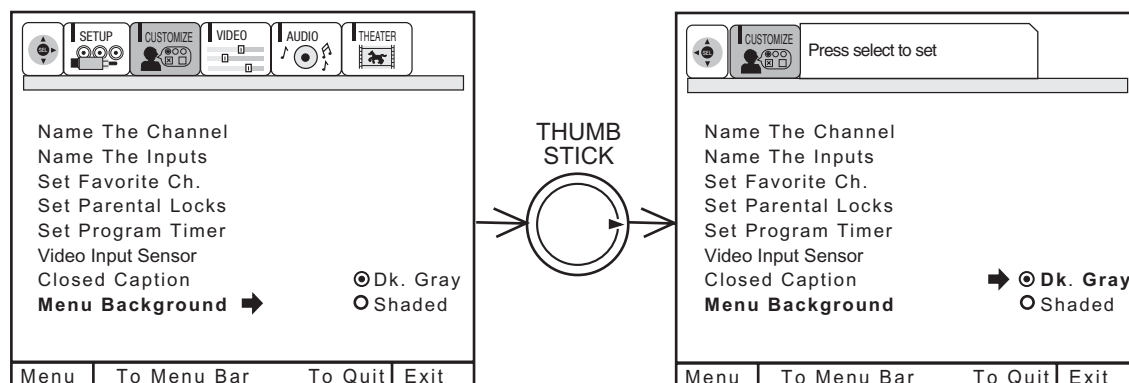

Use THUMB STICK ▲ or ▼ to highlight MENU BACKGROUND setting, and press down on THUMB STICK to select setting. Press EXIT to quit menu or THUMB STICK ◀ to return to previous menu. Select DARK GRAY and a dark gray background is visible (no picture can be seen behind menu screen), select SHADED and a light background is visible.

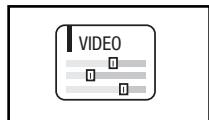

Select VIDEO to adjust picture settings and improve picture quality.

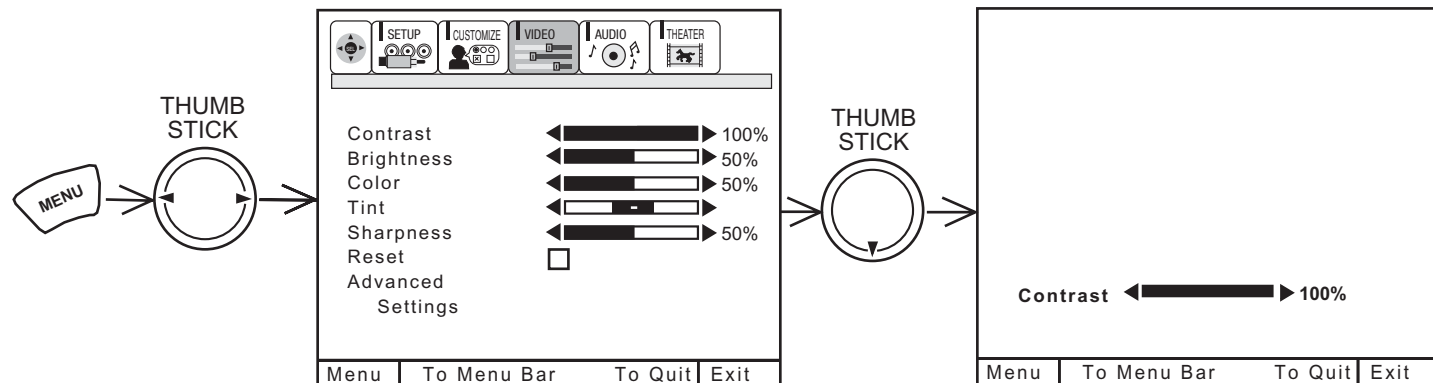

Use the THUMB STICK ▲ or ▼ to highlight the function to be adjusted.  
 Press the THUMB STICK ◀ or ▶ to adjust the function.  
 Press EXIT to quit menu.

**NOTE:** If CONTRAST is selected, you are adjusting CONTRAST. The additional menu items BRIGHTNESS, COLOR, TINT, and SHARPNESS can be selected and adjusted in the same manner.

- |                   |   |
|-------------------|---|
| <b>CONTRAST</b>   | Use this function to change the contrast between black and white levels in the picture. This adjustment will only affect the picture when ADVANCED SETTINGS PERFECT PICTURE is OFF. (see page 54) |
| <b>BRIGHTNESS</b> | Use this function to adjust overall picture brightness.   |
| <b>COLOR</b>      | Use this function to adjust the level of color in the picture.  |
| <b>TINT</b>       | Use this function to adjust flesh tones so they appear natural.   |
| <b>SHARPNESS</b>  | Use this function to adjust the amount of fine detail in the picture.   |
| <b>RESET</b>      | When RESET is selected, press down on THUMB STICK to return video adjustments to factory preset conditions.   |

**NOTE:**

1. It may be necessary to adjust TINT to obtain optimum picture quality when using the COMPONENT VIDEO Y-P<sub>B</sub>P<sub>R</sub> input jacks.
2. If you are using the COMPONENT VIDEO input jacks (Y-P<sub>B</sub>P<sub>R</sub>) and notice that the TINT and COLOR are abnormal, check to make sure that Picture Formats - Component Color Type is set properly. (see page 44)

## ADVANCED SETTINGS

Your HITACHI Projection TV has a PERFECT PICTURE function which will automatically adjust picture settings to produce the highest quality picture possible. When PERFECT PICTURE is highlighted, press down on THUMB STICK to turn the PERFECT PICTURE on or off.

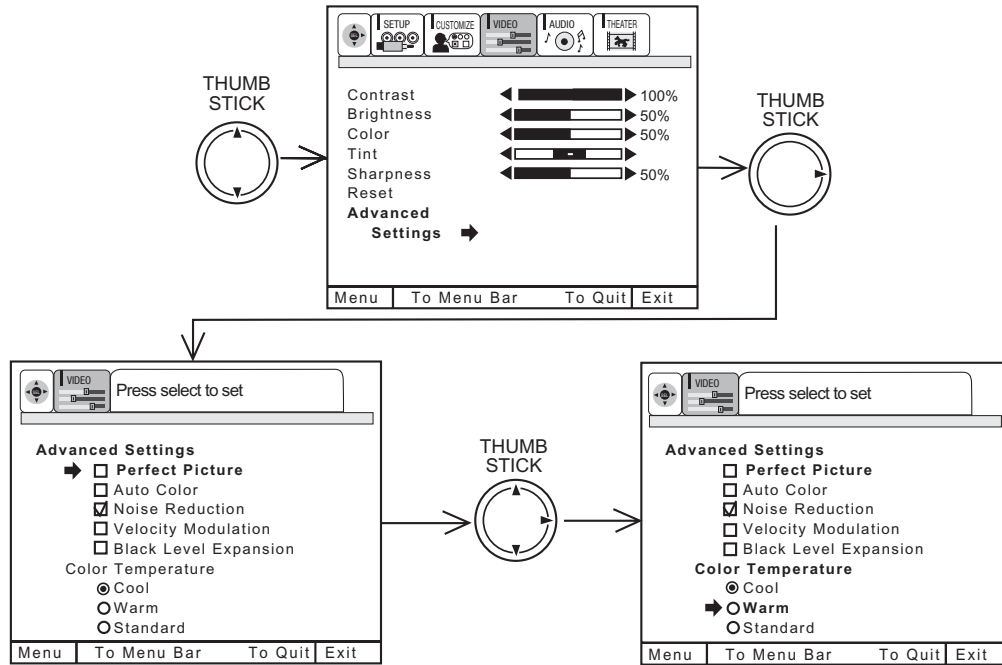

Use THUMB STICK ▲ or ▼ to select function.

Press down on THUMB STICK to select the function setting. When the function has an ✓ in the box, it is ON.

Press down on THUMB STICK to change COLOR TEMPERATURE setting. When the function shows a ⊙, it is selected.

Press EXIT to quit menu or THUMB STICK ◀ to return to previous menu.

### PERFECT PICTURE

When the PERFECT PICTURE function is on, the TV's internal computer will perform the following:

1. Automatically monitor and adjust contrast depending on room lighting (sensor is located in the front panel) to produce a more natural picture.
2. Automatically monitor and adjust color levels and maintain natural flesh tones.
3. Automatically compensate for weak or strong TV signals to produce a clear picture.

Turn the PERFECT PICTURE function off to control other PREFERENCE SETTINGS.

### AUTO COLOR

The AUTO COLOR function automatically monitors and adjusts the color to maintain constant color levels even after a program or channel changes. It also maintains natural flesh tones while preserving fidelity of background colors. (This function will automatically set to on and cannot be turned off when the PERFECT PICTURE function is ON.)

### NOISE REDUCTION

The NOISE REDUCTION function automatically reduces conspicuous noise in the picture without degrading picture quality. (This function will automatically be set to on and cannot be turned off when the PERFECT PICTURE function is ON.)

### VELOCITY MODULATION

The VELOCITY MODULATION function automatically enhances the edges between light and dark areas.

### BLACK LEVEL EXPANSION

The BLACK LEVEL EXPANSION function automatically enhances shadow detail in dark scenes.

### COLOR TEMPERATURE

Set this to WARM for hotter colors with more red, set to COOL for less intense colors with more blue, or set to STANDARD for standard color.





Select AUDIO to adjust the TV to your preference and to improve the sound quality.

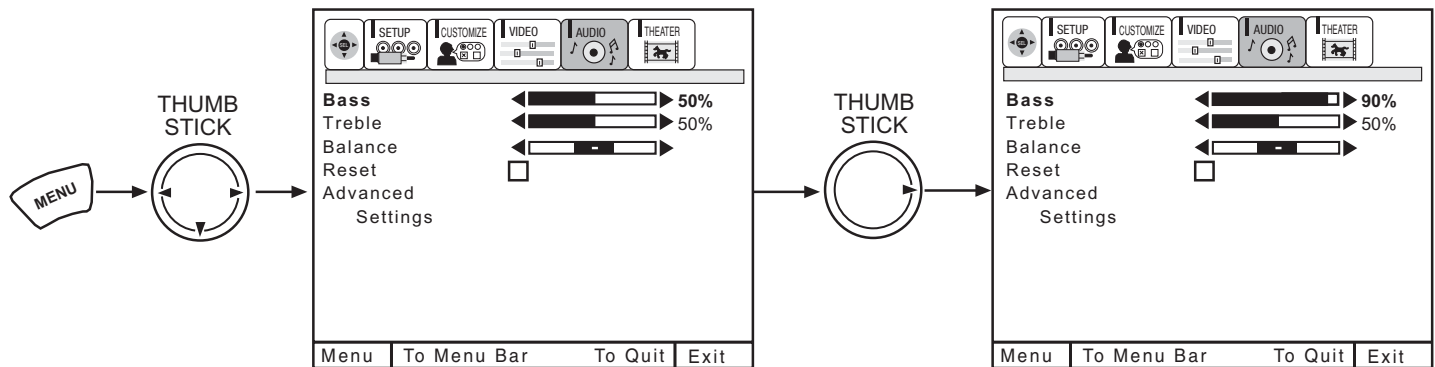

Use THUMB STICK ▲ or ▼ to highlight the function to be adjusted.  
 Press THUMB STICK ◀ or ▶ to adjust the function.  
 Press EXIT to quit MENU.

**NOTE:** If BASS is selected you are adjusting BASS. The additional menu items TREBLE and BALANCE can be selected and adjusted in the same manner.

**BASS**

This function controls the low frequency audio to all speakers.

**TREBLE**

This function controls the high frequency audio to all speakers.

**BALANCE**

This function will control the left to right balance of the TV internal speakers and the AUDIO TO HI FI output.

**RESET**

When RESET is selected, press CURSOR ▶ to return audio adjustments to factory preset conditions.



## ADVANCED SETTINGS

Use ADVANCED SETTINGS to improve the sound performance of your TV, depending on listening conditions.

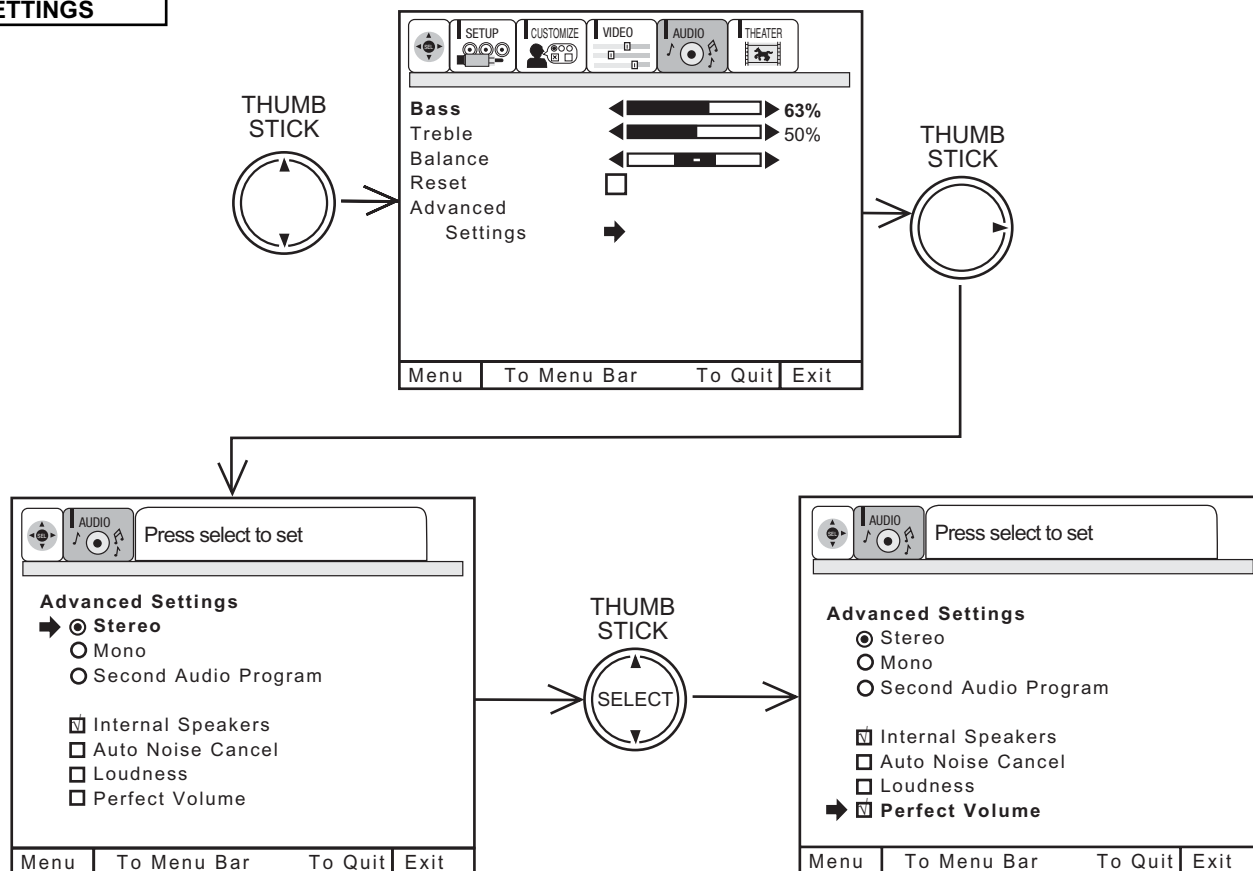

Press THUMB STICK ▲ or ▼ to highlight a function. Press down on THUMB STICK to change the function setting. When the function has an ✓ in the box, it is ON.

### MTS MODE

Multi-Channel Television Sound will allow you to select STEREO (a stereo broadcast), MONO (monaural sound) used when receiving a weak stereo broadcast or SAP (second audio program) which may be a secondary language, weather report, etc. The sources received will be displayed at the top center edge of the TV. The source you select will be displayed above the sources received. See example below for each selection when both stereo and second audio are received (monaural is always received).

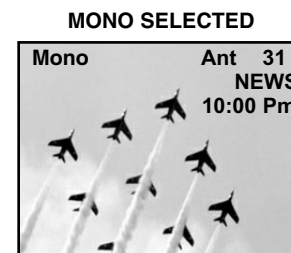

### INTERNAL SPEAKERS

This function is useful when first setting up the external speakers, or if you prefer to use only speakers from a separate stereo system.

### AUTO NOISE CANCEL

This function eliminates the noise between stations. If a channel is tuned and is noisy, this function will automatically eliminate the audio for that channel.

### LOUDNESS

This function will improve the quality of both low and high frequency sounds when listening at low volume levels.

### PERFECT VOLUME

This function will automatically adjust volume so each channel has the same average volume level.



# THEATER

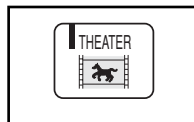

Use this function to choose picture and audio settings for a true home THEATER experience.

## THEATER MODES

Use this function to choose from automatic picture settings to optimize your TV's performance.

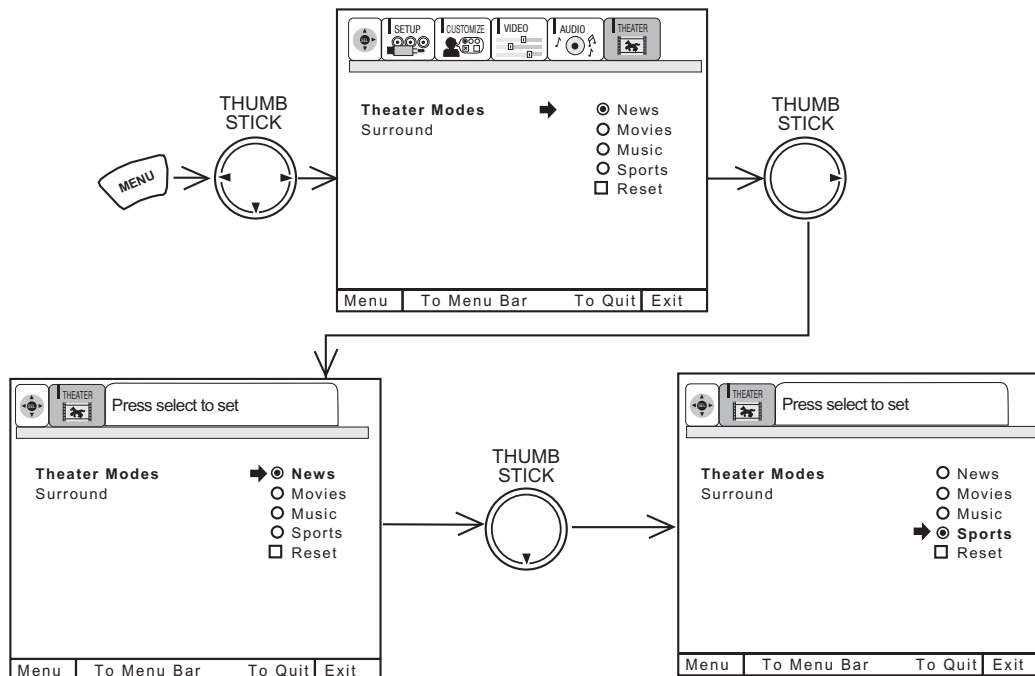

Use THUMB STICK ▲ or ▼ to change THEATER MODES settings.

When NEWS mode is chosen, the following are automatically set:

CONTRAST - 75%, COLOR TEMPERATURE - WARM, LOUDNESS - ON, PERFECT VOLUME - ON.

When MOVIES mode is chosen, the following are automatically set:

CONTRAST - 60%, COLOR TEMPERATURE - STANDARD, BASS - 63%, LOUDNESS - OFF, PERFECT VOLUME - OFF, SURROUND - SRS.

### NOTE: MOVIE MODE 3:2 PULLDOWN DETECTION SPECIAL FEATURE

Theatrical movies are shot on film at 24 frames or still pictures per second, instead of 30 frames or 60 fields like video. When film is transferred to video for television viewing, the disparity between the two frame rates must be reconciled. This involves a process known as 3:2 pulldown.

When MOVIE MODE is selected from the THEATER menu, your Hitachi Projection Television will activate the circuitry for this special feature to improve video performance when watching film based sources. This 3:2 pulldown detection will only work in MOVIE MODE.

When MUSIC mode is chosen, the following are automatically set:

CONTRAST - 75%, COLOR TEMPERATURE - COOL, LOUDNESS - OFF, PERFECT VOLUME - OFF, SURROUND - SRS and BBE.

When SPORTS mode is chosen, the following are automatically set:

CONTRAST - 100%, COLOR TEMPERATURE - COOL, BASS - 63%, LOUDNESS - OFF, PERFECT VOLUME - OFF, SURROUND - SRS.

You can customize each of the above modes (NEWS, MOVIE, MUSIC and SPORTS) to your preference to increase viewing performance and pleasure, depending upon the video program being viewed. However, if RESET is selected, all modes will reset to the initial conditions as explained above.

When RESET is selected, it will take approximately two seconds to return to factory conditions (SPORTS mode).

Press EXIT to quit menu or THUMB STICK ◀ to return to previous menu.



## Surround

The following surround settings will reproduce the live sound you would hear in concert halls, sports stadiums, movie theaters, etc. with only two speakers.

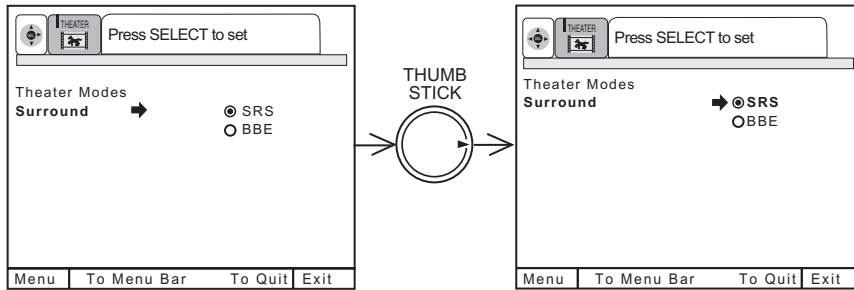

To enter the SURROUND MODE, use THUMB STICK ▲ or ▼ to highlight then press down on THUMB STICK to select SURROUND MODE of your choice.

### SURROUND OFF

Use this for normal stereo/mono broadcasts.



Based on the principles of the human hearing system, SRS technology delivers an exciting and realistic 3D Sound experience from just two external speakers (or) the two internal speakers of your HITACHI Television. If your HITACHI Television is connected to an external audio system, SRS will also create an incredible 3D sound experience from two speakers and even enhance a complete multi-speaker surround sound system.

**NOTES:** \*SRS and the  symbol are registered trademarks of SRS Labs, Inc. in the United States and selected foreign countries. SRS technology is incorporated under license from SRS Labs, Inc.

### BBE Technology

Sound reproduction quality enhancement system. The BBE technology produces sound that is natural and crisp from just two speakers (or) the two internal speakers of your HITACHI television. If your HITACHI television is connected to an external audio system, BBE will also create an incredible crisp sound experience from two speakers and even more complete and accurate reproduction of the original performance. BBE brings to the listener's ear a more complete and accurate reproduction of the original performance. Each voice, speaking or singing, each instrument or sound effect is presented with its attendant harmonics or partials more clearly audible. The ear can then more easily recognize the unique tonal colors of each sound as though the sound was being produced live.

**NOTES:** BBE functions the same manner on TV mode and on VIDEO mode.

**NOTES:** Licensed by BBE Sound, Inc. under USP4638258 and 4482866. BBE and BBE symbol are registered trademarks of BBE Sound, Inc. Manufactured under license from BBE Sound, Inc.

# CARE OF YOUR HITACHI PROJECTION TV AND YOUR REMOTE CONTROL



## **DO**

Dust the screen and cabinet with a soft cloth.

Clean the screen with a soft cloth moistened in warm water and dry with a soft cloth. A mild soap may be used if the screen is extremely dirty.

Place your television away from extreme heat, humidity, and extremely dusty places.

Remove the plug from the wall outlet if your television will not be used for a long period of time, for instances, when you go on vacation.

## **DO NOT**

Do not clean your screen or cabinet with strong cleaners, polishes or a chemically treated cloth.

Do not place rubber or vinyl products or cellophane tape on your television.

Do not touch the screen too often.

Do not subject the remote control to shocks such as dropping it on the floor, etc. Physical damage to the precision parts may result.





Avoid placing the remote control in a high humidity place or getting it wet. Do not leave it on or near a heater. Excessive heat or moisture may cause the unit to cease operation.

When the batteries run down, remote control operation will become erratic or possibly stop altogether. Replace the old batteries with two new AA size batteries.

Exposure of the viewing screen to prolonged direct sunlight or heat may cause the screen to permanently warp, resulting in a distorted picture.



# RECEPTION PROBLEMS

	<p>¥ IGNITION NOISE: Black spots or horizontal streaks may appear, picture may flutter or drift. Usually caused by interference from automobile ignition systems, neon lamps, electrical drills, and other electrical appliances.</p>
	<p>¥ GHOSTS: Ghosts are caused by the television signal following two paths. One is the direct path and the other is reflected from tall buildings, hills or some other objects. Changing the direction or position of the antenna may improve reception. Ghosting may also be caused by defects in the antenna system such as unshielded leads or connecting several sets to the same antenna without using multiple antenna couplers.</p>
	<p>¥ SNOW: If your receiver is located in the fringe area of a television station where the signal is weak, your picture may be marred by the appearance of small dots. When the signal is extremely weak, it may be necessary to install a special antenna to improve the picture.</p>
	<p>¥ RADIO FREQUENCY INTERFERENCE: The interference produces moving ripples or diagonal streaks, and in some cases, causes loss of contrast in the picture.</p>

**NOTE:** The TV set can generate sound distortion in external devices such as a radio. Please separate radio equipment from the TV set to a considerable distance.



SYMPTOMS	CHECK THESE ITEMS AND TRY THESE ADJUSTMENTS											
	Be sure external connection is correct	Be sure power cord is plugged in	Be sure TV is switched "ON"	Try another channel (station trouble)	Check antenna connections (back of TV)	Check outside antenna	Check for local interference	Adjust Contrast control	Adjust Brightness control	Adjust Color control	Adjust Tint control	Adjust Volume control
No Picture, no sound	●	●	●	●	●	●						
Sound OK, picture poor	●			●	●	●	●	●				
Picture OK, sound poor	●			●	●	●	●					●
Picture blurred	●			●	●	●	●					
Lines or streaks in picture				●	●	●	●					
Poor reception on some channels				●	●	●	●					
Picture rolls vertically				●			●					
No color	●			●	●	●	●			●		
Poor color	●			●	●	●	●			●	●	

HITACHI Projection Television incorporates advanced power surge protection technology designed to protect against component or circuit damage due to external or internal voltage power surges.

IF YOUR TELEVISION SHOULD APPEAR TO HAVE A LOSS OF POWER, PLEASE FOLLOW THIS PROCEDURE:

1. Press the power switch (ON/OFF switch) once.
2. If there is still no power, wait 30 seconds and press the power switch again.
3. If there is still no power, unplug the power cord from the wall. Wait 30 seconds and plug the power cord back in. Press the power switch again.

This protective technology should provide for years of lasting entertainment from your HITACHI Projection Television.



## Features:

- ¥ Superfine Picture Quality
  - 1200 Line Horizontal Resolution
- ¥ Pure Green and Red Filter Lenses
- ¥ PERFECT PICTURE System
- ¥ Multit-Picture-In-Picture with freeze.
- ¥ Remote (Controls many VCR brands, cable boxes, satellite boxes, and other audio equipment.)
- ¥ High Definition On-Screen Display (UltraTEC BIT-MAP)
- ¥ ON SCREEN PLUG and PLAY guide
- ¥ Full Set of Input Jacks, including S-VIDEO
- ¥ COMPONENT VIDEO: Y-P<sub>B</sub>/P<sub>R</sub>
- ¥ Velocity Modulation
- ¥ Closed Caption Decoder
- ¥ High Resolution Picture-In-Picture with Freeze
- ¥ Tuned Port Bass Reflex Speakers
- ¥ Magic Focus (Auto Digital Convergence) 53UDX10B/61UDX10B  
Digital Convergence (Digital Array) 43FDX10B/43FDX11B
- ¥ Dual Antenna Inputs
- ¥ Video Input Sensor
- ¥ 3 Dimensional Y/C Comb Filter
- ¥ Full 1080i HDTV capable when used with a Set-Top Box.
- ¥ **BBE** Technology.
- ¥ **SRS** Technology

\*SRS and the  symbol are registered trademarks of SRS Labs, Inc. in the United States and selected foreign countries. SRS technology is incorporated under license from SRS Labs, Inc.

\*Licensed by BBE Sound, Inc. under USP4638258 and 4482866. BBE and BBE symbol are registered trademarks of BBE Sound, Inc. Manufactured under license from BBE Sound, Inc.

## Inputs:

- ¥ Power Input . . . . .AC 120V, 60Hz
- ¥ Stand-By Power
  - 43FDX10B/43FDDX11B . . . . .2.7W
  - 53UDX10B/61UDX10B . . . . .2.7W
- ¥ Power Consumption (operating)
  - 43FDX11B/43FDX10B . . . . .225W
  - 53UDX10B/61UDX10B . . . . .216W
- ¥ Power Consumption (maximum)
  - 43FDX11B/43FDX10B . . . . .265W
  - 53UDX10B/61UDX10B . . . . .253W
- ¥ Antenna input impedance . . . . .75 Ohm
- ¥ Channel coverage . . . . .181ch.
  - VHF-Band . . . . .2 ~ 13
  - UHF-Band . . . . .14 ~ 69
  - CATV Mid Band . . . . .A-5 ~ A-1
  - . . . . .A-I
  - Super Band . . . . .J-W
  - Hyper Band . . . . .W+1 - W+28
  - Ultra Band . . . . .W+29 - W+84
- ¥ Video . . . . .1.0Vp-p, 75 Ohm
- ¥ S-Video
  - Luminance (Y) . . . . .1.0Vp-p, 75 Ohm
  - Chrominance (C) . . . . .0.286Vp-p, 75 Ohm
- ¥ Component Video
  - Luminance (Y) . . . . .1.0Vp-p, 75 Ohm
  - Chrominance (P<sub>B</sub>/P<sub>R</sub>) . . . . .0.7Vp-p, 75 Ohm
- ¥ Audio input level . . . . .47k Ohm

## Outputs:

- ¥ Video . . . . .1.0Vp-p, 75 Ohm
- ¥ Audio . . . . .470mVrms, 1k Ohm

## Dimensions:

	<b>43FDX10B/ 43FDX11B</b>	<b>53UDX10B</b>	<b>61UDX10B</b>
¥ Height (in.)	43 5/8	51 5/8	61 1/8
¥ Width (in.)	38 15/16	46	52 3/8
¥ Depth (in.)	20 1/16	25 5/16	28 7/8
¥ Weight (lbs.)	148	225	283

**NOTE:** Due to improvements, specifications in this operating guide are subject to change without notice.





# HITACHI

*Service  
hotline*

To locate an authorized  
HITACHI service facility  
in the continental U.S.A.  
and Canada,

**DIAL TOLL FREE**

7 days a week, 24 hours a day

**800 HITACHI**

**(1-800-448-2244)**

## **Hitachi America, LTD. Home Electronics Division**

Hitachi has made every effort to assure you hours of trouble free operation from your unit. However, should you require service, a network of Hitachi Authorized Service Facilities has been established in all 50 states and Puerto Rico. Each facility will provide you with convenient and expedient assistance. Our service hotline operator will direct you to the Hitachi Authorized Service Facility nearest you. Just present proof of purchase and/or delivery receipts to the Hitachi Authorized Service Facility, and service will be rendered in accordance with the terms of the limited warranty as stated on your warranty card or operating guide.

*Should you have any questions regarding warranty, service, operation, or technical assistance, please contact:*

**Hitachi America, LTD.  
Home Electronics Division  
1855 Dornoch Court  
San Diego, CA 92154**

*In Canada, please contact: 1-800-HITACHI  
(1-800-448-2244)*

**HITACHI (HSC) Canada Inc.  
6740 Campobello Road  
Mississauga, Ont. L5N 2L8**

# NOTES

---

# NOTES

---

**HITACHI**

## Free Manuals Download Website

<http://myh66.com>

<http://usermanuals.us>

<http://www.somanuals.com>

<http://www.4manuals.cc>

<http://www.manual-lib.com>

<http://www.404manual.com>

<http://www.luxmanual.com>

<http://aubethermostatmanual.com>

Golf course search by state

<http://golfingnear.com>

Email search by domain

<http://emailbydomain.com>

Auto manuals search

<http://auto.somanuals.com>

TV manuals search

<http://tv.somanuals.com>