

¹HITACHI

PROJECTION COLOR TV

**55EX9K 50EX8K/10B
50EX11BV/12KV**

OPERATING GUIDE

Your new HITACHI PROJECTION COLOR TV incorporates a host of features designed to give you excellent performance if you follow the instructions in this manual. Please read the following instructions and "IMPORTANT SAFEGUARDS" notice before turning on your TV for the first time.

Save these instructions for later use.



This television receiver will display television closed captioning ( or ), in accordance with paragraph 15.119 of the FCC rules.

TABLE OF CONTENTS

TABLE OF CONTENTS	2
IMPORTANT SAFEGUARDS	4
ACCESSORIES	9
REMOTE CONTROL BATTERY INSTALLATION AND REPLACEMENT	10
PICTURE CAUTIONS	11
HOW TO SET UP YOUR NEW HITACHI PROJECTION TV	12
ANTENNA	12
LOCATION	12
VIEWING	12
HOOK-UP CABLES AND CONNECTORS	13
ANTENNA CONNECTIONS	14
FRONT PANEL CONTROLS	15
<input type="checkbox"/> AVX (Audio/Video) selector	15
<input type="checkbox"/> VOLUME level	15
<input type="checkbox"/> CHANNEL selector	15
<input type="checkbox"/> POWER button	15
<input type="checkbox"/> POWER light	15
<input type="checkbox"/> AI (Artificial Intelligence) sensor	15
<input type="checkbox"/> REMOTE CONTROL sensor	15
AUDIO SYSTEM SET-UP	16
REAR PANEL JACKS	17
<input type="checkbox"/> Antenna Input	17
<input type="checkbox"/> Audio/Video Inputs 1, 2	17
<input type="checkbox"/> Output	17
<input type="checkbox"/> Audio to Hi-Fi	17
<input type="checkbox"/> S-Video	17
<input type="checkbox"/> Rear Speaker Terminals	17
<input type="checkbox"/> Speaker Matrix Surround Switch	17
REAR PANEL CONNECTIONS	18
CONNECTING TO REAR SPEAKER TERMINALS	18
TIPS ON REAR PANEL CONNECTIONS	18
THE GENIUS REMOTE CONTROL (CLU-692GR)	20
USING THE GENIUS REMOTE TO CONTROL VCR FUNCTIONS	21
USING THE GENIUS REMOTE TO CONTROL CABLE BOX FUNCTIONS	22
TABLE 1. VCR Precoded remote controls	22
TABLE 2. Cable Box Precoded remote controls	24
HOW TO USE THE GENIUS REMOTE TO CONTROL YOUR TV	25
<input type="checkbox"/> POWER button	25
<input type="checkbox"/> RECALL button	25
<input type="checkbox"/> MENU, ENTER, CURSOR buttons	25
<input type="checkbox"/> CHANNEL SELECTOR buttons	25
<input type="checkbox"/> AVX button	26
<input type="checkbox"/> VOLUME, MUTE buttons	26
<input type="checkbox"/> LAST CHANNEL (LST-CH) button	26
<input type="checkbox"/> PICTURE-IN-PICTURE buttons	26
-SET UP- FUNCTIONS	27
• CLOSED CAPTION 	27
• INITIAL SETTING	27
• AIR/CABLE	28
• AUTOPROGRAM	28
• CHANNEL MEMORY	28
• CLOCK SET	29
• CHANNEL CAPTION	29
• PROGRAM LIST	29
• TIMER SET	29

• AUTOMATIC MESSAGE	30
• FAVORITE CHANNELS	31
• VOLUME CORRECTION	32
PICTURE-IN-PICTURE (P-IN-P) FUNCTIONS	33
P IN P BUTTON.....	33
□ P-IN-P BUTTON	33
□ EXCHNG BUTTON	33
□ SHIFT BUTTON.....	33
□ FREEZE BUTTON	33
□ FREEZE BUTTON WITHOUT A SUB-PICTURE:	34
-PICTURE- FUNCTIONS	35
• PICTURE PROGRAM.....	35
• PICTURE SETTINGS.....	35
• AI.....	35
• AUTOCOLOR.....	36
• NOTCH FILTER	36
• NOISE REDUCER.....	36
• CONVERGENCE	36
-SOUND- FUNCTIONS	38
• SOUND PROGRAM	38
• SOUND SETTING	38
• MTS MODE (Multi-Channel Television Sound).....	38
• DYNAMIC BASS	39
• LOUDNESS	39
• INT. SPEAKERS	39
CARE OF YOUR PROJECTION TV AND REMOTE CONTROLS	40
TROUBLESHOOTING.....	41
RECEPTION PROBLEMS (EXTERNAL TO THE TV)	41
CHECK HERE BEFORE CALLING FOR SERVICE.....	41
SPECIFICATIONS	43

IMPORTANT SAFEGUARDS

Follow all warnings and instructions marked on this television receiver.



CAUTION: TO REDUCE THE RISK OF ELECTRIC SHOCK,
DO NOT REMOVE COVER (OR BACK).
NO USER-SERVICEABLE PARTS INSIDE.
REFER SERVICING TO QUALIFIED SERVICE PERSONNEL.

 The lightning flash with arrowhead symbol, within an equilateral triangle, is intended to alert the user to the presence of uninsulated "dangerous voltage" within the product's enclosure that may be of sufficient magnitude to constitute a risk of electric shock to persons.

 The exclamation point within an equilateral triangle is intended to alert the user to the presence of important operating and maintenance (servicing) instructions in the literature accompanying the appliance.

WARNING:
TO PREVENT FIRE OR SHOCK HAZARD, DO NOT EXPOSE THIS TELEVISION SYSTEM TO RAIN OR MOISTURE.

NOTE:

- There are no user serviceable parts inside the receiver.
- Model number and serial number are indicated on the back side of the set.

POWER SOURCE:

This projection color TV is designed to operate on 120 volts 60 Hz, AC household current.

Insert power cord plug into a 120 volt 60 Hz outlet.

NEVER CONNECT THE TV TO 50 Hz, DIRECT CURRENT, OR ANYTHING OTHER THAN THE SPECIFIED VOLTAGE.

CAUTION: THIS PROJECTION COLOR TV USES A SPECIAL POLARIZED POWER SUPPLY CORD. TO PREVENT ELECTRIC SHOCK DO NOT USE THIS (POLARIZED) PLUG WITH AN EXTENSION CORD, RECEPTACLE OR OTHER OUTLET UNLESS THE BLADES CAN BE FULLY INSERTED TO PREVENT BLADE EXPOSURE.

• POLARIZED PLUG



NOTE: Never remove the back cover of the set as this can expose you to very high voltages and other hazards. If the set does not operate properly, unplug the set and call your dealer or service shop.

HITACHI

SAFETY POINTS YOU SHOULD KNOW ABOUT
YOUR HITACHI TELEVISION RECEIVER

CAUTION:

- * Read all of these instructions.
- * Save these instructions for later use.
- * Follow all warnings and instructions marked on the television receiver.

Our reputation has been built on the quality, performance, and ease of service of HITACHI television receivers.

Safety is also foremost in our minds in the design of these units. To help you operate these products properly, this section illustrates safety tips which will be of benefit to you. Please read it carefully and apply the knowledge you obtain from it to the proper operation of your HITACHI television receiver. Please fill out your warranty card at once and mail it to HITACHI. This will enable HITACHI to notify you promptly in the improbable event that a safety problem should be discovered in your model of product.

FOR YOUR PERSONAL SAFETY

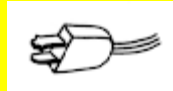

1 This television set is equipped with a polarized alternating-current line plug (a plug having one blade wider than the other). This plug will fit into the power outlet only one way. This is a safety feature. If you are unable to insert the plug fully into the outlet, try reversing the plug. If the plug should still fail to fit, contact your electrician to replace your obsolete outlet. Do not defeat the safety purpose of the polarized plug.

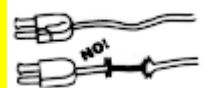

2 When the power cord or plug is damaged or frayed, unplug this television set from the wall outlet and refer servicing to qualified service personnel.



3 Do not overload wall outlets and extension cords as this can result in fire or electric shock.



4 Do not allow anything to rest on or roll over the power cord, and do not place the TV where the power cord is subject to traffic or abuse. This may result in a shock or fire hazard.



5 Do not attempt to service this television set yourself as opening or removing covers may expose you to dangerous voltage or other hazards. Refer all servicing to qualified service personnel.



6 Never push objects of any kind into this television set through cabinet slots as they may touch dangerous voltage points or short out parts that could result in a fire or electric shock. Never spill liquid of any kind on the television set.



7 If the television set has been dropped or the cabinet has been damaged, unplug this television set from the wall outlet and refer servicing to qualified service personnel.



8 If liquid has been spilled into this television set, unplug it from the wall outlet and refer service to qualified service personnel.



9 Do not subject your television set to impact of any kind. Be particularly careful not to damage the picture tube surface.



10 Unplug this television set from the wall outlet before cleaning. Do not use liquid cleaners or aerosol cleaners. Use a damp cloth for cleaning.



11-1 Do not place this television set on an unstable cart, stand, or table. The television set may fall, causing serious injury to a child or an adult, and serious damage to the appliance. Use only with a cart or stand recommended by the manufacturer, or sold with the television set. Wall or shelf mounting should follow the manufacturer's instructions, and should use a mounting kit approved by the manufacturer.



11-2 An appliance and cart combination should be moved with care. Quick stops, excessive force, and uneven surfaces may cause the appliance and cart combination to overturn.

PROTECTION AND LOCATION OF YOUR SET

12 Do not use this television set near water, for example, near a bathtub, washbowl, kitchen sink, or laundry tub, in a wet basement, or near a swimming pool, etc.



- Never expose the set to rain or water. If the set has been exposed to rain or water, unplug the set from the wall outlet and refer servicing personnel.



13 Choose a place where light (artificial or sunlight) does not shine directly on the screen.



14 Avoid dusty places, since accumulated dust inside the chassis may cause failure of the set when high humidity persists.

15 The set has slots, or openings in the cabinet for ventilation purposes, to provide reliable operation of the receiver, and to protect from overheating. These openings must not be blocked or covered.



- Never cover the slots or openings with cloth or other material.



- Never block the bottom ventilation slots of the set by placing it on a bed, sofa, rug, etc.



- Never place the set near or over a radiator or heat register.



- Never place the set in a "built-in" enclosure, unless proper ventilation provided.

PROTECTION AND LOCATION OF YOUR SET

16-1 If an outside antenna is connected to the television set, be sure the antenna system is protected against voltage surges and built up static charges, Section 810 of the National Electrical Code, NFPA No. 70-1975, provides information with respect to proper grounding of the mast and supporting structure, grounding of the lead-in wire to an antenna discharge unit, size of grounding conductors, location of antenna discharge unit, connection to grounding electrode, and requirements for the grounding electrode.

EXAMPLE OF ANTENNA GROUNDING

16-2 **Note to CATV system installer:** (Only for the television set with CATV reception) This reminder is provided to call the CATV system installer's attention to Article 820-40 of the NEC that provides guidelines for proper grounding and, in particular, specifies that the cable ground shall be connected to the grounding system of the building, as close to the point of cable entry as practical.

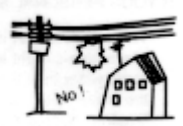

17 An outside antenna system should not be located in the vicinity of overhead power lines or other electrical lights or power circuits, or where it can fall into such power lines or circuits. When installing an outside antenna system, extreme care should be taken to keep from touching such power lines or circuits as contact with them might be fatal.



18 For added protection for this television set during a lightning storm, or when it is left unattended and unused for long periods of time, unplug it from the wall outlet and disconnect the antenna. This will prevent damage due to lightning and power-line surges.

OPERATION OF YOUR SET



19 This television set should be operated only from the type of power source indicated on the marking label. If you are not sure of the type of power supply at your home, consult your television dealer or local power company. For television sets designed to operate from battery power, refer to the operating instructions.



20 If the television set does not operate normally by following the operating instructions, unplug this set television set from the wall outlet and refer servicing to qualified service personnel. Adjust only those controls that are

covered in the operating instructions as improper adjustment of other controls may result in damage and will often require extensive work by a qualified technician to restore the television set to normal operation.



21 When going on a holiday: If your television set is to remain unused for a period of time, turn the television set "off" and unplug it from the wall outlet.

IF THIS SET DOES NOT OPERATE PROPERLY



22 If you are unable to restore normal operation by following the detailed procedure in your operating instructions, do not attempt any further adjustment. Unplug the set and call your dealer or service technician.

23 Whenever the television set is damaged or fails, or a distinct change in performance indicates a need for service, unplug the set and have it checked by a professional service technician.

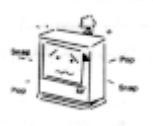

24 It is normal for some TV sets to make occasional snapping or popping sounds, particularly when being turned on or off. If the snapping or popping is continuous or frequent, unplug the set and consult your dealer or service technician.

FOR SERVICING AND MODIFICATION



25 Do not use attachments not recommended by the television set manufacturer as they may cause hazards.

26 When replacement parts are required, be sure the service technician has used replacement parts specified by the manufacturer that have the same characteristics as the original part. Unauthorized substitutions may result in fire, electric shock, or other hazards.



27 Upon completion of any service or repairs to the television set, ask the service technician to perform routine safety checks to determine that the television is in safe operating condition.

ACCESSORIES

CHECK TO MAKE SURE YOU HAVE THE FOLLOWING ACCESSORIES BEFORE DISPOSING OF THE PACKAGING MATERIAL.

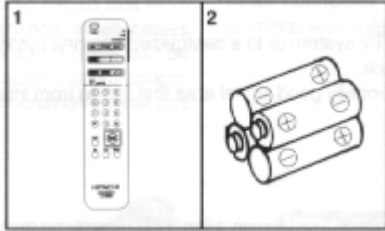

1. GENIUS Remote Control Unit: CLU-692GR (Part No.2573922)
2. Two "AA" size, 1.5V batteries (For Remote Control Unit)

REMOTE CONTROL BATTERY INSTALLATION AND REPLACEMENT

Open the battery cover of the remote transmitter by pushing the notched part of the cover with your fingers.

- a) Push batteries towards the springs and lift them out.
- b) Replace the old batteries with two new "AA" size batteries for the Genius Remote.
- c) Match the (+) and (-) marks in the battery compartment with the (+) and (-) terminal of the batteries.
- d) Replace the cover.

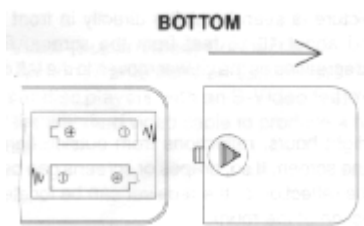

PICTURE CAUTIONS

WARNING

Continuous on-screen displays such as video games, stock market quotations, computer generated graphics, and other fixed (non-moving) patterns can cause permanent damage to projection television receivers. Such "PATTERN BURNS" constitute misuse and are NOT COVERED by your Hitachi Factory Warranty.

When using the Picture-in-Picture function, the sub-picture should not be left permanently in one corner of the screen or a "pattern burn" may develop over a long period of time.

This projection television receiver was intended mainly for the private viewing of programs broadcast by TV stations and cable companies and programs from other video sources. Public viewing may require prior authorization from the broadcaster or owner of the video program.

HOW TO SET UP YOUR NEW HITACHI PROJECTION TV

ANTENNA

Unless your TV is connected to a cable TV system or to a centralized antenna system, a good outdoor color TV antenna is recommended for the best performance. However, if you are located in an exceptionally good signal area that is free from interference, and multiple image ghosts, an indoor antenna may be sufficient.

LOCATION

Select an area where sunlight or bright indoor illumination will not fall directly on the picture screen. Also, be sure that the location selected allows free flow of air to and from the perforated back cover of the set. To avoid cabinet warping, cabinet color changes, and increased chance of set failure, do not place the TV where temperatures can become excessively hot. For example, in direct sunlight or near a heating appliance, etc.

VIEWING

The major benefit of the HITACHI Projection Television is its large viewing screen. To see this large screen at its best, test various locations in the room to find the best spot for viewing. The drawings give several suggestions.

The best picture is seen by sitting directly in front of the TV and about 10 to 18 feet from the screen. Picture brightness decreases as the viewer moves to the left or right of the receiver.

During daylight hours, reflections from outside light may appear on the screen. If so, drapes or screens can be used to reduce the reflection or the TV can be located in a different section of the room.

If the TV's audio output will be connected to a Hi-Fi system's external speakers, the best audio performance will be obtained by placing the speakers equidistant from each side of the receiver cabinet and as close as possible to the height of the picture screen center. For best stereo separation, place the external speakers at least 4 feet from the side of the TV. Place the surround speakers to the side or behind the viewing area. Differences in room sizes and acoustical environments will require some experimentation with speaker placement for best performance.

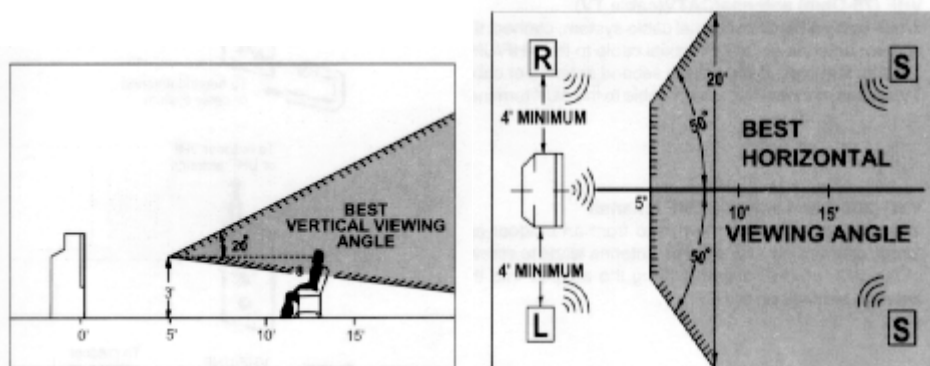

NOTE: The magnetic field of external speakers may cause the TV picture to distort if the speakers are placed too close to the television. Move the speakers away from the TV until there is no picture distortion.

HOOK-UP CABLES AND CONNECTORS

Most video/audio connections between components can be made with shielded video and audio cables that have phono connectors. For best performance, video cables should use 75-Ohm coaxial shielded wire. Cables can be purchased from most stores that sell audio/video products. Below are illustrations and names of common connectors. Before purchasing any cables, be sure of the output and input connector types required by the various components. Also make sure the cables are the correct length.

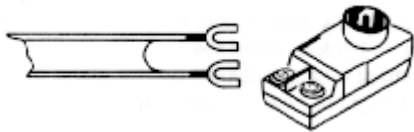

300-Ohm Twin Lead Connector Coaxial

This outdoor antenna cable must be connected to an antenna adaptor (300-Ohm to 75-Ohm) signals (antenna or cable the television.



"F" Type 75-Ohm Antenna

For connecting RF

TV) to the antenna jack on

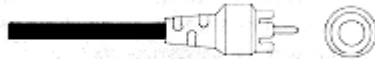

Phono Connector Connector

Used on all standard video and audio cables which connect to inputs and outputs located on the Television's front and rear jack panels. standard video cable to produce



S-Video (Super Video)

This connector is and laser disc in place of the a high-quality picture.

ANTENNA CONNECTIONS

VHF (75-) antenna/CATV(cable TV)

When using a 75-ohm coaxial cable system, connect the outdoor antenna or CATV coaxial cable to the VHF/UHF 75-ohm terminal.

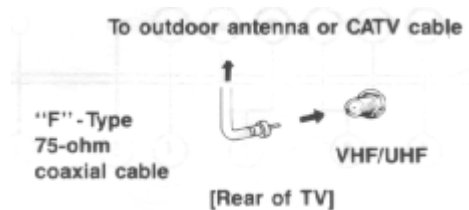

VHF (300-) antenna/UHF antenna

When using a 300-ohm twin lead from an outdoor antenna, disconnect the VHF or UHF indoor antenna leads from screws of the VHF or UHF adaptor, and connect outdoor VHF or UHF antenna leads to these screws of the VHF or UHF adaptor.

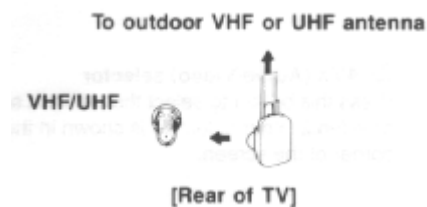

When both VHF and UHF antennas are connected

Attach an optional ANT. MIXER (antenna cable mixer) to the TV antenna terminal, and connect the cables to the ANT. MIXER. Consult your dealer or service store for the ANT. MIXER.

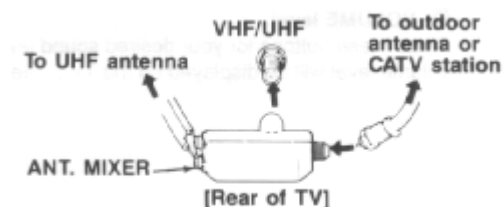

FRONT PANEL CONTROLS

Click to see front panel diagram.

AVX (Audio/Video) selector

Press this button to select the antenna source, video:1, or video:2. Your selection is shown in the top right corner of the screen.

VOLUME level

Press these buttons for your desired sound level. The volume level will be displayed on the TV screen.

CHANNEL selector

Press these buttons until the desired channel appears in the top right corner of the TV screen.

POWER button

Press this button to turn the TV on or off.

POWER light

You will see a red light when the TV is turned on.

NOTE: Your HITACHI TV will appear to be turned "off" if there is no video input when VIDEO:1 or 2 is selected using the AVX button. Check the Power On indicator to make sure the TV is off when not in use.

AI (Artificial Intelligence) sensor

This "Artificial Intelligence" sensor will make automatic picture adjustments depending on the amount of light in the room to give the best picture. See page 34.

REMOTE CONTROL sensor

Point your Genius Remote at this area when selecting channels, adjusting volume, etc.

AUDIO SYSTEM SET-UP

- Match the numbers below to the diagram for speaker placement and refer to the table for the surround sound requirements.

The television's internal speakers.

These speakers are connected to a separate audio amplifier. Use the "Audio to Hi-Fi" output on the TV.

These speakers are connected to the Rear Speaker 8□ output on the TV. These speakers are used as "fill-in" speakers for the surround feature so they won't sound as loud as the other speakers in the system. This is needed to create the special "movie theater-like" sound effect.

[Click to see Audio System Set-Up](#)

* See page 11 for location of surround switch.

REAR PANEL JACKS

Click to see Rear Panel Jacks.

Antenna Input

Use an "F" type coaxial cable to connect an antenna or cable TV (CATV) output to this rear panel jack.

Audio/Video Inputs 1, 2

The "AVX" (Auxiliary video) button will step through each video source and the input each time it is pressed. Use the audio and video inputs to connect external devices, such as VCRs, camcorders, laser disc players, video games, etc.

Output

These jacks provide fixed audio and video signals which are used for recording.

Audio to Hi-Fi

These jacks provide variable audio output to a separate stereo system amplifier. With this connection, the audio to the stereo can be controlled by the television's remote control.

S-Video

Input 1 provides S-Video (Super Video) jacks for connecting equipment with S-Video output capability.

Rear Speaker Terminals

These terminals are used to connect external speakers, which are used for the surround sound feature. The volume level is controlled by the remote control volume buttons. Use speakers with 8 Ω impedance only.

Speaker Matrix Surround Switch

Use this switch to choose between the surround sound and external speaker features. See page 10 for Audio System Set-up.

REAR PANEL CONNECTIONS

Click to see Rear Panel Connections.

Typical full-feature set-up. Follow connections that pertain to your personal entertainment system.

CONNECTING TO REAR SPEAKER TERMINALS

Connect after turning the power of the TV OFF.

- Press the Right Speaker red button and insert the positive lead wire + into the hole above the button. In the same manner, press the Right Speaker black button and insert the negative lead wire -. Repeat this procedure for the Left Speaker.

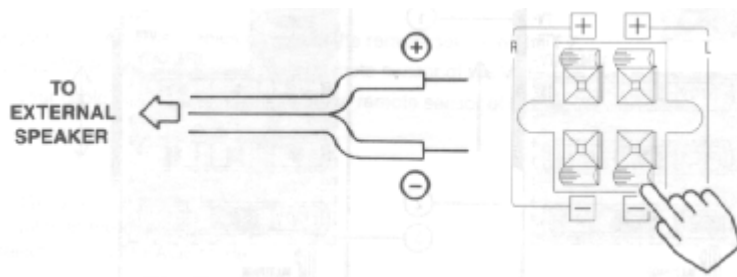

CAUTION: Do not connect Speakers simultaneously to the REAR SPEAKER terminal of the Projection TV and Amplifier. This could damage both the Projection TV and the Speakers.

Your Hitachi TV was designed to use 8Ω speakers only. Any other type may degrade the audio performance of your entertainment system.

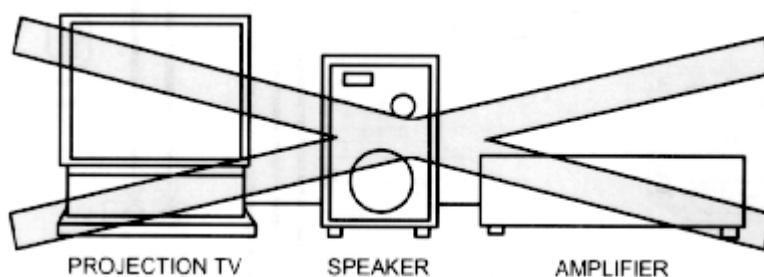

TIPS ON REAR PANEL CONNECTIONS

- The S-Video connection is provided for high performance laser discs, VCRs, etc., that have this feature. Use this connection in place of the standard video connection if your device has this feature.
- If your device has only one audio output, connect it to the left audio jack on the TV.
- Refer to the operating guide of your other electronic equipment for additional information on connecting your hook-up cables.

-
- A single VCR can be used for VCR#1 and VCR#2, but note that a VCR cannot record its own video or line output (input 1 in the example on pg. 12). Refer to your VCR operating guide for more information on "line" input-output connections.

THE GENIUS REMOTE CONTROL (CLU-692GR)

- Refer to page 15 for description of remote control buttons.

[Click here to see CLU-692GR and Multi-Page Windows](#)

In addition to controlling all the functions on your Hitachi Projection TV, the new Genius Remote control is designed to operate different types of VCR's (also abbreviated VTR) and different types of CATV converters (cable boxes) with one touch. Basic operation buttons are grouped together in one area. All other controls are separated from them and arranged in MULTI-PAGE sections, with a display that can be switched to cover any of the three pages. Functions are arranged and properly categorized into windows. Making operation simple even when multiple functions are to be controlled

- To operate your TV, point the Genius remote at the remote sensor of the TV.
- To operate your VCR, point the remote at the remote sensor of the VCR.
- To operate your cable box, point the remote at the remote sensor of the cable box.

MULTI-PAGE SELECT SWITCH

Slide the switch in the direction of the arrow to select the MULTI-PAGE mode.

- Button layout when "TV" is selected.

- Button layout for "VCR."
(Power button turns the VCR on or off.)

- Button layout for "MENU/CATV."
(Power button turns cable box on or off.) See pages 17, 19 and 20.

TV EXCLUSIVE BUTTONS

These will always control the TV even when the Multi-Page select switch is in the VCR or MENU/CATV position.

PRECODED BUTTONS

These buttons will control a VCR or a cable box when the Multi-Page select switch is in the VCR or MENU/CATV position.

LIGHT BUTTON

When you are in a dark room, press this button to light up the channel and volume buttons. The light will stay on for about 8 seconds if no button is pressed. The buttons will not appear to light if the room is too bright.

USING THE GENIUS REMOTE TO CONTROL VCR FUNCTIONS

- To operate your VCR, point the Genius remote at the remote sensor of the VCR.

The Genius remote is designed to operate different types of VCR's. You must first program the Genius remote to match the remote system of your VCR. (Refer to Table 1 on page 18).

- (1) Turn ON your VCR.
- (2) Set the Multi-Page select switch on the Genius remote to VCR.
- (3) AIM the Genius remote at the front of your VCR.
- (4) While holding down the SELECT button, press the button that matches your VCR as shown on page 18. The channels on the VCR will begin changing after 5 seconds when the correct button is pressed. When this happens the Genius Remote control is programmed for your VCR. If the VCR channels do not change after 5 seconds, try a different Genius Remote button.
- (5) Release both buttons when the VCR starts to change channels. The precoded VCR buttons will now control your VCR.

NOTES:

- If your VCR cannot be operated after performing the above procedures, the codes have not been precoded into the Genius remote control and it will not be able to operate your VCR.
- You will only have to program your remote control to match your VCR once. The remote will remember the codes until you replace the batteries.
- Whenever you install or replace batteries in the Genius remote, you must reprogram the Genius remote to match the remote system of your VCR.
- When operating your TV or a cable box, remember to set the Multi-Page select switch to the proper position.
- Refer to the instruction manual for the VCR to operate buttons exclusively for the VCR.
- Be sure to keep the original remote control for the VCR even if you use the Hitachi Genius remote to control your VCR.

USING THE GENIUS REMOTE TO CONTROL CABLE BOX FUNCTIONS

- To operate your cable box, point the Genius remote at the remote sensor of the cable box.

The Genius remote is designed to operate different types of cable boxes. You must first program the Genius remote to match the remote system of your cable box. (Refer to Table 2 on page 18).

- (1) Turn ON your cable box.
- (2) Set the Multi-Page select switch on the Genius remote to MENU/CATV.
- (3) AIM the Genius remote at the front of your cable box.
- (4) While holding down the SELECT button, press the button that matches your cable box as shown on page 18. The channels on the cable box will begin changing after 5 seconds when the correct button is pressed. When this happens the Genius Remote control is programmed for your cable box. If the cable box channels do not change after 5 seconds, try a different Genius Remote button.
- (5) Release both buttons when the cable box starts to change channels. The precoded cable box buttons will now control your cable box.

NOTES:

- If your cable box cannot be operated after performing the above procedures, the codes have not been precoded into the Genius remote control and it will not be able to operate your cable box.
- You will only have to program your remote control to match your cable box once. The remote will remember the codes until you replace the batteries.
- Whenever you install or replace batteries in the Genius remote, you must reprogram the Genius remote to match the remote system of your cable box.
- When operating your TV or VCR, remember to set the Multi-Page select switch to the proper position.
- Be sure to keep the original remote control for the cable box even if you use the Hitachi Genius remote to control the cable box.

TABLE 1. VCR Precoded remote controls

VCR Brand	Press SELECT and this button
Canon	6
Citizen	0
Curtis Mathis	2 / 6
Dimensia	2
GE	2 / 6
Goldstar	0
Hitachi	1
Instant Replay	6
JC Penny	1 / 6 / 9
JVC	0
Kenwood	0
Magnavox	4 / 6
Marantz	9
Marta	0



Memorex	6
MGA	7
Minolta	1
Mitsubishi	7
Montgomery Wards	CHANNEL ▲
NEC	9
Panasonic	6
Pentax	1
Philco	4 / 6
Philips	4 / 6
Pioneer	1
ProScan	2
Quasar	6
RCA	1 / 2
Realistic	6 / 9 / CHANNEL ▲
Sanyo	9
Scott	7 / 8
Sears	1 / 9
Sharp	CHANNEL ▲
Sony	5 / VOLUME ▲ / VOLUME ▼
Sylvania	4 / 6
Tashiko	0
Technics	6
Toshiba	1 / 8
Wards	CHANNEL ▲
Yamaha	9
Zenith	3 / 5



TABLE 2. Cable Box Precoded remote controls

CATV brand	Press SELECT and this button
General Instrument	0 / 1 / 2 / 3 / 8
Hamlin	4
Jerrold	0 / 1 / 2 / 3 / 8
Pioneer	7
Regal	4
Scientific Atlantic	6
Viewstar	9
Zenith	5

HOW TO USE THE GENIUS REMOTE TO CONTROL YOUR TV

POWER button

Press this button to turn the TV set on or off.

RECALL button

When you want to check the channel being received, or if it has a stereo (ST) or second audio (SA) program, press the "RECALL" button. You can also check the time, and if the ON TIME or OFF TIME has been set. (These functions are explained in the MENU - SET UP section beginning on page 22.)

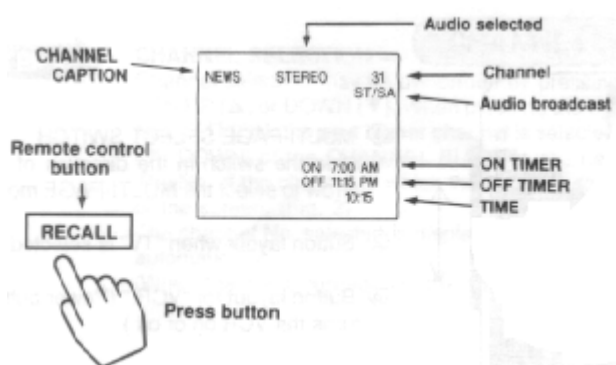

If a video input is used:

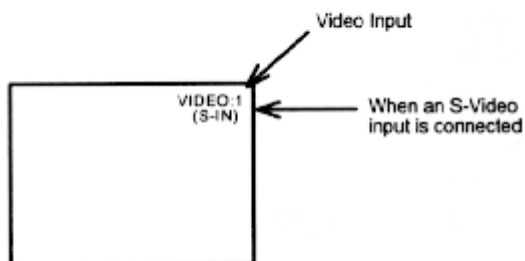

You can also use the "RECALL" button to quickly clear many of the other on-screen displays.

Click to see the Remote.

MENU, ENTER, CURSOR buttons

All the on-screen display features can be set or adjusted by using these buttons.

The "MENU" button will start or exit the on-screen display.

The "CURSOR" buttons will highlight functions or adjust different features.

The "ENTER" button will set features to your preference.

CHANNEL SELECTOR buttons

Enter two or three numbers to select channels. Enter a "0" first for channels 1 to 9. Use the "100" button for channels 100 and higher.

Channel selection may also be performed by pressing channel up (▲) or down (▼).

NOTE: THE TV MAY NOT RECEIVE SOME CHANNELS IF YOU ARE NOT IN THE CORRECT AIR/CABLE MODE. SEE PAGE 23.

AVX button

The AVX (Auxiliary Video) button will select between the antenna signal and the two sets of video input jacks each time the button is pressed.

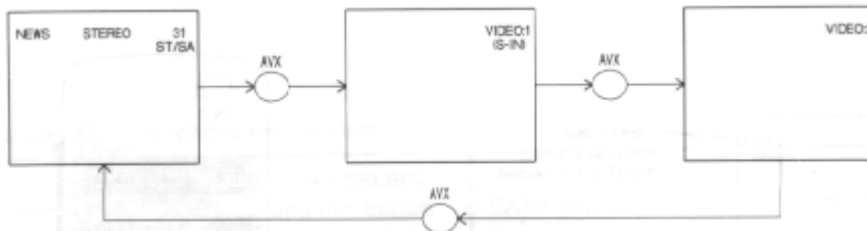

VOLUME, MUTE buttons

Press the "VOLUME" up (▲) or down (▼) button until you obtain the desired sound level.

To turn the sound off instantly to answer the telephone, etc., press the "MUTE" button. Press the "MUTE" button again or press the "VOLUME" up (▲) button to restore the sound.

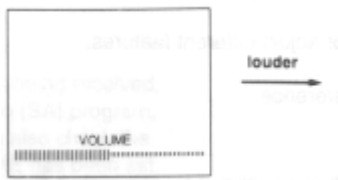

The word "MUTE" will remain displayed if the CLOSED CAPTION feature is turned off.



The word "MUTE" will not be displayed if the CLOSED CAPTION feature is on.

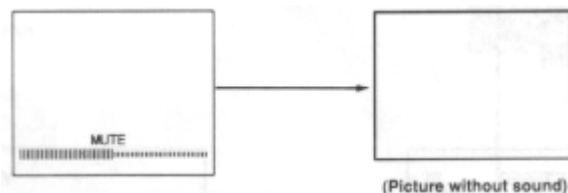

LAST CHANNEL (LST-CH) button

Use this button to select between the last two channels viewed. (Good for watching two sporting events, etc.)

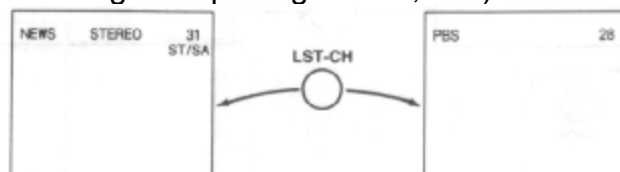

PICTURE-IN-PICTURE buttons

See separate section on page 31 for a description.

-SET UP- FUNCTIONS

Press MENU, 1, and ENTER to display 5 of the -SET UP- Functions. There are a total of 9 -SET UP- Functions.

Use the CURSOR UP or DOWN to scroll through the functions, or use the number buttons to highlight a function. The functions highlighted in purple can be selected by pressing ENTER. To exit the on-screen display, press MENU or RECALL.

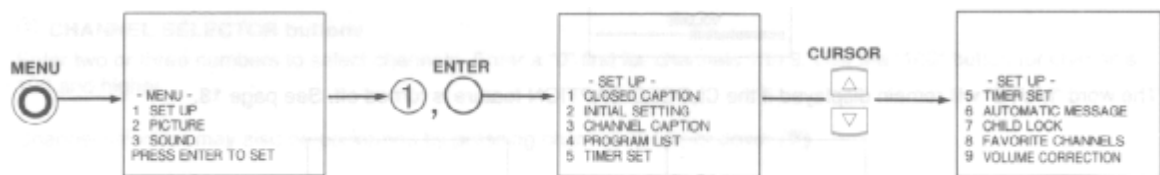

NOTE: To see an autodemonstration of the on-screen display and to practice using the remote control, press and hold the POWER button on the TV set for approximately 5 seconds. Press the POWER button on the TV again to end the autodemonstration.

• CLOSED CAPTION

When CLOSED CAPTION is highlighted in purple, press ENTER to see the following display:

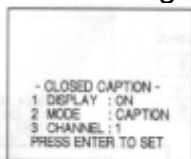

Closed captions are the dialogue, narration, and/or sound effects of a television program or home video which are displayed on the TV screen.

Your local TV program guide denotes these programs as .

DISPLAY: ON/OFF is to turn the  display on or off.

MODE: CAPTION is for the program you are viewing.

MODE: TEXT is for additional information such as news reports or a TV program guide. This information covers the entire screen and viewing the TV program is not possible. TEXT may not be available with every  program.

CHANNEL: 1 is used for the primary language (usually English).

CHANNEL: 2 is sometimes used for a second language (may vary by region).

Use the CURSOR UP or DOWN to highlight the function to change, press ENTER to change the function, and press MENU to exit.

NOTE: The word MUTE will not be displayed if the DISPLAY is ON. If you do not have sound, make sure MUTE is not set.

• INITIAL SETTING

Select **-SET UP-** and **-INITIAL SETTINGS-** when setting your TV up for the first time. Use the **CURSOR UP / DOWN** or a **NUMBER** from the remote to highlight the functions desired.

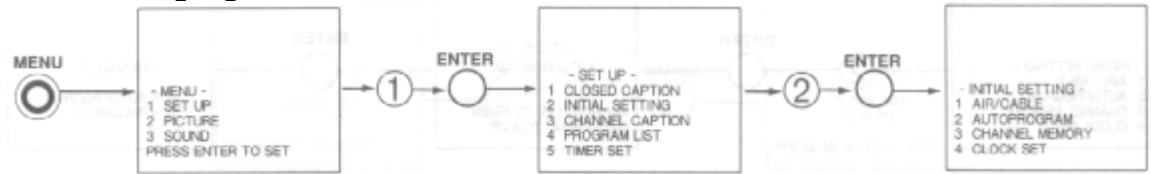

• AIR/CABLE

Select this function to change between regular VHF/UHF broadcasting (AIR) and cable TV (CATV1 or CATV2)

Press the **CURSOR** buttons to highlight the correct **AIR/CABLE** mode and press **MENU** to exit.

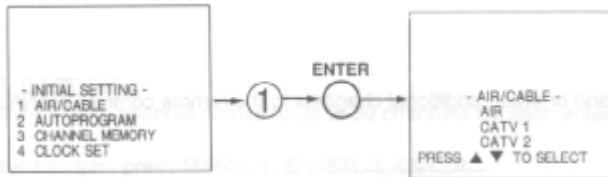

Reception channels for each mode are shown at the right.

Refer to your cable or TV guide for channel identification standards.

If certain CATV channels are poor or not possible in the CATV1 mode, set **-AIR/CABLE-** select to CATV2.

RECEPTION BAND		
AIR	CATV 1 or CATV 2	
	CATV CHANNEL	Indicated on the screen
VHF 2 ~ 13ch UHF 14 ~ 69ch	VHF 2 ~ 13	2 ~ 13
	Mid band A ~ I A-5 ~ A-1	14 ~ 22 95 ~ 99
	Super band J ~ W	23 ~ 36
	Hyper band W + 1 ~ W + 28	37 ~ 64
	Ultra band W + 29 ~ W + 84	65 ~ 125

• AUTOPROGRAM

This feature will automatically store active TV channels in **CHANNEL MEMORY**. This will allow you to skip over unused channels when using the **CHANNEL UP (▲)** or **DOWN (▼)** buttons.

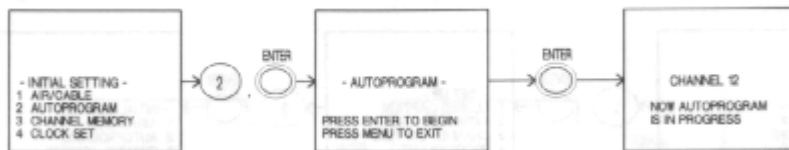

If the **MENU** button is pressed while the autoprogramming function is engaged, programming will stop. See **CHANNEL MEMORY** to add or erase additional channels.

• CHANNEL MEMORY

Use this function after **AUTOPROGRAM** to add or erase additional channels to the remote control **CHANNEL ▲, ▼** buttons.



Add or erase additional channels while still in CHANNEL MEMORY using the CHANNEL ▲, ▼ buttons or number buttons and then add or erase using the CURSOR ◀, ▶ buttons.

• **CLOCK SET**

Use the same remote control buttons as shown in previous examples to display the clock setting, press MENU, 1, ENTER, 2, ENTER, 4, ENTER.



Once the proper time is set (including AM or PM), press MENU to start.

• **CHANNEL CAPTION**

Use this feature to give channel names to up to 30 channels for the antenna source (ABC, PAY1, CMDY, etc.).

To display this function, press MENU, 1, ENTER, 3, ENTER.



Press the CURSOR ▲, ▼ to select letters.

Press the CURSOR ◀, ▶ to change position.

Press ENTER to set the CHANNEL CAPTION and it will appear in the top left corner of the screen.

Press CHANNEL ▲, ▼ or the number buttons to select and label additional channels.

Press MENU to exit.

The (*) represents a blank space.

Select CANCEL to erase a CHANNEL CAPTION.

• **PROGRAM LIST**

This function allows you to view which channels are labeled in CHANNEL CAPTION (NAME), which have been added to CHANNEL MEMORY (SCAN), and which are protected by CHILD LOCK (LOCK). Press MENU, 1, ENTER, 4, ENTER to view.

CH	NAME	SCAN	LOCK
01	----	--	--
02	CBS	ON	--
03	SHOW	ON	ON
04	NBC	ON	--
05	PLBY	--	ON

Press CURSOR ▲, ▼ to view more channels.

Press MENU to EXIT.

• **TIMER SET**

This function will automatically turn the TV on or off.

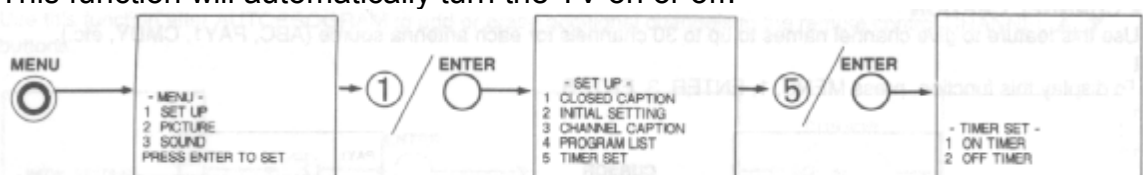

Press 1, ENTER, to select the ON TIMER.



Press the CURSOR ◀, ▶ buttons for TIMER SET: ON or OFF and MODE: 1 SHOT (one time only) or MODE: DAILY (TV will turn on at the same time every day).

Press the number buttons to select the CHANNEL the TV will tune to when the TV automatically turns on.

Press the CURSOR buttons to set the ON TIME.

Press ENTER after each selection. Your choice will appear in "blocked" letters.

Press MENU to start.

Repeat the previous steps to select and set the OFF TIMER.

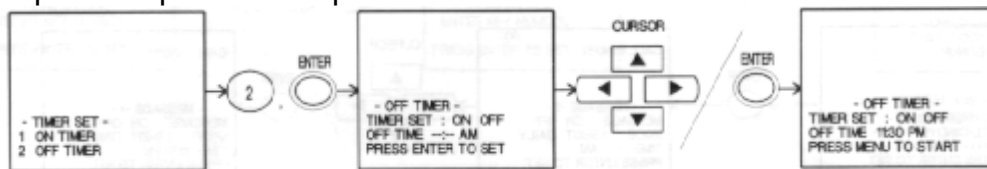

Remember to press ENTER after making selections with the CURSOR buttons.

Press MENU to start.

CAUTION: The OFF TIMER is a one time only operation. Do not try to use your TV as a deterrent when away from home by using both the ON and OFF TIMERS. The OFF TIMER function will not work until you reset it and the next ON TIME (when using the DAILY MODE) will leave the TV set turned on until you press the power button on the TV or remote control to turn it off.

• AUTOMATIC MESSAGE

Use this function to set up to three messages once a day or one time only. Setting the AUTOMATIC MESSAGE is the same as setting CHANNEL CAPTION and ON TIMER. Press MENU, 1, ENTER, 6, ENTER to get the AUTOMATIC MESSAGE display. (You can also use the CURSOR ▲, ▼ to "scroll" to AUTOMATIC MESSAGE and then select the function.)

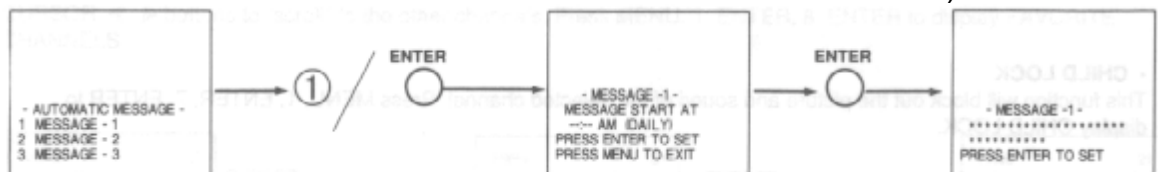

Use the CURSOR ▲, ▼ to select a letter or other character.

Use the CURSOR ◀, ▶ to change position

The asterisk (*) represents a blank space.

When finished with your message press ENTER.

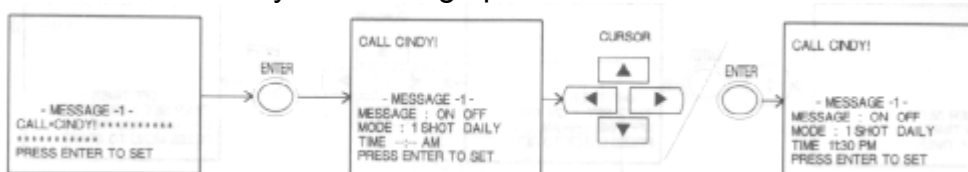

Press the CURSOR and ENTER buttons to set the functions shown in the same way as you set the OFF TIMER.
Press MENU to start.

FIVE beeps will be heard when the AUTOMATIC MESSAGE is displayed.

Examples: Use this message function to remember to take daily vitamins, or use the 1 SHOT to remember to call a friend.

CAUTION: Do not leave an AUTOMATIC MESSAGE on the TV screen for more than 48 hours at a time. A pattern burn may develop and this is not covered by your warranty. The message can be erased from the TV by pressing RECALL, MUTE, LST-CH, etc.

2. CHILD LOCK

This function will block out the picture and sound of the selected channel. Press MENU, 1, ENTER, 7, ENTER to display CHILD LOCK.



The code to set or cancel CHILD LOCK is a three digit key number. The factor preset key number is 000.

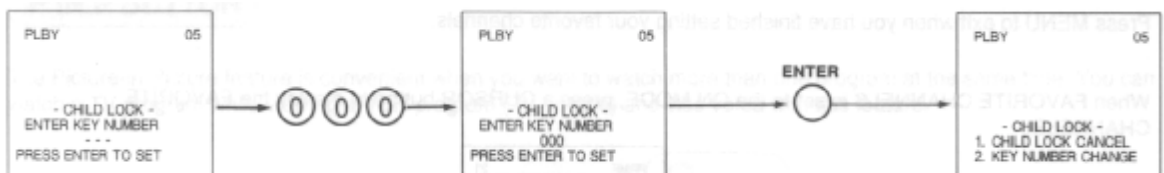

The picture and sound will now be blocked out for this channel. Repeat the same steps to cancel the CHILD LOCK.

To change the key number, select key number change. Enter the old number (factory preset 000 for first time use), then enter a new three digit key number you prefer.

If you forget your key number, use the factory code 777 to erase your key number. This will reset the key number back to the factory preset 000.

• FAVORITE CHANNELS

This function will allow you to select channels using the CURSOR buttons. Up to 5 channels can be preset for each group of favorite channels, for a total of 20 channels. Note that only 12 channels will be shown at a time.

Use the CURSOR ◀, ▶ buttons to "scroll" to the other channels. Press MENU, 1, ENTER, 8, ENTER to display FAVORITE CHANNELS.

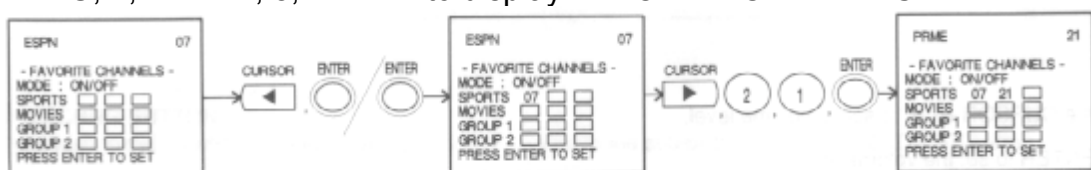

Press the CHANNEL ▲, ▼ or the number buttons to select a channel. Press the CURSOR button to highlight the spot to save the channel. Press ENTER to set the channel to that location.

Press MENU to exit when you have finished setting your favorite channels.

When FAVORITE CHANNELS is set to the ON MODE, press a CURSOR button to display the FAVORITE CHANNELS.



Press the CURSOR buttons to highlight a FAVORITE CHANNEL and the TV will tune to that channel.

NOTE: A channel may be set to more than one FAVORITE CHANNEL location. Set channel 00 to a location to erase a favorite channel.

• **VOLUME CORRECTION**

Use this function to reduce the volume level of up to four TV channels that sound loud compared to other TV channels. Press MENU, 1, ENTER, 9, ENTER, to display VOLUME CORRECTION.

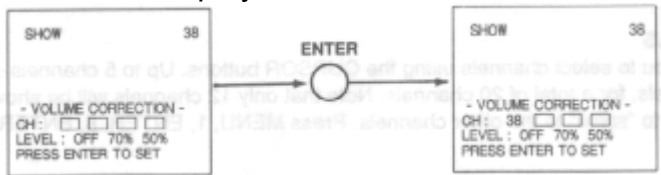

Press the CURSOR ◀, ▶ to select volume level.

Press ENTER to set the volume level.

Press MENU to exit.

PICTURE-IN-PICTURE (P-IN-P) FUNCTIONS

P IN P BUTTON

The Picture-in-Picture feature is convenient when you want to watch more than one program at the same time. You can watch a TV program while viewing a VCR program on the VIDEO:1 or VIDEO:2 source.

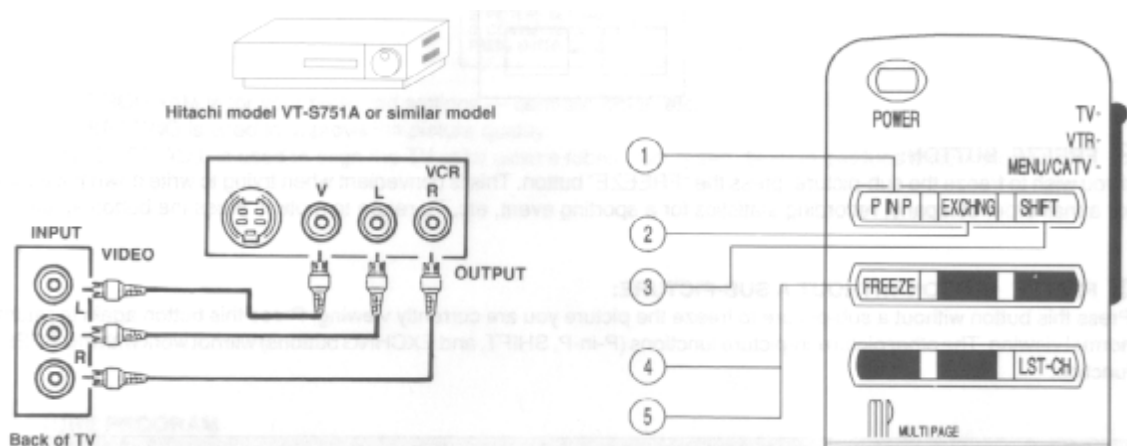

P-IN-P BUTTON

Press the "P in P" button and a sub-picture appears in one corner of the screen. Press the button a second time to reduce the size of the sub-picture. To remove the sub-picture from the screen, press the button a third time. The TV channel will always be either the main picture or the sub-picture.

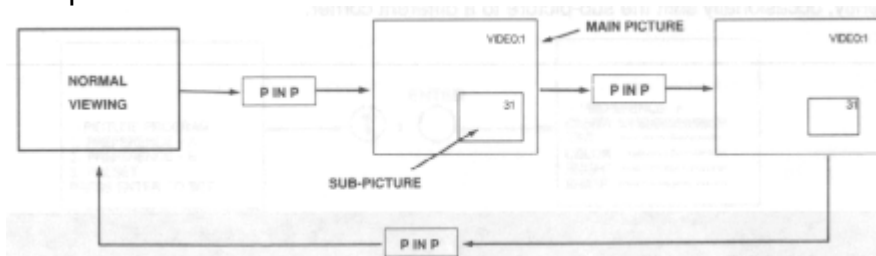

EXCHNG BUTTON

If you wish to switch what is being shown on the main picture to the sub-picture, press the "EXCHNG" button

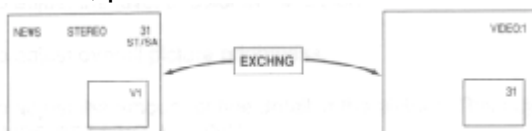

SHIFT BUTTON

To move the sub-picture to another corner, press the "SHIFT" button. The sub-picture moves one step counter-clockwise every time the "SHIFT" button is pressed.

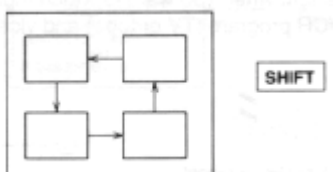

FREEZE BUTTON

If you wish to freeze the sub-picture, press "FREEZE" button. This is convenient when trying to write down the address for a mail order company, recording statistics for a sporting event, etc. To return to motion, press the button again.

FREEZE BUTTON WITHOUT A SUB-PICTURE:

Press this button without a sub-picture to freeze the picture you are currently viewing. Press this button again to return to normal viewing. The other picture-in-picture functions (P-in-P, SHIFT, and EXCHNG buttons) will not work with this FREEZE function.

CAUTION:

A pattern burn may develop if the sub-picture is left in the same corner permanently. If the P-in-P feature is used frequently, occasionally shift the sub-picture to a different corner.

NOTE:

1. Only sound from the main picture can be heard.
2. When the "P-in-P" button is pressed, the sub-picture will appear in the same position as previously set.
3. The "FREEZE" function is released when the "EXCHNG" button is pressed.
4. P-in-P will not work with a CHILD LOCK channel.

-PICTURE- FUNCTIONS

Press MENU, 2, ENTER to display the -PICTURE- functions.

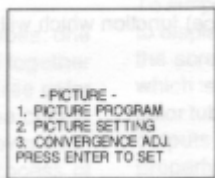

PICTURE PROGRAM is for your preferred settings - contrast, color, etc.
PICTURE SETTING is used to improve the picture quality.
CONVERGENCE ADJ. is used to align the TV color picture tubes (red, green, blue) to produce a clear picture.

• PICTURE PROGRAM

You can have two sets of preferred settings, PREFERENCE-A, PREFERENCE-B or use the factory PRESET settings.

Press MENU, 2, ENTER, 1, ENTER to select the PICTURE PROGRAM.

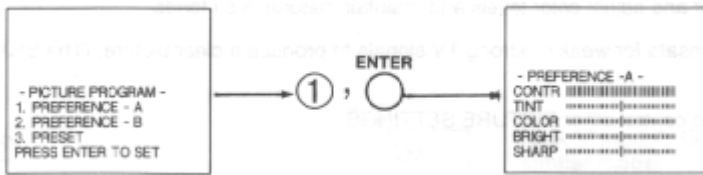

Press the CURSOR buttons to select and make adjustments.

CONTR - Use this function to change the contrast between black and white levels in the picture. This adjustment will only affect the picture when the PICTURE SETTING AI is OFF. See page 34.

TINT - Use this function to adjust flesh tones so they appear natural.

COLOR - Use this function to adjust the level of color in the picture.

BRIGHT - Use this function to adjust overall picture brightness.

SHARP - Use this function to adjust the amount of fine detail in the picture. This adjustment will only affect the picture when PICTURE SETTING AI is OFF.

• PICTURE SETTINGS

Your Hitachi TV has a new AI (Artificial Intelligence) function which will automatically adjust picture settings to produce the highest quality picture possible.

• AI

Press MENU, 2, ENTER, 2, ENTER to display the PICTURE SETTING.

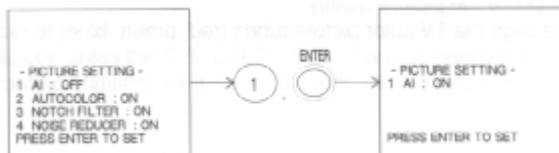

Use the CURSOR ▲, ▼ to select function.

Press ENTER to turn function on or off.

When the AI function is on, the TV internal computer will perform the following:

Automatically monitor and adjust contrast depending on room lighting (sensor is located in the front panel), to produce a more natural picture.

Automatically monitor and adjust color levels and maintain natural flesh tones.

Automatically compensate for weak or strong TV signals to produce a clear picture. (The SHARPNESS function is automatically adjusted.)

Turn the AI function off to control other PICTURE SETTINGS.

• AUTOCOLOR

The AUTOCOLOR function automatically monitors and adjusts the color to maintain constant color levels even after a program or channel changes. It also maintains natural flesh tones while preserving fidelity of background colors. For best picture performance leave the AUTOCOLOR function on.

• NOTCH FILTER

Turn on the NOTCH FILTER when viewing a television program or a program from one of the regular video inputs to improve the picture appearance, especially around the outline of buildings, signs, letters, etc. Turn off the NOTCH FILTER when viewing a program from the S-Video input to get the maximum sharpness and clarity out of the picture.

• NOISE REDUCER

The NOISE REDUCER automatically reduces conspicuous noise in the picture without degrading picture quality.

• CONVERGENCE

Your Projection TV has three color projection tubes: one for red, one for green, one for blue. When mixed together in the proper proportion, the output of these three color tubes can produce any color. To produce these colors, however, the beams must be precisely aligned over each other so that the colors can be mixed. The process of aligning these picture beams is called "convergence".

Over a period of time, the picture tubes can drift out of alignment due to normal bumps and vibrations or moving the TV. If you move your TV, or if, after a time, you notice color rings or halos around objects in the picture, you may want to converge (align) the colors.

To simplify convergence, the following feature allows you to display a test pattern of horizontal and vertical lines on the screen. Properly converged, the lines appear white, which is actually a combination of the outputs of the three color tubes. The output of the green tube is stationary. The outputs of the red and blue tubes can be adjusted. When properly aligned, the outputs of all three tubes should be directly over each other to produce the white lines.

Press MENU, 2, ENTER, 3, ENTER to display the CONVERGENCE ADJUSTMENT.

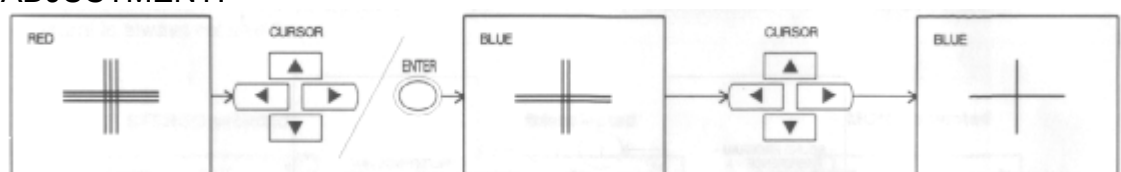

Press the CURSOR ▲, ▼ to move the color displayed up or down.

Press the CURSOR ◀, ▶ to move the color displayed left or right.



Press ENTER to change the color.
Press MENU to exit.

-SOUND- FUNCTIONS

Press MENU, 3, ENTER to display the -SOUND- functions.

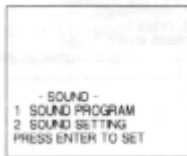

SOUND PROGRAM is for your preferred settings - balance, bass and treble.

SOUND SETTING is used to improve the sound quality.

• SOUND PROGRAM

You can have two sets of preferred settings, PREFERENCE-A, PREFERENCE-B or use the factory PRESET settings.

Press MENU, 3, ENTER, 1, ENTER to select the SOUND PROGRAM.

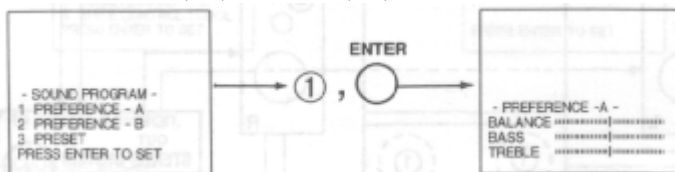

Press the CURSOR buttons to select and make adjustments.

BALANCE - This function will control the left, right balance of the TV internal speakers, the AUDIO TO HI-FI output, and the surround speakers.

BASS - This function controls the low frequency audio to all speakers.

TREBLE - This function controls the high frequency to all speakers.

• SOUND SETTING

Use the sound settings to improve the sound performance of your TV depending on listening conditions.

Press MENU, 3, ENTER, 2, ENTER to display the SOUND SETTING.

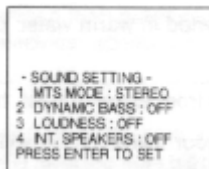

Use the CURSOR ▲, ▼ to select a function.

Press ENTER to set a function or to turn it on or off.

• MTS MODE (Multi-Channel Television Sound)

will allow you to select STEREO (a stereo broadcast), SA (second audio) program which may be a secondary language, weather report, etc. or MONO (monaural sound) used when receiving a weak stereo broadcast. The sources received will be displayed below the channel number. The source you select will be displayed to the left of the channel number. See example below for each selection when both stereo and second audio are received (monaural is always received).

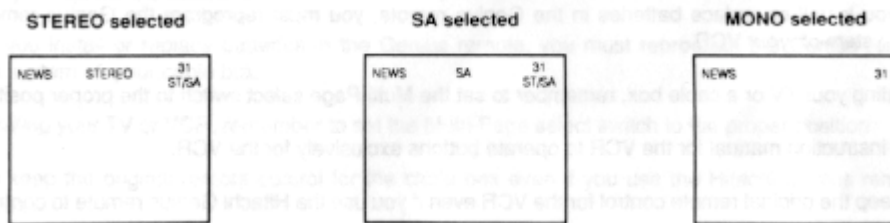

- **DYNAMIC BASS**

This function allows you to enjoy spectacular bass sound that would normally be heard only with expensive home speaker systems.

- **LOUDNESS**

This function will improve the quality of both low and high frequency sounds when listening at low volume levels.

- **INT. SPEAKERS**

This function is useful when first setting up the external speakers, or if you prefer to use only speakers from a separate stereo system.

CARE OF YOUR PROJECTION TV AND REMOTE CONTROLS

DO

- Dust the screen and cabinet with a soft cloth.
- Clean the screen with a soft cloth moistened in warm water. Dry with a soft cloth. (A mild soap may be used if the screen is extremely dirty.)
- Place your TV and remote controls away from extreme heat, humidity and extremely dusty places.
- Remove the plug from the wall outlet if your television set will not be used for a long period of time, for instance, when you go on vacation.

DO NOT

- Do not clean your screen or cabinet with strong cleaners, polishes or chemically treated cloth.
- Do not place rubber or vinyl products or cellophane tape on your set.
- Do not touch the screen too often.
- Do not subject the Remote Control to shocks such as dropping it on the floor, etc. Physical damage to the precision parts may result.
- Avoid placing the Remote Control in a high humidity place or getting it wet. Don't leave it on or near a heater. Excessive heat or moisture may cause the unit to cease operation.



- When the batteries run down, remote control operation will become erratic or possibly stop altogether. Replace the old batteries with two fresh "AA" size batteries for either the Genius remote or the Easy remote.
- Exposure of the viewing screen to prolonged direct sunlight or heat may cause the screen to permanently warp, resulting in a distorted picture.

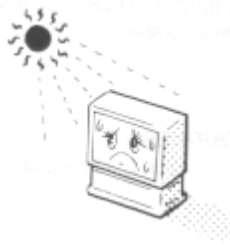

TROUBLESHOOTING

RECEPTION PROBLEMS (EXTERNAL TO THE TV)



- **IGNITION NOISE:**

Black spots or horizontal streaks may appear, picture may flutter or drift. Usually caused by interference from automobile ignition systems, neon lamps, electrical drills and other electrical appliances.



- **GHOSTS:**

Ghosts are caused by the television signal following two paths. One is the direct path and the other is reflected from tall buildings, hills or some other objects. Changing the direction or position of the antenna may improve reception. Ghosting may also be caused by defects in the antenna system such as unshielded leads or connecting several sets to the same antenna without using multiple antenna couplers.



- **SNOW:**

If your receiver is located in the fringe area of a television station where the signal is weak, your picture may be marred by the appearance of small dots. When the signal is extremely weak, it may be necessary to install a special antenna to improve the picture.



- **RADIO FREQUENCY INTERFERENCE:**

The interference produces moving ripples or diagonal streaks, and in some cases, causes loss of contrast in the picture.

CHECK HERE BEFORE CALLING FOR SERVICE

[Click here to see Troubleshooting chart](#)

This Projection Television incorporates advanced power surge protection technology designed to protect against component or circuit damage due

to external or internal voltage or power surges.

IF YOUR SET SHOULD APPEAR TO HAVE A LOSS OF POWER,
PLEASE FOLLOW THIS PROCEDURE:

- 1) Push the power switch (ON/OFF switch) once.
 - 2) If there is still no power, wait 30 seconds and push the power switch again.
 - 3) If there is still no power, unplug the power cord from the wall. Wait thirty seconds and plug the power cord back in. Push the power switch again.
- This protective technology should provide for years of lasting entertainment from your Projection Television.
-

SPECIFICATIONS

Features:

- Super Fine Picture Quality
750 Line Horizontal Resolution
- Artificial Intelligence System
- Genius Remote (Controls many VCR and cable boxes brands)
- Full Function Menu On-Screen Display
- Full Set of Input Jacks, including S-Video
- Closed Caption Decoder

Inputs:

- Power Input AC 120V, 60 Hz

- Power consumption (operating) 153W

- Power consumption (maximum) 220W

- Antenna input impedance 75 \square
- Channel coverage 181 ch.
- VHF-Band 2 ~ 13
- UHF-Band 14 ~ 69
- CATV Mid Band A-5 ~ A-1, A-I
- Super Band J-W
- Hyper Band W+1 - W+28
- Ultra Band W+29 - W+84

- Video 1.0Vp-p, 75 \square

- S-Video
- Luminance (Y) 1.0Vp-p, 75 \square
- Chrominance (C) 0.286Vp-p, 75 \square

- Audio input impedance 47k \square
- Average input level 470mVrms
- Maximum input level 940mVrms

Outputs:

- Video 1.0Vp-p, 75 \square

- Audio (fixed) 470mVrms, 1k \square

Dimensions:

	55EX9K	50EX8K/10B	50EX11BV/12KV
• Height (in.)	55 7/8	50	54 1/2
• Width (in.)	50 1/4	41 1/2	41 1/2
• Depth (in.)	28 1/8	25	28 5/8
• Weight (lbs.)	275	245	390

NOTE: Due to improvements, specifications in this operating guide are subject to change without notice.

HITACHI SERVICE HOTLINE

To locate an authorized HITACHI service facility in the continental U.S.A.

DIAL TOLL FREE

7 days a week, 24 hours a day

800 HITACHI

1-800-448-2244

Hitachi Home Electronics (America), Inc.

Hitachi has made every effort to assure you hours of trouble free operation from your unit. However, should you require service, a network of Hitachi Authorized Service Facilities has been established in all 50 states and Puerto Rico. Each facility will provide you with convenient and expedient assistance. Our service "Hotline" operator will direct you to the Hitachi Authorized Service Facility nearest you. Just present proof of purchase and/or delivery receipts to the Hitachi Authorized Service Facility, and service will be rendered in accordance with the terms of the limited warranty as stated on your warranty card or operating guide.

Should you have any questions regarding in-warranty service, operation or technical assistance, please contact:

Hitachi Home Electronics (America), Inc

3890 Steve Reynolds Blvd

Norcross, GA 30093

Tel: 404-279-5600

Hitachi Sales Corporation of Hawaii

3219 Koapaka St.

Honolulu, HI 96819

Tel: 808-836-3621

Free Manuals Download Website

<http://myh66.com>

<http://usermanuals.us>

<http://www.somanuals.com>

<http://www.4manuals.cc>

<http://www.manual-lib.com>

<http://www.404manual.com>

<http://www.luxmanual.com>

<http://aubethermostatmanual.com>

Golf course search by state

<http://golfingnear.com>

Email search by domain

<http://emailbydomain.com>

Auto manuals search

<http://auto.somanuals.com>

TV manuals search

<http://tv.somanuals.com>