

HITACHI

Projector

HOME-1

User's Manual - Operating Guide

Thank you for purchasing this projector.

WARNING Before using, read the "User's Manual - Safety Guide" and these manuals to ensure correct usage through understanding. After reading, store them in a safe place for future reference.

NOTE • The information in this manual is subject to change without notice.

- The manufacturer assumes no responsibility for any errors that may appear in this manual.
- The reproduction, transmission or use of this document or contents is not permitted without express written authority.

TRADEMARK ACKNOWLEDGMENT :

- VGA and XGA are registered trademarks of the International Business Machines Corporation.
- Apple and Mac are registered trademarks of Apple Computer, Inc.
- VESA and SVGA are trademarks of the Video Electronics Standard Association.
- Windows is a registered trademark of Microsoft Corporation.

All other trademarks are the property of their respective owners.

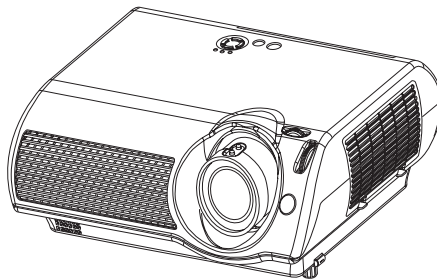

Projector Features

This multimedia projector is used to project various computer signals as well as NTSC / PAL / SECAM video signals onto a screen. Little space is required for installation and large images can easily be realized.

● **Ultra High Brightness**

Crisp, ultra-bright presentations is achieved by using a UHB (ultra high brightness) lamp and a highly efficient optical system.

● **Whisper Mode Equipped**

Special mode is available for reducing projector noise to achieve quieter operation.

● **User Memory Function**

This projector can memorize 4 settings by MY MEMORY function.

● **Optical Lens Shift**

The lens of this projector can be shifted horizontally and vertically. When you want to finely adjust the picture position, use the picture shift dials.

● **Keystone Distortion Correction**

Quick correction of distorted images electrically.

Preparation

Please see the “Contents Of Package” of the “User’s Manual – Quick Guide”. Your projector should come with the items shown there. Contact your dealer anything is missing.

NOTE • Keep the original packing material for future reshipment. For moving the projector, be sure to use the original packing material. Use special caution for the lens part.

Contents

Projector Features	2	Multifunctional Settings	21
Preparation	2	Using The Menu Functions	21
Part Names	4	MAIN Menu	22
The Projector	4	PICTURE-1 Menu	23
Fastening The Lens Cap	4	PICTURE-2 Menu	25
The Remote Control	6	INPUT Menu	26
Setting Up	7	AUTO Menu	28
Arrangement	7	SCREEN Menu	29
Adjusting The Projector's		OPTION Menu	30
Elevator	8	Lamp	31
Using The Picture Shift Dials	8	Replacing The Lamp	32
Connecting Your Devices	9	Air Filter	33
Connecting Power Supply	11	Caring For The Air Filter	33
Remote Control	12	Replacing The Air Filter	34
Putting Batteries	12	Other Care	35
Operating The Remote Control	13	Caring For The Inside	
Power ON/OFF	14	Of The Projector	35
Turning On The Power	14	Caring For The Lens	35
Selecting An Input Signal	15	Caring For The Cabinet	
Turning Off The Power	16	And Remote Control	35
Operating	17	Troubleshooting	36
Adjusting The Volume	17	Related Messages	36
Temporarily Muting The Sound	17	Regarding	
Using The Automatic		The Indicator Lamps	38
Adjustment Feature	18	Phenomena That May Easily Be	
Correcting Keystone		Mistaken For Machine Defects	40
Distortions	18	Warranty And After-Service	41
Signal Searching	19	Specifications	42
Selecting The Aspect Ratio	19		
Temporarily Blanking		TECHNICAL	
The Screen	19		
Selecting The Gamma Mode	20		
Recalling Your Adjustments	20		

Part Names

The Projector

 Indicates the corresponding reference page

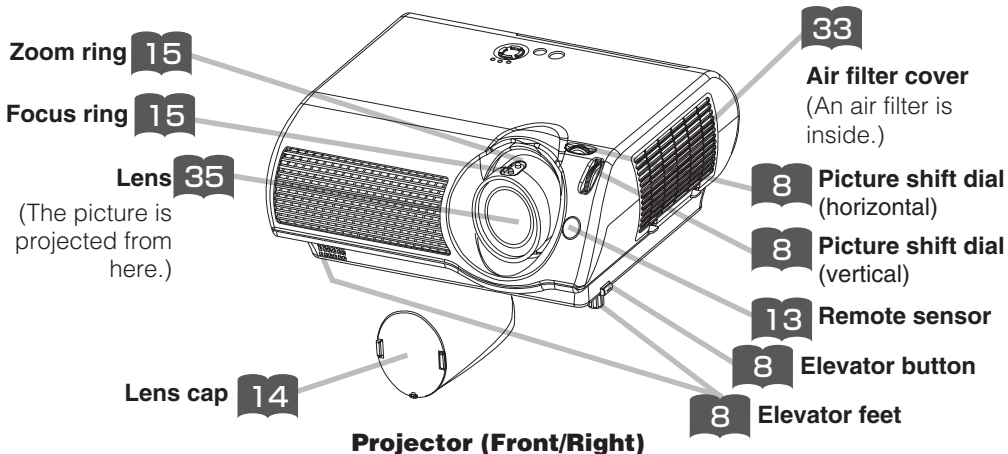

Fastening The Lens Cap

To avoid losing, please fasten the lens cap to the projector using the strap.

- 1 Fix the strap to the strap ring of lens cap, as the right drawing.**

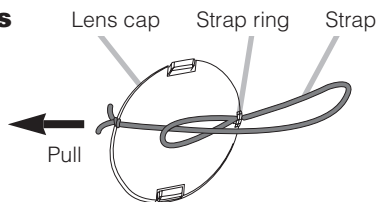

- 2 Put one piece of the strap into the groove on rivet, as the right drawing.**

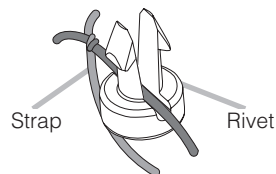

- 3 Push the rivet into the strap hole.**

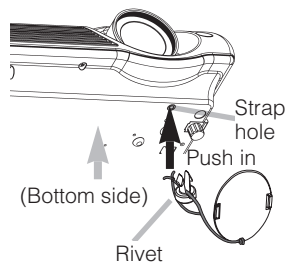

Part Names (continued)

The Projector (continued)

INPUT button 15
toggles between the signal ports.

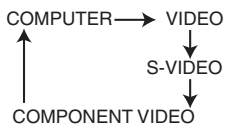

STANDBY/ON button 14
prepares for turning the power on/off. Refer to the section "Power ON/OFF".

14 POWER indicator
tells the state of power supply. Refer to the section "Power ON/OFF".

38 TEMP indicator
lights or blinks when any problem about internal temperature has happened.

38 LAMP indicator
lights or blinks when any problem about the lamp has happened.

21 MENU buttons
operate the menu function.

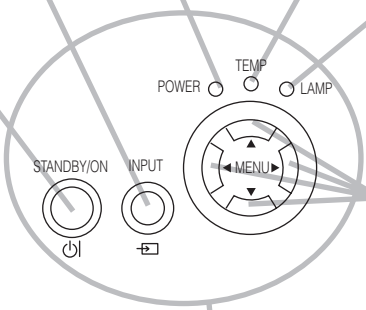

AUDIO R port 10
AUDIO L port 10
(from a video equipment)

AUDIO port 10
(from a computer)

S-VIDEO port 10

VIDEO port 10

Ports cover 10

COMPONENT VIDEO - Y 10

COMPONENT VIDEO - Cb/Pb 10

COMPONENT VIDEO - Cr/Pr 10

11 AC inlet

10 CONTROL port

10 COMPUTER port

14 Power switch

Projector (Rear/Left)

Part Names (continued)

The Remote Control

15 S-VIDEO button

selects the input signal of S-VIDEO port.

19 SEARCH button

searches for an input signal between the following signal ports of COMPUTER, VIDEO, S-VIDEO and COMPONENT VIDEO.

15 VIDEO button

selects the input signal of VIDEO port.

15 COMPUTER button

selects the input signal of COMPUTER port.

19 WIDE button

toggles between the modes for aspect ratio.

18 AUTO button

executes automatic adjustment.

20 CINEMA, DYNAMIC, NORMAL, CUSTOM buttons

select each of gamma mode.

18 KEYSTONE button

turns on/off the KEYSTONE mode.
In the KEYSTONE mode,
To adjust the keystone,
use the cursor (▲/▼) buttons.

21 ESC button

returns to the previous display at the menu functions.

16 OFF button

prepares for turning the power off.

14 ON button

prepares for turning the power on.

15 COMPONENT button

selects the input signal of COMPONENT port.

17 VOLUME button

turns on/off the VOLUME mode.
In the VOLUME mode,
To adjust the volume,
use the cursor (▲/▼) buttons.

19 BLANK button

blanks the screen temporarily.

17 MUTE button

mutes/restores the sound.

20 M1, M2, M3, M4 buttons

call the setting data on each memory.

21 MENU button

opens/closes the menu.

21 RESET button

cancels the adjustment in progress.
* The adjustments of the volume etc. are not reset.

21 ENTER button

proceeds to the next operation at the menu functions.

21 (Cursor) buttons

works for adjusting or menu controlling.



Setting Up

Arrangement

⚠ WARNING • Install the projector in a suitable environment according to instructions of the “User’s Manual – Safety Guide” and this manual.

- The power outlet should be close to the projector and easily accessible.

Refer to the illustrations and tables below to determine the screen size and projection distance.

The values shown in the table are calculated for a full size screen:854×480

(a):Distance from the projector to the screen (±10%)

(b):Distance from the lens center to the top of the screen (±10%)

Reference for the 16:9 aspect ratio

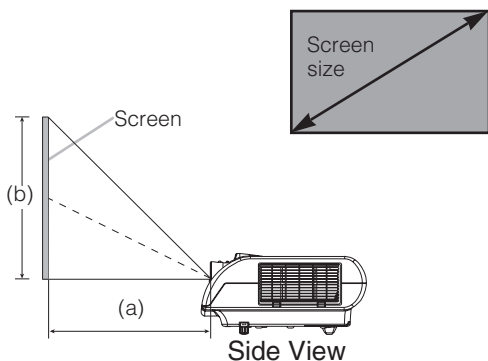

Screen Size [type (m)]	(a) [type (m)]		(b) [type (cm)]
	Min.	Max.	
30 (0.8)	29(0.7)	60(1.5)	15(37)
40 (1.0)	40(1.0)	81(2.1)	20(50)
50 (1.3)	50(1.3)	102(2.6)	25(62)
60 (1.5)	60(1.5)	122(3.1)	29(75)
70 (1.8)	71(1.8)	143(3.6)	34(87)
80 (2.0)	81(2.1)	163(4.2)	39(100)
90 (2.3)	91(2.3)	184(4.7)	44(112)
100 (2.5)	101(2.6)	205(5.2)	49(125)
120 (3.0)	122(3.1)	246(6.2)	59(149)
150 (3.8)	153(3.9)	308(7.8)	74(187)
200 (5.1)	204(5.2)	411(10.4)	98(249)
250 (6.4)	256(6.5)	513(13.0)	123(311)
300 (7.6)	307(7.8)	616(15.7)	147(374)

Reference for the 4:3 aspect ratio

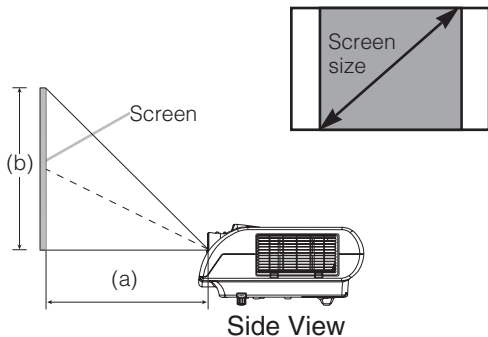

Screen Size [type (m)]	(a) [type (m)]		(b) [type (cm)]
	Min.	Max.	
30 (0.8)	36(0.9)	74(1.9)	18(46)
40 (1.0)	49(1.2)	99(2.5)	24(61)
50 (1.3)	62(1.6)	125(3.2)	30(76)
60 (1.5)	74(1.9)	150(3.8)	36(91)
70 (1.8)	87(2.2)	175(4.4)	42(107)
80 (2.0)	99(2.5)	200(5.1)	48(122)
90 (2.3)	112(2.8)	225(5.7)	54(137)
100 (2.5)	124(3.2)	251(6.4)	60(152)
120 (3.0)	150(3.8)	301(7.6)	72(183)
150 (3.8)	187(4.8)	377(9.6)	90(229)
200 (5.1)	250(6.4)	503(12.8)	120(305)
250 (6.4)	313(8.0)	629(16.0)	150(381)
300 (7.6)	376(9.5)	755(19.2)	180(457)

Setting Up (continued)

Adjusting The Projector's Elevator

⚠ CAUTION • If you press the elevator buttons without holding the projector, the projector might crash down, overturn, smash your fingers and possibly result in malfunction. To prevent damaging the projector and injuring yourself, ALWAYS HOLD THE PROJECTOR whenever using the elevator buttons to adjust the elevator feet.

You can use the elevator feet to make adjustments if the surface on which you need to set the projector is uneven or if you otherwise need to adjust the angle of projection. The adjustment range of the elevator feet is 0 to 9 degrees.

1 Press and hold in the elevator buttons.

2 Raise or lower the projector to the desired height and then release the elevator buttons.

When you release the elevator buttons, the elevator feet will lock into position.

3 As necessary, you can also finely adjust the height of the projector by twisting the elevator feet by hand.

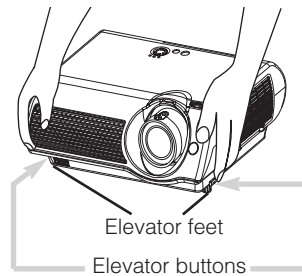

Using The Picture Shift Dials

The lens of this projector can be shifted horizontally and vertically. When you want to finely adjust the picture position, use the picture shift dials.

- ① Using the horizontal picture shift dial shifts the picture to right or left.
- ② Using the vertical picture shift dial shifts the picture upward or downward.

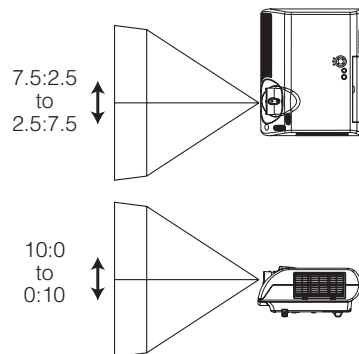
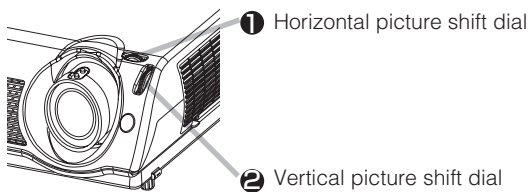

NOTE • Generally, better quality of a picture is available when the lens shift is set to the center.

- Do not attach anything other than specified options (such as an optional conversion lens) to the screw thread. For details, please ask your dealer.

Setting Up (continued)

Connecting Your Devices

⚠ WARNING • Incorrect connecting could result in fire or electrical shock. Whenever attempting to connect other devices to the projector, please thoroughly read the "User's Manual - Safety Guide", this manual and the manual of each device to be connected.

⚠ CAUTION • TURN OFF ALL DEVICES prior to connecting them to the projector. Attempting to connect a live device to the projector may generate extremely loud noises or other abnormalities that may result in malfunction and/or damage to the device and/or projector.

ATTENTION • Make sure that you connect devices to the correct port. Incorrect connection may result in malfunction and/or damage to the device and/or projector. Refer to the section "TECHNICAL" of this manual for the pin assignment of connectors and RS-232C communication data.

- Some cables have to be used with core set. Use the accessory cable or a designated-type cable for the connection. For cables that have a core only at one end, connect the core to the projector.
- Secure the screws on the connectors and tighten.
- Whenever attempting to connect a laptop computer to the projector, be sure to activate the laptop's RGB external image output (set the laptop to CRT display or to simultaneous LCD and CRT display). For details on how this is done, please refer to the instruction manual of the corresponding laptop computer.

NOTE About Plug-and-Play Capability

- This projector is compatible with VESA DDC 1/2B. Plug-and-Play can be achieved by connecting this projector to computers that are VESA DDC (display data channel) compatible. Please take advantage of this function by connecting the accessory RGB cable to the COMPUTER port (DDC 1/2B compatible). Plug-and-Play may not work properly if any other type of connection is attempted.
- Plug-and-Play is a system composed of the computer, its operating system and peripheral equipment (i.e. display devices).
- Please use the standard drivers in your computer as this projector is a Plug-and-Play monitor.

NOTE • Some computers may have multiple display screen modes. Use of some of these modes will not be possible with this projector.

- For some COMPUTER input modes, the optional Mac adapter is necessary.
- When the image resolution is changed on a computer, depending on an input, automatic adjust function may take some time and may not be completed. In this case, you may not be able to see a check box to select "Yes/No" for the new resolution on Windows. Then the resolution will go back to the original. It might be recommended to use other CRT or TFT monitors to change the resolution.

Setting Up (continued)

Please refer to the following for connecting your devices.
See the rear of the projector and open the ports cover.
You can see the ports.

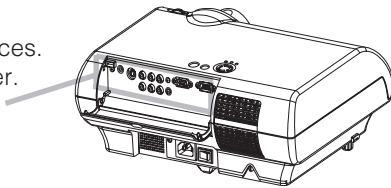

Connecting to a computer

- RGB out ← RGB cable (D-sub 15 pin) → ①
- Audio out ← Audio cable (Stereo mini) → ②
- RS-232C port ← RS-232C cable → ③

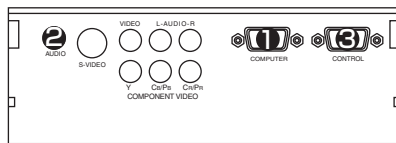

Connecting to a DVD/VCR player

- Video out ← Audio/Video cable → ④
- Audio out (L) ← Audio/Video cable → ⑤
- Audio out (R) ← Audio/Video cable → ⑥

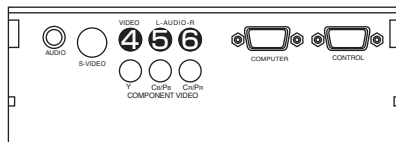

If using a SCART RGB input,

- Video → SCART out port ← SCART cable → ④
- AUDIO-L → SCART out port ← SCART cable → ⑤
- AUDIO-R → SCART out port ← SCART cable → ⑥
- G → SCART out port ← SCART cable → ⑦
- B → SCART out port ← SCART cable → ⑧
- R → SCART out port ← SCART cable → ⑨

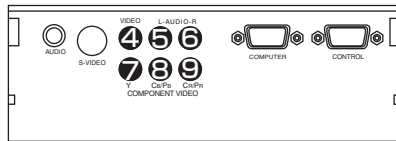

If using a S-video input,

- S-video out port ← S-video cable → ⑩
- Audio out (L) ← Audio cable → ⑤
- Audio out (R) ← Audio cable → ⑥

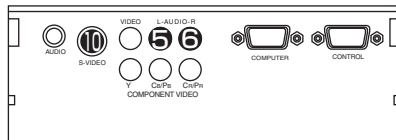

If using a component input,

- Component (Y) out ← Component cable → ⑦
- Component (Cb/Pb) out ← Component cable → ⑧
- Component (Cr/Pr) out ← Component cable → ⑨
- Audio out (L) ← Audio cable → ⑤
- Audio out (R) ← Audio cable → ⑥

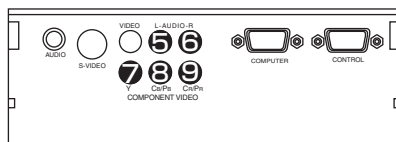

If using a component input from COMPUTER port,

- Component (Y) out ← Component cable → ①
- Component (Cb/Pb) out ← Component cable (with D-sub 15 pin) → ①
- Component (Cr/Pr) out ← Component cable (with D-sub 15 pin) → ①
- Audio out ← Audio cable (Stereo mini) → ②

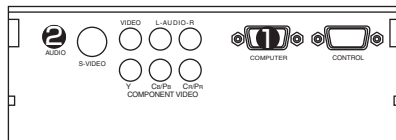

Setting Up (continued)

Connecting Power Supply

⚠ WARNING • Please use extra caution when connecting the power cord as incorrect or faulty connections may result in FIRE and/or ELECTRICAL SHOCK. Please adhere to the “User’s manual – Safety Guide” and the following.

- Only plug the power cord into outlets rated for use with the power cord’s specified voltage range.
- Only use the power cord that came with the projector. If it is damaged, contact your dealer to newly get correct one.
- Never modify the power cord. Never attempt to defeat the ground connection of the three-pronged plug.
- Make sure that you firmly connect the power cord to the projector and wall outlet.

1 **Connect the connector of the power cord to the AC inlet of the projector. ①**

2 **Firmly plug the power cord’s plug into the outlet.**

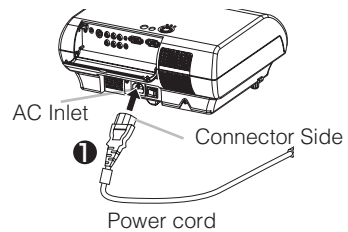

Remote Control

Putting Batteries

⚠ CAUTION Always handle the batteries with care and use them only as directed. Improper use may result in battery cracking or leakage, which could result in fire, injury and/or pollution of the surrounding environment.

- Keep the battery away from children and pets.
- Be sure to use only the batteries specified for use with the remote control. Do not mix new batteries with used ones.
- When inserting batteries, verify that the plus and minus terminals are aligned correctly (as indicated in the remote control).
- When you dispose the battery, you should obey the law in the relative area or country.

1 Remove the battery cover.

Slide back and remove the battery cover in the direction of the arrow.

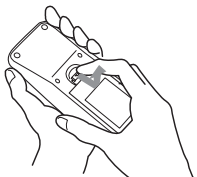

2 Insert the batteries.

Align and insert the two AA batteries according to their plus and minus terminals (as indicated in the remote control).

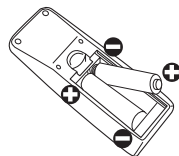

3 Close the battery cover.

Replace the battery cover in the direction of the arrow and snap it back into place.

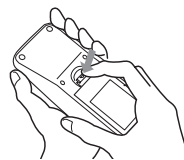

Remote Control (continued)

Operating The Remote Control

ATTENTION • Do not drop or otherwise expose the remote control to physical impact.

- Do not get the remote control wet or place it on wet objects. Doing so may result in malfunction.
- Remove the batteries from the remote control and store them in a safe place if you won't be using the remote control for an extended period.
- Replace the batteries whenever the remote control starts to malfunction.
- When strong lights, such as direct sunlight or light from an extremely close range (such as from an inverter fluorescent lamp), hit the projector's remote sensor, the remote control may cause to function. Adjust the direction of the projector to keep light from directly hitting the projector's remote sensor.

- The remote control works with the projector's remote sensor.
- The range of the remote sensor is 3 meters with a 60-degree range (30 degrees to the left and right of the remote sensor).
Also a remote signal reflected in the screen etc. may be available. If it is difficult to send a remote signal to the sensor directly, please try.
- Since the remote control uses infrared light to send signals to the projector (Class1 LED), be sure to use the remote control in an area free from obstacles that could block the remote control's output signal to the projector.

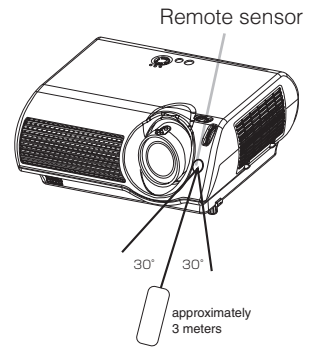

Power ON/OFF

Turning On The Power

⚠ WARNING • When the power is ON, a strong light is emitted. Do not look into the lens or vents of the projector.

NOTE • Turn the power on/off in right order. Please power on the projector before the connected devices. Power off the projector after the connected devices.

1 Make sure that the power cord is firmly and correctly connected to the projector and outlet.

2 When the lens cap is attached, remove the lens cap.

3 Set the power switch to [I] (ON).



Power switch (ON position)

The POWER indicator will light orange.

4 Press the STANDBY/ON button of the projector or the ON button of the remote control.

The projector lamp will light up and the POWER indicator will begin blinking green.

According to a setup, the projector lamp may light up and the POWER indicator may begin blinking green, without pressing this button.

When the power is completely on, the indicator will stop blinking and light green.

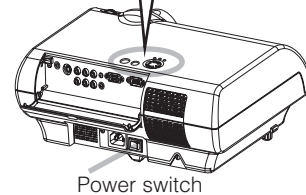
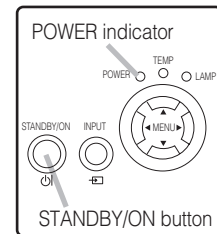

Power switch

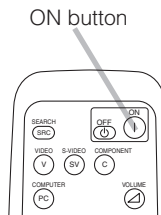

ON button

Power ON/OFF (continued)

Selecting An Input Signal

1 Using the projector's control button

Press the **INPUT** button.

As illustrated below, each time you press the INPUT button, the projector switches between its input signal ports. Select the signal you wish to project.



Using the remote control

Press the **COMPUTER**, **VIDEO**, **S-VIDEO** or **COMPONENT** button according to an input to choose.

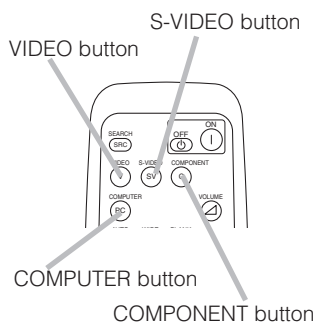
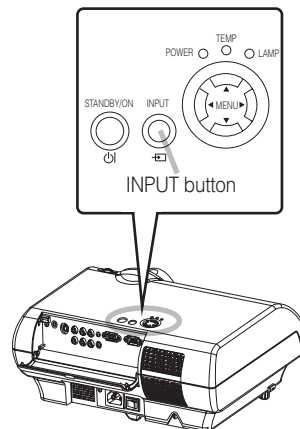

2 Use the zoom ring to adjust the screen size.

3 Use the focus ring to focus the picture.

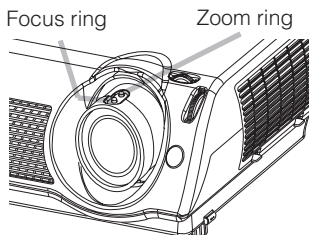

Power ON/OFF (continued)

Turning Off The Power

NOTE • Turn the power on/off in right order. Please power on the projector before the connected devices. Power off the projector after the connected devices.

1 Press the **STANDBY/ON** button of the projector or the **OFF** button of the remote control.

The message “Power off?” will appear on the screen for approximately 5 seconds.

2 Press the **STANDBY/ON** button or the **OFF** button again while “Power off?” the message is visible.

The projector lamp will go off, and the POWER indicator will begin blinking orange.

Then the POWER indicator will stop blinking and light to solid orange when the lamp cooling is complete.

3 Switch the power switch to [O] (OFF).



Power switch (OFF position)

The POWER indicator will go off.

4 Attached the lens cap.

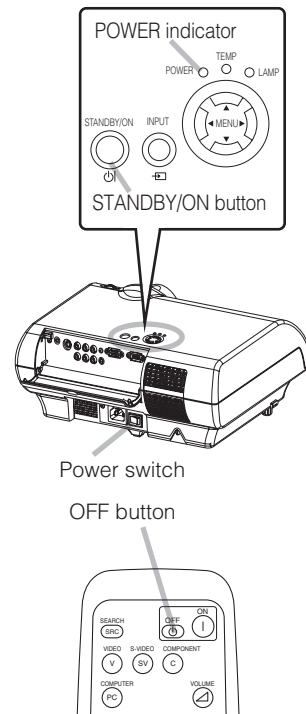

Operating

Adjusting The Volume

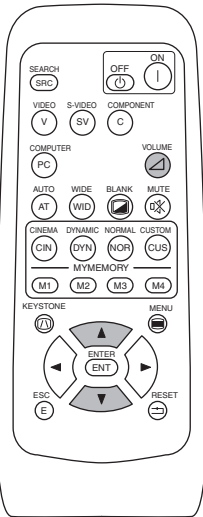

1 Press the **VOLUME** button.

As illustrated on the right, a dialog will appear on the screen to aid you in adjusting the volume.

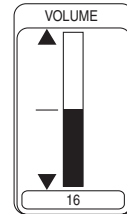

2 Use the **▲/▼** buttons to adjust the volume.

Press the VOLUME button again to close the dialog and complete this operation. (Even if you don't do anything, the dialog will automatically disappear after a few seconds.)

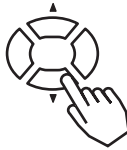

- ▲ Press this to increase the volume
- ▼ Press this to decrease the volume

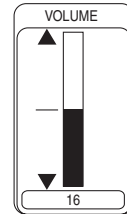

Temporarily Muting The Sound

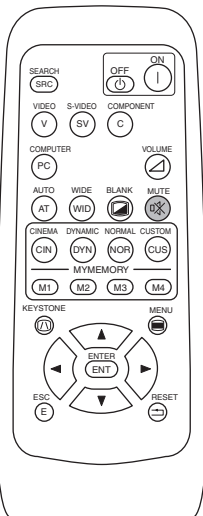

1 Press the **MUTE** button.

Press the MUTE button.

As illustrated on the right, a dialog will appear on the screen indicating that you have muted the sound.

(If you don't do anything, the dialog will automatically disappear after a few seconds.)

Press the MUTE or VOLUME button again to restore the sound.

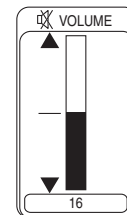

Operating (continued)

Using The Automatic Adjustment Feature



1 Press the **AUTO** button.



Automatic Adjustment for RGB Input

Horizontal position (H POSITION), vertical position (V POSITION), clock phase (H PHASE) and horizontal size (H SIZE) are automatically adjusted.

Make sure that the application window is set to its maximum size prior to attempting to use this feature. Dark pictures may still be incorrectly adjusted. Use a bright screen when adjusting.

Automatic Adjustment for Video Input

The signal type best suited for the respective input signal is selected automatically.

This feature is available only if VIDEO is set to AUTO in the INPUT menu.

NOTE • The automatic adjustment operation requires approximately 10 seconds. Also, please note that it may not function correctly with some input.

Correcting Keystone Distortions

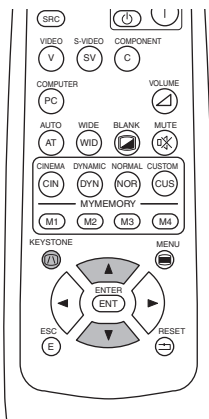

1 Press the **KEYSTONE** button.

As illustrated on the right, a dialog will appear on the screen to aid you in correcting the distortion.

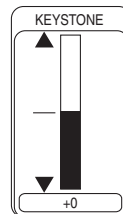

2 Use the **▲**, **▼** buttons to correct distortion.

Press the KEYSTONE button again to close the dialog and complete this operation. (Even if you don't do anything, the dialog will automatically disappear after a few seconds.)



NOTE • When the WIDE is selected under the ASPECT item of the MAIN menu, this adjustment is ignored.

- The correcting keystone distortions function may not work well with some types of input signals.
- The adjustable range for correcting keystone distortions will vary with the type of input signal.

Operating (continued)

Signal Searching

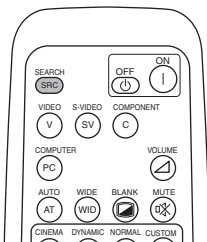

1

Press the SEARCH button.

Cycle through input signals, displaying the images of retrieved signals. If no signal is found, returns to the signal that was selected before the search was begun.

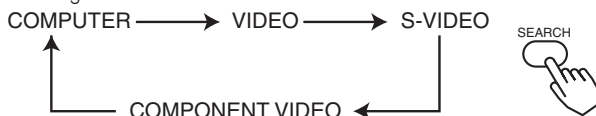

- NOTE**
- May not function properly with some input signals.
 - The signal searching function takes about 10 seconds to display an image.

Selecting The Aspect Ratio

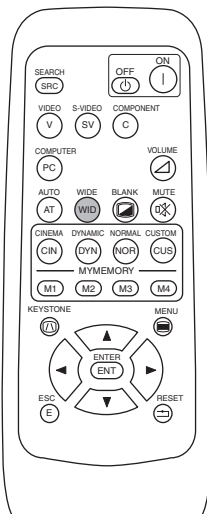

1

Press the WIDE button.

COMPUTER input

4:3 → 16:9 → 15:9 → 32:15

- At a COMPUTER input, selecting an aspect ratio may display the message "SYNC IS OUT OF RANGE". In this case, please select one of other aspect ratios.

VIDEO, S-VIDEO, COMPONENT VIDEO input

4:3 → 16:9 → WIDE → MOVIE-1 → MOVIE-2

- At a COMPONENT VIDEO input of 16:9 Hi-Vision of 1125i (1035i/1080i)/750p, only 16:9 can be selected.

Temporarily Blanking The Screen

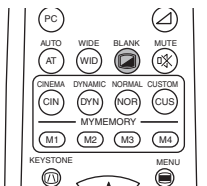

1

Press the BLANK button.

The input signal screen is shut off, and a blank screen appears. You can set the blank screen using the menu (from the SCREEN menu, select BLANK).

Press the BLANK button again to remove the blank screen, and return to the input signal screen.

- NOTE**
- The temporarily blanking function will automatically finish if a button of the remote control except the , , , , ENTER, ESC, RESET or ON button is pressed, or if a button of projector is pressed, or if there is a change in the input signal's state.

Operating (continued)

Selecting The Gamma Mode

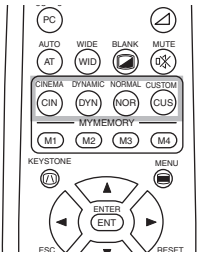

- 1 Press the **CINEMA, DYNAMIC, NORMAL or CUSTOM** button according to a mode to choose.

This projector has the 4 modes called the CINEMA, DYNAMIC, NORMAL and CUSTOM.

Recalling Your Adjustments



- 1 Press the **M1, M2, M3 or M4** button to recall a setting.

This projector can memorize 4 settings by the MY MEMORY function of the PICTURE-1 menu.

Pressing the M1, M2, M3 or M4 button calls the setting of the memory whose number corresponds, if it is memorized. It is the same function as selecting the LOAD1, LOAD2, LOAD3 or LOAD4 under the MY MEMORY item of the PICTURE-1 menu. Please refer to the description of MY MEMORY item of the section "PICTURE-1 Menu".

Multifunctional Settings

Using The Menu Functions

This projector has the following menus: MAIN, PICTURE-1, PICTURE-2, INPUT, AUTO, SCREEN, OPTION. Each of these menus is operated using the same methods. The basic operations of these menus are as follows.

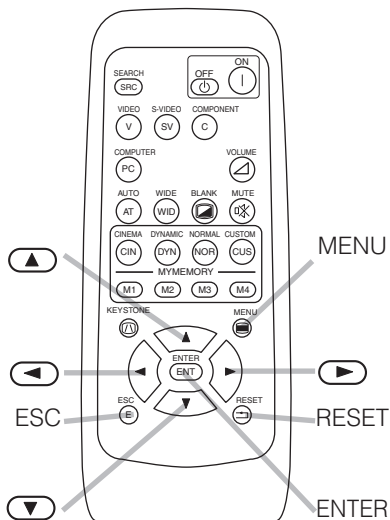

1 Press the **MENU** button.

The menu display appears on the screen.

[ex. Adjusting VOLUME]

1. Press the MENU button.

2 Use the **▲/▼** buttons to select a menu, then press the **▶** or **ENTER** button.

The display of the selected menu appears.

2. Use the **▲/▼** buttons to select the OPTION, then press the **▶** or ENTER button.

3 Use the **▲/▼** buttons to select an item, then press the **▶** or **ENTER** button.

The operation display of the selected item appears.

3. Use the **▲/▼** buttons to select the VOLUME, then press the **▶** or ENTER button.

4 Use the **▲/▼** buttons to operate the item.

When you want to reset the adjustment, press the RESET button during the operation. Note that the items whose functions are performed simultaneously with operating (ex. LANGUAGE, WHISPER, H PHASE etc.) are not reset. When you want to return to the previous display, press the **◀** or ESC button.

4. Use the **▲/▼** buttons to adjust the VOLUME.

5 Press the **MENU** button, or do not perform any operation for several seconds.

The menu display disappears and your operation finishes.

5. Press the MENU button.

Multifunctional Settings (continued)

MAIN Menu

With the MAIN menu, the items shown in the table below can be performed.
Perform each operation in accordance with the instructions in the table below.

MENU		▲
MAIN	KEYSTONE	+0
PICTURE-1	BRIGHT	+0
PICTURE-2	CONTRAST	+0
INPUT	ASPECT	4:3
AUTO	WHISPER	NORMAL
SCREEN	MIRROR	NORMAL
OPTION	LANGUAGE	ENGLISH
	[Language]	
◀ SELECT ▶		▼

Item	Description
KEYSTONE	<p>Adjust the Keystone (Vertical) Distortion: Upper in the data $\blacktriangleleft \leftrightarrow \blacktriangleright$ Lower in the data</p> <ul style="list-style-type: none"> • The adjustable range of this function will vary with the type of input signal. At some signals, this function may not work well. • When the V:INVERT or the H&V:INVERT is selected under the MIRROR item, if the projector screen is inclined or if the projector is angled downward, this function may not work correctly. • When the WIDE is selected under the ASPECT item of the MAIN menu, this adjustment is ignored. • When the zoom adjustment is set to the TELE side, this correction may be excessive. This function should be used with zoom set to WIDE whenever possible.
BRIGHT	Adjust Brightness: Light $\blacktriangleleft \leftrightarrow \blacktriangleright$ Dark
CONTRAST	Adjust Contrast: Strong $\blacktriangleleft \leftrightarrow \blacktriangleright$ Weak
ASPECT	<p>Select an Aspect Ratio At a COMPUTER input: 4:3 $\blacktriangleleft \leftrightarrow \blacktriangleright$ 16:9 $\blacktriangleleft \leftrightarrow \blacktriangleright$ 15:9 $\blacktriangleleft \leftrightarrow \blacktriangleright$ 32:15</p> <ul style="list-style-type: none"> • At a COMPUTER input, selecting an aspect ratio may display the message "SYNC IS OUT OF RANGE". In this case, please select one of other aspect ratios. <p>At a VIDEO input, a S-VIDEO input or a COMPONENT VIDEO input: 4:3 $\blacktriangleleft \leftrightarrow \blacktriangleright$ 16:9 $\blacktriangleleft \leftrightarrow \blacktriangleright$ WIDE $\blacktriangleleft \leftrightarrow \blacktriangleright$ MOVIE-1 $\blacktriangleleft \leftrightarrow \blacktriangleright$ MOVIE-2</p> <ul style="list-style-type: none"> • At a COMPONENT VIDEO input of 16:9 Hi-Vision of 1125i(1035i/1080i)/750p, only 16:9 can be selected.
WHISPER	<p>Select the Whisper Mode: NORMAL $\blacktriangleleft \leftrightarrow \blacktriangleright$ WHISPER</p> <ul style="list-style-type: none"> • When the WHISPER is selected, acoustic noise and screen brightness are reduced.
MIRROR	<p>Select a Mirror Status: NORMAL $\blacktriangleleft \leftrightarrow \blacktriangleright$ H:INVERT $\blacktriangleleft \leftrightarrow \blacktriangleright$ V:INVERT $\blacktriangleleft \leftrightarrow \blacktriangleright$ H&V:INVERT</p>
LANGUAGE	<p>Select a Menu Language: ENGLISH $\blacktriangleleft \leftrightarrow \blacktriangleright$ FRANÇAIS $\blacktriangleleft \leftrightarrow \blacktriangleright$ DEUTSCH $\blacktriangleleft \leftrightarrow \blacktriangleright$ ESPAÑOL $\blacktriangleleft \leftrightarrow \blacktriangleright$ \Rightarrow ITALIANO $\blacktriangleleft \leftrightarrow \blacktriangleright$ NORSK $\blacktriangleleft \leftrightarrow \blacktriangleright$ NEDERLANDS $\blacktriangleleft \leftrightarrow \blacktriangleright$ \Rightarrow 日本語 $\blacktriangleleft \leftrightarrow \blacktriangleright$ PORTUGUÊS $\blacktriangleleft \leftrightarrow \blacktriangleright$ 中文 $\blacktriangleleft \leftrightarrow \blacktriangleright$ 한글 $\blacktriangleleft \leftrightarrow \blacktriangleright$ \Rightarrow SVENSKA $\blacktriangleleft \leftrightarrow \blacktriangleright$ РУССКИЙ $\blacktriangleleft \leftrightarrow \blacktriangleright$ SUOMI $\blacktriangleleft \leftrightarrow \blacktriangleright$ POLSKI</p>
RESET	<p>Reset the MAIN Menu Items: Selecting the EXECUTE performs this function. EXECUTE $\blacktriangleleft \leftrightarrow \blacktriangleright$ CANCEL</p> <ul style="list-style-type: none"> • The items of the MAIN menu are collectively returned to the initial setting. Note that the items WHISPER and LANGUAGE are not reset.

Multifunctional Settings (continued)

PICTURE - 1 Menu

















With the PICTURE-1 menu, the items shown in the table below can be performed.
Perform each operation in accordance with the instructions in the table below.

MENU		
MAIN	GAMMA	NORMAL
PICTURE-1	COLOR BAL R	+0
PICTURE-2	COLOR BAL G	+0
INPUT	COLOR BAL B	+0
AUTO	SHARPNESS	+0
SCREEN	COLOR	+0
OPTION	TINT	+0
	MY MEMORY	SAVE1
SELECT		

Item	Description
GAMMA	<p>Select a Gamma Mode: NORMAL \blacktriangle \Leftrightarrow \blacktriangledown CINEMA \blacktriangle \Leftrightarrow \blacktriangledown DYNAMIC \blacktriangle \Leftrightarrow \blacktriangledown CUSTOM</p> <ul style="list-style-type: none"> • Selecting the CUSTOM and then pressing the \blacktriangleright or the ENTER button calls the CUSTOM menu. <p>CUSTOM Menu Selecting one from the following and then pressing the \blacktriangleright or the ENTER button performs each function.</p> <p>GAMMA \blacktriangle \Leftrightarrow \blacktriangledown COLOR TEMP \blacktriangle \Leftrightarrow \blacktriangledown R \blacktriangle \Leftrightarrow \blacktriangledown G \blacktriangle \Leftrightarrow \blacktriangledown B</p> <ul style="list-style-type: none"> • The R, G and B can be selected only when the USER is selected under the COLOR TEMP.
	<p>CUSTOM GAMMA</p> <p>Adjust the Gamma Data: Up \blacktriangle \Leftrightarrow \blacktriangledown Down</p>
	<p>CUSTOM COLOR TEMP</p> <p>Select a Color Temperature Mode: HIGH \blacktriangle \Leftrightarrow \blacktriangledown MIDDLE \blacktriangle \Leftrightarrow \blacktriangledown LOW \blacktriangle \Leftrightarrow \blacktriangledown USER</p>
	<p>CUSTOM R</p> <p>Adjust the Red Color Level for the USER mode of the COLOR TEMP: Strong \blacktriangle \Leftrightarrow \blacktriangledown Weak</p>
	<p>CUSTOM G</p> <p>Adjust the Green Color Level for the USER mode of the COLOR TEMP: Strong \blacktriangle \Leftrightarrow \blacktriangledown Weak</p>
	<p>CUSTOM B</p> <p>Adjust the Blue Color Level for the USER mode of the COLOR TEMP: Strong \blacktriangle \Leftrightarrow \blacktriangledown Weak</p>
COLOR BAL R	Adjust the Red Color Balance: Strong \blacktriangle \Leftrightarrow \blacktriangledown Weak
COLOR BAL G	Adjust the Green Color Balance: Strong \blacktriangle \Leftrightarrow \blacktriangledown Weak
COLOR BAL B	Adjust the Blue Color Balance: Strong \blacktriangle \Leftrightarrow \blacktriangledown Weak
SHARPNESS	<p>Adjust the Whole Sharpness: Clear \blacktriangle \Leftrightarrow \blacktriangledown Soft</p> <ul style="list-style-type: none"> • This is a function for video inputs. This item can't be selected only at COMPUTER inputs.
COLOR	<p>Adjust COLOR : Strong \blacktriangle \Leftrightarrow \blacktriangledown Weak</p> <ul style="list-style-type: none"> • This is a function for video inputs. This item can't be selected only at COMPUTER inputs including SCART RGB inputs. • It is unavailable to deepen colors on SECAM signal input. (The adjustment bar position and value in menu box are changeable but no effect.)
TINT	<p>Adjust the Tint: Green \blacktriangle \Leftrightarrow \blacktriangledown Red</p> <ul style="list-style-type: none"> • This is a function for video inputs. This item can't be selected only at COMPUTER inputs including SCART RGB inputs.

Multifunctional Settings (continued)

PICTURE - 1 Menu (continued)

Item	Description
MY MEMORY	<p>Load/Save a Setting: Selecting one from the following and then pressing the  or the ENTER button performs each function. LOAD1  ⇔  LOAD2  ⇔  LOAD3  ⇔  LOAD4  ⇔  ⇒  SAVE1  ⇔  SAVE2  ⇔  SAVE3  ⇔  SAVE4</p> <ul style="list-style-type: none"> • This projector has 4 memories called M1, M2, M3 and M4 for settings. Performing the SAVE1, SAVE2, SAVE3 or SAVE4 puts the current setting data on the memory whose number corresponds. Performing the LOAD1, LOAD2, LOAD3 or LOAD4 calls the data of memory whose number corresponds, and adjusts the picture automatically depending on the data. • The LOAD1, LOAD2, LOAD3 or LOAD4 cannot be selected when there is no memory whose number corresponds. • At a different signal input from the signal that was being inputted when the setting was memorized, the picture may not be adjusted correctly.
RESET	<p>Reset the PICTURE-1 Menu Items: Selecting the EXECUTE performs this function. EXECUTE  ⇔ CANCEL</p> <ul style="list-style-type: none"> • The items of the PICTURE-1 menu are collectively returned to the initial setting. Note that the items MY MEMORY and CUSTOM - GAMMA are not reset.











Multifunctional Settings (continued)

PICTURE - 2 Menu

With the PICTURE-2 menu, the items shown in the table below can be performed.

Perform each operation in accordance with the instructions in the table below.

MENU	
MAIN	V POSITION 20
PICTURE-1	H POSITION 142
PICTURE-2	H PHASE 31
INPUT	H SIZE 1344
AUTO	OVER SCAN 95
SCREEN	RESET
OPTION	
[C]: SELECT	

Item	Description
V POSITION	<p>Adjust the Vertical Position: Up  ⇄  Down</p> <ul style="list-style-type: none"> This item can be selected only at a COMPUTER input.
H POSITION	<p>Adjust the Horizontal Position: Left  ⇄  Right</p> <ul style="list-style-type: none"> This item can be selected only at a COMPUTER input.
H PHASE	<p>Adjust the Horizontal Phase (to eliminate flicker) : Right  ⇄  Left</p> <ul style="list-style-type: none"> This item can be selected only at a COMPUTER input or a COMPONENT VIDEO input.
H SIZE	<p>Adjust the Horizontal Size: Large  ⇄  Small</p> <ul style="list-style-type: none"> When this adjustment is excessive, the picture may not be displayed correctly. In such a case, please press the RESET button during selection of this item to reset the H SIZE. This item can be selected only at a COMPUTER input.
OVER SCAN	<p>Adjust the Over-scan Ratio: Large  ⇄  Small</p> <ul style="list-style-type: none"> This item can be selected only at a VIDEO input, a S-VIDEO input or a COMPONENT VIDEO input. When this adjustment is too large, a certain degradation may appear at the frame area of the picture. In such a case, please adjust small.
RESET	<p>Reset the PICTURE-2 Menu Items: Selecting the EXECUTE performs this function. EXECUTE  ⇄ CANCEL</p> <ul style="list-style-type: none"> The items of the PICTURE-2 menu are collectively returned to the initial setting. Note that the H PHASE item is not reset.

Multifunctional Settings (continued)

INPUT Menu

With the INPUT menu, the items shown in the table below can be performed.

Perform each operation in accordance with the instructions in the table below.

MENU ▲		
MAIN	COLOR SPACE	AUTO COMPONENT
PICTURE-1	COMPONENT	COMPONENT
PICTURE-2	VIDEO	AUTO
INPUT	FRAME LOCK	TURN ON
AUTO	3D-YCS	NORMAL
SCREEN	VIDEO NR	LOW
OPTION	PROGRESSIVE INFORMATION	TURN OFF
◀ SELECT ▼		

Item	Description
COLOR SPACE	<p>Select a Color Space Mode: AUTO (▲) ⇄ (▼) RGB (▲) ⇄ (▼) SMPTE240 (▲) ⇄ (▼) REC709 (▲) ⇄ (▼) REC601</p> <ul style="list-style-type: none"> This item can be selected only at a COMPUTER input or a COMPONENT VIDEO input. When the AUTO is selected, the optimum mode is automatically selected. However, it may not work well at some signals. In such a case, select the SMPTE240 or REC709 for HDTV signal.
COMPONENT	<p>Select a Function of COMPONENT VIDEO Jacks: COMPONENT (▲) ⇄ (▼) SCART RGB</p> <ul style="list-style-type: none"> When the SCART RGB is selected, the COMPONENT VIDEO jacks function as ports for a RGB input with a SCART cable. Refer to the section "Signal Connectors" of "TECHNICAL".
VIDEO	<p>Select a Signal Type Mode: AUTO (▲) ⇄ (▼) NTSC (▲) ⇄ (▼) PAL (▲) ⇄ (▼) SECAM (▲) ⇄ (▼) NTSC 4.43 (▲) ⇄ (▼) M-PAL (▲) ⇄ (▼) N-PAL</p> <ul style="list-style-type: none"> This item performs only at a VIDEO input or a S-VIDEO input. For a COMPONENT VIDEO input, although this item is ineffective, the signal type is identified automatically even if the AUTO is not selected. Selecting the AUTO automatically selects the optimum mode. However, it may not work well at a PAL60 signal and some other signals. If the picture becomes unstable (ex. a irregular picture, color lack), please select the mode depending on the input signal. The AUTO operation requires approximately 10 seconds.
FRAME LOCK	<p>Select the Frame Lock Mode: TURN ON (▲) ⇄ (▼) TURN OFF</p> <ul style="list-style-type: none"> This function performs only at a COMPUTER input with vertical frequency of 48 to 72 Hz. When the TURN ON is selected, a moving picture is displayed more smoothly. This function may cause a certain degradation of the picture. In such a case, please select the TURN OFF.
3D-YCS	<p>Select a 3D-YCS mode: STILL IMAGE (▲) ⇄ (▼) NORMAL (▲) ⇄ (▼) TURN OFF</p> <ul style="list-style-type: none"> This function performs only at a VIDEO input of NTSC 3.58. NORMAL is the mode for images with a lot of motions like movies, and STILL IMAGE is the mode for images with few motions or completely still ones like slides. When this function performs, the VIDEO NR function is ineffective.

Multifunctional Settings (continued)

INPUT Menu (continued)

Item	Description
VIDEO NR	<p>Select a Noise Reduction Mode: HIGH (▲) ⇄ (▼) MIDDLE (▲) ⇄ (▼) LOW</p> <ul style="list-style-type: none"> • This function performs only at a VIDEO input or a S-VIDEO input. At a VIDEO input of NTSC 3.58, this function performs only when the TURN OFF is selected under the 3D-YCS. • When the HIGH, the MIDDLE or the LOW is selected, the noise on screen is reduced according to each mode. • When this function is excessive, it may cause a certain degradation of the picture.
PROGRESSIVE	<p>Select the Progressive Mode: TV (▲) ⇄ (▼) FILM (▲) ⇄ (▼) TURN OFF</p> <ul style="list-style-type: none"> • This function performs only at an interlaced signal of a VIDEO input, a S-VIDEO input or a COMPONENT VIDEO input of 525i or 625i signal. The FILM mode is adaptable to the 3-2 Pull-Down system to the conversion. • When the TV or FILM is selected, the screen image will be crisper. But it may cause a certain defect (for example, jagged line) of the picture at a quick moving object. In such a case, please select the TURN OFF, even though the screen image may lose the crisp. • This function may cause a certain degradation of the picture. In such a case, please select the TURN OFF.
INFORMATION	<p>Display the Information: Pressing the (▶) or the ENTER button performs this function.</p> <ul style="list-style-type: none"> • Use this function when you want the information about the current input (ex. the resolution and the vertical frequency at a COMPUTER input, the signal type of a video input) and setting states of the COMPONENT, the VIDEO and the FLAME LOCK.
S2-ASPECT	<p>Select the S2-ASPECT Mode: TURN ON (▲) ⇄ (▼) TURN OFF</p> <ul style="list-style-type: none"> • This function performs only at a S-VIDEO input. • When the TURN ON is selected, an S2-Video signal can be identified and the optimum aspect ratio is automatically selected. • When the ASPECT button of the remote control is used or the ASPECT item of the MAIN menu is operated, the S2-ASPECT mode will be switched to the TURN OFF automatically.
RESET	<p>Reset the INPUT Menu Items: Selecting the EXECUTE performs this function. EXECUTE (▲) ⇄ CANCEL</p> <ul style="list-style-type: none"> • The items of the INPUT menu are collectively returned to the initial setting. Note that the INFORMATION item is not reset.

Multifunctional Settings (continued)

AUTO Menu

With the AUTO menu, the items shown in the table below can be performed.
Perform each operation in accordance with the instructions in the table below.

MENU	
MAIN	ADJUST
PICTURE-1	POWER OFF 0 min
PICTURE-2	SEARCH
INPUT	RESET
AUTO	
SCREEN	
OPTION	
[C]: SELECT	

Item	Description
ADJUST	<p>Automatically Adjust the Picture: Pressing the or the ENTER button performs this function.</p> <p>At a COMPUTER input:</p> <ul style="list-style-type: none"> V POSITION, H POSITION, H PHASE and HSIZE are automatically adjusted. Please use this function with the maximum window size. <p>At a VIDEO input or S-VIDEO input:</p> <ul style="list-style-type: none"> This function performs only when the AUTO is selected under the VIDEO item of the INPUT menu. For a COMPONENT VIDEO input, although this function is ineffective, the signal type is identified automatically even if the AUTO is not selected. This function automatically selects the optimum mode for the input signal. However, it may not work well at a PAL60 signal and some other signals. If the picture becomes unstable (ex. irregular picture, color lack), please use the function of VIDEO of the INPUT menu. The operation of this function requires approximately 10 seconds. Also, please note that it may not function correctly with some input.
POWER OFF	<p>Set the Automatically Power Off Timer: Long (Max. 99 minutes.) ⇔ Short (Min. 0 minute =DISABLE)</p> <ul style="list-style-type: none"> This function performs only when the time is set to 1 to 99. When the set time passes without a valid signal (there is no signal, or the signal is out of specifications), the projector lamp automatically goes off, and the POWER indicator begins blinking. Please refer to the section "Turning OFF The Power" of "Power ON/OFF" about the turning off.
SEARCH	<p>Automatically Signal Search: TURN ON ⇔ TURN OFF</p> <ul style="list-style-type: none"> If the TURN ON is selected under this item when no signal input is detected, the projector begins searching for an input signal. When an input signal is detected the projector will cease searching and the picture will appear. The priority of a search is as follows: COMPUTER → VIDEO → S-VIDEO → COMPONENT VIDEO If the projector is unstable to find an input signal at any of its ports, it will return to the state it was in prior to the search.
RESET	<p>Reset the AUTO Menu Items: Selecting the EXECUTE performs this function. EXECUTE ⇔ CANCEL</p> <ul style="list-style-type: none"> The items of the AUTO menu are collectively returned to the initial setting. Note that the item ADJUST is not reset.

Multifunctional Settings (continued)

SCREEN Menu

With the SCREEN menu, the items shown in the table below can be performed.

Perform each operation in accordance with the instructions in the table below.

MENU		
MAIN	BLANK	BLACK
PICTURE-1	START UP	TURN ON
PICTURE-2	MENU POSITION	
INPUT	MESSAGE	TURN ON
AUTO	RESET	
SCREEN		
OPTION		

⏏: SELECT

Item	Description
BLANK	<p>Select a Blank Screen Color: BLUE (▲) ⇄ (▼) WHITE (▲) ⇄ (▼) BLACK</p> <ul style="list-style-type: none"> The blank screen of selected color is displayed by pressing the BLANK button. Please refer to the section "Temporarily Blanking The Screen" of "Operating" about the screen blanking.
START UP	<p>Select the Start Up Screen: TURN ON (▲) ⇄ (▼) TURN OFF</p> <ul style="list-style-type: none"> If the TURN ON is selected when there is no signal or the detected signal is out of specifications, the blank screen is displayed.
MENU POSITION	<p>Adjust a Menu Position: Pressing the (▶) or ENTER button start adjusting,</p> <p style="text-align: center;">Up (▲) Left (◀) ↔ (▶) Right (▼) Down</p> <ul style="list-style-type: none"> The (◀) button does not finish this item. When you want to return to the previous display, please press the ESC button.
MESSAGE	<p>Select the Message Mode: TURN ON (▲) ⇄ (▼) TURN OFF</p> <ul style="list-style-type: none"> When the TURN OFF is selected, the following message functions are disabled: The message of "AUTO IN PROGRESS" The message of "NO INPUT IS DETECTED" The message of "SYNC IS OUT OF RANGE" The message while being searched for an input signal, "Searching" The message when an input signal is detected, "Detecting" The indication of the input signal by input change.
RESET	<p>Reset the SCREEN Menu Items: Selecting the EXECUTE performs this function. EXECUTE (▲) ⇄ CANCEL</p> <ul style="list-style-type: none"> The items of the SCREEN menu are collectively returned to the initial setting.

Multifunctional Settings (continued)

OPTION Menu

With the OPTION menu, the items shown in the table below can be performed.

Perform each operation in accordance with the instructions in the table below.

MENU	
MAIN	VOLUME 16
PICTURE-1	LAMP TIME 1234h
PICTURE-2	FILTER TIME 21h
INPUT	
AUTO	
SCREEN	
OPTION	
⏏ SELECT	

Item	Description
VOLUME	Adjust Volume: High ▲ ↔ ▼ Low
LAMP TIME	<p>To begin the operation of this item, please press the ► button of the projector or the RESET button of the remote control for 3 seconds.</p> <p>Reset the Lamp Timer: Selecting the RESET performs this function. RESET ▲ ← CANCEL</p> <ul style="list-style-type: none"> The numerical value of four digits shown on this menu is the projector use time since the last RESET operation of this item. The value is reset to 0 at the same time the RESET is selected. The value of this function is used to display the message of "CHANGE THE LAMP". So this function must be performed only immediately after replacing the lamp. <p>Do not perform this function unless you have replaced the lamp. Perform this function every time the lamp is replaced. Incorrect performing of this function causes incorrect operation of the message function.</p> <ul style="list-style-type: none"> Please see to the section "Lamp" about replacing the lamp.
FILTER TIME	<p>To begin the operation of this item, please press the ► button of the projector or the RESET button of the remote control for 3 seconds.</p> <p>Reset the Filter Timer: Selecting the RESET performs this function. RESET ▲ ← CANCEL</p> <ul style="list-style-type: none"> The numerical value of four digits shown on this menu is the projector use time since the last RESET operation of this item. The value is reset to 0 at the same time the RESET is selected. The value of this function is used to display the message of "CLEAN THE AIR FILTER". So this function must be performed only immediately after cleaning or replacing the air filter. <p>Do not perform this function unless you have cleaned or replaced the air filter. Perform this function every time the air filter is cleaned or replaced. Incorrect performing of this function causes incorrect operation of the message function.</p> <ul style="list-style-type: none"> Please see to the section "Air Filter" about cleaning and replacing the air filter.

Lamp

WARNING



HIGH VOLTAGE



HIGH TEMPERATURE



HIGH PRESSURE

The projector uses a high-pressure mercury glass lamp. The lamp can **break with a loud bang, or burn out**, if jolted or scratched, handled while hot, or worn over time. Note that each lamp has a different lifetime, and some may burst or burn out soon after you start using them. In addition, when the bulb bursts, it is possible for **shards of glass** to fly into the lamp housing, and for **gas containing mercury** to escape from the projector's vent holes.

- If the lamp should break (it will make a loud bang when it does), unplug the power cord from the outlet, and make sure to request a replacement lamp from your local dealer. Note that shards of glass could damage the projector's internals, or cause injury during handling, so please do not try to clean the projector or replace the lamp yourself.
- If the lamp should break (it will make a loud bang when it does), ventilate the room well, and make sure not to breathe the gas that comes out of the projector vents, or get it in your eyes or mouth.
- Do not open the lamp cover while the projector is suspended from above. This is dangerous, since if the lamp's bulb has broken, the shards will fall out when the cover is opened. In addition, working in high places is dangerous, so ask your local dealer to have the lamp replaced even if the bulb is not broken
- If the indicators or a message prompts you to replace the lamp (see the section "Related Messages" and "Regarding the indicator Lamps"), replace the lamp as soon as possible. Using the lamp for long periods of time, or past the replacement date, could cause it to burst. Do not use old (used) lamps; this is a cause of breakage.
- If the lamp breaks soon after the first time it is used, it is possible that there are electrical problems elsewhere besides the lamp. If this happens, contact your local dealer or a service representative.
- Use the lamp of the specified type only. **Type number: DT00611** (sold separately)
- Handle with care: jolting or scratching could cause the lamp bulb to burst during use.
- Before replacing the lamp, make sure the power switch is off and the power cable is not plugged in, then wait at least 45 minutes for the lamp to cool sufficiently. Handling the lamp while hot can cause burns, as well as damaging the lamp.
- Do not use the projector with the lamp cover removed. At the lamp replacing, make sure that the screws are screwed in firmly. Loose screws could result in damage or injury.
- Obey local ordinances when disposing of used lamps. In most cases, it is possible to dispose of used bulbs in the same manner as used glass bottles, but in some cases, bulbs are sorted separately.

Lamp (continued)

Replacing The Lamp

- ⚠ WARNING** • Please carefully read the “User’s Manual - Safety Guide”.
- ⚠ CAUTION** • Do not reset the lamp timer without replacing the lamp.
- When you replace the lamp, please replace also the air filter. The air filter may be attached when you buy a replacement lamp for this projector. Please ask your dealer.

If the indicators or a message prompts you to replace the lamp, replace the lamp as soon as possible. Using the lamp for long periods of time, or past the replacement date, could cause it to burst. If the projector is mounted on the ceiling, or if the lamp has broken, do not try to clean the projector or replace the lamp yourself.

- 1 Turn off the projector, and unplug the power cord. Allow the lamp bulb to cool for at least 45 minutes.**
- 2 Contact your local dealer to prepare a new lamp. Tell the dealer your lamp type number. If the projector is mounted on the ceiling, or if the lamp has broken, also ask the dealer to replace the lamp.**

In the case of replacement by yourself,

- 3 After making sure that the projector has cooled adequately, slowly flip over the projector, so that the bottom is facing up.**
- 4 Unscrew the screw of the lamp cover, then slide and take the lamp cover up.**
- 5 Unscrew the 2 screws, and slowly pick up the lamp by the handles.**
- 6 Insert the new lamp, and tighten the 2 screws firmly to lock it in place.**
- 7 Slide the lamp cover into place, and tighten the screw of the lamp cover firmly.**

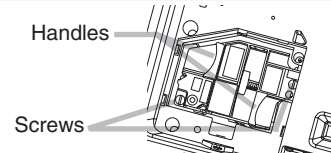
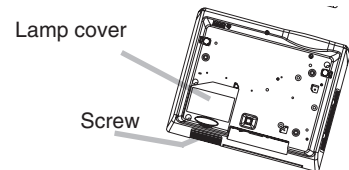

- 8 Slowly turn the projector so that the top is facing up.**
- 9 Turn on the projector, and reset the lamp timer. When the lamp has been replaced after the message of “THE POWER WILL TURN OFF AFTER 0hr.” is displayed, complete the following operation within 10 minutes of switching power on.**
 - (1) While the projector running, press the MENU button to open the menu.
 - (2) Choose the “OPTION” on the menu using the / button, then press the button or ENTER button.
 - (3) Choose the “LAMP TIME” using the / button, then press and hold the button of projector or the RESET button of remote control for 3 seconds.
 - (4) Choose the “RESET” using the button.

Air Filter

⚠ WARNING • Please carefully read the “User’s Manual - Safety Guide”.

- Before replacing the air filter, make sure the power switch is off and the power cable is not plugged in.
- Use the air filter of the specified type only. **Type number: NJ08312** (sold separately)
- Do not use the projector with the air filter and filter cover removed. The use without the air filter could result in damage.

⚠ CAUTION • Do not reset the filter timer without cleaning or replacing the air filter.

- If the air filter becomes clogged by dust or the like, internal temperature rises and could cause malfunction. The power is automatically turned off in order to prevent the projector from overheating internally.
- When you replace the lamp, please replace also the air filter. The air filter may be attached when you buy a replacement lamp for this projector. Please ask your dealer.

Caring For The Air Filter

The air filter should be cleaned about every 100 hours. If the indicators or a message prompts you to clean the air filter (see the section “Related Messages” and “Regarding The Indicator Lamps”), clean the air filter as soon as possible. If the air filter becomes clogged by dust or the like, internal temperature rises and could cause malfunction.

1 Turn off the projector, and unplug the power cord.

2 Apply a vacuum cleaner to the top of the filter cover to clean the air filter.

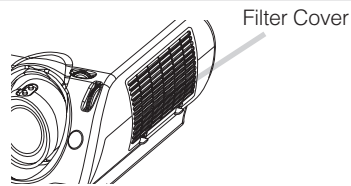

3 Reset the filter timer.

- (1) Turn on the projector. While the projector running, press the MENU button to open the menu.
- (2) Choose the “OPTION” on the menu using the / button, then press the button or ENTER button.
- (3) Choose the “FILTER TIME” using the / button, then press and hold the button of projector or the RESET button of remote control for 3 seconds.
- (4) Choose the “RESET” using the button.

Air Filter (continued)

Replacing The Air Filter

If the soiling will not come off the air filter, or it becomes damaged, then it needs to be replaced. Please replace the air filter as soon as possible.

1 Turn off the projector, and unplug the power cord.

2 Contact your local dealer to prepare a new air filter. Tell the dealer your air filter type number.

3 After making sure that the projector has cooled adequately, remove the filter cover. Hold the release buttons of the filter cover, while pulling up it.

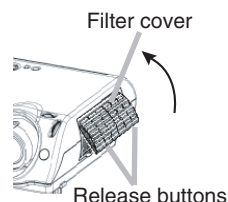

4 Hold the release buttons of the air filter, while pulling down it.

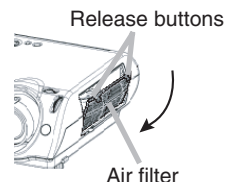

5 Insert a new air filter, and replace the filter cover.

6 Reset the filter timer.

- (1) Turn on the projector. While the projector running, press the MENU button to open the menu.
- (2) Choose the "OPTION" on the menu using the / button, then press the button or ENTER button.
- (3) Choose the "FILTER TIME" using the / button, then press and hold the button of projector or the RESET button of remote control for 3 seconds.
- (4) Choose the "RESET" using the button.

Other Care

⚠ WARNING • Please carefully read the “User’s Manual - Safety Guide”.

• Before replacing the air filter, make sure the power switch is off and the power cable is not plugged in.

ATTENTION • Do not use cleaners or chemicals other than those listed below, including benzene and paint thinner.

- Do not use aerosols or sprays.
- Do not polish or wipe with hard objects.

Caring For The Inside Of The Projector

In order to ensure the safe use of your projector, please have it cleaned and inspected by your local dealer about once every 2 years. Never try to care for the inside of the unit yourself. Doing so is dangerous.

Caring For The Lens

1 Turn off the projector, and unplug the power cord.

2 Lightly wipe the lens with a commercially available lens-cleaning wipe. Do not touch the lens directly with your hand.

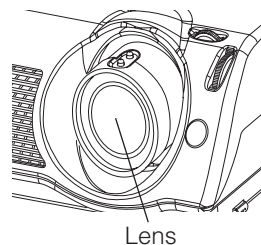

Caring For The Cabinet And Remote Control

1 Turn off the projector, and unplug the power cord.

2 Wipe lightly with gauze or a soft cloth.

If soiling is severe, dip soft cloth in water or a neutral cleaner dilute in water, and wipe lightly after wringing well. Then, wipe lightly with a soft, dry cloth.

Troubleshooting

Related Messages

When the unit's power is ON, messages such as those shown below may be displayed. When any such message is displayed on the screen, please respond as described below. If the same message is displayed after the treatment, or if a message other than the following appears, please contact your dealer or service company.

Message	Description
CHANGE THE LAMP AFTER REPLACING LAMP, RESET THE LAMP TIMER. (*1)	Lamp usage time is approaching 2000 hours. (*2) Preparation of a new lamp, and an early lamp change is recommended. After you have changed the lamp, please be sure to reset the lamp timer.
CHANGE THE LAMP AFTER REPLACING LAMP, RESET THE LAMP TIMER. THE POWER WILL TURN OFF AFTER ** hr. (*1)	Lamp usage time is approaching 2000 hours. (*2) A lamp change within ** hours is recommended. When lamp usage reaches 2000 hours, the power will automatically be turned OFF. Please change the lamp by referring to the "Lamp" section of this manual. After you have changed the lamp, please be sure to reset the lamp timer.
CHANGE THE LAMP AFTER REPLACING LAMP, RESET THE LAMP TIMER. THE POWER WILL TURN OFF AFTER 0 hr.	As lamp use has reached 2000 hours (*2), the power will soon be automatically turned OFF. Please immediately turn the power off, and change the lamp by referring to the "Lamp" section of this manual. After you have changed the lamp, please be sure to reset the lamp timer.
NO INPUT IS DETECTED ON ***	There is no input signal. Please confirm the signal input connection, and the status of the signal source.
SYNC IS OUT OF RANGE ON *** <input type="text"/> fH *****kHz <input type="text"/> fV *****Hz	The horizontal or vertical wavelength of the inputted signal is outside of the response parameters of this unit. Please confirm the specs for this unit or the signal source specs.
CHECK THE AIR FLOW	The internal portion temperature is rising. Please turn the power OFF, and allow the unit to cool down at least 20 minutes. After having confirmed the following items, please turn the power ON again. <ul style="list-style-type: none"> • Is there blockage of the air passage aperture? • Is the air filter dirty? • Does the peripheral temperature exceed 35°C?

NOTE (*1) • Although this message will be automatically disappeared after around 3 minutes, it will be reappeared every time the power is turned ON.

(*2) • Lamps have a finite product life. Lamps are characterized by the fact that, after long hours of usage, a lamp will no longer light up, or the lamp will break or burst, etc. This unit is equipped with an automatic shut-down function, such that the power will automatically be turned OFF when lamp usage time has reached 2,000 hours. Please be aware, however, that among lamp types, there are major differences in product lifetimes; a lamp may thus fail to light even prior to the functioning of the automatic shut-down function of this unit.

Troubleshooting (continued)

Related Messages (continued)

Message	Description
CLEAN THE AIR FILTER POWER OFF FIRST, THEN CLEAN THE AIR FILTER. AFTER CLEANING THE AIR FILTER, RESET THE FILTER TIMER.	A note of precaution when cleaning the air filter. Please immediately turn the power OFF, and clean or change the air filter by referring to the "Air Filter" section of this manual. After you have cleaned or changed the air filter, please be sure to reset the filter timer. If the same message is displayed after the treatment, please clean the transparent area of filter cover and the dust-detecting window, according to the following.

ATTENTION • The transparent area of filter cover and the dust-detecting window should be cleaned for normal operation of the optical dust detecting system. Please pay attention not to remain fiber or fragment of cloth inside the duct.

1 Turn off the projector, and unplug the power cord.

2 After making sure that the projector has cooled adequately, remove the filter cover.

Hold the release buttons of the filter cover, while pulling up it.

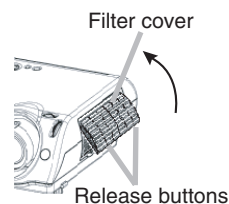

3 Wipe the transparent area of the filter cover by using a swab or a soft cloth.

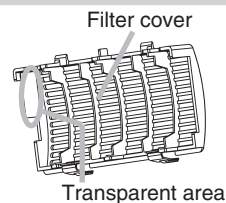

4 Remove the air filter.

Hold the release buttons of the air filter, while pulling down it.

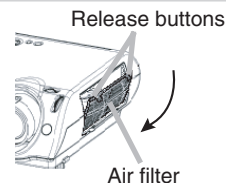

5 Wipe the dust-detecting window by using a soft cloth.

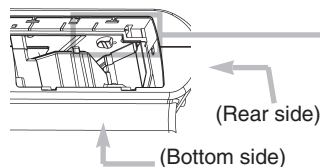

Dust detecting window

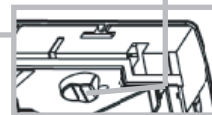

6 Replace the air filter and filter cover.

Troubleshooting (continued)

Regarding The Indicator Lamps

ATTENTION • When the interior portion has become overheated, or when the lamp cover has not been properly fixed (attached), for safety purposes, the power source may be automatically turned off, and the indicator lamps may also be turned off. In such a case, press the “○” (OFF) side of the power switch, and wait at least 45 minutes. After the unit has sufficiently cooled down, please make confirmation of the attachment state of the lamp and lamp cover, and then turn the power on again.

Lighting and flashing of the POWER indicator, the LAMP indicator, and the TEMP indicator have the meanings as described in the table below. Please respond in accordance with the instructions within the table. If the same indication is displayed after the treatment, or if an indication other than the following is displayed, please contact your dealer or service company.

POWER indicator	LAMP indicator	TEMP indicator	Description
Lighting in orange	Turned off	Turned off	The unit is in a standby state. Please refer to the “Power ON/OFF” section of this manual.
Flashing in green	Turned off	Turned off	The unit is warming up. Please wait.
Lighting in green	Turned off	Turned off	The unit is in an ON state. Ordinary operations may be performed.
Flashing in orange	Turned off	Turned off	The unit is cooling down. Please wait.
Blinking in red	-	-	The unit is cooling down. A certain error has been detected. Wait until the POWER indicator has finished flashing, and then perform the proper response measure using the item descriptions below as reference.
Lighting or blinking in red	Lighting in red	Turned off	<p>The projector lamp does not light, and/or there is a possibility that the interior portion has become heated. Turn the power OFF and wait at least 20 minutes. After the unit has sufficiently cooled down, please make confirmation of the following items, and then turn the power ON again. If the same indication is displayed, please change the lamp.</p> <ul style="list-style-type: none"> • Is there blockage of the air passage aperture? • Is the air filter is dirty? • Does the peripheral temperature exceed 35°C?

Troubleshooting (continued)

Regarding The Indicator Lamps (continued)

POWER indicator	LAMP indicator	TEMP indicator	Description
Lighting or blinking in red	Turned off	Blinking in red	<p>The cooling fan is not operating. Turn the power OFF and wait at least 20 minutes. After the unit has sufficiently cooled down, please make confirmation of the following item, and then resent the power to ON.</p> <ul style="list-style-type: none"> • Is there no foreign matter caught in the cooling fan?
Lighting or blinking in red	Turned off	Lighting in red	<p>There is a possibility that the interior portion has become heated. Turn the power OFF and wait at least 20 minutes. After the unit has sufficiently cooled down, please make confirmation of the following item, and then resent the power to ON.</p> <ul style="list-style-type: none"> • Is there blockage of the air passage aperture? • Is the air filter is dirty? • Does the peripheral temperature exceed 35°C?
Lighting in green	Alternative blinking in the red		<p>There is a possibility that the interior portion has become overcooled. Please use the unit within the usage temperature parameters (0°C to 35°C). After the treatment, resent the power to ON.</p>
Lighting in green	Simultaneous blinking in red		<p>It is time to clean the air filter, or there is no air filter. Please immediately turn the power OFF, and clean or change the air filter by referring to the "Air Filter" section of this manual. After you have cleaned or changed the air filter, please be sure to reset the filter timer. After the treatment, resent the power to ON.</p>

Troubleshooting (continued)

Phenomena That May Easily Be Mistaken For Machine Defects

⚠ WARNING • Please carefully read the “User’s Manual - Safety Guide”.

Never use the projector if abnormal operations such as smoke, strange odor, excessive sound, damaged casing or elements or cables, penetration of liquids or foreign matter, etc. should occur.

NOTE • Although bright spots or dark spots may appear on the screen, this is a unique characteristic of liquid crystal displays, and such do not constitute or imply a machine defect.

Before requesting repair, please check in accordance with the following chart. If the situation cannot be corrected, then contact your dealer.

Phenomenon	Cases not involving a machine defect, and Items to be confirmed	Reference pages
Power does not come ON.	The main power source is not ON. Turn on the main power.	11,14
	The electrical power cord is not plugged in. Correctly connect the power cord.	
	The main power source has been interrupted during operation, such as by a power outage (blackout), etc. Be sure to press the “O” (power OFF) side of the main power switch, and leave this OFF for at least 20 minutes. After the unit has sufficiently cooled down, turn ON the power source.	14
Neither sounds nor pictures are outputted.	The lamp has not been properly fixed. Turn the power OFF and wait at least 45 minutes. After the unit has sufficiently cooled down, please make confirmation of the attachment state of the lamp and lamp cover, and then turn the power ON again.	32
	The input changeover settings are mismatched. Select the input signal, and correct the settings.	15
Pictures are displayed, but no sounds are heard.	No signal is being inputted. Correctly connect the connection cables.	10
	The electrical wiring to this unit is not correctly connected. Correctly connect the connection cables.	10
	The volume setting has been set at (or adjusted to) an extremely low level. Adjust the VOLUME setting to a higher level.	17
Sounds are heard, but no pictures are displayed.	The MUTE mode is the current setting. Press the MUTE button to release (change) the MUTE mode setting.	17
	The electrical wiring to this unit is not correctly connected. Correctly connect the connection cables.	10
	The brightness setting has been set at (or adjusted to) an extremely low level. Adjust the BRIGHT setting to a brighter level.	22
	The lens cap has not been removed. Remove the lens cap.	4,14

Troubleshooting (continued)

Phenomena That May Easily Be Mistaken For Machine Defects (continued)

Phenomenon	Cases not involving a machine defect, and Items to be confirmed	Reference pages
Colors have a faded-out appearance, or Color tone is poor.	Color settings are not correctly adjusted. Perform picture adjustments by changing the COLOR BAL R, COLOR BAL G, COLOR BAL B, COLOR, and/or the TINT settings, etc.	23
Pictures appear dark.	The brightness setting and/or contrast setting has not been properly adjusted. Perform picture adjustments by changing the BRIGHT and/or CONTRAST settings, etc.	22
	The WHISPER mode is the current setting. Change (by releasing) from the WHISPER mode.	
	Lamp is approaching the end of its product lifetime. Exchange the old lamp with a new lamp.	31,32
Pictures appear blurry.	Either the FOCUS setting or the H PHASE is not properly adjusted. Adjust the focus and the H PHASE setting.	15,25
	The lens is dirty or misty. Clean the lens.	35

Warranty And After-Service

If a problem occurs with the equipment, first refer to the "Troubleshooting" section of this manual, and run through the suggested checks. If this does not resolve the problem contact your dealer or service company. They will tell you what warranty condition is applied.

Specifications

Item		Specification												
Product name		Liquid crystal projector												
Liquid crystal panel	Panel size	1.4 cm (0.55 type)												
	Drive system	TFT active matrix												
	Pixels	409,920 pixels (854 horizontal x 480 vertical)												
Lens		Zoom lens F=1.6 ~ 2.8 f=14.2 ~ 28.4 mm												
Lamp		130W UHB												
Speaker		1.0W												
Power supply		AC100 ~ 120V, 2.4A / AC220 ~ 240V, 1.1A												
Power consumption		220W												
Temperature range		0 ~ 35°C (Operating)												
Size		350 (W) x 121 (H) x 285 (D) mm (Not including protruding parts)												
Weight (mass)		3.6 kg												
Ports		<table border="0"> <tr> <td>RGB Input Ports</td> <td>AUDIO Ports</td> </tr> <tr> <td>COMPUTER1</td> <td>AUDIO1</td> </tr> <tr> <td>VIDEO Input Ports</td> <td>AUDIO R, L1</td> </tr> <tr> <td>VIDEO1</td> <td>CONTROL Ports</td> </tr> <tr> <td>S-VIDEO1</td> <td>CONTROL1</td> </tr> <tr> <td>COMPONENT VIDEO (CR/PR, CB/PB, Y)1</td> <td></td> </tr> </table>	RGB Input Ports	AUDIO Ports	COMPUTER1	AUDIO1	VIDEO Input Ports	AUDIO R, L1	VIDEO1	CONTROL Ports	S-VIDEO1	CONTROL1	COMPONENT VIDEO (CR/PR, CB/PB, Y)1	
RGB Input Ports	AUDIO Ports													
COMPUTER1	AUDIO1													
VIDEO Input Ports	AUDIO R, L1													
VIDEO1	CONTROL Ports													
S-VIDEO1	CONTROL1													
COMPONENT VIDEO (CR/PR, CB/PB, Y)1														
Optional Parts		Lamp: DT00611 Air Filter: NJ08312 For others, consult your dealer.												

NOTE • This specifications are subject to change without notice.

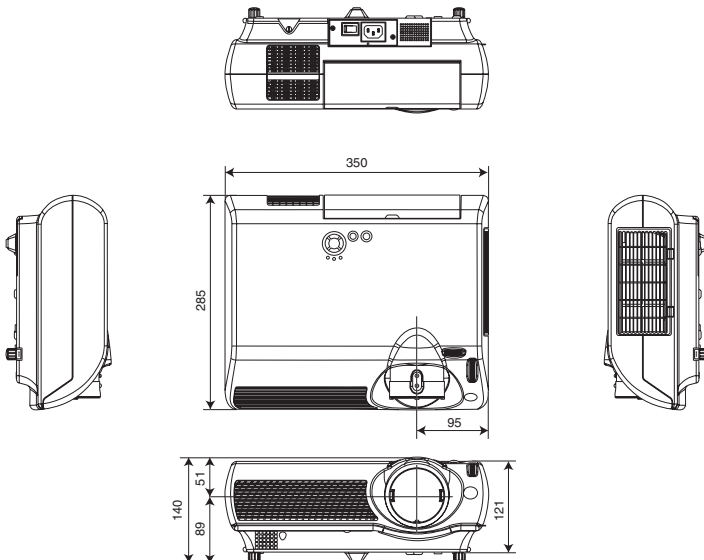

TECHNICAL

Signal Connectors

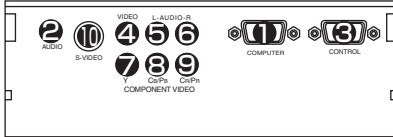

Port	Specification																																				
11 COMPUTER 	Video signal: RGB separate, Analog, 0.7 Vp-p, 75 Ω terminator (positive) H/V. sync. signal: TTL level (positive/negative) Composite sync. signal: TTL level D-sub 15-pin shrink jack <table border="1"> <thead> <tr> <th>No.</th> <th>Signal</th> <th>No.</th> <th>Signal</th> <th>No.</th> <th>Signal</th> </tr> </thead> <tbody> <tr> <td>1</td> <td>Video input Red</td> <td>6</td> <td>Ground Red</td> <td>11</td> <td>-</td> </tr> <tr> <td>2</td> <td>Video input Green</td> <td>7</td> <td>Ground Green</td> <td>12</td> <td>SDA (DDC)</td> </tr> <tr> <td>3</td> <td>Video input Blue</td> <td>8</td> <td>Ground Blue</td> <td>13</td> <td>H. sync./Composite sync.</td> </tr> <tr> <td>4</td> <td>-</td> <td>9</td> <td>Ground</td> <td>14</td> <td>Vertical sync</td> </tr> <tr> <td>5</td> <td>Ground</td> <td>10</td> <td>-</td> <td>15</td> <td>SCL (DDC)</td> </tr> </tbody> </table>	No.	Signal	No.	Signal	No.	Signal	1	Video input Red	6	Ground Red	11	-	2	Video input Green	7	Ground Green	12	SDA (DDC)	3	Video input Blue	8	Ground Blue	13	H. sync./Composite sync.	4	-	9	Ground	14	Vertical sync	5	Ground	10	-	15	SCL (DDC)
No.	Signal	No.	Signal	No.	Signal																																
1	Video input Red	6	Ground Red	11	-																																
2	Video input Green	7	Ground Green	12	SDA (DDC)																																
3	Video input Blue	8	Ground Blue	13	H. sync./Composite sync.																																
4	-	9	Ground	14	Vertical sync																																
5	Ground	10	-	15	SCL (DDC)																																
2 AUDIO (interlocked 1 port)	200 mVrms, 50 kΩ (max. 3.0 Vp-p), Stereo mini jack																																				
13 CONTROL 	D-sub 9-pin plug <table border="1"> <thead> <tr> <th>No.</th> <th>Signal</th> <th>No.</th> <th>Signal</th> <th>No.</th> <th>Signal</th> </tr> </thead> <tbody> <tr> <td>1</td> <td>-</td> <td>4</td> <td>-</td> <td>7</td> <td>RTS</td> </tr> <tr> <td>2</td> <td>RD</td> <td>5</td> <td>Ground</td> <td>8</td> <td>CTS</td> </tr> <tr> <td>3</td> <td>TD</td> <td>6</td> <td>-</td> <td>9</td> <td>-</td> </tr> </tbody> </table>	No.	Signal	No.	Signal	No.	Signal	1	-	4	-	7	RTS	2	RD	5	Ground	8	CTS	3	TD	6	-	9	-												
No.	Signal	No.	Signal	No.	Signal																																
1	-	4	-	7	RTS																																
2	RD	5	Ground	8	CTS																																
3	TD	6	-	9	-																																
4 VIDEO	1.0 Vp-p, 75 Ω terminator, RCA jack																																				
AUDIO 5 L, 6 R (interlocked 4 / 7 8 9 / 10)	200 mVrms, 50 kΩ (max. 3.0 Vp-p), RCA jack																																				
COMPONENT VIDEO 7 Y, 8 Cb/Pb, 9 Cr/Pb	Y signal: 1.0 Vp-p, 75 Ω terminator Cb/Pb signal: 0.7 Vp-p, 75 Ω terminator Cr/Pb signal: 0.7 Vp-p, 75 Ω terminator																																				
10 S-VIDEO 	Mini Din 4-pin jack <table border="1"> <thead> <tr> <th>No.</th> <th>Signal</th> </tr> </thead> <tbody> <tr> <td>1</td> <td>Color signal: 0.286 Vp-p (NTSC, burst), 75 Ω terminator Color signal: 0.300 Vp-p (PAL/SECAM, burst), 75 Ω terminator</td> </tr> <tr> <td>2</td> <td>Brightness signal: 1.0 Vp-p, 75 Ω terminator</td> </tr> <tr> <td>3</td> <td>Ground</td> </tr> <tr> <td>4</td> <td>Ground</td> </tr> </tbody> </table>	No.	Signal	1	Color signal: 0.286 Vp-p (NTSC, burst), 75 Ω terminator Color signal: 0.300 Vp-p (PAL/SECAM, burst), 75 Ω terminator	2	Brightness signal: 1.0 Vp-p, 75 Ω terminator	3	Ground	4	Ground																										
No.	Signal																																				
1	Color signal: 0.286 Vp-p (NTSC, burst), 75 Ω terminator Color signal: 0.300 Vp-p (PAL/SECAM, burst), 75 Ω terminator																																				
2	Brightness signal: 1.0 Vp-p, 75 Ω terminator																																				
3	Ground																																				
4	Ground																																				

Example Of Computer Signal

Resolution H x V	fH (kHz)	fV (Hz)	Rating	Signal mode
720 x 400	37.9	85.0	VESA	TEXT
640 x 480	31.5	59.9	VESA	VGA (60Hz)
640 x 480	35.0	66.7		Mac13"mode
640 x 480	37.9	72.8	VESA	VGA (72Hz)
640 x 480	37.5	75.0	VESA	VGA (75Hz)
640 x 480	43.3	85.0	VESA	VGA (85Hz)
800 x 600	35.2	56.3	VESA	SVGA (56Hz)
800 x 600	37.9	60.3	VESA	SVGA (60Hz)
800 x 600	48.1	72.2	VESA	SVGA (72Hz)
800 x 600	46.9	75.0	VESA	SVGA (75Hz)
800 x 600	53.7	85.1	VESA	SVGA (85Hz)
832 x 624	49.7	74.5		Mac16"mode
848 x 480	29.8	60.0	VESA	W VGA (60Hz)
1024 x 768	48.4	60.0	VESA	XGA (60Hz)
1024 x 768	56.5	70.1	VESA	XGA (70Hz)
1024 x 768	60.0	75.0	VESA	XGA (75Hz)
1280 x 960	60.0	60.0	VESA	SXGA (60Hz)
1280 x 1024	64.0	60.0	VESA	SXGA (60Hz)

- NOTE** • Some computers may have multiple display screen modes. Use of some of these modes will not be possible with this projector.
- Be sure to check jack type, signal level, timing and resolution before connecting this projector to a computer.
 - Depending on the input signal, full-size display may not be possible in some cases. Refer to the number of display pixels above.
 - Although the projector can display signals with resolution up to UXGA (1,600 x 1,200), the signal will be converted to the projector's panel resolution before being displayed. The best display performance will be achieved if the resolutions of the input signal and projector panel are identical.
 - The image may not be displayed correctly when the input sync. signal is "Composite Sync." or "Sync. on G".
 - Automatically adjustment may not function correctly with some input signals.
 - When the image resolution is changed on a computer, depending on an input, automatic adjust function may take some time and may not be completed. In this case, you may not be able to see a check box to select "Yes/No" for the new resolution on Windows. Then the resolution will go back to the original. It might be recommended to use other CRT or TFT monitors to change the resolution.

Initial Set Signals

The following signals are used for the initial settings.

The signal timing of some computer models may be different. In such case, refer to adjust the V.POSIT and H.POSIT of the menu.

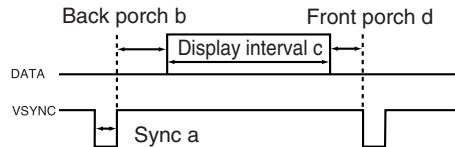
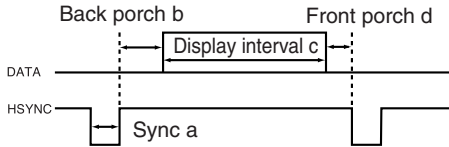

Computer / Signal	Horizontal signal timing (μ s)			
	a	b	c	d
TEXT	2.0	3.0	20.3	1.0
VGA (60Hz)	3.8	1.9	25.4	0.6
Mac 13"mode	2.1	3.2	21.2	2.1
VGA (72Hz)	1.3	3.8	20.3	1.0
VGA (75Hz)	2.0	3.8	20.3	0.5
VGA (85Hz)	1.6	2.2	17.8	1.6
SVGA (56Hz)	2.0	3.6	22.2	0.7
SVGA (60Hz)	3.2	2.2	20.0	1.0
SVGA (72Hz)	2.4	1.3	16.0	1.1
SVGA (75Hz)	1.6	3.2	16.2	0.3
SVGA (85Hz)	1.1	2.7	14.2	0.6
Mac 16"mode	1.1	3.9	14.5	0.6
848 x 480 (60Hz)	2.8	3.3	26.9	0.5
XGA (60Hz)	2.1	2.5	15.8	0.4
XGA (70Hz)	1.8	1.9	13.7	0.3
XGA (75Hz)	1.2	2.2	13.0	0.2
1280x960 (60Hz)	1.0	2.9	11.9	0.9
1280x1024 (60Hz)	1.0	2.3	11.9	0.4

Computer / Signal	Vertical signal timing (lines)			
	a	b	c	d
TEXT	3	42	400	1
VGA (60Hz)	2	33	480	10
Mac 13"mode	3	39	480	3
VGA (72Hz)	3	28	480	9
VGA (75Hz)	3	16	480	1
VGA (85Hz)	3	25	480	1
SVGA (56Hz)	2	22	600	1
SVGA (60Hz)	4	23	600	1
SVGA (72Hz)	6	23	600	37
SVGA (75Hz)	3	21	600	1
SVGA (85Hz)	3	27	600	1
Mac 16"mode	3	39	624	1
848 x 480 (60Hz)	3	13	480	1
XGA (60Hz)	6	29	768	3
XGA (70Hz)	6	29	768	3
XGA (75Hz)	3	28	768	1
1280x960 (60Hz)	3	36	960	1
1280x1024 (60Hz)	3	38	1024	1

RS-232C Communication

Connecting The Cable

- (1) Turn off the projector and the computer power supplies.
- (2) Connect the CONTROL port of the projector with a RS-232C port of the computer by a RS-232C cable. Use the cable that fulfills the specification shown in the following figure.
- (3) Turn on the computer power supply and after the computer has started up, turn on the projector power supply.

Projector

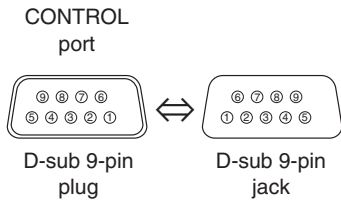

RS-232C cross cable

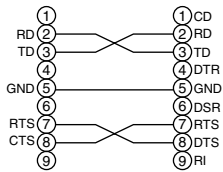

Computer

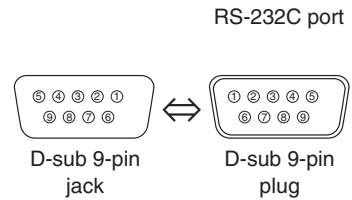

Communications Setting

19200bps, 8N1

1. Protocol

Consist of header (7 bytes) + command data (6 bytes).

2. Header

BE + EF + 03 + 06 + 00 + CRC_low + CRC_high

CRC_low : Lower byte of CRC flag for command data

CRC_high : Upper byte of CRC flag for command data

3 Command data

Command Data Chart

byte_0	byte_1	byte_2	byte_3	byte_4	byte_5
Action		Type		Setting code	
low	high	low	high	low	high

Action (byte_0 - 1)

Action	Classification	Content
1	SET	Change setting to desired value.
2	GET	Read projector internal setup value.
4	INCREMENT	Increment setup value by 1.
5	DECREMENT	Decrement setup value by 1.
6	EXECUTE	Run a command.

RS-232C Communication (continued)

Requesting projector status (Get command)

- (1) Send the request code Header + Command data ('02H'+ '00H'+ type (2 bytes)+'00H'+ '00H') from the computer to the projector.
- (2) The projector returns the response code '1DH'+ data (2 bytes) to the computer.

Changing the projector settings (Set command)

- (1) Send the setting code Header + Command data ('01H'+ '00H'+ type (2 bytes) + setting code (2 bytes)) from the computer to the projector.
- (2) The projector changes the setting based on the above setting code.
- (3) The projector returns the response code '06H' to the computer.

Using the projector default settings (Reset Command)

- (1) The computer sends the default setting code Header + Command data ('06H'+ '00H'+ type (2 bytes) + '00H'+ '00H') to the projector.
- (2) The projector changes the specified setting to the default value.
- (3) The projector returns the response code '06H' to the computer.

Increasing the projector setting value (Increment command)

- (1) The computer sends the increment code Header + Command data ('04H'+ '00H'+ type (2 bytes) + '00H'+ '00H') to the projector.
- (2) The projector increases the setting value on the above setting code.
- (3) The projector returns the response code '06H' to the computer.

Decreasing the projector setting value (Decrement command)

- (1) The computer sends the decrement code Header + Command data ('05H'+ '00H'+ type (2 bytes) + '00H'+ '00H') to the projector.
- (2) The projector decreases the setting value on the above setting code.
- (3) The projector returns the response code '06H' to the computer.

When the projector cannot understand the received command

When the projector cannot understand the received command, the error code '15H' is sent back to the computer.

Sometimes the projector cannot properly receive the command. In such a case, the command is not executed and the error code '15H' is sent back to the computer. If this error code is returned, send the same command again.

When the projector cannot execute the received command.

When the projector cannot execute the received command, the error code '1cH' + 'xxxH' is sent back to the computer. When the data length is greater than indicated by the data length code, the projector ignores the excess data code.

Conversely when the data length is shorter than indicated by the data length code, an error code will be returned to the computer.

- NOTE**
- Operation cannot be guaranteed when the projector receives an undefined command or data.
 - Provide an interval of at least 40ms between the response code and any other code.
 - The projector outputs test data when the power supply is switched ON, and when the lamp is lit. Ignore this data.
 - Commands are not accepted during warm-up.

RS-232C Communication (continued)

Command Data Chart

Names	Operation type	Header				Command data			
					CRC	Action	Type	Setting code	
Keystone	Get	BE EF	03	06 00	B9 D3	02 00	07 20	00 00	
	Increment	BE EF	03	06 00	DF D3	04 00	07 20	00 00	
	Decrement	BE EF	03	06 00	0E D2	05 00	07 20	00 00	
Keystone Reset	Execute	BE EF	03	06 00	08 D0	06 00	0C 70	00 00	
Brightness	Get	BE EF	03	06 00	89 D2	02 00	03 20	00 00	
	Increment	BE EF	03	06 00	EF D2	04 00	03 20	00 00	
	Decrement	BE EF	03	06 00	3E D3	05 00	03 20	00 00	
Brightness Reset	Execute	BE EF	03	06 00	58 D3	06 00	00 70	00 00	
Contrast	Get	BE EF	03	06 00	FD D3	02 00	04 20	00 00	
	Increment	BE EF	03	06 00	9B D3	04 00	04 20	00 00	
	Decrement	BE EF	03	06 00	4A D2	05 00	04 20	00 00	
Contrast Reset	Execute	BE EF	03	06 00	A4 D2	06 00	01 70	00 00	
Aspect	Set	4:3	BE EF	03	06 00	9E D0	01 00	08 20	00 00
		16:9	BE EF	03	06 00	0E D1	01 00	08 20	01 00
		15:9	BE EF	03	06 00	6E D0	01 00	08 20	03 00
		32:15	BE EF	03	06 00	5E D2	01 00	08 20	04 00
		WIDE	BE EF	03	06 00	CE D3	01 00	08 20	05 00
		MOVIE-1	BE EF	03	06 00	3E D3	01 00	08 20	06 00
		MOVIE-2	BE EF	03	06 00	AE D2	01 00	08 20	07 00
Whisper	Set	Get	BE EF	03	06 00	AD D0	02 00	08 20	00 00
		NORMAL	BE EF	03	06 00	3B 23	01 00	00 33	00 00
	WHISPER	BE EF	03	06 00	AB 22	01 00	00 33	01 00	
	Get	BE EF	03	06 00	08 23	02 00	00 33	00 00	
Mirror	Set	Normal	BE EF	03	06 00	C7 D2	01 00	01 30	00 00
		H Inverse	BE EF	03	06 00	57 D3	01 00	01 30	01 00
		V Inverse	BE EF	03	06 00	A7 D3	01 00	01 30	02 00
		H&V Inverse	BE EF	03	06 00	37 D2	01 00	01 30	03 00
	Get	BE EF	03	06 00	F4 D2	02 00	01 30	00 00	

RS-232C Communication (continued)

Command Data Chart (continued)

Names	Operation type	Header				Command data		
					CRC	Action	Type	Setting code
Language	Set	English	BE EF	03 06 00	F7 D3	01 00	05 30	00 00
		FRANÇAIS	BE EF	03 06 00	67 D2	01 00	05 30	01 00
		Deutsch	BE EF	03 06 00	97 D2	01 00	05 30	02 00
		ESPAÑOL	BE EF	03 06 00	07 D3	01 00	05 30	03 00
		Italiano	BE EF	03 06 00	37 D1	01 00	05 30	04 00
		Norsk	BE EF	03 06 00	A7 D0	01 00	05 30	05 00
		Nederlands	BE EF	03 06 00	57 D0	01 00	05 30	06 00
		PORTUGUÊS	BE EF	03 06 00	C7 D1	01 00	05 30	07 00
		日本語	BE EF	03 06 00	37 D4	01 00	05 30	08 00
		中文	BE EF	03 06 00	A7 D5	01 00	05 30	09 00
		한글	BE EF	03 06 00	57 D5	01 00	05 30	0A 00
		SVENSKA	BE EF	03 06 00	C7 D4	01 00	05 30	0B 00
		РУССКИЙ	BE EF	03 06 00	F7 D6	01 00	05 30	0C 00
	SUOMI	BE EF	03 06 00	67 D7	01 00	05 30	0D 00	
POLSKI	BE EF	03 06 00	97 D7	01 00	05 30	0E 00		
	Get	BE EF	03 06 00	C4 D3	02 00	05 30	00 00	
Gamma	Set	NORMAL	BE EF	03 06 00	C7 F0	01 00	A1 30	00 00
		CINEMA	BE EF	03 06 00	57 F1	01 00	A1 30	01 00
		DYNAMIC	BE EF	03 06 00	A7 F1	01 00	A1 30	02 00
		CUSTOM	BE EF	03 06 00	07 FD	01 00	A1 30	10 00
		Get	BE EF	03 06 00	F4 F0	02 00	A1 30	00 00
Custom Gamma		Get	BE EF	03 06 00	08 F1	02 00	A3 30	00 00
		Increment	BE EF	03 06 00	6E F1	04 00	A3 30	00 00
		Decrement	BE EF	03 06 00	BF F0	05 00	A3 30	00 00
Custom Color Temp	Set	USER	BE EF	03 06 00	3B F8	01 00	B0 30	10 00
		HIGH	BE EF	03 06 00	0B F5	01 00	B0 30	03 00
		MIDDLE	BE EF	03 06 00	9B F4	01 00	B0 30	02 00
		LOW	BE EF	03 06 00	6B F4	01 00	B0 30	01 00
		Get	BE EF	03 06 00	C8 F5	02 00	B0 30	00 00
Custom User R	Set	50	BE EF	03 06 00	57 F7	01 00	B1 30	05 00
		60	BE EF	03 06 00	C7 F6	01 00	B1 30	04 00
		70	BE EF	03 06 00	F7 F4	01 00	B1 30	03 00
		80	BE EF	03 06 00	67 F5	01 00	B1 30	02 00
		90	BE EF	03 06 00	97 F5	01 00	B1 30	01 00
		100	BE EF	03 06 00	07 F4	01 00	B1 30	00 00
		Get	BE EF	03 06 00	34 F4	02 00	B1 30	00 00
Custom User G	Set	50	BE EF	03 06 00	13 F7	01 00	B2 30	05 00
		60	BE EF	03 06 00	83 F6	01 00	B2 30	04 00
		70	BE EF	03 06 00	B3 F4	01 00	B2 30	03 00
		80	BE EF	03 06 00	23 F5	01 00	B2 30	02 00
		90	BE EF	03 06 00	D3 F5	01 00	B2 30	01 00
		100	BE EF	03 06 00	43 F4	01 00	B2 30	00 00
		Get	BE EF	03 06 00	70 F4	02 00	B2 30	00 00

RS-232C Communication (continued)

Command Data Chart (continued)

Names	Operation type	Header				Command data		
					CRC	Action	Type	Setting code
Custom User B	Set	50	BE EF	03 06 00	EF F6	01 00	B3 30	05 00
		60	BE EF	03 06 00	7F F7	01 00	B3 30	04 00
		70	BE EF	03 06 00	4F F5	01 00	B3 30	03 00
		80	BE EF	03 06 00	DF F4	01 00	B3 30	02 00
		90	BE EF	03 06 00	2F F4	01 00	B3 30	01 00
		100	BE EF	03 06 00	BF F5	01 00	B3 30	00 00
	Get	BE EF	03 06 00	8C F5	02 00	B3 30	00 00	
Color Balance R	Get	BE EF	03 06 00	01 D2	02 00	05 20	00 00	
	Increment	BE EF	03 06 00	67 D2	04 00	05 20	00 00	
	Decrement	BE EF	03 06 00	B6 D3	05 00	05 20	00 00	
Color Balance R Reset	Execute	BE EF	03 06 00	94 D3	06 00	05 70	00 00	
Color Balance G	Get	BE EF	03 06 00	B5 D7	02 00	12 20	00 00	
	Increment	BE EF	03 06 00	D3 D7	04 00	12 20	00 00	
	Decrement	BE EF	03 06 00	02 D6	05 00	12 20	00 00	
Color Balance G Reset	Execute	BE EF	03 06 00	04 DB	06 00	29 70	00 00	
Color Balance B	Get	BE EF	03 06 00	45 D2	02 00	06 20	00 00	
	Increment	BE EF	03 06 00	23 D2	04 00	06 20	00 00	
	Decrement	BE EF	03 06 00	F2 D3	05 00	06 20	00 00	
Color Balance B Reset	Execute	BE EF	03 06 00	D0 D3	06 00	06 70	00 00	
Sharpness	Get	BE EF	03 06 00	F1 72	02 00	01 22	00 00	
	Increment	BE EF	03 06 00	97 72	04 00	01 22	00 00	
	Decrement	BE EF	03 06 00	46 73	05 00	01 22	00 00	
Sharpness Reset	Execute	BE EF	03 06 00	C4 D0	06 00	09 70	00 00	
Color	Get	BE EF	03 06 00	B5 72	02 00	02 22	00 00	
	Increment	BE EF	03 06 00	D3 72	04 00	02 22	00 00	
	Decrement	BE EF	03 06 00	02 73	05 00	02 22	00 00	
Color Reset	Execute	BE EF	03 06 00	80 D0	06 00	0A 70	00 00	
Tint	Get	BE EF	03 06 00	49 73	02 00	03 22	00 00	
	Increment	BE EF	03 06 00	2F 73	04 00	03 22	00 00	
	Decrement	BE EF	03 06 00	FE 72	05 00	03 22	00 00	
Tint Reset	Execute	BE EF	03 06 00	7C D1	06 00	0B 70	00 00	
My Memory Load	Set	1	BE EF	03 06 00	0E D7	01 00	14 20	00 00
		2	BE EF	03 06 00	9E D6	01 00	14 20	00 01
		3	BE EF	03 06 00	6E D6	01 00	14 20	02 00
		4	BE EF	03 06 00	FE D7	01 00	14 20	03 00
My Memory Save	Set	1	BE EF	03 06 00	F2 D6	01 00	15 20	00 00
		2	BE EF	03 06 00	62 D7	01 00	15 20	01 00
		3	BE EF	03 06 00	92 D7	01 00	15 20	02 00
		4	BE EF	03 06 00	02 D6	01 00	15 20	03 00

RS-232C Communication (continued)

Command Data Chart (continued)

Names	Operation type	Header				Command data			
					CRC	Action	Type	Setting code	
V Position	Get	BE EF	03	06 00	0D 83	02 00	00 21	00 00	
	Increment	BE EF	03	06 00	6B 83	04 00	00 21	00 00	
	Decrement	BE EF	03	06 00	BA 82	05 00	00 21	00 00	
V Position Reset	Execute	BE EF	03	06 00	E0 D2	06 00	02 70	00 00	
H Position	Get	BE EF	03	06 00	F1 82	02 00	01 21	00 00	
	Increment	BE EF	03	06 00	97 82	04 00	01 21	00 00	
	Decrement	BE EF	03	06 00	46 83	05 00	01 21	00 00	
H Position Reset	Execute	BE EF	03	06 00	1C D3	06 00	03 70	00 00	
H Phase	Get	BE EF	03	06 00	49 83	02 00	03 21	00 00	
	Increment	BE EF	03	06 00	2F 83	04 00	03 21	00 00	
	Decrement	BE EF	03	06 00	FE 82	05 00	03 21	00 00	
H Size	Get	BE EF	03	06 00	B5 82	02 00	02 21	00 00	
	Increment	BE EF	03	06 00	D3 82	04 00	02 21	00 00	
	Decrement	BE EF	03	06 00	02 83	05 00	02 21	00 00	
H Size Reset	Execute	BE EF	03	06 00	68 D2	06 00	04 70	00 00	
Over Scan	Get	BE EF	03	06 00	91 70	02 00	09 22	00 00	
	Increment	BE EF	03	06 00	F7 70	04 00	09 22	00 00	
	Decrement	BE EF	03	06 00	26 71	05 00	09 22	00 00	
Over Scan Reset	Execute	BE EF	03	06 00	EC D9	06 00	27 70	00 00	
Color Space	Set	AUTO	BE EF	03	06 00	0E 72	01 00	04 22	00 00
		RGB	BE EF	03	06 00	9E 73	01 00	04 22	01 00
		SMPTTE240	BE EF	03	06 00	6E 73	01 00	04 22	02 00
		REC709	BE EF	03	06 00	FE 72	01 00	04 22	03 00
		REC601	BE EF	03	06 00	CE 70	01 00	04 22	04 00
	Get	BE EF	03	06 00	3D 72	02 00	04 22	00 00	
Component	Set	COMPONENT	BE EF	03	06 00	4A D7	01 00	17 20	00 00
		SCART RGB	BE EF	03	06 00	DA D6	01 00	17 20	01 00
	Get	BE EF	03	06 00	79 D7	02 00	17 20	00 00	
Video Format	Set	AUTO	BE EF	03	06 00	9E 75	01 00	00 22	0A 00
		NTSC	BE EF	03	06 00	FE 71	01 00	00 22	04 00
		PAL	BE EF	03	06 00	6E 70	01 00	00 22	05 00
		SECAM	BE EF	03	06 00	6E 75	01 00	00 22	09 00
		NTSC 4.43	BE EF	03	06 00	5E 72	01 00	00 22	02 00
		M-PAL	BE EF	03	06 00	FE 74	01 00	00 22	08 00
	N-PAL	BE EF	03	06 00	0E 71	01 00	00 22	07 00	
Get	BE EF	03	06 00	0D 73	02 00	00 22	00 00		
Frame Lock	Set	TURN OFF	BE EF	03	06 00	CB D6	01 00	14 30	00 00
		TURN ON	BE EF	03	06 00	5B D7	01 00	14 30	01 00
	Get	BE EF	03	06 00	F8 D6	02 00	14 30	00 00	
3D-YCS	Set	TURN OFF	BE EF	03	06 00	E6 70	01 00	0A 22	00 00
		NORMAL	BE EF	03	06 00	76 71	01 00	0A 22	01 00
		STILL IMAGE	BE EF	03	06 00	86 71	01 00	0A 22	02 00
	Get	BE EF	03	06 00	D5 70	02 00	0A 22	00 00	

RS-232C Communication (continued)

Command Data Chart (continued)

Names	Operation type		Header			Command data		
						CRC	Action	Type
Video NR	Set	LOW	BE EF	03 06 00	26 72	01 00	06 22	01 00
		MIDDLE	BE EF	03 06 00	D6 72	01 00	06 22	02 00
		HIGH	BE EF	03 06 00	46 73	01 00	06 22	03 00
		Get	BE EF	03 06 00	85 73	02 00	06 22	00 00
Progressive	Set	Turn off	BE EF	03 06 00	4A 72	01 00	07 22	00 00
		TV	BE EF	03 06 00	DA 73	01 00	07 22	01 00
		Film	BE EF	03 06 00	2A 73	01 00	07 22	02 00
		Get	BE EF	03 06 00	79 72	02 00	07 22	00 00
S2-Aspect	Set	TURN OFF	BE EF	03 06 00	1A 71	01 00	0B 22	00 00
		TURN ON	BE EF	03 06 00	8A 70	01 00	0B 22	01 00
		Get	BE EF	03 06 00	29 71	01 00	0B 22	00 00
Auto Adjust		Execute	BE EF	03 06 00	91 D0	06 00	0A 20	00 00
Auto off		Get	BE EF	03 06 00	08 86	02 00	10 31	00 00
		Increment	BE EF	03 06 00	6E 86	04 00	10 31	00 00
		Decrement	BE EF	03 06 00	BF 87	05 00	10 31	00 00
Auto Search	Set	TURN OFF	BE EF	03 06 00	B6 D6	01 00	16 20	00 00
		TURN ON	BE EF	03 06 00	26 D7	01 00	16 20	01 00
		Get	BE EF	03 06 00	85 D6	02 00	16 20	00 00
Blank Color	Set	Blue	BE EF	03 06 00	CB D3	01 00	00 30	03 00
		White	BE EF	03 06 00	6B D0	01 00	00 30	05 00
		Black	BE EF	03 06 00	9B D0	01 00	00 30	06 00
		Get	BE EF	03 06 00	08 D3	02 00	00 30	00 00
Blank on/off	Set	TURN OFF	BE EF	03 06 00	FB D8	01 00	20 30	00 00
		TURN ON	BE EF	03 06 00	6B D9	01 00	20 30	01 00
		Get	BE EF	03 06 00	C8 D8	02 00	20 30	00 00
Startup	Set	TURN ON	BE EF	03 06 00	0B D2	01 00	04 30	00 00
		TURN OFF	BE EF	03 06 00	9B D3	01 00	04 30	01 00
		Get	BE EF	03 06 00	38 D2	02 00	04 30	00 00
Menu Position V		Get	BE EF	03 06 00	40 D7	02 00	16 30	00 00
		Increment	BE EF	03 06 00	26 D7	04 00	16 30	00 00
		Decrement	BE EF	03 06 00	F7 D6	05 00	16 30	00 00
Menu Position V Reset		Execute	BE EF	03 06 00	A8 C7	06 00	44 70	00 00
Menu Position H		Get	BE EF	03 06 00	04 D7	02 00	15 30	00 00
		Increment	BE EF	03 06 00	62 D7	04 00	15 30	00 00
		Decrement	BE EF	03 06 00	B3 D6	05 00	15 30	00 00
Menu Position H Reset		Execute	BE EF	03 06 00	DC C6	06 00	43 70	00 00
Message	Set	TURN OFF	BE EF	03 06 00	8F D6	01 00	17 30	00 00
		TURN ON	BE EF	03 06 00	1F D7	01 00	17 30	01 00
		Get	BE EF	03 06 00	BC D6	02 00	17 30	00 00

RS-232C Communication (continued)

Command Data Chart (continued)

Names	Operation type	Header				Command data		
					CRC	Action	Type	Setting code
Volume	Get	BE EF	03	06 00	31 D3	02 00	01 20	00 00
	Increment	BE EF	03	06 00	57 D3	04 00	01 20	00 00
	Decrement	BE EF	03	06 00	86 D2	05 00	01 20	00 00
MUTE	Set	TURN ON	BE EF	03 06 00	46 D3	01 00	02 20	00 00
		TURN OFF	BE EF	03 06 00	D6 D2	01 00	02 20	01 00
	Get	BE EF	03	06 00	75 D3	02 00	02 20	00 00
Lamp Time	Get	BE EF	03	06 00	C2 FF	02 00	90 10	00 00
Lamp Time Reset	Execute	BE EF	03	06 00	58 DC	06 00	30 70	00 00
Filter Time	Get	BE EF	03	06 00	C2 F0	02 00	A0 10	00 00
Filter Time Reset	Execute	BE EF	03	06 00	98 C6	06 00	40 70	00 00
Magnify	Get	BE EF	03	06 00	7C D2	02 00	07 30	00 00
	Increment	BE EF	03	06 00	1A D2	04 00	07 30	00 00
	Decrement	BE EF	03	06 00	CB D3	05 00	07 30	00 00
Freeze	Set	Normal	BE EF	03 06 00	83 D2	01 00	02 30	00 00
		Freeze	BE EF	03 06 00	13 D3	01 00	02 30	01 00
	Get	BE EF	03	06 00	B0 D2	02 00	02 30	00 00
Power	Set	TURN OFF	BE EF	03 06 00	2A D3	01 00	00 60	00 00
		TURN ON	BE EF	03 06 00	BA D2	01 00	00 60	01 00
	Get	BE EF	03	06 00	19 D3	02 00	00 60	00 00
		(Example Return) 00 00 (Off) 01 00 (On) 02 00 (Cool down)						
Input Source	Set	COMPUTER	BE EF	03 06 00	FE D2	01 00	00 20	00 00
		Video	BE EF	03 06 00	6E D3	01 00	00 20	01 00
		S-Video	BE EF	03 06 00	9E D3	01 00	00 20	02 00
		Component	BE EF	03 06 00	AE D1	01 00	00 20	05 00
	Get	BE EF	03	06 00	CD D2	02 00	00 20	00 00
Error Status	Get	BE EF	03	06 00	D9 D8	02 00	20 60	00 00
		(Example of Return) 00 00 (Normal) 01 00 (Cover-error) 02 00 (Fan-error) 03 00 (Lamp-error) 04 00 (Temp-error) 05 00 (Air flow-error) 06 00 (Lamp-Time-over) 07 00 (Cool-error) 08 00 (Filter-Error) 09 00 (Filter-Missing)						

Free Manuals Download Website

<http://myh66.com>

<http://usermanuals.us>

<http://www.somanuals.com>

<http://www.4manuals.cc>

<http://www.manual-lib.com>

<http://www.404manual.com>

<http://www.luxmanual.com>

<http://aubethermostatmanual.com>

Golf course search by state

<http://golfingnear.com>

Email search by domain

<http://emailbydomain.com>

Auto manuals search

<http://auto.somanuals.com>

TV manuals search

<http://tv.somanuals.com>