

Instruction Manual

HITACHI
Inspire the Next

Washing Machine

Fully Automatic

Model

SF-170TCV
SF-160TCV
SF-150TCV
SF-140TCV
SF-130TCV



Thank you for purchasing a Hitachi fully automatic washing machine.

- Please read this Instruction Manual carefully for proper operation of the machine.
- Please keep this Instruction Manual for future reference.

Contents

Preparation for use

Environmentally Friendly Waste Disposal	2
Hints and Tips for Eco-friendly Washing	2
Safety Instructions	3
Installation.....	5
■ Parts and Accessories	5
■ Control Panel and Display.....	6
■ Before You Start Washing.....	8

Operation

How to Use the Washing Machine	9
Program Overview.....	15
List of Programs	16
■ Partial Operations Using the Normal Program..	20
In Case of Power Outage	23

Maintenance

Care and Maintenance	24
Troubleshooting	25
Error Codes.....	26
How to Install the Washing Machine	27
Customer Service	31
Specifications	31

For household use only

Environmentally Friendly Waste Disposal

Disposing of the packaging

The shipping package has protected your new washing machine on its way to your home. All materials are ecologically harmless and recyclable. Please contribute to a better environment by disposing of packaging materials in an environmentally conscious manner.

Ask your dealer about current means of disposal.

Risk of choking!

Do not let children play with packaging and associated parts.

There is a risk of suffocating on plastic bags and collapsible boxes.

Disposing of your old appliance

Old appliances are not worthless rubbish. Environment-conscious recycling can reclaim valuable new materials.

Risk of death!

Unplug the power plug from appliances you are no longer using. Cut off the power cord and dispose of it with the plug.

If you wish to discard this product, contact your local authorities or dealer and ask for the correct method of disposal.

Hints and Tips for Eco-friendly Washing

- Keep to the load limit of each program.
- This washing machine features power-saving operations with a built-in inverter controller which enables the machine to optimize operations according to the conditions of your clothes.
- Add detergent according to the degree of soiling, laundry size, and water hardness. Follow the detergent manufacturer's instructions regarding the amount of detergent to use.
- This washing machine has enhanced water-saving features such as Spin Shower Rinse and uses less water than former models. If you want to save more water, select the Water Save program using the Program button.

Safety Instructions

This washing machine is designed for home use only.

Before operating the washing machine, please read these safety instructions carefully.

WARNING

Issues which could cause death or serious injury.

General safety

- Do not dismantle, repair or modify the washing machine.
→ This could cause malfunction, fire, electric shock or injury.
→ Contact your local service center for repairs.
- Do not put fire sources or anything inflammable in or near the washing machine (gas, diesel, petroleum, thinner, alcohol, or clothes stained with these substances).
→ This could cause an explosion or fire.
- Do not pour water on the washing machine when it is running.
→ This could cause an electric shock.
- Do not climb on the washing machine. Do not place heavy object, drop any object or apply impact on the lid glass.
→ This could cause lid glass breakage. If any scratch or breakage is found on lid glass, stop using the washing machine and contact your local service center to request inspection and repair.
- It is a malfunction if the tub is still spinning when the lid lock is released and you can open the lid. If this happens, do not touch the laundry inside the tub and stop using the washing machine immediately. Contact your local service center for repair.
- This appliance is not intended for use by persons (including children) with reduced physical, sensory or mental capabilities, or lack of experience and knowledge, unless they have been given supervision or instruction concerning use of the appliance by a person responsible for their safety.

Installation

- Do not install the washing machine in an extremely humid place, such as a bathroom or a place exposed to rain.
→ Risk of fire, electric shock, current leakage, corrosion or product damage.
- Do not install the washing machine on a board with castors or on an unstable surface.
→ This may cause injury or malfunction due to abnormal vibration.
- The washing machine must be grounded if you use a two-pin plug adapter on the three-pin plug.
→ Not doing so could cause the electric shock, electronic substrate and electronic parts damage.
- Use a new water supply hose to connect the washing machine to the water tap.
- The opening must not be obstructed by carpeting if the washing machine is installed on a carpeted floor.

Power source and cord

- Do not insert or remove the power plug with wet hands.
→ This could cause an electric shock.
- Use the rated voltage. Do not connect other devices to the same outlet.
→ Using the washing machine and other electric appliances on the same outlet may cause the plug to overheat and result in fire.
- Clean off any dust on the power plug.
→ A dirty or dusty plug may cause a fire.
- Do not use an electric socket or outlet that is damaged or loose.
→ This could cause an electric shock, short circuit, or fire.
- Do not damage, cut, modify, bend, or fold the power cord.
→ This could damage the power cord and cause a fire or electric shock.
- Do not use an extension cord on the power cord.
→ This could cause overheating or fire.
- If the power cord is damaged, it must be replaced by a service agent or repair shop authorized by the manufacturer to avoid risks.

Safety Instructions

Child safety

- Keep packaging out of reach of children and infants.
→ Danger of suffocation.
- Do not let children climb onto the washing machine or to get into the tub. Do not leave boxes or chairs near the washing machine that children could use to climb onto it.
→ This may cause injury.
- Children should be supervised to ensure that they do not play with the appliance.

CAUTION

Issues which could cause injury or damage property.

General safety

- If there is a water outage or you remove the water supply hose and reattach it, close the tap and press the Start/Pause button, then wait 40 seconds and slowly open the tap.
→ Air pressure from a large amount of air in the water pipes could damage the washing machine.
- Periodically check that the union nut on the water supply hose is tight.
→ A loose nut may cause a water leak.
- Remove the power plug from the outlet and close the water tap if you will not use the washing machine for a long time.

Use

- All packaging materials must be removed before using the washing machine.
→ This could cause malfunction or abnormal vibration.
- Check inside the tub before operating the washing machine.
→ Check that no pets or small animals are in the tub.
- Do not wash items, such as raincoats, wet suits, ski suits, sleeping bags, cushions, pillows, shoes, shower curtain or other things, through which water does not flow easily.
→ The washing machine may not work properly, or it could cause injury or damage the washing machine.
- Do not fold and stack large items together, such as blankets, when washing them.
- Do not use a laundry net that is larger than 40 cm on a side.
→ The clothes may become off balance and cause abnormal vibration during the spin cycle.
- Do not load laundry over the lower part of the liquid load balancer (dotted line).
→ Doing so could cause laundry to fly out of the tub during the spin cycle and damage the clothes or the washing machine, or cause a water leak.
- Always put detergent into the detergent dispenser when washing laundry.
- Do not use water hotter than 50°C.
- Do not open the lid without using the Lid Open Button.
→ This may cause the damage of lid and lid open button.
- Do not wash items together with coins, pins, or stones.
→ This may damage clothes or the washing machine, or cause a water leak.
Check inside pockets before washing.
- Do not press the buttons with sharp pointed objects.
- Do not put heavy objects, liquid-filled containers or equipment which produces heat on the washing machine.
→ This may damage the washing machine or its top.

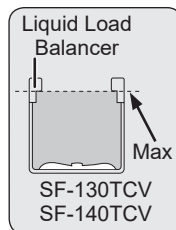
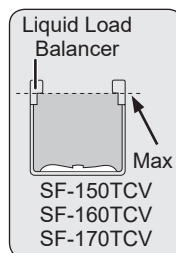

Care and maintenance

- If detergent, fabric softener or bleach spills on the surface of the machine, clean it up with a damp cloth immediately.
→ The plastic or steel parts of the washing machine may be damaged.
- Do not place equipment that produces heat near the washing machine.
→ This may cause deformation of the washing machine.

Parts and Accessories

Tub

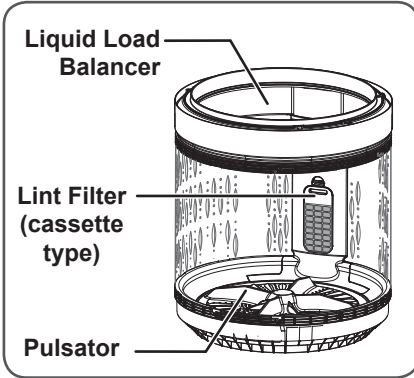

Dispenser

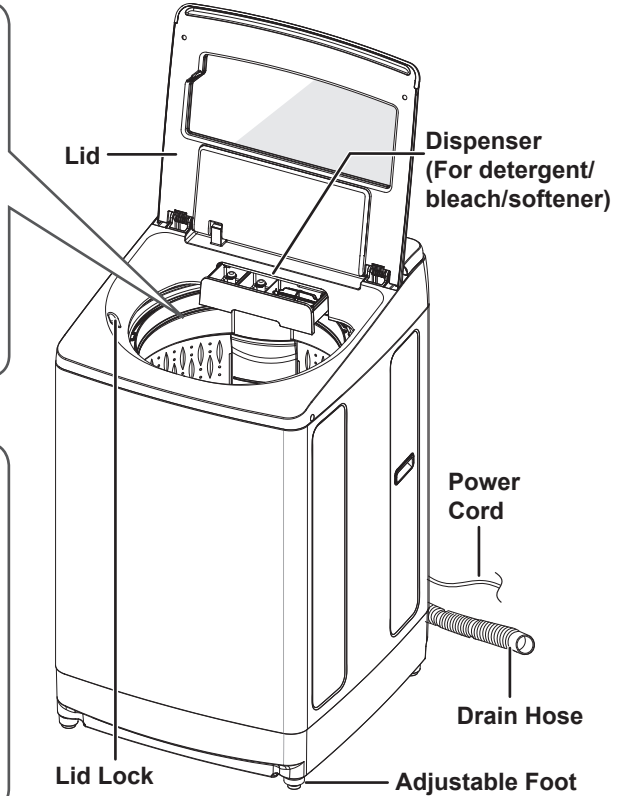
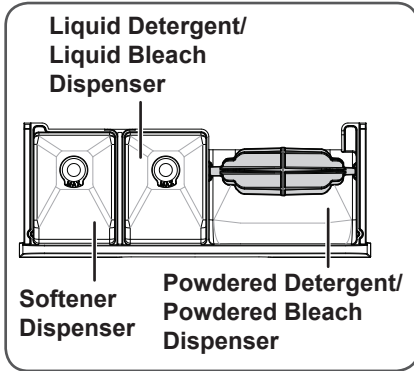

Accessories

Water Supply Hose and One-touch Joint

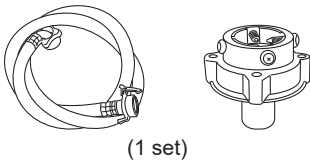

Foot Caps



Rat Guard

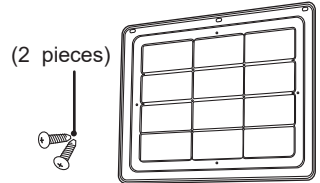

Optional accessories

Laundry Net



Refer to page 12
Part number PTSF-140JJS 001





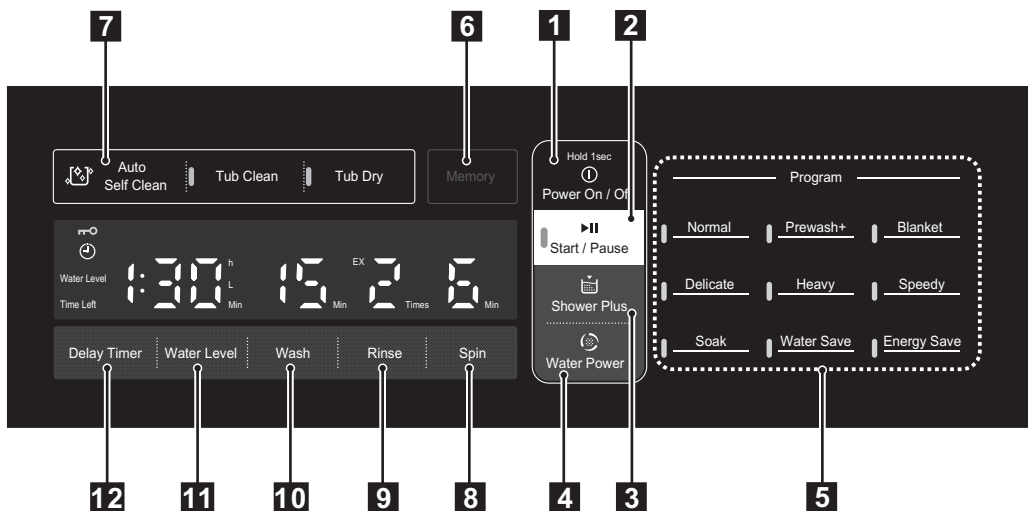

Control Panel and Display

While the washing machine is operating (lid closed)

NOTES



- Touch operation, touch the buttons directly with your bare finger.
- If Lid glass surface has water, detergent and so on, please clean-up them by using dry fabric.



<p>1 Power button</p> 	<p>Press this button to switch power on and off (when power on, please hold 1sec and display  MEMO is on). The washing machine automatically switches off when operations are finished. The washing machine also turns off automatically if it is not operated or no button is pressed for 10 minutes after the power has been turned on.</p>
<p>2 Start/Pause button</p> 	<p>Starts and pauses operation. When the washing machine is paused for over one hour and no operations are done, it turns off automatically.</p>
<p>3 Shower Plus button</p> 	<p>Supplies water to the tub when this button is pressed. Amount of water supplied depends on load amount or program. If you want to cancel water supply, press this button again. This function is available during the washing and normal rinsing processes. This button does not function if the water level has already reached highest level of each program.</p>
<p>4 Water Power button</p> 	<p>Changes the strength of the water flow. The strength of the water flow changes each time this button is pressed. Water flow strength is shown on the Water Level/Timer indicator. (0: normal, 1: strong, 2: stronger, -1: weak, -2: weaker) This function is available during the washing and normal rinsing processes.</p>
<p>5 Program button</p>	<p>Selects programs. The program changes each time the button is pressed.</p>
<p>6 Memory button</p>  <p>(SF-170TCV only)</p>	<p>Records the selected course, water level, wash time, rinse time and spin time when it is pressed for 3 seconds. To recall a recorded course, press this button after the washing machine is turned on.</p>

Control Panel and Display

While the washing machine is operating (lid closed)

<p>7 Auto Self Clean button</p> 	<p>Automatically cleans the outside of the tub and the inside of the outer tub to keep the washing machine clean. This setting is switched off at the time of shipment from the factory. Once switched on, the Auto Self Clean function operates every time you wash your laundry.</p>
<p>8 Spin button</p>	<p>Changes the spin time. The spin time can be set between 1 and 9 minutes.</p>
<p>9 Rinse button</p>	<p>Changes the rinse time.</p>
<p>10 Wash button</p>	<p>Changes the washing time. The washing time can be set between 3 to 24 minutes.</p>
<p>11 Water Level button</p>	<p>You can set the amount of Water each time you press the Water Level button.</p>
<p>12 Delay Timer button</p> 	<p>In the Delay Timer mode, the delay time can be set between 3 and 12 hours. Lights in the Delay Timer mode.</p>

Displays all cycle Information, remaining time and error codes.

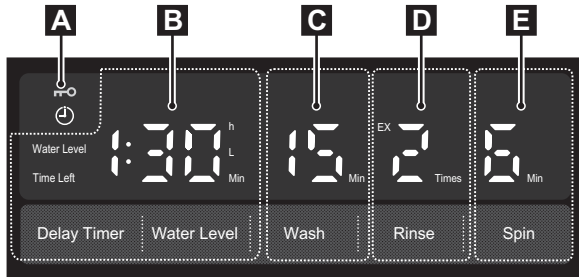

<p>A</p>	<p>Lid lock  The Lid is locked when the symbol is on.</p>
<p>B</p>	<p>Adjust the Water Level of program (Shows 'Water Level') Remaining time of the program (Shows 'Time Left')</p>
<p>C</p>	<p>Time of the Wash.</p>
<p>D</p>	<p>Time of the Rinse.</p>
<p>E</p>	<p>Time of the Spin.</p>

Before You Start Washing

Preparation of the laundry

- Remove any foreign objects (coins, safety pins, etc.).
- Put delicate clothes (knits, lingerie, etc.) in a net.
- Remove large lumps of lint, mud, sand, hair, and pet hair from laundry.
- Tie strings and close fasteners.



Sorting the laundry

- Sort laundry according to the type of fabric and care label symbols (cottons, blended fabrics, synthetics, wool, hand washable items, etc.).
- Do not wash extremely small loads, such as only a pair of jeans.
→ The clothes may become off balance and cause abnormal vibration during the spin cycle.
- Separate colored and white items.

Risk of injury!

Do not wash the following items, through which water does not flow easily, because doing so creates abnormal vibration during the spin cycle and could cause injury or malfunction.

- Waterproof items, such as a wet suit, ski suit, shower curtain, etc.
- Items with non-slip rubber backing, such as door mats.
- Cushions, pillows, shoes, etc.

Detergents and additives

- Use an appropriate amount of detergent according to the Detergent indicator on the washing machine. The type and amount of detergent depend on the type of fabric, volume, load size, degree of soiling, and hardness of the water used.
Use less detergent if:
 - The load is small.
 - The laundry is not very dirty.
- Too much detergent can result in excess foam, which reduces rinse efficiency or may cause a water leak.
- Depending on the detergent brand, detergent may not dissolve completely in the detergent tray if the water pressure is low or the water is too cold.
→ Page 24: Care and Maintenance
- When using softeners or bleaches, follow the instructions on the package.
- Detergent remained in drain route may be caused by quality of water or type of detergent. In case of repeatedly using under this condition, it may cause washer trouble.

* In case of unstable water pressure while washing machine working, it may cause the water remaining in Detergent and Softener box.

How to Use the Washing Machine

1 Sort the laundry

- Sort the laundry according to the type of fabric, care label symbol, and degree of soiling.
→ Page 8: Preparation of the laundry
- Do not exceed the maximum load.
- Laundry shall not exceed this line.
Otherwise, laundry may jump out from the wash tub while spinning and it may cause damage.

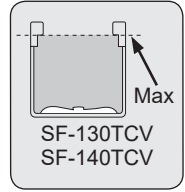
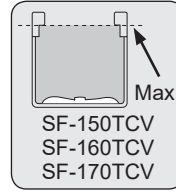

2 Press the Power button to turn on the power

- If no program is selected within 10 minutes, the washing machine automatically switches itself off.
Press the Power button again to turn on the power.

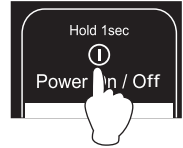

3 Select and adjust the program

- Select a program with the Program button.
→ Page 16: List of Programs
- You can change the combination or settings of wash, rinse, and spin operations with the Wash, Rinse, and Spin buttons.
- You can switch on the Auto Self Clean function with the Auto Self Clean button.
→ Page 11: How to use the Auto Self Clean function
→ Once switched on, the Auto Self Clean function operates every time you do your laundry.
Press the Auto Self Clean button again while the power is on to deactivate the function.

Set the operations

Select a function.

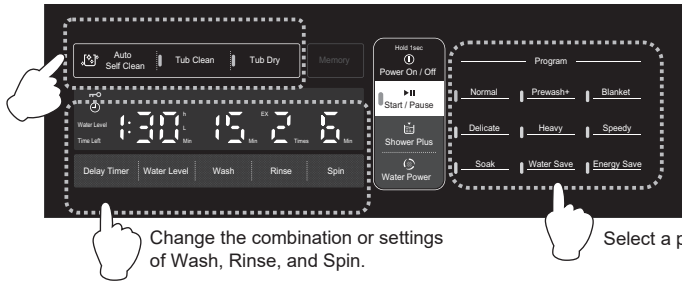

Change the combination or settings of Wash, Rinse, and Spin.

Select a program.

4 Press the Start/Pause button

- Before operation starts, the laundry is weighed, and the amount of detergent and water appear on the display.

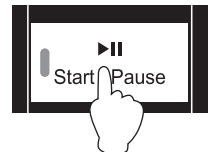

How to Use the Washing Machine

5 Put detergent into the detergent dispenser and close the lid

- Open the detergent dispenser, add the amount of detergent shown on the package, and then close the detergent dispenser.
- The amount of detergent is based on a single 35-gram scoop of powder detergent. Since the required amount of detergent varies depending on the type of detergent, follow the instructions on the package of detergent.
- For liquid detergent, follow the instructions on the package and add it to the liquid detergent/liquid bleach dispenser.
- Add softener to the softener dispenser according to the instructions on the package of softener. The softener is added to the tub automatically before the final rinse.
- For liquid bleach, follow the instructions on the package and add it to the liquid detergent/liquid bleach dispenser.
- The speed that the lid closes may vary, depending on the temperature, however, this is not abnormal.

Pausing a program:	Press the Start/Pause button. The washing machine will switch itself off if it is not restarted within 24 hours.
Adding clothes partway through a program:	Press the Start/Pause button to pause operation and add your clothes. The lid is locked while the tub is spinning, so wait until the tub stops completely and the lid lock is automatically released. After adding the clothes, close the lid and press the Start/Pause button to restart operation. * Note: It is not recommended to add a large amount of clothes as the washing machine first measures the load size to determine optimum operation.
Adding water partway through a program:	Press the Shower Plus button. Adds water when you press the button. Water stops being added when you press the button again or the maximum level is reached. * Note: This function cannot operate in the Tub Dry, Tub Clean, Blanket and Water Save Programs.
Changing strength of water flow:	Press the Water Power button. Repeatedly press the button to adjust the strength through five levels. * Note: This function operates in the Normal, Prewash+, Delicate, Speedy, Soak, and Water Save courses for washing and normal rinsing programs. Even if the indicator of strength changes, it may not change the strength according to the process or the load amount.
Terminating a program:	Press the Start/Pause button, and press the Power button to turn off the power.

How to Use the Washing Machine

6 Program ends

- The alarm sounds when a program ends.

The alarm can be deactivated or the sound can be changed in 5 types if the button of Water Level is pressed for at least 3 seconds.

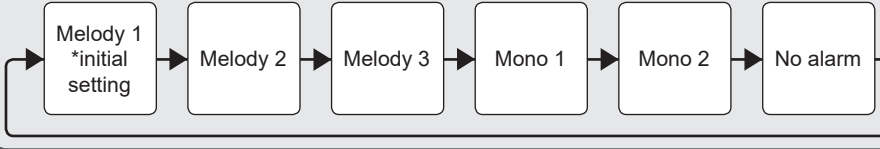

- The washing machine automatically switches off when the operations are finished.

How to use the Auto Self Clean function

- 1 Press the Power button to turn on the power.
- 2 Select a program.
- 3 Press the Auto Self Clean button.
- 4 Press the Start/Pause button.

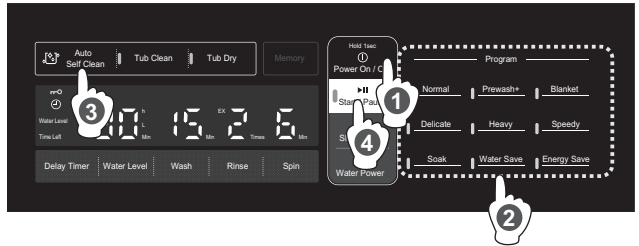

- When the Auto Self Clean function is running, about 14 more minutes and 10 more liters of water are needed.
- The setting is switched off at the time of shipment from the factory. Once switched on, the Auto Self Clean function operates every time you do your laundry.
- Prior to the final spin cycle, the outside of the tub, the back side of the pulsator, and the inside of the outer tub are washed to eliminate dirt and mold.
- To deactivate the Auto Self Clean function, press the Auto Self Clean button again while the power is on.

- The Auto Self Clean function runs just before the spin cycle begins in each program.
- The Auto Self Clean function runs even when the washing machine has started operation from rinsing.
- The Auto Self Clean function cannot be set or cancelled during operation.
- The Auto Self Clean function is automatically cancelled when:
 - The spin time is manually set to 1 minute.
 - Spin-only operation is set.
 - No spinning is set.
- Depending on the type and degree of dirt, some dirt may not be washed with the Auto Self Clean function.
- If the washing machine is seldom used, some dirt may not be washed with the Auto Self Clean function.
- To clean the tub more completely, we recommend using the Tub Clean program along with the Auto Self Clean function.

- The Auto Self Clean function is deactivated when one of the following programs is selected.
 - Blanket
 - Tub Dry
 - Tub Clean
- When the Auto Self Clean function is running, some water may flow out from the softener dispenser. This is the normal operation of the washing machine and does not indicate a malfunction.

How to Use the Washing Machine

How to use the Blanket program

① Prepare the laundry.

- Fold large items, such as quilts or blankets, as follows.
They should not be taller than 30 cm after they are folded.

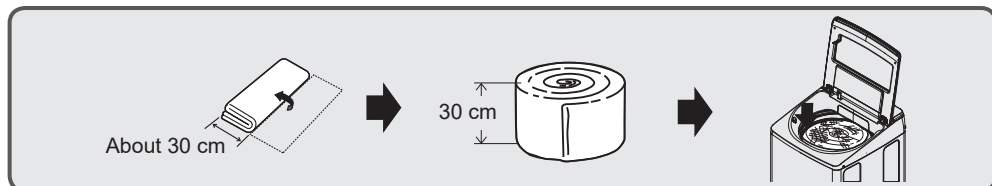

If it exceeds 30 cm, use a laundry net, which is sold separately.
(Laundry net: Product number PTSF-140JJS 001)



② Press the Power button to turn on the power.

③ Select the Blanket program.

④ Press the Start/Pause button.

⑤ Add detergent and close the lid.

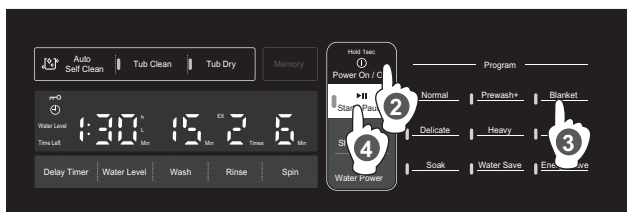

Items you can wash with the Blanket program

- Washable quilts

Machine washable quilts with synthetic (polyester) batting.

When not using the optional laundry net:

150 cm x 200 cm or smaller, and less than 1.5 kg

When using the optional laundry net:

174 cm x 225 cm or smaller, and less than 2 kg

(Laundry net: Product number PTSF-140JJS 001)

- Washable blankets

Up to 3 kg of synthetic blankets that are labeled as hand washable.

– For electric blankets, follow the instructions for the electric blanket.

- Other washable items

Mattress pads labeled as hand washable.

■ Do not fold and stack large items together, (such as sheets) when washing them.

→ The clothes may become off balance and cause abnormal vibration during the spin cycle.

How to Use the Washing Machine

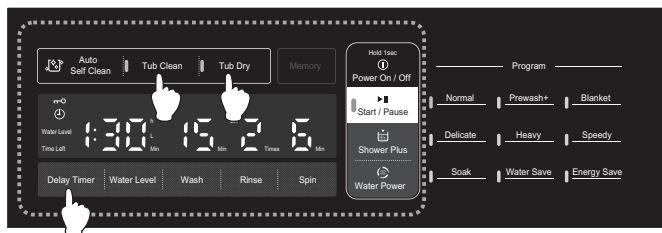

How to use the Tub Dry program

■ Use this program separately from other washing programs. (Do not put laundry into the tub.)

- 1 Press the Power button to turn on the power.
- 2 Select the Tub Dry program.
- 3 Close the lid and press the Start/Pause button.

■ The tub spins quickly the same as the regular spin cycle to remove the water from the tub.

How to use the Tub Clean program

■ Use this program separately from other washing programs. (Do not put laundry into the tub.)

- 1 Press the Power button to turn on the power.
- 2 Select the Tub Clean program.

■ The Tub Clean program can be set to 3 or 11 hours. At first, 11 hours is set. Press the Program button again to set 3 hours.

- 3 Close the lid, and press the Start/Pause button. The washing machine starts pouring water into the tub. (Close the lid when C3 is displayed)
- 4 Press the Start/Pause button and open the lid, add tub cleaner, according to the package, to the tub. (Liquid peroxide-based bleach is also effective as a tub cleaner. Since the required amount of bleach varies depending on the type of bleach, follow the instructions on the package of bleach.)
- 5 Close the lid, and press the Start/Pause button.

■ Water is added to the maximum level to wash away dirt you cannot see on the tub and outer tub. After that, Normal Rinse is performed twice to flush out any remaining dirt or tub cleaner.

How to use the Delay Timer

- 1 Press the Power button to turn on the power.
- 2 Select a program.
- 3 Press the Delay Timer button and select the time to finish washing. Each press of the button starting from 3 hours to 12 hours later.
- 4 Press the Start/Pause button.
- 5 Add detergent and close the lid. The power turns off after a short time.
- 6 Operations finish at the set time.

■ The Delay Timer is unavailable for the Blanket, Tub Dry, and Tub Clean programs.

■ To change the setting, press the Power button and do the settings again.

■ If there is a power outage while the timer is set, the timer setting is cancelled. If this happens, press the Power button again and reset the timer.

■ To prevent your laundry from wrinkling, remove it as soon as possible after washing is done.

How to Use the Washing Machine

How to use the Prewash+ program

- You can wash your heavily soiled laundry first, then add the regular laundry to wash off all together at a time. With a guidance of Beep sound which is generated in about 20 minutes after starting the operation, put additional laundry and detergent.

* Recommended amount of heavily soiled laundry is less than 2kg.

Additional amount of regular laundry should be less than 8kg.

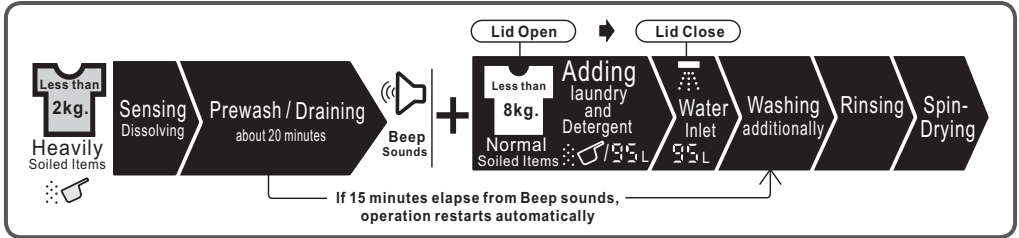

Operation:

- 1 Press the Power button to turn on the power.
- 2 Select the Prewash+ program.
- 3 Press the Start/Pause button.
- 4 Put the detergent and close the lid.
- 5 When the Beep sounds, open the lid to add the Laundry and Detergent. Then close the lid.

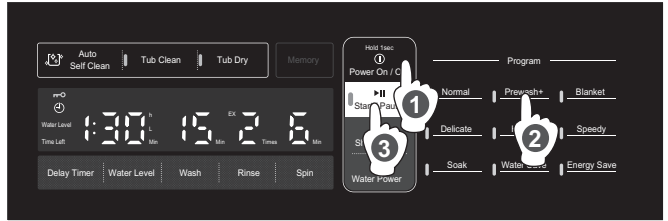

Others:

- Please put additional laundry and detergent within 15 minutes after the Beep sounds. If 15 minutes elapse from Beep sounds, operation restarts automatically.
- In this case, rinsing starts without adding washing cycle.

Program Overview

Program	Type of Laundry / Notes	Model / Max Load				
		170TCV	160TCV	150TCV	140TCV	130TCV
Normal	For daily washing of cotton and linen items such as shirts, underwear, towels, bed linen and table linen.	17 kg	16 kg	15 kg	14 kg	13 kg
Prewash+	Can wash your heavily soiled laundry first, then add the regular laundry to wash off all together at a time.	10 kg	10 kg	10 kg	10 kg	10 kg
Delicate	Gentle wash program for delicate items such as lingerie and thin lace curtains.	8.5 kg	8 kg	7.5 kg	7 kg	6.5 kg
Speedy	This lets you wash small loads of lightly soiled clothes and small items such as underwear.	8.5 kg	8 kg	7.5 kg	7 kg	6.5 kg
Soak	For washable large items and heavily soiled durable clothes.	13.6 kg	12.8 kg	12 kg	11.2 kg	10.4 kg
Blanket	For washable large items such as duvets, blankets, bedspreads, etc.	3 kg	3 kg	3 kg	3 kg	3 kg
Energy Save	Eco operation that saves energy that provides the same washing performance as the Normal program.	17 kg	16 kg	15 kg	14 kg	13 kg
Water Save	Eco operation that saves water that provides the same washing performance as the Normal program.	17 kg	16 kg	15 kg	14 kg	13 kg
Heavy	For washing heavily soiled durable clothes (jeans, sportswear, etc.)	17 kg	16 kg	15 kg	14 kg	13 kg

List of Programs

: Default settings

: Changeable settings (via corresponding button)

Program		Normal	Prewash+		Delicate	
			Pre	Add		
Maximum load	170TCV	17 kg	2 kg	8 kg	8.5 kg	
	160TCV	16 kg	2 kg	8 kg	8 kg	
	150TCV	15 kg	2 kg	8 kg	7.5 kg	
	140TCV	14 kg	2 kg	8 kg	7 kg	
	130TCV	13 kg	2 kg	8 kg	6.5 kg	
Amount of water	170TCV	33 to 107 L (adjusted automatically)	33 to 68 L	95 L	61 L	
		33 to 107 L		-	47 to 88 L	
	160TCV	33 to 105 L (adjusted automatically)	33 to 68 L	94 L	61 L	
		33 to 105 L		-	47 to 88 L	
	150TCV	33 to 103 L (adjusted automatically)	33 to 68 L	93 L	61 L	
		33 to 103 L		-	47 to 88 L	
	140TCV	33 to 101 L (adjusted automatically)	33 to 68 L	92 L	61 L	
		33 to 101 L		-	47 to 87 L	
	130TCV	33 to 99 L (adjusted automatically)	33 to 68 L	90 L	61 L	
		33 to 99 L		-	47 to 86 L	
	Wash	15 min		45 min		6 min
		3, 9, 12, 15, 18, 24 min, or none		-		-
Rinse	Spin Shower Rinse 2 times + Normal Rinse 1 time (In case of laundry exceeds 80%, the process will be Spin Shower Rinse 1 time and Normal Rinse 1 time.)		Normal Rinse 2 times	Normal Rinse 1 time		
	Normal Rinse 2 times, Water-Injection Rinse 2 times, Normal Rinse 3 times, Water-Injection Rinse 3 times, none, Normal Rinse 1 time, or Water-Injection Rinse 1 time		Normal Rinse 1 time, Water-Injection Rinse 1 time, Normal Rinse 2 times, Water-Injection Rinse 2 times, Normal Rinse 3 times, Water-Injection Rinse 3 times, or none			
Spin	Time	6 min			3 min	
		1, 3, 6, 9 min, or none			1, 3, 6, 9 min, or none	
Required time (guide)	170TCV	46 to 79 min	63 to 99 min		35 min	
	160TCV	46 to 79 min	63 to 99 min		35 min	
	150TCV	46 to 79 min	63 to 99 min		35 min	
	140TCV	46 to 79 min	63 to 99 min		35 min	
	130TCV	46 to 79 min	63 to 99 min		35 min	

List of Programs

: Default settings

: Changeable settings (via corresponding button)

Program		Speedy	Soak				Blanket
			0.5 hrs	1 hrs	3 hrs	5 hrs	
Maximum load	170TCV	8.5 kg	13.6 kg				3 kg
	160TCV	8 kg	12.8 kg				3 kg
	150TCV	7.5 kg	12 kg				3 kg
	140TCV	7.5 kg	11.2 kg				3 kg
	130TCV	7 kg	10.4 kg				3 kg
Amount of water	170TCV	54 L	33 to 107 L (adjusted automatically)				107 L
		33 to 88 L	33 to 107 L				88 to 107 L
	160TCV	54 L	33 to 105 L (adjusted automatically)				107 L
		33 to 88 L	33 to 105 L				88 to 107 L
	150TCV	54 L	33 to 103 L (adjusted automatically)				107 L
		33 to 88 L	33 to 103 L				88 to 107 L
	140TCV	54 L	33 to 101 L (adjusted automatically)				103 L
		33 to 87 L	33 to 101 L				87 to 103 L
130TCV	54 L	33 to 99 L (adjusted automatically)				103 L	
	33 to 86 L	33 to 99 L				86 to 103 L	
Wash		3 min	30 min	60 min	180 min	300 min	25 min
		3, 9, 12, 15, 18, 24 min, or none	-	-	-	-	-
Rinse		Normal Rinse 1 time	Normal Rinse 2 times				Normal Rinse 2 times
		Normal Rinse 1 time, Water-Injection Rinse 1 time, Normal Rinse 2 times, Water-Injection Rinse 2 times, Normal Rinse 3 times, Water-Injection Rinse 3 times, or none	Normal Rinse 2 times, Water-Injection Rinse 2 times, Normal Rinse 3 times, Water-Injection Rinse 3 times, or none, Normal Rinse 1 time, or Water-Injection Rinse 1 time				-
Spin	Time	3 min	6 min				9 min
		1, 3, 6, 9 min, or none	1, 3, 6, 9 min, or none				
Required time (guide)	170TCV	31 min	70 to 83 min	100 to 113 min	220 to 233 min	340 to 353 min	77 min
	160TCV	31 min	70 to 83 min	100 to 113 min	220 to 233 min	340 to 353 min	77 min
	150TCV	31 min	70 to 83 min	100 to 113 min	220 to 233 min	340 to 353 min	77 min
	140TCV	31 min	70 to 83 min	100 to 113 min	220 to 233 min	340 to 353 min	77 min
	130TCV	31 min	70 to 83 min	100 to 113 min	220 to 233 min	340 to 353 min	77 min

List of Programs



: Default settings

: Changeable settings (via corresponding button)

Program		Energy Save	Water Save	Heavy	
Maximum load	170TCV	17 kg	17 kg	17 kg	
	160TCV	16 kg	16 kg	16 kg	
	150TCV	15 kg	15 kg	15 kg	
	140TCV	14 kg	14 kg	14 kg	
	130TCV	13 kg	13 kg	13 kg	
Amount of water	170TCV	33 to 107 L (adjusted automatically)	33 to 101 L (adjusted automatically)	33 to 107 L (adjusted automatically)	
		33 to 107 L	33 to 101 L	33 to 107 L	
	160TCV	33 to 105 L (adjusted automatically)	33 to 100 L (adjusted automatically)	33 to 105 L (adjusted automatically)	
		33 to 105 L	33 to 100 L	33 to 105 L	
	150TCV	33 to 103 L (adjusted automatically)	33 to 98 L (adjusted automatically)	33 to 103 L (adjusted automatically)	
		33 to 103 L	33 to 98 L	33 to 103 L	
	140TCV	33 to 101 L (adjusted automatically)	33 to 97 L (adjusted automatically)	33 to 101 L (adjusted automatically)	
		33 to 101 L	33 to 97 L	33 to 101 L	
	130TCV	33 to 99 L (adjusted automatically)	33 to 94 L (adjusted automatically)	33 to 99 L (adjusted automatically)	
		33 to 99 L	33 to 94 L	33 to 99 L	
	Wash		48 min	15 min	18 min
			-	3, 9, 12, 15, 18, 24 min, or none	12, 15, 18, 21, 24 min, or none
Rinse		Spin Shower Rinse 2 times + Normal Rinse 1 time (In case of laundry exceeds 80%, the process will be Spin Shower Rinse 1 time and Normal Rinse 1 time.)	Water-Injection Rinse 2 times	Normal Rinse 2 times	
		-	Normal Rinse 2 times, Water-Injection Rinse 2 times, Normal Rinse 3 times, Water-Injection Rinse 3 times, none, Normal Rinse 1 time, or Water-Injection Rinse 1 time		
Spin	Time	5 min	6 min	6 min	
		-	1, 3, 6, 9 min, or none		
Required time (guide)	170TCV	88 to 100 min	42 to 75 min	52 to 78 min	
	160TCV	83 to 100 min	42 to 75 min	52 to 78 min	
	150TCV	83 to 100 min	42 to 75 min	52 to 78 min	
	140TCV	83 to 100 min	42 to 75 min	52 to 78 min	
	130TCV	83 to 100 min	42 to 75 min	52 to 78 min	

List of Programs



- The wash time and the spin time may change during the program depending on the weight and type of laundry being washed.
- The required times are guidelines. More time may be required than is noted here depending on the water pressure and the type of laundry.
- Programs cannot be changed after they are started. To change them, turn the power off and then on again, then select a program.
- When the Auto Self Clean function is running, about 14 more minutes and 10 more liters of water are needed.
- We do not recommend using fabric softener when the Water Save program is selected.
- The Water Save program cycle is the recommended program cycle for a normally soiled load of laundry at the rated capacity.
- Spin Shower Rinse* is used in the Normal and Energy Save programs to enhance water-saving performance without compromising the efficiency of rinsing.
* Spin Shower Rinse: A powerful shower and centrifugal force rinse out detergent more effectively.
- The clear part of the lid and control panel may become foggy or may form dew on the edge of lid if you use hot water to wash your laundry, however, this is not abnormal. Wipe it off after washing your laundry.
- It has the potential not to be enough for max load according to the kind of clothes.
- Even if you set the delay timer, it may start soon according to the required time of the program.
- Water flow is adjusted automatically according to the amount of load and water level. When loads are heavy and water level are high, water flow is adjusted at slower rate to maintain the performance of washer.
- Amount of detergent is indicated according to following table as a guide.

Load (guide) 	Water Level 	Amount of detergent 	
8~17 kg	88~107 L	72 g	(SF-170TCV)
8~16 kg	88~105 L		(SF-160TCV)
8~15 kg	88~103 L		(SF-150TCV)
8~14 kg	88~101 L		(SF-140TCV)
8~13 kg	88~99 L		(SF-130TCV)
4~7 kg	68~82 L	46~55 g	
0~3 kg	33~61 L	22~41 g	

* The amount of detergent is based on a type of 20-gram per 30-liter.

Since the required amount of detergent varies depending on the type of detergent, follow the instructions on the package of detergent.

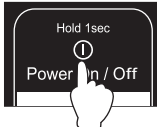
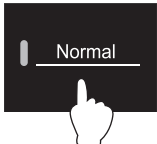
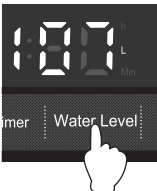
Partial Operations Using the Normal Program

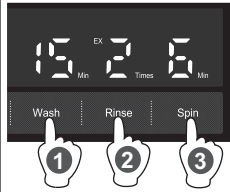
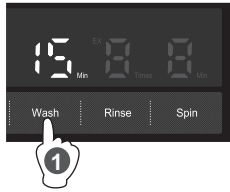
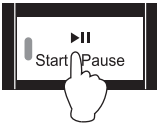
If you want...	To customize the wash program	To reuse the wash water and separate your laundry	To not spin the laundry because you are worried about wrinkles
Operations	Wash → Rinse → Spin	Wash only	Wash → Rinse
Setting method			
1.		Turn on the power.	
2.		Select the Normal program.	
3.		Set the amount of water. If you do not set the amount of water, it is set automatically based on the weight of the laundry.	
4.	 <p>Set the operations</p>	 <ol style="list-style-type: none"> 1 Set the wash time with the Wash button. 2 Set the number and type of rinses with the Rinse button. 3 Set the spin time with the Spin button. 	 <ol style="list-style-type: none"> 1 Set the wash time with the Wash button. 2 Set the number and type of rinses with the Rinse button.
5.		Press the Start/Pause button to start.	
Remarks	Operates according to the wash, rinse, and spin settings.	Stops while the wash water is still in the tub.	Stops while the rinse water is still in the tub.

Partial Operations Using the Normal Program

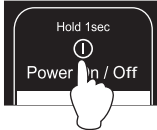
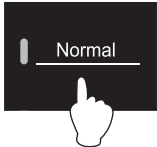
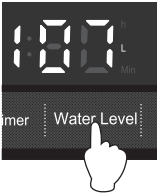
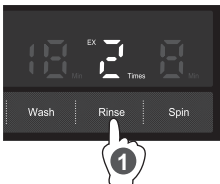
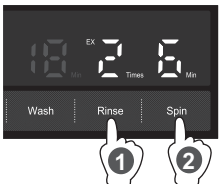
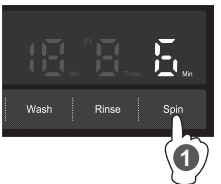
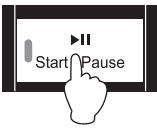
If you want...	To rinse only	To rinse and spin	To drain and spin
Operations	Rinse only	Rinse ⇨ Spin	Drain ⇨ Spin
Setting method			
1.	 <p>Turn on the power.</p>		
2.	 <p>Select the Normal program.</p>		
3.	 <p>Set the amount of water. If the amount of water is not set, then maximum water level is used.</p>		Cannot be used.
4.	 <p>① Set the number and type of rinses with the Rinse button.</p>	 <p>① Set the number and type of rinses with the Rinse button. ② Set the spin time with the Spin button.</p>	 <p>① Set the spin time with the Spin button.</p>
5.	 <p>Press the Start/Pause button to start.</p>		
Remarks	Drains water and spins before rinsing. Stops while the rinse water is still in the tub.	Drains water and spins before rinsing.	Drains water and spins.

Partial Operations Using the Normal Program

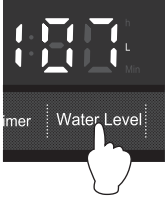

- Repeatedly press the Water Level buttons until the wash, rinse, and spin settings you want are set.
If the indicator is not lit, that operation is not performed.

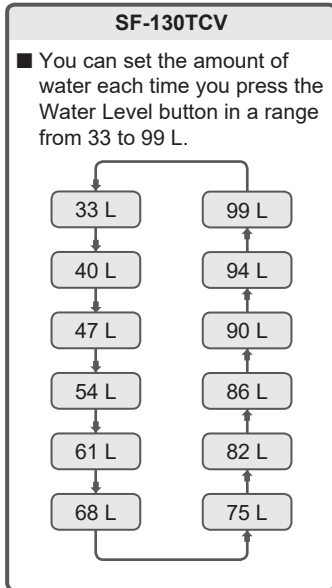
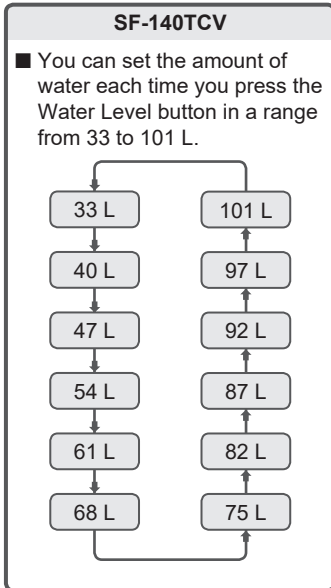
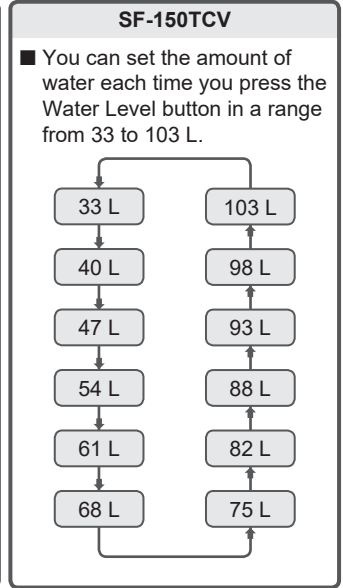
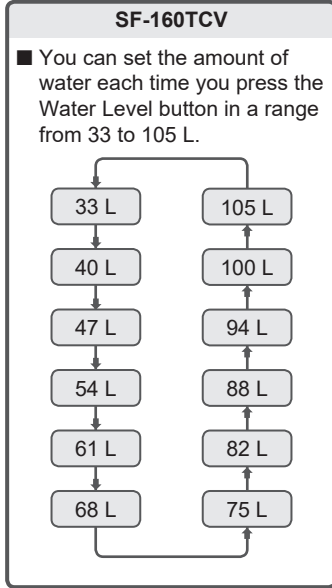
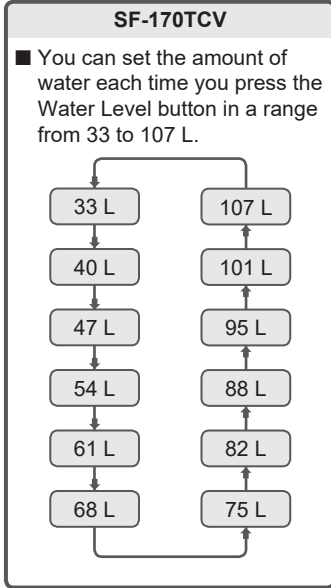

Partial Operations Using the Normal Program

- You can set the wash time each time you press the Wash button in a range from 3 to 24 minutes and no washing.

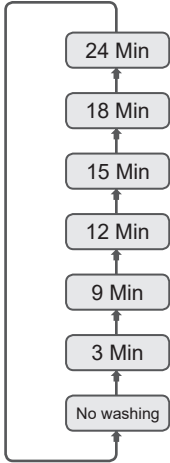
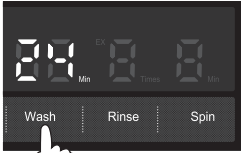

- You can set the number and type of rinses by pressing the Rinse button. Each time you press the Rinse button the setting changes in sequence, from Water-Injection Rinse 2 times, Normal Rinse 2 times, Water-Injection Rinse 1 time, Normal Rinse 1 time, no rinsing, Water-Injection Rinse 3 times, Normal Rinse 3 times.

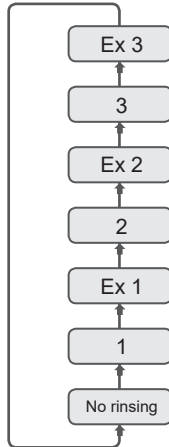

- You can set the spin time each time you press the Spin button in a range of 1 to 9 minutes and no spinning.

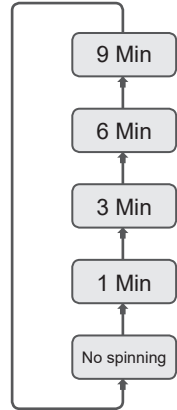

In Case of Power Outage

If there is a power outage

The washing machine is equipped with a restart function.

If a power outage occurs while the washing machine is operating, the cycle (i.e., wash, rinse, or spin) at that time is saved, and when the power is restored, automatically restart from the interrupted cycle.

If there is a power outage during the operation, the lid is locked and cannot be opened. After the power is restored, the lock is released.

Care and Maintenance

Cleaning the lint filter (cassette type)

- 1 Press down on the knob on the top of the lint filter (cassette type) and pull it towards you.
- 2 Open the lint filter (cassette type) to the sides and remove the lint that is inside.
- 3 Reverse the procedure to replace the lint filter (cassette type).

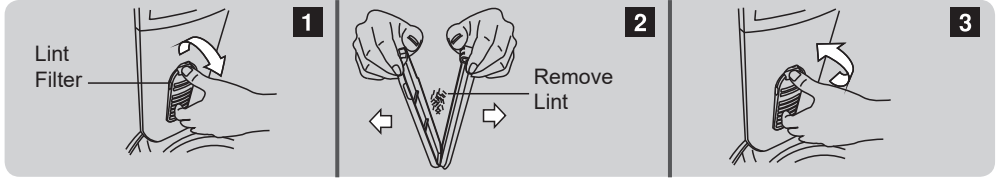

Cleaning the dispenser

- 1 Pull the dispenser and tilt it upwards to remove it.
- 2 Pull off the caps and Easy Dissolver.
- 3 Use a brush or something to clean the parts.
- 4 To remount, tilt the dispenser, align the rib to guide and insert it.

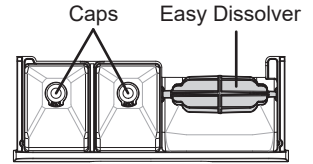

- When you replace the caps, press it until it stops completely. If it is not pressed all the way in, the softener, liquid detergent and liquid bleach will not be added to the tub completely and some will remain in the dispenser.

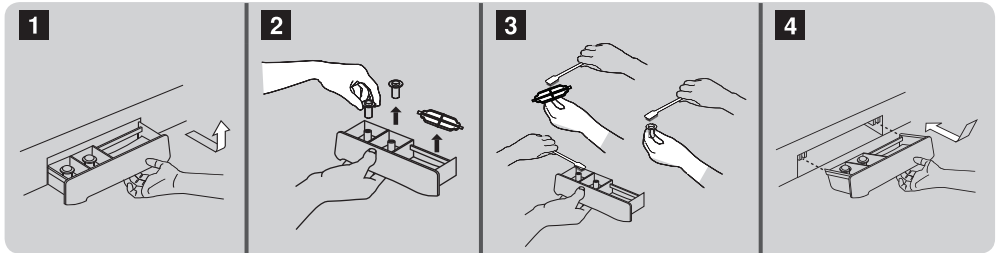

Cleaning the water supply inlet

- 1 Close the tap.
- 2 Disconnect the water supply hose from the top of the washing machine. (Water in the hose may be drained when you disconnect the hose.)
- 3 Use a brush or something to clean the water supply inlet of the washing machine.
- 4 Reverse the procedure to replace the water supply hose.

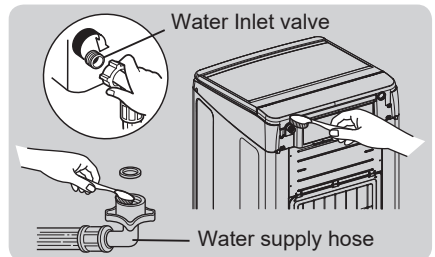

Care and maintenance of the washing machine

- Clean the machine body.
- Wipe the outside of the washing machine with a soft cloth. Do not use solvents such as alcohol or benzene.
- If you use a chemically treated cloth, use it according to the instructions for the product.
- If detergent or softener gets on the washing machine, quickly wipe it off. The surface could be damaged.

Troubleshooting

Problem	Thing to check	Instructions
Does not operate	Is the power plug not inserted in the power outlet?	Insert in the power outlet.
	Is a power outage?	Check your other product in your home.
	Is the Delay Timer set?	Please check this function.
It is wet, even though it is the first time to use it (drain hose, tub, etc.)	Is moisture or water left in the tub or hoses from the performance test before shipping from the factory?	Clean by soft cloth and use "Tub Dry" function for Tub drying.
The remaining time increases during operation	Is remaining time adjusted to compensate for the speed of the incoming water?	Adjust water volume to high speed.
Water is added again during the washing process	Is water added automatically up to the set water level if the water level falls because water is absorbed by the laundry?	During operating is normal case.
Wash time is longer than the time that was set manually	Is the water pressure low?	The operating time may increase due to a longer water supply time.
The washing machine stops during the spin cycle and starts adding water	Are clothes unbalance?	If the laundry is extremely off balance when the spin cycle starts, the spin cycle stops and the rinse cycle starts to rebalance the laundry. After the load is rebalanced, the spin cycle starts again.
The lid does not open	Is the lid locked?	When the lid lock indicator cannot be opened.
		Cannot be opened because there was a power outage or the power was turned off while the lid lock indicator was lit. Turn on the power and wait for the lock to be released.

Error Codes

Error code	Description	Things to check	Solution
E0	Laundry overload	Check if the laundry overloaded?	Decrease the amount of laundry according to the instructions on page 15.
E1	Water is not supplied	Is the tap open?	Check the tap, water supply inlet filter, water pipes, and water supply hose.
		Has dirt collected in the water supply inlet filter?	
		Are the water pipes or water supply hose frozen?	
		Has the water supply been disrupted?	
E2	Water does not drain	Is the drain hose blocked?	Check the drain hose and the drain outlet.
		Is the drain hose twisted, crushed, or frozen?	
		Is the drain hose connected correctly?	
		Is the drain outlet too high?	
E3	The tub does not spin	Is the lid open?	Close the lid.
E4		Is the laundry all on one side of the tub?	Add a few more items to wash. (If there is only one item in the tub, it is likely to become unbalanced.)
		Does the laundry include too many thick items like cotton blankets or jeans or too many large items like sheets?	
		Is the washing machine wobbling, or is the floor under the washing machine slanted?	
		Are there any unwashable things in the tub? →Page 8: Preparation of the laundry (sorting the laundry)	
E8	The lid cannot be locked	Is the lid closed?	Check that the lid is completely closed. Check that there are no foreign objects in the lock.
		Are there any foreign objects in the lock?	
E9	The lid lock cannot be released	Are there any foreign objects in the lock?	Turn the power off and then on again and wait a little while. If the lid is still locked, contact a service center for repair.
Eh	The spinning speed does not reach the specified value.	Check if there is too much detergent?	Check the amount of powder detergent used. Check the drain hose and its installation.
		Check if the drain hose is clogged?	
		Check if the drain hose is installed correctly?	

■ If warning sign such as “F0”, “F9”...etc. are shown in the display, stop operating the washer immediately and contact an authorized service dealer or a service agent for further inspection and/or repairing.

How to Install the Washing Machine

Safety precautions

- Do not use a damaged power plug, doing so is dangerous. Contact a repair center that is certified by the manufacturer to replace the plug.
- If the outlet you are using is a 2-pin outlet, use an adapter to change from three pins to two pins. If you do this, be sure to connect an earth wire. There are risk of electric shock, electronic substrate and electronic parts damage if you do not connect an earth wire.
- Do not connect an earth wire to a gas pipe, telephone wire, water pipe, or lightning rod. Remove the power plug from the electric outlet when you are attaching an earth wire.
- You do not need to attach an earth wire if the electric outlet is a 3-pin type with earth terminal.

Where to install the washing machine

- The hoses may be damaged or rupture if they freeze. Do not install the washing machine outside or any other place where there is a risk of freezing.
- Install the washing machine on a solid level floor to avoid excessive vibration and noise.
- Do not install the washing machine in an extremely humid place, such as a bathroom or a place exposed to rain.
- Do not install the washing machine in a slippery or unstable location. Doing so could cause abnormal vibration.
- Install the washing machine away from walls as shown below to avoid abnormal noise and vibration.

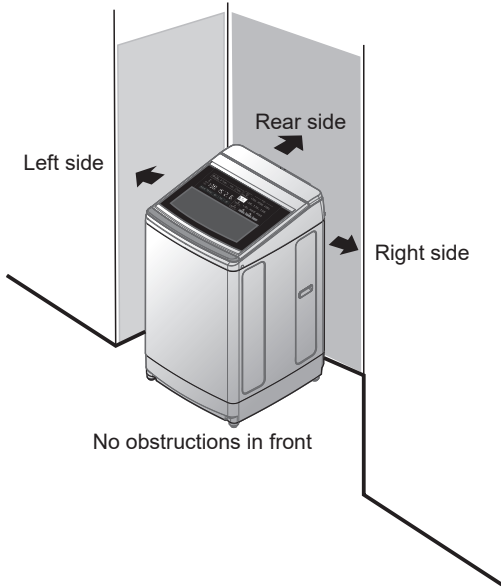

Area	Clearance (cm)
Left	1.5*
Right	1.5*
Rear	Should be 10 cm or more for the rear with the Water Supply Hose.

* Should be 9 cm or more for the side with the drain hose.

How to Install the Washing Machine

Installing the drain hose

- 1 Lay the washing machine down on its back.
- 2 Pull the drain hose out of the washing machine.
- 3 Insert the narrow part of the drain hose into the clamp on the washing machine.
- 4 Stand the washing machine up.

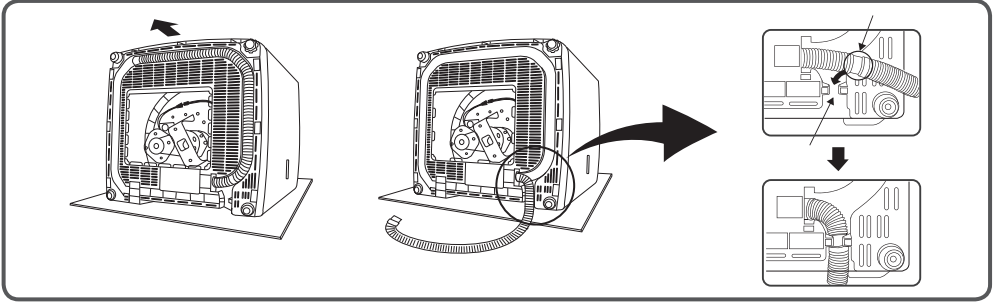

- 5 Insert the end of the drain hose into the drain channel.

- Do not allow the drain hose to be bent, twisted, pulled out and damaged, stepped on, or crimped.
- Spread a cloth on the ground before laying the washing machine down on its back to prevent damaging it.
- Use a knife to cut the end of the drain hose at a 45 degree angle because if the drain channel is shallow and the end of the drain hose is blocked, it could cause a malfunction.

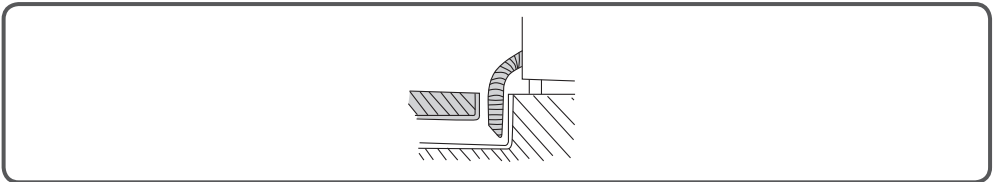

- Keep the top of the drain hose no more than 10 cm above the floor if it crosses a door sill or something else. If it is higher than this, the water has difficulty draining and a "C2" error (water does not drain) may occur.
- Do not extend the drain hose more than 2 meters from the washing machine.

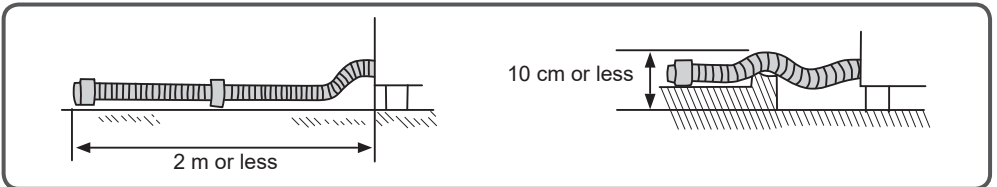



How to Install the Washing Machine

Connecting to the tap

- Water supply hose

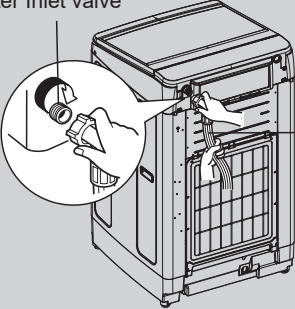

- The optimum water pressure is 0.03 to 0.8 MPa.

<p>Horizontal tap</p>  <p>Extension tap</p> 	<p>Water Inlet valve</p>  <p>Water supply hose</p> <ul style="list-style-type: none">■ Check that the rubber seal is in the hose connector.■ Connect the water supply hose to the water supply inlet on the washing machine.
--	--

- Water supply hose with one-touch joint

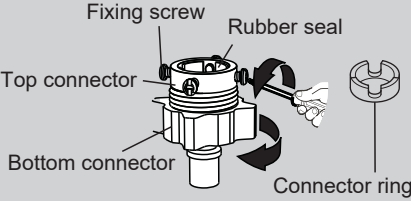
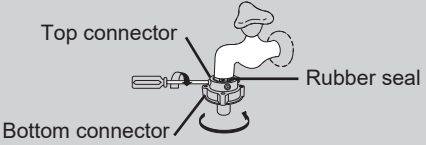
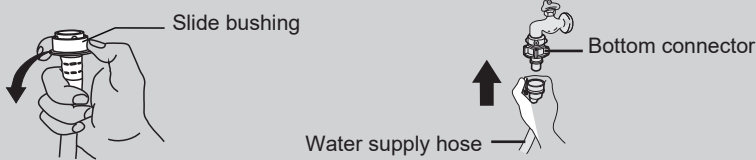

<p>1. Loosen the top connector.</p>  <ul style="list-style-type: none">• If the diameter of the tap is larger than the connector ring, remove the ring.	<p>2. Press up on the top connector so the rubber seal and the tap are firmly sealed. Next, tighten the 4 screws.</p>  <ul style="list-style-type: none">• Rotate the bottom connector so there is no water leakage.• Close the tap so you can remove the water supply hose from the bottom connector. Next, pull off the hose and lower the clasp.
<p>3. Attach the water supply hose to the bottom connector and lower the clasp.</p> 	

- Make sure the union nut between the water supply hose and the washing machine is firmly tightened.
- Before operating the washing machine, open the tap to confirm that the water supply hose is correctly connected. If the union nut is loose water will leak.

How to Install the Washing Machine

Connecting the power

- Connect the washing machine correctly to a grounded AC power supply.
- The voltage of the power supply must match the voltage rating of the washing machine.
- Do not use extension cords or overload the power outlet by using power strips.

Checking levelness

1. Check the center of tub

- Set the Washing Machine at the operating area.
- After set the Washing Machine, to check the center of tub.
- In the case of center of tub difference between Left and Right too large, re-adjust the leg of Washing Machine.

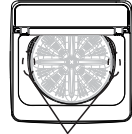

Check the difference between left and right

Note : If the tub is not center, it may cause of the Washing Machine vibration or abnormal operation.

Adjustable leg
Foot Caps

Loosen lock nut
Lock nut

Adjust leg height
Adjustable leg
Raise this leg
Lower this leg

Tighten lock nut
Lock nut

- Rotate the lock nut in the direction of the arrow to loosen it and then rotate the adjustable leg to stabilize the Washing Machine.
- When the adjustment is finished, rotate the lock nut in the direction of the arrow to tighten it.

2. Check the horizontal level

Following the figure, attach the weight at the end of thread and drop down, can check by simplicity.

If show the same gap between A and that is the horizontal level ± 5 mm

* Because the misalignment of Tub may due to setting environment, it is important to adjust the center of Tub.

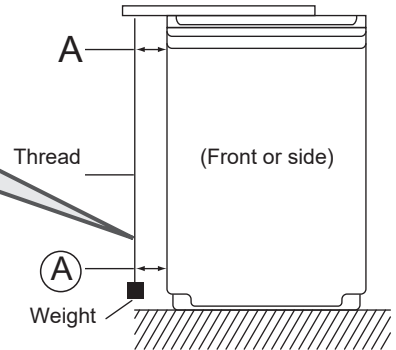

Checking after installation

If any of the following problems or other abnormalities occur, immediately unplug the power plug and contact your local service center.

- The washing machine does not operate when the power is turned on.
- The power cord is damaged.
- There are abnormal vibrations or sounds during operation.
- There is a smell of burning.

Customer Service

If the washing machine malfunctions, check the Instruction Manual thoroughly before you call for repairs.

If you are unable to identify or solve the problem, contact your local service center.

When you call the service center, you will need to tell them the model of the washing machine, describe the malfunction, and give them your address and phone number.

Specifications

Model	SF-170TCV
Power supply	See the rating plate on the back of the washing machine.
Standard water level	107 L (maximum water level)
Standard amount of water used	195 L (Normal program)
Water pressure	0.03 to 0.8 MPa (0.3 to 8 Kgf/cm ²)
Dimensions	Width 640 mm x Depth 696 mm x Height 1080 mm
Weight	49 kg

Model	SF-160TCV	SF-150TCV
Power supply	See the rating plate on the back of the washing machine.	
Standard water level	105 L (maximum water level)	103 L (maximum water level)
Standard amount of water used	190 L (Normal program)	185 L (Normal program)
Water pressure	0.03 to 0.8 MPa (0.3 to 8 Kgf/cm ²)	
Dimensions	Width 640 mm x Depth 696 mm x Height 1080 mm	
Weight	49 kg	

Model	SF-140TCV	SF-130TCV
Power supply	See the rating plate on the back of the washing machine.	
Standard water level	101 L (maximum water level)	99 L (maximum water level)
Standard amount of water used	180 L (Normal program)	175 L (Normal program)
Water pressure	0.03 to 0.8 MPa (0.3 to 8 Kgf/cm ²)	
Dimensions	Width 640 mm x Depth 696 mm x Height 1040 mm	
Weight	48 kg	

Free Manuals Download Website

<http://myh66.com>

<http://usermanuals.us>

<http://www.somanuals.com>

<http://www.4manuals.cc>

<http://www.manual-lib.com>

<http://www.404manual.com>

<http://www.luxmanual.com>

<http://aubethermostatmanual.com>

Golf course search by state

<http://golfingnear.com>

Email search by domain

<http://emailbydomain.com>

Auto manuals search

<http://auto.somanuals.com>

TV manuals search

<http://tv.somanuals.com>