

# HITACHI

## Video Deck



 As an ENERGY STAR® Partner, our company has determined that this product meets the ENERGY STAR® guidelines for energy efficiency. ENERGY STAR® is a U.S. registered mark.

VT-FX6500A

Owner's Manual

Your Complete Guide  
to Videocassette Viewing  
and Recording

---

**Using these quality features:**

- Hi-Fi system
- Rotary 4-head Record/Playback System
- Bilingual on-screen menu display selectable in English or Spanish
- Infrared remote control
- Real time tape counter
- 181 channel capability PLL frequency synthesizer tuner with direct station call
- Digital Display
- Auto power on and off system
- Auto counter reset
- Auto rewind when the end of a tape is reached
- Direct Button Operation
- 2 Step Picture Search Operation
- Still
- Digital Auto Tracking (DTR)
- Auto Repeat
- Picture Select
- Three different playback tape speeds : SP/LP/SLP
- Two different recording tape speeds : SP/SLP
- IRT (Instant Recording Timer)
- 1 Year, 7 events (including Daily and Weekly Timer Recording)
- Time Search/Quick-Find/Index Search
- Slow Motion
- S-VHS Quasi Playback (SQPB)
- Auto Clock Setting

**HITACHI AMERICA, LTD.**  
**HOME ELECTRONICS DIVISION**

1855 Dornoch Court,  
San Diego, Ca 92173

Tel. 1-800-HITACHI  
(1-800-448-2244)

QR32252 ©Hitachi, Ltd. 2000

**HITACHI CANADA LTD.**  
**DIGITAL MEDIA DIVISION**

6740 Campobello Road,  
Mississauga, Ontario  
L5N 2L8

Tel. 1-800-HITACHI  
(1-800-448-2244)

Printed in China

## TABLE OF CONTENTS

IMPORTANT SAFEGUARDS .....	4
PRECAUTIONS .....	6
LOCATION .....	6
POWER SUPPLY .....	6
AVOID THE HAZARDS OF ELECTRICAL SHOCK AND FIRE.....	6
WARNING.....	6
FEATURES.....	7
VIDEO CASSETTE TAPE INFORMATION.....	8
PRECAUTIONS .....	8
TWO DIFFERENT TAPE SPEEDS.....	8
INSERTING A CASSETTE.....	8
REMOVING A CASSETTE.....	8
ERASE PREVENTION .....	8
OPERATING CONTROLS AND FUNCTIONS.....	9
PREPARATION FOR USE.....	11
ANTENNA/CABLE CONNECTIONS .....	11
RECORDING HINTS.....	12
RECORDING HINTS.....	12
RECORDING HINTS.....	13
SETTING THE CH3/CH4 SWITCH.....	13
A/V TERMINALS .....	13
CONNECTING TO INPUT JACKS.....	13
INSTALLING THE BATTERIES.....	14
SET UP FOR USE .....	15
CHANNEL SET UP (Automatic).....	15
TO SELECT A DESIRED CHANNEL.....	16
CLOCK SET UP .....	17
AUTO CLOCK SETTING.....	17
MANUAL CLOCK SETTING .....	18
DAYLIGHT-SAVINGS TIME.....	22
TO CANCEL THE DAYLIGHT-SAVINGS TIME.....	22
TO DELETE OR ADD CHANNELS .....	23
CHANNEL SET UP AGAIN.....	24
SELECTING THE LANGUAGE.....	24
MTS (Multi-Channel Television Sound) SYSTEM.....	25
CHECKING THE SELECTED MTS MODE .....	25
MTS RECORDING/MONITOR MODE.....	25
SELECTING THE MTS SYSTEM .....	26
TO SELECT THE HIFI MODE.....	26
TO SELECT MONO MODE.....	26
TO SELECT STEREO OR SAP MODE .....	26
PLAYBACK .....	27
NORMAL PLAYBACK.....	27
PICTURE SEARCH .....	27
STILL PICTURE .....	27
VERTICAL HOLD CONTROL.....	27
TRACKING ADJUSTMENT .....	28
SLOW MOTION.....	28
COUNTER MEMORY.....	28
TO EXIT THE COUNTER MEMORY.....	28
SPECIAL PLAYBACK.....	29
AUTO REPEAT PLAYBACK.....	29
TO EXIT THE AUTO REPEAT MODE.....	29
PICTURE SELECT.....	29
INDEX SEARCH.....	30
QUICK-FIND.....	30
TO SKIP TO THE BEGINNING OF NEXT PROGRAM.....	30
TO VIEW AT NORMAL SPEED .....	31
TIME SEARCH .....	31
RECORDING.....	32
VIEWING AND RECORDING THE SAME PROGRAM.....	32
SKIPPING UNWANTED SCENES DURING RECORDING.....	33
RECORDING ONE PROGRAM AND VIEWING ANOTHER.....	33
TO MONITOR THE PROGRESS OF YOUR RECORDING.....	33
IRT (Instant Recording Timer) .....	33

TIMER RECORDING .....	35
AUTOMATIC TIMER RECORDING .....	35
HINTS FOR TIMER RECORDING .....	38
TO CHECK THE AUTOMATIC TIMER PROGRAM .....	38
TO CORRECT OR CANCEL AN AUTOMATIC TIMER PROGRAM .....	39
TO STOP A STARTED AUTOMATIC TIMER PROGRAM.....	39
COPYING A VIDEO TAPE.....	40
TO MONITOR THE RECORDING.....	40
ON SCREEN DISPLAY .....	41
SPECIAL FEATURES .....	41
REAL TIME TAPE COUNTER.....	41
AUTO REWIND.....	41
CONTROLLING YOUR TV OR CABLE CONVERTER WITH THE VCR'S REMOTE	
.....	42
REMOTE CONTROL OF THE CABLE CONVERTER .....	42
PROGRAMMING THE REMOTE CONTROL OF THE CABLE CONVERTER ....	42
TO OPERATE THE CABLE BOX ONCE THE REMOTE IS PROGRAMMED FOR	
IT .....	42
REMOTE CONTROL OF THE TV .....	43
PROGRAMMING THE REMOTE CONTROL OF THE TV .....	43
CONTROLLING THE TV .....	43
TROUBLESHOOTING GUIDE.....	44
MAINTENANCE.....	44
SERVICING.....	44
CABINET CLEANING .....	44
HEAD CLEANING .....	44
TECHNICAL SPECIFICATIONS .....	45
CABLE CHANNEL DESIGNATIONS .....	46

## IMPORTANT SAFEGUARDS

**WARNING!**  
TO REDUCE THE RISK OF ELECTRIC SHOCK, DO NOT EXPOSE THIS APPLIANCE TO RAIN OR MOISTURE.



**CAUTION: TO REDUCE THE RISK OF ELECTRIC SHOCK,  
DO NOT REMOVE COVER (OR BACK).  
NO USER-SERVICEABLE PARTS INSIDE.  
REFER SERVICING TO QUALIFIED SERVICE PERSONNEL.**

The caution marking is located on the rear of the cabinet.



The lightning flash with arrowhead symbol, within an equilateral triangle, is intended to alert the user to the presence of uninsulated "dangerous voltage" within the product's enclosure that may be of sufficient magnitude to constitute a risk of electric shock to persons.



The exclamation point within an equilateral triangle is intended to alert the user to the presence of important operating and maintenance (servicing) instructions in the literature accompanying the product.

- 1. Read instructions**-All the safety and operating instructions should be read before the appliance is operated.
- 2. Retain Instructions**-The safety and operating instructions should be retained for future reference.
- 3. Heed Warnings**-All warnings on the appliance and in the operating instructions should be adhered to.
- 4. Follow Instructions**-All operating and use instructions should be followed.
- 5. Cleaning**-Unplug this video product from the wall outlet before cleaning. Do not use liquid cleaners or aerosol cleaners. Use a damp cloth for cleaning.  
**EXCEPTION:** A product that is meant for uninterrupted service and, that for some specific reason, such as the possibility of the loss of an authorization code for a CATV converter, is not intended to be unplugged by the user for cleaning or any other purpose, may exclude the reference to unplugging the appliance in the cleaning description otherwise required in item 5.
- 6. Attachments**-Do not use attachments not recommended by the video product manufacturer as they may cause hazards.
- 7. Water and Moisture**-Do not use this video product near water, for example, near a bath tub, wash bowl, kitchen sink, or laundry tub, in a wet basement, or near a swimming pool, and the like.
- 8. Accessories**-Do not place this video product on an unstable cart, stand, tripod, bracket, or table. The video product may fall, causing serious injury to a child or adult, and serious damage to the appliance. Use only with a cart, stand, tripod, bracket, or table recommended by the manufacturer, or sold with the video product. Any mounting of the appliance should follow the manufacturer's instructions and should use a mounting accessory recommended by the manufacturer. An appliance and cart combination should be moved with care. Quick stops, excessive force, and uneven surfaces may cause the appliance and cart combination to overturn.



- 9. Ventilation**- Slots and openings in the cabinet are provided for ventilation and to ensure reliable operation of the video product and to protect it from overheating, and these openings must not be blocked or covered. The openings should never be blocked by placing the video product on a bed, sofa, rug, or other similar surface. This video product should not be placed in a built-in installation such as a bookcase or rack unless proper ventilation is provided or the manufacturer's instructions have been adhered to .
- 10. Power Sources**-This video product should be operated only from the type of power source indicated on the marking label. If you are not sure of the type of power supply to your home, consult your appliance dealer or local power company. For products intended to operate from battery power, or other sources, refer to the operating instructions.
- 11. Grounding or Polarization**- This video product is equipped with a polarized alternating-current line plug (a plug having one blade wider than the other). This plug will fit into the power outlet only one way. This is a safety feature. If you are unable to insert the plug fully into the outlet, try reversing the plug. If the plug should still fail to fit, contact your electrician to replace your obsolete outlet. Do not defeat the safety purpose of the polarized plug.
- 12. Power Cord Protection**- Power supply cords should be routed so that they are not likely to be walked on or pinched by items placed upon or against them, paying particular attention to cords at plugs, convenience receptacles, and the point where they exit from the appliance.
- 13. Outdoor Antenna Grounding**-If an outside antenna or cable system is connected to the video product, be sure the antenna or cable system is grounded so as to provide some protection against voltage surges and built-up static charges. Article 810 of the National Electrical Code, ANSI/NFPA No. 70, provides information with regard to proper grounding of the mast and supporting structure, grounding of the lead-in wire to an antenna discharge unit, size of grounding conductors, location of antenna-discharge unit, connection to grounding electrodes, and requirements for the grounding electrode. (Fig. A)

14. **Lightning**-For added protection for this video product during a lightning storm, or when it is left unattended and unused for long periods of time, unplug it from the wall outlet and disconnect the antenna or cable system. This will prevent damage to the video product due to lightning and power-line surges.

15. **Power Lines**-An outside antenna system should not be located in the vicinity of overhead power lines or other electric light or power circuits, or where it can fall into such power lines or circuits. When installing an outside antenna system, extreme care should be taken to keep from touching such power lines or circuits as contact with them might be fatal.

16. **Overloading**-Do not overload wall outlets and extension cords as this can result in a risk of fire or electric shock.

17. **Object and Liquid Entry**-Never push objects of any kind into this video product through any openings as they may touch dangerous voltage points or short-out parts that could result in a fire or electric shock. Never spill liquid of any kind on the video product.

18. **Servicing**-Do not attempt to service this video product yourself as opening or removing covers may expose you to dangerous voltage or other hazards. Refer all servicing to qualified service personnel.

19. **Damage Requiring Service**-Unplug this video product from the wall outlet and refer servicing to qualified service personnel under the following conditions:

- a. When the power-supply cord or plug is damaged.
- b. If liquid has been spilled, or objects have fallen into the video product.
- c. If the video product has been exposed to rain or water.
- d. If the video product does not operate normally by following the operating instructions. Adjust only those controls that are covered by the operating instructions as an improper adjustment of other controls may result in damage and will often require extensive work by a qualified technician to restore the video product to its normal operation.
- e. If the video product has been dropped or damaged in any way.
- f. When the video product exhibits a distinct change in performance-this indicates a need for service.

20. **Replacement Parts**-When replacement parts are required, be sure the service technician has used replacement parts specified by the manufacturer or have the same characteristics as the original part. Unauthorized substitutions may result in fire, electric shock or other hazards.

21. **Safety Check**-Upon completion of any service or repairs to this video product, ask the service technician to perform safety checks to determine that the video product is in proper operating condition.

22. **Heat**-This video product should be situated away from heat sources such as radiators, heat registers, stoves, or other products (including amplifiers) that produce heat.

# PRECAUTIONS

## LOCATION

For safe operation and satisfactory performance of your VCR, keep the following in mind when selecting a place for its installation:

- Shield it from direct sunlight and keep it away from sources of intense heat.
- Avoid dusty or humid places.
- Avoid places with insufficient ventilation for proper heat dissipation. Do not block the ventilation holes on the sides of the VCR.
- Install unit in a horizontal position.
- Avoid locations subject to strong vibration.
- Do not place the VCR near strong magnetic fields.
- Avoid moving VCR to locations where temperature differences are extreme.
- Do not place the VCR directly on top of the TV.

## POWER SUPPLY

- AC 120V, 60Hz ONLY

## AVOID THE HAZARDS OF ELECTRICAL SHOCK AND FIRE

- Do not handle the power cord with wet hands.
- Do not pull on the power cord when disconnecting it from AC wall outlet. Grasp it by the plug.
- If, by accident, water is spilled on your VCR, unplug the power cord immediately and take the unit to an Authorized Service Center for servicing.
- Do not put your fingers or objects into the VCR cassette holder.
- Do not place anything directly on top of the VCR.

## WARNING

Moisture condensation may occur inside the unit when it is moved from a cold place to a warm place, or after heating a cold room or under conditions of high humidity. Do not use the VCR at least for 2 hours until its inside is dry.

**FCC WARNING- This equipment may generate or use radio frequency energy. Changes or modifications to this equipment may cause harmful interference unless the modifications are expressly approved in the instruction manual. The user could lose the authority to operate this equipment if an unauthorized change or modification is made.**

### IMPORTANT COPYRIGHT INFORMATION

Unauthorized recording or use of broadcast television programming, video tape, film or other copyrighted material may violate applicable copyright laws. We assume no responsibility for the unauthorized duplication, use or other acts which infringe upon the rights of copyright owners.

**WARNING:** To prevent electric shock, match wide blade of plug to wide slot, fully insert.

**ATTENTION: (French translation of above warning)**

The serial number of this product may be found on the back of the VCR. No other VCR has the same serial number as yours. You should record the number and other vital information here and retain this book as a permanent record of your purchase to aid identification in case of theft. Serial numbers are not kept on file.

Date of Purchase	
Dealer Purchase from	
Dealer Address	
Dealer Phone No.	
Model No.	
Serial No.	

## FEATURES

- **Hi-Fi system-** The Hi-Fi stereo recording system offers you excellent sound quality with a dynamic range of 80dB, frequency response from 20Hz to 20kHz, and 0.005% wow and flutter
- **Rotary 4-head Record/Playback System-** Rotary 4-heads to ensure excellent picture quality and special effects playback.
- **Bilingual on-screen menu display selectable in English or Spanish**
- **Infrared remote control**
- **Real time tape counter-** This shows the elapsed recording or playback time in hours, minutes, and seconds. (Does not work in blank areas of the tape)
- **181 channel capability PLL frequency synthesizer tuner with direct station call-** (A converter may be necessary to view scrambled cable channels.)
- **Digital Display**
- **Auto power on and off system-** Automatically turns the VCR on when you insert the cassette, turns off after auto-rewind, and ejects when the beginning of the tape is reached.
- **Auto counter reset-** (Automatically resets tape counter "0:00:00" when a tape is inserted)
- **Auto rewind when the end of a tape is reached-** (Does not occur when using the timer recording).
- **Direct Button Operation-** When a tape is in the VCR and the power is off, just press PLAY, REW or F.FWD button on the main unit and it will automatically turn on the VCR and perform the desired function. (Does not occur when using the timer recording).
- **2 Step Picture Search Operation-** You can view a video program at a high speed or super high speed in either a forward or reverse direction . (Super high speed is available in LP and SLP mode only)
- **Still-** "Freeze" the picture at any time, for close viewing of a particular scene.
- **Digital Auto Tracking (DTR)-** Automatically adjusts the tracking for each tape you play.
- **Auto Repeat-** Allows you to repeat the playing of a tape indefinitely without pressing the PLAY button.
- **Picture Select-** Allows you to select the picture quality of a tape.
- **Three different playback tape speeds: SP/LP/SLP**
- **Two different recording tape speeds : SP/SLP**
- **IRT (Instant Recording Timer)-** Instant timed recording for 30 to 480 minutes is possible at the push of the REC/IRT button.
- **1 Year, 7 events (including Daily and Weekly Timer Recording)-** The built-in timer allows you to record up to 7 programs at different times on different channels up to 1 year in advance. The daily timer allows recordings to be made of daily broadcasts, from Monday through Friday, and the weekly timer allows recording to be made once a week up to the end of the tape.
- **Time Search-** Lets you set the VCR to advance the tape by entering the desired playback time you want to skip.
- **Quick-Find-** Lets you search and confirm the contents of the recorded program(s) using the index mark.
- **Index Search-** Lets you Index the start of a recording.
- **Slow Motion-** You can view the video program at a slower than normal playback speed. Slow speed can be controlled by pressing the F.FWD button (faster) or the REW button (slower).
- **S-VHS Quasi Playback (SQPB)-** Allows you to view a tape recorded in S-VHS format.
- **Auto Clock Setting-** Allows you to use the clock function from the PBS broadcast.

### A NOTE ABOUT RECYCLING

This product's packaging materials are recyclable and can be reused. Please dispose of any materials in accordance with your local recycling regulations.

Batteries should never be thrown away or incinerated but disposed of in accordance with your local regulations concerning chemical wastes.

# VIDEO CASSETTE TAPE INFORMATION

This VCR will operate with any cassette that has the VHS mark. For best results, we recommend the use of high-quality tapes. Do not use poor quality or damaged tapes.

## PRECAUTIONS

- Avoid moisture. Moisture condensation may occur on the tape if it is moved from a cold place to a warm place or vice versa. Before using a tape with these conditions, to avoid damage of the tape and your VCR, wait until the tape has warmed to room temperature and the moisture has evaporated.
- Avoid extreme heat, high humidity and magnetic fields.
- Do not tamper with the cassette mechanism.
- Do not touch the tape with your fingers.

## TWO DIFFERENT TAPE SPEEDS

Before recording, select the tape speed from: SP mode (Standard Play) or SLP mode (Super Long Play).

The table below shows the maximum recording/playback time using T60, T120, or T160 tapes in each mode.

Tape Speed	Recording/Playback Time			
	Type of tape	TT16060	T120	T160
SP mode			1 hour	2 hours
SLP mode			3 hours	6 hours

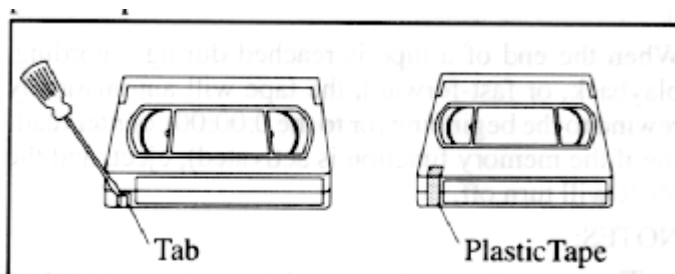
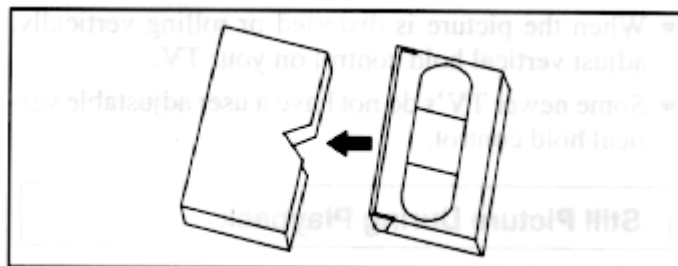
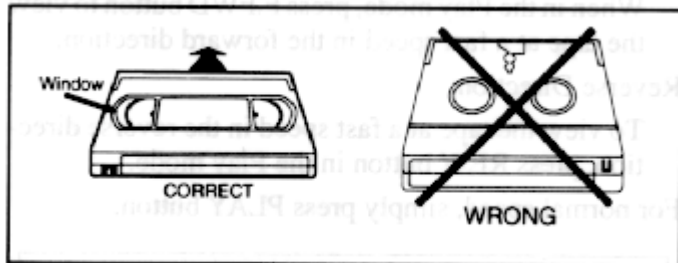



# OPERATING CONTROLS AND FUNCTIONS

## NOTE:

• We do not recommend the use of universal remote controls. Not all of the functions may be controlled with a universal remote control.

If you decide to use a universal remote control with this unit, please be aware that the code number given may not operate this unit. In this case, please call the manufacturer of the universal remote control.

## -VCR FRONT PANEL

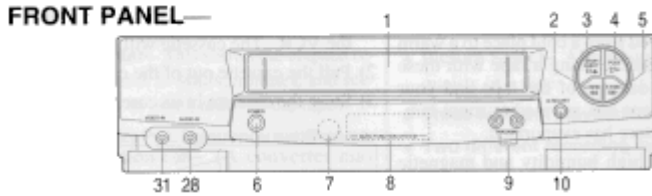

## -REMOTE CONTROL

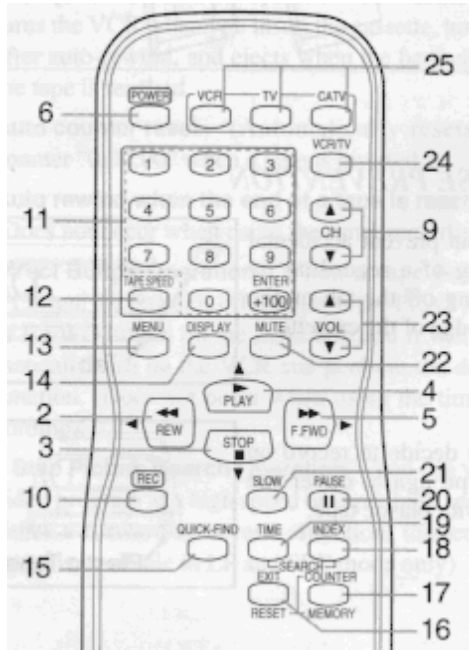

### 1. Cassette Compartment

**2. REW button-** Press to rewind the tape, or to view the picture rapidly in reverse during the playback mode. (Rewind Search)

◀ **button-** Press to cancel a setting of timer program. Press to correct digits when setting program (For example: setting clock or timer program). Press to add or delete channel numbers during channel preset. (only on the remote control)

**3. STOP button-** Press to stop the tape motion.

**EJECT button-** Press to remove a tape from the VCR. (only on the VCR)

▼ **button-** Press to enter digits when setting program (for example: setting clock or timer program). Press to select setting modes from the on screen menu. (only on the remote control)

**4. PLAY button-** Press to begin playback.

▲ **button-** Press to enter digits when setting program (for example: setting clock or timer program). Press to select setting modes from the on screen menu. (only on the remote control)

**5. F.FWD button-** Press to rapidly advance the tape, or view the picture rapidly in forward during playback. (Forward Search)

▶ **button-** When setting program (for example: setting clock or timer program), press to determine your selection and proceed to the next step you want to input. Press to determine the setting modes from the on screen menu. Press to add or delete channel numbers during channel preset. (only on the remote control)

**6. Power button-** Press to turn VCR on and off. Press to activate timer recording.

**7. Remote sensor window-** Receives the infrared signals from the remote control.

**8. Digital display-** See page 33.

**9. CHANNEL(CH) ▲/▼ buttons-** Press to select the desired channels for viewing or recording.

**Tracking function-** Press to minimize video 'noise' (lines or dots on screen) during playback (only on the VCR) or slow mode.

Press to stabilize the picture in the Still mode when the picture begins to vibrate vertically.

**10. REC button-** Press for manual recording.

**IRT button-** Press to activates Instant Recording Timer. (only on the VCR)

**11. NUMBER buttons-** Press to select desired channels for viewing or recording. To select channels from 1 to 9, first press "0" button then 1 to 9. (only on the remote control)

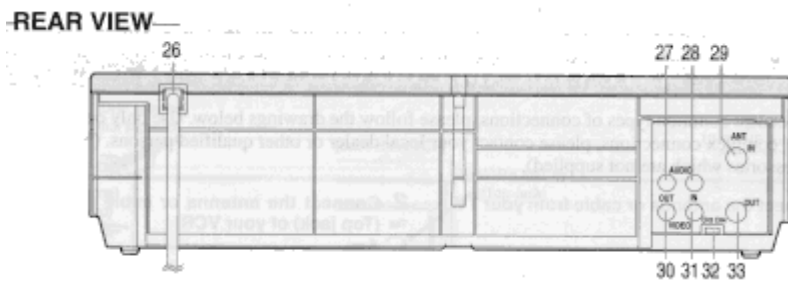

**+100 button-** When selecting cable channels which are higher than 99, press this button first, then press the last two digits. (To select channel 125, first press "+100" button then press "2" and "5"). (only on the remote control)

**ENTER-** For details, see pages 34-35. (only on the remote control)

**12. TAPE SPEED button-** Press to choose the desired recording speed : SP/SLP. (only on the remote control)

**13. MENU button-** Press to display the menu on the TV screen. Press to exit the menu on the TV screen. (only on the remote control)

**14. DISPLAY button-** Press to display the counter or the current channel number and the current time on the TV screen. (only on the remote control)

**15. QUICK-FIND button-** Quick Find mode. For more information, please read page 26. (only on the remote control)

**16. COUNTER RESET button-** Press to reset counter to 0:00:00. (only on the remote control)

**EXIT button-** Press to exit the menu on the TV screen. (only on the remote control)

**17. COUNTER MEMORY button-** Press to set counter memory on and off. (only on the remote control).

**18. INDEX SEARCH button-** Index Search mode. For more information, please read page 25. (only on the remote control)

**19. TIME SEARCH button-** Time Search mode. For more information, please read page 26. (only on the remote control)

**20. PAUSE button-** Press to temporarily stop the tape during recording or to view a still picture during playback. (only on the remote control)

**Frame Advance function-** Press to advance the picture by one frame at a time during the still mode. (only on the remote control)

**21. SLOW button-** Press to start slow motion playback. The slow speed can be controlled by pressing the F.FWD button (faster) or the REW button (slower). (only on the remote control)

**22. MUTE button-** Press to mute the TV's sound. Press it again to resume the sound. (only on the remote control)

**23. VOL(ume) buttons-** Press to adjust the desired TV's volume level by using either ▲ or ▼ button. (only on the remote control)

**24.VCR/TV button-** Press to select TV or VCR mode. (only on the remote control)

*VCR position:* to view playback, to monitor video recordings or watch TV using the VCR tuner.

*TV position:* to watch TV or to view one program while recording another.

**25. MODE SELECT buttons-** (only on the remote control)

- **CATV button-** For details, see page 34.

- **TV button-** For details, see page 35.

- **VCR button-** For details, see page 34-35.

**26. Power cord-** Connect to a standard AC outlet (120V/60Hz)

**27. AUDIO OUT jack-** Connect to the audio input jack of your audio equipment or another VCR

**28. AUDIO IN jack-** Connect to the audio output jack of your audio equipment or another VCR.

**29. ANT. IN terminal-** Connect to an antenna, Cable system or Satellite system.

**30. VIDEO OUT jack-** Connect to the video input jack of your video camera or another VCR.

**31. VIDEO IN jack-** Connect to the video output jack of your video camera or another VCR.

**32. CH3/CH4 selector switch-** Use to select a video output channel (3 or 4) for VCR playback.

**33. ANT. OUT terminal-** Connects to the antenna input terminal on your TV.

# PREPARATION FOR USE

## ANTENNA/CABLE CONNECTIONS

For some of the most common types of connections, please follow the drawings below. Use only one connection. For any further complex connections, please contact your local dealer or other qualified persons. (You may need additional accessories which are not supplied).

1 Disconnect the antenna or cable from your TV.	2 Connect the antenna or cable to the ANT. IN (Top jack) of your VCR.
3 Connect one end of the coaxial cable (supplied) to the ANT.OUT (Bottom jack) of your VCR.	4 Connect the other end of the coaxial cable (supplied) to the UHF/VHF antenna jack of your TV.

**Fig.1: Indoor Antenna**

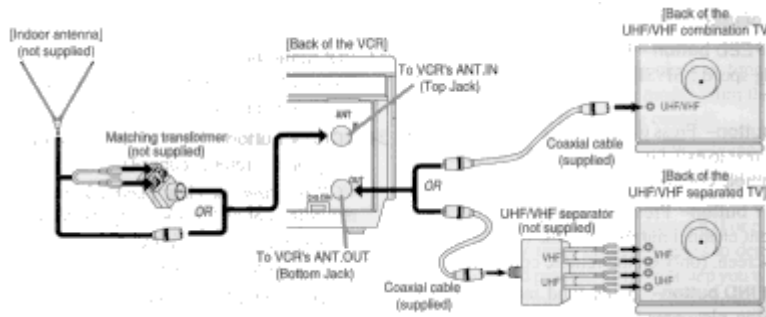

You can record one channel while viewing another. The same goes for Automatic Timer Recording and IRT. For details, please refer to "Recording" on page 27.

**Note:** The connection of an indoor antenna with a VCR may not always give acceptable TV reception.

**Fig. 2: VHF/UHF Combination Antenna or Cable from the Cable Company**

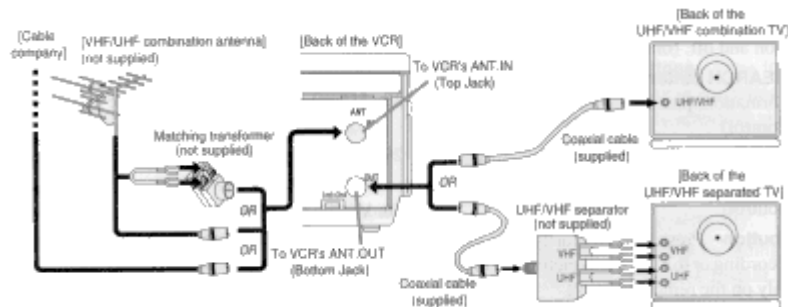

You can record one channel while viewing another. The same goes for Automatic Timer Recording and IRT. For details, please refer to "Recording" on page 27.

**Continued on the next page.**

**Fig. 3: VHF/UHF Separate Antenna**

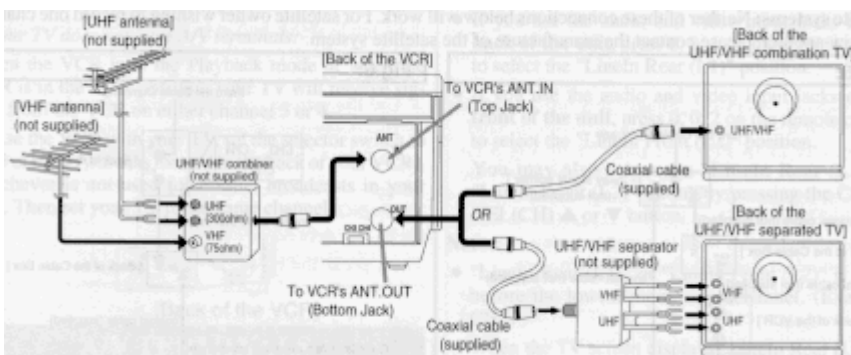

You can record one channel while viewing another. The same goes for Automatic Timer Recording and IRT. For details, please refer to "Recording" on page 27.

**Fig. 4: Cable Box and Satellite Box**

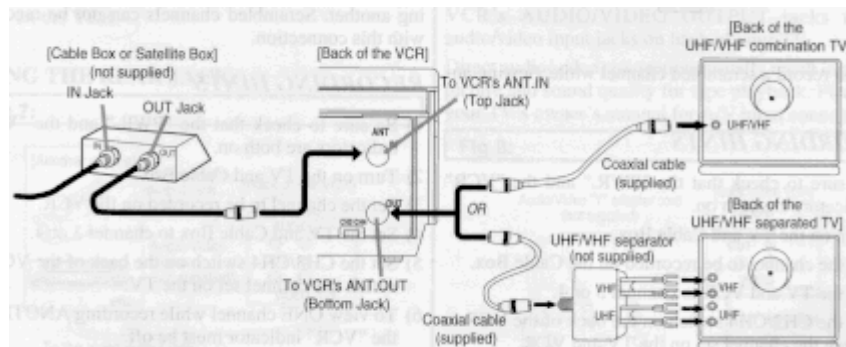

You can ONLY record and view the SAME channel when using this connection. There are no exceptions. The same goes for Automatic Timer Recording and IRT.

**Note:** Channel memory programming is NOT needed when using this connection.

## RECORDING HINTS

- 1) Be sure to check that the "PWR." and the "VCR" indicators are both on.
- 2) Turn on the TV and Cable Box or Satellite Box.
- 3) Set the channel to be recorded on the Cable Box or Satellite Box.
- 4) Set the TV and VCR to channel 3 or 4.
- 5) Set the CH3/CH4 switch on the back of the VCR to match the channel set on the TV and VCR.
- 6) Press the REC button. For AUTOMATIC TIMER RECORDING, the VCR must stay on channel 3 or 4 at step [9] on page 30.

**Continued on the next page.**

Some customers with cable boxes may record one channel and view another, with either one of the connections below.

**Satellite systems:** Neither one of these connection will work. For satellite owner wishing to record one channel and view another, please contact the manufacture of the satellite system.

**Fig. 5:**

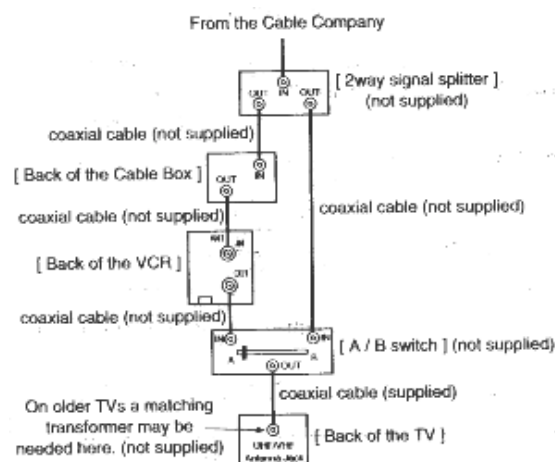

You can record a scrambled channel while viewing another.

## RECORDING HINTS

- 1) Be sure to check that the "PWR." and the "VCR" indicators are both on.
- 2) Turn on the TV and Cable Box.
- 3) Set the channel to be recorded on the Cable Box.
- 4) Set the TV and VCR to channel 3 or 4.
- 5) Set the CH3/CH4 switch on the back of the VCR to match the channel set on the TV and VCR.
- 6) Press the REC button. For AUTOMATIC TIMER RECORDING, the VCR must stay on channel 3 or 4 at step [9] on page 30.
- 7) Set the A-B switch to the other side. For AUTOMATIC TIMER RECORDING, set the A-B switch to the other side after step [12] 0.
- 8) Select the channel to be viewed on the TV.

**Note:** If you wish to see the VCR menu, view what you are recording or playing a tape with this connection, make sure the A-B switch is on the correct side.

Fig. 6:

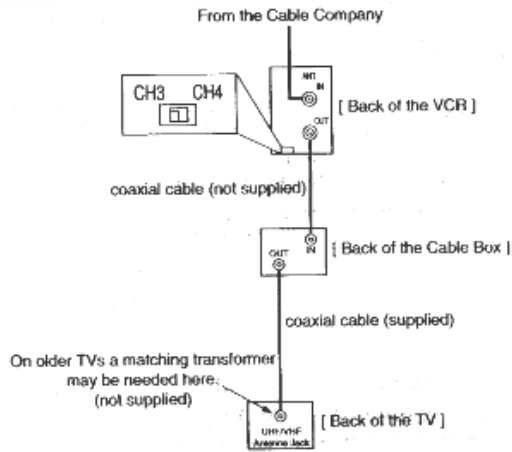

This connection is good only if none of your channels are scrambled. You can record one channel while viewing another. Scrambled channels can not be recorded with this connection.

## RECORDING HINTS

- 1) Be sure to check that the "PWR." and the "VCR" indicators are both on.
- 2) Turn on the TV and Cable Box.
- 3) Set the channel to be recorded on the VCR.
- 4) Set the TV and Cable Box to channel 3 or 4.
- 5) Set the CH3/CH4 switch on the back of the VCR to match the channel set on the TV.
- 6) To view ONE channel while recording ANOTHER, the "VCR" indicator must be off.  
For AUTOMATIC TIMER RECORDING, the "VCR" indicator must be off after step [11] on page 30.
- 7) Set the channel to be viewed on the Cable Box.

**Note:** If you wish to see the VCR menu, view what you are recording or playing a tape with this connection, the "VCR" indicator must be on and the Cable Box channel must match the channel selected on the back of the VCR. (CH 3 or 4)

### Note to CATV system installer

This reminder is provided to call the CATV system installer's attention to Article 820-40 of the NEC that provides guidelines for proper grounding and, in particular, specifies that the cable ground shall be connected to the grounding system of the building, as close to the point of cable entry as practical.

## SETTING THE CH3/CH4 SWITCH

*If your TV does not have A/V terminals:*

When the VCR is in the Playback mode or when the VCR is in the VCR position, your TV will receive signals from the VCR on either channel 3 or 4.

To use the VCR with your TV, set the selector switch to CH3 or CH4 (which is located in the back of your VCR), whichever is not used for normal broadcasts in your area. Then set your TV to the same channel.

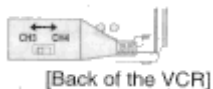

## A/V TERMINALS

### CONNECTING TO INPUT JACKS

When you copy a video tape, or watch a program recorded on an another source, use the audio/video input jacks on the VCR.

- When you connect a monaural VCR (another source) to this VCR, connect the Audio output jack of the monaural VCR (another source) to the AUDIO IN L jack of this VCR. The audio signal will be recorded in both L and R channel equally.

#### USING THE REAR JACK:

Fig. 7:

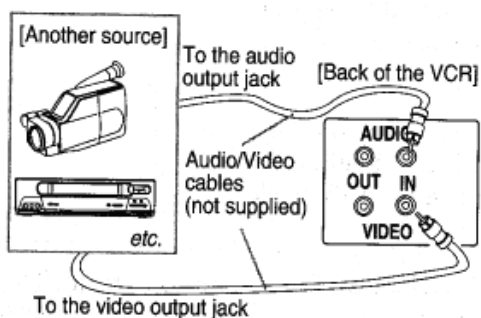

#### USING THE FRONT JACK:

You can use the audio and video input jacks on the front panel of the VCR instead of using the jacks on the back.

## INPUT SELECT OF FRONT OR REAR

To use the audio/video input jacks, select the "LineIn Rear (L1)" or "LineIn Front (L2)" position.

- 1) Be sure to check that the "PWR." and the "VCR" indicators are both on.
- 2) Turn on the TV and set the TV to channel 3 or 4. Now set the CH3/CH4 switch on the back of the VCR to match the channel selected on the TV.
- 3) Connect the audio/video cables to the audio/video input jacks on the back of the VCR. Now connect the other end of the cables to the audio/video output jacks on the source.

4)

- If you use the audio and video input jacks **on the back of the unit**, press 0, 0, 1 on the remote control to select the "LineIn Rear (L1)" position.
- If you use the audio and video input jacks **on the front of the unit**, press 0, 0, 2 on the remote control to select the "LineIn Front (L2)" position.

You may also select the "LineIn Rear (L1)" or "LineIn Front (L2)" setting by pressing the CHANNEL(CH) ▲ or ▼ button.

### Notes:

- "LineIn Rear (L1)" or "LineIn Front (L2)" is found before the lowest memorized channel. (Example: CH2)
- When the TV screen displays "LineIn Rear (L1)" or "LineIn Front (L2)", its background will be blue.

## CONNECTING TO OUTPUT JACKS

If your TV has A/V input jacks, you may connect your VCR's AUDIO/VIDEO OUTPUT jacks to the audio/video input jacks on back of your TV.

Direct audio/video connections usually result in a better picture and sound quality for tape playback. Please see your TV's owner's manual for A/V input connections.

Fig. 8:

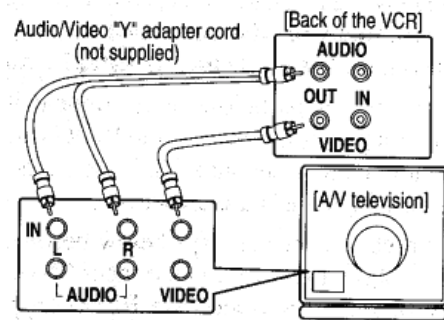

## INSTALLING THE BATTERIES

- 1) Open the battery compartment cover by pressing the cover on the remote unit in the direction of the arrow.
- 2) Insert 2 "AA" penlight batteries into the battery compartment in the direction indicated by the polarity (+/-) markings.
- 3) Replace the cover.



## SET UP FOR USE

You can program the tuner to scan only the channels you receive in your area. You must use the remote control for this procedure.

### NOTES:

- **Channel memory programming is NOT needed when connected to a cable box or satellite box as in Fig 4 on page 11 or Fig 5 on page 12. In this case with your remote, select the VCR to channel 3 or 4 the same channel as located on the back of VCR (CH3 or CH4). Then the channel you wish to record or view may be selected on the cable box or satellite box.**
- Follow the steps below once. Repeat it only if there is a power failure or if the VCR is unplugged for more than 30 seconds. (In these cases, the programmed channels are erased.)
- You must follow the steps below before attempting to play or record a video tape. If you want to play or record a video tape **BEFORE** programming the tuner, you must first turn off the VCR. Then, press the POWER button again to turn it back on. To program the tuner again, see "CHANNEL SET UP AGAIN" on page 19.

## CHANNEL SET UP (Automatic)

### Plug in the VCR power cord

Plug the VCR power cord into a standard AC outlet. The "- - : - -" indicator flashes on the display.



- Whenever the AC plug is connected, the VCR search the local PBS (Public Broadcasting Station) channel for auto clock setting. If the VCR find the local PBS channel, current time appears on the display.

**Remember:** If your cable box or satellite box is connected as in Fig 4 on page 11 or Fig 5 on page 12, you **DO NOT** have to set up the channels. Just select the TV and VCR to channel 3 or 4 and also have the CH3/CH4 switch on the back of the VCR to match the channel you selected (CH 3 or CH 4). Now select the Box to the channel you wish to view or record.

### 2 Select channel 3 or 4 on the TV

Turn on the TV and set the TV to channel 3 or 4. Now set the CH3/CH4 switch on the back of the VCR to match the channel selected on the TV.

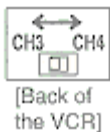

### 3 Turn on the VCR

Press the POWER button to turn on the VCR. Both the "PWR." indicator and the "VCR" indicator on the display come on.

- **Use the remote control for this procedure.**



---

#### 4 Select "ENGLISH" or "ESPAÑOL"

Select "ENGLISH" or "ESPAÑOL"=Spanish by using the PLAY/▲ or STOP/▼ button. Then, press the F.FWD/▶ button.

**NOTE:** This function effects only the language on the screen menu and not the audio source.



---

#### 5 Begin Channel preset

Press the F.FWD/▶ button once. The tuner scans and memorizes all active channels in your area.

- The VCR distinguishes between standard TV channels and cable channels.

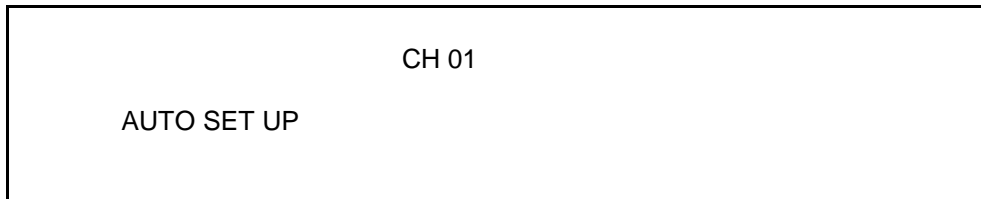

---

#### 6 After scanning

The tuner stops on the lowest memorized channel. The TV screen returns to TV mode.

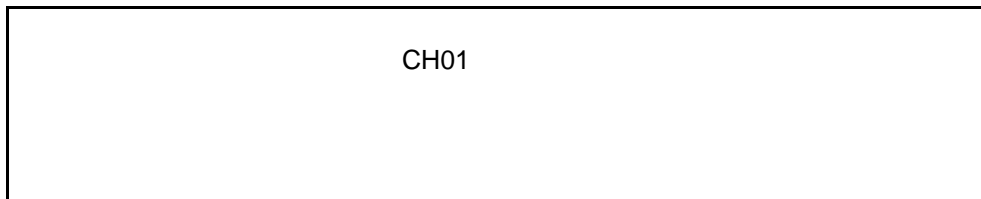

- If "AUTO SET UP" appears on the TV screen again, check the cable connections. Press the F.FWD/▶ button once again and the VCR will begin preset again.
  - If the VCR cannot find the local PBS channel at step 1, after scanning channels, "AUTO CLOCK" flashes on the TV screen. And the VCR search the local PBS channel for auto clock setting again. When the clock is not set yet, press the POWER button to turn on the VCR, then press the number buttons or CHANNEL (CH) ▲/▼ button to select your local PBS channel. The current time may appear on the display. If current time does not appear, follow "MANUAL CLOCK SETTING" on page 17.
- Note:** The VCR will search through all the available channels from the lowest channel. It must scan each channel for 10 seconds to determine if that channel is transmitting the EDS (Extended Data Service) signal. If the highest channel has EDS signal, it takes many times. To cancel this search, press the RESET/EXIT button.

- If you want to use DAYLIGHT-SAVINGS TIME feature when current time appears, follow "DAYLIGHT-SAVINGS TIME" on page 18.

### TO SELECT A DESIRED CHANNEL

You can select the desired channel by using the CHANNEL(CH) ▲ or ▼ button or directly pressing the number buttons on the remote control.

**Note for using the number buttons:**

- When selecting cable channels which are higher than 99, press the + 100 button first, then press the last two digits. (Example: to select channel 125, first press the +100 button then press "2" and "5").
- You must precede single-digit channel numbers with a zero (For example: 02, 03, 04 and so on).



## CLOCK SET UP

Set the clock accurately for proper automatic timer recording.

- If the Public Broadcasting Station (PBS) is available in your area, the VCR set the clock automatically by using it at "CHANNEL SET UP" on page 14. (Auto Clock Setting feature)

Once the clock is set by this feature, the VCR will get automatically the current time from your local PBS channel, using a new service called Extended Data Service (EDS) whenever turning the VCR off, at 12:00AM and 12:00PM. If the clock's time is incorrect for some reason or you want to reset the clock immediately, following "AUTO CLOCK SETTING".

- If you want to set the clock manually, follow "MANUAL CLOCK SETTING" on page 17.
- If you want to use DAYLIGHT-SAVINGS TIME feature, follow "DAYLIGHT-SAVINGS TIME" on page 18.

### AUTO CLOCK SETTING

- Confirm that the antenna connections are correct and the CHANNEL PRESET completes first.



- **Use the remote control for this procedure.**

- Be sure to check that the "PWR." and the "VCR" indicators are both on.
- Turn on the TV and set the TV to channel 3 or 4. Now set the CH3/CH4 switch on the back of the VCR to match the channel selected on the TV.

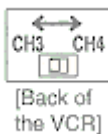

- If the VCR is connected directly to a cable converter box, the cable converter box must turn on and select the local PBS channel itself. Then, the VCR must be set to the output channel of the cable converter box (usually channel 3 or 4), to be able to set up and automatically correct the clock.

#### 1 Select main menu

Press the MENU button until the main menu appears.

- If the clock is not set yet, CLOCK SET menu appears immediately when you press the MENU button. In this case, go to step [3].

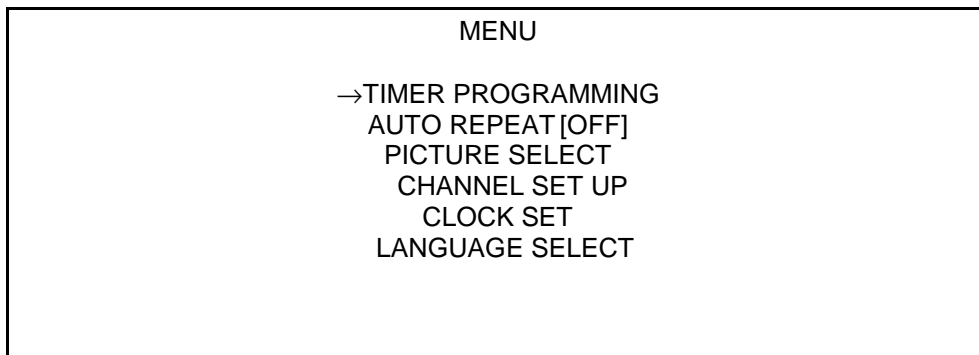

#### 2 Select "CLOCK SET"

Press the PLAY/▲ or STOP/▼ button to point to "CLOCK SET".

Then press the F.FWD/▶ button.

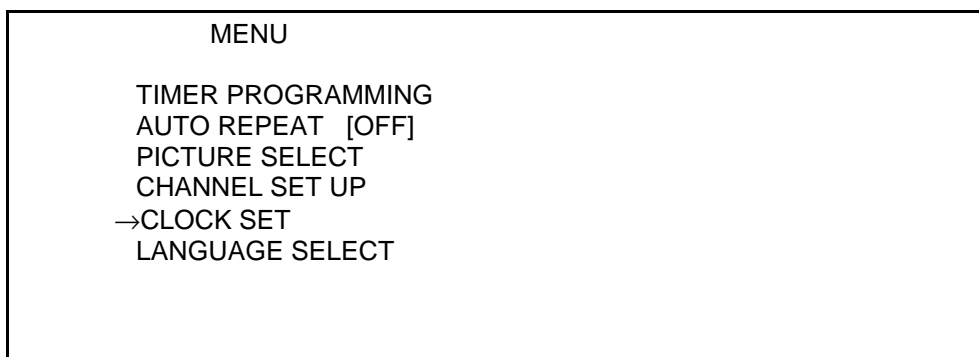

#### 3 Select "AUTO CLOCK"

If [ON] appears beside "AUTO CLOCK", press the F.FWD/▶ button.

- If it is not, press the PLAY/▲ or STOP/▼ button to point to "AUTO CLOCK".

Then, press the F.FWD/▶ button twice.



---

#### 4 Select the PBS channel

First, press the PLAY/▲ or STOP/▼ button to point to "MANUAL". Then, press the F.FWD/▶ button. Next, press the number buttons or PLAY/▲ or STOP/▼ button to select the PBS channel.

- If you leave it set to "AUTO" when the clock is not set yet, the VCR read your local PBS channel once time every 10 minutes until the VCR get the current time.

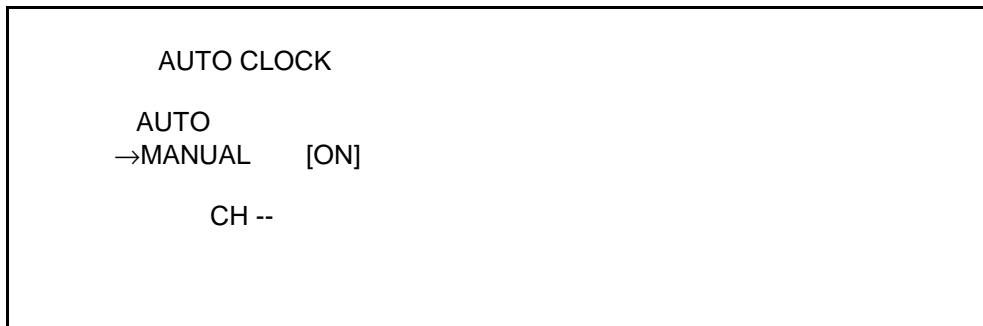

#### 5 The VCR begin to get the current time

Press the F.FWD/▶ button. "AUTO CLOCK" flashes on the TV screen. After a few minutes, flashing stops and current time appears on the display.

**NOTE:**

- When your local PBS channel is incorrect or is not received, the clock cannot be set automatically. In this case, follow "MANUAL CLOCK SETTING" on page 17.

### MANUAL CLOCK SETTING

We suggest that you use a TV or radio station as your time source.

In the example below, the clock is to be set to:

DATE 20th March , 2000  
SETTING TIME 5:40PM



- Use the remote control for this procedure.
- Be sure to check that the "PWR." and the "VCR" indicators are both on.
- Turn on the TV and set the TV to channel 3 or 4. Now set the CH3/CH4 switch on the back of the VCR to match the channel selected on the TV.

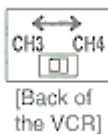

---

#### 1 Select main menu

Press the MENU button until the main menu appears.

- If the clock is not set yet, CLOCK SET menu appears immediately when you press the MENU button. In this case, go to step [3].

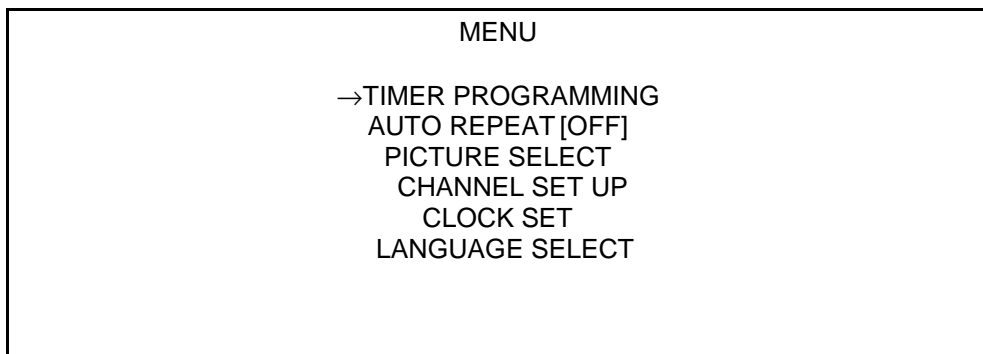

---

## 2 Select "CLOCK SET"

Press the PLAY/▲ or STOP/▼ button to point to "CLOCK SET".

Then press the F.FWD/▶ button.

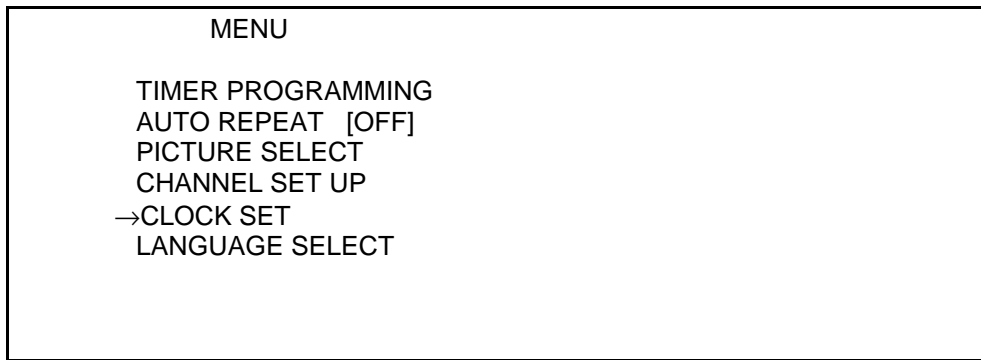

---

## 3 Select "MANUAL"

If [ON] appears beside "MANUAL", press the F.FWD/▶ button.

- If it is not, press the PLAY/▲ or STOP/▼ button to point to "MANUAL".

Then, press the F.FWD/▶ button twice.

- When you press the F.FWD/▶ button during steps [4] to [8], you may move forward to the next step.
- Press the REW/◀ button to go back one step from the current step during steps [5] to [9].

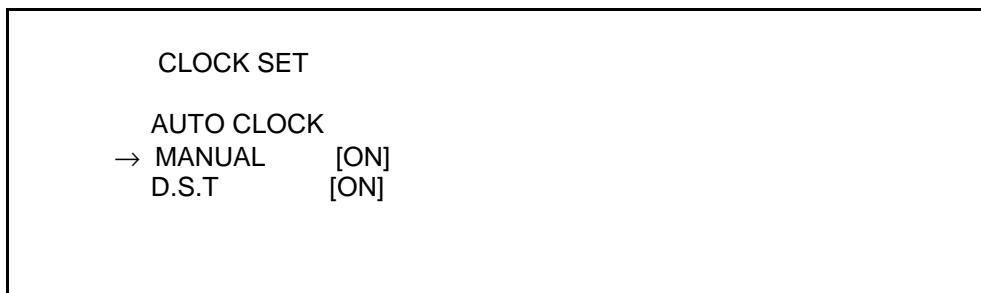

---

**4 Select the month**

Press the PLAY/▲ or STOP/▼ button until the desired month appears.  
(Example: March → 03)

Then, press the F.FWD/▶ button.

CLOCK SET			
MONTH DAY		YEAR	
03 /--			----
HOUR MINUTE		AM/PM	
-- : --			--

---

**5 Select the day**

Press the PLAY/▲ or STOP/▼ button until the desired day appears. (Example: 20th → 20)

Then, press the F.FWD/▶ button.

CLOCK SET			
MONTH DAY		YEAR	
03/20			----
HOUR MINUTE		AM/PM	
-- : --			--

---

**6 Select the year**

Press the PLAY/▲ or STOP/▼ button until the desired year appears.  
(Example: 2000)

Then, press the F.FWD/▶ button.

CLOCK SET			
MONTH DAY		YEAR	
03/20		2000	
HOUR MINUTE		AM/PM	
-- : --			--

---

**7 Select the hour**

Press the PLAY/▲ or STOP/▼ button repeatedly until your desired hour appears.  
(Example: 05)

Then, press the F.FWD/▶ button.

CLOCK SET			
MONTH DAY		YEAR	
03/01 MON		2000	
HOUR MINUTE		AM/PM	
05 : --			--

---

**8 Select the minute**

Press the PLAY/▲ or STOP/▼ button repeatedly until your desired minute appears.  
(Example: 40)

Then, press the F.FWD/▶ button.

CLOCK SET

MONTH DAY YEAR

03/01

MON2000

HOUR MINUTE

AM/PM

05 : 40

--

**9 Select "AM" or "PM"**

Press the PLAY/▲ or STOP/▼ button to point to "AM" or "PM"  
(Example: PM)

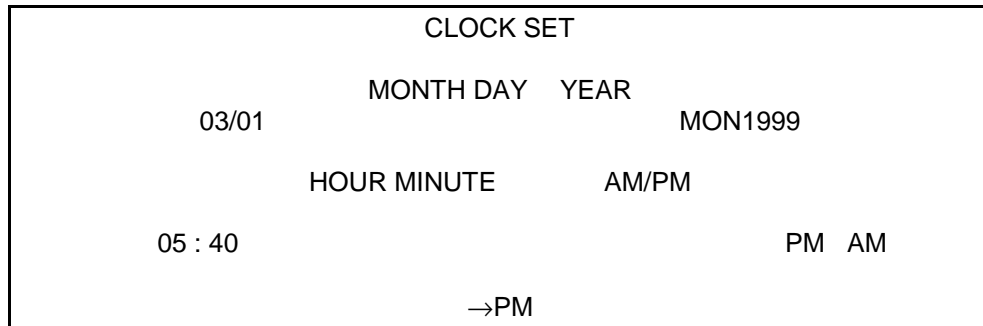

---

**10 Start the clock**

Press the RESET/EXIT or F.FWD/▶ button.

Although seconds are not displayed, they begin counting from 00 when you press the RESET/EXIT or F.FWD/▶ button. Use this feature to synchronize the clock with the correct time.

- When unplugging the AC-cord or if there is a power failure for more than 30 seconds, you may have to reset the clock.
- If the display shows an abnormal reading or no reading, unplug the power cord for more than 30 seconds. Then plug it back in and reset clock.

## DAYLIGHT-SAVINGS TIME

Select this feature and the VCR's clock automatically will advance one hour in April, then reverse one hour in October. Follow the steps below when you want to use this feature even if you set the AUTO CLOCK to ON.

When Daylight-Savings Time is ON, the clock's time will change automatically as follows:

**First Sunday of April: from 2:00AM to 3:00AM**

**Last Sunday of October: from 2:00AM to 1:00AM**

### NOTES:

- When programmed timer recordings start between 2:00AM-2:59AM on the First Sunday of April, the VCR will start recording at 3:00AM.
- When programmed timer recordings end between 2:00AM-2:59AM on the First Sunday of April, the VCR will stop recording at 3:00AM.



- **Use the remote control for this procedure.**
- Be sure to check that the "PWR." and the "VCR" indicators are both on.
- Turn on the TV and set the TV to channel 3 or 4. Now set the CH3/CH4 switch on the back of the VCR to match the channel selected on the TV.

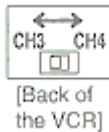

### 1 Select main menu

1 ) Press the MENU button until the main menu appears.

- If the clock is not set yet, CLOCK SET menu appears immediately when you press the MENU button. In this case, go to step [3].

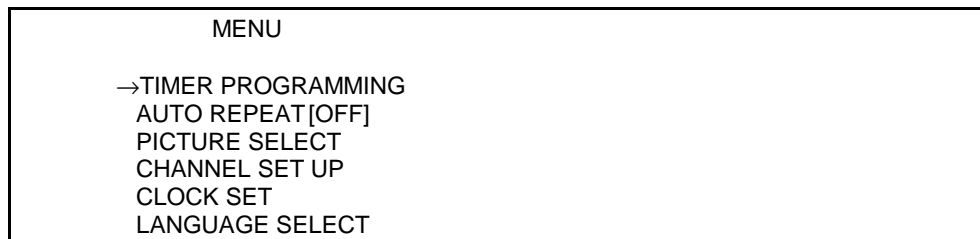

### 2 Select "CLOCK SET"

Press the PLAY/▲ or STOP/▼ button to point to "CLOCK SET". Then, press the F.FWD/▶ button.

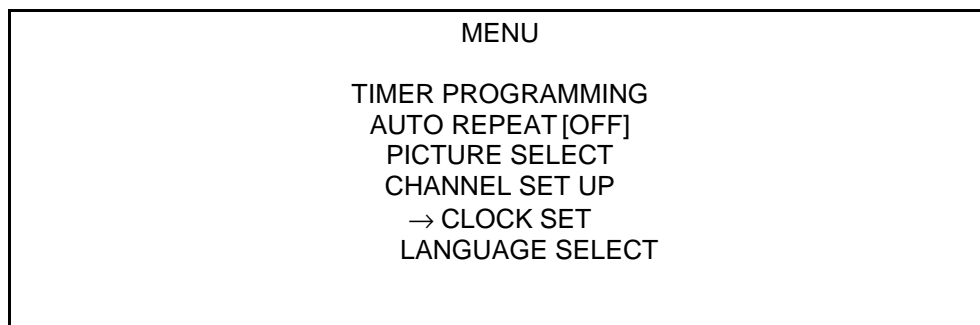

### 3 Set the "D.S.T." (Daylight-Savings Time) to [ON]

Press the PLAY/▲ or STOP/▼ button to point to "D.S.T.". Then, press the F.FWD/▶ button so that [ON] appears.

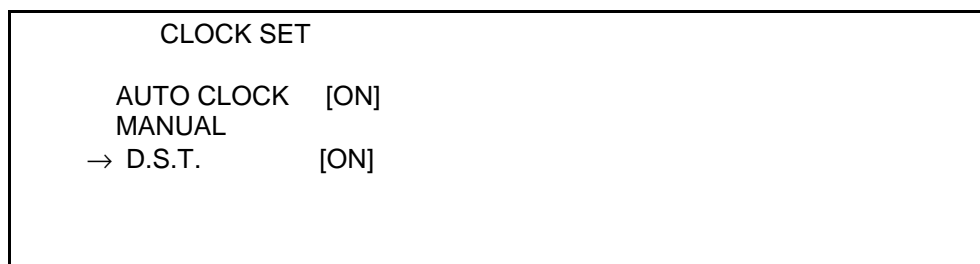

### 4 To return to TV mode

Press the RESET/EXIT button

## TO CANCEL THE DAYLIGHT-SAVINGS TIME

Repeat steps [1] to [3]. Then, press the F.FWD/▶ button so that [OFF] appears on the menu. Press the RESET/EXIT button to return to TV mode.

## TO DELETE OR ADD CHANNELS

The channels you no longer receive or seldom watch can be deleted from the memory. (Of course, you can later add the deleted channel into the memory again.)



- Use the remote control for this procedure.
- Be sure to check that the "PWR." and the "VCR" indicators are both on.
- Turn on the TV and set the TV to channel 3 or 4. Now set the CH3/CH4 switch on the back of the VCR to match

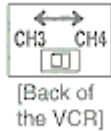

the channel selected on the TV.

### 1 Select main menu

Press the MENU button until the main menu appears.

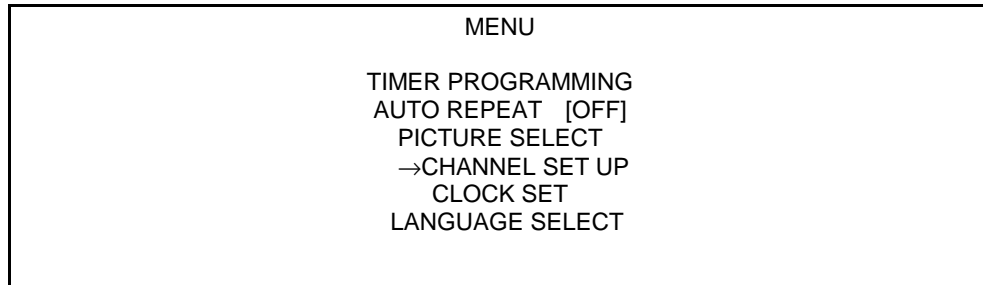

### 2 Select "CHANNEL SET UP"

Press the PLAY/▲ or STOP/▼ button to point to "CHANNEL SET UP".

Then press the F.FWD/▶ button.

### 3 Select "MANUAL SET UP"

Press the PLAY/▲ or STOP/▼ button to point to "MANUAL SET UP".

Then, press the F.FWD/▶ button.

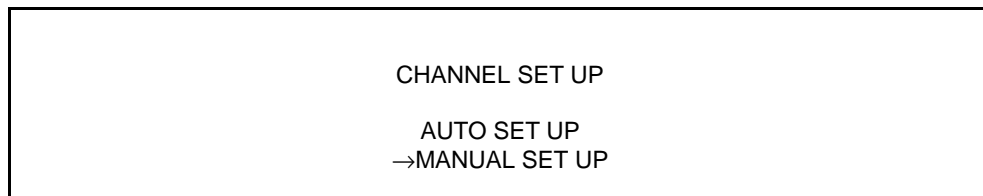

### 4 Enter the desired channel number

Press the number buttons or the PLAY/▲ or STOP/▼ button until your desired channel number appears. (Example: CH30)

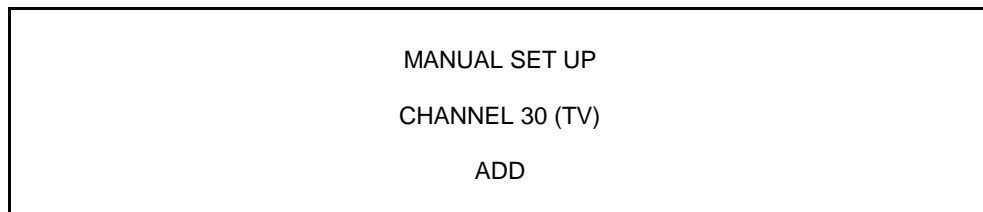

### 5 Delete it from memory

Press the F.FWD/▶ or REW/◀ button so that "DELETE" flashes on the TV screen.

- To delete another channel, repeat steps [4] and [5]
- If you press F.FWD/▶ or REW/◀ button again, the channel is memorized again.



- DELETED -

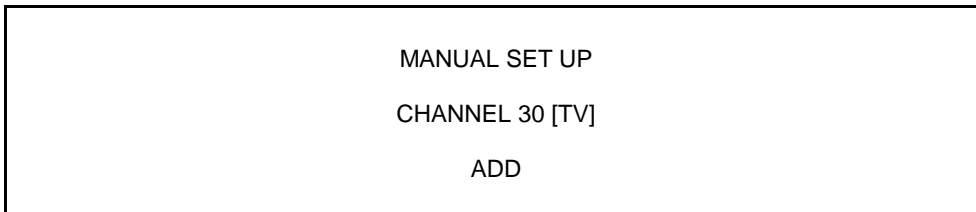

- MEMORIZED -

#### 6 Exit the preset mode

Press the RESET/EXIT button on the remote control to return to TV mode.

**NOTE:** To confirm that channel(s) has been deleted or added, press the CHANNEL(CH) ▲ or ▼ button.

## CHANNEL SET UP AGAIN

**Remember:** If your cable box or satellite box is connected as in Fig 4 on page 11 or Fig 5 on page 12, you DO NOT have to set up the channels. Just select the TV and VCR to channel 3 or 4 and also have the CH3/CH4 switch on the back of the VCR to match the channel you selected (CH 3 or CH 4). Now select the Box to the channel you wish to view or record.



• Use the remote control for this procedure.

- 1) Press the MENU button until the main menu appears.
- 2) Press the PLAY/▲ or STOP/▼ button to point to "CHANNEL SET UP". Then, press the F.FWD/▶ button.
- 3) Confirm "AUTO SET UP" is pointed to, then press the F.FWD/▶ button. After scanning, the tuner stops at the lowest memorized channel.

- The VCR distinguishes between standard TV channels and cable channels.

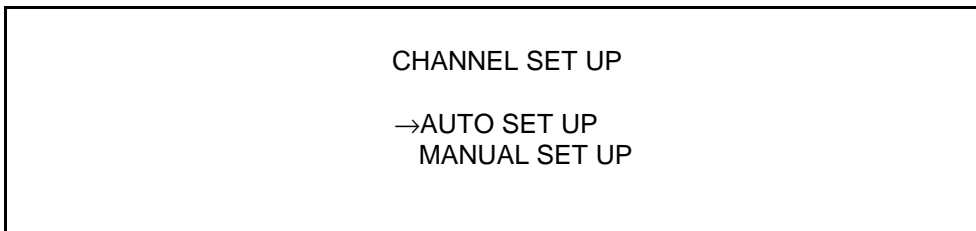

## SELECTING THE LANGUAGE

If you want to change the language on the TV screen, follow the steps below:

**Note:** This function effects only the language on the screen menu and not the audio source.



• Use the remote control for this procedure.

- 1) Press the MENU button until the main menu appears.
- 2) Press the PLAY/▲ or STOP/▼ button to point to "LANGUAGE SELECT". Then, press the F.FWD/▶ button.
- 3) Select "ENGLISH" or "ESPAÑOL"= Spanish by using the PLAY/▲ or STOP/▼ button.
- 4) Press the RESET/EXIT button to return to TV mode.

**NOTE:** If for some reason the menu is in Spanish, press MENU button until the main menu appears, press PLAY/▲ button to point to "SELEC.IDIOMA", press the F.FWD/▶ button, press the PLAY/▲ button to point to "ENGLISH", then press the RESET/EXIT button.



## MTS (Multi-Channel Television Sound) SYSTEM

You can record or listen to a program in MTS stereo, by using a stereo amplifier and speakers.

Connect your VCR to your stereo amplifier using the following diagram.

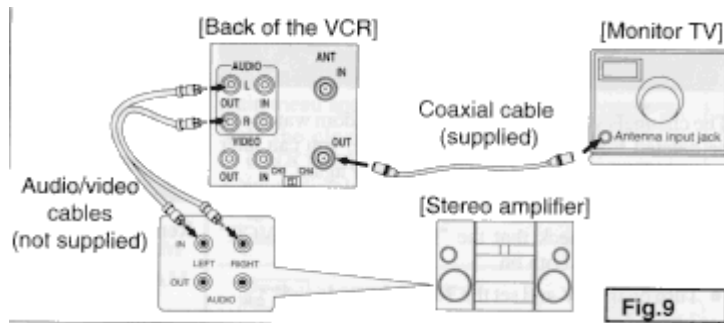
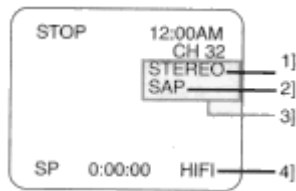

Fig.9

## CHECKING THE SELECTED MTS MODE

When you play a VHS tape, or receive a broadcast on the VCR tuner channel you are watching, the status shown below will appear when you press the DISPLAY button on the remote control.



SAP	Second Audio Program, which means your program, can also be received in a second language or sometimes a radio station.
HIFI	High Fidelity which produces better sound than standard stereo VCRs.

1] When a program is broadcast in stereo, STEREO appears on the TV screen.

2] When a program is broadcast in second audio, SAP appears on the TV screen.

3] When a program broadcast both in stereo and second audio, STEREO and SAP appear on the TV screen.

**NOTE:** Although a program may be broadcast in both stereo and second audio, you cannot record in both stereo and second audio at the same time.

4] While the VCR is set in HIFI stereo mode, HIFI appears on the TV screen. While the VCR is set in monaural (MONO) mode, HIFI disappears from the TV screen.

**NOTE:** If you play non-HIFI tapes while the VCR is set in HIFI, HIFI will disappear from the TV screen and the VCR will play automatically in monaural.

## MTS RECORDING/MONITOR MODE

Type of broadcast	Display on the TV screen	STEREO/SAP SELECTION	HI-FI audio track (2-channel)		Normal audio track
L-channel	R-channel				
Regular (monaural audio)	None	Invalid	Mono	Mono	Mono
Stereo broadcast	STEREO	Invalid	L	R	L & R
Bilingual broadcast	SAP	TV STEREO*	Main audio program	Main audio Program	Main audio program
SAP*	Sub audio program	Sub audio program	Sub audio parogram		
Stereo & Bilingual broadcast	STEREO SAP	TV STEREO*	L	R	L & R
SAP*	Sub audio program	Sub audio program	Sub audio program		

\* You must select the recording mode in TV STEREO or SAP when you record a broadcast. Refer to "TO SELECT STEREO OR SAP MODE" on the next page.

## SELECTING THE MTS SYSTEM

- Be sure to check that the "PWR" and "VCR" indicators are both on.
- Turn on the TV and set the TV to channel 3 or 4. Now set the CH3/CH4 switch on the back of the VCR to match the channel selected on the TV.

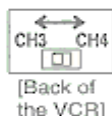

## TO SELECT THE HIFI MODE

### 1 Select main menu

Press the MENU button until the MENU 2 appears.



### 2 Select "AUDIO OUT"

Press the PLAY/▲ or STOP/▼ button to point to "AUDIO OUT". Then, press the F.FWD/▶ button.

### 3 Select "HIFI"

Press the PLAY/▲ or STOP/▼ button to point to "HIFI".

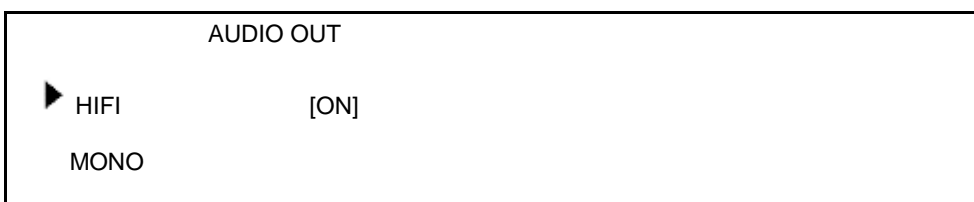

### 4 To return to TV mode

Press the RESET/EXIT button.

#### NOTES:

- Normally, "HIFI" should be selected for playback with HIFI sound.
- When you play non-HIFI tapes, the VCR will play automatically in the monaural mode.
- The VCR records automatically MTS broadcasts in HIFI stereo sound unless you select SAP mode recording before you begin recording.

## TO SELECT MONO MODE

You can change the selection to "MONO" if you want to listen to HIFI tapes in normal audio playback.

- 1) Press the MENU button until the MENU 2 appears.
- 2) Press the PLAY/▲ or STOP/▼ button to point to "AUDIO OUT". Then, press the F.FWD/▶ button.
- 3) Press the PLAY/▲ or STOP/▼ button to point to "MONO".
- 4) Press the RESET/EXIT button to return to TV mode.

## TO SELECT STEREO OR SAP MODE

### 1 Select main menu

Press the MENU button until the MENU 2 appears.



### 2 Select "TV STEREO" or "SAP"

2) Press the PLAY/▲ or STOP/▼ button to point to "TV STEREO" or "SAP" (depending which one you would prefer to select).

Then, press the F.FWD/▶ button.

### 3 To return to TV mode

Press the RESET/EXIT button.

#### NOTES:

- You must select the recording mode, either TV STEREO or SAP when you record a broadcast. Refer to "MTS RECORDING/MONITOR MODE" on previous page. When you play the tape on the VCR later, it will be in stereo or SAP.
- If you select second audio when second audio is not available, the VCR will record normal audio.

## PLAYBACK

### NORMAL PLAYBACK

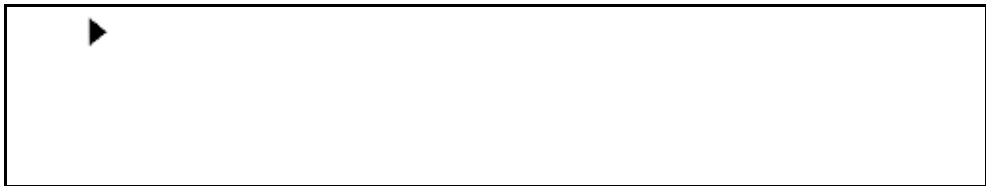
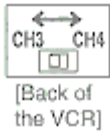

### PICTURE SEARCH

This feature is very useful in finding or skipping over a particular scene on a tape. In this mode, the sound will be muted.

- 1) You may view a video tape at a high speed in either a forward or reverse direction by pressing the F.FWD or REW button. (in the SP / LP / SLP modes)
- 2) Press it again and the VCR will now search in super high speed. (in the LP / SLP modes only)
- 3) Press the PLAY button to return to normal speed.

### STILL PICTURE

You can view a still picture on the TV screen during playback (the Still mode). Press the PAUSE button on the remote control during playback. Press the PLAY button to return to playback.

- You can advance the picture by one frame at a time by pressing the PAUSE button on the remote control during the still mode.
- If it is left in the Still mode for more than five minutes, the VCR will automatically switch to the Stop mode.

### VERTICAL HOLD CONTROL

In the Pause/Still mode only, if the picture begins to vibrate vertically, stabilize the picture by pressing the CHANNEL(CH) ▲ or ▼ button.

#### NOTES:

- If the picture is distorted or rolling vertically, adjust the vertical hold control on your TV, if equipped.
- Most newer TV's do not have a user adjustable vertical hold control.

## TRACKING ADJUSTMENT

• Tracking adjustment will be set automatically (Digital Tracking function) when you start playback. However when playing pre-recorded tapes or tapes recorded on units other than your own, noise lines (black and white streaks) may appear on the playback picture. If this occurs, you can adjust the tracking control manually by pressing CHANNEL ▲ or ▼ button **on the VCR** until the streaks disappear.

To return to the DTR function, stop the tape once and start playback again.

• You can reduce the noise lines by pressing the CHANNEL(CH) ▲ or ▼ button in slow mode, too. Slow tracking adjustment will not be set automatically.

**NOTE:** In Still mode, press the SLOW button and press the CHANNEL(CH) ▲ or ▼ button until the streaks disappear. To return to Still mode, press the PAUSE button on the remote control again.

## SLOW MOTION

Press the SLOW button on the remote control to reduce the playback speed. The VCR mutes the sound during slow motion. You can control the speed by pressing the F.FWD button (faster) or the REW button (slower).

Press the PLAY button to return to normal playback.

**NOTE:** If it is left in the Slow mode for more than five minutes, the VCR will automatically switch to the Stop mode.

## COUNTER MEMORY

Use this feature to memorize the beginning point that you want to return to. And you can search it easily by rewinding or fast forwarding.



• Use the remote control for the following procedure.

- Be sure to check that the "PWR." and the "VCR" indicators are both on.
- Turn on the TV and set the TV to channel 3 or 4. Now set the CH3/CH4 switch on the back of the VCR to match the channel selected on the TV.

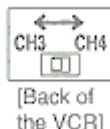

• This feature only works with a prerecorded tape.

---

### 1 Stop tape at your desired point

Insert a prerecorded tape. Rewind or fast forward the tape to the beginning point at which you want to mark.

### 2 Reset the counter to 0:00:00

Press the COUNTER RESET button on the remote control. If necessary press the COUNTER RESET button again to reset the counter to 0:00:00.

### 3 Select the Counter Memory mode

Press the COUNTER MEMORY button on the remote control until "M" appears on the TV screen.

• The COUNTER MEMORY button does not function if the Auto Repeat mode is set to [ON]. In this case, set the Auto repeat mode to [OFF].

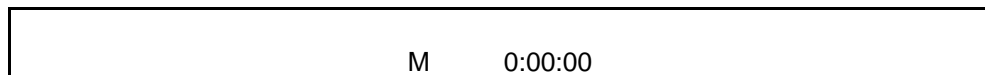

---

### 4 Begin recording or playback

Press the REC or PLAY button.

Press the STOP button when recording or playback is completed.

### 5 To activate the Counter Memory

Press the REW (or F.FWD) button, the VCR will stop automatically when the counter has returned to approximately 0:00:00.

**NOTE:** The displayed time will not change during blank portions on the tape.

## TO EXIT THE COUNTER MEMORY

Press COUNTER MEMORY button on the remote control so that "M" *disappears* from the TV screen.

On more information concerning the on screen display, please refer to page 33.

## SPECIAL PLAYBACK

- Use the remote control for the following procedure.
- Be sure to check that the "PWR." and the "VCR" indicators are both on.
- Turn on the TV and set the TV channel to 3 or 4. Now set the CH3/CH4 switch on the back of the VCR to match the channel selected on the TV.

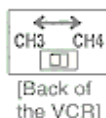

## AUTO REPEAT PLAYBACK

The VCR has the auto repeat function that allows you to repeat a tape indefinitely without touching the PLAY button. Make sure to insert a prerecorded tape.

### 1 Select main menu

Press MENU button until the main menu appears.

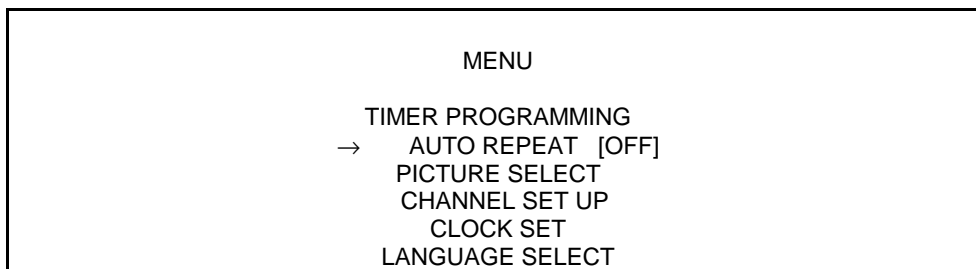

### 2 Select "AUTO REPEAT"

Press the PLAY/▲ or STOP/▼ button to point to "AUTO REPEAT".

### 3 Begin Auto repeat playback

Press the F.FWD/▶ button so that [ON] will appear next to "AUTO REPEAT" on the TV screen.

When in Stop mode, Repeat playback mode will start automatically.

If the on-screen menu still remains, press the RESET/EXIT button to exit the menu.

- Once you select the Auto Repeat mode, it stays in effect even after you turn off the VCR.
- The COUNTER MEMORY button does not function if the Auto Repeat mode is set to [ON]. In this case, set the Auto Repeat mode to [OFF].
- To stop playback, press the STOP button.

## TO EXIT THE AUTO REPEAT MODE

Repeat steps [1 ] to [2], Then, press the F.FWD/▶ button. [OFF] will then appear on the menu. Then, press the RESET/EXIT button to return to TV mode

**Power failure:** If there is a power failure for more than 30 seconds, Auto Repeat Playback will go to off.

## PICTURE SELECT

This function enables you to select the picture quality of a tape.

- This selection must be done during playback.

### 1 Insert a tape into VCR

Begin playback.

### 2 Select main menu

Press the MENU button until the main menu appears.

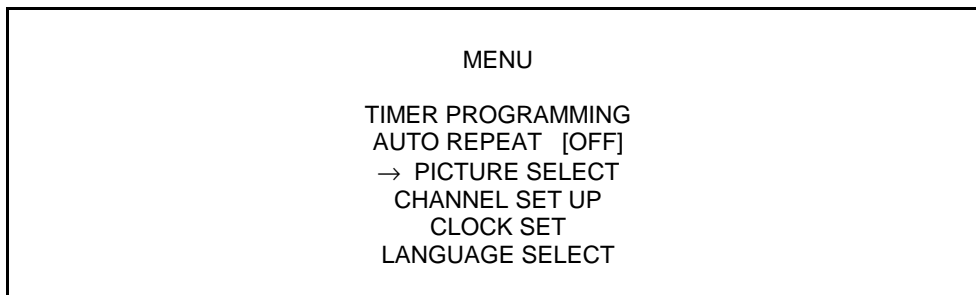

### 3 Select "PICTURE SELECT"

Press the PLAY/▲ or STOP/▼ button to point to "PICTURE SELECT".

### 4 Select your desired mode

Press the F.FWD/▶ button until your desired mode (NORMAL, SOFT or SHARP) appears on the TV screen..

- Once you select the Picture Select mode, it stays in effect even after you turn off the VCR.
- To stop playback, press the STOP button.

**Power failure:** If there is a power failure for more than 30 seconds, Picture Select will go to NORMAL.

## INDEX SEARCH

This feature provides a method of indexing a recordings starting point so that it can be easily returned to in either fast forward or rewind mode.

- The index mark will be made automatically when the REC button is pressed. It will also be marked at the starting point of Timer recording and IRT.
- The index mark will not be recorded if the PAUSE button on the remote control is pressed and released during recording.
- The time gap between making the index marks on the tape should be greater than 1 minute for SP recording, 2 minutes for LP recording and 3 minutes for SLP recording.

**Example:** You are watching program number 4 and want to fast forward to program number 7. You must skip three programs.

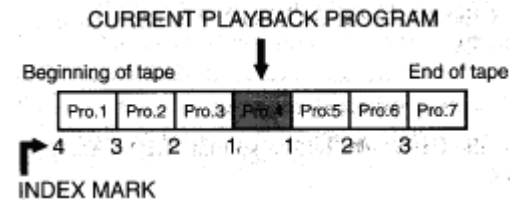

### 1 Select "INDEX SEARCH"

Press the INDEX SEARCH button on the remote control.

### 2 Enter your desired number

Press the PLAY/▲ or STOP/▼ or INDEX SEARCH button until the number of programs that you want to skip appears.

(Example: "03" for 3 programs)

INDEX SEARCH  
03

- The Index Search mode will be cancelled if the procedures are not activated in 30 seconds.

### 3 Begin Index Search

Press the REW or F.FWD button. The VCR begins rewinding or fast forwarding to the beginning of desired program.

**NOTE:** Every time an index signal is skipped, the number in the program indicator decreases by one.

### 4 After Index Search

When the preset program is reached, the VCR will start playback automatically.

- A video cassette must be inserted in the VCR for this function to work
- The number of Index Searches can be set up to 20.
- This function will not operate in the recording mode.
- When you want to cancel the Index Search while in progress, press the STOP button.

## QUICK-FIND

This function enables you to search and confirm the contents of the recorded program(s) using the index mark.

The VCR begins fast forwarding by selecting this function. When the VCR find the beginning of the program (=the index mark), the VCR begins playback video tape at high speed for 30 seconds. Then, return to fast forwarding again to the beginning of next program. The VCR repeats these operation to the tape end.

Concerning the index mark, please see "INDEX SEARCH" section.

- Tape must be fully rewound.

### 1 Select "QUICK-FIND" mode

Press the QUICK-FIND button on the remote control.

QUICK-FIND



## TO SKIP TO THE BEGINNING OF NEXT PROGRAM

Press the QUICK-FIND button on the remote control.

## TO VIEW AT NORMAL SPEED

Press the PLAY button. The Quick-Find is cancelled.

- A video cassette must be insert in the VCR for this function to work.
- This function will not operate in the recording mode.
- When you want to cancel the Quick-Find while in progress, press the STOP button.
- When the end of a tape is reached during the Quick-Find, the tape will automatically rewind to the beginning. After rewinding finishes, the VCR will eject the tape and turn itself to off.

## TIME SEARCH

The Time Search function makes it possible to quickly advance the tape to your desired position simply by entering the exact amount of playback time you want to skip.

**Example:** To watch a program after 2 hours and 50 minutes from the present position, in either direction.

---

### 1 Select "TIME SEARCH"

Press the TIME SEARCH button on the remote control..

### 2 Enter your desired time

Press the PLAY/▲ or STOP/▼ button until your desired time appears. ("2:50" stands for 2 hours 50 minutes)

- The Time Search mode will be cancelled if the procedures are not activated in 30 seconds.



---

### 3 Begin Time Search

By pressing the REW or F.FWD button, the VCR will rewind or fast forward to the specified point. The time counts down as the searching progresses.

### 4 After Time Search

Playback starts automatically when 0:00 is reached.

- A video cassette must be inserted in the VCR for this function to work.
- Time Search can be set up to a maximum of 9 hours 59 minutes (9:59).
- This function will not operate in the recording mode.
- When you want to cancel the Time Search while in progress, press the STOP button.

## RECORDING

- Please refer to the connection you are using, through pages 10, 11, or 12 on "ANTENNA/CABLE CONNECTIONS" before continuing.
- Be sure to check that the "PWR." and the "VCR" indicators are both on.
- Turn on the TV and set the TV to channel 3 or 4. Now set the CH3/CH4 switch on the back of the VCR to match the channel selected on the TV.

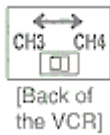

- Insert a cassette tape with its erase prevention tab in place. (If necessary, rewind or fast forward the tape to the point at which you want to begin recording.)
- You must select the recording mode in TV STEREO or SAP when you record a broadcast. Refer to "SELECTING THE MTS SYSTEM" on page 21.

## VIEWING AND RECORDING THE SAME PROGRAM

### 1 Select the channel to be recorded

Press the number buttons on the remote control or the CHANNEL (CH) ▼ or ▲ button.

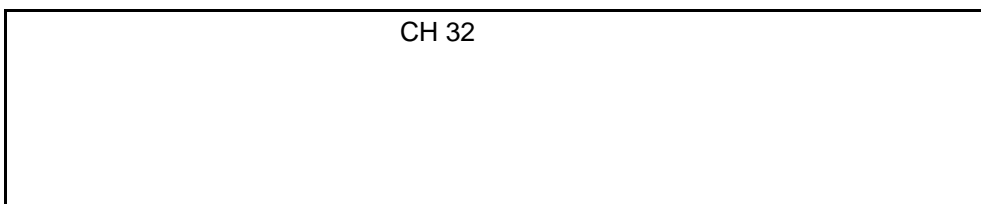

**NOTE:** If you have a cable box or satellite box connected to this VCR, please refer to "ANTENNA/CABLE CONNECTIONS" on pages 11 and 12 before proceeding to the next step.

### 2 Select the tape speed

Press the TAPE SPEED button on the remote control to select the desired tape speed (SP/SLP).



### 3 Begin recording

Press the REC button. The "REC" indicator appears on the display.



**NOTE:** If any menu is activated on the TV screen, the REC button on the remote control does not function. Press the RESET/EXIT button to clear the menu. Then, press the REC button.

### 4 Stop recording

Press the STOP button when recording is completed.



## SKIPPING UNWANTED SCENES DURING RECORDING

Press the PAUSE button on the remote control to temporarily stop recording.  
Press the PAUSE or REC button to resume recording.

Press the PAUSE or REC button to resume recording.



**NOTE:** When the VCR is in the Pause mode, you may view the time remaining with ■ marks on the TV screen. Each ■ mark represents one minute. After five minutes, the VCR will automatically switch to the Stop mode to prevent tape damage. When there is 1 minute remaining, one ■ will flash.

## RECORDING ONE PROGRAM AND VIEWING ANOTHER

You can record one program while viewing another. To start recording, follow steps [1] to [3] under "VIEWING AND RECORDING THE SAME PROGRAM".

To select the channel you want to view at the TV, follow the steps below.

**NOTE:** If you have a cable box or satellite box connected to this VCR, please refer to "ANTENNA/CABLE CONNECTIONS" on pages 11 and 12 before proceeding to the next step.

### 4 Select the TV mode

Press the VCR/TV button on the remote control so that the "VCR" indicator on the VCR's digital display disappears

### 5 Select the channel on the TV

Set the TV to the channel you want to watch.

## TO MONITOR THE PROGRESS OF YOUR RECORDING

- 1) Press the VCR/TV button on the remote control so that the "VCR" indicator on the display comes on.
- 2) Turn on the TV and set the TV channel to 3 or 4. Now set the CH3/CH4 switch on the back of the VCR to match the channel selected on the TV.

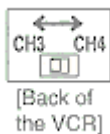

## IRT (Instant Recording Timer)

This function enables you to set the recording length simply by pressing the REC/IRT button on the VCR.

- Please refer to the connection you are using, through pages 10, 11, or 12 on "ANTENNA/CABLE CONNECTIONS" before continuing.
- You cannot use the remote control for this function.
- Be sure to check that the "PWR." and the "VCR" indicators are both on.
- Turn on the TV and set the TV to channel 3 or 4. Now set the CH3/CH4 switch on the back of the VCR to match the channel selected on the TV.

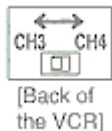

- Insert a cassette tape with its erase prevention tab in place. (If necessary, rewind or fast forward the tape to the point at which you want to begin recording.)

PUSH(ES)	DISPLAY	RECORDED LENGTH
1 push		(normal recording)
2 pushes	0:30	30 minutes
3 pushes	1:00	60 minutes
↓	↓	↓
17 pushes	8:00	480 minutes
18 pushes		(normal recording)

**NOTE: If you have a cable box or satellite box connected to this VCR, please refer to "ANTENNA/CABLE CONNECTIONS" on pages 11 and 12 before proceeding to the next step.**

---

### **1 Select the channel to be recorded**

Press the number buttons on the remote control or the CHANNEL(CH) ▼ or ▲ button.

### **2 Select the tape speed**

Press the TAPE SPEED button on the remote control to select the desired tape speed (SP/SLP).

### **3 Begin IRT**

Press the REC/IRT button on the VCR as many times as needed. The recording length will be determined by the number of times you press the REC/IRT button.

Each additional push will increase the recording time by 30 minutes. It can be set for up to 8 hours.



- Recording starts immediately when the REC/IRT button is pressed, whether you are watching the same or a different channel.
- When the REC/IRT button is pressed 18 times, the VCR returns to the normal recording mode.
- To stop the IRT operation, press the STOP button on the VCR or on the remote control.
- To show the remaining time, press the DISPLAY button on the remote control so that "IRT" appears on the TV screen. (It will show up momentarily then disappear.)
- Recording stops when 0:00 is reached.
- Please note that in the SLP mode maximum recording time, assuming the tape is started at the beginning, is 8 hours using T-160 (or 6 hours using T-120).
- The TV that is connected to your VCR may be turned on or off during IRT.
- If the tape runs out before the end time, the VCR will switch to the Stop mode immediately, eject the tape and turn power off.

# TIMER RECORDING

## AUTOMATIC TIMER RECORDING

You may set the VCR to start and end a recording while you are away. You can set seven programs to record on specific days, daily or weekly within a 1 year period.

*In the example below, the timer is being set to record:*

DATE: May 4th, 2000  
SETTING TIME: from 7:30PM to 8:30PM  
CHANNEL: CH16  
TAPE SPEED: SP  
PROGRAM NO: No. 1

• Please refer to the connection you are using, through pages 10, 11, or 12 on "ANTENNA/CABLE CONNECTIONS" before continuing.



• Use the remote control for this procedure.

- Be sure to check that the "PWR." and the "VCR" indicators are both on to program it.
- Turn on the TV and set the TV to channel 3 or 4. Now set the CH3/CH4 switch on the back of the VCR to match the channel selected on the TV.

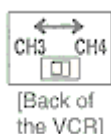

- Clock must be set to the correct time and date before setting the timer.
- Insert a cassette tape with its erase prevention tab in place. (If necessary, rewind or fast forward the tape to the point at which you want to begin recording.)

### *Avoid overlap of programs ...*

There is a case that a program will not be performed.

When programs overlap:

- The program with an earlier start time has priority.
- Once the earlier program finishes, the overlapping programs will begin recording in sequence.
- The illustration below demonstrates the sequence of recordings.

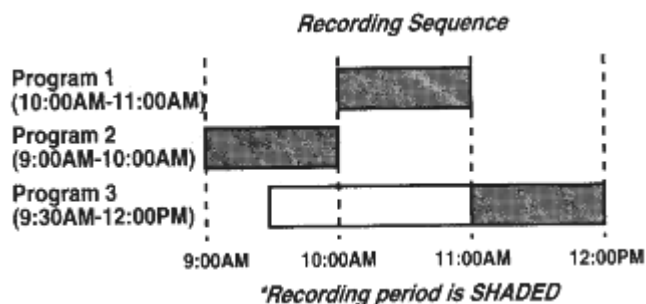

### **1 Select "TIMER PROGRAMMING"**

First, press the MENU button until the main menu appears.

Next, press the PLAY/▲ or STOP/▼ button to point to "TIMER PROGRAMMING". Then press the F.FWD/▶ button.

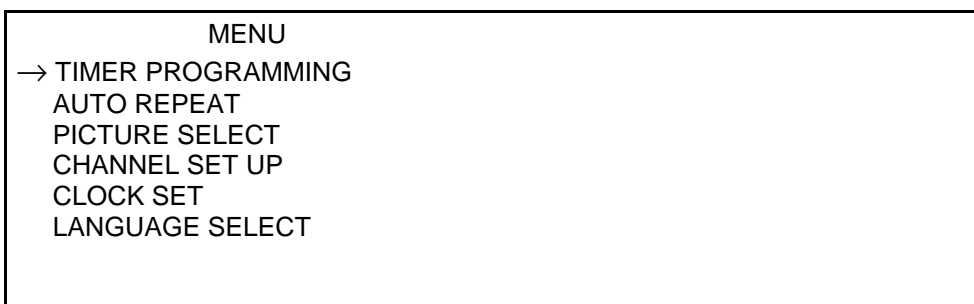

**NOTE:** If you have not yet set the clock, "CLOCK SET" appears. If so, continue with step [3] on page 16 or 17. Then, set the timer recording.

---

**2 Select your desired program number (1-7)**

Program number which is not set up flashes.

Press the PLAY/▲ or STOP/▼ button until your desired program number appears. (Example: 1)

Then, press the F.FWD/▶ button.

PROGRAM NUMBER 1  
DATE -- / --  
START TIME -- / -- --  
END TIME -- / -- --  
CHANNEL --  
REC SPEED --

---

**3 Select once, daily, or weekly recording**

*For once recording:*

Press the PLAY/▲ or STOP/▼ button to point to "ONCE", and then press the F.FWD/▶ button.

PROGRAM NUMBER 1

→ONCE  
DAILY  
WEEKLY

*For daily recording:* To record a TV program at the same time on the same channel from Monday through Friday.

Press the PLAY/▲ or STOP/▼ button to point to "DAILY", and then press the F.FWD/▶ button.

PROGRAM NUMBER 1

→ ONCE  
DAILY  
WEEKLY

*For weekly recording:* To record a TV program at the same time on the same channel every week.  
(Example: every Monday on ch 7 at 5:00PM)

Press the PLAY/▲ or STOP/▼ button to point to "WEEKLY", and then press the F.FWD/▶ button.

PROGRAM NUMBER 1

ONCE  
DAILY  
→ WEEKLY

- When you press the F.FWD/▶ button during steps [4] to [10], you may move to the next step.
- Press the REW/◀ button to go back one step from the current step during steps [2] to [10].

---

**4 Set the date when you want to start**

First, press the PLAY/▲ or STOP/▼ button until the desired month appears.  
(Example: "05" for May)

Then, press the F.FWD/▶ button.

Next, press the PLAY/▲ or STOP/▼ button until the desired day appears, and then press the F.FWD/▶ button. (Example: "04" for 4th)

ONE TIME PROGRAM

PROGRAM NUMBER 1  
DATE 05/04 THU  
START TIME -- : -- --  
END TIME -- : -- --  
CHANNEL --  
REC SPEED --

---

**5 Set the start hour**

Press the PLAY/▲ or STOP/▼ button until the desired hour appears. (Example: 07)

Then, press the F.FWD/▶ button.

```
ONE TIME PROGRAM
PROGRAM NUMBER  1
DATE            05/04  THUR
START TIME     07: -- --
END TIME       -- : -- --
CHANNEL        --
REC SPEED      --
```

---

**6 Set the start minute**

Press the PLAY/▲ or STOP/▼ button until the desired minute appears. (Example: 30)

Then, press the F.FWD/▶ button.

Next, press the PLAY/▲ or STOP/▼ button to point to "AM" or "PM". (Example: PM) Then, press the F.FWD/▶ button.

```
ONE TIME PROGRAM
PROGRAM NUMBER  1
DATE            05/04  THU
START TIME     07:30 PM
END TIME       -- : -- --
CHANNEL        --
REC SPEED      --
                                     AM
                                     → PM
```

---

**7 Set the end hour**

Press the PLAY/▲ or STOP/▼ button until the desired hour appears. (Example: 08)

Then, press the F.FWD/▶ button.

```
ONE TIME PROGRAM
PROGRAM NUMBER  1
DATE            05/04  THU
START TIME     07: 30 PM
END TIME       08: -- --
CHANNEL        --
REC SPEED      --
```

---

**8 Set the end minute**

Press the PLAY/▲ or STOP/▼ button until the desired minute appears. (Example: 30) Then, press the F.FWD/▶ button.

Next, press the PLAY/▲ or STOP/▼ button to point to "AM" or "PM". (Example: PM) Then, press the F.FWD/▶ button.

```
ONE TIME PROGRAM
PROGRAM NUMBER  1
DATE            05/04  THU
START TIME     07: 30 PM
END TIME       08: 30 PM
CHANNEL        --
REC SPEED      --
                                     AM
                                     → PM
```

---

**9 Set the channel number**

Press the PLAY/▲ or STOP/▼ button until the desired channel number appears. (Example: 16) Then, press the F.FWD/▶ button.

• Remember refer to "ANTENNA/CABLE CONNECTIONS" on pages 11 and 12 if you have a cable box or satellite box before setting the channel number.

```

ONE TIME PROGRAM

PROGRAM NUMBER  1
DATE            05/04  THU
START TIME     07: 30 PM
END TIME       08: 30 PM
CHANNEL        16
REC SPEED      --

```

### 10 Set the tape speed

Press the PLAY/▲ or STOP/▼ button until the desired tape speed appears. (Example: SP)

```

ONE TIME PROGRAM

PROGRAM NUMBER  1
DATE            05/04  THU
START TIME     07: 30 PM
END TIME       08: 30 PM
CHANNEL        16
REC SPEED      SP
                →SP
                SLP

```

### 11 Finish setting the program

Press the F.FWD/▶ button. Program 1 is now completed.

- To set another program, repeat steps [2] to [11].
- Press the RESET/EXIT button to return to original mode.

### 12 Set the timer

Press the POWER button to turn off. The "☑" indicator on the display comes on.

- Please see "HINTS FOR TIMER RECORDING" for more information.

## HINTS FOR TIMER RECORDING

- If there is a power failure or the VCR is unplugged for more than 30 seconds, the clock setting and all timer settings will be lost.
- If the tape runs out before the end time, the VCR will switch to the Stop mode immediately, eject the tape and the VCR power will be turned off. The "☑" indicator will flash.
- If a tape is not in the VCR or does not have the erase-protection tab, the "☑" indicator flashes and timer recording cannot be performed. Please insert a recordable tape.
- The TV that is connected to your VCR may be turned ON or OFF when the VCR is in the timer-record mode.

## TO CHECK THE AUTOMATIC TIMER PROGRAM.

- 1) Turn the power on.
- 2) Press the MENU button. The details of the your program appear on the TV screen.

```

TIMER PROGRAMMING

DATE STA/END    CH
→ 1  05/04 07:30 PM  16
      THU  08:30 PM   SP
      3  05/11 10:00 PM 125
      W THU 10:54 PM   SLP
      5  05/21 11:00 PM  40
      DAILY 11:30 PM   SLP

```

- If the program you wish to check is not on the screen, press the PLAY/▲ or STOP/▼ button until your desired program appears.
- 3) Press the RESET/EXIT button to return to original mode.
- 4) Press the POWER button to return to timer stand-by mode.

## TO CORRECT OR CANCEL AN AUTOMATIC TIMER PROGRAM

- 1) Turn the power on.
- 2) Press the MENU button. The details of your program appear on the TV screen.

TIMER PROGRAMMING			
	DATE	STA/END	CH
→ 1	05/04	07:30 PM	16
	THU	08:30 PM	SP
3	05/11	10:00 PM	125
	W THU	10:54 PM	SLP
5	05/21	11:00 PM	40
	DAILY	11:30 PM	SLP

- 3) Select the program which you want to correct or cancel using the PLAY/▲ or STOP/▼ button.
  - If the program you wish to correct or cancel is not on the screen, press the PLAY/▲ or STOP/▼ button until your desired program appears.

**NOTE:** If some empty program numbers exist, the lower program number appears on the TV screen by pressing the REW/◀ button.

In this case, you can enter the new program. Press the F.FWD/▶ button during program number flashes, then continue with the step [3] in the "AUTOMATIC TIMER RECORDING" section.

- 4) Press the F.FWD/▶ button.

ONE TIME PROGRAM	
PROGRAM NUMBER	1
DATE	05/04 THU
START TIME	07:30 PM
END TIME	08:30 PM
CHANNEL	16
REC SPEED	SP

- To cancel the program, press the REW/◀ button during the program number flashes.
  - To correct the program, go to the digit you want to change by using the F.FWD/▶ button or REW/◀ button. Then, enter the correct numbers using the ▲/PLAY or ▼/STOP button.
- 5) Press the RESET/EXIT button to return to original mode.
  - 6) Press POWER button to return to timer stand-by mode.

## TO STOP A STARTED AUTOMATIC TIMER PROGRAM

Press the STOP/EJECT button on the VCR.

**NOTE:** The STOP button on the remote control will not function in Automatic Timer Recording mode.

## COPYING A VIDEO TAPE

You can make copies of video tapes made by friends or relatives for your enjoyment.

**Warning:** Unauthorized recordings of copyrighted video tapes may be an infringement of copyright laws.

Connect the editing (recording) VCR (this unit), source (playing) VCR (another VCR) and your TV using the following diagram.

### NOTE:

- You can use the audio and video input jacks on the front panel of the editing (recording) VCR instead of using the jacks on the back.
- When you connect a monaural VCR (another source) to this VCR, connect the Audio output jack of the monaural VCR (another source) to the AUDIO IN L jack of this VCR. The audio signal will be recorded in both L and R channel equally.

Fig. 10:

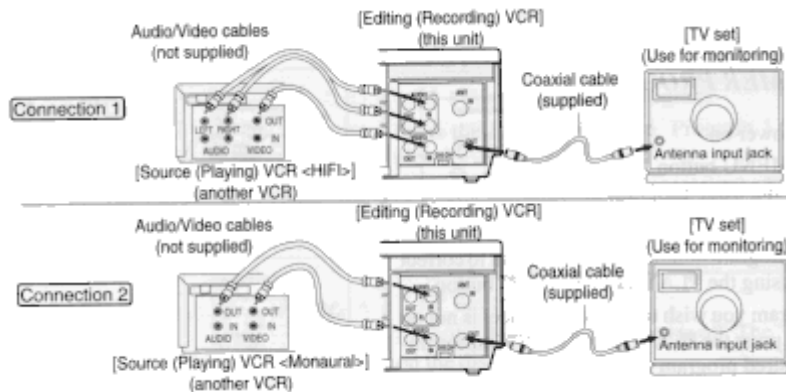

- 1) Insert a pre-recorded video cassette into the source (playing) VCR.
- 2) Insert a blank video cassette, or one you want to record over, into the editing (recording) VCR cassette compartment.
- 3) Press the TAPE SPEED button on the remote control on the editing (recording) VCR to select the desired recording speed (SP/SLP).
- 4) Select the "LineIn Rear (L1)" or "LineIn Front (L2)" position on the editing (recording) VCR. See page 13, under "Connecting to input jacks".
- 5) Press the REC button on the editing (recording) VCR.
- 6) Begin playback of the tape in the source (playing) VCR.

- For best results during dubbing, use the VCR's front panel controls whenever possible. The remote control might affect the playback VCR's operation.
- Always use video-quality shielded cables with RCA-type connectors. Standard audio cables are not recommended.
- You can use a video disc player, satellite receiver, or other audio/video component with A/V outputs in place of the playback VCR.
- If video or color fades in and out you may be copying a copy guarded video tape.

## TO MONITOR THE RECORDING

- 1) Turn on the TV and set the TV to channel 3 or 4. Now set the CH3/CH4 switch on the back of the VCR to match the channel selected on the TV.

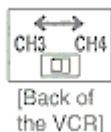

- 2) Press the VCR/TV button on the remote control on the editing (recording) VCR so that the "VCR" indicator on the display comes on.



## ON SCREEN DISPLAY

**NOTE:** VCR power and the "VCR" indicator must be on.

• To check the Count, Clock and Channel number, press the DISPLAY button on the remote control. Each time you press the DISPLAY button, TV screen will change as shown below.

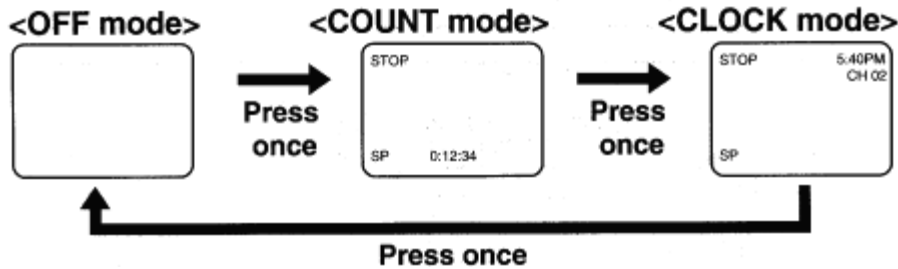

• It is normal for the status display (STOP, PLAY etc.) and the tape speed display (SP, LP, (playback only), or SLP) to disappear after 5 seconds.

1. **PWR. (power) indicator-** Lights up when the power is turned on.
2.  **indicator-** Lights up when a timer recording or an IRT has been set. Flashes if a tape is not inserted in the VCR even if you set a timer.
3. **Cassette indicator-** Lights up when there is a tape in the VCR.
4. **VCR indicator-** Indicates that the VCR is in the VCR position.
5. **REC indicator-** Lights up when the VCR is in the Recording mode. Flashes when a recording has been paused.
6. **Clock/Feature/Channel/Speed indicator-** Indicates the current time (when the clock is set), and briefly displays which feature the VCR is currently performing as the illustration. Indicates the channel number (when it is set). Indicates the tape speed (when it is changed).

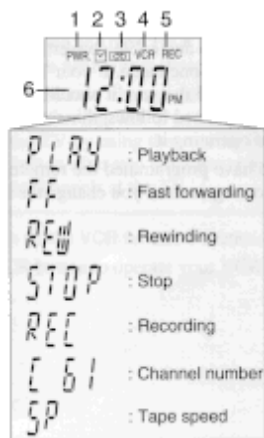

## SPECIAL FEATURES

### REAL TIME TAPE COUNTER

- This shows the elapsed recording or playback time in hours, minutes, and seconds. (The displayed time will not change during blank portions on the tape.)
- The "-" indication will appear when the tape is rewound further than "0:00:00" on the tape counter.

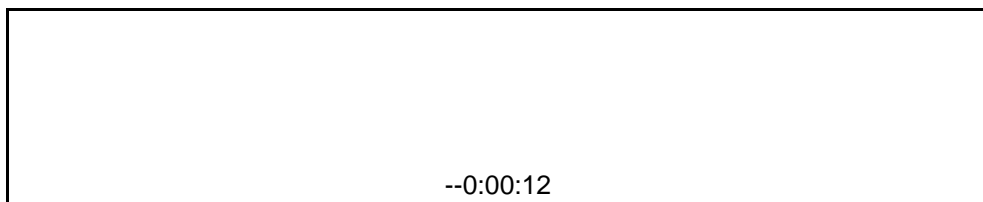

### AUTO REWIND

When the end of a tape is reached during recording, playback, or fast-forward, the tape will automatically rewind to the beginning. After rewinding finishes, the VCR will eject the tape and turn itself to off.

- The tape will not auto-rewind during timer recording or Instant Recording Timer.
- When the Counter Memory is activated, the tape will rewind to the M0:00:00 and the VCR will go into the Stop mode.

## CONTROLLING YOUR TV OR CABLE CONVERTER WITH THE VCR'S REMOTE

This Hitachi remote control can be used with your TV as well as the VCR, as long as your TV comes with a remote control. This feature comes in handy--you don't have to juggle two remotes.

The remote control is compatible with the fifteen makers of TV's listed below--but don't be alarmed if yours is not on our list. You may still be able to program the remote for your TV.

Every TV that comes with a remote control is set up to detect certain infrared signals. You need to program the VCR's remote control to send signals that your TV will recognize and respond to. Here's what to do:

### Compatibility

- The remote control is designed to be operated with many televisions and cable converters, but will not work with every one made. If your TV or cable box does not respond the way it should when you program it as explained follows, this remote may be incapable of operating it.
- Once you have programmed the remote, you won't have to do it again until you change the batteries.

## REMOTE CONTROL OF THE CABLE CONVERTER

If you have a cable converter, you will probably want to program your VCR's remote control so you can easily change channels. The process is the same as for programming the remote to operate your TV.

## PROGRAMMING THE REMOTE CONTROL OF THE CABLE CONVERTER

### 1 Program the remote control

Hold down the CATV button and press the number of your brand of cable box (shown in the chart).

**NOTE:** If that button combination does not work, or if your brand is not on the chart, just go through all the button combinations until you find the one that works best.

Cable Converters	Press the CATV and This Number
Jerrold 1	1
Jerrold 2	2
Jerrold 3	3
Hamlin	4
Zenith	5
Scientific Atlanta	6
Pioneer	7
Philips	8

## TO OPERATE THE CABLE BOX ONCE THE REMOTE IS PROGRAMMED FOR IT

### 1 Press the CATV button and then the button of the function you want.

*For example;*

Press the CATV button and the CH(▲), and the cable converter station will change to the next higher station.

**NOTE:** Also, you may change the channels at the cable converter by using the number buttons. If you can not change the channels at the cable converter by using the number buttons, press the ENTER button after you press the number buttons. It may change channels at the cable converter.

### 2 Press the VCR button to operate your VCR with the remote again.

# REMOTE CONTROL OF THE TV

## 1 Turn on the TV

Turn on the TV (any channel is okay).

## 2 Program the remote control

Aim the VCR's remote control at your TV set. Hold down the TV button (not the VCR/TV button) while you press the number corresponding to your brand of television as shown in the chart.

*For example;*

If you have an RCA television, press the TV and 0 at the same time. If this button combination sends a signal that matches with your TV, the channel will change on the TV, and you'll know the remote is set to control the television.

### NOTES:

- If that button combination does not change the TV channel, go through the whole list of button combinations one by one until you find one that does change your TV channel.
- Also, if your brand of TV is not listed in the chart, try all the number buttons. One of them may work for you.
- If the TV channel still doesn't change after going through all the button combinations listed, it is likely that you will not be able to program this remote control for your TV.

TV Brands	Press the TV and This Number
Hitachi	1
Zenith	2
Sony	3
Magnavox	4
Sanyo	5
Gold Star	6
Toshiba	7
Funai	8
Panasonic 2	9
RCA	0
Panasonic 1	CH (▲ up arrow)
Mitsubishi	CH (▼ down arrow)
JVC	+100/ENTER
Sharp 1	MEMORY
Sharp 2	DISPLAY

# CONTROLLING THE TV

Once programmed, the VCR's remote control is ready to control the TV.

### NOTE:

Be aware that not all of your TV's functions may work even though the remote control is correctly programmed.

## 1. Select the TV function mode

First press the TV button to change to the TV function mode, then press the button of the TV function that you want.

*For example;*

Press the TV button and the CH (▲), and the TV station will change to the next higher station.

### NOTE:

Also, you may change the channels at the TV by using the number buttons. If you can not change the channels at the TV by using the number buttons, press the ENTER button after you press the number buttons. It may change channels at the TV.

## 2 Return to the VCR function mode

Press the VCR button to operate your VCR with the remote again.

## TROUBLESHOOTING GUIDE

If you have followed the instructions contained in this manual and have difficulty in operating your VCR, locate the PROBLEM in the left column below. Check the corresponding CORRECTIVE ACTION columns to remedy the problem.

PROBLEM	CORRECTIVE ACTION
No power.	<ul style="list-style-type: none"> <li>• Make sure the AC cord is connected to an AC outlet.</li> <li>• Make sure the power is turned on.</li> </ul>
Timer recording is not possible.	<ul style="list-style-type: none"> <li>• Make sure the timer recording is set correctly.</li> <li>• Make sure the power is off.</li> <li>• Make sure the VCR clock is set correctly.</li> </ul>
Cannot go into Record mode.	<ul style="list-style-type: none"> <li>• Make sure the tape has an erase-prevention tab. If needed, cover the hole with plastic tape.</li> </ul>
Playback picture is partially noisy	<ul style="list-style-type: none"> <li>• Adjust tracking control for a better picture by using the CHANNEL ▲ or ▼ button on the VCR.</li> </ul>
No picture but the audio is OK in playback.	<ul style="list-style-type: none"> <li>• Head cleaning may be necessary. Refer to "HEAD CLEANING" on page 37.</li> </ul>
No picture or poor picture on playback.	<ul style="list-style-type: none"> <li>• Set your TV to the VCR mode and/or press the VCR/TV button on the remote control so that the "VCR" indicator on the display comes on.</li> <li>• Fine tune your TV.</li> </ul>
On-the-air TV programs cannot be seen.	<ul style="list-style-type: none"> <li>• Re-check the ANT. IN and ANT.OUT connections. See page 10.</li> <li>• Set your TV to the TV mode and/or press the VCR/TV button on the remote control so that the "VCR" indicator on the display disappears..</li> </ul>
No operation from the infrared Remote Control	<ul style="list-style-type: none"> <li>• Make sure the AC cord is connected to an AC outlet.</li> <li>• Check batteries in remote control</li> <li>• If the TV or CATV button is selected, press the VCR button on the remote control</li> </ul>
Video or color fades in and out when making a copy of a video tape	<ul style="list-style-type: none"> <li>• You cannot copy a copyrighted video tape. You are experiencing copy guard protection.</li> </ul>

## MAINTENANCE

### SERVICING

Should your VCR become inoperative, do not try to correct the problem by yourself. There are no user-serviceable parts inside. Turn off, unplug the power cord, and take the unit to our Authorized Service Center for servicing.

### CABINET CLEANING

- Wipe the front panel and other exterior surfaces of the VCR with a soft cloth immersed in lukewarm water and wrung dry.
- Never use a solvent or alcohol. Do not spray insecticide liquid near the VCR. Such chemicals may cause damage and discoloration to the exposed surfaces.

### HEAD CLEANING

- Playback picture may become blurred or interrupted while the TV program reception is clear. Dirt accumulated on the video heads after long periods of use, or the usage of rental or worn tapes can cause this problem.

If a streaky or snowy picture appears during playback, the video heads in your VCR may need to be cleaned.

1. Please visit your local Audio/Video store and purchase a good quality VHS Video Head Cleaner.
2. If a Video Head Cleaner does not solve the problem, consult our nearest Authorized Service Center. Professional video head cleaning requires highly technical attention.

#### NOTES:

- Remember to read the instructions included with the video head cleaner before use.
- Clean video heads only when problems occur.

## TECHNICAL SPECIFICATIONS

Format:	VHS
Video Signal System:	NTSC color EIA standard
Record/Playback System:	Video: 4 heads Audio: VHS Hi-Fi stereo record/playback system
Tape Speed:	33.35mm/s (SP), 16.67mm/s (LP)(Playback Only), 11.12mm/s (SLP)
RF Input:	UHF/VHF 75 ohm
Tuner:	181 channel tuning ability *(125 cable channels)
Type:	Auto programming frequency synthesis
Power Input:	AC120V 60Hz
Power Consumption:	14 W nominal
Cabinet Size:	14-1/4" (W) x 3-5/8" (H) x 8-3/4" (D) 36.0cm (W) x 9.2cm (H) x 22.3cm (D)
Weight:	5.51 lbs. (2.5 kg) (approx.)
Storage Temperature:	-4°F to 131°F
Operating Temperature:	41°F to 104°F
Accessories:	1 coaxial cable (Part No. 5857952), 1 remote control unit (Part No. HL11271), 2 AA batteries

\* Check your cable company's compatibility requirements.

- **Design and specifications subject to change without notice.**
- **If there is a discrepancy between languages, the default language will be English.**

# CABLE CHANNEL DESIGNATIONS

If you subscribe to cable TV, the channels are displayed as 1-125.

Cable companies often designate channels with letters or letter-number combinations. Please check with your local cable company. The following is a chart of common cable channel designations.

CATV Channel	5A	2	3	4	5	6	7	8	9	10	11	12	13	A	B
VCR Display	1	2	3	4	5	6	7	8	9	10	11	12	13	14	15
CATV Channel	C	D	E	F	G	H	I	J	K	L	M	N	O	P	Q
VCR Display	16	17	18	19	20	21	22	23	24	25	26	27	28	29	30
CATV Channel	R	S	T	U	V	W	W+1	W+2	W+3	W+4	W+5	W+6	W+7	W+8	W+9
VCR Display	31	32	33	34	35	36	37	38	39	40	41	42	43	44	45
CATV Channel	W+10	W+11	W+12	W+13	W+14	W+15	W+16	W+17	W+18	W+19	W+20	W+21	W+22	W+23	W+24
VCR Display	46	47	48	49	50	51	52	53	54	55	56	57	58	59	60
CATV Channel	W+25	W+26	W+27	W+28	W+29	W+30	W+31	W+32	W+33	W+34	W+35	W+36	W+37	W+38	W+39
VCR Display	61	62	63	64	65	66	67	68	69	70	71	72	73	74	75
CATV Channel	W+40	W+41	W+42	W+43	W+44	W+45	W+46	W+47	W+48	W+49	W+50	W+51	W+52	W+53	W+54
VCR Display	76	77	78	79	80	81	82	83	84	85	86	87	88	89	90
CATV Channel	W+55	W+56	W+57	W+58	A-5	A-4	A-3	A-2	A-1	W+59	W+60	W+61	W+62	W+63	W+64
VCR Display	91	92	93	94	95	96	97	98	99	100	101	102	103	104	105
CATV Channel	W+65	W+66	W+67	W+68	W+69	W+70	W+71	W+72	W+73	W+74	W+75	W+76	W+77	W+78	W+79
VCR Display	106	107	108	109	110	111	112	113	114	115	116	117	118	119	120
CATV Channel	W+80	W+81	W+82	W+83	W+84										
VCR Display	121	122	123	124	125										

## DECLARATION OF CONFORMITY

with FCC Rules for Electromagnetic Compatibility

Products: Video Deck

Models: VT-FX6500A

Trade Name: HITACHI

This device complies with part 15 of FCC Rules. Operation is subject to the following two conditions:  
 (1) this device may not cause harmful interference, and (2) this device must accept any interference received, including interference that may cause undesired operation.

Responsible Party: HITACHI AMERICA, LTD.  
 HOME ELECTRONICS DIVISION  
 905 East South Street, Anaheim, CA 92805 U.S.A.  
 Tel: 714-780-0152

## Free Manuals Download Website

<http://myh66.com>

<http://usermanuals.us>

<http://www.somanuals.com>

<http://www.4manuals.cc>

<http://www.manual-lib.com>

<http://www.404manual.com>

<http://www.luxmanual.com>

<http://aubethermostatmanual.com>

Golf course search by state

<http://golfingnear.com>

Email search by domain

<http://emailbydomain.com>

Auto manuals search

<http://auto.somanuals.com>

TV manuals search

<http://tv.somanuals.com>