

Arm Mount Sled

Wearable Solution for Dolphin 70e Black

Quick Start Guide

Aller à www.honeywellaidc.com pour le français.

Vai a www.honeywellaidc.com per l'italiano.

Gehe zu www.honeywellaidc.com für Deutsch.

Ir a www.honeywellaidc.com para español.

Para Português, acesse www.honeywellaidc.com.

Перейти на русскоязычный сайт www.honeywellaidc.com.

Pro češtinu jdi na www.honeywellaidc.com.

Pre slovenčino hodí na www.honeywellaidc.com.

Türkçe için lütfen www.honeywellaidc.com sayfasını ziyaret ediniz.

Idź na stronę : www.honeywellaidc.com po quick start w języku polskim.

如要到中国 www.honeywellaidc.com (简体)。

إلى لانتق www.honeywellaidc.com للغة العربية.



Getting Started

The Arm Mounted Sled is a device that is used with the wearable version of the Dolphin 70e Black (Honeywell Wearable Solution). For information about the Dolphin 70e Black, refer to the quick start packaged with the terminal. This document is designed to assist the user who is wearing the wearable Dolphin 70e Black on an arm.

Out of the Box

A typical Honeywell Wearable Solution arm mount accessory kit contains the following items (may be packaged separately):

- Arm mount sled
- Arm band
- Tethered ring scanner (optional)
- Audio end cap, headset adapter cable and headset (optional)
- Quick Start Guide

The Dolphin 70e Black terminal and other accessories are packaged separately. Be sure to keep the original packaging in case you need to return the Dolphin 70e Black or accessories for service.

Initial Use Overview

When preparing for initial wearable use, insert a fully charged battery and follow the steps in this guide to assemble the wearable sled and mount the assembly on an arm. When finished, loosen the arm band straps to remove the assembly from the arm.

Subsequent Use Overview

For subsequent use, it may be necessary to remove the terminal from the sled before changing the battery. Next reassemble the sled and mount the assembly on an arm. When finished, loosen the arm band straps to remove the assembly from the arm.

The arm band can be washed between uses. Be sure to remove the sled from the arm band before washing the arm band.

Getting to Know the Arm Mount Sled

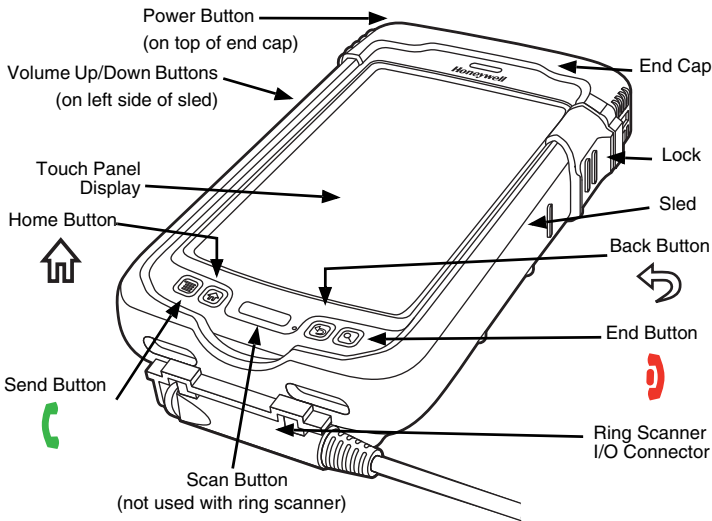

The sled encases the Dolphin 70e Black and helps protect the terminal from impacts.

Dolphin 70e Black Features Not Used

When the Dolphin 70e Black is installed in the arm mounted sled, the following features are not available:

- Internal scanner
- Micro-USB port

Removing the Dolphin 70e Black from the Sled

1. If the audio end cap is used, remove the audio cable.
To prevent damage to the Dolphin 70e Black always unplug the audio cable (if used) before removing the end cap.

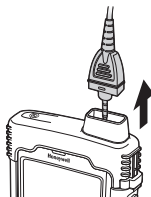

2. Slide the lock down to release the end cap.

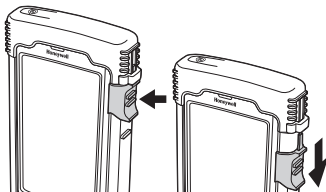

3. Push up on the right side of the end cap. Do not attempt to remove the end cap without opening the lock first!



4. Pull the end cap off of the sled.

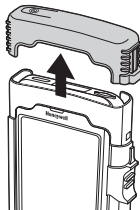

- Slide the Dolphin 70e Black out of the sled. Use the notch in the bottom of the sled to push the Dolphin 70e Black.

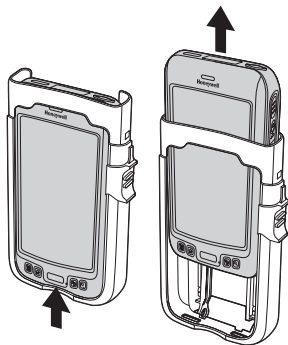

Removing the Battery

- Remove the Dolphin 70e Black from the sled before changing the battery.
- Place the terminal in **Suspend** mode by pressing and releasing the **Power** button .
- Perform the steps illustrated below to remove the battery.

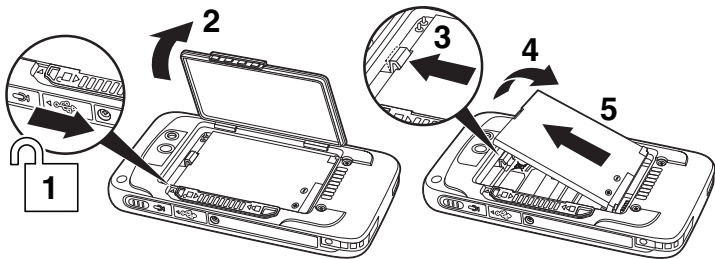

Installing the Battery

The Dolphin 70e Black wearable model is designed for use with battery part numbers BAT-STANDARD-02 (Li-ion 3.7 V, 6.179 watt hour) and BAT-EXTENDED-02 (Li-ion 3.7 V, 12.358 watt hour) manufactured for Honeywell International Inc.

 We recommend use of Honeywell Li-ion battery packs. Use of any non-Honeywell battery may result in damage not covered by the warranty

Note: Standard model battery and battery door shown.

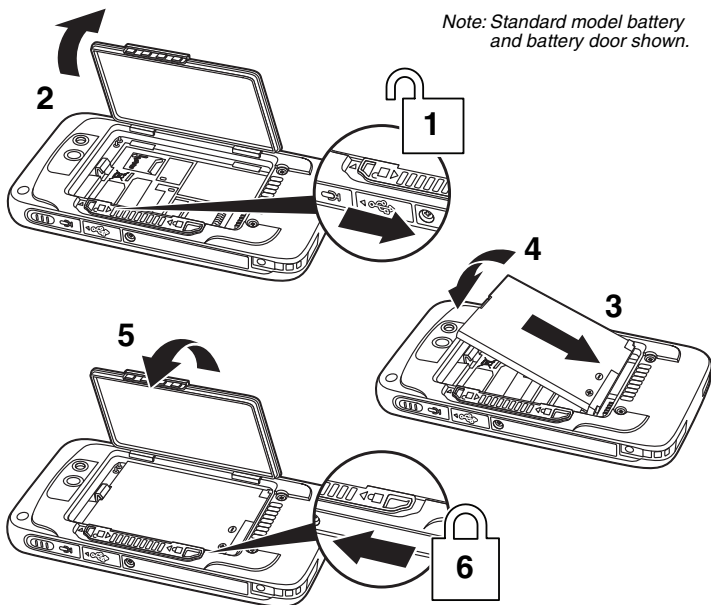

Turning Power On/Off

To turn the terminal **On**, press and release the **Power** button .

To turn the terminal **Off**:

1. Press and hold the **Power** button  for approximately 4 seconds until the Options menu displays.
2. Touch **Power off**.

Suspend Mode

Suspend mode automatically turns the touch screen off to save battery power when the terminal is inactive for a programmed period of time. The automatic timeout limits are adjustable from the **Advance** tab located under **Settings > System > Power**.

Press and release the **Power** button  to toggle the terminal in or out of **Suspend Mode**.

*Note: You should always place the terminal into **Suspend** mode before removing the battery.*

Placing Dolphin 70e Black into the Sled

1. If the end cap is installed on the sled, slide the lock down to release the end cap.

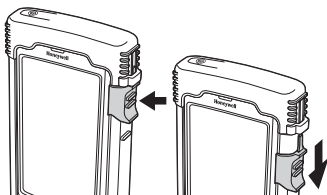

2. Push up on the right side (the side with the lock) of end cap. Do not attempt to remove the end cap without sliding the lock first!

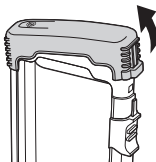

3. Pull the end cap off the sled.

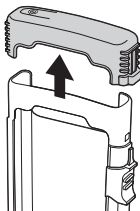

4. Make sure the USB door is closed. Rotate the door on the right side of the Dolphin 70e Black to close.

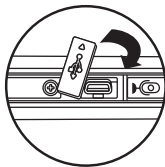

5. Press until the door is flush with the side of the terminal.

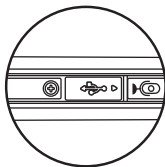

6. Slide the Dolphin 70e Black into the sled.



7. If using the audio end cap, make sure audio jack door is open. Pull the rubber door out and rotate the door 180° as shown to prevent damage.

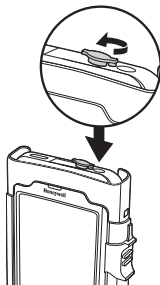

8. If using the audio end cap, make sure the audio cable is not installed in the end cap.

- Slide the end cap straight onto the sled until it clicks in place.

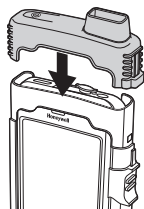

Audio End Cap

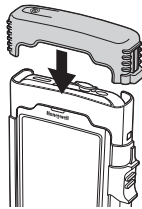

Standard End Cap

- Slide the lock closed to secure the end cap.

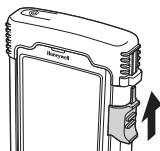

Attaching the Headset (Optional)

- Make sure the audio jack door is open as shown in the previous section.
- Slide the 3.5mm audio connector into the end cap.

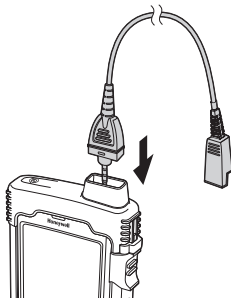

3. Attach the quick disconnect end of the headset adapter cable to the headset's cable.

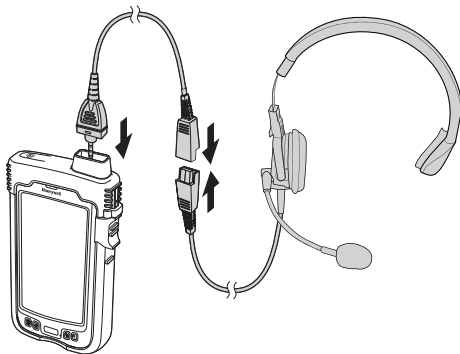

4. Slide the cable ends together until they click. Do not twist or bend the connectors.

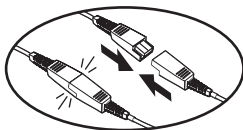

Connecting the Ring Scanner (Optional)

1. Slide the ring scanner cable connector into the bottom of the sled until the connector ring clicks shut.

It is not necessary to remove the ring scanner from the sled before removing the Dolphin 70e Black from the sled.

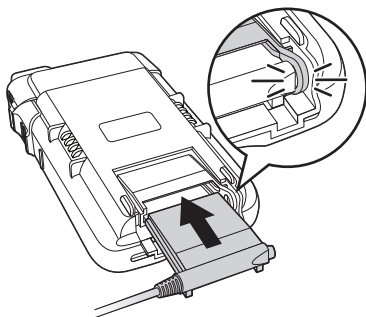

Ejecting the Ring Scanner

1. To eject the ring scanner, open the connector ring with one hand, pulling toward the outside of the sled.
2. Push the ring scanner connector out of the sled.

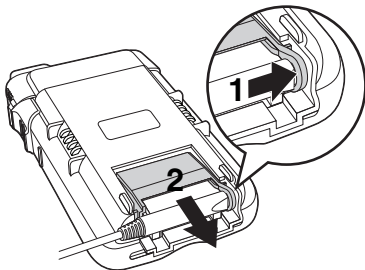

Mounting the Arm Band

Note: The illustrations in this procedure assume the sled has not yet been mounted to the arm band. However the sled can be mounted to the arm band before the user puts the arm band on.

1. If the arm band straps are not fed through the buckles, feed them through to form a loop before placing the arm band on the arm. For ease of installation, the straps should be kept looped through the buckles.
2. Place and balance the arm band assembly on the top of the desired arm with the buckles toward the outside of the arm.
3. Using the other hand, pull each strap end straight away from the arm until the arm band is comfortably secured.

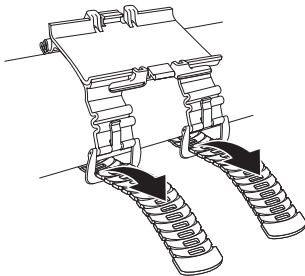

4. Ensure the latch on each buckle is through a hole in the strap.

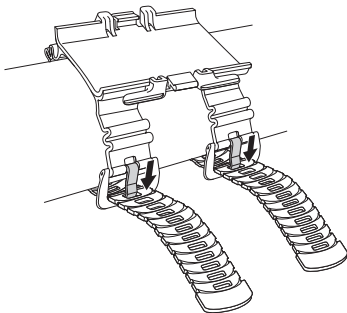

1. If there is excess strap length:

- Loop the excess strap behind the horns on the sled, as shown, or

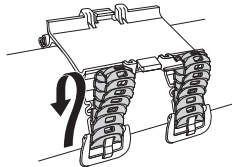
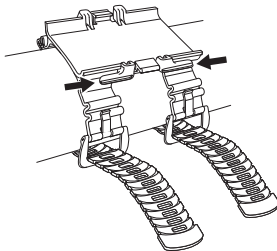

- Trim the straps to length and use the provided clips to terminate the strap end.

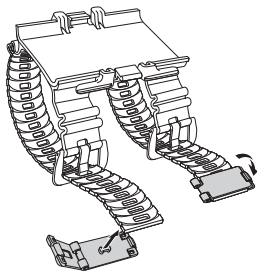

2. Align the sled assembly with the arm band and press on the sled until it latches onto the arm band. Be sure to align tabs on the back of sled with the notches on the arm band. The end of the sled with the ring scanner connector must face toward the hand.

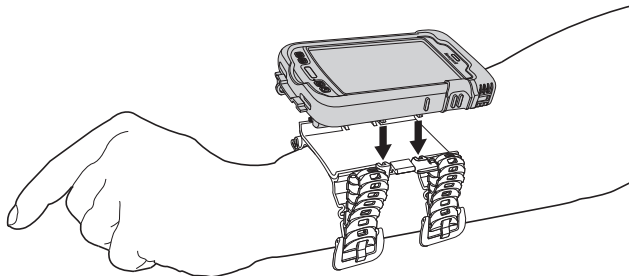

3. If using the ring scanner, slide the ring scanner over the index finger and adjust the strap for a comfortable fit.

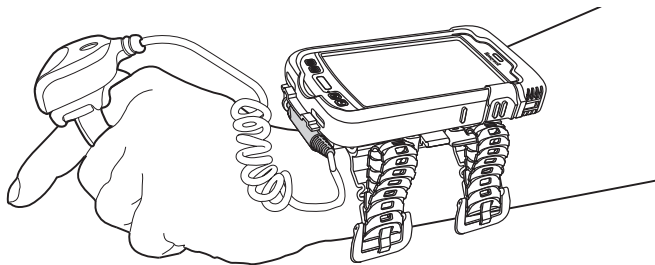

4. To remove the sled assembly, unbuckle and loosen the straps. It is not necessary to remove the strap from the buckle.

Resetting the terminal

There are three types of system resets: a soft reset, a hard reset, or a factory reset. The soft and hard resets preserve all data stored in the file system. Contact a Honeywell technical support representative for more information on how to perform a factory reset.

A **Soft Reset** (Warm Boot) re-boots the device and preserves any objects created in RAM. You would perform a soft reset when: the terminal fails to respond, after installing some software applications, or after making changes to certain system settings, such as network cards.

A **Hard Reset** (Cold Boot) re-boots the terminal and closes any open applications running in RAM at the time of the reset.

To perform a **Soft Reset** or **Hard Reset**:

1. Press and hold the **Power** button  approximately 4 seconds until the options menu appears.
2. Touch **Soft Reset** or **Hard Reset** on the menu. When the reset is complete, the **Home** screen displays.

*Note: To perform a **Hard Reset** if the touch screen has stopped responding, press and hold the **Power** button  for approximately 8 seconds until the terminal starts to re-boot. When the reset is complete, the **Home** screen displays.*

Technical Assistance

Contact information for technical support, product service, and repair can be found at www.honeywellaidc.com.

User Documentation

For localized versions of this document, and to download the User's Guide, go to www.honeywellaidc.com.

Limited Warranty

Refer to www.honeywellaidc.com/warranty_information for your product's warranty information.

Patents

For patent information, please refer to www.honeywellaidc.com/patents.

Disclaimer

Honeywell International Inc. ("HII") reserves the right to make changes in specifications and other information contained in this document without prior notice, and the reader should in all cases consult HII to determine whether any such changes have been made. The information in this publication does not represent a commitment on the part of HII.

HII shall not be liable for technical or editorial errors or omissions contained herein; nor for incidental or consequential damages resulting from the furnishing, performance, or use of this material.

This document contains proprietary information that is protected by copyright. All rights are reserved. No part of this document may be photocopied, reproduced, or translated into another language without the prior written consent of HII.

© 2014 Honeywell International Inc. All rights reserved.

Web Address: www.honeywellaidc.com

Free Manuals Download Website

<http://myh66.com>

<http://usermanuals.us>

<http://www.somanuals.com>

<http://www.4manuals.cc>

<http://www.manual-lib.com>

<http://www.404manual.com>

<http://www.luxmanual.com>

<http://aubethermostatmanual.com>

Golf course search by state

<http://golfingnear.com>

Email search by domain

<http://emailbydomain.com>

Auto manuals search

<http://auto.somanuals.com>

TV manuals search

<http://tv.somanuals.com>