

**Honeywell**

THE POWER OF **CONNECTED**

# CV41

## Vehicle Mounted Computer

Windows CE 6.0 - CV41C



# User Guide

# Disclaimer

Honeywell International Inc. (“HII”) reserves the right to make changes in specifications and other information contained in this document without prior notice, and the reader should in all cases consult HII to determine whether any such changes have been made. The information in this publication does not represent a commitment on the part of HII.

HII shall not be liable for technical or editorial errors or omissions contained herein; nor for incidental or consequential damages resulting from the furnishing, performance, or use of this material. HII disclaims all responsibility for the selection and use of software and/or hardware to achieve intended results.

This document contains proprietary information that is protected by copyright. All rights are reserved. No part of this document may be photocopied, reproduced, or translated into another language without the prior written consent of HII.

Copyright © 2012-2018 Honeywell International Inc. All rights reserved.

Web Address: [www.honeywellaidc.com](http://www.honeywellaidc.com)

Microsoft®, Windows®, ActiveSync®, MSN, Outlook®, Windows Mobile®, the Windows logo, and Windows Media are registered trademarks or trademarks of Microsoft Corporation in the United States and/or other countries.

Wi-Fi®, WMM®, Wi-Fi Multimedia™, Wi-Fi Protected Access®, WPA™, WPA2™ and the Wi-Fi CERTIFIED™ logo are trademarks or registered trademarks of Wi-Fi Alliance.

The Bluetooth® word mark and logos are owned by the Bluetooth SIG, Inc.

Laird Technologies, the Laird logo, Summit Data Communications, the Summit logo, and “Connected. No Matter What” are trademarks of Laird Technologies, Inc.

Verizon® is a registered trademark of Verizon Trademark Services LLC.

SD and SDHC are trademarks or registered trademarks of SD-3C, LLC in the United States and/or other countries.

Other product names or marks mentioned in this document may be trademarks or registered trademarks of other companies and are the property of their respective owners.

For patent information, refer to [www.hsmpats.com](http://www.hsmpats.com).

# TABLE OF CONTENTS

<b>Chapter 1 - Customer Support</b> .....	<b>1</b>
Product Service and Repair.....	1
Technical Assistance.....	1
Limited Warranty.....	1
<b>Chapter 2 - About the Computer</b> .....	<b>3</b>
About the CV41 Vehicle Mount Computer.....	4
Overview of the CV41 Features.....	5
Power Supply Options.....	6
About the Smart Dock.....	7
Attach the CV41 to the Smart Dock.....	7
Remove the CV41 from the Smart Dock.....	8
Secure the CV41.....	9
About the LEDs.....	10
CV41 Accessories.....	11
About Internal UPS Battery.....	13
Maximize the Internal UPS Battery Usage.....	13
About the Backup Battery.....	14
Insert an SD Card.....	15
About the Touch Screen.....	15
Protect the Touch Screen.....	15
Adjust the Screen Brightness.....	16
Enable the Defroster.....	16
Change the Volume.....	17
Connect an External Antenna.....	17

About the Keypad .....	19
Use the Modifier Keys .....	19
Capitalize Characters .....	20
Enable or Disable the Keypad Backlight .....	20
Set the Keypad and Display Backlight Timer .....	21
Transfer Files To and From Your PC .....	22

## **Chapter 3 - Understand the User Interface and Applications.....23**

About the User Interface .....	24
About the Desktop Screen.....	24
Learn the Basic Skills .....	24
Use the Touch Screen .....	24
Use the Taskbar.....	25
Use Pop-Up Menus .....	25
Enter Information .....	25
Use Transcriber .....	26
Calibrate the Screen .....	26
Set the Date and Time.....	26
Sync to a Local Time Server .....	26
About Applications.....	27
Applications Available On the Computer .....	27
Applications You Can Download For the Computer.....	28
About Features Demo.....	28
About SmartSystems Foundation .....	28

## **Chapter 4 - Manage the Computer .....29**

Manage the Computer in Your Network.....	30
Manage the Computer Using SmartSystems Foundation.....	30
Develop and Install Applications .....	31
Package Your Application.....	31
Choose a Target Location.....	31
Install Applications Using SmartSystems Foundation Console.....	31
Install Applications Using Microsoft ActiveSync .....	31
Install Applications Using an SD Card .....	32
Update the Honeywell Content Software .....	32
Update the Operating System and Low-Level Firmware.....	32

Update the Honeywell Content Software .....	33
Update Honeywell Content Using SmartSystems Foundation .....	33
Update Honeywell Content Using a ActiveSync .....	33

## **Chapter 5 - Configure the Computer.....35**

How to Configure the Computer .....	36
Use Intermec Settings on the Computer .....	36
Start Intermec Settings .....	36
About the Structure of Intermec Settings .....	37
Navigate in Intermec Settings .....	40
Configure Profile Settings With Intermec Settings .....	41
Restore Default Settings .....	42
Hide Menu Items in Intermec Settings .....	43
Use Intermec Settings Remotely With SmartSystems Foundation .....	43
About Network Communications.....	43
Configure 802.11a/b/g (Wi-Fi) Radio Communications.....	44
Configure Bluetooth Communications.....	44
Connect to a Bluetooth Scanner .....	45
Connect to a Bluetooth Printer .....	46
About Serial and USB Communications.....	46
Connect to a USB Scanner .....	46
Connect to a Serially Tethered Scanner .....	47
Create an ISP Connection .....	48
Create a VPN Server Connection.....	50
About Wireless Security .....	50
Choose Between Microsoft and Funk Security.....	51

Select a Funk Security Profile.....	51
Select a Funk Security Profile .....	51
Configure WPA or WPA2 Enterprise (802.1x) Security With Funk .....	51
Configure WPA or WPA2 Personal (PSK) Security With Funk .....	52
Configure 802.1x Security With Funk Security .....	52
Configure LEAP Security With Funk .....	53
Configure Static WEP Security With Funk Security .....	53
Use Open (No Security) Associations with Funk .....	54
Select Microsoft as Your Security Choice .....	54
Select Microsoft Security.....	54
Configure WPA or WPA2 Enterprise (802.1x) Security With Microsoft.....	55
Enable WPA or WPA2 Personal (PSK) Security With Microsoft.....	55
Configure 802.1x Security with Microsoft.....	56
Configure Static WEP Security With Microsoft.....	57
Use Open (No Security) Associations With Microsoft.....	57
Load a Certificate .....	57

## **Chapter 6 - Use the Auto-On Feature.....59**

About the Auto-On Feature .....	60
Enable the Auto-On Feature .....	60
Disable the Auto-On Feature .....	60

## **Chapter 7 - Use WWAN and GPS Communications .....61**

About WWAN Communications.....	62
Activate UMTS Communications .....	62
Activate CDMA Communications.....	63
About GPS .....	63
Test the GPS Receiver .....	64

## **Chapter 8 - Enable Screen Blanking.....65**

About Screen Blanking.....	66
Install the Hardware for Screen Blanking .....	66
Before You Install the Switch .....	66
Tools You Need.....	66
Create a Custom Serial Cable .....	67
Install Switch for Screen Blanking .....	67

Enable Screen Blanking.....68

**Chapter 9 - Troubleshoot and Maintain the Computer .....69**

About the Intermecc Dashboard .....70

Troubleshoot Your Computer .....70

    Troubleshoot the Wi-Fi Connection .....70

    Troubleshoot 802.1x Security.....71

    Check 802.11 Network Status .....71

    Troubleshoot Reading Bar Codes.....73

    Troubleshoot Operating the Computer.....74

Call Product Support .....74

    Find Your Configuration Number.....75

    Find Your Operating System Version.....75

Reset the Computer.....75

    Cold Boot the Computer .....75

    Warm Boot the Computer.....75

    Clean Boot the Computer.....76

    Disconnect the UPS Battery .....76

Replace the Fuse .....77

Clean the Computer .....77

**Appendix A - Specifications and Default Settings.....47**

Physical and Environmental Specifications.....48

    Physical Dimensions .....48

    Environmental Specifications .....48

    Power and Electrical Specifications .....48

    Hardware .....48

    Wireless LAN.....49

    Bluetooth.....49

    Default Configuration .....49

Data Collection Settings.....	50
Communications .....	52
Device Settings.....	52
Core Messaging Service Settings .....	53
Device Monitor Settings .....	53
RFID Settings .....	54
Virtual Wedge Settings.....	54
Port Pin Assignments .....	54
COM 1 and COM 2 Ports.....	54
USB Port .....	55
CANBUS/Audio Port .....	55
Power Supply Connector.....	56
USB Dongle Cable .....	57
<b>Appendix B - Keypads and Keystrokes .....</b>	<b>59</b>
Standard Characters.....	60
<b>Appendix C - ScanNGo Wi-Fi Configuration Bar Codes .....</b>	<b>65</b>
Radio Configuration Bar Codes .....	66
2D Configuration Bar Codes .....	67
1D Configuration Bar Codes .....	68
<b>Appendix D - CV41 Docks .....</b>	<b>73</b>
Standard Dock.....	74
Components .....	74
Enhanced Dock for Off-Vehicle Use.....	75
Components - Back .....	75
Components - Top .....	76



## Product Service and Repair

Honeywell International Inc. provides service for all of its products through service centers throughout the world. To obtain warranty or non-warranty service, please visit [www.honeywellaidc.com/locations](http://www.honeywellaidc.com/locations) to find contact information for your region's service center. Be sure to obtain a Return Material Authorization number (RMA #). You should do this prior to returning the product.

## Technical Assistance

If you need assistance installing or troubleshooting your device, please contact us by using one of the methods below:

Knowledge Base: [www.hsmknowledgebase.com](http://www.hsmknowledgebase.com)

Our Knowledge Base provides thousands of immediate solutions. If the Knowledge Base cannot help, our Technical Support Portal (see below) provides an easy way to report your problem or ask your question.

Technical Support Portal: [www.hsmsupportportal.com](http://www.hsmsupportportal.com)

The Technical Support Portal not only allows you to report your problem, but it also provides immediate solutions to your technical issues by searching our Knowledge Base. With the Portal, you can submit and track your questions online and send and receive attachments.

Telephone: [www.honeywellaidc.com/locations](http://www.honeywellaidc.com/locations)

For our latest contact information, please check our website at the link above.

## Limited Warranty

Honeywell International Inc. ("HII") warrants its products to be free from defects in materials and workmanship and to conform to HII's published specifications applicable to the products purchased at the time of shipment. This warranty does not cover any HII product which is (i) improperly installed or used; (ii) damaged by accident or negligence, including failure to follow the proper maintenance, service, and cleaning sched-

ule; or (iii) damaged as a result of (A) modification or alteration by the purchaser or other party, (B) excessive voltage or current supplied to or drawn from the interface connections, (C) static electricity or electro-static discharge, (D) operation under conditions beyond the specified operating parameters, or (E) repair or service of the product by anyone other than HII or its authorized representatives.

This warranty shall extend from the time of shipment for the duration published by HII for the product at the time of purchase (“Warranty Period”). Any defective product must be returned (at purchaser’s expense) during the Warranty Period to HII factory or authorized service center for inspection. No product will be accepted by HII without a Return Materials Authorization, which may be obtained by contacting HII. In the event that the product is returned to HII or its authorized service center within the Warranty Period and HII determines to its satisfaction that the product is defective due to defects in materials or workmanship, HII, at its sole option, will either repair or replace the product without charge, except for return shipping to HII.

EXCEPT AS MAY BE OTHERWISE PROVIDED BY APPLICABLE LAW, THE FOREGOING WARRANTY IS IN LIEU OF ALL OTHER COVENANTS OR WARRANTIES, EITHER EXPRESSED OR IMPLIED, ORAL OR WRITTEN, INCLUDING, WITHOUT LIMITATION, ANY IMPLIED WARRANTIES OF MERCHANTABILITY OR FITNESS FOR A PARTICULAR PURPOSE, OR NON-INFRINGEMENT.

HII’S RESPONSIBILITY AND PURCHASER’S EXCLUSIVE REMEDY UNDER THIS WARRANTY IS LIMITED TO THE REPAIR OR REPLACEMENT OF THE DEFECTIVE PRODUCT WITH NEW OR REFURBISHED PARTS. IN NO EVENT SHALL HII BE LIABLE FOR INDIRECT, INCIDENTAL, OR CONSEQUENTIAL DAMAGES, AND, IN NO EVENT, SHALL ANY LIABILITY OF HII ARISING IN CONNECTION WITH ANY PRODUCT SOLD HEREUNDER (WHETHER SUCH LIABILITY ARISES FROM A CLAIM BASED ON CONTRACT, WARRANTY, TORT, OR OTHERWISE) EXCEED THE ACTUAL AMOUNT PAID TO HII FOR THE PRODUCT. THESE LIMITATIONS ON LIABILITY SHALL REMAIN IN FULL FORCE AND EFFECT EVEN WHEN HII MAY HAVE BEEN ADVISED OF THE POSSIBILITY OF SUCH INJURIES, LOSSES, OR DAMAGES. SOME STATES, PROVINCES, OR COUNTRIES DO NOT ALLOW THE EXCLUSION OR LIMITATIONS OF INCIDENTAL OR CONSEQUENTIAL DAMAGES, SO THE ABOVE LIMITATION OR EXCLUSION MAY NOT APPLY TO YOU.

All provisions of this Limited Warranty are separate and severable, which means that if any provision is held invalid and unenforceable, such determination shall not affect the validity of enforceability of the other provisions hereof. Use of any peripherals not provided by the manufacturer may result in damage not covered by this warranty. This includes but is not limited to: cables, power supplies, cradles, and docking stations. HII extends these warranties only to the first end-users of the products. These warranties are non-transferable.

For warranty information, go to [www.honeywellaidc.com](http://www.honeywellaidc.com) and click Get Resources > Product Warranty.

CHAPTER

# 2

## ABOUT THE COMPUTER

This chapter introduces the CV41 Vehicle Mount Computer with Microsoft® Windows® CE operating system. Use this chapter to learn about the basic features and available accessories.

# About the CV41 Vehicle Mount Computer

The rugged CV41 Vehicle Mount Computer is designed for real-time data collection applications in warehousing, distribution, work-in-process, time and attendance, and stationary applications. The CV41 is highly configurable and runs on the Microsoft Windows CE 6.0 operating system. Additionally, the CV41 supports terminal emulation applications, browser-based applications, and custom applications.

The CV41 is used with the smart dock. The dock installs onto a vehicle and provides conditioned power to the CV41. All peripheral connections are also made on the dock. With the CV41 design, you can easily remove the CV41 from the smart dock and attach it to another vehicle that is equipped with a dock.

**Note:** *There are two docks available for the CV41. The proper dock must be selected based on intended use:*

- The **Standard Dock** which is used for DC powered (i.e.: vehicle mounted) applications.
- The **Enhanced Dock for Off-Vehicle Use** for AC powered applications.

Throughout this document, the differences in the two dock ports/connectors may not be mentioned. See **CV41 Docks** for details on the ports/connectors available on each type of dock.

## CV41 Front View

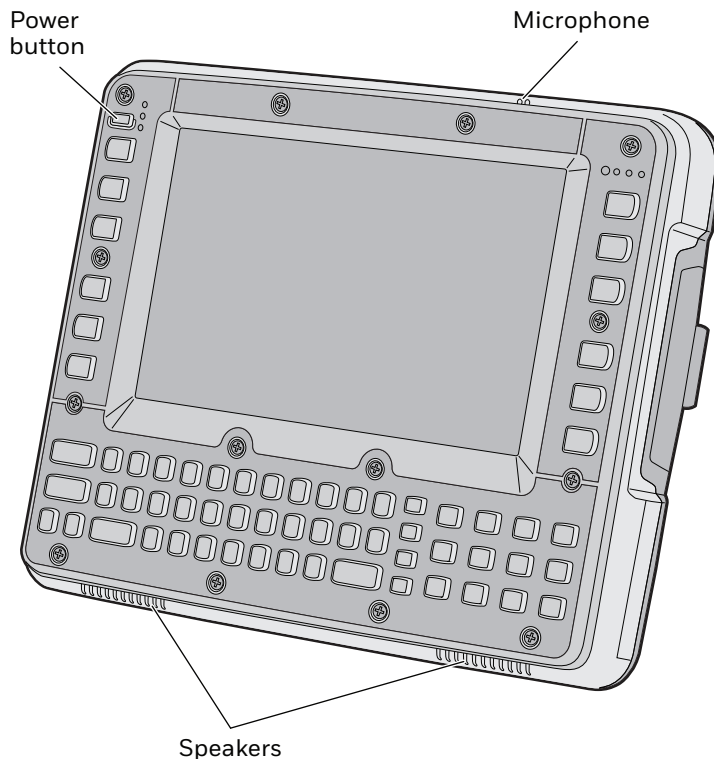

**Caution:** If the CV41 has connectors for external antennas, do not power up the CV41 without the external antennas connected. Damage to the WLAN radio may result.

### CV41 Back View with Quick Mount Smart Dock

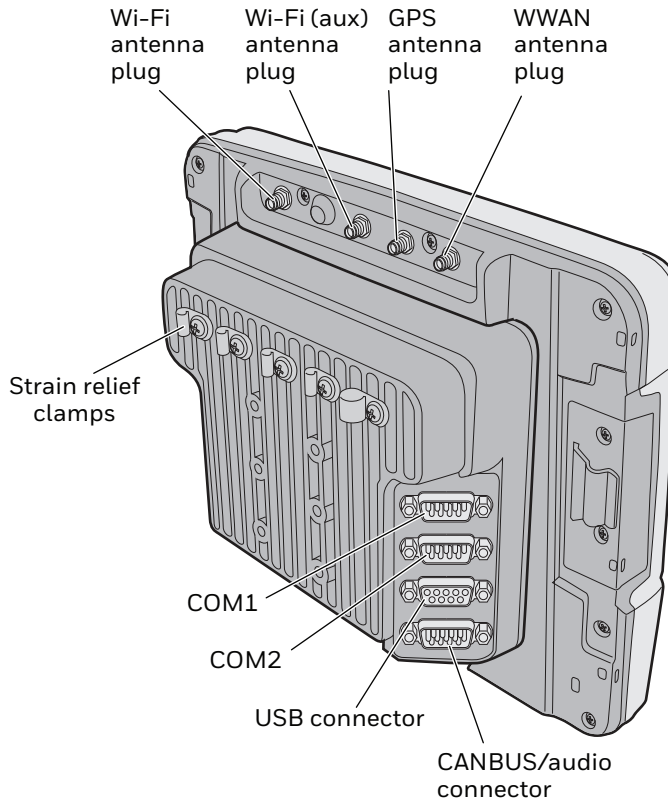

### CV41 Back View with Quick Mount Smart Dock

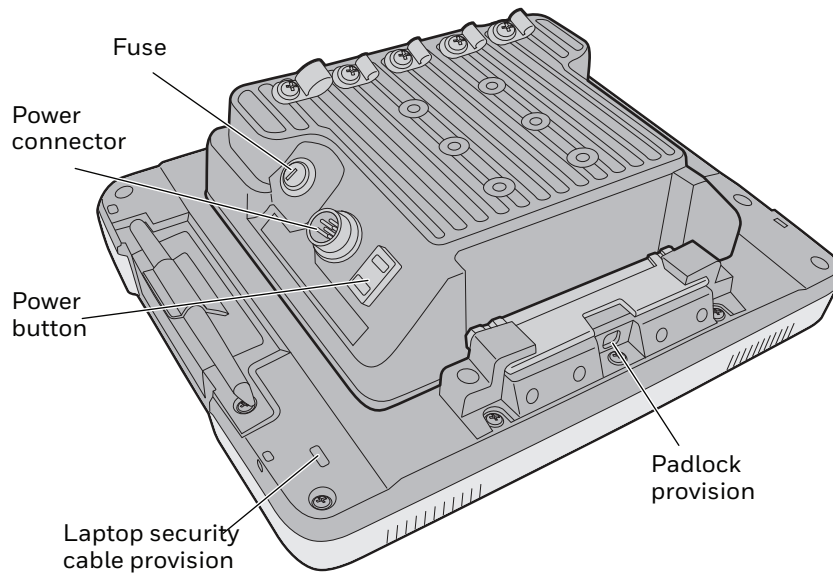

## Overview of the CV41 Features

The CV41 includes these standard features:

- WVGA display with a resolution of 800 x 480 pixels
- 1 GB of RAM memory

- 1 GB flash memory with user-installable expansion slot supporting an additional 1 to 4 GB SD card
- 802.11a/b/g and Bluetooth® radios
- Optional WWAN radio (available in North America, Europe, and Australia only)
- Intel Atom 1.6 GHz processor



The CV41 Vehicle Mount Computer has an IEEE 802.11a/b/g radio installed and Wi-Fi® certified for interoperability with other 802.11a/b/g wireless LAN devices.

## Power Supply Options

To use the CV41, you must apply power to it. By default, the CV41 comes with a DC power cable that connects directly to a forklift battery running 10-60 VDC power. Other power supply options include:

- External 6-96 DC/DC Power Converter (requires [Standard Dock](#))
- External AC/DC Power Supply (requires [Enhanced Dock for Off-Vehicle Use](#))



**Caution: Be sure to use the proper dock for the application. See [CV41 Docks](#) for information.**

The AC/DC power supply must be connected to a 120 V, 60 Hz supply in North America, or to a 230 V, 50 Hz power supply outside of North America (appropriate AC cable not included). Make sure that the external AC power is properly grounded and provides a maximum of 15 A of overcurrent protection (10 A for 230 V circuits). For more information on installing any of these power supply options, see the *CV41 Vehicle Mounting Kit Reference Guide*.

**Note:** *In North America, the AC power supply is intended for use with a UL Listed ITE power supply with an output rating of 12 to 48 VDC, minimum 15 W. Outside of North America, the power supply is intended for use with an IEC certified ITE power supply with an output rating of 12 to 48 VDC, minimum 15 W.*

Contact your Honeywell representative to order one of the power supply options listed. For installation instructions, see the *CV41 Vehicle Mounting Kit Reference Guide*.

# About the Smart Dock

The smart dock is secured to a forklift using a RAM mounting kit and provides conditioned power to the CV41. The CV41 can then be connected or removed from the smart dock at any time. With this unique system, you can easily move the CV41 from one vehicle equipped with the smart dock to another. Additionally, the dock provides:

- a USB port
- two COM ports
- a CANBUS/audio port
- strain relief cable mounts

To connect any accessory such as a tethered scanner, an audio headset, or a USB flash drive, you need to purchase the correct accessory cables. For more information, contact your Honeywell representative.



**Caution: Make sure the smart dock is powered off before you connect any cables to it.**

## Attach the CV41 to the Smart Dock

Once you have secured the smart dock and connected it to power, attach the CV41 to the smart dock.

1. Press and hold the **Power** button on the CV41 until the computer turns off.
2. Locate the protruding lip on the rear of the CV41.
3. Place the lip of the CV41 over the top of the dock.
4. Slide the CV41 from side-to-side until the CV41 is seated into the smart dock.
5. Push down onto the smart dock until you hear a click.
6. If necessary, adjust the viewing angle by adjusting the pivot arm on the RAM mount.
7. Press the **Power** button on the smart dock to turn on the dock.

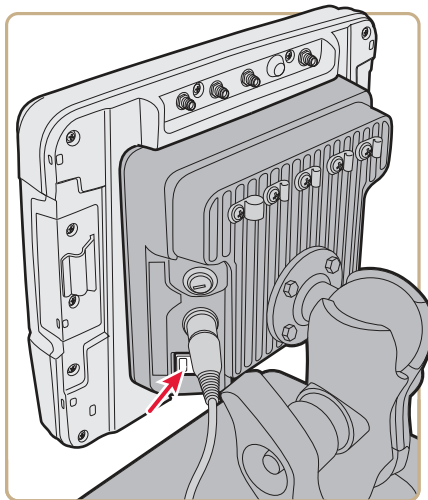

8. Press the **Power** button on the CV41 to turn on the CV41.

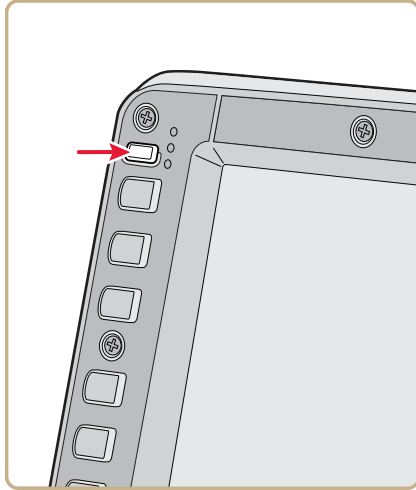

## Remove the CV41 from the Smart Dock

The CV41 can easily be moved from one vehicle equipped with the smart dock to another.

1. Press and hold the **Power** button on the CV41 until the computer turns off.
2. Pull down on the red quick release handle.

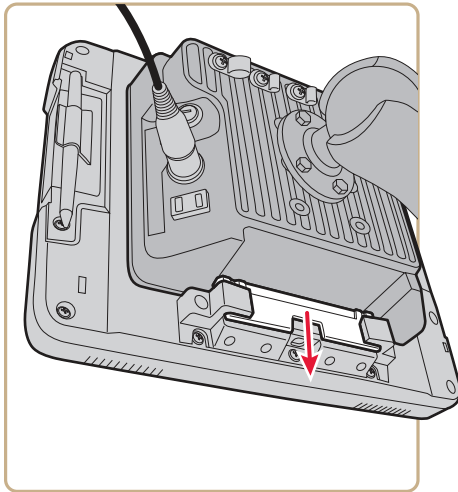

3. Pull the bottom of the CV41 away from the smart dock.
4. Lift the CV41 away from the dock.



# Secure the CV41

If you do not want users to remove the CV41 from a forklift, use either a padlock or a laptop security provision to keep your CV41 safe.

## Padlock Provision Location

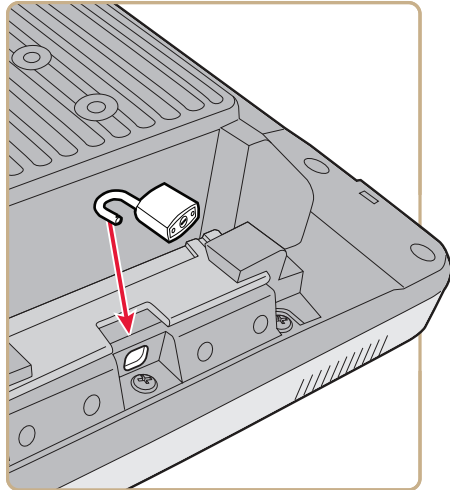

## Laptop Security Provision Location

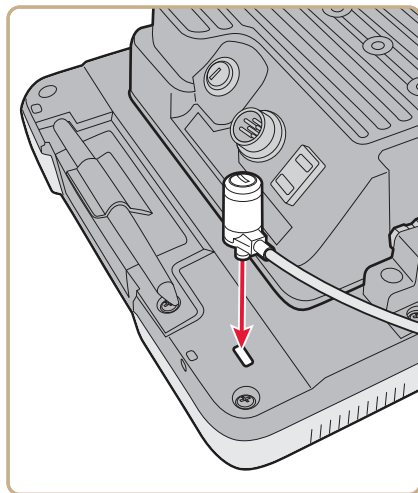

# About the LEDs

The LEDs on the CV41 tell the state of the computer. Use this section to learn about the connection and system LEDs.

## Connection LEDs

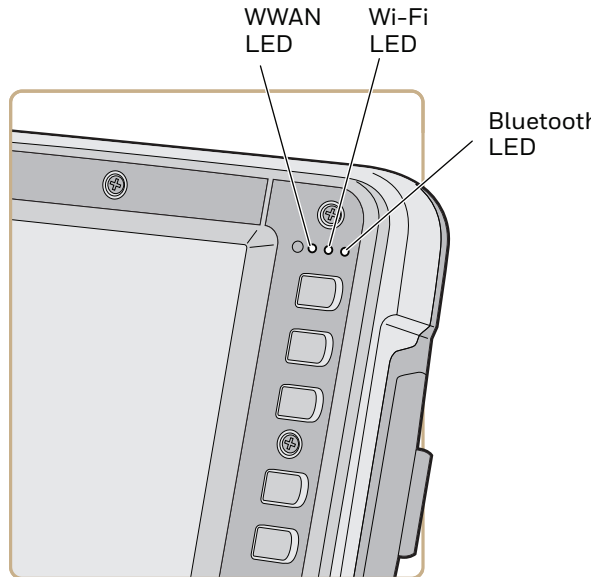

LED	State	Description
WWAN	Solid green	The CV41 is connected to WWAN.
	Off	The CV41 is not connected to WWAN.
Wi-Fi	Solid green	The CV41 is connected to Wi-Fi.
	Off	The CV41 is not connected to Wi-Fi.
Bluetooth	Solid blue	Bluetooth is turned on.
	Off	Bluetooth is turned off.

## System LEDs

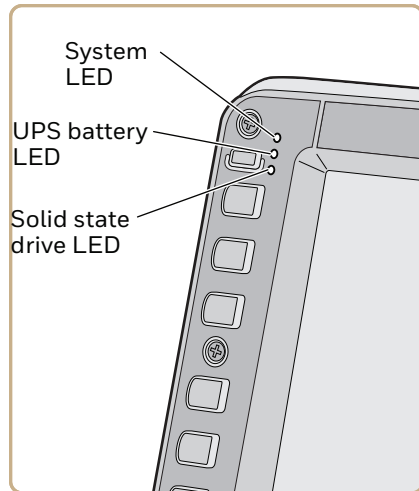

LED	State	Description
System	Solid green	The CV41 is on, or the CV41 is on but the backlight or display may be off.
	Blinking green every 4.5 seconds	The CV41 is in suspend mode, or external power is not present.
	Blinking green every 1.5 seconds	The CPU temperature is less than -20 °C (-4 °F), the heater is warming the CPU for 30 seconds, or the CV41 needs to be moved to a warmer environment.
	Off	The CV41 is off, external power is not present, or it is in suspend mode.
UPS battery	Solid green	(External power present) The UPS battery is charging. (External power not present) The CV41 is off or the UPS battery is not present.
	Solid amber	(External power present) There is no UPS battery present, the CV41 is out of charging temperature range, a charge timeout has occurred, or there is a charging fault. (External not present) UPS battery is supplying power and is discharging.
	Off	The UPS battery is fully charged, or is not charging.
Solid state drive	Flashing green	Read or write activity is occurring.
	Off	There is no read or write activity.

## CV41 Accessories

The CV41 does not ship with any accessories. All accessories are sold and ordered separately. For help, contact your Honeywell sales representative.

Accessory	Description
Quick Mount Smart Dock	The smart dock provides a mount for the CV41, and supplies conditioned power to the CV41. This dock is designed for DC powered applications only. See <a href="#">CV41 Docks</a> . For more information, see the <i>CV41 Vehicle Mounting Kit Reference Guide</i> .

Accessory	Description
Dock for Off-Vehicle Use	The smart dock provides a mount for the CV41, and supplies conditioned power to the CV41. This dock is designed for off-vehicle AC powered applications only. See <a href="#">CV41 Docks</a> .
RAM Mounting Kit	Use this mounting kit to attach the CV41 to a variety of surfaces, including a vehicle or to your desktop. For more information, see the <i>CV41 Vehicle Mounting Kit Reference Guide</i> .
USB Y-Cable	Use the USB cable to connect USB devices and peripherals to the CV41.
Screen Blanking Box	Use the screen blanking box to turn off the CV41 display while a vehicle is in motion.
CANBUS Y-Cable	Use the CANBUS Y-Cable to connect a CANBUS interface to the CV41.
UPS Battery	Purchase a new UPS battery when the one in your CV41 does not provide satisfactory operating time.
Audio Cable	Use the audio cable to connect a headset to the CV41.
Headset	Use the headset for a hands-free voice solution.
Touch Screen Protective Film (10 pack)	Use the protective film to reduce wear and protect the touch screen from being damaged.
Stylus Kit (5 pack)	Use the stylus to navigate around the user interface of the CV41.
WWAN Adhesive Mount Antenna Kit	Purchase the WWAN antenna to provide WWAN connectivity to a WWAN-enabled CV41.
GPS Antenna Kit	Purchase the GPS antenna to provide GPS connectivity to a GPS-enabled CV41.
6-96 VDC Power Connection Kit	Use this kit to supply power to trucks that are that run a voltage of greater than 60 VDC.
AC Power Supply	Use the AC power supply to power the CV41. The power supply can be connected to a 120 V or to a 230 V supply. If you are outside of the United States, you must supply your own power cord. Must use off-vehicle dock with this power supply. See <a href="#">CV41 Docks</a> .

# About Internal UPS Battery

The CV41 contains an internal UPS battery that is automatically charged when you place the CV41 in a powered smart dock. The UPS battery can power the CV41 for a minimum of 30 minutes at -20 °C (-40 °F) or higher. The UPS battery allows you to continue using the CV41 when it is not mounted in a dock or when the vehicle battery is being changed.

If the UPS battery becomes critically low on power, the CV41 performs a controlled shutdown. You can recharge it by placing the CV41 into the smart dock. You can fully charge a discharged UPS battery in approximately 4 hours.

## Maximize the Internal UPS Battery Usage



**Caution: If you plan on shipping the CV41 to a different location, make sure the internal UPS battery is disconnected. For help, see [Disconnect the UPS Battery](#).**

Adjust the backlight, screen, or computer turn off times to maximize the internal UPS battery usage. The changes you make to these settings are cumulative. For example, if you set the backlight and screen turn off times to 15 sec and the CV41 turn off times to 5 min, the CV41 actually turns off after 5 min and 15 sec.

**Note:** *Disabling the backlight also disables the screen and the CV41 turn off times. Conversely, disabling the screen turn off time also disables the CV41 turn off times.*

1. Tap **Start > Settings > Control Panel > Intermec Settings**. The Intermec Settings screen appears.
2. Tap **Device Settings > Power Management > Battery Power**. The Battery Power screen appears.

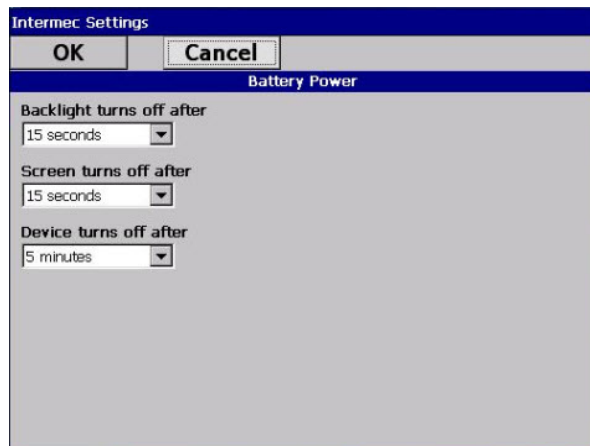

3. Adjust the **Backlight**, **Screen**, and **Device** turn off times in the drop-down menus.
4. Tap **OK** when you are finished to save your changes.

## About the Backup Battery

The CV41 has a permanent Lithium-Ion battery installed to maintain the time, date, and CMOS setup information for a minimum of 90 days. The Lithium-Ion battery is not user-replaceable and should last five years before it needs a replacement.

The backup battery must only be changed by authorized service personnel. For more information, contact your Honeywell service representative.

# Insert an SD Card

You can use an SD card to increase file storage and install software. The computer supports an optional 1 to 4 GB maximum capacity SD card.

1. Remove the CV41 from the smart dock.
2. Press the **Power** button to place the CV41 in Suspend mode.
3. Using a small Phillips screwdriver, remove the two screws that secure the SD card access panel.

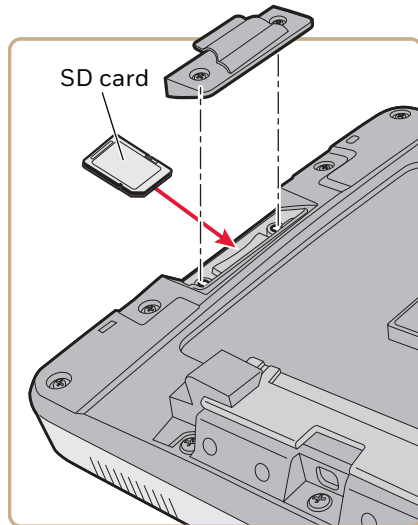

4. Insert the SD card into the SD card slot.
5. Reattach the SD card access panel and screw to a torque value of 4 to 5 in/lbs.
6. Reattach the CV41 to the smart dock.
7. Press the **Power** button to resume the CV41 from Suspend mode.

# About the Touch Screen

The CV41 comes with an 8-inch color touch screen display with a resolution of 800 x 480 pixels. The display also comes with an optional heater to reduce condensation on the external surface of the display when moving between sub-freezing temperatures and normal temperatures.

# Protect the Touch Screen

Apply the optional touch screen protective film to help protect the screen from minor damage, scratches, and abrasions. Contact your Honeywell representative to order protective film for your touch screen.

1. Clean the touch screen from fingerprints, lint particles, dust, and smudges. For more information, see [Clean the Computer](#).
2. Peel off the backing from the film to expose the adhesive.
3. Slide one edge of the film between the touch screen and display housing.
4. Repeat Step 3 for the other three edges of the touch screen film.

## Adjust the Screen Brightness

Depending on the current lighting conditions of the environment, you may want to adjust the screen brightness of the CV41.

**Note:** *If the ambient light sensor is enabled, you cannot adjust the screen brightness on the CV41.*

1. On the keypad, tap the **ALT** key to enable the secondary keys.
2. Tap **F7** to increase brightness or **F8** to decrease the brightness.
3. Repeat Steps 1 and 2 to increase or decrease brightness.

## Enable the Defroster

If your CV41 contains a defroster, use it to help reduce condensation on an external surface when the computer is moving between sub-freezing and normal temperatures.

1. Tap **Start** > **Settings** > **Control Panel** > **Intermec Settings**. The Intermec Settings screen appears.
2. Tap **Device Settings** > **Heater**. The Heater screen appears.

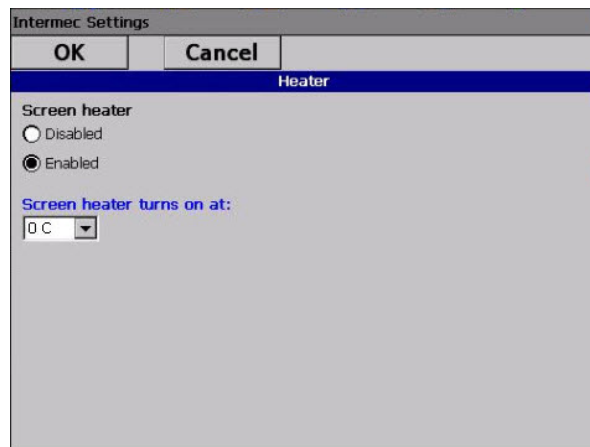

3. In **Screen heater**, select **Enabled**.
4. In **Screen heater turns on at:**, set the temperature tripping point in degrees Celsius. When the temperature reaches the trip point, the heater automatically turns on.
5. Tap **OK** to save and exit the Heater screen.



# Change the Volume

The CV41 can make sounds when you tap the screen or use an attached scanner. You can change the CV41 volume to suit your needs and the environment.

1. On the keypad, tap **ALT** to enable the secondary keys.
2. Tap **F9** to increase volume or **F10** to decrease the volume.
3. Repeat Steps 1 and 2 to increase or decrease volume.

# Connect an External Antenna



**Caution: If the CV41 has connectors for external antennas, do not power up the CV41 without the external antennas connected. Damage to the WLAN radio may result.**

The CV41 comes with either an internal or external Wi-Fi antenna option. If you ordered the external antenna option, you can purchase antennas to mount on a wall, forklift, or other flat surface using screws or small patches of adhesive-backed hook and loop fastener material.

**Note:** *If you have the internal 802.11 antenna option, you cannot connect an external 802.11 antenna to your CV41. If you are using GPS or WWAN, you must connect an external GPS or WWAN antenna.*

1. Using your own hardware, secure the external antenna to a wall, forklift, or other flat surface.
2. Secure the antenna to one of the antenna plugs on the CV41.

Wi-Fi antenna plug    Wi-Fi (aux) antenna plug    GPS antenna plug    WWAN antenna plug

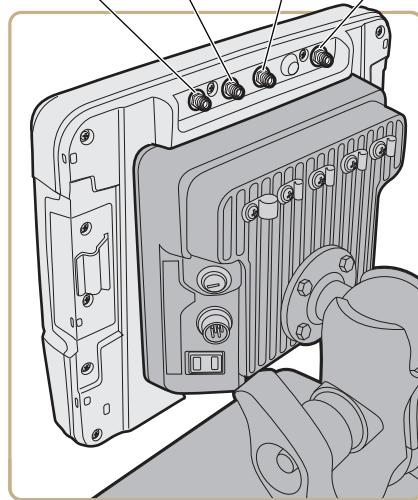

Because system performance and antenna polarization are site-dependent, a permanent mounting location may require some experimentation. In most fixed installations, you should mount the antenna initially in a vertically-polarized position, with the cable from the antenna parallel to the floor and ceiling. For information on purchasing an antenna, contact your Honeywell sales representative.

# About the Keypad

The CV41 comes with one standard keypad overlay and contains a backlight for low light conditions. Use the following sections to understand how to use the keypad.

If you need to remap the keypad, use the Device Resource Kit. You can download this Resource Kit from the Intermec Developer Library website at [www.honeywellaidc.com](http://www.honeywellaidc.com).

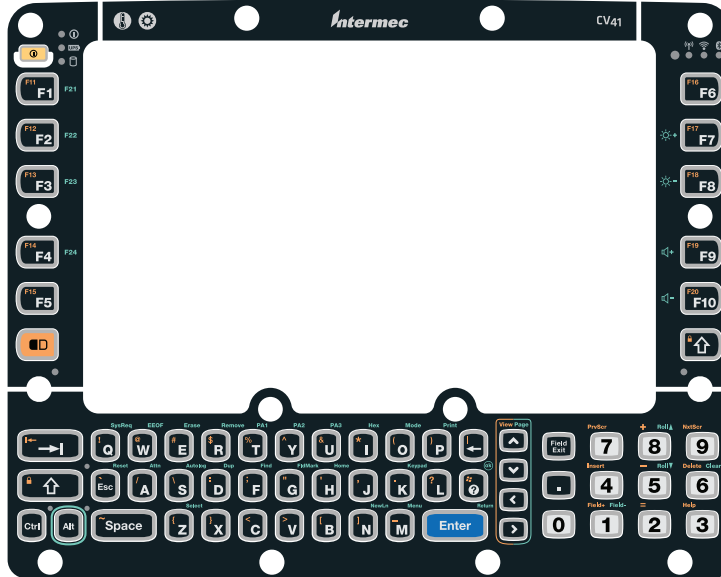

## CV41 Keypad Overlay



## Use the Modifier Keys

The CV41 keypad provides modifier keys to let you access additional characters, symbols, and functions printed on the keypad overlay. Once you understand how to use the modifier keys and key sequences, you can access all of the additional features printed on the keypad overlay.

There are three modifier keys: the orange (  ) key, the green ( **Alt** ) key, and the Control ( **Ctrl** ) key.

You want to:	Press:	Example:
Use an orange character or function printed above a key.	 key (LED turns on) and then the key with the character or function printed above it (LED turns off).	Press  and then <b>F1</b> to select the F11 function.
Use a green character or function printed above the key.	<b>Alt</b> key (LED turns on) and then the key with the character or function printed above it (LED turns off).	Press <b>Alt</b> and then  to select the <b>Print</b> function.
Enable the Control modifier key.	<b>Ctrl</b> key (LED turns on) and then the key with the character or function printed above it (LED turns off)	

## Capitalize Characters

You can capitalize characters individually, or you can type all capital letters by enabling Caps Lock.



To capitalize a single character:

- Press the  key. The **Shift** key LED flashes to show that the **Shift** key is enabled for one key press.

To enable Caps lock:

- Press the  key, and then the  key. The **Shift** key LED lights up green to show that the CV41 is in Caps Lock mode.

To disable Caps Lock:

- When Caps Lock is enabled, press the  key, and then the  key. The **Shift** key LED turns off to show that Caps Lock has been disabled.

## Enable or Disable the Keypad Backlight

The computer has a keypad backlight for low light conditions. By default, the keypad backlight is enabled. Disable the keypad to conserve power.

1. Tap **Start** > **Settings** > **Control Panel** > **Intermec Settings**. The Intermec Settings screen appears.
2. Tap **Device Settings** > **Backlight** > **Keypad Backlight**. The Keypad Backlight screen appears.

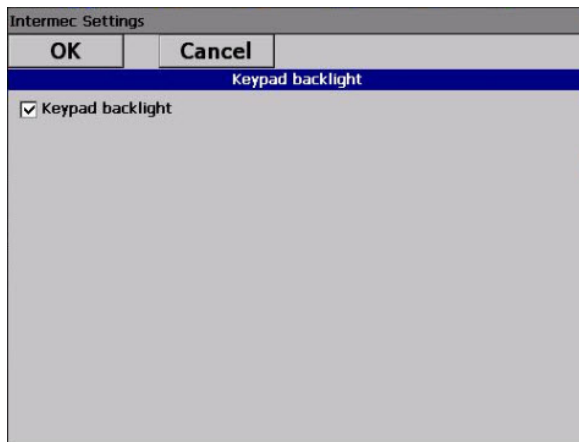

3. Clear the check box to disable the backlight, and select the check box to enable it.
4. Tap **OK** to save your changes.

## Set the Keypad and Display Backlight Timer

The keypad backlight and the display backlight share the same timer. When the display is on, the keypad backlight is also on. Use this section to learn how to set the keypad and display backlight timer.

1. Tap **Start** > **Control Panel** > **Intermec Settings**. The Intermec Settings screen appears.
2. Tap **Device Settings** > **Power Management** > **Battery Power**. The Battery Power screen appears.

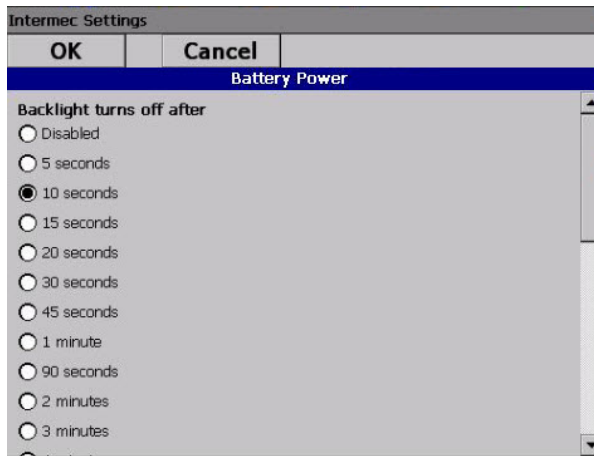

3. Select the amount of time you want the backlight timer to stay on.
4. Tap **OK** to save your settings.

# Transfer Files To and From Your PC

You can use Microsoft ActiveSync (Windows XP or earlier) or Windows Mobile Device Center (Windows Vista or Windows 7) to establish a connection between the CV41 and a PC. After you connect to your PC, you can transfer files, synchronize files, remotely debug, and perform other device management activities. ActiveSync and Windows Mobile Device Center are free applications available from the Microsoft website at [www.microsoft.com/download](http://www.microsoft.com/download).

To establish a partnership between your CV41 and a PC, you need to physically connect your computer to your PC using a standard USB cable, and a USB cable adapter. To buy the USB cable adapter, contact your Honeywell representative.

1. Connect the CV41 to the smart dock.
2. Secure the USB cable adapter to the smart dock.
3. Connect the USB cable to the USB cable adapter and to your PC.
4. Download ActiveSync from the Microsoft website and install ActiveSync on your PC.
5. Follow the on-screen instructions to establish a partnership. When the partnership is established, the Microsoft ActiveSync screen appears on your PC.

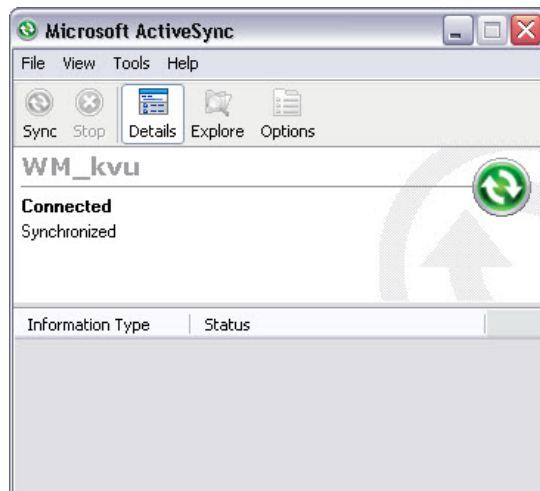

CHAPTER

# 3

## UNDERSTAND THE USER INTERFACE AND APPLICATIONS

Use this chapter to learn about the Windows Embedded CE 6.0 user interface and how to interact with the screen. You can also use this chapter to learn about the applications on your computer, as well as additional applications you can download.

# About the User Interface

The user interface for the Windows Embedded CE 6.0 operating system is similar to previous versions of Windows CE. The interface is touch-friendly and easy to navigate. Use the following sections to understand how to interact with Windows CE.

## About the Desktop Screen

When you turn on your computer, the Desktop screen is the first screen that appears, unless Intermec Terminal Emulator (ITE) is configured to automatically launch. The Desktop screen contains the Desktop and the Taskbar.

**Windows CE Default Screen**



Tap **Start > Help**, then select a topic on the computer to find additional information on Windows CE components.

## Learn the Basic Skills

This section describes the basic concepts of using and customizing the vehicle mount computer and Windows CE.

## Use the Touch Screen



Use your finger or stylus to navigate around the CV41 user interface.

Action	Description
Tap	Tap the screen once with your stylus or finger to select options, open or close applications, or launch menus.
Double-tap	Double-tap the screen with your stylus or finger to launch applications.
Drag	Hold your stylus or finger on the screen and drag across the screen to select text and images.
Tap and hold	Tap and hold your stylus or finger on an item to see a menu of actions available for that item. On the pop-up menu that appears, tap the action you want to perform.



## Use the Taskbar

The Taskbar is located at the bottom of the screen. It displays the Start menu icon, the current time, the Input panel icon, and the current status of information such as external power connections, and battery power remaining. Use the following table for CV41 specific taskbar icons.

Icon	Description
	The remaining power for the UPS battery from 0 to 100 percent.
	The UPS battery is charging.
	The CV41 is connected to external power.

For more information on Windows CE 6.0 icons, tap **Start > Help**, then select a topic on the computer to find additional information on Windows CE components.

## Use Pop-Up Menus

Use pop-up menus to quickly perform an action on an item. For example, you can use a pop-up menu to delete or make a copy of an item. To access a pop-up menu, tap and hold the item on which you want to perform the action. When the menu appears, tap the action you want to perform, or tap anywhere outside the menu to close the menu without performing the action.

## Enter Information

If you do not use the keypad, you can enter information on your vehicle mount computer in several ways depending on the program you are using.

Action	Description
Typing	Enter typed text into the computer by tapping keys on the on-screen keyboard or by using handwriting recognition software.
Writing	Use the stylus to write directly on the screen.
Drawing	Use the stylus to draw directly on the screen.

Use the input panel to enter information in any program on your computer. You can either type using the on-screen keyboard or write using Transcriber. The characters appear as typed text.

1. Tap the **Input Panel** icon. The Input Panel menu appears.
2. Tap **LargeKB**. The large keyboard displays on the desktop of the computer.

## Use Transcriber

Use Transcriber to write anywhere on the screen using the stylus just as you would on paper. You can write an entire sentence of information, and then pause to let Transcriber change the written characters to typed characters.

1. Double-tap the **Transcriber** icon on the desktop. The Transcriber Intro help box appears on the desktop with some tips on how to use Transcriber.
2. Click **OK** to close the help box. The Transcriber Input Panel appears in the lower right corner of the desktop.
3. Write anywhere on the screen. Pause and let Transcriber change the written characters to typed characters.

## Calibrate the Screen

You may need to calibrate your screen if you tap on one area and it registers in a different area of the screen. Make sure you use the stylus to complete the alignment process.

1. Tap **Start > Settings > Control Panel > Stylus**.
2. Select the **Calibration** tab.
3. Tap the **Recalibrate** button.
4. Follow the prompts on the screen to complete the alignment process.

## Set the Date and Time

Use this section to learn how to set the date and time for the CV41. Optionally, you can sync the date and time to a local time server.

1. Tap the clock on the taskbar. The Date/Time Properties screen appears.
2. Set your current date, time, and time zone.
3. Select the **Automatically adjust clock for daylight savings** if you want the CV41 to automatically adjust for daylight savings time.
4. Tap **Apply** to save your settings.

## Sync to a Local Time Server

To keep your CV41 time and date running accurately, you can sync it to a local time server through an Internet connection.

1. Establish an ActiveSync connection.
2. On the CV41, tap **My Device > Windows**.
3. Copy the **GrabTime.ini** file and place it onto your desktop PC.
4. Open the .ini file and add the local time server domain to the top of the .ini file.
5. (Optional) Delete the remaining time server domains from the list.







6. Save the .ini file and copy it back to the My Device\Windows folder on the CV41.
7. On the CV41, tap **Start > Settings > Control Panel > Options**.
8. Select **Autolaunch TimeSync** and tap **OK**.

## About Applications

Honeywell provides many useful applications to help you configure, troubleshoot, and connect your computer to other devices and networks. You can also download additional applications from the Honeywell website to help you use all of the features of your computer.

## Applications Available On the Computer

Use this table to understand some of the applications available on your computer.

Icon	Application	Description
	Intermec Settings	Use Intermec Settings to configure your computer. You can use Intermec Settings to individually configure a computer or you can use it through SmartSystems to configure all of your computers.
	iSpyWiFi	Use iSpyWiFi to check your 802.11 status and diagnose issues with the connection.
	Profile Settings	Use Profile Settings to easily configure the computer for a specific use. You can choose predefined value for Power settings. <ul style="list-style-type: none"> <li>• Tap the Profile Setting you want to use. You will see a message that changes are saved and a check mark appears next to your choice.</li> </ul>
	Bluetooth Printing	Use the Bluetooth Printing application to connect to a Bluetooth printer.
	Bluetooth Scanning	Use the Bluetooth Scanning application to connect to a Bluetooth scanner.
	Intermec Browser	Intermec Browser is a locked-down web application for your computer that is compatible with Internet Explorer 6.0. You can configure Intermec Browser for your specific application requirements and design your own web pages.
	Intermec Terminal Emulator (ITE)	Intermec Terminal Emulator (ITE), part of Intermec Client Pack (ICP), is a terminal emulation client designed for enterprise-level data collection. ITE is packed with enhancements that improve productivity, reduce errors, and deliver fast return on investment. It supports multiple emulation protocols in a single client and has new features such as session persistence, remote management and configuration, and offers a maintenance plan to keep you up-to-date with the latest releases and upgrades.

## Applications You Can Download For the Computer

You can download several applications from the website that extend the capabilities of your computer. All of the applications explained below are available from the Intermecc website. Some of the applications require the purchase of a license to run. About Intermecc Launcher

Intermecc Launcher is a Microsoft Windows application, designed for Honeywell computers that provides a platform from which other applications may be launched while attempting to provide a locked-down environment. You can configure Intermecc Launcher for your specific application requirements. You can download and use Intermecc Launcher for a 60-day evaluation period. After the evaluation period expires, you will need to purchase a license.

### About Features Demo

Features Demo provides a simple way to explore the key features of your computer. You will find applications that demonstrate scanning, document imaging, image capture, printing, and GPS functionality. Many of the applications that are part of Features Demo also have separate full-featured versions that you can download and license for your computer.

### About SmartSystems Foundation

SmartSystems™ is an easy-to-use software platform that provides IT Administrators and Integrators a single, integrated portal for hands-free provisioning, deployment, and management of Honeywell devices minimizing the effort spent on software upgrades, equipment monitoring, maintenance and troubleshooting.

SmartSystems Foundation provides a consistent way to manage Honeywell devices including computers, vehicle mounted computers, RFID readers, printers and bar code scanners, located on-site or remote, to make the most of limited IT resources, and lower the total cost of ownership for Honeywell data collection equipment. SmartSystems Foundation can be downloaded at no charge from the Honeywell website. For more information, visit [www.honeywellaidc.com](http://www.honeywellaidc.com).

CHAPTER

# 4

## MANAGE THE COMPUTER

Use this chapter to learn how to remotely update, configure, and monitor your Honeywell computers. You will also find information on installing and developing software applications as well as how to upgrade the system software.

# Manage the Computer in Your Network

When you have multiple computers and peripherals in your network, it is essential to have an easy way to manage updates, configure all of the devices, and remotely troubleshoot problems. Honeywell provides a device management software platform called SmartSystems™ Foundation to help you manage your devices. You can also purchase third-party device management software through a vendor.

## Manage the Computer Using SmartSystems Foundation

SmartSystems Foundation is a software platform that lets you manage all of your SmartSystems-enabled devices simultaneously from a central server. The SmartSystems Foundation console displays all SmartSystems-enabled computers and peripherals in your network.

### SmartSystems Foundation Console

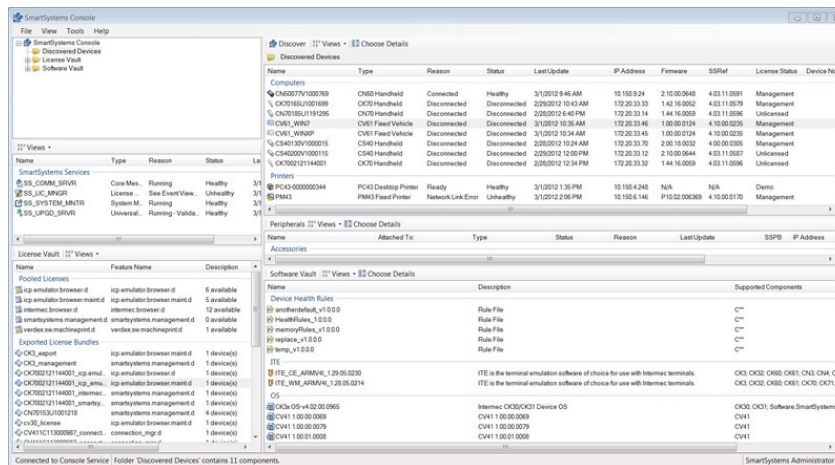

Through the console, you can:

- drag-and-drop configuration bundles, operating system updates, and firmware upgrades to multiple computers.
- save configuration settings from a single device and deploy those settings to many devices simultaneously.
- remotely change settings on SmartSystems-enabled computers and peripherals.

The SmartSystems Foundation console can report on asset locations and battery status, making it easier to manage your devices.

With a Provisioning license, SmartSystems Foundation can automatically push software, configuration settings, and other files to connected computers. You can download SmartSystems Foundation from the Honeywell website. For more information, visit [www.honeywellaidc.com](http://www.honeywellaidc.com). To purchase a Provisioning license, contact your Honeywell sales representative.

# Develop and Install Applications

Use the Intermec Resource Kits and the CV41 Software Development Kits to develop applications to run on the computer. The Resource Kits are a library of C++, .NET, Java, and web components grouped by functionality that you can use to create applications for the computer. The Resource Kits are part of the Intermec Developer Library (IDL), and can be downloaded from the Honeywell website at [www.honeywellaidc.com](http://www.honeywellaidc.com).

For more information, see the *Intermec Developer Library Resource Kit Developer Guide*.

## Package Your Application

For very simple applications, the executable file may be the only file you need to deploy. More typically, you will have a set of files to install.

Honeywell recommends using .cab files to install your applications. The computer uses standard Windows CE .cab files and will install third-party .cab files.

## Choose a Target Location

Place your application in any of these memory locations on the computer:

- The ObjectStore.
- The optional SD card. Depending on available disk space, consider installing your application files on the SD card. Using a card creates the \SD Card folder on the computer.
- The \System folder. Applications and data in the \System folder will persist through a clean boot.

## Install Applications Using SmartSystems Foundation Console

You can use the SmartSystems console to drag-and-drop applications onto your computer. The console is part of SmartSystems Foundation.

1. Download your application file from the Honeywell website and unzip it on your desktop PC.
2. Double-click the application file to install it. The application file should appear in the Software Vault.
3. From the SmartSystems console in the Software Vault, drag-and-drop the application onto each computer in your network, or drop the application on a group of computers contained in a folder.

## Install Applications Using Microsoft ActiveSync

When you only have a few computers to update with applications, you can copy files using Microsoft ActiveSync. This procedure assumes that Microsoft ActiveSync is installed on your PC and is up and running.

1. Connect to the computer using ActiveSync.
2. Copy the .cab files from your PC to the CV41.
3. Browse to the .cab files and tap the files to install them.

## Install Applications Using an SD Card

Use an SD card to install applications on one computer at a time or if you have no network connection.

1. Copy your application file to the storage card.
2. Install the SD card in the CV41.
3. On the CV41, browse to the **SD Card** folder and run your application.

## Update the Honeywell Content Software

The computer uses a series of cab files to update the operating system (OS), low-level firmware, and Honeywell Content files.

SSPB files deliver Honeywell functionality such as data collection, configuration, and wireless security to your CV41. As new features are added to these components, you can upgrade your SSPB files without needing to upgrade the operating system. Similarly, features added to the operating system do not affect the functionality of the SSPB, and you can choose to upgrade only the operating system.

## Update the Operating System and Low-Level Firmware

Use a USB flash drive to upgrade the operating system (OS) and low-level firmware of the CV41. Before you can update your CV41, you need:

- a USB Y-Cable.
- a USB flash drive.
- the upgrade .exe file. This file is available from the Honeywell Technical Support Downloads Portal at [www.hsmftp.honeywell.com](http://www.hsmftp.honeywell.com).

After you locate these items, you can update your computer.

1. Connect the USB flash drive to your PC.
2. Download and install the OS update file to your PC.
3. Click **Create\_CV41\_Update\_Drive.bat**. A command window appears and scans your PC for a connected USB flash drive.
4. In the Command window, press **3** and then **Enter**. The USB flash drive is formatted and the update files are loaded onto the drive.
5. Remove the USB flash drive and insert it into the smart dock.
6. Make sure the that the smart dock is connected to power and insert the CV41 into the dock.



7. Turn on the CV41. A screen prompt appears.
8. Press **F** and then **Enter** to update the OS and device firmware. The installer installs the update onto the CV41. When it is finished, the CV41 turns off.
9. Remove the USB flash drive and press the **Power** button. The CV41 continues the update process. After the update is complete, the computer boots again.

## Update the Honeywell Content Software

You can use these methods to update the Honeywell Content software on the CV41:

- You can update individual computers, or multiple computers at the same time using the SmartSystems console. For help, see the next section, [Update Honeywell Content Using SmartSystems Foundation](#).
- You can update individual computers using ActiveSync.

## Update Honeywell Content Using SmartSystems Foundation

You can use the SmartSystems console to update the Honeywell Content on your CV41. The console is part of SmartSystems Foundation and is available from the Honeywell website. Before you can update your CV41, you need:

- SmartSystems Foundation. To find the application, go to the Technical Support Downloads Portal at [www.hsmftp.honeywell.com](http://www.hsmftp.honeywell.com).
- .the SSPB files you want to install. These SSPB files are available from the Technical Support Downloads Portal at [www.hsmftp.honeywell.com](http://www.hsmftp.honeywell.com).

After you locate these items, you can update your CV41 using SmartSystems Foundation.

1. Open the SmartSystems console.
2. Make sure the computer is discovered.
3. Make sure the computer is in the powered smart dock and that power management is disabled.
4. Download the SmartSystems bundle to your PC.
5. Double-click the SmartSystems bundle on your PC to extract the update files to the software vault.
6. From the SmartSystems console, locate the bundle to install and drag it to each computer (or group in a folder) you want to update. The SmartSystems console installs the update to your computers.

**Note:** *The SmartSystems console indicates that your computer is offline by displaying a red stop symbol until the computer reboots and connects to the system.*

## Update Honeywell Content Using a ActiveSync

Use ActiveSync to update individual computers.

1. Establish an ActiveSync partnership. For help, see [Transfer Files To and From Your PC](#).
2. From your desktop PC, download the bundle you want to install. These bundles are available from the Technical Support Downloads Portal at [www.hsmftp.honeywell.com](http://www.hsmftp.honeywell.com).
3. Transfer the bundle file to \System directory on the CV41.
4. Tap on the file on the CV41. The computer reboots. After the computer reboots, the bundle files install. When the installation is finished, the CV41 reboots once again.

CHAPTER

# 5

## CONFIGURE THE COMPUTER

Use this chapter to learn about the available methods for configuring your computer and how to use Intermec Settings. You can also use this chapter to learn how to configure network communications and wireless security.

# How to Configure the Computer

You can configure many parameters on the computer such as the bar code symbologies it decodes or the network settings. The values you set for these parameters determine how the computer operates.

There are several ways to configure the computer:

- Directly on the computer. You can use Intermec Settings directly on the computer to change only the settings on that computer. For more information, see the next section.
- Remotely using SmartSystems Foundation. When you use SmartSystems, you can remotely configure all of your CV41 vehicle mount computers as well as other SmartSystems-enabled Honeywell computers and peripherals. For more information, see [Use Intermec Settings Remotely With SmartSystems Foundation](#).
- You can use a third-party device management product that supports the computer and Intermec Settings, such as Soti MobiControl or Wavelink Avalanche. For more information, visit the [Device Management](#) page on the Honeywell website.

You can also configure the computer with configuration bundles that you create using SmartSystems Foundation. For more information, see the SmartSystems Foundation Online Help.

## Use Intermec Settings on the Computer

Use Intermec Settings to configure parameters for Honeywell applications on the computer as well as some device-specific parameters like volume. You can configure parameters for important functions like data collection and communications.

External bar code scanners are supported by connecting the scanner to a COM port or by Bluetooth. When configuring a scanner using Intermec Settings, the scanner symbologies can be updated through the CV41 data collection software.

## Start Intermec Settings

Intermec Settings is located in the Control Panel.

- Tap **Start** > **Settings** > **Control Panel** > **Intermec Settings**. The Intermec Settings Main Menu appears.

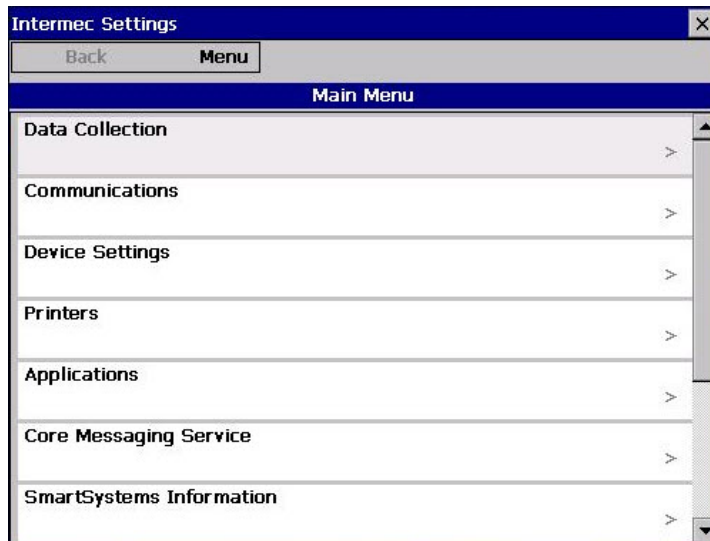

## About the Structure of Intermecc Settings

Use the following tables to help find the parameters in Intermecc Settings that you want to configure. Each table contains the parameters for one of the Intermecc Settings Main Menu options.

If you see > next to a menu option, there are more screens available in the next level. If you see ... next to a menu option, there is only one more screen available.

Most parameters are saved when you tap **OK**. Some settings require you to reboot the computer for the changes to take effect.

<b>Data Collection Options</b>	<b>Parameters You Can Configure</b>
Tethered Scanner (COM 1)	<ul style="list-style-type: none"> <li>• Enable Scanner Port</li> <li>• Symbologies</li> <li>• Symbology options</li> <li>• Scanner settings</li> <li>• Scanner port settings</li> <li>• Decode security</li> </ul>
Tethered Scanner (COM 2)	<ul style="list-style-type: none"> <li>• Enable Scanner Port</li> <li>• Symbologies</li> <li>• Symbology options</li> <li>• Scanner settings</li> <li>• Scanner port settings</li> <li>• Decode security</li> </ul>
Bluetooth Scanner	<ul style="list-style-type: none"> <li>• Symbologies</li> <li>• Symbology options</li> <li>• Scanner settings</li> <li>• Bluetooth scanner settings</li> <li>• Scanner port settings</li> <li>• Decode security</li> </ul>
BT-Configure on Connect	Bluetooth-configure on connect

<b>Communications Options</b>	<b>Parameters You Can Configure</b>
Device Name	Device name
802.11 Radio	<ul style="list-style-type: none"> <li>• Security choice</li> <li>• Security settings (includes Wi-Fi settings such as enable/disable radio)</li> <li>• Funk Security Settings</li> <li>• Microsoft Security settings</li> <li>• IP settings</li> <li>• Certificates</li> <li>• Radio bands</li> <li>• Security changes</li> </ul>
Bluetooth	Bluetooth settings (power, discoverable, connectable, and so on)

<b>Device Settings Options</b>	<b>Parameters You Can Configure</b>
Backlight	Keypad backlight
Date and Time	Date and time settings
Heater	Screen heater settings
IDL Runtime Versions	<ul style="list-style-type: none"> <li>• ITC50 (read-only)</li> <li>• ITCScan (read-only)</li> </ul>

Device Settings Options	Parameters You Can Configure
Keypad	Keypad settings
Power Management	<ul style="list-style-type: none"> <li>Battery power</li> <li>External power</li> <li>Auto-on</li> </ul>
Profile Settings Application	Whether these parameter options appear in Profile Settings: <ul style="list-style-type: none"> <li>Always on</li> <li>Maximize battery life</li> <li>Normal</li> </ul>
Screen	<ul style="list-style-type: none"> <li>Brightness settings</li> <li>Screen Blanking On Motion settings</li> </ul>
Sounds	Sound settings
System Component Versions	System component versions (read-only)

Printer Options	Parameters You Can Configure
Printer (if connected through Bluetooth)	Printer settings (Information, memory, printer definitions, power, Bluetooth communications, and so on)

**Note:** The Printer menu displays settings for Bluetooth connected printers. The settings that appear in the menu are dependent on the printer that is paired with the device. The printer needs to be paired using the Bluetooth Printing application.

Application Options	Parameters You Can Configure
Intermec Browser	<ul style="list-style-type: none"> <li>Administration settings</li> <li>Toolbar options</li> <li>Key settings</li> <li>Printer settings</li> <li>Function key mapping</li> </ul>
Intermec Terminal Emulation	<ul style="list-style-type: none"> <li>Program name (read-only)</li> <li>Program version (read-only)</li> <li>SIP settings</li> <li>No Lockdown settings</li> <li>No Auto-Start</li> <li>OOR Monitor settings</li> <li>Chk In License settings</li> <li>Trusted App settings</li> <li>Scan Control settings</li> <li>Menu options</li> <li>Toolbar options</li> <li>Debug filters</li> <li>UDP+ options</li> <li>Sessions 1 - 4</li> </ul>

Core Messaging Service Options	Parameters You Can Configure
Server IP	Server IP (read-only)
Associated Server IP	Associated server IP
Broadcast Name	Broadcast name
Port	Port (read-only)
Keep Alive Ping Interval	Keep alive ping interval

SmartSystems Information Options	Parameters You Can Configure
Identity	Identity information (hardware version, firmware version, OS version, and so on) (read-only)
Administrator	Administrator settings (name, phone, and email)
Location	Location settings (country, state, city, campus, and detail)
Information	Device Notes (read-only)

Device Monitor Options	Parameters You Can Configure
Device Health Controls	<ul style="list-style-type: none"> <li>• Enable health data collection</li> <li>• Set rule file location</li> <li>• Set data refresh periods</li> </ul>

Virtual Wedge Options	Parameters You Can Configure
Enable Virtual Wedge	Enable virtual wedge
Virtual Wedge Method	Set the virtual wedge method (adapt to application, character mode, and block mode)
Bar Code Scanner Wedge	Bar code scanner wedge settings (bar code scanner grid and label encoding)

License Manager Options	Parameters You Can Configure
About	About settings (read-only)
License Vault	None (displays applications that are licensed)

RFID Options	Parameters You Can Configure
RFID Service	RFID Service settings

For more information on all parameters in Intermec Settings, see the *Intermec Settings Command Reference Manual*.

## Navigate in Intermec Settings

You can easily navigate Intermec Settings to find the parameter you need to configure.



To move down a level:

- Tap the menu item in the list.

To move back a level:

- Tap **Back** or **Cancel** on the Tile bar.

To save a parameter setting:

- Tap **OK**.

To exit Intermec Settings:

- Tap **Menu** > **Exit** or **OK**.

## Configure Profile Settings With Intermec Settings

A profile is a set of predefined values that you can easily apply to the computer to ensure optimal performance in a specific scenario. The end user does not need to figure out the “right” settings because we have already done that work for you. Profile Settings is available from the **Start** > **Programs** menu so you can make it available to the end user for easy configuration.

### Profile Settings Screen

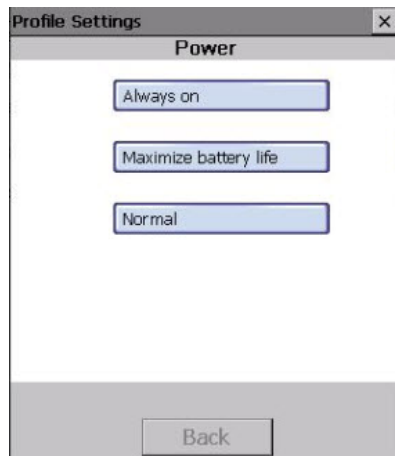

Use Intermec Settings to determine the profiles you want the end user to see in the Profile Settings application.

1. Go to **Device Settings** > **Profile Settings Application**.
2. Select **Always on**, **Maximizing battery life**, or **Normal**.

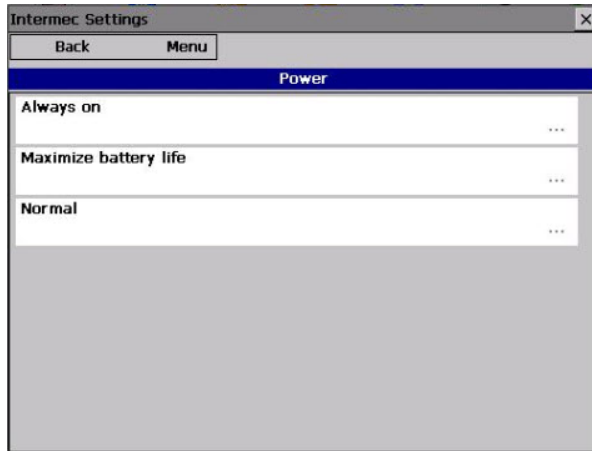

3. From the sub-menus, select or clear the **Show option in Profile Settings** check box for the settings you want to have available to the end user.
4. Click **OK** to save your selection.

## Restore Default Settings

You can easily restore a menu to its default settings or all of the Intermec Settings parameters to their default settings if necessary.

1. Navigate to the menu that you want to restore to defaults.
2. Tap **Menu > Restore Menu Defaults**.

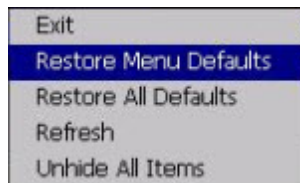

3. When prompted, tap **Yes** to restore the menu default settings.
4. If prompted to refresh the computer, tap **Yes**.

You can restore defaults settings for all parameters.

1. Tap **Menu > Restore All Defaults**. The application asks if you are sure you want to restore all defaults.

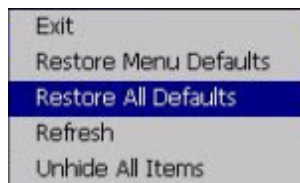

2. Tap **Yes**.

After several minutes, all of the default settings are restored.

## Hide Menu Items in Intermec Settings

You can hide items in the Intermec Settings menus if you do not want them available for other users to access. Hidden items are not saved when you back up your settings in the SmartSystems console.

On the computer, you can:

- hide menu items by tapping and holding the item, and then choosing **Hide Menu Item** from the popup list. When asked if you want to hide the menu, tap **Yes**.
- restore all hidden items in all menus, by tapping **Menu > Unhide All Items**.

**Note:** *When you restore default settings in Intermec Settings, only the settings for visible items are restored to defaults. The settings for hidden menu items are not affected.*

## Use Intermec Settings Remotely With SmartSystems Foundation

Your computer is SmartSystems-enabled, which lets you open Intermec Settings from the SmartSystems console to remotely configure all of your computers. For more information on SmartSystems, see [Manage the Computer Using SmartSystems Foundation](#).

1. In the SmartSystems console, select a computer and right-click.
2. From the menu, select **Start Intermec Settings**.
3. Configure the settings you need to change. As you choose parameters from the tree structure, help for each parameter appears in the upper right pane of Intermec Settings.
4. When you are done making changes, choose **File > Save Settings**.

For help using Intermec Settings, click **Help > Contents**. For information on all of the parameters in Intermec Settings, see the *Intermec Settings Command Reference Manual*.

## About Network Communications

You can easily add the computer to your wireless or wired data collection network. You can connect your computer using:

- 802.11a/b/g radio communications.
- Bluetooth communications.
- USB and serial communications.

## Configure 802.11a/b/g (Wi-Fi) Radio Communications



**Caution: Make sure all components with antennas are at least 30 cm (1 ft) apart when power is applied. Failure to comply could result in equipment damage.**

The computer contains an 802.11 radio to transfer data using wireless communications and to support the TCP/IP network protocols. This section of the manual assumes that your wireless network is set up, including your access points.

By default, the 802.11 radio is enabled. If it is disabled, use the following procedure to enable the Wi-Fi radio using Intermec Settings.

1. From the Intermec Settings main menu, tap **Communications > 802.11 Radio > Radio Enabled**.



2. Select the **Radio Enabled** check box and tap **OK**. By default, the computer uses Funk security and enables DHCP.
3. Use Intermec Settings to configure any other parameters you need to use for communication with your network.
4. Configure 802.11 security. For help, see [About Wireless Security](#).

## Configure Bluetooth Communications

Your computer is Bluetooth™-enabled, which lets you connect to other Bluetooth devices, such as scanners or printers.

The Bluetooth radio needs to be on before you can discover and connect to other Bluetooth devices. By default, the radio is turned on. You can configure Bluetooth communications using Intermec Settings or from the Start menu.

1. From the Intermec Settings main menu, tap **Communications > Bluetooth**.

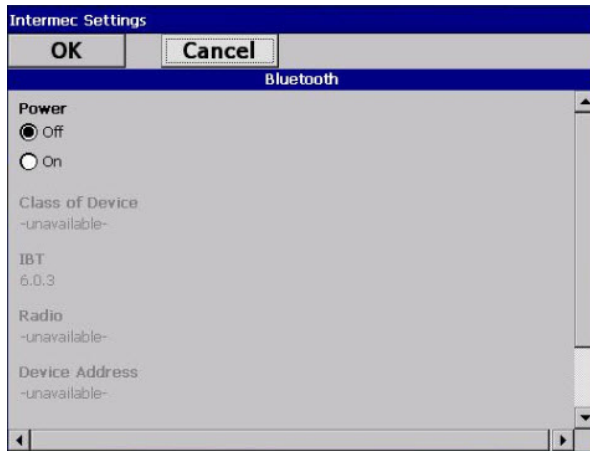

2. Select the **On** check box.
3. Tap **OK**.  
The Bluetooth radio maintains its state through a reboot or cold boot and maintains virtual COM ports. But, if you clean boot your computer you need to recreate pairings to devices.

## Connect to a Bluetooth Scanner

You can connect the computer to an Honeywell Bluetooth scanner, such as the SF51 or SR61.

1. Tap **Start > Settings > Control Panel > Bluetooth Scanning**.



2. Tap **Add Device**.



3. Select **Quick Connect**, **Search**, or **Manual**. Follow the onscreen instruction to add a wireless scanner.

## Connect to a Bluetooth Printer

To configure your computer for Bluetooth wireless printing, you need to:

- create an application that opens the wireless printing COM port on your computer. For help, see the Bluetooth Resource Kit, which is part of the Intermecc Developer Library (IDL), available from [www.honeywellaidc.com](http://www.honeywellaidc.com).
- select the current wireless printer on your computer. For help, see the next procedure.

**Note:** You can also print wirelessly using Microsoft APIs with Bluetooth extensions for Winsock and Bluetooth virtual COM ports. For help, see the Bluetooth Resource Kit documentation.

1. Tap **Start > Settings > Control Panel > Bluetooth Printing**.



2. Tap **Search** to find a printer, or tap **Manual** to enter a device address. Follow the onscreen instructions to select the current wireless printer.
3. (Optional) Tap **Print Test Page**. The printer prints out a test page.

## About Serial and USB Communications

Use a serial or USB cable to transmit and receive data from another device through serial or USB communications. If you are using a USB cable, you must purchase a USB Y-Cable. For more information, contact your Honeywell representative.

## Connect to a USB Scanner

When an HID-enabled USB scanner is used with the CV41, any data handling must be programmed into the scanner because the data transmits to an active window as a key-stroke message, and bypasses the Intermecc Data Collection wedge. You can program the scanner by:

- scanning the configuration bar codes from the scanner manufacturer.
- installing an application that accepts the incoming data.

For the SR30 or SR61T, you must purchase the correct scanner USB cable to use with the CV41. For more information, see the following table.

Scanner Model	Required Cable
SR30	6.5 ft (1.9 m) cable (P/N 236-159-002)
SR61T (Gen 1)	6.5 ft (1.9 m) cable (P/N 236-182-001)
SR61T (Gen 2)	6.5 ft (1.9 m) cable (P/N 236-240-001)

## Connect to a Serially Tethered Scanner

Use this procedure to connect your computer to connect a tethered scanner and enable RS-232 communications. For the SR30 or SR61T, you must purchase the correct serial cable to use with the CV41. For more information, see the following table.

Scanner Model	Required Cable
SR30	6.5 ft (1.9 m) cable (P/N 236-164-002)
SR61T (Gen1, Gen 2)	<ul style="list-style-type: none"> <li>6.5 ft (1.9 m) cable (P/N 236-197-001)</li> <li>12 ft (3.6 m) cable (P/N 237-197-001)</li> </ul>

1. Connect the scanner to the COM1 or COM2 port.
2. From the Intermec Settings main menu, select **Tethered Scanner (COM 1 or COM 2)**.

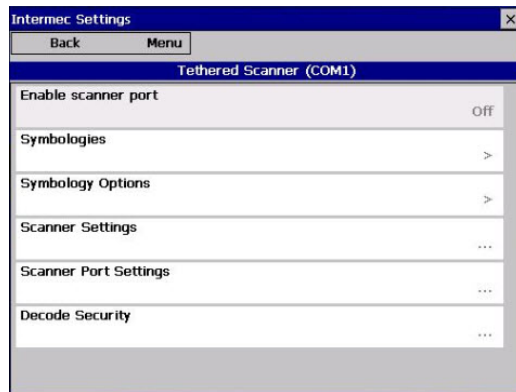

3. Tap **Scanner Settings**.

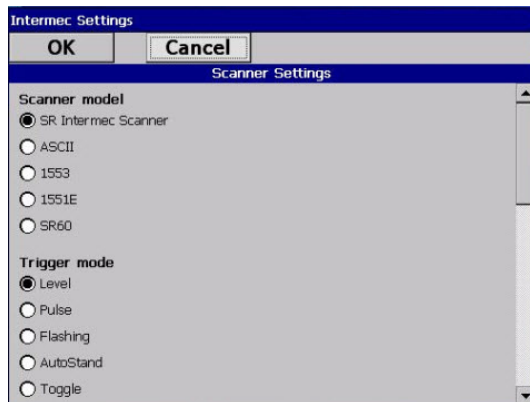

4. Perform one of these items based on the type of scanner you are connecting:
  - For an SR30 or SR61T scanner, tap **Scanner Settings**, select **SR Intermec Scanner**, and then tap **OK**.
  - For an ASCII scanner, tap **Scanner Settings**, select **ASCII**, and then tap **OK**. Set up the appropriate COM port settings by selecting **Scanner Port Settings**.
5. Tap **Enable scanner port**.
6. Check the **Enable scanner port** check box and tap **OK**.

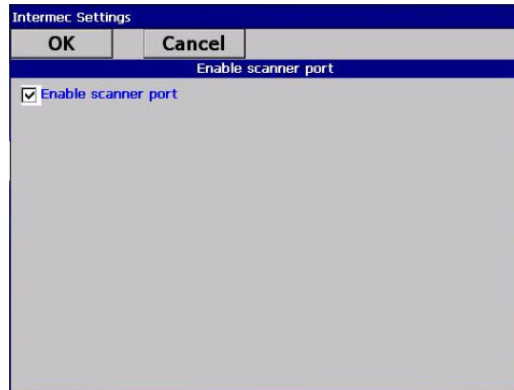

## Create an ISP Connection

You can create an Internet Service Provider (ISP) connection to send and receive email messages using Messaging (Outlook Email) and view web pages using Internet Explorer Mobile. You need to get your ISP dial-up access telephone number, a user name, and a password from your ISP.

1. Tap **Start** > **Settings** > **Control Panel**.
2. Double-tap **Network and Dial-up Connections**.
3. Double-tap **Make New Connection**.

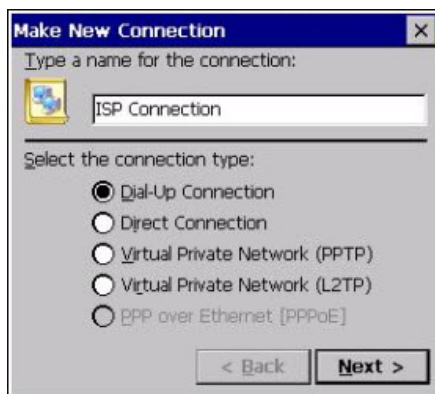

4. Enter a name for the connection, such as "ISP Connection."
5. Select the **Dial-up Connection** radio button.
6. Tap **Next**.



7. If you are using an external modem connected to your computer with a cable, select **Hayes Compatible on COM1** from the **Select a modem** list.

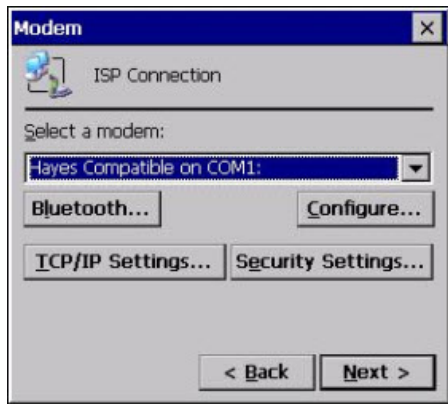

8. Tap **Next**.



9. Enter the access phone number and then tap **Finish**.
10. Double-tap on the connection you just created.
11. Tap **Dial Properties**.

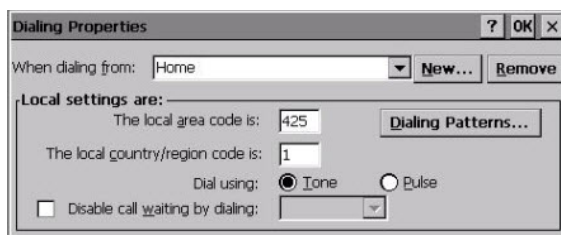

12. On the Dialing Properties screen, configure your dialing properties and tap **OK**.
13. Enter the **User name**, **Password**, and **Domain** (if provided by an ISP or your network administrator).
14. Tap **Connect**.

## Create a VPN Server Connection

You can create a Virtual Private Network (VPN) connection to securely connect to servers, such as a corporate network, through the Internet. Before you can create a VPN connection, you need this information from your network administrator:

- User name
- Password
- Domain name
- TCP/IP settings
- Host name or IP address of the VPN server

After you have located this information, you can create a VPN server connection.

1. Tap **Start** > **Settings** > **Control Panel**.
2. Double-tap **Network and Dial-up Connections**.
3. Double-tap **Make New Connection**.
4. Double-tap either **Virtual Private Network (PPTP)** or **Virtual Private Network (L2TP)**.
5. Step through the screens to set up your VPN connection.

## About Wireless Security

The computer provides five types of security for your wireless network:

- Wi-Fi Protected Access 2 (WPA2™)
- Wi-Fi Protected Access (WPA)
- 802.1x
- LEAP
- WEP

This section explains how to configure wireless security on your computer. Honeywell recommends that you implement WPA2 security using PSK (Personal) or 802.1X (Enterprise) key management as appropriate.

You must use either Funk or Microsoft security to implement your security solution. For details, see the next section, [Choose Between Microsoft and Funk Security](#) Honeywell recommends that you always implement WPA2 security using PSK (Personal) or 802.1X (Enterprise) key management.

If you are using WPA-802.1x, WPA2-802.1x, or 802.1x security, this section also assumes that your authentication server and authenticators are properly configured.

**Note:** *Your security choice does not depend on your authentication server. For example, you can choose Funk security if you use Microsoft Active Directory® to issue certificates.*

## Choose Between Microsoft and Funk Security

The computer supports both Funk and Microsoft security, which dynamically select wireless networks based on your preferences. The option you choose depends on your network security needs.

- If you are using the computer in a static environment that requires a high level of security, you should use Funk security, which offers CCX v4.0 compliance, support for LEAP and TTLS, and configuration for up to four profiles.  
To use Funk security, you need to select a profile. For help, see the next section, [Select a Funk Security Profile](#)
- If you are primarily using the computer to connect to Wi-Fi hotspots, you may want to use Microsoft security.  
To use Microsoft security, you need to select it as your security choice. For help, see [Select Microsoft as Your Security Choice](#).

### Select a Funk Security Profile

You can define up to four profiles for Funk security. Different profiles let your computer communicate in different networks without having to change all of your security settings. For example, you may want to set up one profile for the manufacturing floor and one for the warehouse. By default, the active profile is Profile 1.

### Select a Funk Security Profile

Use the following procedure to select a Funk security profile.

1. Start Intermec Settings.
2. Choose **Communications > 802.11 Radio > Funk Security**.
3. Choose a profile. A list of configurable settings appears.
4. (Optional) In the **Profile Label** text box, enter a meaningful name for your profile.
5. Configure your security settings. For help, see the next sections.
6. Repeat Steps 3 through 5 for each profile you want to define.
7. Set an active profile by choosing it from the **Active Profile** list.
8. Save your settings.

### Configure WPA or WPA2 Enterprise (802.1x) Security With Funk

Use these procedures to set WPA-802.1x or WPA2-802.1x security on your computer with Funk security.

1. Make sure the communications and radio parameters on your computer are configured.
2. Make sure Funk is selected as your security choice.
3. Start Intermec Settings.
4. Choose **Communications > 802.11 Radio > Funk Security**.

5. Select the profile you want to configure.
6. For **Association**, choose **WPA** or **WPA2**. Encryption automatically defaults to **TKIP** or **AES**, respectively.
7. For **8021x**, choose **TTLS**, **PEAP**, **EAP-FAST**, or **TLS**.
8. If you choose **TTLS**, **EAP-FAST**, or **PEAP**:
  - a. For **Prompt for Credentials**, choose **Enter credentials now**.
  - b. Enter a **User Name** and **User Password**.
  - c. For **Validate Server Certificate**, choose **Yes**.

**Note:** *The correct date must be set on your computer when you enable **Validate Server Certificate**.*

9. If you choose **TLS**:
  - a. Load a user and root certificate on your computer. For help, see [Load a Certificate](#).
  - b. Enter a **User Name** and **Subject Name**.
  - c. For **Validate Server Certificate**, choose **Yes**.

## Configure WPA or WPA2 Personal (PSK) Security With Funk

Use the following procedure to configure WPA-PSK or WPA2-PSK with Funk security.

1. Make sure the communications and radio parameters on your computer are configured.
2. Make sure Funk is selected as your security choice.
3. Start Intermec Settings.
4. Choose **Communications > 802.11 Radio > Funk Security**.
5. Select the profile you want to configure.
6. For **Association**, choose **WPA** or **WPA2**.
7. For **8021x**, choose **None**.
8. For **Pre-Shared Key**, enter the pre-shared key or passphrase.  
The pre-shared key must be a value of 32 hex pairs preceded by 0x for a total of 66 characters. The value must match the key value on the access point. The passphrase must be from 8 to 63 characters. After you enter a passphrase, the computer internally converts it to a pre-shared key. This value must match the passphrase on the authenticator.
9. Save your settings.

## Configure 802.1x Security With Funk Security

Use the following procedure to configure 802.1x-WEP security with Funk security. Honeywell recommends that you use WPA2-802.1x instead of 802.1x-WEP if possible.

1. Make sure the communications and radio parameters on your computer are configured.
2. Make sure Funk is selected as your security choice.
3. Start Intermec Settings.
4. Choose **Communications > 802.11 Radio > Funk Security**.
5. Select the profile you want to configure.
6. For **Association**, choose **Open**.
7. For **Encryption**, choose **WEP**.
8. For **8021x**, choose **TTLS, PEAP, or TLS**.
9. If you chose **TTLS** or **PEAP**:
  - a. Enter a **User Name**.
  - b. For **Prompt for Credentials**, choose **Enter credentials now**.
  - c. Enter a **User Password**.
  - d. For **Validate Server Certificate**, choose **Yes**.
10. If you choose **TLS**:
  - a. Load a user and root certificate on your computer. For help, see [Load a Certificate](#).
  - b. For **Validate Server Certificate**, choose **Yes**.
  - c. Enter a **User Name** and **Subject Name**.
11. Save your settings.

### Configure LEAP Security With Funk

After you configure the communications and radio parameters on your computer and select Funk as your security choice, you can configure LEAP.

1. Start Intermec Settings.
2. Choose **Communications > 802.11 Radio > Funk**.
3. Select the profile you want to configure.
4. For **8021x**, choose **LEAP**.
5. For **Association**, choose **Open, WPA, WPA2, or Network EAP**. Encryption automatically defaults to **TKIP** if you choose **WPA**, **AES** if you choose **WPA2**, and **WEP** if you choose **Open** or **Network EAP**.
6. For **Prompt for Credentials**, choose **Enter credentials now**.
7. Enter a **User Name** and **User Password**.
8. Save your settings.

### Configure Static WEP Security With Funk Security

Use the following procedure to configure static WEP security with Funk. Honeywell recommends that you use WPA2-PSK instead of WEP if possible.

1. Make sure the communications and radio parameters on your computer are configured.
2. Make sure Funk is selected as your security choice.
3. Start Intermec Settings.
4. Choose **Communications > 802.11 Radio > Funk Security**.
5. Select the profile you want to configure.
6. For **8021x** choose **None**.
7. For **Association**, choose **Open**.
8. For **Encryption**, choose **WEP**.
9. Define a value for the keys you want to use. You can define up to four keys (**Key 1** through **Key 4**).  
Enter an ASCII key or a hex key that is either 5 bytes or 13 bytes long depending on the capability of the radio. Set a 5-byte value for 64-bit WEP or a 13-byte value for 128-bit WEP. Hex keys must be preceded by 0x and contain 5 or 13 hex pairs.
10. For **Transmit key**, choose the key you want to use for transmitting data.
11. Save your settings.

### Use Open (No Security) Associations with Funk

Use the following procedure to configure your computer for open security using Funk.

1. Start Intermec Settings.
2. Choose **Communications > 802.11 Radio > Funk Security**.
3. Select the active profile you are using.
4. For **Association**, choose **Open**.
5. For **Encryption**, choose **None**.
6. Tap **OK**. Your settings are saved.

### Select Microsoft as Your Security Choice

The default security setting is Funk. If you want to use Microsoft Wireless Zero Configuration (WZC) security, you need to select it as your security choice. After you select Microsoft as your security choice, you will be prompted to save your settings and reset the computer for your change to take effect.

With Microsoft as your security choice, you can configure:

- WPA or WPA2
- 802.1x
- Static WEP

### Select Microsoft Security

Use the following procedure to select Microsoft security.

1. Start Intermec Settings. For help, see [Start Intermec Settings](#).
2. Choose **Communications > 802.11 Radio > Security Choice**.
3. From the **Security Choice list**, select **Microsoft Security**. An alert box appears telling you that you must save your settings and reboot the computer for the new security choice to take effect.
4. Tap **Yes**. The computer resets and starts with Microsoft Security as the Security Choice.

## Configure WPA or WPA2 Enterprise (802.1x) Security With Microsoft

Use these procedures to set WPA-802.1x security on your computer with Microsoft security.

1. Make sure the communications and radio parameters on your computer are configured.
2. Start Intermec Settings.
3. Choose **Communications > 802.11 Radio > Microsoft Security**.
4. For **Infrastructure Mode**, choose **Infrastructure**.
5. For **Network Authentication**, choose **WPA** or **WPA2**. Data Encryption automatically defaults to **TKIP** for WPA and **AES** for WPA2.
6. For **802.1x Authentication**, choose either **TLS** or **PEAP**.
7. If you choose **TLS**:
  - a. Load a user and root certificate on your computer. For help, see [Load a Certificate](#).
  - b. Choose **Properties**. The Certificates dialog box appears.
  - c. Select the certificate you want to use from the list. The User Logon dialog box appears.
  - d. Enter a **User Name** and **Domain** and tap **OK**.
  - e. Tap **OK** to exit the Certificates dialog box.
  - f. Tap **OK** to save the Microsoft Security settings.
8. If you choose **PEAP**:
  - a. Load a root certificate of the authentication server on your computer. For help, see [Load a Certificate](#).
  - b. Tap **OK** to save the security settings and the User Logon dialog box appears.
  - c. Tap a **User Name**, **Password**, and **Domain**. Select **Save Password** if you want to save the password for future authentication sessions.
  - d. Tap **OK** to save the Microsoft Security settings.

## Enable WPA or WPA2 Personal (PSK) Security With Microsoft

Use the following procedure to enable WPA-PSK With Microsoft Security.

1. Make sure the communications and radio parameters on your computer are configured.
2. Start Intermec Settings.
3. Choose **Communications > 802.11 Radio > Microsoft Security**.
4. For **Infrastructure Mode**, choose **Infrastructure**.
5. For **Network Authentication**, choose **WPA-PSK**. Data Encryption automatically defaults to **TKIP** for WPA and **AES** for WPA2.
6. For **Pre-Shared Key**, enter the pre-shared key or the passphrase.  
The pre-shared key must be a value of 32 hex pairs preceded by 0x for a total of 66 characters. The value must match the key value on the authenticator. The passphrase must be from 8 to 63 characters. After you enter a passphrase, the computer internally converts it to a pre-shared key.
7. Save your settings.

### Configure 802.1x Security with Microsoft

Use the following procedure to configure 802.1x security with Microsoft security. Honeywell recommends that you use WPA2-802.1x instead of 802.1x-WEP if possible.

1. Make sure the communications and radio parameters on your computer are configured.
2. Start Intermec Settings.
3. **Choose Communications > 802.11 Radio > Microsoft Security**.
4. For **Infrastructure Mode**, choose **Infrastructure**.
5. For **Network Authentication**, choose **Open**.
6. For **Data Encryption**, choose **WEP**.
7. For **802.1X Authentication**, choose **TLS** or **PEAP**.
8. If you choose TLS:
  - a. Load a user and root certificate on your computer. For help, see [Load a Certificate](#).
  - b. Choose **Properties**. The Certificates dialog box appears.
  - c. Select the certificate you want to use from the list. The User Logon dialog box appears.
  - d. Enter a **User Name** and **Domain** and tap **OK**.
  - e. Tap **OK** to exit the Certificates dialog box.
  - f. Tap **OK** to save the Microsoft Security settings.
9. If you choose PEAP:
  - a. Load a root certificate of the authentication server on your computer. For help, see [Load a Certificate](#).
  - b. Tap **OK** to save the security settings and the User Logon dialog box appears.
  - c. Enter a **User Name**, **Password**, and **Domain**. Select **Save Password** if you want to save the password for future authentication sessions.
  - d. Tap **OK** to save the Microsoft Security settings.



10. For **Network Key Setting**, choose **Automatic**.
11. Save your settings.

## Configure Static WEP Security With Microsoft

Use the following procedure to configure static WEP security with Microsoft security. Honeywell recommends that you use WPA2-PSK instead of WEP if possible.

1. Make sure the communications and radio parameters on your computer are configured.
2. Start Intermec Settings.
3. Choose **Communications > 802.11 Radio > Microsoft Security**.
4. For **Network Authentication**, choose **Open**.
5. For **Data Encryption**, choose **WEP**.
6. For **Network Key Setting**, choose **Enter Key and Index**.
7. For **Network Key Value**, enter an ASCII key or a hex key that is either 5 bytes or 13 bytes long depending on the capability of the radio.  
Set a 5-byte value for 64-bit WEP or a 13-byte value for 128-bit WEP. Hex keys must be preceded by 0x and contain 5 or 13 hex pairs.
8. For **Network Key Index**, select the key you want to use for data transmission.
9. Save your settings.

## Use Open (No Security) Associations With Microsoft

Use the following procedure to configure your computer for open security using Microsoft WZC.

1. Start Intermec Settings.
2. Choose **Communications > 802.11 Radio > Microsoft Security**.
3. For **Network Authentication**, choose **Open**.
4. For **Data Encryption**, choose **Disabled**.
5. Tap **OK**. Your settings are saved.

## Load a Certificate

To use transport layer security (TLS) with WPA or 802.1x security, you need a unique client certificate on the computer and a trusted root certificate authority (CA) certificate. Certificates are pieces of cryptographic data that guarantee a public key is associated with a private key. They contain a public key and the entity name that owns the key. Each certificate is issued by a certificate authority.

1. Start Intermec Settings.
2. Tap **Communications > 802.11 Radio > Certificates**. The Certificates screen appears.

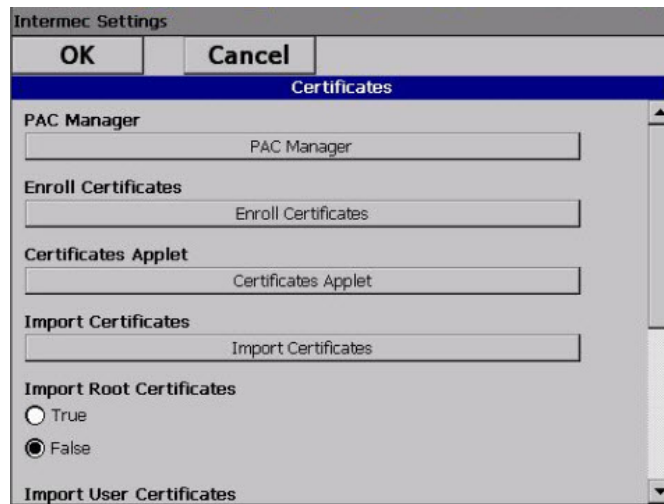

3. To import user and root certificates from a Microsoft IAS server:
  - a. Tap **Import Certificates**.
  - b. Tap **Web Enrollment**.
  - c. Enter the **User**, **Password**, and **Server** (IP address) to log into the server.
  - d. Tap **OK**. A dialog box appears asking if you want to load the root certificate.
  - e. Tap **OK**. The Enrollment Tool message box appears telling you that the certificate has been added.
  - f. Tap **OK** to close the message box.
4. To import a certificate chain:
  - a. Tap the **Import PFX** tab.
  - b. Tap **Import Certificates** to install the selected certificate.
  - c. In the CertImportUI screen, tap the <<< button next to the Select pfx to import text field.
  - d. Select the root certificate from the list.
  - e. Tap **Import Certificate**.

## USE THE AUTO-ON FEATURE

You can use the Auto-On feature to turn on the CV41 when apply external power to the computer.

# About the Auto-On Feature

The Auto-On feature turns on the CV41 when you apply external power to the computer. When Auto-On is disabled, the CV41 monitors the ignition input signal and turns on the computer when the ignition on your vehicle is active.

To disable the Auto-On feature, you must wire the ignition input wire from your CV41 to your vehicle to monitor the ignition input signal. For more information, see the CV41 Vehicle Mounting Kit Reference Guide.

## Enable the Auto-On Feature

When Auto-On is enabled, the CV41 turns on when external power is applied. For example, when the smart dock is powered on and:

- the CV41 is placed into the dock.
  - the CV41 is placed into the dock and the vehicle is turned on.
1. Tap **Start** > **Settings** > **Control Panel** > **Options**. The Options screen appears.
  2. Tap the **Misc** tab.
  3. Select **Enable Auto-On** and tap **OK**.

## Disable the Auto-On Feature

When Auto-On is disabled, the CV41 is turned off, and the ignition input signal:

- is inactive, the CV41 remains off.
- changes to active, the CV41 turns on.

When the Auto-On is disabled, the CV41 is turned on, and the ignition input signal:

- changes to active, the CV41 stays on.
  - changes to inactive, the CV41 is placed into Suspend mode.
1. Tap **Start** > **Settings** > **Control Panel** > **Options**. The Options screen appears.
  2. Tap the **Misc** tab.
  3. Make sure that **Enable Auto-On** is not selected and tap **OK**.

# USE WWAN AND GPS COMMUNICATIONS

Some configurations of the CV41 come equipped with a WWAN radio. With WWAN enabled, you can use UMTS or CDMA communications to transmit data through cellular wide-area networks (WANs), and use the Global Positioning System Receiver (GPS).

# About WWAN Communications

The CV41 Vehicle Mount Computer has an optional WWAN radio that supports both CDMA and UMTS cellular technology. Use either one of these technologies to transmit data through cellular wide-area networks.

## Activate UMTS Communications

You use a SIM card to activate UMTS communications on your computer. You can purchase the SIM card from your network provider.

1. Remove the CV41 from the smart dock.
2. Press the **Power** button to place the CV41 in Suspend mode.
3. Using a small Phillips screwdriver, remove the two screws that secure the SIM card access panel.

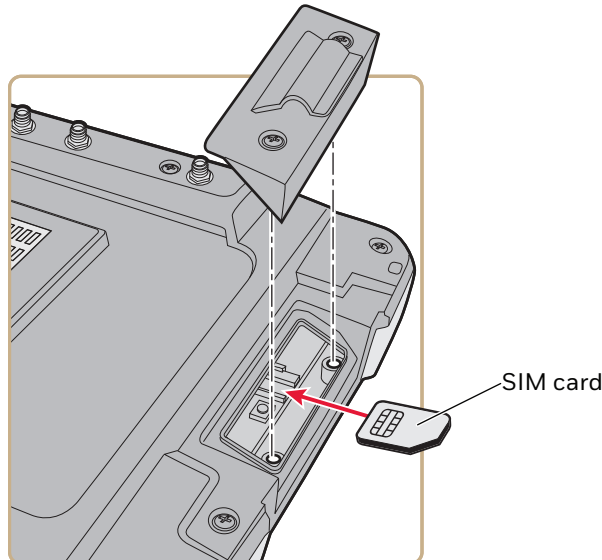

4. Insert the SD card into the SD card slot.
5. Reattach the SD card access panel and screw to a torque value of 4 to 5 in/lbs.
6. Reattach the CV41 to the smart dock.
7. Connect an external WWAN antenna. For more information, see [Connect an External Antenna](#).
8. Press the **Power** button to resume the CV41 from Suspend mode.
9. Select **Start > Programs > GobiCM > GobiCMExe**.
10. In **Firmware Selection**, select your wireless carrier and click **Update Firmware**.
11. Select the **UMTS** tab.
12. In **Data Connection Test**, tap **Connect**.
13. Tap **Save Connection Data**.

## Activate CDMA Communications

To activate the CDMA radio module in your computer, you need to contact your wireless carrier and set up an account for each computer. The following table lists the carriers that Honeywell currently supports. If your carrier is not listed in the table, please contact Honeywell product support to see if it is now supported.

Country	Carriers
United States	Verizon

The carrier requires the Mobile Equipment Identifier (MEID) to start the activation process. You can find the MEID:

- in the Gobi Connection Manager menu. Tap **Start > Settings > Control Panel > Gobi Connection Manager > CDMA** tab.

After you supply the MEID to your carrier, the carrier responds with values that you must enter in the Gobi Connection Manager (if required). Your carrier sales contact and a Honeywell representative can guide you through the process.

1. Press the **Power** button to place the CV41 in Suspend mode.
2. Connect an external WWAN antenna. For more information, see [Connect an External Antenna](#).
3. Press the **Power** button again to turn on the CV41.
4. Select **Start > Programs > GobiCM > GobiCMExe**.
5. In **Firmware Selection**, select your wireless carrier and click **Update Firmware**.
6. Select the **CDMA** tab, enter **\*22899** in the **Activation Code** field, and tap **Save Connection Data**.
7. Tap **Activate**.
8. Tap **Save Connection Data**.

## About GPS

The GPS receiver in the CV41 delivers standards-based National Marine Electronics Association (NMEA) data strings to GPS applications. To use the GPS receiver, you need to:

- enable WWAN communications. For more information, see [Use WWAN and GPS Communications](#).
- install an external GPS antenna to the CV41. For more information, see [Connect an External Antenna](#).

For more information on purchasing an external GPS antenna, contact your Honeywell representative.

## Test the GPS Receiver

Use this section to learn how to test the GPS receiver on the CV41 using the Gobi Connection Manager.

1. Make sure WWAN communications is enabled. For more information, see [Use WWAN and GPS Communications](#).
2. Make sure an external GPS antenna is connected. For more information, see [Connect an External Antenna](#).
3. Select **Start > Programs > GobiCM > GobiCMExe**.
4. Select the **GPS** tab and tap **Start**. The Gobi Connection Manager shows your current location.
5. Tap **Stop** to finish the test.



# ENABLE SCREEN BLANKING

Enable screen blanking on your computer to turn off the computer screen while your vehicle is in motion.

# About Screen Blanking

The CV41 supports screen blanking. When motion is detected, a screen blanking box or switch turns off the computer screen to avoid unnecessary driver distractions. Once the vehicle is stationary, the screen turns back on. To enable screen blanking on your computer, you must purchase one of the following:

- Screen blanking box
- Switch

Honeywell recommends that you use the screen blanking box to enable screen blanking on the CV41. If your vehicle lacks an electrical signal that detects vehicle motion, use a switch to enable screen blanking.

You can install the switch in a variety of ways, but Honeywell recommends you install a switch that closes when the user presses the accelerator pedal on a vehicle.

Honeywell does not sell a switch for screen blanking, but you can purchase a screen blanking box from Honeywell. For more information, contact your Honeywell representative.

## Install the Hardware for Screen Blanking

This section explains how to install the switch to enable screen blanking on your computer. To install the screen blanking box, see the instructions that came with the screen blanking box.



**Caution: Installation of the screen blanking box or switch should be done by trained service personnel only.**

## Before You Install the Switch

Before you install the switch or relay for screen blanking, you need to supply power to the vehicle mount computer. For more information, see the CV41 Vehicle Mounting Kit Reference Guide.

## Tools You Need

To install the switch, you need the following parts and tools:

- Switch
- Mounting hardware and tools
- Custom serial cable

## Create a Custom Serial Cable

To install the switch, you need to create a custom serial cable with a DB9 connector built to the following specifications outlined below.

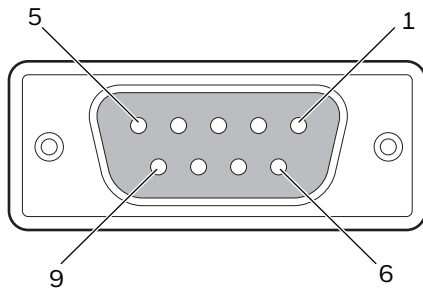

Pin	Signal	Description
1	Not used	
2	Not used	
3	Not used	
4	Not used	
5	Not used	
6	Not used	
7	RTS	Request to send output
8	CTS	Clear to send input
9	Not used	

## Install Switch for Screen Blanking

This section explains how mount, connect, and enable the switch for screen blanking.

1. Using your own mounting hardware, secure the switch sensor to the vehicle.
2. Connect the serial cable to the switch. Make sure that Pin 7 connects to the switch connection and Pin 8 connects to the other terminal.

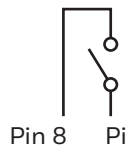

3. Connect the serial cable to the COM1 or COM2 port on your computer.

## Enable Screen Blanking

After you have wired and mounted the motion switch sensor, you must enable screen blanking in Intermec settings on the vehicle mount computer.

1. In Intermec Settings, select **Device Settings > Screen Blanking on Motion**.
2. In **Screen Blanking on Motion**, select the COM port the custom serial cable is connected to.
3. In **Screen-on delay after motion stops (sec)**, enter the amount of time in seconds that you want the display to turn on after the vehicle is stationary.
4. Tap **OK**. Screen blanking is enabled.

CHAPTER

# 9

## TROUBLESHOOT AND MAINTAIN THE COMPUTER

If you encounter any problems while using the computer, look in this chapter to find a possible solution. You will also find information on routine maintenance.

# About the Intermec Dashboard

The Intermec Dashboard is designed to provide proactive monitoring of your mobile computers to prevent downtime. You can easily see the health of the device and can help pinpoint the source of a problem to determine if it is hardware or software related. Intermec Dashboard displays information such as the status of network connections, battery usage, storage space, and internal devices. It also provides system information such as the operating system, firmware, and hardware configuration.

- Press the Intermec Dashboard button (  ) on the keypad.

Intermec Dashboard is highly integrated with SmartSystems Foundation. You can use SmartSystems Foundation to remotely monitor the health of your computers. For more information, refer to the SmartSystems online help.

## Troubleshoot Your Computer

Use the troubleshooting tables in this section to fix problems with the Wi-Fi connection, 802.1x security, or general problems with operating the computer.

**Note:** *If you send the computer in for service, it is your responsibility to save the computer data and configuration. Honeywell is responsible only for ensuring that the hardware matches the original configuration when repairing or replacing the computer.*

## Troubleshoot the Wi-Fi Connection

Use this troubleshooting table to help solve problems with your 802.11 radio connection.

Problem	Solution
When you turn on the computer after it was suspended for a while (10 to 15 minutes or longer), it can no longer send or receive messages over the network.	Host may have deactivated or lost current terminal emulation session. In a TCP/IP direct connect network, turn off the "Keep Alive" message from host to maintain the TCP session while the computer is suspended.
The computer is connected to the network and you move to a new site to collect data. Your computer now shows you are not connected to the network.	Move closer to an access point or to a different location to reestablish communications until you reconnect with the network.
The computer appears to be connected to the network, but you cannot establish a terminal emulation session with the host computer.	There may be a problem with the host computer, or with the connection between the access point and the host computer. Check with the network administrator to make sure the host is running and allowing users to log in to the system.
The computer appears to be connected to the network, but the host computer is not receiving any information from the computer.	There may be a problem with the connection between the access point and the host computer. Check with the network administrator or use your access point user's manual.

Problem	Solution
A network connection icon appears in the toolbar, but then disappears.	The computer may not be communicating with the intended access point. Make sure the network name matches the access point network name. The access point may not be communicating with the server. Ensure the access point is turned on, properly configured, and has 802.1x security enabled.

## Troubleshoot 802.1x Security

Use the following table to troubleshoot problems with your 802.1x security that will prevent you from connecting to your network, such as an incorrect password.

Problem	Solution
The computer indicates it is not authenticated.	Make sure that: <ul style="list-style-type: none"> <li>the User Name and Password parameters on the computer must match the user name and password on authentication server. You may need to reenter the password on both the computer and authentication server.</li> <li>on your authentication server, the user and group are allowed and the group policy is allowed to log into the server. For help, see the documentation that shipped with your authentication server software.</li> <li>the IP address and secret key for access point must match the IP address and secret key on the authentication server. You may need to reenter the IP address and secret key on both your access point and authentication server.</li> <li>the authentication server software is running on the server PC.</li> </ul>
You receive a message saying "The server certificate has expired or your system date is incorrect" after you perform a clean boot on the computer.	Date and time are not saved when you perform a clean boot. Reenter the date and time, and then save your changes.

## Check 802.11 Network Status

If you have trouble connecting to your 802.11 wireless network:

- Make sure you have correctly set network parameters on the computer.
- Check your wireless security settings.

Follow the next procedure to verify available access points and networks, check signal strength, and view other diagnostics. If you need to contact Honeywell Product Support, this information can be helpful in troubleshooting wireless network connection issues.

1. Tap **Start > Programs > iSpyWiFi**. The iSpyWiFi application launches. The iSpyWiFi tab shows:
  - MAC address and IP address of the 802.11 radio.
  - network association status, including the SSID and MAC address of the access point.
  - security configuration.
  - radio transmit power and signal strength information.
2. Tap the **Scan** tab to view a list of available 802.11 networks. The list includes the signal strength, channel, and MAC address for each network.
  - Tap **Scan** to refresh the screen.
3. Tap the **Supp** tab to view radio supplicant information, including a list of supplicant events and authentication status.
  - To verify the settings for the currently active security profile, tap **Configure Profile**. Intermec Settings launches for you to configure 802.11 Radio settings.
  - To try reconnecting to the network, tap **Reconnect**.
  - To delete the events in the list, tap **Clear Events**.
4. Tap the **Ping** tab to run a ping test to the host.
  - a. In the **Host** field, enter the IP address of the host.
  - b. From the **Repetitions** list, choose the number of times the computer will ping the host.
  - c. Tap **Ping**. The graph shows the amount of time it takes for the host to return the ping. Tap **List** to see this information in a list format.
5. Tap the **RSSI** tab to view the received signal strength of the host signal. The information box includes the current signal strength, host SSID name, MAC address, data rate, and transmit power.
  - Tap **Mark** to place an arrow marker above the graph.
6. Tap the **Conf** tab to set up a log file that lists RSSI history. This screen includes the 802.11 radio driver version and available radio modes.
  - a. Check the **Log to File** check box.
  - b. (Optional) Change the sample period and number of samples displayed.
  - c. Tap **Log File**. The Save As screen appears.
  - d. (Optional) Change the name of the saved log file, the folder to which the file will be saved, the content type (log or text), and the location.
  - e. Tap **OK**.



# Troubleshoot Reading Bar Codes

Use this section to troubleshoot problems that may prevent you from being able to read a bar code with an Honeywell scanner. If you cannot find the solution in the following table, refer to your scanner user guide for more information.

Problem	Solution
<p>You cannot see the illumination beam or frame from the scanner when you press the <b>Scan</b> button and aim the imager at a bar code label.</p>	<ul style="list-style-type: none"> <li>You may be too far away from the bar code label. Try moving closer to the bar code label and scan it again.</li> <li>You may be reading the bar code label “straight on.” Change the reading angle and try again.</li> <li>The imager hardware trigger might be disabled in Intermec Settings. To check the setting go to <b>Start &gt; Settings &gt; Control Panel &gt; Intermec Settings &gt; Data Collection &gt; Scanner Settings</b>. Hardware trigger should be checked.</li> </ul>
<p>When you release a <b>Scan</b> button or handle trigger, the <b>Good Read</b> light does not turn off.</p>	<p>The <b>Good Read</b> light remains on if you configure the computer to use continuous/edge triggering. If you configure the computer for level triggering and the <b>Good Read</b> light remains on, there may be a problem. Press one of the <b>Scan</b> buttons or pull the trigger again without scanning a bar code label. If the light is still on, contact your Honeywell representative.</p>
<p>The scanner will not read the bar code label.</p>	<ul style="list-style-type: none"> <li>Aim the scanner beam to cross the entire bar code label in one pass. Vary the scanning angle.</li> <li>Check the quality of the bar code label. Scan a bar code label that you know will scan. Compare the two bar code labels to see if the bar code quality is too low. You may need to replace the label that you cannot scan.</li> <li>Make sure the bar code symbology is enabled and configured correctly. Use Intermec Settings to check the symbologies. Expand <b>Data Collection &gt; Symbologies</b> beneath devices listed (scanner, virtual wedge) to check and enable symbologies, then scan the bar code label again.</li> <li>Make sure the computer application is expecting input from a bar code. You may need to type this information instead</li> <li>Check to see if the right scanner model is selected. To check the setting go to <b>Start &gt; Settings &gt; Control Panel &gt; Intermec Settings &gt; Data Collection &gt; Scanner Settings</b>.</li> <li>Check to see if the scanner cable is damaged.</li> </ul>
<p>The scanner does not read the bar code labels quickly, or the scanning beam seems to be faint or obscured.</p>	<p>The scanner window may be dirty. Clean the window with a solution of ammonia and water. Wipe dry. Do not allow abrasive material to touch the window.</p>
<p>When Enable Scanner Port is checked in Intermec Settings, the “COM port is busy. Another application may be using the port” error message appears.</p>	<p>Confirm that no other application is currently using the COM port or select another COM port for the scanner. If that does not work, try to restart the computer to see if the COM port becomes available.</p>

Problem	Solution
The scanner does not read the bar code or is corrupted when it is enabled as an ASCII scanner.	<ul style="list-style-type: none"> <li>Check to see if the Scanner Port Settings in Intermecc Settings match those settings programmed in the scan engine.</li> <li>The scanner may be in an unknown state. Reset the scanner to the factory default settings by scanning the manufacturer's configuration bar code, and reconnect the scanner.</li> </ul>
You scan a valid bar code label to enter data for your application. The data decoded by the scanner does not match the data encoded in the bar code label.	The scanner may have decoded the bar code label in a symbology other than the label's actual symbology. Try scanning the bar code label again. Make sure you scan the entire label.
The input device attached to the computer does not work well or read bar code labels very quickly.	Set the Scanner Model command to the specific attached input device. Check enabled bar code symbologies and enable only the symbologies being used.

## Troubleshoot Operating the Computer

Use this section to troubleshoot problems that may prevent you from being able to operate the computer.

Problem	Solution
You press the <b>Power</b> button and nothing happens.	<p>Try the following solutions:</p> <ul style="list-style-type: none"> <li>Make sure that power is connected to the computer, and that the Power switch on the smart dock is on.</li> <li>If your computer is not connected to the smart dock, you may have run out of battery power.</li> <li>Disconnect the UPS battery and turn the power back on. For help, see <a href="#">Disconnect the UPS Battery</a>.</li> </ul>
The computer appears to be locked up and you cannot enter data.	<ul style="list-style-type: none"> <li>Perform a cold boot. For help, see <a href="#">Cold Boot the Computer</a>.</li> <li>Perform a warm boot. For help, see <a href="#">Warm Boot the Computer</a>.</li> <li>Perform a clean boot. For help, see <a href="#">Clean Boot the Computer</a>.</li> <li>If the computer does not boot or reset, contact your Honeywell representative for help.</li> </ul>
You tap the screen and nothing happens.	Align your screen. For help, see <a href="#">Calibrate the Screen</a> .
You cannot type a character on the keypad or you can only type uppercase or lowercase letters.	You may have locked a modifier key on the keypad. Press the necessary key sequence to unlock the key.

## Call Product Support

See [Customer Support](#).

## Find Your Configuration Number

Use the following procedure to help you find the configuration number of your computer.

- Look at the label on the back of the computer.

## Find Your Operating System Version

Use the following procedure to find the OS version of your computer.

- Tap **Start** > **Settings** > **Control Panel** > **About**. The OS version is displayed in the **Version** tab as the Intermec Content version.

## Reset the Computer

If the computer does not resume after pressing the **Power** button, or if the computer or an application locks up, you may need to reset the computer. The computer uses the configuration currently saved in flash memory during the boot process. There are four ways to reset the computer:

- Cold boot
- Warm boot
- Clean boot
- Disconnect the UPS battery

## Cold Boot the Computer

If the computer seems to be locked up, try cold booting it. Cold booting the CV41 restarts the computer and RAM is cleared, while the registry and files under \System folder are preserved.

1. Tap **Start** > **Settings** > **Control Panel** > **Registry**.
2. Tap the **Coldboot** button.

## Warm Boot the Computer

Warm booting the CV41 restarts the computer, while the file system and registry settings are preserved.

1. Tap **Start** > **Settings** > **Control Panel** > **Registry**.
2. Tap the **Warmboot** button.

## Clean Boot the Computer

In some cases where the computer completely stops responding, it may be necessary to perform a clean boot. Because clean booting may result in data loss, use this method only if all other recovery methods have failed. This returns the computer back to its factory default settings.

**Note:** Clean booting the device erases all files in the ObjectStore including any file or registry changes. Any files that are present in the \System folder are preserved.

1. Tap **Start** > **Settings** > **Control Panel** > **Registry**.
2. Tap the **Load Factory Defaults** button.

## Disconnect the UPS Battery

If the CV41 stops responding, or you plan on shipping the CV41, you need to disconnect the UPS battery.

1. Remove the CV41 from the smart dock. For help, see [Remove the CV41 from the Smart Dock](#).
2. Using a Phillips head screwdriver, remove the two screws that secure the SIM card access panel.

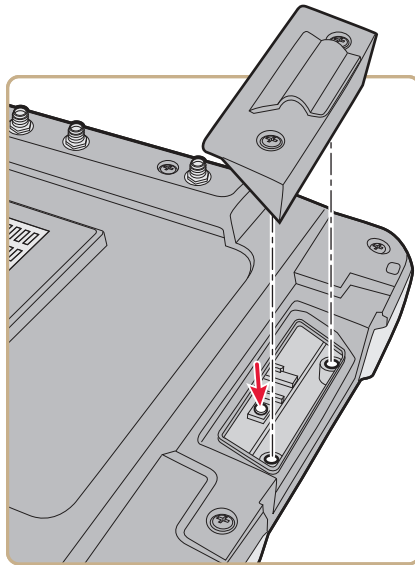

3. Press the **UPS Battery Disconnect** button located below the SIM card slot.
4. Reinstall the SIM card access panel and tighten the screws to a torque to a value of 4-5 in/lbs.

Once power external power is reconnected to the CV41, the UPS battery automatically reconnects.

## Replace the Fuse

The CV41 uses a 10 A time delay (slow blow) fuse, which is located on the smart dock. If you need to replace the fuse, make sure that you replace it with the same size, rating, and type of fuse (Littelfuse 03260 10 MXP or equivalent).

1. Remove the CV41 from the smart dock. For help, see [Remove the CV41 from the Smart Dock](#).
2. Disconnect the smart dock from power.
3. Using a flathead screwdriver, remove the fuse holder from the CV41.

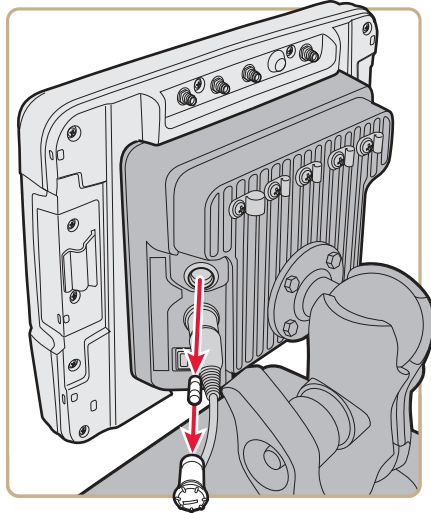

4. Replace the fuse.
5. Secure the fuse holder back into the CV41.

## Clean the Computer

To keep the computer in good working order, you may need to clean the touch screen. Clean the touch screen as often as needed for the environment in which you are using the computer. To clean the computer, use a solution of ammonia and water.

1. Press the **Power** button to suspend the computer.
2. Dip a clean cloth towel in the ammonia solution and wring out the excess.
3. Wipe off the touch screen. Do not allow any abrasive material to touch these surfaces.
4. Wipe dry.



APPENDIX

# A

## SPECIFICATIONS AND DEFAULT SETTINGS

# Physical and Environmental Specifications

## Physical Dimensions

CV41 dimensions	21.4 x 26.8 x 4.3 /6.6 cm (8.4 x 10.6 x 1.7/2.6 in)
CV41 weight	2.1 kg (5.6 lbs)
Smart dock dimensions	15.5 x 18 x 6.4 cm (6.1 x 7.1 x 2.5 in)
Smart dock weight	1.2 kg (3.2 lbs)

## Environmental Specifications

Standard operating temperature	Non-condensing: -20 °C to 50 °C (-4 °F to 122 °F)
Extreme operating temperature	Condensing: -30 °C to 50 °C (-22 °F to 122 °F)
Storage temperature	Non-condensing: -30 °C to 60 °C (-22 °F to 148 °F)
Relative humidity	Up to 90% non-condensing at 40 °C (104 °F) with extended temperatures up to 100%
Water and dust	IP66
ESD	15 kV
Vibration	MIL-STD-810F, composite wheeled vehicles
Crash	SAE-J 1455

## Power and Electrical Specifications

Input power	DC input voltage: 10 to 60 VDC Input current: 4.6 A Input fuse: 10 A time delay
External power supply	Internal power supply: 10-60 VDC AC adapter: 90-240 VAC DC power supply: 6-96 VDC
Backup battery (CMOS)	Field replaceable, rechargeable lithium-ion battery, 30 minutes of life at -20 °C (-4 °F).

## Hardware

Touch Screen	20 cm (8 in) color WVGA 800 x 480 LED backlit display. Standard display: <ul style="list-style-type: none"><li>• 400 NIT indoor display</li><li>• Ambient light sensor</li><li>• Glove compatible</li><li>• Field-replaceable resistive touch screen</li></ul> Optional display: <ul style="list-style-type: none"><li>• 900 MIT outdoor display</li><li>• Defroster</li></ul>
--------------	---



Keypad	Backlit 64 QWERTY keyboard with number pad and 10 function keys. Universal keyboard overlay legend and supports VT220, 3270, 5250. All keys (except modifiers and the power button) are mappable.
Processor	Intel Atom Z530 at 1.6 GHz
Memory	1 GB total mappable memory with 512 MB as system memory in Windows CE.
Integrated radio	802.11a/b/g
Interfaces	USB 2.0 host port, USB 1.1 client port, two RS-232 COM ports, a CANBUS/audio port, DC power input and ignition input, and RF antenna ports for Wi-Fi, WWAN, and GPS.
Antennas	Dual internal antennas or optional external antennas
Removable storage	Secure Digital
Operating system	Microsoft Windows CE 6.0

## Wireless LAN

Data rates	Supports all 802.11a/b/g data rates.
Wireless frequencies (varies by domain)	<ul style="list-style-type: none"> <li>• 2.4 to 2.4895 GHz IEEE 802.11b/802.11g DSSS OFDM</li> <li>• 5.15 to 5.82 GHz IEEE 802.11a DSSS OFDM</li> </ul>
RF data rates	1, 2, 5.5, 6, 9, 11, 12, 18, 14, 36, 48, 54 Mbps
RF power level	64 mW (18 dBm)
Channels	FCC: 1-11, 36, 40, 44, 48, 149, 153, 157, 161 ETSI: 1-13, 36, 40, 44, 48
Security	WPA, WPA2, 802.1x (EAP-TLS, TTLS, LEAP, PEAP, EAP-FAST), WEP
Cisco compatibility	CCX v4 certified

## Bluetooth

Data rates	Up to 3.0 Mbits over the air
Connection	10 m (32.8 ft) line of sight
Bluetooth version	2.0 + EDR
Operating frequency	2.402-2.480 GHz
QDID	B013455

## Default Configuration

The following tables list the default values of the configuration settings supported on the computer. If you restore the computer to factory default settings, the computer uses these values.

The settings are grouped by function and reflect the organization of Intermec Settings. Not all of the configuration settings are listed in this appendix. For detailed information on most of the settings, see the *Intermec Settings Command Reference Manual*.

## Data Collection Settings

Use data collection settings to configure the Bluetooth or tethered scanner and to configure the bar codes that you want the imager to be able to read.

Data Collection Setting	Default Value
Enable Scanner	Off
BT-Configure On Connect	Overwrite with computer settings

Symbology	Default Value
AustraliaPost	Disable
Aztec	Disable
BPO	Disable
CanadaPost	Disable
Codabar	Disable
Codablock A	Disable
Codablock F	Disable
Code 11	Disable
Code 39	Enable
Code 93	Disable
Code 128/GS1-128	Enable Code 128, GS1-128, GS1-128 identifier
DataMatrix	Enable
DutchPost	Disable
EAN/UPC	Enable UPC A, UPC E, EAN 8, EAN 13
GS1 Composite	Disable
GS1 DataBar Expanded	Disable
GS1 DataBar Limited	Disable
GS1 DataBar Omni-Directional	Disable
JapanPost	Disable
KoreaPost	Disable
Matrix 2 of 5	Disable
Maxicode	Disable
Micro PDF417	Disable
MSI	Disable
PDF417	Enable
Planet	Disable
Plessey	Disable
Postnet	Disable
QR Code	Disable
Standard 2 of 5	Disable
Telepen	Disable

<b>Symbology</b>	<b>Default Value</b>
TLC 39	Disable

<b>Symbology Option Settings</b>	<b>Default Value</b>
Preamble	None (Disable)
Postamble	None (Disable)
Symbology Identifier	Disable
Multicode	Disable

<b>Scanner Settings</b>	<b>Default Value</b>
Scanner Model	SR Intermec Scanner
Trigger Mode	Level
Aimer Mode	Typical aimer
Hardware Trigger	Enable
Trigger Timeout (sec)	2
Aiming Duration (msec)	500
Turn Off After Good Read	Enable/One-shot
Number of Good Read Beeps	One

<b>Scanner Port Settings</b>	<b>Default Value</b>
Baud Rate	57600

<b>Decode Security Settings</b>	<b>Default Value</b>
Consecutive Data Validation	0
Identical Consecutive Timeout	300 ms
Different Consecutive Timeout	0
Center Decoding	Disable
Center Decoding Tolerance	0

<b>Scanner Settings</b>	<b>Default Value</b>
Scanner Model	SR Intermec Scanner
Trigger Mode	Level
Aimer Mode	Typical aimer
Hardware Trigger	Enable
Trigger Timeout (sec)	2
Aiming Duration (msec)	500
Turn Off After Good Read	Enable/One-shot
Number of Good Read Beeps	One

## Communications

Use communications settings to configure how the computer communicates with the network.

Communications Setting	Default Value
Device Name	Intermec CV41

802.11 Radio Setting	Default Value
Radio Enabled	Off
Security Choice	Funk
Microsoft Security	Disable
Active Profile	Profile 1
DHCP	Enable
Import Root Certificates	False
Import User Certificates	False
Import Pac Files	False
Radio Bands	Indeterminate
Allow Security Changes	Enable

Bluetooth Setting	Default Value
Bluetooth Power	On

## Device Settings

Use device settings to configure settings on the computer.

Backlight Setting	Default Value
Keypad Backlight	Enable

Screen Setting	Default Value
Screen Heater	Enabled
Screen Heater Turns Off at	0°C

Keypad Setting	Default Value
Caps Lock on Reboot	Disabled

Battery Power Setting	Default Value
Backlight Turns On After (Battery Power)	3 seconds
Screen Turns Off After (Battery Power)	15 seconds
Device Turns Off After (Battery Power)	5 minutes
Backlight Turns On After (External Power)	2 minutes
Screen Turns Off After (External Power)	2 minutes
Device Turns Off After (External Power)	5 minutes

Battery Power Setting	Default Value
Auto-on	Disable

Profiles Settings	Default Value
Always On	Show Option in Profile Settings
Maximize Battery Life	Show Option in Profile Settings
Normal	Show Option in Profile Settings

Screen Settings	Default Value
Brightness	High
Screen Blanking On Motion	Disable
Screen-On Delay After Motion Stops (sec)	1.0

Sound Setting	Default Value
Beeper and Voice	15
Headset Beeper	0
Screen Taps	Off
Key Clicks	Off

## Core Messaging Service Settings

Use core messaging service settings to configure the message routers between client and server software applications.

Core Messaging Service Setting	Default Value
Associated Server IP	Null
Broadcast Name	INTERMEC
Port	62241
Keep Alive Ping Interval	30 Seconds

## Device Monitor Settings

Use device monitor settings to configure how the computer monitors the network.

Device Health Setting	Default Value
Enable Health Data Collection	On
Set Rule File Location	\\SmartSystems\HealthRules.txt
Set Data Refresh Periods Asset Msg Send Period System Device Health Network Device Health Printer	0 seconds 90 seconds 45 seconds 0
Network Device Health Refresh (seconds)	45

## RFID Settings

Use RFID settings to enable the RFID service.

RFID Settings	Default Value
Enable RFID Service	Off

## Virtual Wedge Settings

Use virtual wedge settings to configure the virtual wedge.

Virtual Wedge Settings	Default Value
Virtual Wedge	Enable
Virtual Wedge Method	Adapt to Application
Barcode Scanner Grid	Null
Label Encoding (Code Page)	1252(D)-ANSI Win3.1 US

## Port Pin Assignments

Use this section to learn about the ports pin assignments on the CV41, smart dock, and cables.

### COM 1 and COM 2 Ports

The COM 1 and COM 2 ports are located on the smart dock. By default, Pin 9 is configured to provide + 5 V for an external bar code scanner, or it can be configured to provide RI.

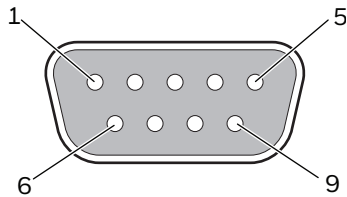

Pin	Signal	Description
1	DCD	Data carrier detect (input)
2	RXD	Receive data (input)
3	TXD	Transmit data (output)
4	DTR	Data terminal ready (output)
5	GND	Signal/power ground
6	DSR	Data set ready (input)
7	RTS	Request to send (output)
8	CTS	Clear to send (input)
9	+5 VDC or RI	Bar code scanner power (500 mA max) or Ring indicator (input)
Shell	CGND	Chassis ground

## USB Port

The USB port is located on the back of the smart dock.

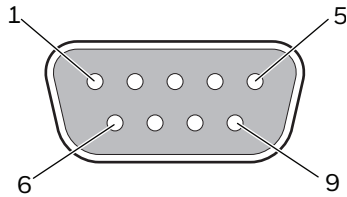

Pin	Signal	Description
1	GND	Common ground
2	USBC_D+	USB client data signal
3	USBC_D-	USN client data signal
4	USB_H1_PWR	USB host 1 (5 V output power)
5	GND	Common ground
6	GND	Common ground
7	USB_H1_D+	USB host 1 data signal
8	USB_H1_D-	USB host 1 data signal
9	USBC_VBUS	USB client (5 V detect from attached host)

## CANBUS/Audio Port

The CV41 CANBUS and audio port is located on the smart dock. The CV41 cannot support CANBUS and audio simultaneously.

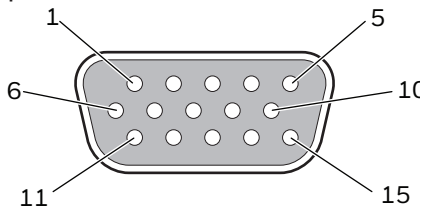

Pin	Signal	Description
1	-	CAN reserved
2	CAN_L	CAN_L bus line dominant low
3	CAN_GND	CAN ground
4	-	CAN reserved
5	GND	Optional ground
6	Audio return	Headset return
7	Audio output	Headset output
8	Mic input	Microphone input
9	Mic return	Microphone return
10	Audio return	
11	GND	Optional ground

Pin	Signal	Description
12	CAN_SHLD	
13	CAN_H	CAN_H bus line dominant high
14	-	CAN reserved
15	CAN_V+	Optional CAN external power supply

## Power Supply Connector

Power is supplied from the smart dock to the CV41 through the power connector. The power supply connector also provides a connection point for the vehicle chassis ground to be connected internally to the conductive chassis of the computer. The CV41 internal power supply can accept DC input voltages in the range of 10 to 60 VDC.

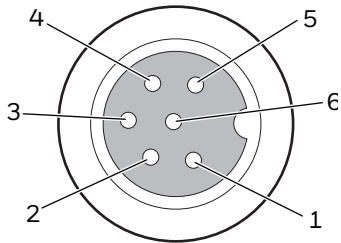

Pin	Signal	Description
1	V In+	10-60 nominal DC input +
2	V In+	10-60 nominal DC input +
3	V In-	Input -
4	V In-	Input -
5	GND	Chassis ground
6	Ignition	+0 V to 60 V to start terminal



# USB Dongle Cable

Use the USB dongle cable to connect USB devices, such as a USB flash drive to the smart dock and CV41.

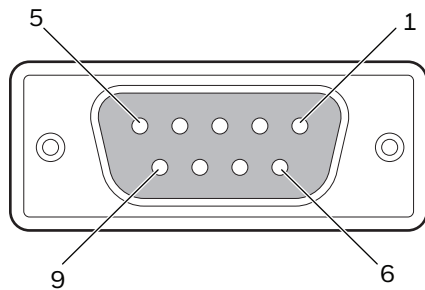
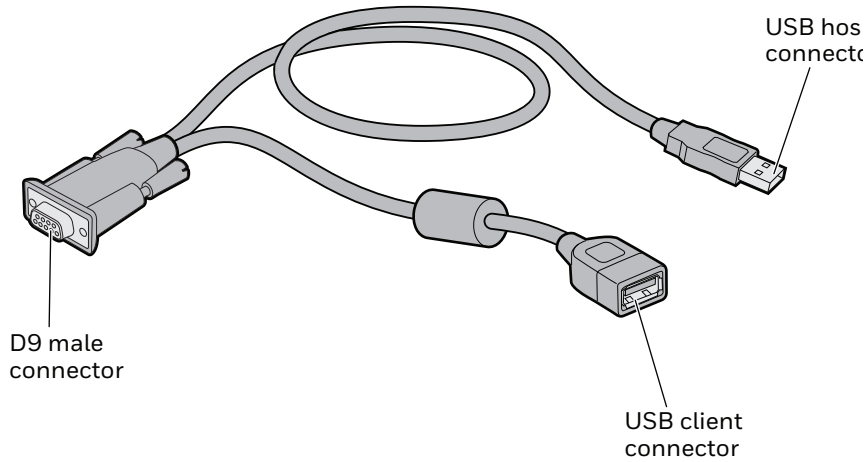

Pin	Signal	Description
1	GND	Common ground
2	USBC_D+	USB client data signal
3	USBC_D-	USB client data signal
4	USB_H1_PWR	USB host 5 V output power
5	GND	Common ground
6	GND	Common ground
7	USB_H1_D+	USB host 1 data signal
8	USB_H1_D-	USB host 1 data signal
9	USBC_VBUS	USB client 5 V detect from attached host

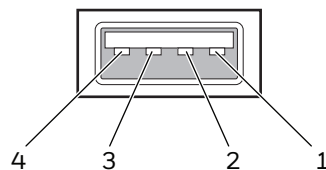

Pin	Signal	Description
1	5V_USB	USB power, current limited
2	USB2N_A	USB D-

Pin	Signal	Description
3	EUSB2PA_A	USB D+
4	DGND	USB power return
Shell	CGND	Chassis ground

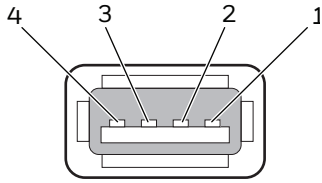

Pin	Signal	Description
1	V In+	12 to 48 V nominal DC input +
2	V In+	12 to 48 V nominal DC input +
3	V In-	Input -
4	V In-	Input -

APPENDIX

# B

## KEYPADS AND KEYSTROKES

# Standard Characters

Use the following tables to learn how to enter standard and other available characters and functions with the keypad. If there is no sequence of keystrokes for a particular character or function, it is only available through the soft input panel (SIP), which you can access by tapping the keyboard icon on the touch screen.





To Enter	Keypad
a	A
b	B
c	C
d	D
e	E
f	F
g	G
h	H
i	I
j	J
k	K
l	L
m	M
n	N
o	O
p	P
q	Q
r	R
s	S
t	T
u	U
v	V
w	W
x	X
y	Y
z	Z

To Enter	Keypad
F1	ı
F2	¢
F3	£
F4	
F5	¥
F6	ı
F7	§

To Enter	Keypad
F8	¨
F9	©
F10	ª
F11	¸ j
F12	¸ ¢
F13	¸ £
F14	¸
F15	¸ ¥
F16	¸ †
F17	¸ §
F18	¸ ¨
F19	¸ ©
F20	¸ ª
F21	Alt <b>F1</b>
F22	Alt <b>F2</b>
F23	Alt <b>F3</b>
F24	Alt <b>F4</b>

To Enter	Keypad
* (asterisk)	¸ *
@ (at symbol)	¸ W
# (pound)	¸ #
& (ampersand)	¸ &
% (percentage)	¸ %
: (colon)	¸ D
; (semicolon)	¸ F
, (comma)	¸ J
\$ (dollar)	¸ R
! (exclamation)	¸ Q
? (question mark)	¸ L
- (hyphen or minus)	¸ 5
. (period)	. or ¸ K
+ (plus)	¸ 8
' (apostrophe)	¸ H
= (equals)	¸ 2
_ (underscore)	¸ M
^ (caret)	¸ u
> (greater than)	¸ V
< (less than)	¸ C

To Enter	Keypad
( (left parenthesis)	b O
) (right parenthesis)	b P
[ (left square bracket)	b B
] (right square bracket)	b N
{ (left curly brace)	b Z
} (right curly brace)	b X
~ (tilde)	b s
\ (backslash)	b S
/ (forward slash)	b A
" (quotes)	b G
Insert	b 4
Delete	b 6
(broken vertical bar)	b {
` (grave)	b
Forward Tab	j
Backspace	{
Up Arrow	u
Down Arrow	d
Left Arrow	l
Right Arrow	r
CapsLock	b ]
Enter	e
ok	Alt 
Shift	] ]
Space	s
Start (Windows)	? or b ?
Esc	
Alt	<b>Alt</b>
Ctrl	<b>Ctrl</b>
Intermec Dashboard	?

To Enter	Keypad
Attention	Alt 
Autolog	Alt 
Clear	Alt 6
Duplicate	Alt 
EEOF	Alt 
Erase	Alt 

To Enter	Keypad
Find	Alt <b>F</b>
Field +	b 1
Field -	Alt <b>2</b>
Fieldmark	Alt <b>G</b>
Help	b 3
Hex	Alt <b>I</b>
Home	Alt <b>H</b>
Keypad	Alt <b>K</b>
Menu	Alt <b>M</b>
Mode	Alt <b>O</b>
New Line	Alt <b>N</b>
Next Screen	b 9
PA1	Alt <b>T</b>
PA2	Alt <b>Y</b>
PA3	Alt <b>U</b>
Page	Alt <b>^</b>
Print	Alt <b>P</b>
Previous Screen	b 7
Remove	Alt <b>R</b>
Reset	Alt <b>Esc</b>
Return	Alt <b>Enter</b>
Roll Down	Alt <b>5</b>
Roll Up	Alt <b>8</b>
Select	Alt <b>Z</b>
System Request	Alt <b>Q</b>
View Down	b d
View Up	b u





# C

## SCANNINGO WI-FI CONFIGURATION BAR CODES

You can use the ScanNGo Wi-Fi configuration bar codes to quickly configure the 802.11 radio in your computer.

# Radio Configuration Bar Codes

Use the following ScanNGo bar codes to enable the 802.11 radio and set the defaults for either Funk security or Microsoft security. After you scan the bar codes, you will still need to use Intermec Settings or another configuration program to set network-specific settings on your computer and to configure the wireless security.

**Note:** *If you are using Microsoft security, you can only use the 1D configuration bar codes.*

The following ScanNGo bar codes were created using SmartSystems Foundation. For more information on SmartSystems Foundation, see [Manage the Computer Using SmartSystems Foundation](#).

## 2D Configuration Bar Codes

You can configure the computer with a 2D imager.

1. Scan the appropriate bar code from the table and wait for the program to start.
2. Follow any instructions on the device.

### ***2D Imager Radio Configuration Bar Codes***

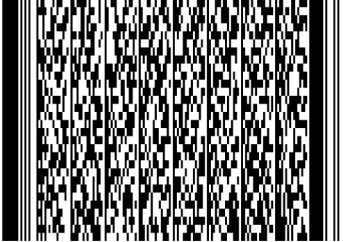
<b>When You Want To:</b>	<b>Scan This Bar Code</b>
<ul style="list-style-type: none"><li>• Set all communication settings to defaults (Wi-Fi, WWAN if applicable)</li><li>• Enable Wi-Fi - set Funk security to defaults</li></ul>	

# 1D Configuration Bar Codes





You can configure the computer with a 1D imager.

1. Scan the **START HERE** bar code from the table and wait for the program to start.
2. Scan the 1/9 bar code.
3. Scan the rest of the bar codes in any order.
4. Follow any instructions on the device.

## 1D Imager Radio Configuration Bar Codes

When You Want To:	Scan This Bar Code
<ul style="list-style-type: none"><li>• Set all communication settings to defaults (Wi-Fi, WWAN if applicable)</li><li>• Enable Wi-Fi - set Funk security to defaults</li></ul>	 START HERE
	 1/9
	 2/9
	 3/9
	 4/9
 5/9	





### 1D Imager Radio Configuration Bar Codes (Continued)

When You Want To:	Scan This Bar Code
<ul style="list-style-type: none"><li>• Set all communication settings to defaults (Wi-Fi, WWAN if applicable)</li><li>• Enable Wi-Fi - set Funk security to defaults</li></ul>	 6/9
	 7/9
	 8/9
	 9/9

### 1D Imager Radio Configuration Bar Codes (Continued)

When You Want To:	Scan This Bar Code
<ul style="list-style-type: none"><li>• Set all communication settings to defaults (Wi-Fi, WWAN if applicable)</li><li>• Enable Wi-Fi - set Microsoft security to defaults</li></ul>	 START HERE
	 1/9
	 2/9
	 3/9
	 4/9
 5/9	

**1D Imager Radio Configuration Bar Codes (Continued)**

<b>When You Want To:</b>	<b>Scan This Bar Code</b>
<ul style="list-style-type: none"><li>• Set all communication settings to defaults (Wi-Fi, WWAN if applicable)</li><li>• Enable Wi-Fi - set Microsoft security defaults</li></ul>	 6/9
	 7/9
	 8/9
	 9/9





## CV41 DOCKS

This chapter details the different docks available for the CV41:

- [Standard Dock](#)
- [Enhanced Dock for Off-Vehicle Use](#)

# Standard Dock



**Caution: This dock is designed for DC power vehicle-mounted applications only.**

Power Connection	Direct or DC/DC power supply
Serial Ports	COM1 and COM2
USB Ports	USB port provides host and client connections via an adapter cable. This port also supports Honeywell external keyboards.
Ethernet	N/A
CANbus	CANbus connection via an adapter cable
Audio	Headset connection via an adapter cable
Screen Blanking	Supported via COM1 and COM2 connectors.
Ignition Control	Supported

## Components

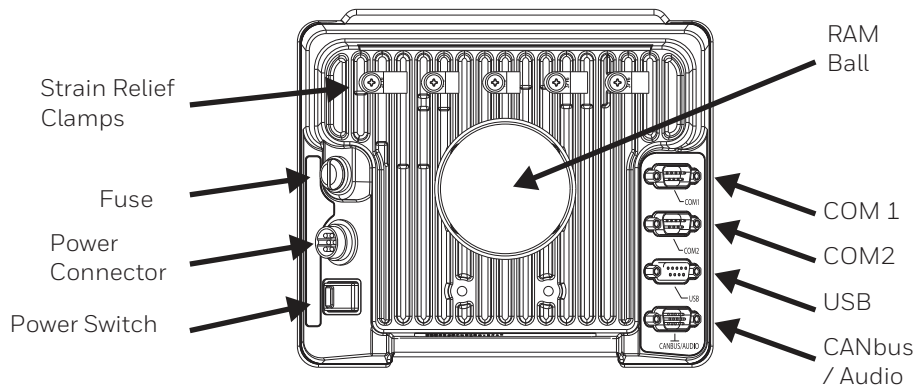

# Enhanced Dock for Off-Vehicle Use



**Caution: This dock is designed for AC power (non vehicle-mounted) applications only.**

Power Connection	AC/DC Adapter
Serial Ports	COM1 and COM2
USB Ports	USB1 port provides host and client via an adapter cable. This port also supports Honeywell external keyboards. USB2 port provides two USB host ports via an adapter cable. Direct USB host connection on top of dock.
Ethernet	RJ-45 Ethernet connection on top of dock (not supported).
CANbus	CANbus connection via an adapter cable
Audio	Headset connection via an adapter cable
Screen Blanking	Supported via COM1 and COM2 connectors.
Ignition Control	Supported

## Components - Back

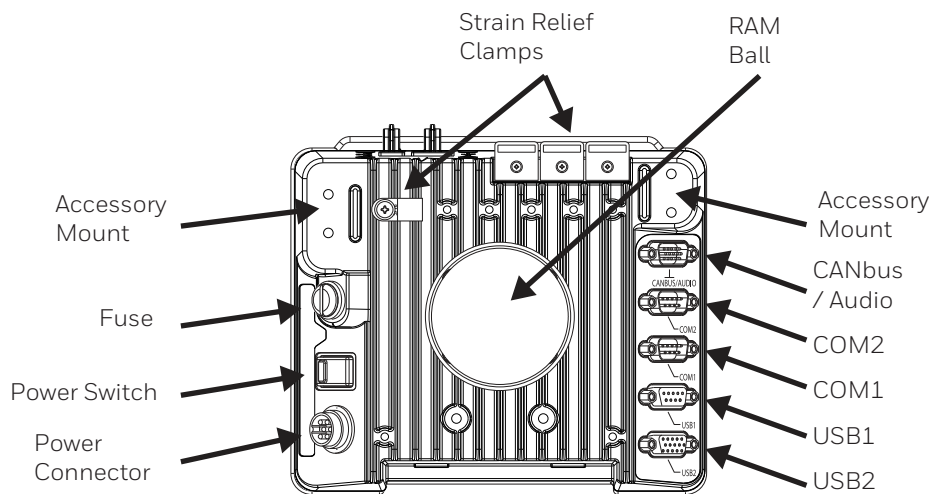

## Components - Top

Only the Enhanced Dock has these connectors on the top. The connectors are located behind water tight plugs.

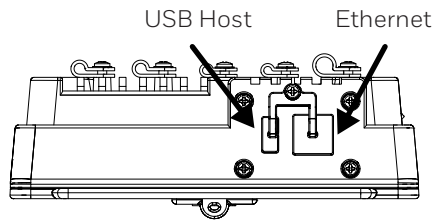

*Note: The Ethernet port is not supported on the CV41.*



Honeywell  
9680 Old Bailes Road  
Fort Mill, SC 29707

[www.honeywellaidc.com](http://www.honeywellaidc.com)

## Free Manuals Download Website

<http://myh66.com>

<http://usermanuals.us>

<http://www.somanuals.com>

<http://www.4manuals.cc>

<http://www.manual-lib.com>

<http://www.404manual.com>

<http://www.luxmanual.com>

<http://aubethermostatmanual.com>

Golf course search by state

<http://golfingnear.com>

Email search by domain

<http://emailbydomain.com>

Auto manuals search

<http://auto.somanuals.com>

TV manuals search

<http://tv.somanuals.com>