

HCC474M ULTRA MINIATURE 1/3" COLOR CAMERA





CAUTION

**RISK OF ELECTRIC SHOCK
DO NOT OPEN**



CAUTION: TO REDUCE THE RISK OF ELECTRIC SHOCK, DO NOT REMOVE COVER (OR BACK). NO USER-SERVICEABLE PARTS INSIDE. REFER SERVICING TO QUALIFIED SERVICE PERSONNEL.



The lightning flash with arrowhead symbol, within an equilateral triangle, is intended to alert the user to the presence of uninsulated "dangerous voltage" within the product's enclosure that may be of sufficient magnitude to constitute a risk of electric shock to persons.



The exclamation point within an equilateral triangle is intended to alert the user to the presence of important operating and maintenance (servicing) instruction in the literature accompanying the product.

WARNING:
TO PREVENT THE RISK OF FIRE OR ELECTRIC SHOCK HAZARD, DO NOT EXPOSE THIS CAMERA TO RAIN OR MOISTURE.



We hereby declare that all major safety requirements concerning Low Voltage Directive [(73/23/EEC and amendment 93/68/EEC)] and Electromagnetic Compatibility Directives [(89/336/EEC, 92/31/EEC) and (93/68/EEC)] are fulfilled as laid out in the guideline set down by the member states of the EEC Commission.

Information for USA: This device complies with Part 15 of the FCC rules. Changes or modifications not approved by Honeywell could void the user's authority to operate the equipment.

Due to design modification, data given in the user manual are subject to possible change without prior notice.

Thank you for purchasing the Honeywell Miniature color CCD camera. Before using this camera please read the manual carefully to obtain the best results and keep the manual for future reference.

TABLE OF CONTENTS

PRECAUTIONS	4
FEATURES	6
CONTROLS AND CONNECTIONS	8
Camera Side.....	8
Camera Back	10
MENU OPERATION	12
Menu Description	13
MAIN MENU	14
Lens	15
AGC	16
Electronic Shutter Control	17
White Balance Control	19
Back Light Compensation	21
Text Display	23
Special Menu	26
LENS INSTALLATION AND ADJUSTMENT	31
Mounting a Lens.....	33
Backfocus Adjustment	34
SPECIFICATIONS	36
SUPPLIED ACCESSORIES	39

PRECAUTIONS

Operating

- Before using, check power supply and video output connection.
- Power supplied without voltage stabilization or the voltage maintained at $24V\pm 10VAC$ or $12V\pm 10VDC$ may cause damage.
- If any abnormal condition or malfunction is observed while operating the camera, stop using it immediately and call your local dealer.

Handling

- Do not disassemble the camera and never touch parts inside the camera.
- To avoid possible damage, do not drop the camera or subject it to shocks or vibrations.
- When attaching or removing the lens, handle with care so that moisture and dust do not enter the camera.
- Do not shoot any source of bright light. If the object contains very bright areas, bright vertical or horizontal lines may appear on the screen. This is called “smear,” a phenomenon which often occurs with solid-state pickups and is not a malfunction.

Cleaning

- Turn the power off and wipe off the dirt with a dry soft cloth. If the camera is extremely dirty, use furniture cleaning tissue.
- Do not use alcohols, petroleum distillates, liquid cleaners or sprays.

PRECAUTIONS, CONTINUED

Installation and storage

- Do not point the camera at the sun. This could damage the camera whether it is operating or not.
- Do not install the camera where the temperature could exceed the allowable range.
- Ambient temperature should be less than 40°C for long-term continuous operation.
- Avoid installing in humid or dusty places.
- Avoid installing in places where there is radiation. This could damage the CCD and other components and cause malfunction.
- Avoid installing in places where there are strong magnetic fields or electrical signals.
- Avoid installing in places where the camera would be subject to strong vibrations.
- Never expose the camera to rain or water.

Daily Check

- Make daily checks for proper operation for surveillance use. In order to maintain normal operation, the output of the camera should be checked daily to ensure a clear and focused picture.

Field Installation

- This installation should be made by a qualified service person and should conform to all local codes.

FEATURES

High Sensitivity

- 1/3" 410,000 pixels CCD with on-chip micro lenses and low noise signal processing circuit provide high sensitivity down to 0.4 lux (F1.2, 50IRE, Contrast ON).

High Quality Image

- High resolution, high sensitivity design for a horizontal resolution of 470 TV lines (NTSC)/460 TV lines (PAL).
- High quality image is obtained by digital signal processing with optimization of control program and image correction algorithm.

Backlight Compensation

- When strong light enters the scene background, such as from a spotlight or window, back light compensation function automatically adjust the video level to preserve visibility in important sections of the image.

FEATURES, CONTINUED

White Balance

- Three control modes of auto-tracking preset and manual white balance can be selected according to conditions.

Iris Function

- Provides a drive output for video iris lens.
- Built-in electronic shutter allows 11 shutter speeds up to 1/100,000 sec.
- CCD iris function automatically sets the brightness of the picture by changing the shutter speed of the camera according to the incident light when using a manual iris lens.

Other versatile functions

- Variable AGC function of up to 32dB.
- Text display function of up to 24 characters.
- Internal / Line -lock synchronizations are provided.
- Special menu functions for gamma, color adjustment, contrast, sharpness, preset.
- 24VAC or 12VDC power source.
- Uses either C- or CS-mount lens.

CONTROLS AND CONNECTIONS

Camera Side

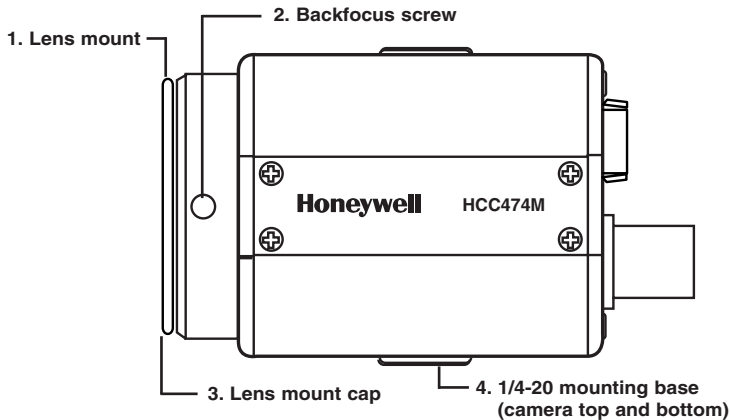

CONTROLS AND CONNECTIONS, CONTINUED

Camera Side, continued

1. Lens mount

Used when installing the lens. A C-mount lens can be used when C-mount adapter is attached. CS-mount lens can be used when adapter is removed.

2. Backfocus screw

A screw is provided to fix the lens mount.

3. Lens mount cap

Cap the lens mount when the lens is not mounted.

4. 1/4-20 mounting base

Mounting base for installing the camera, located on top and bottom of camera.

CONTROLS AND CONNECTIONS, CONTINUED

Camera Back

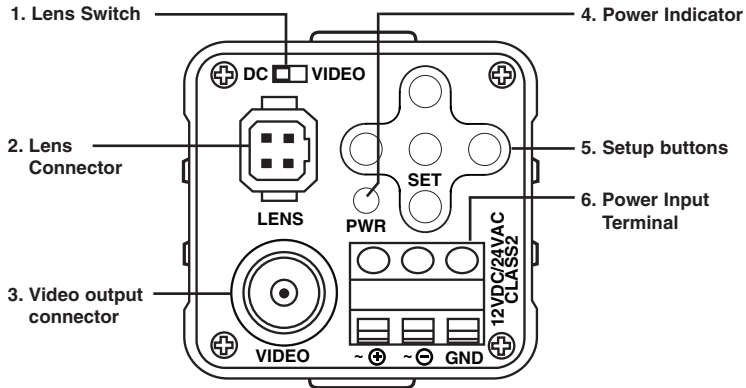

CONTROLS AND CONNECTIONS, CONTINUED

Camera Back, continued

1. Lens switch

Used to switch between DC and Video lenses.

2. Lens connector

When using an auto-iris lens, connect the lens cable to this connector.

3. Video output connector

BNC connector that outputs a composite video signal.

4. Power indicator

Indicator lights when the camera is powered.

5. Setup buttons

Used when setting up and adjusting the camera with the on-screen menu.

6. Power input terminal

Use only 24VAC or 12VDC UL listed class 2 signal.

Power Connection

The power connection will accept power from either a 12 volt DC source or a 24 volt AC source.

The 12 volt DC connection is polarity sensitive.

If connected incorrectly, the camera will not work.

The left terminal is for the positive connection and the center terminal is the negative connection.

When using a 24 volt AC source, the first and second terminals are used. Polarity selection is not required.

The third, or right, terminal is for a ground connection.

This terminal is seldom used in typical installations.

It may be required when the camera is installed in an oxygen-rich environment or other explosive environments. These environments may be found in medical or industrial applications. Check local codes if this issue is in question.

MENU OPERATION

- The menu system can activate all of the features and options of the camera.
- The menus are superimposed on the image displayed on the screen. The commands can open other menus, toggle options, or change variable parameters.
- The camera settings and adjustments can be changed to accommodate usage conditions.
- When connected to a monitor, convenient on-screen menus facilitate checking and changing the settings and adjustments.
- A brief help line is often presented on the screen below the list of commands.
- The complete set of current parameters is saved and will be loaded each time the camera is turned on until the next change in setup.

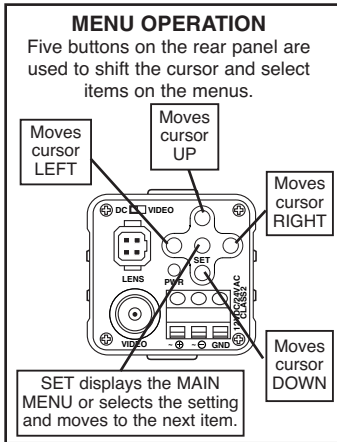

Menu Description

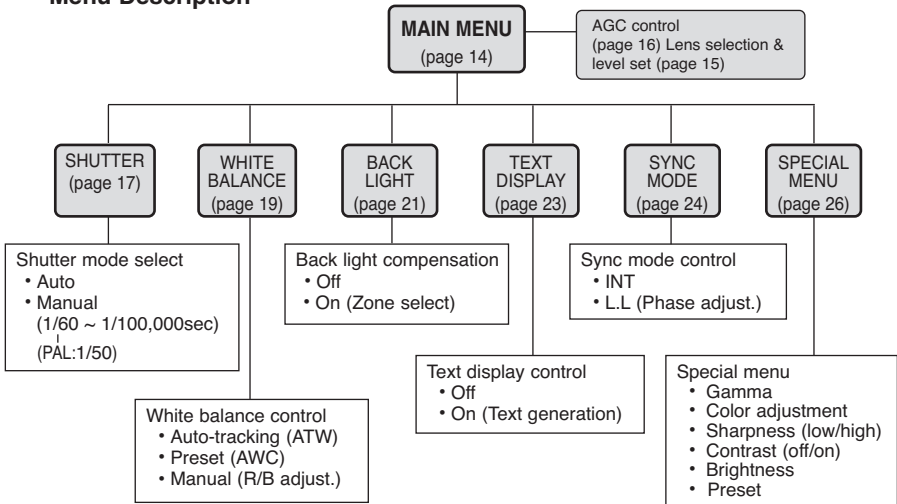

MAIN MENU

MAIN MENU

1. Press the SET button to display the MAIN MENU on the monitor screen.
2. Check the present settings at the MAIN MENU.
3. If no changes are needed, move the cursor to the End position and press the SET button to return the normal video screen.
4. When a setting is changed, the new setting is stored in the internal memory when the cursor is at End and SET is pressed. When power is turned off then on again, operation continues at the most recent settings.

MAIN MENU	
→ Lens	: DC
AGC	: 32dB
Shutter	: AUTO
White Balance	: ATW
Back Light	: OFF
Text Display	: OFF
Sync Mode	: INT
Special Menu	
End	

Note: In absence of button operation, the menu display is extinguished automatically in about 60 seconds.

MAIN MENU, CONTINUED

Lens

1. Press the SET button to display the MAIN MENU.
2. Position the cursor at LENS and press the left or right button for setting the lens mode.
3. Displayed lens mode will be changed by setting lens switch on the rear panel of camera.
4. Press the SET button only when the lens mode is DC to setting the video level of DC type lens.

MAIN MENU	
→ Lens	: DC
AGC	: 32dB
Shutter	: AUTO
White Balance	: ATW
Back Light	: OFF
Text Display	: OFF
Sync Mode	: INT
Special Menu	
End	



5. Press the left or right button to adjust the video level.
After setting, press SET to return to the MAIN MENU.

MAIN MENU, CONTINUED

AGC

1. Press the SET button to display the MAIN MENU.
2. Position the cursor at AGC and press the left or right button to setting the AGC max level.
3. AGC max level has 8 stages from OFF to 32dB.

Right button (ascending sequence);

OFF → 6dB → 12dB → 16dB → 20dB → 24dB → 28dB → 32dB

Left button (descending sequence);

32dB → 28dB → 24dB → 20dB → 16dB → 12dB → 6dB → OFF

MAIN MENU

Lens	: DC
→ AGC	: 32dB
Shutter	: AUTO
White Balance	: ATW
Back Light	: OFF
Text Display	: OFF
Sync Mode	: INT
Special Menu	
End	

At the AGC level setting, camera's sensitivity is automatically increased to a setting level when the level of ambient light drops.

In the general application, AGC max level is set to 32dB.

MAIN MENU, CONTINUED

Electronic Shutter Control

1. Press SET to display the MAIN MENU.
2. Position the cursor at Shutter, and press the left or right button to set the manual shutter.

MAIN MENU	
Lens	: DC
AGC	: 32dB
→ Shutter	: AUTO
White Balance	: ATW
Back Light	: OFF
Text Display	: OFF
Sync Mode	: INT
Special Menu	
End	

AUTO Mode

When using the manual iris, the brightness of the picture image will be fixed by setting the auto mode, so the shutter speed is automatically varied according to the incident light.

Note: Outdoor illumination levels may exceed 150,000 lux, which is outside the range that can be controlled by the electronic shutter. For proper operation of electronic shutter, if illumination levels exceed 10,000 lux, use an auto-iris lens.

MAIN MENU, CONTINUED

MANUAL Mode

1. Press SET to set the manual shutter speed when the cursor is at Shutter and shutter mode is manual.
2. Press the left or right direction button to select a shutter speed from 1/60 to 1/100,000 sec.

MANUAL SHUTTER
→ Shutter Speed : 1/60
Press SET to Main Menu

Right button (ascending sequence):

1/60→(1/50 PAL)→1/100→1/120→1/250→1/500
1/1000→1/2000→1/4000→1/10000→1/30000
1/50000→1/100000→1/60 (1/50 PAL)

Left button (descending sequence):

1/100000→1/50000→1/30000→1/10000
1/4000→1/2000→1/1000→1/500→1/250
1/120→1/100→1/60 (1/50 PAL)→1/100000

3. After selecting a shutter speed, press SET to return to the MAIN MENU.

MAIN MENU, CONTINUED

White Balance Control

1. Press SET to display the MAIN MENU on the monitor screen.
2. Position the cursor at WHITE BALANCE and press the left or right button to toggle through the white balance control mode. Three white balance control modes can be selected according to conditions: ATW, AWC, and Manual.

ATW (Auto-Tracking White Balance)

The white balance mode is set to auto-tracking white balance (ATW). This mode accepts different types of lighting using an automatic tracking system and automatically controls in the color temperature range of 2400K to 10000K.

Note : The ATW mode may not function properly under the following conditions:

- When shooting with non-standard lighting or lighting with a color temperature that exceeds the range of the camera.
 - When a large part of the scene is occupied with a single color or a completely red or blue background.
- In these situations, set White Balance to the MANUAL mode.

MAIN MENU	
Lens	: DC
AGC	: 32dB
Shutter	: AUTO
→ White Balance	: ATW
Back Light	: OFF
Text Display	: OFF
Sync Mode	: INT
Special Menu	
End	

MAIN MENU, CONTINUED

AWC (PRESET WHITE BALANCE)

With a white object present in the scene, press SET then position the cursor at White Balance and set to AWC.

Setting the preset white balance takes several seconds and the selection is complete when the message "**White Balance Completed**" displays on the screen. If the selection is not completed in approximately 5 seconds, press the SET button again.

Note : To avoid failure of the AWC mode setting, do not move the camera or object until the "white balance completed" message appears.

MANUAL (Manual white balance)

1. Press SET to set Manual White Balance when the cursor is positioned at White Balance and the mode is MANUAL.
2. Press the left, right, up, or down direction buttons to control the Red/Blue gain.
3. After setting, press SET to return to the MAIN MENU.

MANUAL WHITE BALANCE

Red 00 

Blue 00 

Press SET to Main Menu

Gain level is from 0 to 20.

MAIN MENU, CONTINUED

Back Light Compensation

Strong light, such as from a spotlight or window, entering the scene background causes the lens iris to close, possibly obscuring desired portions of the scene. The back light compensation function automatically adjusts the video level to preserve visibility in important sections of the scene.

1. Press SET to display the MAIN MENU.
2. Position the cursor at BACK LIGHT and press the left or right button to toggle between the ON and OFF settings.
3. Press SET to select the setting.

MAIN MENU	
Lens	: DC
AGC	: 32dB
Shutter	: AUTO
White Balance	: ATW
→ Back Light	: OFF
Text Display	: OFF
Sync Mode	: INT
Special Menu	
End	

MAIN MENU, CONTINUED

BLC Zone Setting

Backlight control uses 6 sensing zones.

The BLC Zone setting is activated on the screen with either the left or right button to allow the most suitable area to be selected while observing the monitor. Position the cursor at Back Light and press SET to select the BLC zones.

Decide on BLC zone numbers for desired portions of the scene.

Zone 1 Off	Zone 2 Off	
Zone 5 Off	Zone 6 ON	Zone 5 Off
Zone 3 Off	Zone 4 Off	

1. Press SET to display the BLC zone set.
2. Press the up or down direction buttons to move the cursor to desired BLC zone.
3. Press the left or right direction buttons to set the sensing zone in which you want to preserve visibility in important sections of the scene.
4. After setting, press SET to return to the MAIN MENU.

BLC ZONE SET	
→ Zone Display	
Zone 1	:OFF
Zone 2	:OFF
Zone 3	:OFF
Zone 4	:OFF
Zone 5	:OFF
Zone 6	:ON
Press SET to View Zone	

BLC ZONE SET	
Zone Display	
→ Zone 1	:ON
Zone 2	:OFF
Zone 3	:OFF
Zone 4	:OFF
Zone 5	:OFF
Zone 6	:ON
Press SET to Main Menu	

MAIN MENU, CONTINUED

Text Display

1. Press SET to display the MAIN MENU.
2. Move the cursor to TEXT DISPLAY and use the left and right buttons to toggle between the ON and OFF settings.

Text Generation

A maximum of 24 alphanumeric characters (1 line) can be displayed on the screen.

1. To generate text, press SET when the cursor is on TEXT DISPLAY and the text display mode is ON.
2. Use the left, right, up, and down direction buttons to move to each character. Press SET to select each character.
3. Move the cursor to POS and press SET to select text location.

MAIN MENU	
Lens	: DC
AGC	: 32dB
Shutter	: AUTO
White Balance	: ATW
Back Light	: OFF
→ Text Display	: OFF
Sync Mode	: INT
Special Menu	
End	

TEXT GENERATION	
█	ABCDEFGHIJKLMNOPS
	TUVWXYZ abcdefghijkl
	mno pqrstuvwxy z 12345
	6 7 8 9 0 . , ' : + - ~ / * # () < >
	BLK ← → CLR POS END
█	

MAIN MENU, CONTINUED

Text Location

1. Text location is set by selecting POS from the TEXT GENERATION menu and pressing SET.
2. Use the left, right, up, and down buttons to move text location.
3. After selecting text location, press SET to return to the MAIN MENU.

Camera 1

← → ↓ ↑ to Locate, then SET

Sync Mode

1. Press the SET button to display the MAIN MENU on the monitor screen
2. Position the cursor at SYNC MODE and press the left or right button for L.L (line-lock) mode.
3. Press the left or right button again, sync mode is return to INT (internal).

MAIN MENU

Lens	: DC
AGC	: 32dB
Shutter	: AUTO
White Balance	: ATW
Back Light	: OFF
Text Display	: OFF
→ Sync Mode	: L.L
Special Menu	
End	

MAIN MENU, CONTINUED

LINE LOCK PHASE ADJUSTMENT

1. Press SET to adjust line-lock phase when the cursor is at SYNC MODE and the mode is set to L.L.
2. Press the left or right direction button to adjust line-lock phase. Phase adjustment range is from 0 to 270°. After setting, press SET to return to the MAIN MENU.

LINE LOCK PHASE

→ Phase 135 degree



Press SET to Main Menu.



Note : In the line-lock setting, the camera's vertical synchronization can be driven by the 60Hz AC (50Hz PAL) signal in the power lines.

- In the line-lock mode, synchronization may not be corrected for a few seconds after the power is turned on; this is not a malfunction.
- If horizontal lines rolling upward or downward are observed on the screen, reverse the polarity of the power cable connected to the power input connector.
- When AC power line frequency is of 50Hz (60Hz PAL), the line-lock sync operation is not possible.

MAIN MENU, CONTINUED

Special Menu

The Special Menu is used to change the video output settings to match particular applications.

1. Press SET to display the MAIN MENU.
2. Move the cursor to SPECIAL MENU and press SET.
3. The Special Menu will display.

MAIN MENU	
Lens	: DC
AGC	: 32dB
Shutter	: AUTO
White Balance	: ATW
Back Light	: OFF
Text Display	: OFF
Sync Mode	: L.L
→ Special Menu	
End	

SPECIAL MENU	
→ Gamma	
Color Adj.	
Sharpness	: LOW
Contrast	: OFF
Brightness	
Preset	
End	

MAIN MENU, CONTINUED

GAMMA

1. Position the cursor at GAMMA and press SET.
2. Use the left, right, up, and down buttons to set the Gamma level. Gamma level can be set to a maximum of 32 steps, according to conditions. Default Gamma value is 0.45.
3. Once setting is selected, press SET to return to SPECIAL MENU.

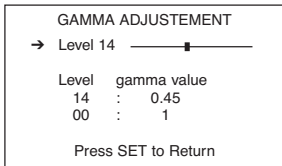

Color Adjustment

1. Position the cursor at COLOR ADJ and press SET.
2. Use the left and right buttons to adjust levels. Use the up and down buttons to move between Phase and Level controls.
3. Once values are selected, press SET to return to SPECIAL MENU.

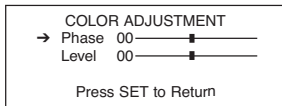

MAIN MENU, CONTINUED

Sharpness

1. Position the cursor at SHARPNESS and use the right and left buttons to toggle between HIGH and LOW.
2. Move the cursor up or down and press SET to select the setting.

SPECIAL MENU	
Gamma	
Color Adj	
→ Sharpness	: LOW
Contrast	: OFF
Brightness	
Preset	
End	

Contrast

When strong illumination such as a spotlight or outdoor light is present in the background, the scene will darken. When using the contrast compensation function, the dark areas are enhanced and the image brightened.

1. Position the cursor at CONTRAST and use the right and left buttons to toggle between ON and OFF.
2. Move the cursor up or down and press SET to select the setting.

SPECIAL MENU	
Gamma	
Color Adj	
Sharpness	: LOW
→ Contrast	: OFF
Brightness	
Preset	
End	

MAIN MENU, CONTINUED

Brightness

1. Position the cursor at BRIGHTNESS and press SET.
2. Use the left and right buttons to adjust levels.
3. Once values are selected, press SET to return to the SPECIAL MENU.

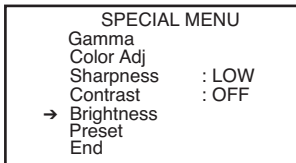
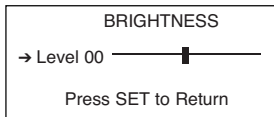

MAIN MENU, CONTINUED

Preset

The Preset function is useful when the camera setup conditions are frequently changed. Preset provides the best image under normal conditions as set by the factory.

1. Position the cursor at Preset and press SET.
The message "Press SET to Factory Set" will be displayed.
2. Pressing SET will perform the preset function.
Once reset, "Factory Setup Completed" will display on the screen for 5 seconds.

SPECIAL MENU	
Gamma	
Color Adj	
Sharpness	: LOW
Contrast	: OFF
Brightness	
→ Preset	
End	

End

To exit the SPECIAL MENU, use the up or down buttons to move the cursor to End and press SET.

LENS INSTALLATION AND ADJUSTMENT

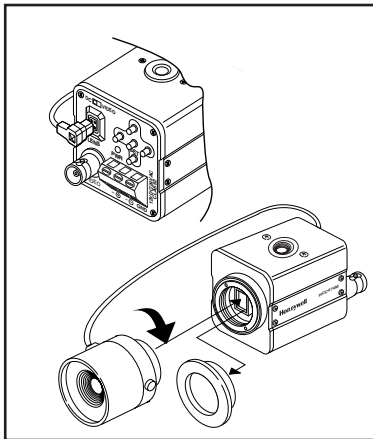

When using an auto-iris lens, install the accessory lens plug on to the lens cable as follows:
Video type lens: Set lens switch to VIDEO.
Connect the lens cable of a video type lens.
If the plug on the cable is of a different type, replace it with the provided 4-pin iris plug.

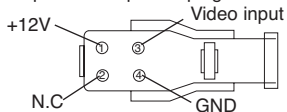

Pin Assignment : Video type (4-pin)

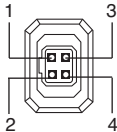

Pin No.	Signal
1	+12V DC (50mA max.)
2	N.C (Not connected)
3	Video (0.7Vp-p, high impedance, no sync)
4	GND

LENS INSTALLATION AND ADJUSTMENT, CONTINUED

DC type lens: Set lens switch to DC.

Connect the lens cable of a DC (galvanometric) type lens. If the plug on the cable is of a different type, replace it with the provided 4-pin iris plug.

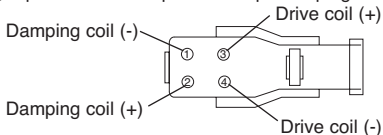

Pin Assignment : DC type (4-pin)

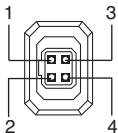

Pin No.	Signal
1	Damping coil (-)
2	Damping coil (+)
3	Drive coil (+)
4	Drive coil (-)

After installing the connector plug, connect it to the lens connector on the rear panel of camera.

LENS INSTALLATION AND ADJUSTMENT, CONTINUED

Mounting a Lens

1. Remove the lens mount cap from the camera.
2. Attach or remove the C-mount adapter depending on the lens to be used.
3. Attach the lens to the lens mount. Secure it so that it does not become loose.
4. If the lens has an auto-iris mechanism, connect the lens cable to the lens connector.

NOTE: When removing the C-mount adapter:

- If the adapter is attached so tightly that it is difficult to remove, use long-nosed pliers to remove it. Insert the tips of the pliers into the holes with no threads and turn to remove.
- A screwdriver can also be used to remove a firmly attached adapter. Insert M3 screws into the holes so that the screwdriver has something to grip.

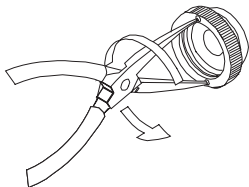

LENS INSTALLATION AND ADJUSTMENT

ADJUSTING AUTO-IRIS LENSES

Connect the camera to a power source and monitor, then adjust the auto-iris lens.

1. Set AGC mode to OFF.
2. When using a video-type lens, adjust the level on the lens to produce minimum smear and optimum pictures.
3. Set AGC mode to 32dB. It is recommended that the AGC be used in the 32dB mode after adjusting the video level.

Backfocus Adjustment

When a lens is mounted, adjustment of the backfocus may be required. Adjust with the lens focus ring when the correct focus cannot be obtained. (Refer to the table on the next page.) An ND filter may be used to open the iris of the auto iris lens when adjusting the backfocus.

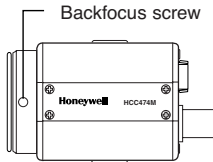

LENS INSTALLATION AND ADJUSTMENT

Backfocus Adjustment With A Fixed-Focus Lens	Backfocus Adjustment With A Zoom Lens
<ol style="list-style-type: none">1. Fully open the aperture and set the focus ring to ∞ (infinity). If using an auto-iris lens, shoot a comparatively dark object so that the aperture is fully open.2. Loosen the two backfocus screws with a hex wrench and turn the lens mount to focus.3. After adjusting the backfocus, tighten the backfocus screw.	<ol style="list-style-type: none">1. Fully open the aperture and set the lens to the maximum telephoto position, then turn the focus ring to focus. If using an auto-iris lens, shoot a comparatively dark object so that the aperture is fully open.2. Set the lens to its maximum wide-angle position.3. Loosen the two backfocus screws with a hex wrench and turn the lens mount to focus. After adjusting the backfocus, tighten the backfocus screws.3. Repeat steps 1 through 3 until the difference between focusing position "Tele" and "Wide" becomes smallest.



CAUTION : Forcibly turning the backfocus screw will damage the camera.

SPECIFICATIONS

ITEMS	SPECIFICATIONS
Signal format	NTSC
CCD Pickup element	Interline transfer 1/3" CCD
Effective pixels	NTSC: 768(H) x 494(V)
Scanning area	6.0(H) x 4.96(V) mm
Scanning system	2:1 interlace
Scanning frequency	NTSC: Horizontal: 15.743kHz / Vertical: 59.94Hz
Video output	Composite video signal: 1Vp-p, 75Ohm, unbalanced
Video S/N ratio	50dB (AGC OFF)
Horizontal resolution	NTSC: 470 TV lines
AGC range	OFF / 6dB / 12dB / 16dB / 20dB / 24dB / 28dB / 32dB
Minimum Illumination	0.45 lux (F1.2, 50IRE, AGC ON, Contrast ON)

SPECIFICATIONS, CONTINUED

ITEMS	SPECIFICATIONS
Auto electronic shutter	ON/OFF selectable (1/60~1/100,000 second) (NTSC:1/60~1/100,000 second PAL:1/50~1/100,000 second)
Shutter speed range	1/60 (1/50 PAL), 1/100, 1/120, 1/250, 1/500, 1/1000, 1/2000, 1/4000, 1/10000, 1/30000, 1/50000, 1/100000 second
White balance	Selectable auto-tracking (ATW), preset (AWC), and MANUAL
Backlight compensation	ON/OFF selectable (6 sensing zones)
Text display	ON/OFF selectable (24 alphanumeric characters)
Special menu	Gamma, Color Adj., Sharpness, Contrast, Brightness and Preset
GAMMA	Variable
Flickerless	ON/OFF selectable
Lens mount	C/CS Mount
Camera mount	1/4"-20 UNC (Top/Bottom)
Power source	24VAC 60 Hz or 12VDC

SPECIFICATIONS, CONTINUED

ITEMS	SPECIFICATIONS
Power consumption	Max 3 watts
Operating temperature	14°F to 122°F (-10°C to +50°C)
Operating humidity	less than 85% relative humidity
Storage temperature	-4°F to 140°F (-20°C to +60°C)
Dimensions	1.6W x 1.6H x 2.8D inches (41W x 41H x 73D mm)
Weight	0.35 lbs (160g)

Notes:

- If used continuously, operate at less than 40°C (140°F) for long-term stable performance.
- Design and specifications are subject to change without notice.
- This CCD camera is designed to output video signals conforming to the NTSC (**PAL**) standard, so it cannot be used with video recorders or color monitors which use color systems other than NTSC (PAL).

SUPPLIED ACCESSORIES

Lens mount cap	1
C-mount adapter	1
L-wrench	1
User manual	1

For Customer Use :

please record the Model No. and Serial No. in the spaces provided below. These numbers are located on the bottom of the camera.

Keep this manual for future reference.

Model No.

Serial No.

Honeywell

Video Systems

www.honeywellvideo.com

1-800-796-CCTV

© 2004 Honeywell International Inc.

All rights reserved. No part of this publication may be reproduced by any means without written permission from Honeywell Video Systems. The information in this publication is believed to be accurate in all respects. However, Honeywell Video Systems cannot assume responsibility for any consequences resulting from the use thereof. The information contained herein is subject to change without notice. Revisions or new editions to this publication may be issued to incorporate such changes.

Free Manuals Download Website

<http://myh66.com>

<http://usermanuals.us>

<http://www.somanuals.com>

<http://www.4manuals.cc>

<http://www.manual-lib.com>

<http://www.404manual.com>

<http://www.luxmanual.com>

<http://aubethermostatmanual.com>

Golf course search by state

<http://golfingnear.com>

Email search by domain

<http://emailbydomain.com>

Auto manuals search

<http://auto.somanuals.com>

TV manuals search

<http://tv.somanuals.com>