

HVE1/HVE4/HVE8 Audio/Video Encoder

Audio/Video Encoder





HVE1	HVE1X
HVE4	HVE4X
HVE8	HVE8X

Getting Started Guide

Revisions

Issue	Date	Revisions
A	08/2013	New document
V1 Rev A	10/2013	Removed Preliminary status. Adjusted alignment and layout. Minor text changes throughout.
V2 Rev A	10/2013	Replaced the photo of the HVE8(X) back panel. Corrected the callouts in Fig 3. Removed references to the microSD card and PoE for HVE8(X). Replaced "SADP (IP finder) software" with "IP Utility".

Cautions and Warnings

 	CAUTION RISK OF ELECTRIC SHOCK DO NOT OPEN		THIS SYMBOL INDICATES THAT DANGEROUS VOLTAGE CONSTITUTING A RISK OF ELECTRIC SHOCK IS PRESENT WITHIN THE UNIT.
CAUTION: TO REDUCE THE RISK OF ELECTRIC SHOCK, DO NOT REMOVE THE COVER. NO USER-SERVICEABLE PARTS INSIDE. REFER SERVICING TO QUALIFIED SERVICE PERSONNEL.			THIS SYMBOL INDICATES THAT IMPORTANT OPERATING AND MAINTENANCE INSTRUCTIONS ACCOMPANY THIS UNIT.

Installation and servicing should be performed only by qualified and experienced technicians to conform to all local codes and to maintain your warranty.

CAUTION 12 V DC models require the use of CSA Certified/UL Listed Class 2 power adapters to ensure compliance with electrical safety standards.

Regulatory Statements

FCC Compliance Statement

Information to the User: This equipment has been tested and found to comply with the limits for a Class A digital device, pursuant to part 15 of the FCC Rules. These limits are designed to provide reasonable protection against harmful interference when the equipment is operated in a commercial environment. This equipment generates, uses, and can radiate radio frequency energy and, if not installed and used in accordance with the instruction manual, may cause harmful interference to radio communications. Operation of this equipment in a residential area is likely to cause harmful interference in which case the user will be required to correct the interference at his own expense.

Note Changes or modifications not expressly approved by the party responsible for compliance could void the user's authority to operate the equipment.

Canadian Compliance Statement

This Class A digital apparatus complies with Canadian ICES-003.
Cet appareil numérique de la Classe A est conforme à la norme NMB-003 du Canada.

Manufacturer's Declaration of Conformance

North America

The equipment supplied with this guide conforms to UL 60950-1 and CSA C22.2 No. 60950-1.

Europe

The manufacturer declares that the equipment supplied is compliant with the essential requirements of the EMC directive 2004/108/EC, conforming to the requirements of standards EN 55022 for emissions, EN 50130-4 for immunity, and EN 60950 for electrical equipment safety.

Waste Electrical and Electronic Equipment (WEEE)

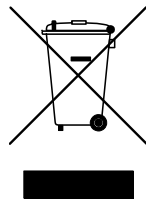

Correct Disposal of this Product (applicable in the European Union and other European countries with separate collection systems).

This product should be disposed of, at the end of its useful life, as per applicable local laws, regulations, and procedures.

Important Safeguards

BEFORE OPERATING OR INSTALLING THE UNIT, READ AND FOLLOW ALL INSTRUCTIONS. AFTER INSTALLATION, retain the safety and operating instructions for future reference

1. **HEED WARNINGS** - Adhere to all warnings on the unit and in the operating instructions.
2. **INSTALLATION**
 - Install in accordance with the manufacturer's instructions.
 - Installation and servicing should be performed only by qualified and experienced technicians to conform to all local codes and to maintain your warranty.
 - Do not install the unit in an extremely hot or humid location, or in a place subject to dust or mechanical vibration. The unit is not designed to be waterproof. Exposure to rain or water may damage the unit.
 - Any wall or ceiling mounting of the product should follow the manufacturer's instructions and use a mounting kit approved or recommended by the manufacturer.
3. **POWER SOURCES** - This product should be operated only from the type of power source indicated on the marking label. If you are not sure of the type of power supplied to your facility, consult your product dealer or local power company.
4. **HEAT** - Situate away from items that produce heat or are heat sources such as radiators, heat registers, stoves, or other products (including amplifiers).

5. **WATER AND MOISTURE** - Do not use this unit near water or in an unprotected outdoor installation, or any area classified as a wet location.
6. **MOUNTING SYSTEM** - Use only with a mounting system recommended by the manufacturer, or sold with the product.
7. **ATTACHMENTS** - Do not use attachments not recommended by the product manufacturer as they may result in the risk of fire, electric shock, or injury to persons.
8. **ACCESSORIES** - Only use accessories specified by the manufacturer.
9. **CLEANING** - Do not use liquid cleaners or aerosol cleaners. Use a damp cloth for cleaning.
10. **SERVICING** - Do not attempt to service this unit yourself as opening or removing covers may expose you to dangerous voltage or other hazards. Refer all servicing to qualified service personnel.
11. **REPLACEMENT PARTS** - When replacement parts are required, be sure the service technician has used replacement parts specified by the manufacturer or have the same characteristics as the original part. Unauthorized substitutions may result in fire, electric shock or other hazards.

Installation

The HVE1(X)/HVE4(X)/HVE8(X) encoders are highly advanced surveillance equipment that should be installed with care. Please ensure that you install a manufacturer-recommended HDD (HVE8(X) models only). See [Table 1-1](#) for a list of recommended HDDs.

During encoder installation:

- Use brackets for racking mounting.
- Ensure that there is ample room for audio and video cables.
- When installing the cables, ensure that the bend radius of the cables is no less than five times its diameter.
- Connect both the alarm and the RS-485 cable.
- Allow at least 2cm (~0.75 inch) of space between rack-mounted devices.
- Ensure that the encoder is grounded.
- Ensure that the environmental temperature is within -10°C–55°C (14°F–131°F).
- Ensure that the environmental humidity is within 10%–90%.

Installing the Hard Disk Drive (HDD)

This section applies only to HVE8(X) models that have room for a Hard Disk Drive (HDD) for recording.

Preparing for Installation

This encoder comes from the factory without a HDD. Follow these instructions to install a HDD that is appropriate for your situation according to the total capacity calculated in terms of the Schedule Recording Settings. The installation and removal of the hard disk should be done by qualified professionals.

Before installing a HDD for HVE(X), please ensure the power is disconnected from the device. Only a factory-recommended HDD should be used for this installation.

Table 1 **Tested Compatible HDDs**

SEAGATE	
Capacity	HDD Model
3T	ST3000VX000-9YW1
	ST2000VX000-9YW1
2T	ST2000VX002-1AH1
	ST2000VM003-1CT1
	ST1000VM002-9ZL1
1T	ST31000322CS
	ST1000VX000-9YW1
	ST31000526SV
	ST3500410SV
500G	ST3500411SV
	ST3250312CS
250G	ST3250310SV
	ST3250820SV
	WD
Capacity	HDD Model
2T	WD20EURS-63S
1T	WDC WD10EVDS-63U

Required Tools: Screwdriver

Installing the HDD

1. Use the screwdriver to unfasten the screws on both sides and the rear panel of the encoder, then remove the cover from the chassis and set aside.

Figure 1 Removing the Cover



2. Place the HDD into the slot on the chassis, and then secure it in position by tightening the screws at the bottom of the chassis.

Figure 2 Installing and Securing the HDD

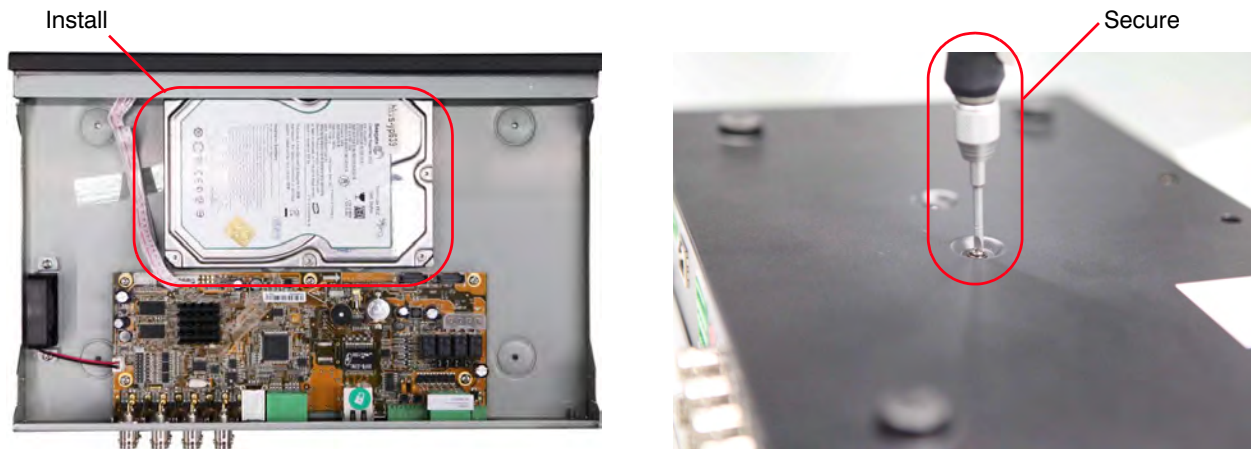

3. Remove the HDD data line from the accessories box. Plug one end of the data line to the circuit board, and the other end to the data line port on the HDD. Connect the power cord to the HDD in the same way.

Figure 3 Connecting the Data Line and the Power Cord

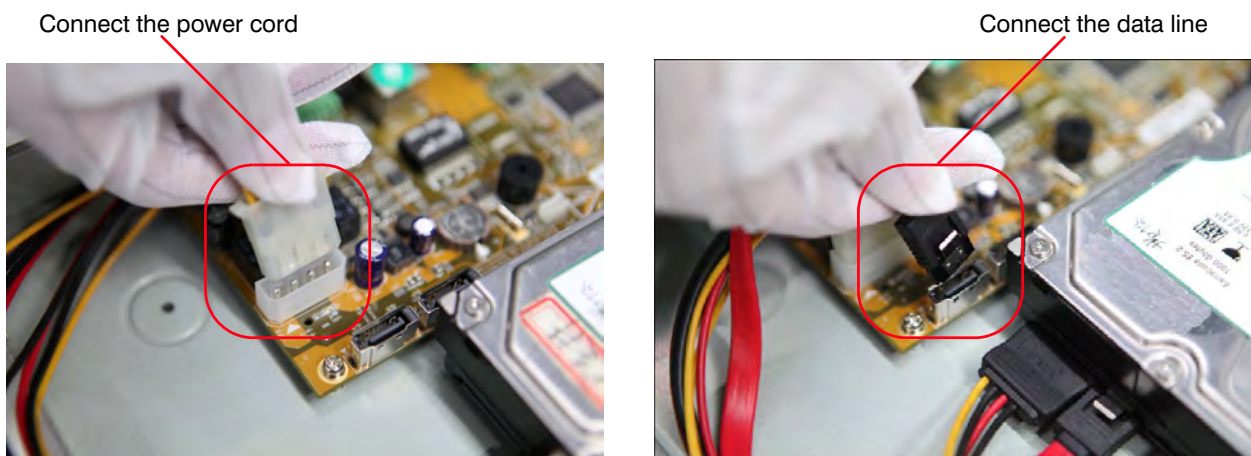

4. Replace the chassis cover, and then tighten the screws on both sides and the rear panel of the encoder.

About the Encoder

HVE1(X)

Front Panel

Figure 4 HVE1 Front Panel

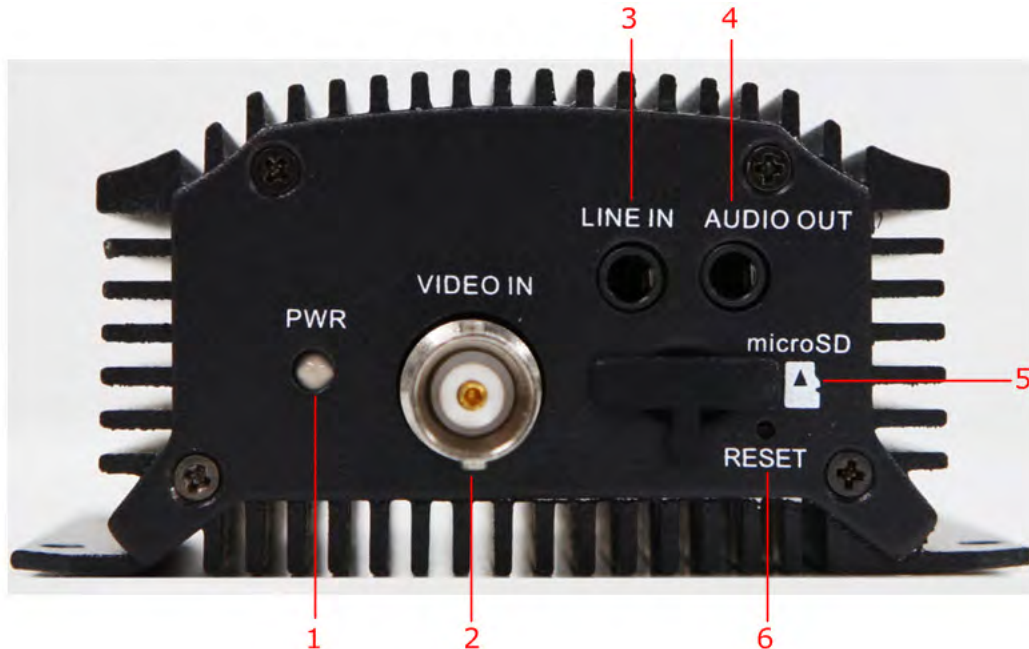

Table 2 HVE1 Front Panel

Interface Element	Function
1	PWR LED Indicator Lights red when the device is powered on. Lights orange when an SD card is inserted.
2	VIDEO IN BNC connector for video input.
3	LINE IN 3.5mm connector for two-way audio input. Connect to an audio input device or an active pick-up, a microphone, etc.
4	AUDIO OUT 3.5mm connector for audio output. Connect an audio output device, such as a loudspeaker.
5	microSD microSD interface for data storage, up to 32GB, Class 6 and above.
6	RESET Restore to the factory default settings by holding the RESET button for more than 15 seconds after the power is turned on.

Rear Panel

Figure 5 HVE1 Rear Panel

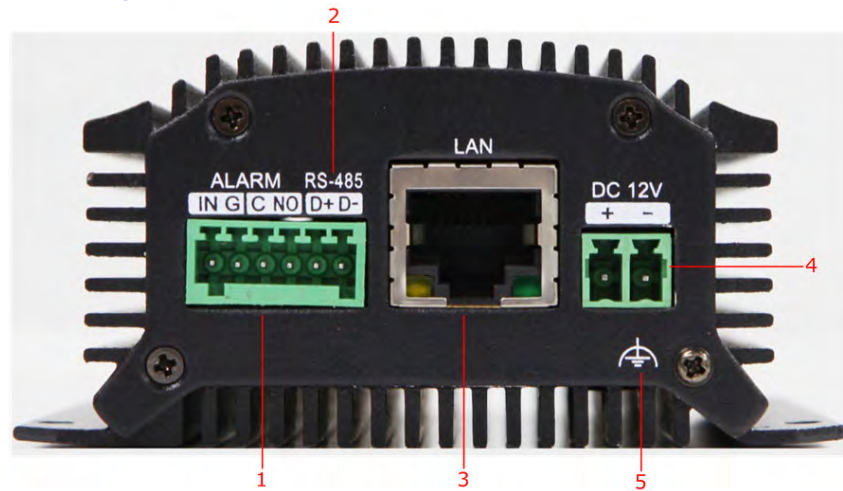

Table 3 HVE1 Rear Panel

	Interface Element	Function
1	ALARM IN/OUT	Relay alarm input/output. The maximum voltage/current supported by the relay output is 12 V / 1 A. Note The alarm output terminal provides no JP2 pin.
2	RS-485	RS-485 connection for pan, tilt, zoom control.
3	LAN	10M/100Mbps adaptive Ethernet interface (PoE). The right LED indicator lights green when the network cable is connected. The left LED indicator blinks orange when data is transmitting/receiving.
4	DC 12V	12 V DC power supply
5	GND	Ground

Note The HVE1 model encoder does not support/supply a beeper/audio alert.

HVE4(X)

Front Panel

Figure 6 HVE4 Front Panel

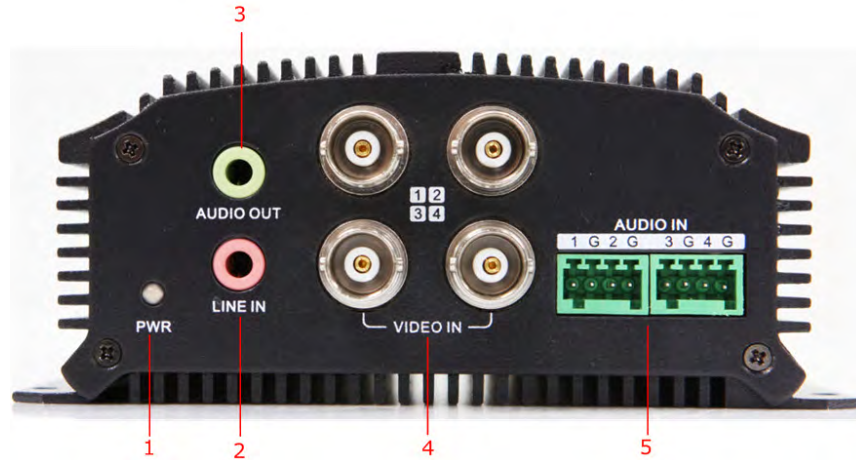

Table 4 HVE1 Front Panel

	Interface Element	Function
1	PWR LED Indicator	Lights red when the device is powered on. Lights orange when the SD card is inserted.
2	LINE IN	3.5mm connector for a two-way audio input. Connect to an audio input device or an active pick-up, a microphone, etc.
3	AUDIO OUT	3.5mm connector for audio output. Connect an audio output device, such as a loudspeaker.
4	VIDEO IN	BNC connectors for video input.
5	AUDIO IN	Input for audio.

Rear Panel

Figure 7 HVE4 Rear Panel

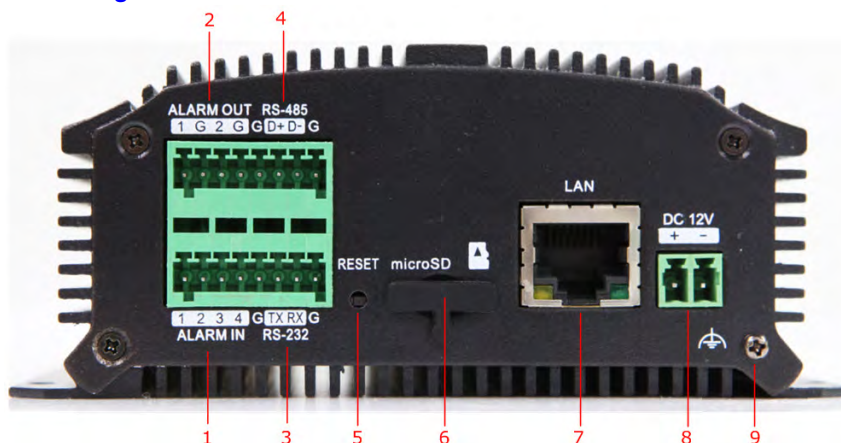

Table 5 HVE1 Rear Panel

Interface Element	Function	
1	ALARM IN	Relay alarm input.
2	ALARM OUT	Relay alarm output. The maximum voltage/current supported by the relay output is 12 V / 1 A.
3	RS-232	Serial interface for configuring the encoder's parameters, or for using as a transparent channel.
4	RS-485	RS-485 connection for pan, tilt, zoom control.
5	RESET	Restore to the factory default settings by holding the RESET button for more than 15 seconds after the power is turned on.
6	microSD	microSD interface for data storage, up to 32GB, Class 6 and above.
7	LAN	10M/100Mbps adaptive Ethernet interface (PoE). The right LED indicator lights green when the network cable is connected. The left LED indicator blinks orange when data is transmitting/receiving.
8	DC12V	12 V DC power supply
9	GND	Ground

Note The HVE4 model encoder does not support/supply a beeper/audio alert.

HVE8(X)

Front Panel

Figure 8 HVE8 Front Panel



Table 6 HVE1 Front Panel

Interface Element	Function
1	POWER Lights red when the device is powered on.
2	STATUS Lights red when data is being read from or written to the HDD.
3	Tx/Rx Does not light when the encoder is not connected to the network. Blinks green when data is being transmitted or received. Blinks at a higher frequency when the data that is being transmitted or received is large.

Rear Panel

Figure 9 HVE8 Rear Panel



Table 7 HVE1 Rear Panel

Interface Element	Function
1	VIDEO IN BNC connectors for video input.
2	LINE IN 3.5mm connector for two-way audio input. Connect to an audio input device or an active pick-up, a microphone, etc.
3	AUDIO OUT 3.5mm connector for audio output. Connect an audio output device, such as a loudspeaker.
4	AUDIO IN Input for audio.

Table 7 HVE1 Rear Panel

	Interface Element	Function
5	LAN	10/100/1000 Mbps adaptive Ethernet interface. The right LED indicator lights green when the network cable is connected. The left LED indicator blinks orange when data is transmitting/receiving.
6	RESET	Restore to the factory default settings by holding the RESET button for more than 15 seconds after the power is turned on.
7	RS-232, RS-485	Serial interface for configuring the encoder's parameters, or for using as a transparent channel. RS-485 connection for pan, tilt, zoom control.
8	ALARM IN	Relay alarm input.
9	ALARM OUT	Relay alarm output.
10	DC12V	12 V DC power supply
11	GND	Ground

Installing the IP Utility

Note Before installing the Honeywell IP Utility, ensure that your encoder is connected to your network through a CAT5 Ethernet cable.

Note We recommend that you disable any Norton's AntiVirus software that might be running on your workstation.

To discover the IP device and configure the network settings, you must first install the IP Utility. For more information, see the user guide on the software CD that came with your encoder, or go to the Honeywell web site. You must have Windows administrator privileges for the workstation onto which the Honeywell IP Utility is being installed.

1. Insert the software CD. Autorun will start the installation. If autorun does not start, browse to the CD drive, and run **Honeywell IP Utility Setup.exe**.
2. Follow the steps in the InstallShield wizard.
3. Log on to the IP Utility by double-clicking the IP Utility icon () on the desktop. The main IP Utility page appears.

Figure 10 IP Utility



Configuring Network Parameters

If you do not know the IP address of the encoder, and this is not the first time you are using the encoder, then you can use IP Utility or the Serial port tools to find the encoder's IP address, and to configure the IP address or other network parameters. We recommend that you change the default IP address for the first use.

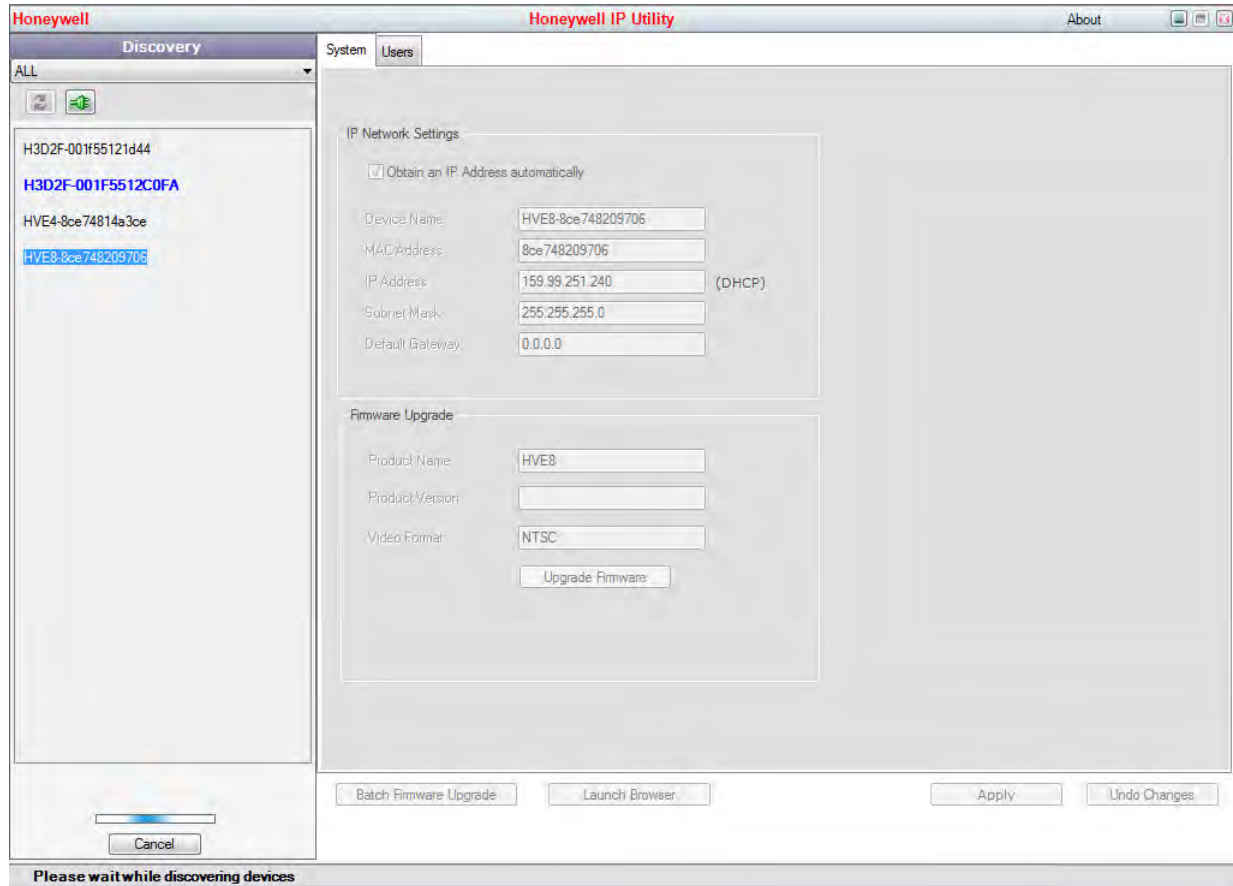
Note For the first-time user, the default user name is **admin**, and the default password is **1234**. The default IP address is **192.168.0.250**.

Searching for Online Devices

Automatically Searching for Online Devices

After you log on to the IP Utility, the devices on the network are automatically discovered and listed in the Discovery pane. After the initial discovery, auto-refresh continues to discover newly added network devices.

Figure 11 Found Devices

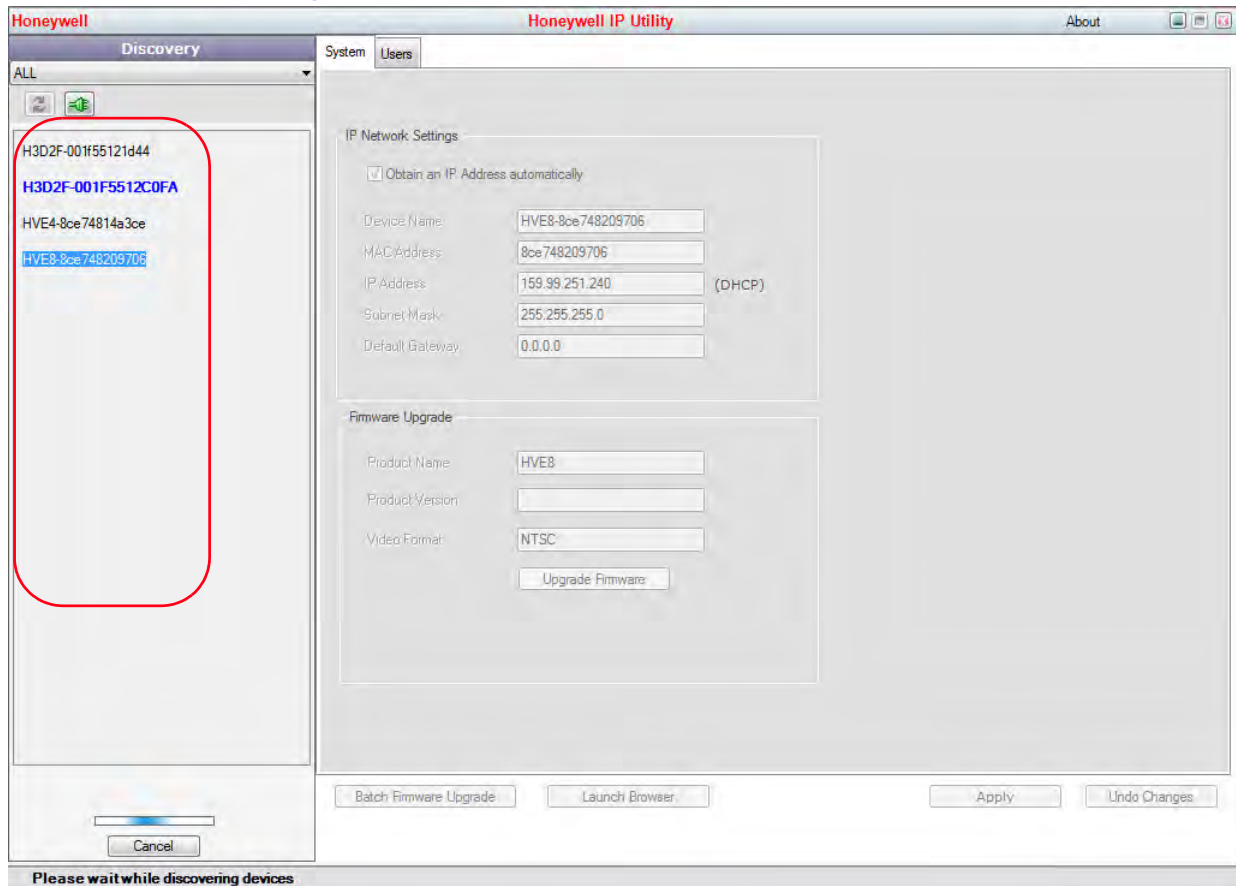

Note Found devices will appear automatically 15 seconds after they go online. They will disappear from the list 45 seconds after they go offline.

Manually Searching for Online Devices

Click the Refresh button  to manually refresh the Online Device list. The newly discovered devices will be added to the list.

Note You can click **Up** or **Down** buttons on each column heading to reorder the information. Click **>>** to expand the device table, and to hide the network parameter panel on the right side. Click **<<** to show the network parameter panel.

Modifying Network Parameters

1. Click to select a connected device from the device list the device. The network parameters for the selected device will appear in the **Modify Network Parameters** panel on the right side.
2. Configure the network settings.
 - **Automatically** – Click to select **Obtain an IP Address automatically**, enter the **Device Name**, then click **Apply**. The network settings are automatically assigned from the network server.
 - **Manually** – Click to deselect **Obtain an IP Address automatically**, then enter the Device Name, IP Address, Subnet Mask, and Gateway. Then click **Apply**.

Figure 12 Editing Network Parameters in the Modify Network Parameters Window

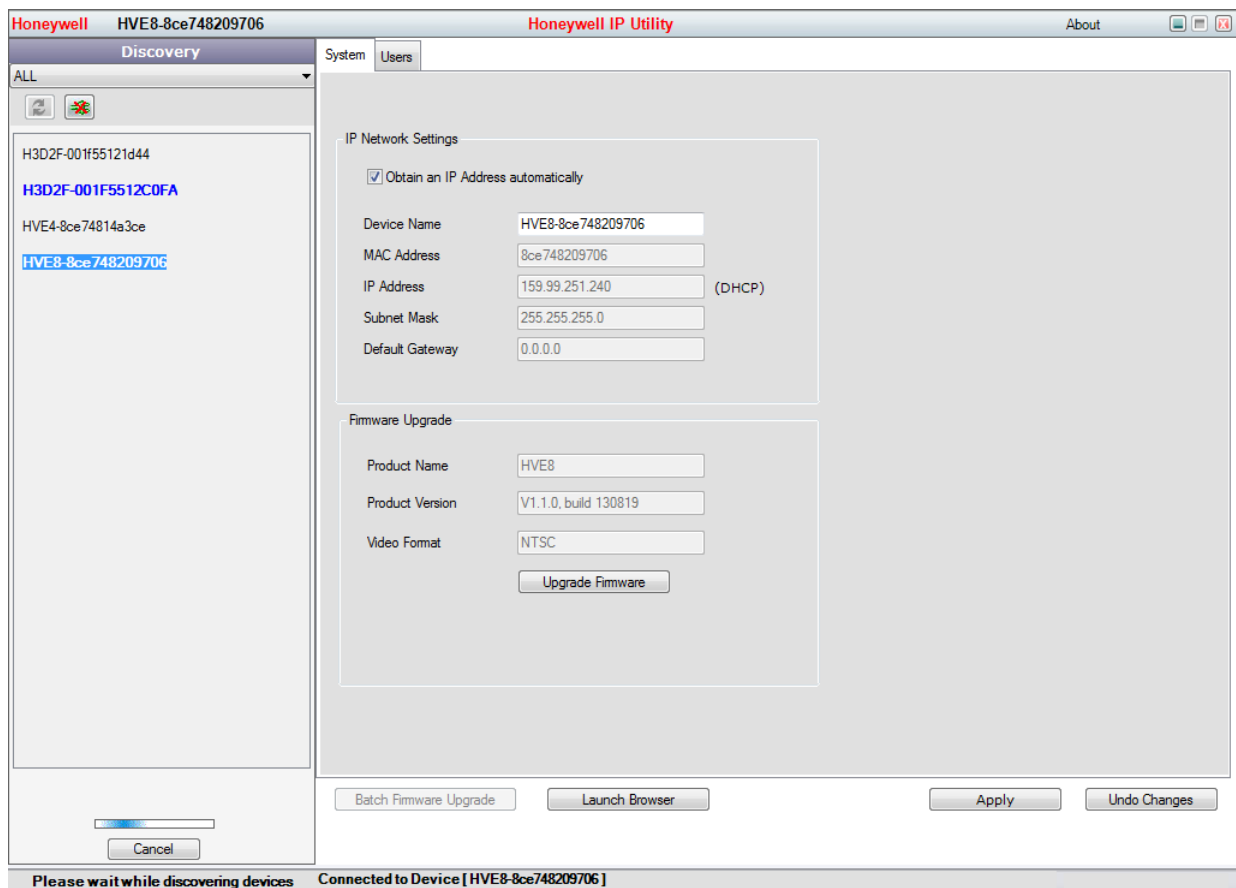

Note Check the IP network settings before clicking Apply. Incorrect values might cause a failure when connecting the tool to the device.

Note Contact your network administrator if you have any network-related issues or questions about your network.

Connecting to an Online IP Device

1. Connect to your IP device by double-clicking it in the **Discover** pane, or by selecting it and clicking . The name for the connected device turns bold and blue, and the **Launch Browser** button becomes active.
2. Click **Launch Browser**. The Honeywell IP Utility login window opens.

Figure 13 Honeywell IP Utility Window



Accessing an HVE Encoder Through a Web Browser

The HVE encoders can be accessed through a Web browser for configuration and operation.

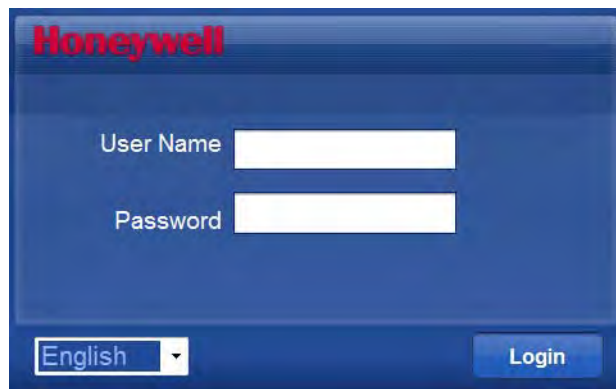
Table 8 Supported Web Browsers

Microsoft Internet Explorer 6, 7, 8, 9
Mozilla Firefox 3.5 and above

Table 8 Supported Web Browsers

Google Chrome 8 and above
Apple Safari 5.0.2 and above
Windows XP SP1 and above (32-bit)

1. Open the web browser.
2. Enter the encoder's IP address (default: 192.168.0.250), and then press **Enter** on your keyboard.
The login window appears.

Note When the HTTPS feature is enabled, the system uses the HTTPS login mode (https://192.168.0.250) by default when you enter the IP address. You can also enter **http://IP address/index.asp** (for example, http://192.168.0.250/index.asp) if you want to use the HTTP mode to log into the device.

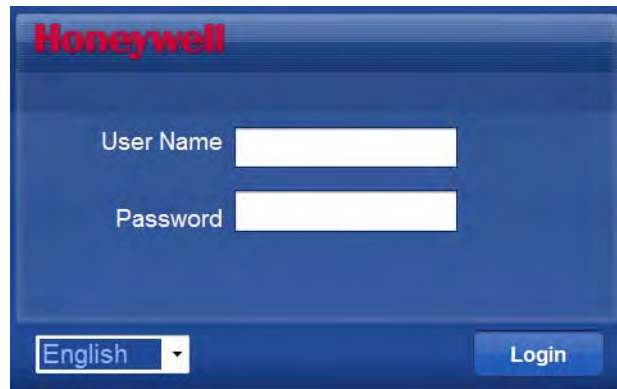
Figure 14 Login Window

3. Enter the user name (default: admin) and password (default: 1234) to log into the system.

Starting Live View

1. In the Live View window, click to select a playing window.
2. Double-click a camera from the device list to start Live View.

Figure 15 Live View Window











3. Click  to start Live View for all of the cameras in the device list.

Table 9 Controls on the Live View Window

Icon	Function
	Select the viewing window division.
	Start/stop live view.
	Capture pictures in the live view mode.
	Manually start/stop recording.
	Enable PTZ control (must be supported by the connected camera)
	Previous/next page.
	Audio on/off.
	Start/stop two-way audio.

Note Before using two-way audio or recording with audio, please configure the **Stream Type** to **Video & Audio** under **Remote Configuration > Camera Settings > Video Settings**.

Opening and Closing Full-Screen Mode

You can double-click on the live video to switch to the full-screen view mode. To switch back to the normal mode, double-click on the live video again.

Operating PTZ Control

Before you begin:

- Ensure the encoder is connected to a camera/dome which supports pan/tilt/zoom control. Connect the R+ and R- terminals on the PTZ unit or speed dome to the RS-485 T+ and RS-485 T- terminals on the encoder.
- Ensure that the baud rate, PTZ control, and address configured in the **RS-485 Settings** interface (**Remote Configuration > Serial Port Settings > 485 Serial Port**) are the same as the parameters of the connected pan/tilt unit or speed dome.

PTZ Control

In Live View mode, you can use the PTZ control buttons to control the pan/tilt/zoom of the camera lens.

There are 8 directional buttons (up, down, left, right, upper left, upper right, bottom left, bottom right) on the display window when the mouse is located in the relative positions. Click these directional buttons to control the PTZ movement.

Figure 16 PTZ Controls



Table 10 PTZ Controls

Button	Function
	Zoom in (+) and out (-).
	Focus near (+) and far (-).
	Iris open (+) and close (-).
	Click to turn On/Off a light (available the connected PTZ camera supports a light).
	Click to turn On/Off the wiper (available when the connected PTZ camera supports a wiper function).
	Slide the bar to set the PTZ speed from level 1 to 7.

Recording

Before you begin:

- Ensure the encoder is connected to a HDD or a network disk.
- Ensure the HDD or network disk has been initialized for the first-time use.

The following instructions apply to Scheduled recording.

Scheduled Recording

1. Click **Configuration > Remote Configuration > Camera Settings > Schedule Settings** to enter the Recording Schedule settings interface.
2. Select a camera for configuration.
3. Check to enable **Enable Record Schedule**.

Figure 17 Schedule Settings Window

Click to **Enable Record Schedule**

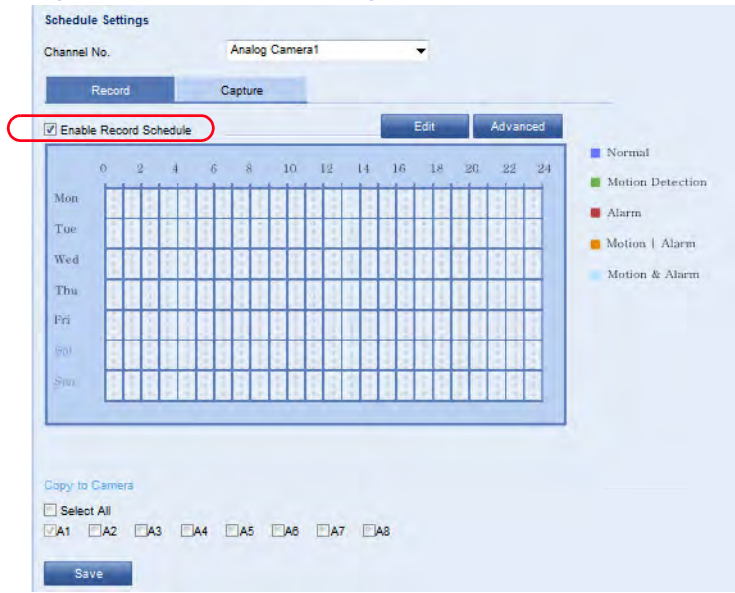

4. Click **Edit** to enter the **Edit Schedule** window.

Figure 18 Edit Schedule Window

Click to select **All Day** or **Customize**

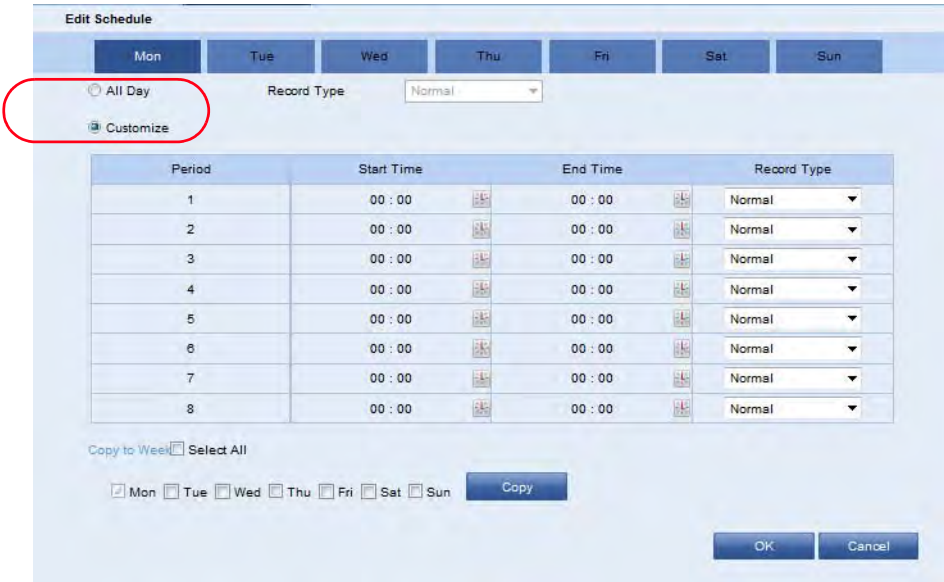

5. Select a day of the week for the schedule.
6. Click to select **All Day** or to **Customize** a time period.
The customized option allows you to set the start and end times for each recording period.

Note Time periods cannot overlap. You can configure up to 8 time periods.

7. Select a **Recording Type** from the drop-down menu. Select from Normal, Motion, Alarm, Alarm & Motion, and Motion Alarm.
 - To copy these recording configurations to the other days of the week, click **Select All**, and then click **Copy**.
 - To copy these recording configurations to select days of the week, click the selection checkbox for that day, and then click **Copy**.
8. On the Schedule Settings interface, click **Advanced** to configure advanced recording parameters.
9. Click **Save** to save the above settings.

Playback

Through a Web browser, you can remotely play back the recorded video.

1. Click the **Playback** tab to open the playback interface.

Figure 19 Playback Tab Interface

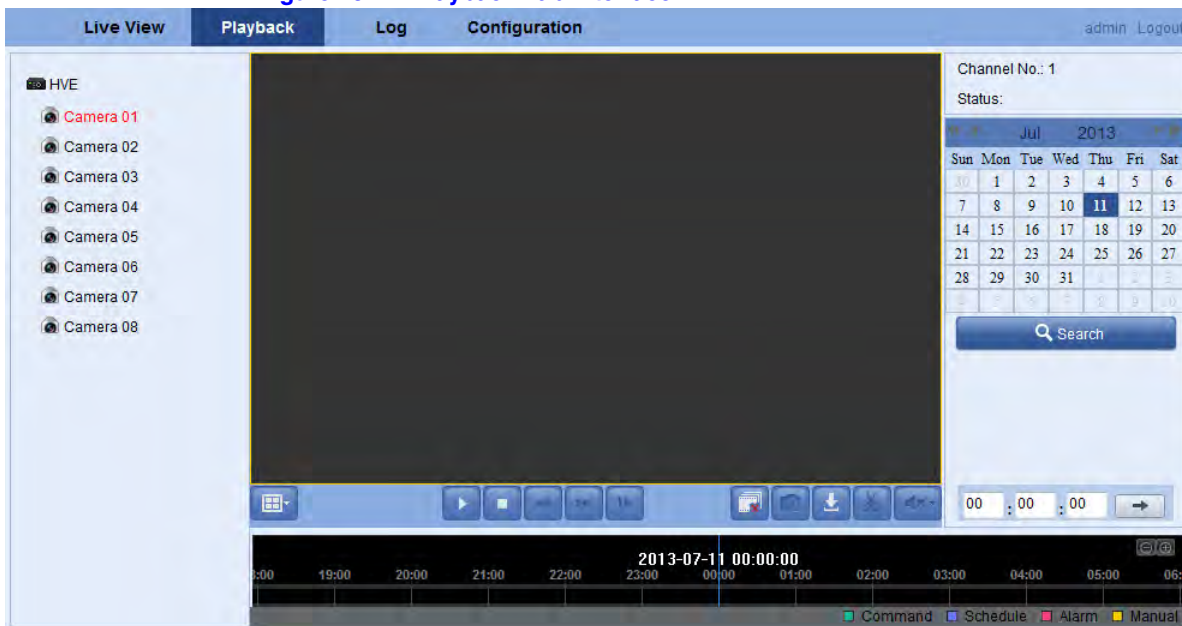

2. Click to select a camera from the device list for playback.
3. Select the date from the calendar, and then click **Search**.

Figure 20 Calendar



4. Click **Play** to play the recorded video.

Figure 21 Recorded Video Playing in the Playback Window



Use the buttons on the playback toolbars to control playback

Figure 22 Playback Toolbars



Table 11 Playback Controls

Button	Function	Button	Function
	Select the playback window division.		Play/pause.
	Stop playback.		Slow playback
	Fast forward.		Play single frames.
	Stop playing all channels.		Capture an image
	Download all video files.		Start/stop clipping video files.
	Audio on/off.		

5. Select a time for playback.
 - Click and drag the progress bar to locate the exact playback point.

Figure 23 Progress Bar



OR

- Enter the time in the time selector and click  to locate the playback point.

Figure 24 Time Selector



The color of the video on the progress bar indicates the type of video.

Figure 25 Playback Video Types

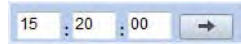
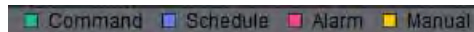

Log

The operation, alarm, exception, and device information can be stored in log files, which can be viewed and exported at any time.

Before you begin:

- Ensure that the connected encoder has a HDD or a network disk. The Log function works only with an encoder that has a HDD or a network disk.
 - Ensure the HDD or network disk has been initialized for first-time use.
1. Click the **Log** tab.
 2. Set the log search conditions to refine your search. Select the Major Type, Minor Type, Start Time, and End Time.
 3. Click **Search** to search the log files.

The log files that meet the search conditions display on the Log window.

Figure 26 Found Log Files

No.	Time	Major Type	Minor Type	Channel No.	Local/Remote User	Remote Host IP
1	2013-07-11 14:16:51	Operation	Power On			0.0.0.0
2	2013-07-11 14:16:51	Information	HDD Information			0.0.0.0
3	2013-07-11 14:16:51	Information	S.M.A.R.T. Information	1		0.0.0.0
4	2013-07-11 14:19:05	Operation	Remote: Get Parameters		admin	172.9.11.41
5	2013-07-11 14:19:05	Operation	Remote: Get Parameters		admin	172.9.11.41
6	2013-07-11 14:19:05	Operation	Remote: Get Parameters		admin	172.9.11.41
7	2013-07-11 14:19:05	Operation	Remote: Get Parameters		admin	172.9.11.41
8	2013-07-11 14:19:07	Operation	Remote: Get Parameters		admin	172.9.11.41
9	2013-07-11 14:19:08	Operation	Remote: Get Parameters		admin	172.9.11.41
10	2013-07-11 14:19:08	Operation	Remote: Get Parameters		admin	172.9.11.41
11	2013-07-11 14:19:08	Operation	Remote: Get Parameters		admin	172.9.11.41
12	2013-07-11 14:19:08	Operation	Remote: Get Parameters		admin	172.9.11.41
13	2013-07-11 14:19:08	Operation	Remote: Get Parameters	A1	admin	172.9.11.41

Total 42 Items [First Page](#) [Prev Page](#) 1/1 [Next Page](#) [Last Page](#)

Note Up to 100 log files can be displayed at a time.

Saving Log Files

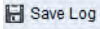
Click  to save the found log files to a local directory.

Honeywell

www.honeywell.com/security

+1 800 323 4576 (North America only)

<https://www.honeywellsystems.com/ss/techsupp/index.html>

Document 800-15611V2 – Rev A – 10/2013

© 2013 Honeywell International Inc. All rights reserved. No part of this publication may be reproduced by any means without written permission from Honeywell. The information in this publication is believed to be accurate in all respects. However, Honeywell cannot assume responsibility for any consequences resulting from the use thereof. The information contained herein is subject to change without notice. Revisions or new editions to this publication may be issued to incorporate such changes.

Free Manuals Download Website

<http://myh66.com>

<http://usermanuals.us>

<http://www.somanuals.com>

<http://www.4manuals.cc>

<http://www.manual-lib.com>

<http://www.404manual.com>

<http://www.luxmanual.com>

<http://aubethermostatmanual.com>

Golf course search by state

<http://golfingnear.com>

Email search by domain

<http://emailbydomain.com>

Auto manuals search

<http://auto.somanuals.com>

TV manuals search

<http://tv.somanuals.com>