

# Honeywell

## Portable Air Conditioner User Manual

Read and save these instructions before use

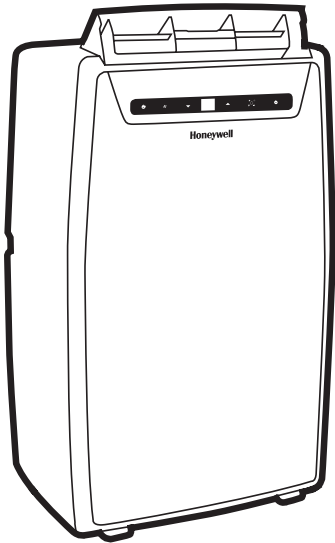

---

Model:

MN1CFS8/ MN1HFS8/  
MN1CFSBB8/ MN1HFSBB8/  
MN1CFSWW8/ MN1HFSWW8  
MN4CFS9/ MN4HFS9/  
MN4CFSBB9/ MN4HFSBB9/  
MN4CFSWW9/ MN4HFSWW9  
MN4CFS0/ MN4HFS0/  
MN4CFSBB0/ MN4HFSBB0/  
MN4CFSWW0/ MN4CFSWW0

---

Customer Support:  
Web: [www.jmatek.com](http://www.jmatek.com)  
USA: 1-800-474-2147 | [usinfo@jmatek.com](mailto:usinfo@jmatek.com)  
CANADA^: [canadainfo@jmatek.com](mailto:canadainfo@jmatek.com)

^ Canada Customer Support service available for models sold in Canada only.



## READ AND SAVE THESE INSTRUCTIONS

IMPORTANT SAFETY INSTRUCTIONS. READ CAREFULLY AND KEEP FOR FUTURE REFERENCE. IN CASE THERE IS ANY INCONSISTENCY OR CONFLICT BETWEEN THE ENGLISH VERSION AND ANY OTHER LANGUAGE VERSION OF THE CONTENT OF THIS MATERIAL, THE ENGLISH VERSION SHALL PREVAIL.

### WARNING:

- Basic safety precautions should always be followed when using electrical appliances.
- Electrical equipment and installations regulated by national legislation must be followed.
- The appliance should be transported upright.
- Do not turn on the appliance for at least one hour after transported.
- DO NOT operate the unit with a damaged plug or loose wall outlet. If the supply cord is damaged, it must be replaced by the manufacturer, its service agent or similarly qualified persons in order to avoid a hazard.
- DO NOT cover the air intake and exhaust when in use.
- DO NOT place objects, especially heavy or hot objects, on top of unit. DO NOT sit on the unit and DO NOT cover or restrict the air intake.
- Always turn OFF and unplug the unit when cleaning, servicing or not in use.
- DO NOT use the appliance if it is damaged.
- DO NOT modify this appliance in anyway, in order to avoid danger.
- If service is required, contact a registered professional electrician or authorized service agent. Do not attempt to disassemble or repair the unit yourself. This can be very dangerous.
- Unplug the unit when stored or not in use.
- DO NOT pull or carry the appliance by the power cord.

## SAFETY (CONTINUED)

- DO NOT pinch the power cord in the door and DO NOT pull it along edges or sharp corners.
- Do not pierce or burn the unit.
- It is essential that the unit is connected to a grounded outlet, that matches the appliance's electrical specifications.
- Refrigerant gas may be odorless.
- Stagnation of possible leaks of refrigerant gas in unventilated rooms could lead to fire or an explosion hazard should the refrigerant come in contact with electric heaters, stoves or other sources of ignition.
- Use care when storing the appliance to prevent mechanical faults.
- Only persons authorized by an accredited agency in the handling of refrigerants should work on refrigerant circuits.
- Maintenance and repairs requiring the assistance of other qualified personnel must be carried out under the supervision of specialists in the use of inflammable refrigerants.
- DO NOT use means to accelerate the defrosting process or to clean, other than those recommended by the manufacturer.
- DO NOT run the power cord under carpeting and rugs. Use caution to prevent tripping on cord.
- DO NOT use the device in the following cases:
  - in a room with continuously operating sources of ignition (eg. open flames, an operating gas appliance or an operating electrical heaters.
  - In areas where gasoline, sulphur, oil, paint or other flammable goods are stored.
  - In an area where the water can be projected.
- DO NOT touch the plug or the device with wet hands.
- Flammable substances or pressurized containers (eg. aerosol cans) should be kept a minimum of 50cms away.
- This appliance has been manufactured for use in domestic environments and should not be used for other purposes.



## SAFETY (CONTINUED)

- Use only implements recommended by the manufacturer for defrosting or cleaning. Unless apt for such unit and with according electrical specifications.
- **Only use the installation kit provided to install this unit. DO NOT attempt to extend the hose or install this unit using other methods other than that shown in this manual. Improper installation will void any existing warranties.**
- DO NOT use an extension cord with this unit.
- This appliance can be used by children aged from 8 years and above, and persons with reduced physical, sensory or mental capabilities or lack of experience and knowledge if they have been given supervision or instruction concerning use of the appliance in a safe way and understand the hazards involved. Children shall not play with the appliance. Cleaning and user maintenance shall not be made by children without supervision.
- Never insert your fingers or rods into the air outlet. Take special care to warn children of these dangers.
- The manufacturer is not liable for injury caused to persons or property damage due to non-compliance with maintenance instructions and improper use of the appliance.
- The appliance shall be installed in accordance with national wiring regulations.
- The appliance is not to be used by persons (including children) with reduced physical, sensory or mental capabilities, or lack of experience and knowledge, unless they have been given supervision or instruction.
- DO NOT operate your air conditioner in a wet room such as a bathroom or laundry room.
- This appliance should be used in a room that allows for good ventilation between the unit and any walls/furniture or other objects. The room size should correspond to the room area as specified for operation by the manufacturer and the appliance should be well kept to prevent mechanical

## **SAFETY (CONTINUED)**

- Keep ventilation openings clear of obstruction.
- DO NOT pierce or burn unit or refrigerant.
- Be aware that refrigerants may not contain an odor.

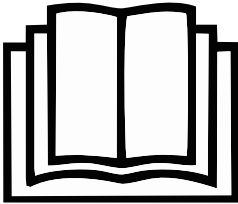
## SAFETY (CONTINUED)

SYMBOL	NOTE	EXPLANATION
	WARNING	This symbol shows that this appliance uses a flammable refrigerant. If the refrigerant is leaked and exposed to an external ignition source, there is a risk of fire.
	CAUTION	This symbol shows that the operation manual should be read carefully.
	CAUTION	This symbol shows that a service personnel should be handling this equipment with reference to the installation manual.
	CAUTION	This symbol shows that information is available such as the operating manual or installation manual.



Repair must be performed based on the recommendations from the manufacturer. Maintenance and repair that requires the assistance of other qualified personnel must be performed under the supervision of specialists in the use of flammable refrigerants.

# THANK YOU

Congratulations on your purchase of this Honeywell Portable Air Conditioner.

Regarding the information pertaining to the installation, handling, servicing, cleaning and disposal of the appliance, please refer to the below paragraph of the manual.

## USER TIPS

Portable Air Conditioners are ideal for spot cooling. The compressor, condenser and evaporator are housed in a compact unit. The air is dehumidified and cooled while a flexible Exhaust Hose sends heat outside. The air conditioner includes a window venting kit.

No permanent installation is needed. The unit is easy to move from room to room and offers a truly flexible air conditioning solution.

Auto Evaporation System - The unit automatically evaporates the condensate through the Exhaust Hose. There is no need to empty the drainage tank except in humid conditions. Read and follow the instructions carefully.

To ensure optimal efficiency of the product, keep doors and windows closed when it is used as an air conditioner or dehumidifier. If the product is being used with the fan function only, an open window could improve air circulation.



### Important:

Before installing the unit, place it UPRIGHT for 1 hour before use to allow the refrigerant to stabilize. Manually adjust the air vent located at the top of the unit to adjust the direction of air flow.

- Follow installation instructions to set up the unit.
- Plug the unit into a properly grounded circuit. DO NOT plug into an extension cord.

\*Applicable for models with Heating feature only.

# PARTS DESCRIPTION

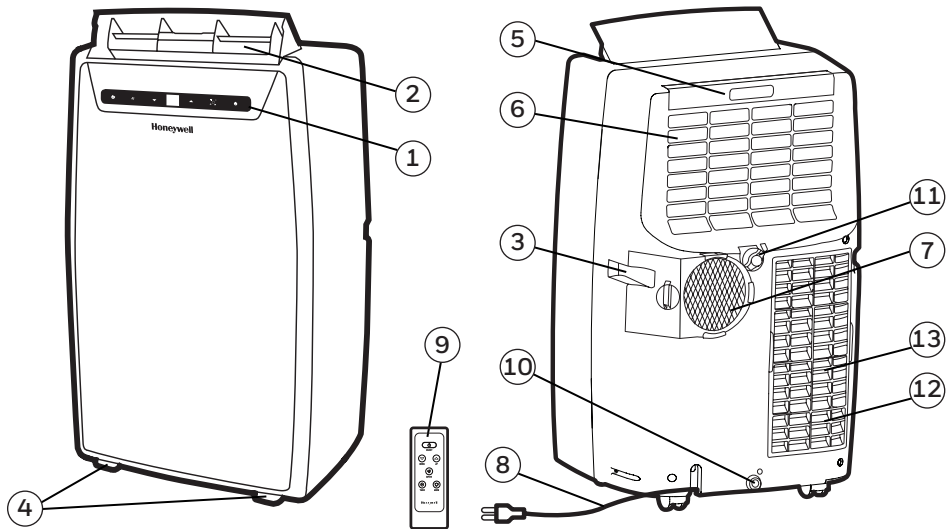

1) Control Panel  
(Incl. Signal Receptor)

2) Air Outlet

3) Handle

4) Casters

5) Upper Dust Filter

6) Upper Grill

7) Exhaust Hose Connector

8) Power Supply Cord

9) Remote Control

10) Lower Drain Plug with Plastic Cap  
(Air Conditioning Mode)

11) Upper Drain Plug  
(Dehumidifier Mode)

12) Lower Dust Filter

13) Lower Grill



# INSTALLATION

It is important that the installation instructions below are followed for successful installation of this Portable Air Conditioner. Please call Customer Support if you have any difficulties or queries regarding these installation procedures.

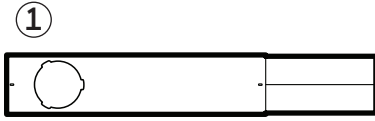

x1

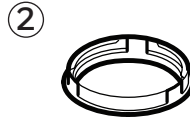

x1

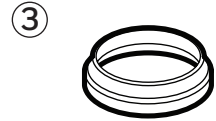

x1

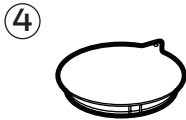

x1

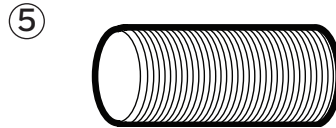

x1

## Installation Kit:

- |                                 |           |                 |           |
|---------------------------------|-----------|-----------------|-----------|
| 1. Window Bracket Kit           | (1 Set)   | 4. Hole Cover   | (1 Piece) |
| 2. Window Bracket Panel Adapter | (1 Piece) | 5. Exhaust Hose | (1 Piece) |
| 3. Exhaust Hose Connector       | (1 Piece) |                 |           |

## Installation Steps:

1. Exhaust Hose Connector, Exhaust Hose and window bracket panel adapter are pre-assembled inside the package.

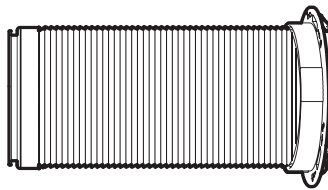

Hose:  
Length: 12" to 47" (30 cm to 120 cm)

# INSTALLATION (CONTINUED)

2. The Window Brackets are approximately 19.7" (50 cm) each, allowing you to install to windows and balcony doors of different heights or width.

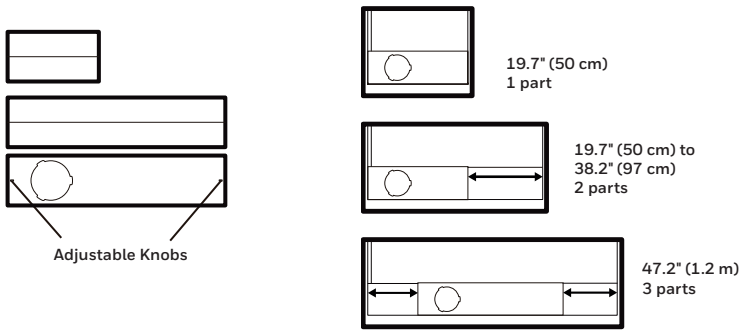

To install the window bracket to the window frame, you need to adjust the height or width of the window bracket by extending the length according to the height or width of the window. When the length is set, tighten the Adjustable Knobs (preinstalled on the window bracket) to ensure the window bracket is secured in the desired position. Use one or all three pieces of window bracket as needed.

**Note:** After setting the window bracket to the size of your window, please remove it from the window and follow the instructions below.

3. Connect the Exhaust Hose to the rear exhaust outlet on the back of the unit. Slide-in the Hose Connector from left to right. Rotate clockwise to ensure the knob mechanism is locked in place. Anticlockwise to unlock the knob mechanism.

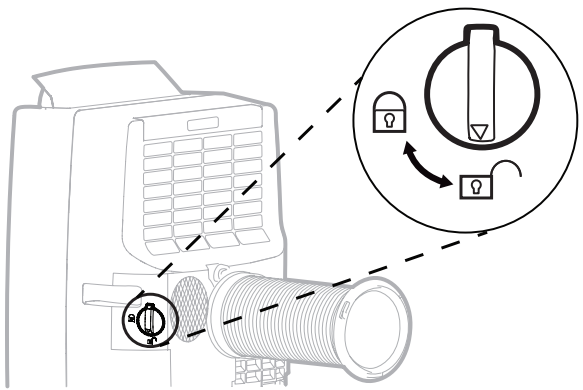

# INSTALLATION (CONTINUED)

4. Connect the window bracket to the window bracket panel adapter. Slide-in the window bracket panel adapter then rotate clockwise until it is locked in place.

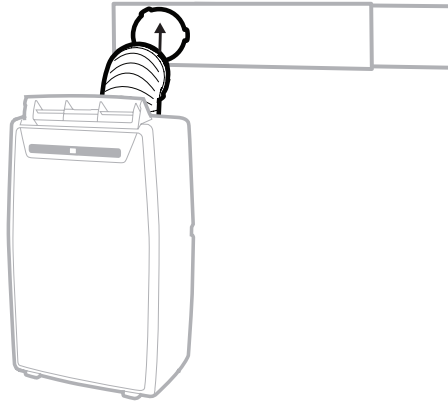

5. Connect the window bracket to the window.

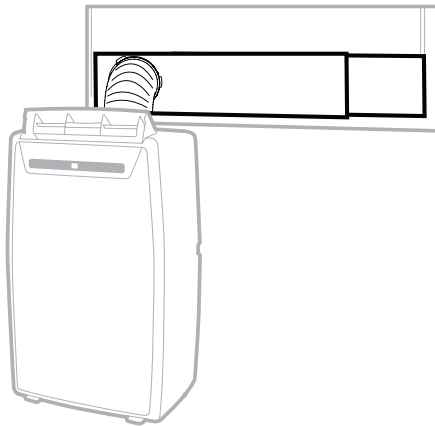

6. The Portable Air Conditioner is now ready to use.

# INSTALLATION (CONTINUED)

**IMPORTANT:** Do not replace or lengthen the Exhaust Hose as this could cause the unit to malfunction.

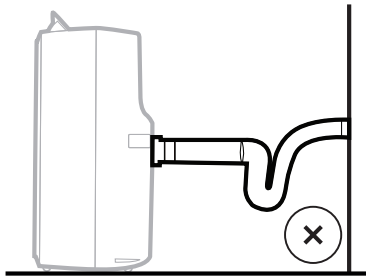

NOT RECOMMENDED

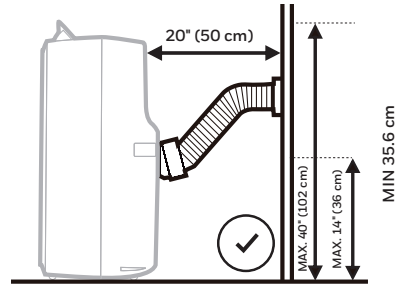

RECOMMENDED

**WARNING:** Any warranties included with this product will be voided if an extra extension hose is added to the originally provided installation kit or if the installation is performed differently than the manufacturer's instructions, without proper consultation. Please contact Customer Support for help with installation procedures if needed.

- The supplied Exhaust Hose has a diameter of 5" (12.7 cm) and can be extended from 12" to 47" (30 cm to 120 cm).
- Do not bend (to the extent shown below) the Exhaust Hose. A bent hose will block exhaust air and cause the unit to malfunction or shut-off.
- Make sure the back of the unit is at least 20" (50 cm) away from the wall. Do not place the unit in front of curtains or drapes as this could obstruct the airflow.

## CONTROL PANEL

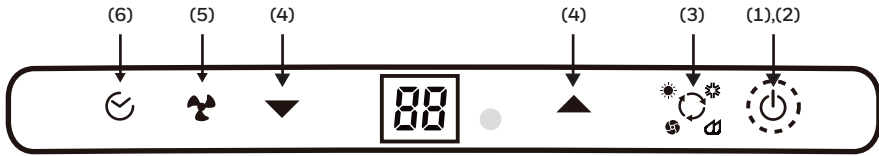

- |                                  |                                     |
|----------------------------------|-------------------------------------|
| 1) Power Control / Standby Mode  | 4) Timer / Temperature Set Controls |
| 2) Warning Light (when flashing) | 5) Fan Speed Control                |
| 3) Mode Control                  | 6) Timer Control                    |

## FUNCTION BUTTONS

### POWER CONTROL

The Power Control turns the unit on and off. When the unit is plugged in, this button lights up indicating it is in a Standby Mode ready to be switched on anytime.

### WARNING LIGHT

Condensation may accumulate in the unit.

If the internal tank becomes full, the Power Control light will flash and the unit will not operate until the unit has been drained (refer to Water Condensation Drainage).

**After switching the air conditioner off, you must wait 3 minutes before switching it back on again.**

### MODE CONTROL

Settings: Air Conditioning, Heating\*, Dehumidifying, Fan.

The corresponding indicator light will illuminate to indicate the current mode setting.



- Air Conditioning Mode   
Adjust fan speed and air temperature to suit your desired comfort level.  
Temperature setting range is 16°C - 32°C (61°F - 89°F).

\*Applicable for models with Heating feature only.

## FUNCTION BUTTONS (CONTINUED)

- Dehumidifying Mode   
Air is dehumidified as it passes through the unit, without being in full cooling mode. If room temperature is higher than 25°C (77°F) fan speed can be adjusted; otherwise fan speed is preset to LOW.  
**Note:** If the unit will be used mainly as a dehumidifier, do not connect the Exhaust Hoses. Continuous drainage is then necessary (refer to Continuous Draining for Dehumidifier Mode).

**IMPORTANT:** The Dehumidifier mode is used to support moisture reduction but should not be expected to dehumidify to the same degree as a standard dehumidifier-only appliance. The built-in dehumidifier automatically adjusts dehumidification based on ambient room temperatures. It is not possible to adjust to a desired humidity percentage. The front display only shows the current AND desired temperatures. It does not show humidity levels.

- Fan Mode   
For air circulation without air conditioner cooling.
- Heating Mode\*   
This unit uses Heat-Pump technology which reverses the air conditioning cooling cycle by transferring heat from the outside into the room – this is more energy efficient than traditional electric heaters that generate heat instead of transferring heat into the room. These properties make this heater ideal for use in autumn or spring when outdoor temperatures are not severely cold, or as supplemental heating in colder rooms of your home.

When heating mode is selected the indicator light will shine. Heating is activated only when the ambient temperature is below 25°C (77°F). In this mode, the desired temperature can be set between 16°C- 25°C (61°F - 77°F).

**Note:** The Exhaust Hoses must vent outside the room when using heating mode.

**IMPORTANT:** The Heat pump draws moisture from the air which then condenses into the internal water tank. The unit will pause operation when the tank is full and will restart when the tank has been emptied. It is recommended to use the heating mode in a room with 50% humidity or lower. Avoid operating moisture-producing products or appliances such as a humidifier or a kettle when using the unit in heating mode.

See the "Draining Water Condensation in Heat Mode" section for more information on draining the water tank.

\*Applicable for models with Heating feature only.

## FUNCTION BUTTONS (CONTINUED)

### TEMPERATURE / TIMER SET CONTROLS

- Used for adjusting the timer and thermostat.
- The default display is setting temperature.
- In cooling mode, when ▼ or ▲ button is pressed, the set temperature is displayed and may be adjusted. After 10 seconds the display will revert back to room temperature. Temperature is only adjustable in cool mode. The time is adjustable between 1 - 24 hours.

**Note:** By pressing both ▼ or ▲ buttons at the same time, the display will toggle between Celsius(°C) and Fahrenheit(°F).

### FAN SPEED CONTROL

3 settings: High, Medium and Low.

### TIMER CONTROL

While the unit is turned on, press the timer button then press the ▼ or ▲ to select the number of hours you would like the unit to continue to run. The unit will turn off automatically.

### AUTO TURN OFF:

While unit is running, press the ▼ or ▲ button to select the number of hours you want the unit to run in air conditioning mode.

### AUTO TURN ON:

When unit is in a standby mode (plugged in with power light on), then press the ▼ or ▲ button to select the number of hours until you want the unit to automatically start running.

## REMOTE CONTROL

The functions work the same as the Portable Air Conditioner's Control Panel. All key functions can be accessed from the remote control.

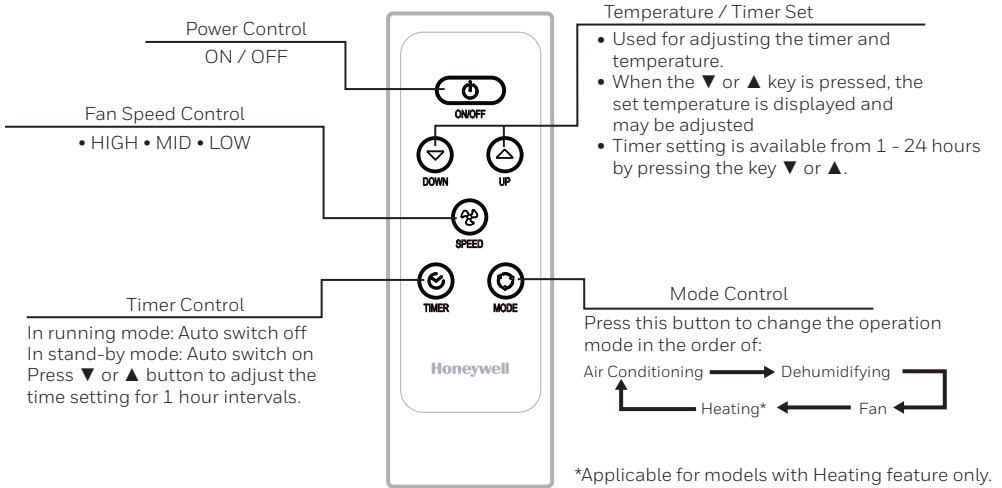

### Note:

- Battery Installation: Remove the cover on the back of the remote control and insert two AAA batteries with + and - pointing in the proper direction according to the polarity markings.

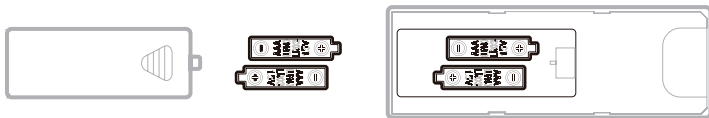

### Caution:

- Use only two AAA or IEC R03 1.5V batteries.
- Remove the batteries if the remote control is not in use for a month or longer.
- All batteries should be replaced at the same time, do not mix with old batteries.
- Do not mix alkaline, standard (carbon-zinc) or rechargeable (nickel-cadmium) batteries.
- Properly dispose of used batteries.

This device complies with part 15 of the FCC Rules. Operation is subject to following two conditions: (1) this device may not cause harmful interference, and (2) this device must accept any interference received, including interference that may cause undesired operation.

This equipment has been tested and found to comply with the limits for a Class B digital device, pursuant to part 15 of the FCC Rules. These limits are designed to provide reasonable protection against harmful interference in a residential installation. This equipment generates, uses and can radiate radio frequency energy and, if not installed and used in accordance with the instructions, may cause harmful interference to radio communications. However, there is no guarantee that interference will not occur in a particular installation. If this equipment does cause harmful interference to radio or television reception, which can be determined by turning the equipment off and on, the user is encouraged to try to correct the interference by one or more of the following measures:

- Reorient or relocate the receiving antenna.
- Increase the separation between the equipment and the receiver.
- Connect the equipment into an outlet on a circuit different from that to which the receiver is connected.
- Consult the dealer or an experienced radio/ TV technician for help.

Caution: Any changes or modifications not expressly approved by the party responsible for compliance could void the user's authority to operate the equipment.



## Appliance Maintenance:

1. Turn off the appliance before disconnecting the power supply.
2. Only clean the appliance with a soft dry cloth.

## Dust Filter Maintenance:

The dust filter is to be cleaned every two weeks to maintain air cooling efficiency. Please follow the below instructions for cleaning the dust filter:

1. Switch off and unplug the air conditioner from the electrical outlet.
2. Remove the Upper Dust Filter and the Lower Dust Filter.
3. Gently wash using water and/ or diluted liquid dishwashing detergent.

Rinse thoroughly and gently shake excess water from the filters. Make sure the filters are dry before reinstalling.

**Note:** You may use a vacuum cleaner to remove dust.

4. Replace the Upper Dust Filter and the Lower Dust Filter onto the unit.

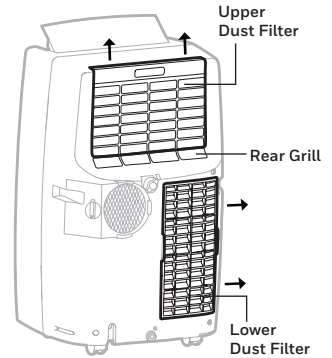

**WARNING:** DO NOT power or operate the Air Conditioner when cleaning or when any or both of the Rear Grills are removed from the unit, or if there is a loose-fitting Rear Grill(s). DO NOT attempt to handle or touch any of the parts or wiring inside the air conditioner after the Rear Grill(s) are removed from the unit. Doing so can cause serious injury or electrical shock.

## End of Season Storage & Maintenance:

If the appliance will not be used for a long time, follow these steps:

1. Be sure to drain the left-over water condensation. Remove the lower drain plug and use a shallow pan to collect the water (make sure to replace the drain plug when finished).
2. To dry excess moisture, run the unit in Fan only mode for 30 minutes before storing.
3. Turn off and unplug the air conditioner from the power supply.
4. Remove the dust filter and clean with water. Dry the dust filter and then reinstall.
5. Disconnecting the Window Installation Kit:
  - Remove the Exhaust Hose from the unit by rotating anti-clockwise to unlock the knob mechanism then sliding out.
  - Remove the window bracket panel adapter from the window bracket by rotating anti-clockwise then pulling away.
  - It is recommended to store the Window Kit parts in a bag together with the Remote Control and placing them together with the air conditioner unit.
  - If needed, you can clean the Window Kit with a damp cloth and water before storing. Make sure all parts of the Window Kit are dry before storage.
6. It is recommended to coil the power cord before storing to ensure the cord is protected from bents and creases.
7. Do not store the appliance covered with plastic bags.

# WATER CONDENSATION DRAINAGE

When there is excess water condensation inside the unit, the air conditioner stops running and shows a warning light (the Power Control button flashes with a red light). This warning light indicates that the water condensation needs to be drained using the following procedures:

## Manual Draining in Cooling, Dehumidifying and Heating\* Modes

Water may need to be drained in high humidity areas.

1. Unplug the unit from power source.
2. Place a shallow pan under the lower rubber drain plug. See diagram.
3. Remove the lower rubber drain plug.
4. Water will drain out and collect in the shallow pan.
5. After the water is drained, replace the lower rubber drain plug firmly.
6. You can now turn on the unit.

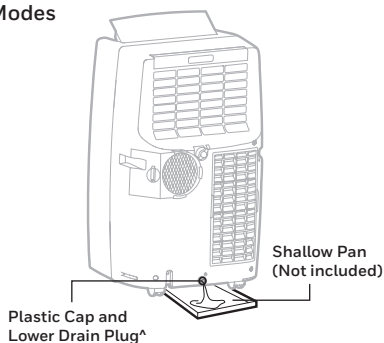

If you find that there is a high volume of condensation and a shallow pan is not enough for your use, you can use a large pan to drain. Follow the below instructions carefully:

1. Find a flat, stable board that is up to 1" thick. The base could be a wooden board purchased from your local hardware store, with a minimum base dimension of 20" (length) x 17" (width) x 1" (thick).
2. The base should be large and sturdy enough to fit the Portable Air Conditioner on top. The air conditioner must be stable and not rock or move when positioned on this base and not easy to topple over.
3. Drain the water from the lower drain plug as needed, into a larger pan or through a drain tube. If using a drain tube, you can purchase vinyl tubing which has an outside diameter of 5/8" and an inside diameter of 1/2". Remember the drain tube must be positioned lower than the drain plug so the water condensation does not flow backwards back into the air conditioner.

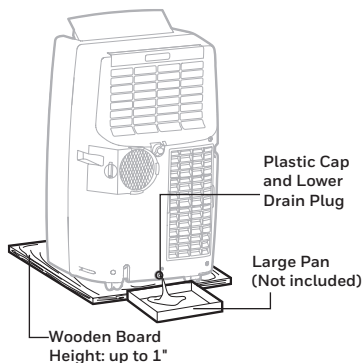

**WARNING:** For safety reasons, the Portable Air Conditioner must NOT be positioned on a base that is higher than 1" from the floor. This is only recommended if you have a stable, flat base to position the Portable Air Conditioner on safely.

\*Applicable for models with Heating feature only.

^MN1CFS8/ MN1HFS8/ MN1CFSBB8/ MN1HFSBB8/ MN1CFSWW8/ MN1HFSWW8: External Dia.: 17 mm  
MN4CFS9/ MN4HFS9/ MN4CFSBB9/ MN4HFSBB9/ MN4CFSWW9/ MN4HFSWW9: External Dia.: 17 mm  
MN4CFS0/ MN4HFS0/ MN4CFSBB0/ MN4HFSBB0/ MN4CFSWW0/ MN4HFSWW0: External Dia.: 17 mm

## Continuous Draining in Dehumidifier Mode

While using the unit in dehumidifier mode, continuous drainage is recommended.

1. Unplug the unit from power source.
2. Remove the upper rubber drain plug.  
Some residual water may spill so please have a pan to collect the water. See diagram.
3. Connect the drain connector to a  $\frac{3}{4}$ " hose or standard garden hose (not included).
4. The water can be continuously drained through the drain tube into a floor drain or bucket.
5. Replace the drain plug.
6. You can now turn on the unit.

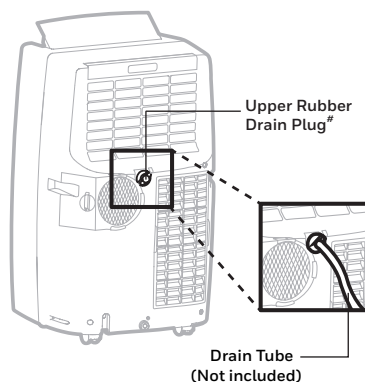

**IMPORTANT:** It is NOT recommended to connect the drain hose for continuous drainage while the unit is switched ON in air conditioning cooling mode. Doing so can reduce the cooling efficiency of the Portable Air Conditioner. Only drain the water condensation when the unit is switched off. Continuous drainage is only suitable when the unit is set up in Dehumidifier mode.

**IMPORTANT:** The water cannot be drained using the continuous drain option in heating\* mode. In Heating mode, the internal water tank collects condensation faster and may require more frequent emptying of the tank in more humid rooms. It is recommended to use the heating mode in a room with 50 % humidity or lower. Avoid operating moisture-creating products or appliances such as a humidifier or a kettle when using the unit in heating mode.

\*Applicable for models with Heating feature only.

#MN1CFS8/ MN1HFS8/ MN1CFSBB8/ MN1HFSBB8/ MN1CFSWW8/ MN1HFSSWW8: External Dia.: 26.5 mm  
MN4CFS9/ MN4HFS9/ MN4CFSBB9/ MN4HFSBB9/ MN4CFSWW9/ MN4HFSSWW9: External Dia.: 17 mm

# TROUBLESHOOTING GUIDE

The following troubleshooting guide addresses the most common problems. If problems persist, call customer support. Unplug and disconnect the appliance from the power source before attempting to troubleshoot.

PROBLEM	POSSIBLE CAUSE	SOLUTION
The air conditioning unit does not start	No electricity.	Check for power.
	Batteries in the remote control need to be replaced.	Change remote control batteries.
	The power cord is not properly plugged in.	Remove and reconnect the power cord.
	The safety LCDI plug has tripped (USA / Canada / Mexico only).	Reset the safety LCDI plug, if problem persists contact our customer support (USA / Canada / Mexico only).
Runs a short while only	The thermostat temperature setting is too close to room temperature.	Lower the set temperature.
	Air outlet is blocked.	Make sure the Exhaust Hose is properly connected.
	There are tight bends in the air Exhaust Hose.	Connect Exhaust Hose as per instructions on page 3.
In Heating Mode*, the unit keeps switching off frequently	The room is too humid. Water Tank needs to be emptied.	In heating mode, the heat pump condenses moisture from the air into the internal water tank. In more humid rooms, it will collect faster and need to be emptied out more frequently. It is recommended to use the heating mode in 50% humidity or less. Switch off any appliances such as a humidifier or kettle to avoid extra moisture build up in the room when operating in heating mode.

\*Applicable for models with Heating feature only.

# TROUBLESHOOTING GUIDE (CONTINUED)

PROBLEM	POSSIBLE CAUSE	SOLUTION
Runs but not cooling	A door or window is open.	Make sure the window or door is closed.
	The dust filter is dirty.	Clean the dust filter.
	The Exhaust Hose is detached.	Reinstall Exhaust Hose properly (refer to Installation section).
	Temperature setting is too high.	Reduce temperature setting on control panel.
	Air outlet or intake is blocked.	Remove blockage.
	Room exceeds recommended size.	Move unit to smaller room.
	Large size or number of windows are decreasing cooling effectiveness.	Cover windows with curtains or blinds.
Will not run and Power button is blinking (water full indicator)	Excess water condensation inside the tank.	Drain the water (refer to Water Condensation Drainage).

# TROUBLESHOOTING GUIDE (CONTINUED)

PROBLEM	POSSIBLE CAUSE	SOLUTION
Heater* is not switching ON.	Heating function not activated yet. The ambient temperature is too high.	Check that the Heating function has been activated.  will be illuminated when the Heater is switched ON.
	Heating is activated only when the ambient temperature is below 25°C (77°F).	Switch on the Heating function when the ambient temperature reaches below 25°C (77°F).

\*Applicable for models with Heating feature only.

**JMATEK North America LLC**  
Mahwah, New Jersey 07495 USA  
Email: [usinfo@jmatek.com](mailto:usinfo@jmatek.com)  
Web: [www.jmatek.com](http://www.jmatek.com)

Made in China  
© 2021 JMATEK Limited. All rights reserved.  
The Honeywell Trademark is used under license  
from Honeywell International Inc.  
Honeywell International Inc. makes no  
representations or warranties with respect to this product.  
This product is manufactured by Airtel Int'l Corp. Ltd.  
(subsidiary of JMATEK Ltd.).

**Honeywell**



## Free Manuals Download Website

<http://myh66.com>

<http://usermanuals.us>

<http://www.somanuals.com>

<http://www.4manuals.cc>

<http://www.manual-lib.com>

<http://www.404manual.com>

<http://www.luxmanual.com>

<http://aubethermostatmanual.com>

Golf course search by state

<http://golfingnear.com>

Email search by domain

<http://emailbydomain.com>

Auto manuals search

<http://auto.somanuals.com>

TV manuals search

<http://tv.somanuals.com>