

ST 3000 Smart Transmitter Release 300 and Smart Field Communicator Model STS103 ***User's Manual***

34-ST-25-14

6/08

Copyright, Notices, and Trademarks

© Copyright 2008 by Honeywell Inc.

June 2008

While this information is presented in good faith and believed to be accurate, Honeywell disclaims the implied warranties of merchantability and fitness for a particular purpose and makes no express warranties except as may be stated in its written agreement with and for its customer.

In no event is Honeywell liable to anyone for any indirect, special or consequential damages. The information and specifications in this document are subject to change without notice.

This document was prepared using Information Mapping® methodologies and formatting principles.

TDC 3000, SFC, Smartline and ST 3000 are U.S. registered trademarks of Honeywell Inc.

Information Mapping is a trademark of Information Mapping Inc.

Honeywell Process Solutions
512 Virginia Drive
Fort Washington, PA 19034

About This Publication

This manual is intended as a detailed “how to” reference for installing, piping, wiring, configuring, starting up, operating, maintaining, calibrating, and servicing Honeywell’s family of **Release 300 Series 100 and Series 900** ST 3000[®] Smart Transmitters. It is based on using a model STS103 Smart Field Communicator (SFC[®]) as the operator interface for the ST 3000 transmitter. Be aware that data in this manual overlaps information in the *ST 3000 Smart Transmitter Installation Guide* and the *Smart Field Communicator Model STS103 Operating Guide* to minimize cross reference.

While this manual provides detailed procedures to assist first time users, it also includes keystroke summaries for most procedures as a quick reference for experienced users.

If you will be digitally integrating the ST 3000 transmitter with our **TotalPlant[®]** Solution (TPS) system, you will need to supplement this information with data in the *PM/APM Smartline[®] Transmitter Integration Manual* which is supplied with the TDC 3000^{®X} bookset. TPS is the evolution of TDC 3000^X.

This manual does **not** apply for **non Release 300 Series 100, Series 600, Series 100e** and **non Release 300 Series 900** transmitter models. If you have a non Release 300 Series 100 or Series 600 ST 3000 Smart Transmitter, refer to the *Installation Guide 34-ST-33-28* and *User’s Manual 34-ST-25-09* supplied with the transmitter for information. If you have a non Release 300 Series 900 or Series 100e Smart Transmitter, refer to the *Installation Guide 34-ST-33-31* and *User’s Manual 34-ST-25-11* supplied with the transmitter for information.

Patent Notice

This product is covered by one or more of the following U.S. Patents: 4,520,488; 4,567,466; 4,494,183; 4,502,335; 4,592,002; 4,553,104; 4,541,282; 4,806,905; 4,797,669; 4,735,090; 4,768,382; 4,787,250; 4,888,992; 5,811,690; 5,875,150; 5,765,436; 4,734,873; 6,041,659 and other patents pending.

References

Publication Title	Publication Number	Binder Title	Binder Number
<i>Smart Field Communicator Model STS103 Operating Guide</i>	34-ST-11-14		
<i>ST 3000 Smart Transmitter Series 100 and Series 900 Release 300 Installation Guide</i>	34-ST-33-39		
For R400 and later: <i>PM/APM Smartline Transmitter Integration Manual</i>	PM12-410	Implementation/ PM/APM Optional Devices	TDC 2045

Symbol Definitions



This CAUTION symbol on the equipment refers the user to the Product Manual for additional information. This symbol appears next to required information in the manual.



This WARNING symbol on the equipment refers the user to the Product Manual for additional information. This symbol appears next to required information in the manual.



WARNING: risk of electrical shock. This symbol warns the user of a potential shock hazard where HAZARDOUS LIVE voltages greater than 30 Vrms, 42.4 Vpeak, or 60 VDC may be accessible.



ATTENTION, Electrostatic Discharge (ESD) hazards. Observe precautions for handling electrostatic sensitive devices



Protective Earth (PE) terminal. Provided for connection of the protective earth (green or green/yellow) supply system conductor.



Earth Ground. Functional earth connection. NOTE: This connection shall be bonded to Protective earth at the source of supply in accordance with national and local electrical code requirements.

Table of Contents

References.....	iv
Technical Assistance	xiii
SECTION 1 —OVERVIEW - FIRST TIME USERS ONLY.....	1
1.1 Introduction	1
1.2 ST 3000 Smart Transmitters	2
1.3 Smart Field Communicator.....	8
1.4 Transmitter/SFC Order	11
1.5 Local Smart Meter Options.....	13
SECTION 2 —QUICK START REFERENCE.....	15
2.1 Introduction	15
2.2 Getting ST 3000 Transmitter On-Line Quickly	16
SECTION 3 —PREINSTALLATION CONSIDERATIONS	17
3.1 Introduction	17
3.2 CE Conformity (Europe) Notice	18
3.3 Considerations for ST 3000 Transmitter	19
3.4 Considerations for SFC	22
3.5 Considerations for Local Smart Meter Option	24
SECTION 4 —INSTALLATION	25
4.1 Introduction	25
4.2 Mounting ST 3000 Transmitter	26
4.3 Piping ST 3000 Transmitter.....	38
4.4 Wiring ST 3000 Transmitter.....	43
SECTION 5 —GETTING STARTED	49
5.1 Introduction	49
5.2 Establishing Communications	50
5.3 Making Initial Checks.....	54
5.4 Changing Mode of Operation	57

Table of Contents

SECTION 6 —CONFIGURATION	59
6.1 Introduction	59
6.2 Overview	60
6.3 Entering a Tag Number.....	71
6.4 Selecting Output Form	73
6.5 Adjusting Damping Time.....	76
6.6 Selecting Unit of Measurement.....	78
6.7 Setting Range Values Using SFC.....	80
6.8 Setting Range Values Using Local Adjustments	84
6.9 Selecting Output Signal Mode (DE Mode Only)	91
6.10 Selecting Message Format (DE Mode Only)	94
6.11 Configuring Smart Meter Using SFC	96
6.12 Configuring Smart Meter Using Pushbuttons	103
6.13 Disconnecting SFC	122
SECTION 7 —STARTUP.....	123
7.1 Introduction	123
7.2 Startup Tasks	124
7.3 Running Analog Output Check	125
7.4 Flow Measurement with DP Transmitter.....	128
7.5 Pressure Measurement with DP Transmitter.....	131
7.6 Liquid Level Measurement - Vented Tank	133
7.7 Liquid Level Measurement - Pressurized Tank	136
7.8 Pressure or Liquid Level Measurement with GP Transmitter	140
7.9 Pressure or Liquid Level Measurement with Flush Mount Transmitter	144
7.10 Pressure Measurement with AP Transmitter	145
7.11 Liquid Level Measurement with DP Transmitter with Remote Seals.....	147
SECTION 8 —OPERATION	151
8.1 Introduction	151
8.2 Accessing Operation Data	152
8.3 Changing Default Failsafe Direction	155
8.4 Writing Data in Scratch Pad Area	157
8.5 Saving and Restoring a Database	159
8.6 Monitoring Local Smart Meter Display.....	163
SECTION 9 —MAINTENANCE	169
9.1 Introduction	169
9.2 Preventive Maintenance.....	170
9.3 Inspecting and Cleaning Barrier Diaphragms.....	171
9.4 Replacing PWA.....	175
9.5 Replacing Meter Body.....	178

Table of Contents

SECTION 10 —CALIBRATION.....	183
10.1 Introduction	183
10.2 Overview.....	184
10.3 Calibrating Analog Output Signal	185
10.4 Calibrating Range with SFC	189
10.5 Resetting Calibration	192
SECTION 11 —TROUBLESHOOTING	195
11.1 Introduction	195
11.2 Overview.....	196
11.3 Clearing the “#” Symbol From SFC Display	197
11.4 Diagnostic Messages	199
11.5 Running Status Check.....	202
11.6 Interpreting Messages	203
11.7 Checking SFC Display and Keyboard	207
SECTION 12 —PARTS LIST	209
12.1 Replacement Parts	209
SECTION 13 —REFERENCE DRAWINGS	231
13.1 Wiring Diagrams	231
APPENDIX A – TABLE III OPTIONS IN MODEL NUMBER.....	233
A.1 Table III Options Reference.....	233
APPENDIX B – FREEZE PROTECTION OF TRANSMITTERS	237
B.1 Possible Solutions/Methods	237
APPENDIX C – CONFIGURATION RECORD SHEET	251
APPENDIX D – HAZARDOUS LOCATIONS REFERENCE	253
D.1 North American Classification of Hazardous Locations	253
D.2 International Electrotechnical Commission (IEC) Classification of Hazardous Locations	259
D.3 Enclosure Ratings	263
INDEX.....	266

Figures

Figure 1	Typical ST 3000 Differential Pressure Transmitter.....	2
Figure 2	Functional Block Diagram for Transmitter in Analog Mode of Operation.....	3
Figure 3	Functional Block Diagram for Transmitter in Digital DE Mode of Operation.....	4
Figure 4	Typical SFC Communication Interface.....	8
Figure 5	Typical ST 3000 Transmitter and SFC Order Components.....	11
Figure 6	ST 3000 with Local Smart Meter Option.....	14
Figure 7	Typical Mounting Area Considerations Prior to Installation.....	19
Figure 8	Typical Bracket Mounted and Flange Mounted Installations.....	26
Figure 9	Leveling a Model STA122 or 922 Absolute Pressure Transmitter.....	30
Figure 10	Typical Flange Mounted Transmitter Installation.....	33
Figure 11	Typical Flush Mounted Transmitter Installation.....	34
Figure 12	Typical Pipe and Flange Mounted Installations.....	35
Figure 13	Typical Remote Diaphragm Seal Transmitter Installation.....	37
Figure 14	Typical 3-Valve Manifold and Blow-Down Piping Arrangement.....	38
Figure 15	Typical Piping Arrangement for ½” NPT Process Connection.....	39
Figure 16	Operating Range for ST 3000 Transmitters.....	43
Figure 17	ST 3000 Transmitter Terminal Block.....	44
Figure 18	Ground Connection for Lightning Protection.....	46
Figure 19	Typical SFC Connections.....	50
Figure 20	Write Protect Jumper Location and Selections.....	55
Figure 21	Display With All Indicators Lit.....	56
Figure 22	Keystroke Summary for Changing Mode of Operation.....	58
Figure 23	Summary of Configuration Process.....	60
Figure 24	SFC and ST 3000 Transmitter Memories.....	61
Figure 25	Flowchart — ST 3000 Pressure Transmitter Configuration.....	66
Figure 26	Keystroke Summary for Entering Tag Number.....	72
Figure 27	Keystroke Summary for Selecting Output Conformity.....	74
Figure 28	Square Root Dropout Points.....	75
Figure 29	Keystroke Summary for Adjusting Damping Time.....	77
Figure 30	Keystroke Summary for Keying in LRV and URV.....	81
Figure 31	Keystroke Summary for Setting LRV and URV to Applied Pressures.....	83
Figure 32	Typical Setup for Setting Range Values Using Local Zero and Span Adjustments.....	90
Figure 33	Keystroke Summary for Selecting Mode of Output Signal Indication.....	93
Figure 34	Keystroke Summary for Selecting Message Format.....	95
Figure 35	Keystroke Summary for Configuring Local Smart Meter.....	102
Figure 36	Button Pushing Summary for Selecting Engineering Units.....	120
Figure 37	Button Pushing Summary for Setting Lower and Upper Display Limits.....	121
Figure 38	Typical SFC and Meter Connections for Constant-Current Source Mode.....	127
Figure 39	Typical Piping Arrangement for Flow Measurement with DP Type Transmitter.....	128
Figure 40	Typical Piping Arrangement for Pressure Measurement with DP Type Transmitter.....	131
Figure 41	Typical Piping Arrangement for Liquid Level Measurement with DP Type Transmitter and Vented Tank.....	133
Figure 42	Typical Piping Arrangement for Liquid Level Measurement with DP Type Transmitter and Pressurized Tank.....	136
Figure 43	Typical Piping Arrangement for Pressure Measurement with GP Type Transmitter.....	140
Figure 44	Typical Piping Arrangement for Liquid Level Measurement with GP Type Transmitter.....	140
Figure 45	Typical Arrangement for Pressure Measurement with Flush Mount Transmitter.....	144
Figure 46	Typical Arrangement for Liquid Level Measurement with Flush Mount Transmitter.....	144
Figure 47	Typical Piping Arrangement for Pressure Measurement with AP Type Transmitter.....	145

Figures

Figure 48	Typical Piping Arrangement for Liquid Level Measurement with DP Type Transmitter with Remote Seals	147
Figure 49	Location of Failsafe Direction Jumper on PWA.....	156
Figure 50	Summary of Save and Restore Database Function.....	159
Figure 51	Display With All Indicators Lit.....	163
Figure 52	Typical Calibration Hookup.....	191
Figure 53	Major ST 3000 Smart Transmitter Parts Reference.	210
Figure 54	ST 3000 Transmitter Mounting Bracket Parts Reference.	211
Figure 55	Series 100/900 Electronics Housing - Electronics/Meter End.	212
Figure 56	Series 100/900 Electronics Housing - Terminal Block End.....	212
Figure 57	Series 100 and Series 900 DP Meter Body for Models STD924 & STD930 C, D, G, H, K, and L and STD974	214
Figure 58	Series 900 DP Meter Body for Models Models STD924 & STD930 A, B, E, F, and J.....	217
Figure 59	Series 100 GP and AP Meter Bodies and Series 900 AP Meter Body	219
Figure 60	Series 900 Dual-Head GP Meter Bodies.....	221
Figure 61	Series 100 and Series 900 LGP Meter Body.....	222
Figure 62	Series 900 Flush Mount Meter Body.	223
Figure 63	Series 100 and Series 900 Flange Mounted Meter Body.	224
Figure 64	High Temperature Meter Body.	226
Figure 65	SFC Smart Field Communicator and Accessories.	228
Figure B-1	Piping Installation for Sealing Liquid With Specific Gravity Heavier Than Process Fluid.....	238
Figure B-2	Piping Installation for Sealing Liquid with Specific Gravity Lighter Than Process Fluid.....	239
Figure B-3	Piping Installation for Gas Flow.	240
Figure B-4	Piping Installation for Differential Pressure Transmitter with Metal Diaphragm Seals.....	241
Figure B-5	Piping Installation for Process Pressure Transmitter with Metal Diaphragm Seal.....	242
Figure B-6	Piping Installation for Differential Pressure Transmitter and Impulse Piping with Electric Heating and Control.....	243
Figure B-7	Piping Installation for Process Pressure Transmitter and Impulse Piping with Electric Heating Control.	244
Figure B-8	Piping Installation for Differential Pressure Transmitter and Impulse Piping with Steam Heating...	247
Figure B-9	Piping Installation for Process Pressure Transmitter and Impulse Piping with Steam Heating.	248

Tables

Table 1	ST 3000 Pressure Transmitter Family.....	6
Table 2	SFC Model Differences.....	9
Table 3	Local Smart Meter Available Options.....	13
Table 4	Start-up Tasks Reference.....	16
Table 5	Operating Temperature Limits (Transmitters with Silicone Fill Fluids).....	20
Table 6	Transmitter Overpressure Ratings.....	21
Table 7	Installing and Charging SFC Battery Pack.....	22
Table 8	Local Smart Meter Specifications.....	24
Table 9	Mounting ST 3000 Transmitter to a Bracket.....	27
Table 10	Zero Corrects Procedure for STD110.....	32
Table 11	Mounting Remote Diaphragm Seal Transmitter.....	36
Table 12	Suggested Transmitter Location for Given Process.....	39
Table 13	Process Connections.....	40
Table 14	Flange Description.....	41
Table 15	Installing Flange Adapter.....	42
Table 16	Wiring the Transmitter.....	45
Table 17	Starting Communications with Transmitter.....	51
Table 18	Confirming Mode of Operation and Identifying Software Versions.....	54
Table 19	Changing Mode of Operation.....	57
Table 20	Summary of Pressure Transmitter Configuration Parameters.....	63
Table 21	Entering Tag Number.....	71
Table 22	Selecting Output Conformity.....	73
Table 23	Adjusting Damping Time.....	76
Table 24	Pre-Programmed Engineering Units for Selection.....	78
Table 25	Keying in LRV and URV.....	80
Table 26	Setting LRV and URV to Applied Pressures.....	82
Table 27	Setting Range Values Using Local Zero and Span Adjustments.....	84
Table 28	Selecting Mode of Output Signal Indication.....	91
Table 29	Selecting Message Format.....	94
Table 30	Setting Up Local Smart Meter Configuration Using an SFC.....	97
Table 31	Smart Meter Pushbutton Description.....	103
Table 32	Smart Meter Engineering Units Code.....	105
Table 33	Selecting Engineering Units.....	106
Table 34	Smart Meter Restrictions for Setting Display Values.....	109
Table 35	Setting Lower Display Values for Smart Meter Display.....	110
Table 36	Setting Upper Display Value for Smart Meter Display.....	114
Table 37	Startup Procedure Reference.....	124
Table 38	Using Transmitter in Constant-Current Source Mode.....	125
Table 39	Starting Up DP Transmitter for Flow Measurement With SFC.....	128
Table 40	Starting Up DP Transmitter for Pressure Measurement With SFC.....	131
Table 41	Starting Up DP Transmitter for Liquid Level Measurement in Vented Tank.....	134
Table 42	Starting Up DP Transmitter for Liquid Level Measurement in Pressurized Tank.....	137
Table 43	Starting Up GP Transmitter for Pressure or Liquid Level Measurement With SFC.....	141
Table 44	Starting Up AP Transmitter for Pressure Measurement With SFC.....	145
Table 45	Starting Up DP Transmitter with Remote Seals for Liquid Level Measurement with SFC.....	148
Table 46	Summary of Keystrokes for Operation Data Access.....	152
Table 47	Cutting Failsafe Direction Jumper.....	156
Table 48	Writing Data in Scratch Pad Area.....	157
Table 49	Saving and Restoring a Database.....	160

Tables

Table 50	Description of Display Indicators Shown in Figure 51	163
Table 51	Summary of Typical Local Smart Meter Indications.	165
Table 52	Possible Smart Meter Error Codes.	166
Table 53	Inspecting and Cleaning Barrier Diaphragms	171
Table 54	Process Head Bolt Torque Ratings.....	174
Table 55	Replacing PWA.....	175
Table 56	Replacing Meter Body Only.....	178
Table 57	Calibrating Output Signal for Transmitter in Analog Mode	185
Table 58	Calibrating Measurement Range With SFC	189
Table 59	Resetting Calibration Data With SFC	193
Table 60	Clearing the # Symbol from the SFC Display	197
Table 61	Summary of Diagnostic Messages for Non-Critical Failures.....	199
Table 62	Summary of Diagnostic Messages for Critical Failures	200
Table 63	Summary of Diagnostic Messages for Communication Errors	200
Table 64	Summary of Diagnostic Messages for Invalid Key Entry Errors	201
Table 65	Summary of Interrupt Messages For SFC Display.....	201
Table 66	Running a Status Check With SFC	202
Table 67	Diagnostic Message Interpretation Table.....	203
Table 68	Running SFC Display and Keyboard Test	207
Table 69	Major ST 3000 Smart Transmitter Parts Reference.	211
Table 70	Parts Identification for Callouts in Figures 55 and 56.....	213
Table 71	Parts Identification for Callouts in Figure 57.....	215
Table 72	Parts Identification for Callouts in Figure 58.....	218
Table 73	Parts Identification for Callouts in Figure 59.....	219
Table 74	Replacement GP and AP Process Head Part Numbers for Narrow Profile Meter Body.....	220
Table 75	Parts Identification for Callouts in Figure 60.....	221
Table 76	Parts Identification for Callouts in Figure 61	222
Table 77	Parts Identification for Callouts in Figure 62.....	223
Table 78	Parts Identification for Callouts in Figure 63.....	225
Table 79	Parts Identification for Callouts in Figure 64.....	226
Table 80	Parts Identification for Callouts in Figure 65.....	229
Table 81	Summary of Recommended Spare Parts	230
Table B-1	Temperature Range of Freeze Protection Systems.....	246
Table B-2	Steam Pressure Versus Steam Temperature Values.....	250
Table D-1	Factory Mutual (FM) Entity Parameters	257
Table D-2	CSA Entity Parameters.....	258
Table D-3	CENELEC / LCIE Certification.....	261
Table D-4	Standards Australia (LOSC) Certification.....	262
Table D-5	Zone 2 (Europe) Declaration of Conformity	262
Table D-6	NEMA Enclosure Type Numbers and Comparable IEC Enclosure Classification	264

Acronyms

AP.....	Absolute Pressure
APM.....	Advanced Process Manager
AWG.....	American Wire Gauge
DE.....	Digital Enhanced Communications Mode
DP.....	Differential Pressure
EMI.....	Electromagnetic Interference
GP.....	Gauge Pressure
HP.....	High Pressure
HP.....	High Pressure Side (DP Transmitter)
inH ₂ O.....	Inches of Water
LGP.....	In-Line Gauge Pressure
LP.....	Low Pressure
LP.....	Low Pressure Side (DP Transmitter)
LRV.....	Lower Range Value
mA.....	Milliamperes
mmHg.....	Millimeters of Mercury
NPT.....	National Pipe Thread
PCB.....	Printed Circuit Board
PM.....	Process Manger
PROM.....	Programmable Read Only Memory
PSI.....	Pounds per Square Inch
PSIA.....	Pounds per Square Inch Absolute
RFI.....	Radio Frequency Interference
SFC.....	Smart Field Communicator
TPS.....	TotalPlant Solution
URL.....	Upper Range Limit
URV.....	Upper Range Value
Vdc.....	Volts Direct Current
XMTR.....	Transmitter

Technical Assistance

If you encounter a problem with your ST 3000 Smart Transmitter, check to see how your transmitter is currently configured to verify that all selections are consistent with your application.

If the problem persists, you can reach Honeywell's Solution Support Center for technical support by telephone during normal business hours. An engineer will discuss your problem with you. Please have your complete model number, serial number, and software revision number on hand for reference. You can find the model and serial numbers on the transmitter nameplates. You can also view the software version number using the SFC or SCT 3000 software application.

By Telephone

Honeywell Solution Support Center Phone:

1-800-423-9883 (U.S. only)

Outside the U.S. call: **1-602-313-6510**

Additional Help

You may also seek additional help by contacting the Honeywell distributor who supplied your ST 3000 transmitter.

By E-mail

You can also e-mail your technical questions or comments about this product to:

Honeywell Solution Support Center e-mail: **ace@honeywell.com**

Problem Resolution

If it is determined that a hardware problem exists, a replacement transmitter or part will be shipped with instructions for returning the defective unit. Please do not return your transmitter without authorization from Honeywell's Solution Support Center or until the replacement has been received.

Section 1 —Overview - First Time Users Only

1.1 Introduction

Section contents This section includes these topics:

Section	Topic	See Page
1.1	Introduction	1
1.2	ST 3000 Transmitters.....	2
1.3	Smart Field Communicator.....	8
1.4	Transmitter/SFC Order.....	11
1.5	Local Smart Meter Options.....	13

About this section This section is intended for users who have never worked with our ST 3000 Smart Transmitter and its companion operator interface device the hand-held Smart Field Communicator (SFC[®]) before. It provides some general information to acquaint you with the ST 3000 transmitter and the SFC.

ATTENTION

Honeywell also offers the SCT 3000 Smartline Configuration Toolkit that runs on a variety of Personal Computer (PC) platforms using MS-DOS 5.0 or higher and Windows 3.1 or higher. It is a bundled Microsoft Windows software and PC-interface hardware solution that allows quick, error-free configuration of Honeywell Smartline field instruments. Some SCT 3000 features include:

- Preconfigured templates that simplify configuration and allow rapid development of configuration databases.
- Context-sensitive help and an on-line user manual.
- Extensive menus and prompts that minimize the need for prior training or experience.
- The ability to load previously configured databases at time of installation.
- Automatic verification of device identification and database configuration menus and prompts for bench set up and calibration.
- The ability to save unlimited transmitter databases on the PC.

SCT 3000 Release 3.12.2 or greater is compatible with our latest Series 100 and 900, Release 300, ST 3000 transmitters. Please contact your Honeywell representative for more information.

1.2 ST 3000 Smart Transmitters

About the transmitter

The ST 3000 Smart Transmitter comes in a variety of models for measurement applications involving one of these basic types of pressure:

- Differential Pressure
- Gauge Pressure
- Absolute Pressure

The transmitter measures the process pressure and transmits an output signal proportional to the measured variable over a 4 to 20 milliampere, two-wire loop. Its major components are an electronics housing and a meter body as shown in Figure 1 for a typical differential pressure model transmitter.

Figure 1 Typical ST 3000 Differential Pressure Transmitter.

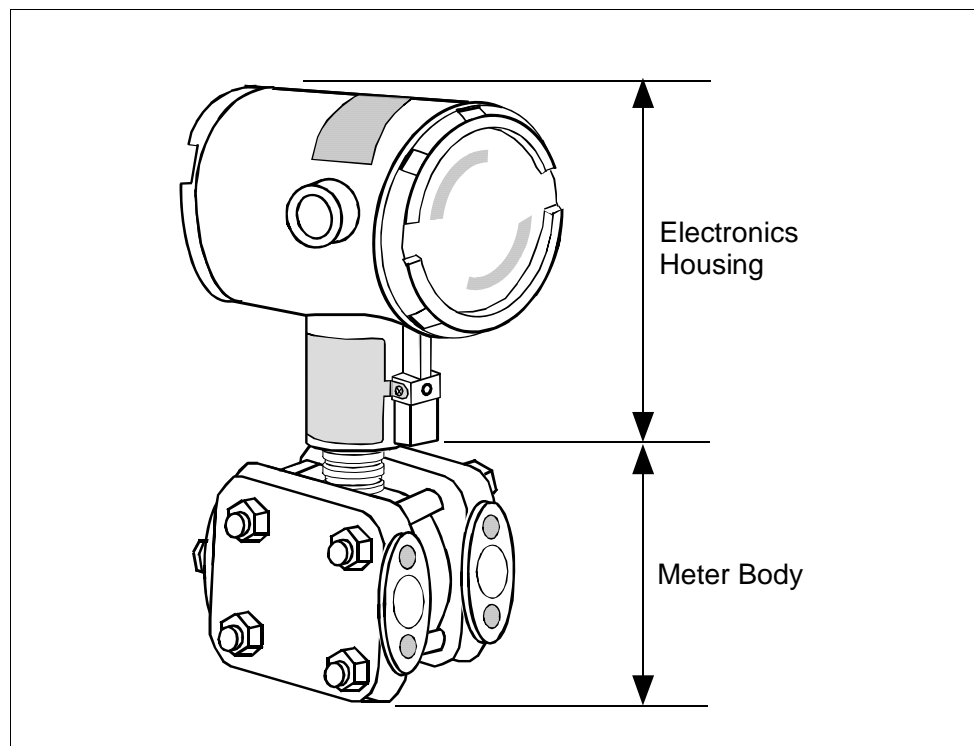

The ST 3000 can transmit its output in either an analog 4 to 20 milliampere format or a digital DE protocol format for direct digital communications with our TPS system, Allen-Bradley PLCs and other control systems.

Continued on next page

1.2 ST 3000 Smart Transmitters, Continued

About the transmitter,
continued

Besides the process variable (PV) output, the transmitter also provides its meter body temperature as a secondary variable which is only available as a read-only parameter through the SFC when the transmitter is in its analog mode. See Figure 2.

Figure 2 Functional Block Diagram for Transmitter in Analog Mode of Operation.

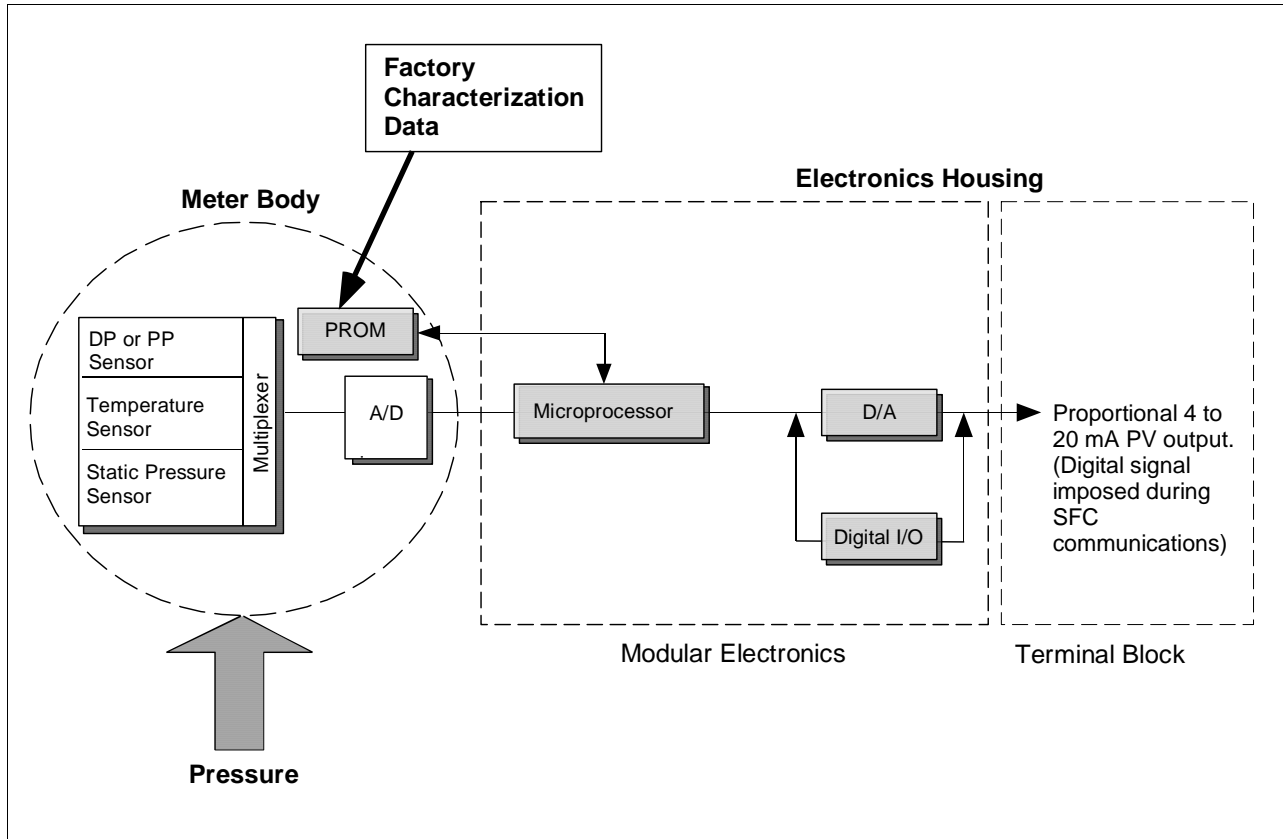

When the transmitter is in its DE mode, the process variable is available for monitoring and control purposes; and the meter body temperature is also available as a secondary variable for monitoring purposes only. See Figure 3.

Continued on next page

1.2 ST 3000 Smart Transmitters, Continued

Figure 3 Functional Block Diagram for Transmitter in Digital DE Mode of Operation.

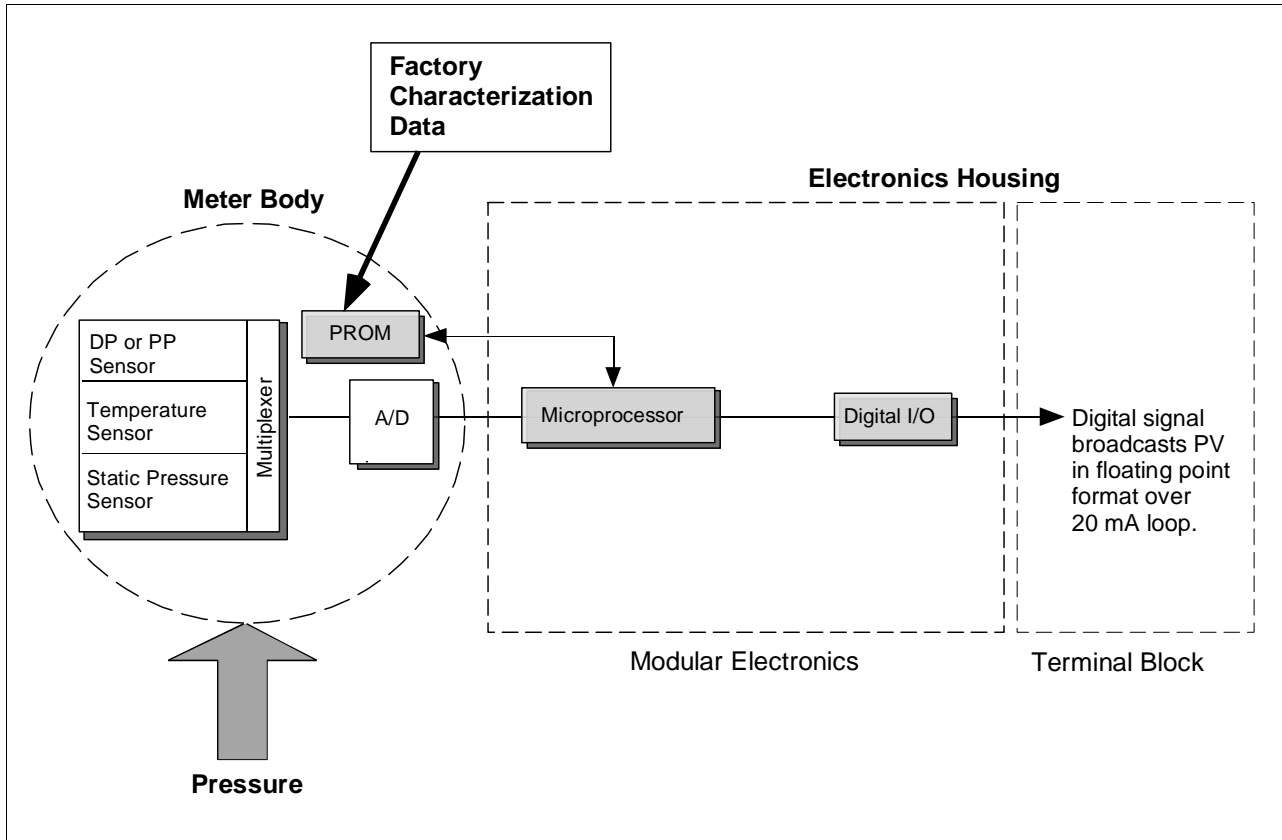

Series and model number data

Honeywell's line of ST 3000 Smart Transmitters includes these two series designations:

- Series 100
- Series 900

Each series includes several models to meet various process pressure measurement and interface requirements. Each transmitter comes with a nameplate located on the top of the electronics housing that lists its given "model number". The model number format consists of a Key Number with several Table selections as shown below.

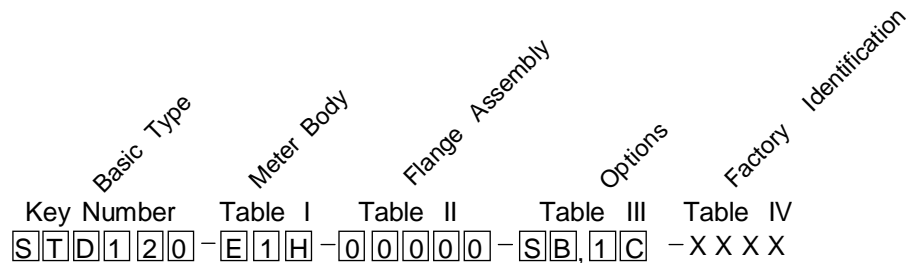

Continued on next page

1.2 ST 3000 Smart Transmitters, Continued

Series and model number data, continued

You can quickly identify what series and basic type of transmitter you have from the third and fourth digits in the key number. The letter in the third digit represents one of these basic transmitter types:

- A = Absolute Pressure
- D = Differential Pressure
- F = Flange Mounted
- G = Gauge Pressure
- R = Remote Seals

The number in the fourth digit matches the first digit in the transmitter Series. Thus, a “1” means the transmitter is a Series 100 and a “9” is a Series 900.

For a complete breakdown of the Table selections in your model number, please refer to the appropriate Specification and Model Selection Guide that is provided as a separate document. However, a description of the available Table III options is given in Appendix A of this manual for handy reference.

ATTENTION

Previous models of the ST 3000 transmitter with designations of Series 100, Series 100e, Series 600, and Series 900 have been supplied at various times since the ST 3000 was introduced in 1983. While all these transmitters are functionally alike, there are differences in housing and electronics design. This manual only applies for Release 300, Series 100 transmitters with software version 3.0 or greater and Release 300, Series 900 transmitters with software version b.0 or greater. See the procedure on page 50 to use the SFC to check your transmitter’s software version.

Release 300 transmitters can be identified by the “**R300**” designation on the nameplate.

Transmitter adjustments

Except for optional zero and span adjustments, the ST 3000 has no physical adjustments. You need an SFC to make any adjustments in an ST 3000 transmitter. Alternately, certain adjustments can be made through the Universal Station if the transmitter is digitally integrated with a Honeywell TPS system; or through a PC running Honeywell SCT 3000 software.

ST 3000 Transmitters presently available

Table 1 illustrates the present ST 3000 pressure transmitter family.

Continued on next page

1.2 ST 3000 Smart Transmitters, Continued

Table 1 ST 3000 Pressure Transmitter Family.

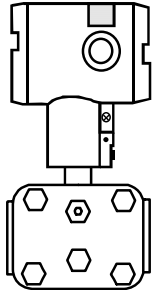
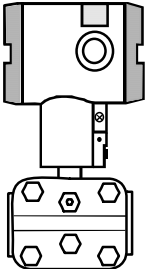
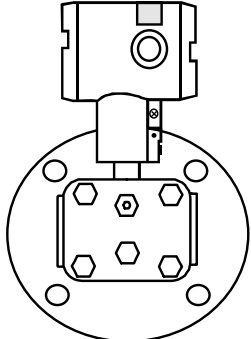
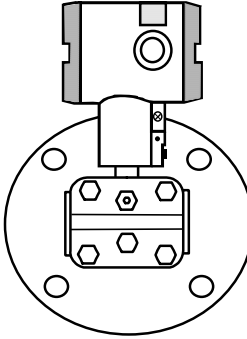
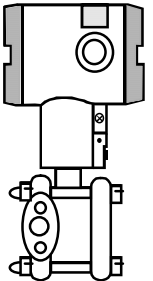
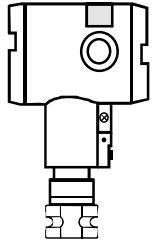
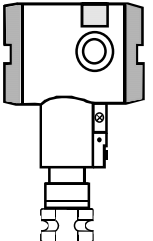
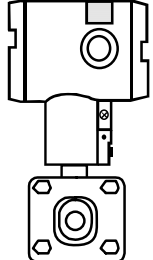
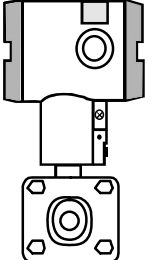
Transmitter Type	Series 100 Model	Series 900 Model
Differential Pressure	 <p style="text-align: right;">STD1xx</p>	 <p style="text-align: right;">STD9xx</p>
Differential Pressure with Flange on One Side	 <p style="text-align: right;">STF1xx</p>	 <p style="text-align: right;">STF9xx</p>
Dual-Head Gauge Pressure	<p>Not Available</p>	 <p style="text-align: right;">STG9xx</p>
In-Line Gauge and Absolute Pressure	 <p style="text-align: right;">STG1xL STA1xL</p>	 <p style="text-align: right;">STG9xL STA9xL</p>
Gauge and Absolute Pressure	 <p style="text-align: right;">STG1xx STA1xx</p>	 <p style="text-align: right;">STG9xx STA9xx</p>

Continued on next page

1.2 ST 3000 Smart Transmitters, Continued

Table 1 ST 3000 Pressure Transmitter Family, continued.

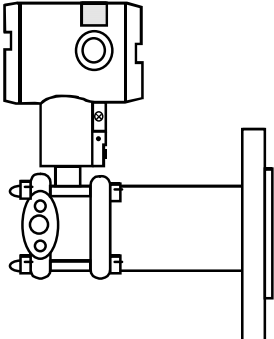
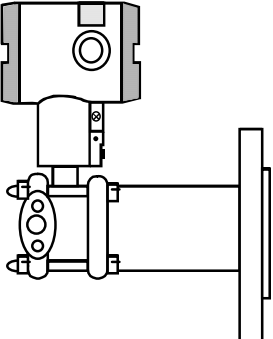
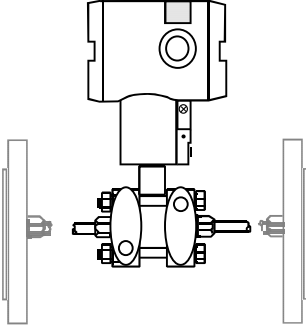
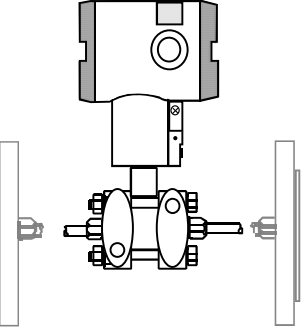
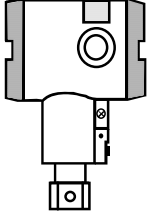
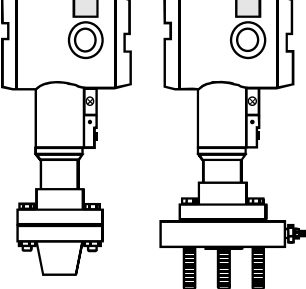
Transmitter Type	Series 100 Model	Series 900 Model
Flange-Mount Liquid Level	 STF1xx	 STF9xx
Differential Pressure with Remote Diaphragm Seals	 STR1xx	 STR9xx
Flush Mount	Not Available	 STG93P
High Temperature	 STG14T STF14T	Not Available

1.3 Smart Field Communicator

About SFC communications

The portable, battery-powered SFC serves as the common communication interface device for Honeywell's family of Smartline Transmitters. It communicates with a transmitter through serial digital signals over the 4 to 20 milliampere line used to power the transmitter. A request/response format is the basis for the communication operation. The transmitter's microprocessor receives a communication signal from the SFC, identifies the request, and sends a response message.

Figure 4 shows a simplified view of the communication interface provided by an SFC.

Figure 4 Typical SFC Communication Interface.

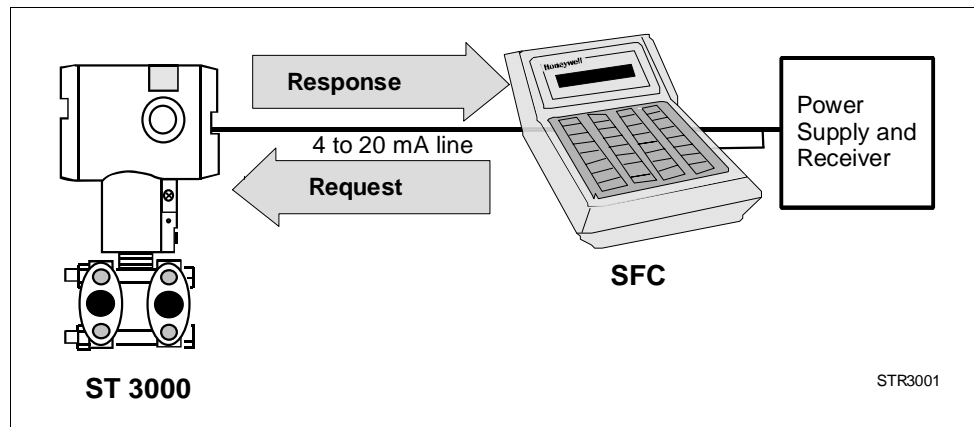

Purpose of SFC

The SFC allows you to adjust transmitter values, or diagnose potential problems from a remote location such as the control room. You can use the SFC to:

- **Configure:** Define and enter the transmitter's operating parameters including
 - range values,
 - output conformity,
 - damping time,
 - tag number (ID), and more
- **Monitor:** Read the input pressure to the transmitter in engineering units and the transmitter's output in percent.
- **Display:** Retrieve and display data from the transmitter or SFC memory.
- **Change Mode of Operation:** Tell transmitter to operate in either its analog (4-20 mA) mode or its digital enhanced (DE) mode.

Continued on next page

1.3 Smart Field Communicator, Continued

Purpose of SFC,
continued

- Check Current Output: Use the transmitter to supply the output current desired for verifying analog loop operation, troubleshooting, or calibrating other components in the analog loop.
- Troubleshoot: Check status of transmitter operation and display diagnostic messages to identify transmitter, communication, or operator error problems.

SFC model differences

As Honeywell’s family of Smartline Transmitters has evolved, the SFC has been changed to meet new model and functionality requirements. Besides different software versions, some major differences exist between these four SFC model designations.

- STS100
- STS101
- STS102
- STS103

Table 2 summarizes the differences between the four SFC models for reference.

Table 2 SFC Model Differences

If SFC model is. . .	Then it is compatible with. . .	And additional functions include . . .
STS100	Analog only ST 3000 smart pressure transmitters	Not applicable
STS101	Analog only ST 3000 smart pressure transmitters, if SFC software version is less than 5.0. Analog and Digital (DE) mode ST 3000 pressure transmitters and STT 3000 temperature transmitters, if SFC software version is 5.0 or greater.	Corrects Reset, Failsafe Direction and Sensor Temperature indication. Changing the mode from analog to digital or digital to analog, configuration parameters for STT 3000 and scratch pad configuration area for ST 3000.

Continued on next page

1.3 Smart Field Communicator, Continued

SFC model differences, continued

Table 2 SFC Model Differences, continued

If SFC model is . . .	Then it is compatible with. . .	And additional functions include . . .
STS102	Analog and Digital (DE) mode ST 3000 pressure transmitters, STT 3000 temperature transmitters, and MagneW 3000 electromagnetic flowmeters.	Changing the mode from analog to digital or digital to analog. Configuration parameters for Magnew 3000 as well as scratch pad configuration area.
STS103	<p>Same as STS102 plus new multivariable transmitters - SCM 3000 Smart Coriolis Flowmeter and SGC 3000 Smart Gas Chromatograph.</p> <p>SMV 3000 Smart Multivariable Transmitters, if SFC software version is 4.2 or greater.</p> <p>SMV 3000 with superheated steam algorithm and thermocouple input, if SFC software version is 4.4 or greater.</p> <p>Release 300 Series 100 and 900 ST 3000 pressure transmitters, if SFC software version is 5.0 or greater.</p>	<p>Two-line, 16-character per line display. Made "SAVE" and "RESTORE" functions part of configuration menu instead of dedicated keys. Configuration parameters for SCM 3000 and SGC 3000.</p> <p>Configuration parameters for SMV 3000</p> <p>SMV 3000 configuration parameters for superheated steam algorithm and thermocouple inputs.</p> <p>Local Smart Meter configuration parameters.</p>

ATTENTION

The keystroke actions and prompt displays referenced in this manual are for the SFC model STS103. While the SFC model STS103 does have a two-line instead of a one-line display, many of the basic keystrokes and configuration parameter prompts for ST 3000 pressure transmitters are identical to those in the model STS102.

If you will be using a model STS102 SFC, you must refer to the *SFC Smart Field Communicator Operating Guide 34-ST-11-10* for keystroke details. But, be aware that transmitter functions will be limited to only those that are supported by the Model STS102 SFC.

1.4 Transmitter/SFC Order

Order components Figure 5 shows the components that would be shipped and received for a typical ST 3000 transmitter and SFC order.

Figure 5 Typical ST 3000 Transmitter and SFC Order Components.

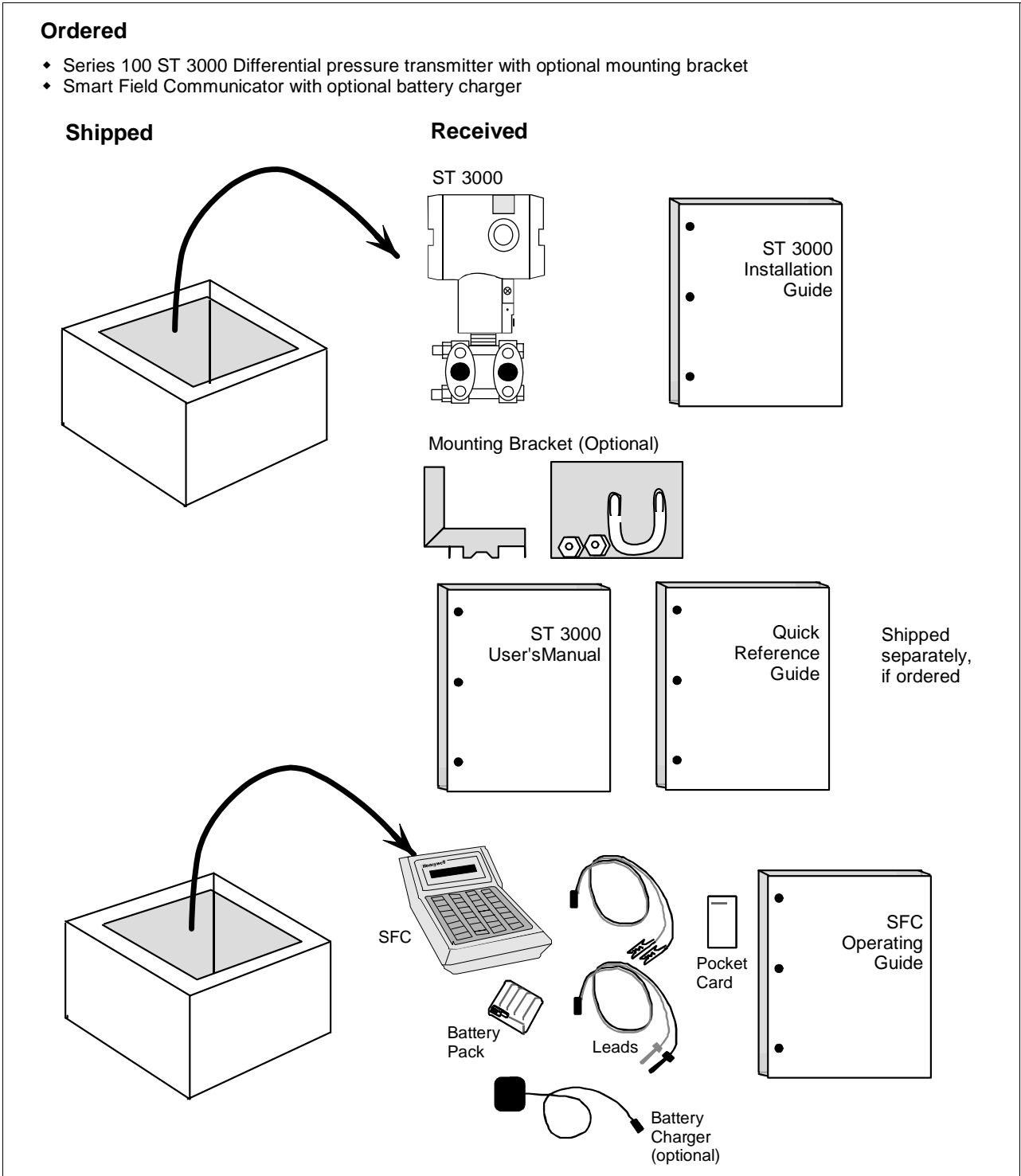

Continued on next page

1.4 Transmitter/SFC Order, Continued

About documentation Various documents are available for reference describing how to install, configure and operate the ST 3000 transmitter:

- *ST 3000 Smart Transmitter Installation Guide Using SFC Model STS103 34-ST-33-39*: One copy is shipped with every transmitter. This document provides information for checking, installing, and wiring the ST 3000 transmitter for operation.
 - *ST 3000 Smart Transmitter and SFC Smart Field Communicator Model STS 103 User's Manual 34-ST-25-14*: One or more copies are sent to the address designated on the order when specified. This document provides detailed information for installing, wiring, configuring, starting up, operating, maintaining, and servicing the ST 3000 transmitter. This is the main reference manual for the ST 3000 transmitter and it overlaps some data in the previously listed Installation Guide 34-ST-33-39 and in the following Operating Guide 34-ST-11-14 to minimize cross reference.
 - *ST 3000 Smart Transmitter Quick Reference Guide 34-ST-09-06*: Shipped with User's Manual. This document provides abbreviated versions of procedures for installing, wiring, configuring, calibrating and troubleshooting the ST 3000 transmitter for quick reference.
 - *Smart Field Communicator Model STS103 Pocket Card 34-ST-11-15*: One card is shipped with every SFC. This card provides quick reference of keystroke actions for selected transmitter interface tasks.
 - *Smart Field Communicator Model STS103 Operating Guide 34-ST-11-14*: One copy is shipped with every SFC. This document provides detailed SFC information and keystroke actions for interfacing with these Honeywell Smartline Transmitters.
 - ST 3000 Smart Pressure Transmitter (Non Release 300 models)
 - STT 3000 Smart Temperature Transmitter
 - MagneW 3000 Smart Electromagnetic Flowmeter
 - SMV 3000 Smart Multivariable Transmitter
 - *Smartline Configuration Toolkit SCT 3000 Installation and Start-up Guide 34-ST-10-08*: One copy is shipped when the SCT 3000 software application is ordered.
-

1.5 Local Smart Meter Options

Option availability Depending upon your transmitter model, it can be equipped with one of the available Local Smart Meter and/or Zero and Span Adjust options as shown in Table 3.

Table 3 Local Smart Meter Available Options

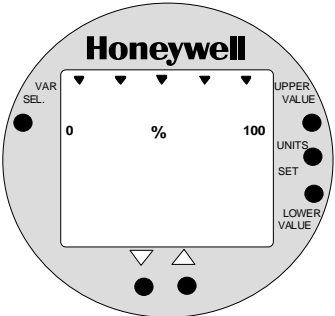
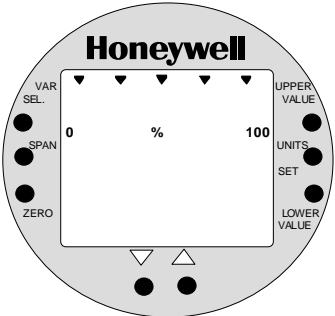
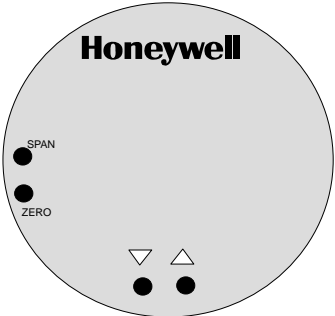
Option Description	Available with Transmitter Series	
	100	900
<p>Local Smart Meter only</p> 	Yes	Yes
<p>Local Smart Meter with Zero and Span Adjustments</p> 	Yes *	Yes
<p>Local Zero and Span Adjustments only</p> 	Yes *	Yes

* Except draft range, model STD110

Continued on next page

1.5 Local Smart Meter Options, Continued

About the options

Each Local Smart Meter and/or Zero and Span Adjust option comes as a separate assembly mounted on the transmitter's Printed Wiring Assembly (PWA) mounting bracket. The meter option assembly includes a cable and plug assembly for mating with a connector on the transmitter's PWA. A meter end-cap which includes a window is supplied on the electronics side of the transmitter's housing so you can view the meter display with the end cap installed. See Figure 6.

Figure 6 ST 3000 with Local Smart Meter Option.

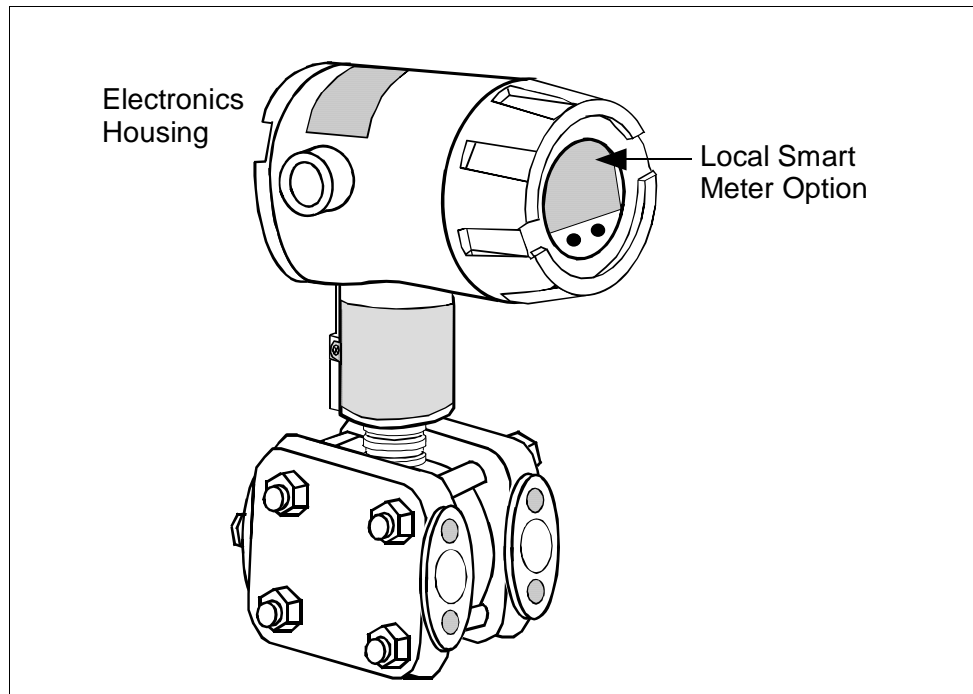

Section 2 —Quick Start Reference

2.1 Introduction

Section Contents This section includes these topics:

Section	Topic	See Page
2.1	Introduction	15
2.2	Getting ST 3000 Transmitter On-Line Quickly	16

About this section This section assumes that the ST 3000 transmitter has been installed and wired correctly, and is ready to be put into operation. It also assumes that you are somewhat familiar with using the SFC and that the transmitter has been configured correctly for your application. If the transmitter has not been installed and wired, you are not familiar with SFC operation, and/or you do not know if the transmitter is configured correctly, please read the other sections of this manual before starting up your transmitter.

This section provides a list of typical start-up tasks and tells you where you can find detailed information about performing the task.

2.2 Getting ST 3000 Transmitter On-Line Quickly

Quick start-up tasks

Table 4 lists common start-up tasks for an ST 3000 transmitter using an SFC and gives an appropriate section in this manual to reference for more information about how to do the task. The start-up tasks are listed in the order they are commonly completed.

Table 4 Start-up Tasks Reference

Task	Description	Reference Section
1	Put analog loop into manual mode.	Appropriate vendor documentation for controller or recorder used as a receiver in analog loop with ST 3000 transmitter.
2	Connect SFC to transmitter and establish communications.	5.2
3	Check or set tag ID.	6.3
4	Identify transmitter's mode of operation.	5.3
5	Change mode of operation, if required.	5.4
6	Check/set output form (Linear/Square Root).	6.4
7	Check/set damping time.	6.5
8	Check/set Lower Range Value and Upper Range Value.	6.7 (See 6.8 for local zero and span adjustments)
9	Run optional output check for analog loop.	7.3
10	Check zero input and set, if required.	7.4 - See Step 9 in Table 39. 7.8 - See Step 9 in Table 43.
11	Check transmitter status.	8.2
12	Setup local Smart Meter, if applicable.	6.11 or 6.12
13	Write data in scratch pad memory, if desired.	8.4
14	Store all changes in the transmitter's non-volatile memory by pressing [SHIFT] and [ENTER].	6.13

Section 3 —Preinstallation Considerations

3.1 Introduction

Section Contents This section includes these topics:

Section	Topic	See Page
3.1	Introduction	17
3.2	CE Conformity (Europe) Notice	18
3.3	Considerations for ST 3000 Transmitter	19
3.4	Considerations for SFC	22
3.5	Considerations for Local Smart Meter Option	24

About this section This section reviews things you should take into consideration before you install the transmitter and start using the SFC. Of course, if you are replacing an existing ST 3000 transmitter and you did not order a new SFC; you can skip this section.

3.2 CE Conformity (Europe) Notice

About conformity and special conditions

This product is in conformity with the protection requirements of **89/336/EEC**, the EMC Directive. Conformity of this product with any other “CE Mark” Directive(s) shall not be assumed.

Deviation from the installation conditions specified in this manual, and the following special conditions, may invalidate this product’s conformity with the EMC Directive.

- You must use shielded, twisted-pair cable such as Belden 9318 for all signal/power wiring.
 - You must connect the shield to ground at the power supply side of the wiring only and leave it insulated at the transmitter side.
-

ATTENTION

ATTENTION

The emission limits of EN 50081-2 are designed to provide reasonable protection against harmful interference when this equipment is operated in an industrial environment. Operation of this equipment in a residential area may cause harmful interference. This equipment generates, uses, and can radiate radio frequency energy and may cause interference to radio and television reception when the equipment is used closer than 30 meters (98 feet) to the antenna(e). In special cases, when highly susceptible apparatus is used in close proximity, the user may have to employ additional mitigating measures to further reduce the electromagnetic emissions of this equipment.

3.3 Considerations for ST 3000 Transmitter

Evaluate conditions

The ST 3000 transmitter is designed to operate in common indoor industrial environments as well as outdoors. To assure optimum performance, evaluate these conditions at the mounting area relative to published transmitter specifications and accepted installation practices for electronic pressure transmitters.

- Environmental Conditions
 - Ambient Temperature
 - Relative Humidity
- Potential Noise Sources
 - Radio Frequency Interference (RFI)
 - Electromagnetic Interference (EMI)
- Vibration Sources
 - Pumps
 - Motorized Valves
 - Valve Cavitation
- Process Characteristics
 - Temperature
 - Maximum Pressure Rating

Figure 7 illustrates typical mounting area considerations to make before installing a transmitter.

Figure 7 Typical Mounting Area Considerations Prior to Installation

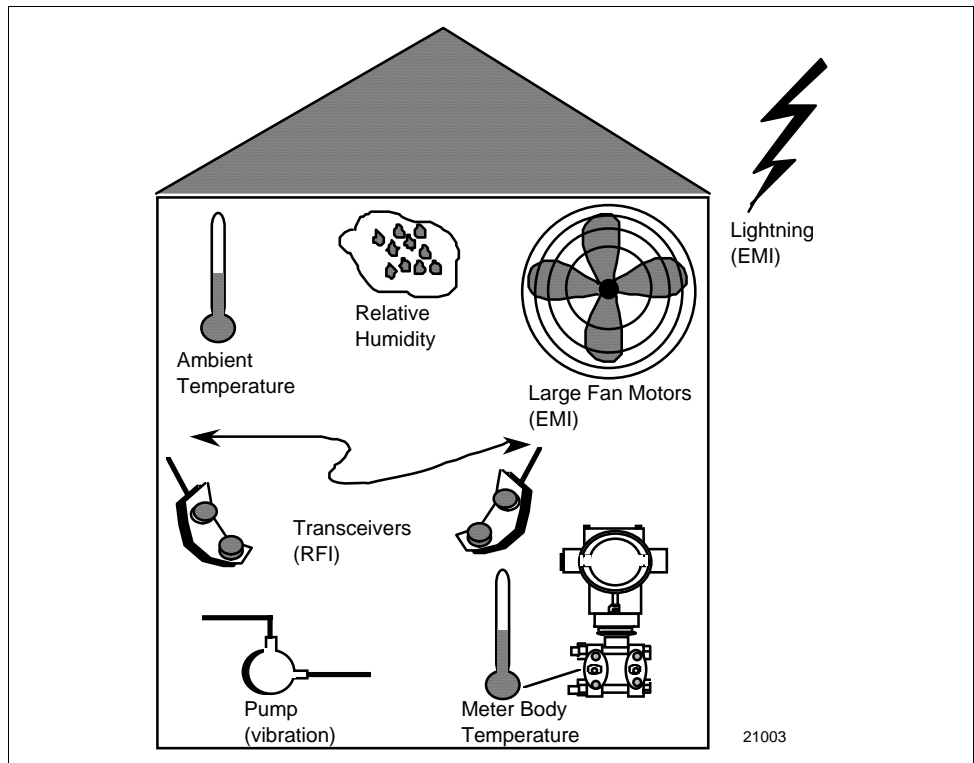

Continued on next page

3.3 Considerations for ST 3000 Transmitter, Continued

Temperature limits Table 5 lists the operating temperature limits for the various types of transmitters with silicone fill fluids. See transmitter specifications for temperature limits of ST 3000 transmitters with alternative fill fluids.

Table 5 Operating Temperature Limits (Transmitters with Silicone Fill Fluids)

Transmitter Type and Model	Ambient Temperature		Process Interface Temperature	
	°C	°F	°C	°F
<i>Draft Range</i> STD110	-40 to 70	-40 to 158	-40 to 70	-40 to 158
<i>Differential Pressure</i> STD125	-40 to 85	-40 to 185	-40 to 85	-40 to 185
STD120, STD130, STD170	-40 to 93	-40 to 200	-40 to 125	-40 to 257
STD904, STD924, STD930, STD974	-40 to 85	-40 to 185	-40 to 125	-40 to 257
<i>Gauge Pressure</i>				
STG140, STG170, STG180, STG14L, STG17L, STG18L	-40 to 93	-40 to 200	-40 to 125	-40 to 257
STG14T	-40 to 93	-40 to 200	-40 to 150 †	-40 to 302 †
STG93P	-15 to 65	5 to 149	-15 to 95 ††	5 to 203 ††
STG944, STG974	-40 to 85	-40 to 185	-40 to 125	-40 to 257
STG90L, STG94L, STG97L, STG98L	-40 to 85	-40 to 185	-40 to 110	-40 to 230
<i>Absolute Pressure</i> STA122/12L	-40 to 93	-40 to 200	See Specification Sheet	
STA140/14L	-40 to 93	-40 to 200	-40 to 80	-40 to 176
STA922/92L	-40 to 85	-40 to 185	See Specification Sheet	
STA940/94L	-40 to 85	-40 to 185	-40 to 80	-40 to 176
Flange Mounted				
STF128, STF132, STF924, STF932	-40 to 93	-40 to 200	-40 to 175	-40 to 350
Pseudo-Flanged Head				
STF12F, STF13F, STF92F, STF93F	-40 to 93	-40 to 200	-40 to 93	-40 to 200
STF14F	-40 to 85	-40 to 185	-40 to 85	-40 to 185
Gauge Pressure Flange Mount				
STF14T	-40 to 93	-40 to 200	-40 to 150 †	-40 to 302 †
<i>Remote Diaphragm Seals</i>				
STR12D, STR13D, STR14G, STR17G, STR14A	See Specification Sheet		See Specification Sheet	
STR93D, STR94G	-40 to 85	-40 to 185	See Specification Sheet	

† Process temperatures above 125 °C (257 °F) require a reduction in the maximum ambient temperature as follows:

Process Temperature	Ambient Temperature Limit
150 °C (302 °F)	50 °C (122 °F)
140 °C (284 °F)	60 °C (140 °F)
125 °C (257 °F)	85 °C (185 °F)

†† Process temperatures above 65 °C (149 °F) require a 1:1 reduction in maximum ambient temperature.

NOTE: For transmitters with local meter option see Table 8.

NOTE: Transmitters with other fill fluids (CTFE, Neobee, Etc.) have different Operating Temperature Limits. For more specific information, refer to the appropriate Specification and Model Selection Guide or transmitter nameplate

3.3 Considerations for ST 3000 Transmitter, Continued

Pressure ratings Table 6 lists maximum working pressure for a given transmitter Upper Range Limit (URL).

The maximum allowable working pressure (MAWP) is the pressure used for the approval body safety calculations.

Table 6 Transmitter Maximum Allowable Working Pressure (MAWP) Ratings

Transmitter Type	Upper Range Limit (URL)	MAWP
Draft Range	10 inches H ₂ O (25 mbar)	50 psi (3.5 bar)
Differential Pressure	400 inches H ₂ O (1 bar)	3000 psi (210 bar)
	100 psi (7 bar)	3000 psi (210 bar)
	3000 psi (210 bar)	3000 psi (210 bar)
Gauge Pressure	100 psi (7 bar)	100 psi (7 bar)
	300 psi (21 bar)	300 psi (21 bar)
	500 psi (35 bar)	500 psi (35 bar)
	3000 psi (210 bar)	3000 psi (210 bar)
	6000 psi (415 bar)	6000 psi (415 bar)
	10000 psi (690 bar)	10000 psi (690 bar)
Flange Mount	400 inches H ₂ O (1 bar)	Per selected flange and material (ANSI/ASME 150#, 300#, DN PN40)
	100 psi (7 bar)	
Remote Seal	400 inches H ₂ O (1 bar)	Lesser MAWP of either Remote Seal selected or transmitter pressure rating
	100 psi (7 bar)	
Absolute Pressure	780 mmHg Absolute (1 bar)	780 mmHg Absolute (1 bar)
	500 psia (35 bar)	500 psia (35 bar)

Note: Maximum Allowable Working Pressure (MAWP) may vary with materials of construction and process temperature. For more specific information, refer to the appropriate Specification and Model Selection Guide or transmitter nameplate

NOTE: To convert bar values to kilopascals (kPa), multiply by 100.

For example, 3.5 bar equals 350 kPa.

3.4 Considerations for SFC

Install SFC battery pack

If the SFC battery pack was removed for shipping and/or storage, you will have to install the battery pack and charge the batteries before you can operate the SFC.

The procedure in Table 7 outlines the steps for the battery pack.

Table 7 Installing and Charging SFC Battery Pack

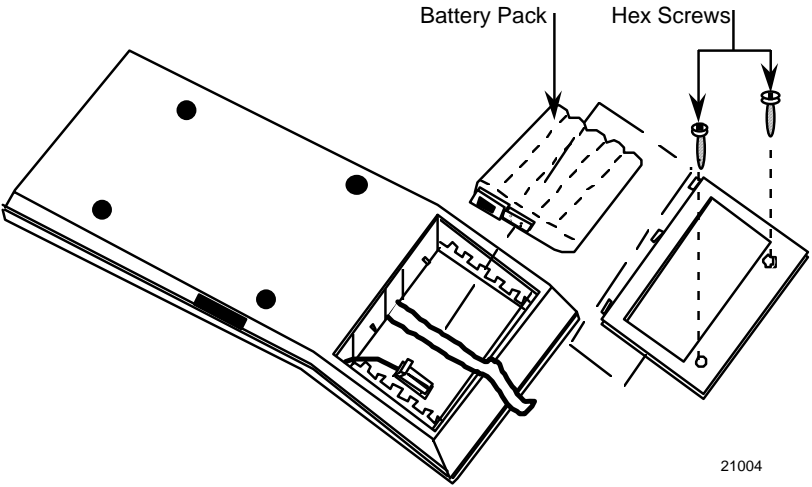
Step	Action
1	Turn SFC face down on working surface. Use metric hex wrench (2.5 mm) to remove screws in battery compartment cover and remove cover.
2	Insert battery pack in compartment and connect plug in compartment to pin on battery back Example - Battery pack installation. 
3	Replace cover and tighten hex screws
4	Connect lead from battery charger to recessed connector on left side of SFC. WARNING The SFC battery charger is not intrinsically safe. Always recharge the SFC battery pack in a nonhazardous location. The SFC itself is an intrinsically safe device.

Continued on next page

3.4 Considerations for SFC, Continued

Install SFC battery pack, continued

Table 7 Installing and Charging SFC Battery Pack, continued

Step	Action								
5	<p data-bbox="643 443 1446 562">Plug battery charger into any standard 120 Vac outlet or universal-European 240 Vac outlet as applicable for charger power rating. If 240 Vac charger is supplied with stripped leads instead of universal-European plug, lead identification for 240 Vac charger is as follows.</p> <table border="1" data-bbox="686 573 1414 716"> <thead> <tr> <th data-bbox="686 573 1049 611">Lead Color...</th> <th data-bbox="1049 573 1414 611">Function...</th> </tr> </thead> <tbody> <tr> <td data-bbox="686 611 1049 646">Blue</td> <td data-bbox="1049 611 1414 646">Neutral</td> </tr> <tr> <td data-bbox="686 646 1049 682">Brown</td> <td data-bbox="1049 646 1414 682">Hot</td> </tr> <tr> <td data-bbox="686 682 1049 716">Green/Yellow</td> <td data-bbox="1049 682 1414 716">Ground</td> </tr> </tbody> </table> <p data-bbox="643 751 1430 863">ATTENTION It takes up to 16 hours to fully recharge the battery pack and you can use the SFC continuously for up to 24 hours before the battery pack needs recharging.</p>	Lead Color...	Function...	Blue	Neutral	Brown	Hot	Green/Yellow	Ground
Lead Color...	Function...								
Blue	Neutral								
Brown	Hot								
Green/Yellow	Ground								

Temperature Limits

The ambient operating temperature limits for the SFC are –10 to 50°C (14 to 122°F) with relative humidity in the range of 10 to 90% RH.

Usage guidelines

- For transmitters operating in the Analog Mode, be sure to put an analog control loop into its manual mode before initiating SFC communications with the transmitter. Also, be sure any switches that may trip alarms or interlocks associated with the analog loop are secured or turned OFF. Communication superimposes digital signals on the loop wiring that could affect the analog control signal.
- Be sure the power supply voltage does not exceed 45Vdc. The ST 3000 transmitter and SFC were designed to operate with voltages below 45Vdc.
- Be sure there is at least 250 ohms of resistance between the SFC and the power supply for proper communications.

3.5 Considerations for Local Smart Meter Option

Reference specifications

Table 8 lists pertinent Smart Meter specifications for reference.

Table 8 Local Smart Meter Specifications.

<i>Operating Conditions</i> _____			
Parameter		Rated	Extreme, Transportation and Storage
Ambient Temperature	°F	-40 to 176	-58 to 194
	°C	-40 to 80	-50 to 90
Relative Humidity	%RH	10 to 90	0 to 100
<i>Design</i> _____			
Accuracy		No error. Reproduces transmitter signal exactly within its resolution.	
Display Resolution	Bargraph	±3% of reading	Shown as:
	Digital Readout	±0.005 for ±19.99 reading range, ±0.05 for ±199.9 reading range, ±0.5 for ±1999 reading range, ±5 for ±19990 reading range, ±50 for ±199900 reading range, ±500 for ±1999000 reading range, ±5000 for ±19990000 reading range.	
Display Update Rate		Above 32°F (0°C): ½ second @ or below 32°F (0°C): 1½ seconds	

Meter Display at High and Low Temperature Extremes

The rated temperature limits for the local meter are listed above and are true in that no damage to the meter will occur over these temperatures, however the readability of the LCD is affected if taken to these temperature extremes:

- The LCD will turn black at some temperature between 80 to 90 °C (176 and 194 °F), rendering the display unreadable. This effect is only temporary, and normally occurs at 90 °C (194 °F).
- At low temperatures, the update rate of the display is lengthened to 1.5 seconds due to the slower response time of the display. At -20 °C (-4 °F) the display becomes unreadable due to slow response of the LCD. This is also only temporary and normal readability will return when temperature returns above -20 °C (-4 °F).

Section 4 —Installation

4.1 Introduction

Section Contents This section includes these topics:

Section	Topic	See Page
4.1	Introduction	25
4.2	Mounting ST 3000 Transmitter.....	26
4.3	Piping ST 3000 Transmitter.....	36
4.4	Wiring ST 3000 Transmitter	41

About this section This section provides information about installing the ST 3000 transmitter. It includes procedures for mounting, piping and wiring the transmitter for operation.

4.2 Mounting ST 3000 Transmitter

Summary

You can mount all transmitter models (except flush mount models and those with integral flanges) to a 2-inch (50 millimeter) vertical or horizontal pipe using our optional angle or flat mounting bracket, or a bracket of your own. Flush mount models are mounted directly to the process pipe or tank by a 1" weld nipple. Those models with integral flanges are supported by the flange connection.

Figure 8 shows typical bracket mounted and flange mounted transmitter installations for comparison.

Figure 8 Typical Bracket Mounted and Flange Mounted Installations

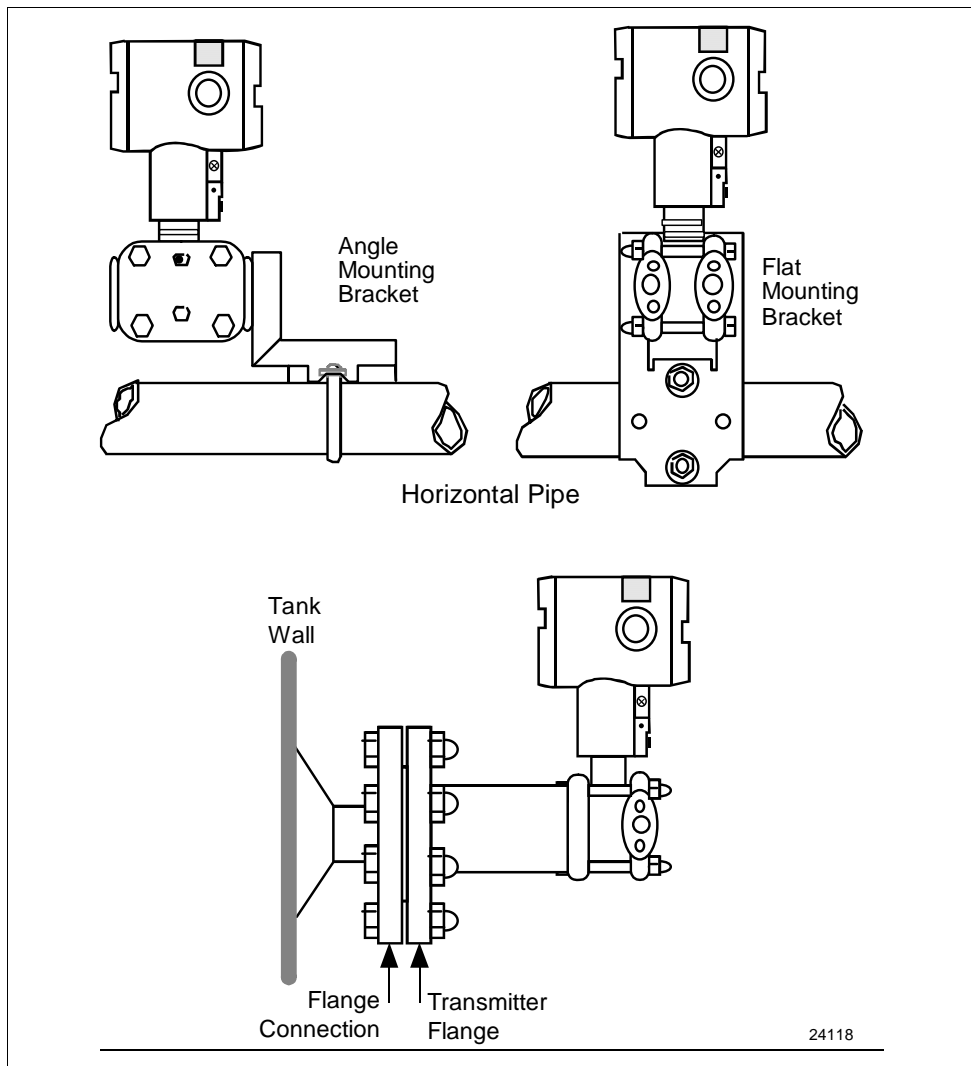

Continued on next page

4.2 Mounting ST 3000 Transmitter, Continued

Dimensions

Detailed dimension drawings for given transmitter series and types are listed in the back of the Installation Guide (Part number 34-ST-33-39) for reference. Note that abbreviated overall dimensions are also shown in the Specification Sheets for the given transmitter models.

This section assumes that the mounting dimensions have already been taken into account and the mounting area can accommodate the transmitter.

Bracket mounting

Table 9 summarizes typical steps for mounting a transmitter to a bracket.

Table 9 Mounting ST 3000 Transmitter to a Bracket

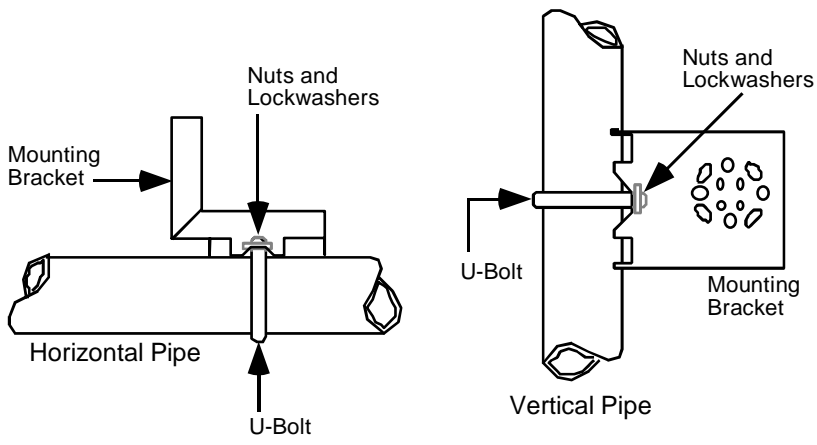
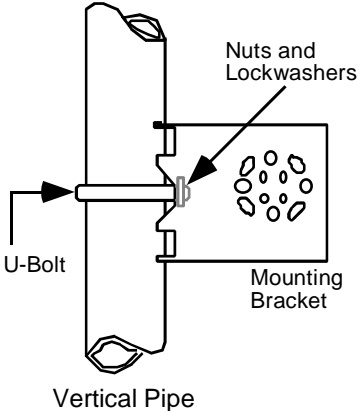
Step	Action						
1	<table border="1" style="width: 100%; border-collapse: collapse;"> <thead> <tr> <th data-bbox="686 905 1040 940">If you are using an...</th> <th data-bbox="1040 905 1414 940">Then...</th> </tr> </thead> <tbody> <tr> <td data-bbox="686 940 1040 976">optional mounting bracket</td> <td data-bbox="1040 940 1414 976">go to Step 2.</td> </tr> <tr> <td data-bbox="686 976 1040 1012">existing mounting bracket</td> <td data-bbox="1040 976 1414 1012">go to Step 3.</td> </tr> </tbody> </table>	If you are using an...	Then...	optional mounting bracket	go to Step 2.	existing mounting bracket	go to Step 3.
If you are using an...	Then...						
optional mounting bracket	go to Step 2.						
existing mounting bracket	go to Step 3.						
2	<p>Position bracket on 2-inch (50.8 mm) horizontal or vertical pipe, and install "U" bolt around pipe and through holes in bracket. Secure with nuts and lockwashers provided.</p> <p>Example - Angle mounting bracket secured to horizontal or vertical pipe.</p> <div style="display: flex; justify-content: space-around; align-items: center;">   </div>						

Continued on next page

4.2 Mounting ST 3000 Transmitter, Continued

Bracket mounting,
continued

Table 9 Mounting ST 3000 Transmitter to a Bracket, continued

Step	Action										
3	<p>Align appropriate mounting holes in transmitter with holes in bracket and secure with bolts and washers provided.</p> <table border="1" data-bbox="639 527 1365 963"> <thead> <tr> <th data-bbox="644 533 1003 569">If transmitter is ...</th> <th data-bbox="1008 533 1360 569">Then ...</th> </tr> </thead> <tbody> <tr> <td data-bbox="644 575 1003 674">DP type with double ended process heads and/or remote seals</td> <td data-bbox="1008 575 1360 674">use alternate mounting holes in end of heads.</td> </tr> <tr> <td data-bbox="644 680 1003 747">GP and AP with single-ended head</td> <td data-bbox="1008 680 1360 747">use mounting holes in side of meter body.</td> </tr> <tr> <td data-bbox="644 753 1003 890">In-line GP and AP (STGxxL and STAxL)</td> <td data-bbox="1008 753 1360 890">use smaller "U" bolt provided to attach meter body to bracket. See figure below.</td> </tr> <tr> <td data-bbox="644 896 1003 963">Dual-head GP and AP</td> <td data-bbox="1008 896 1360 963">use mounting holes in end of process head.</td> </tr> </tbody> </table> <p data-bbox="594 1010 1318 1073">Example – In-line model transmitter mounted to optional angle mounting bracket.</p> <div data-bbox="743 1081 1279 1619" data-label="Diagram"> <p style="text-align: center;">In-line models</p> </div> <p data-bbox="594 1682 1386 1774">NOTE: If the meter body is hexagonal, you must use the additional bracket supplied. If meter body is round, discard the bracket.</p>	If transmitter is ...	Then ...	DP type with double ended process heads and/or remote seals	use alternate mounting holes in end of heads.	GP and AP with single-ended head	use mounting holes in side of meter body.	In-line GP and AP (STGxxL and STAxL)	use smaller "U" bolt provided to attach meter body to bracket. See figure below.	Dual-head GP and AP	use mounting holes in end of process head.
If transmitter is ...	Then ...										
DP type with double ended process heads and/or remote seals	use alternate mounting holes in end of heads.										
GP and AP with single-ended head	use mounting holes in side of meter body.										
In-line GP and AP (STGxxL and STAxL)	use smaller "U" bolt provided to attach meter body to bracket. See figure below.										
Dual-head GP and AP	use mounting holes in end of process head.										

Continued on next page

4.2 Mounting ST 3000 Transmitter, Continued

Bracket mounting,
continued

Table 9 Mounting ST 3000 Transmitter to a Bracket, continued

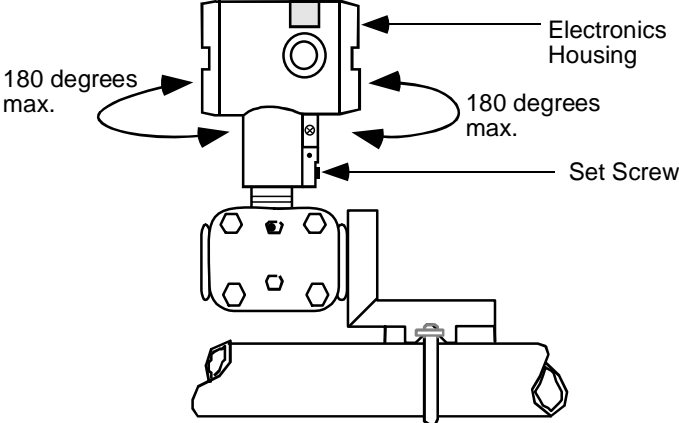
4	<p>Loosen set screw on outside neck of transmitter one full turn. Rotate electronics housing a maximum of 180 degrees in left or right direction from center to the position you require and tighten set screw (13 to 15 lb-in/1.46 to 1.68 N·m).</p> <p>Example - Rotating electronics housing.</p>  <p>ATTENTION The metric socket head wrench kit supplied with the SFC includes 2.5, 3, and 4mm size wrenches. You will need the 4mm size wrench for the outside set screw.</p>
---	---

Continued on next page

4.2 Mounting ST 3000 Transmitter, Continued

ATTENTION

The mounting position of a model STA122, STA922, STA12L, or STA92L Absolute Pressure Transmitter or a model STD110 Draft Range Differential Pressure Transmitter is critical as the transmitter spans become smaller. A maximum zero shift of 2.5 mm Hg for an absolute transmitter or 1.5 inH₂O for a draft range transmitter can result from a mounting position which is rotated 90 degrees from vertical. A typical zero shift of 0.12 mm Hg or 0.20 in H₂O can occur for a 5 degree rotation from vertical.

Precautions for Mounting Transmitters with Small Absolute or Differential Pressure Spans

To minimize these positional effects on calibration (zero shift), take the appropriate mounting precautions that follow for the given transmitter model.

For a model STA122, STA922, STA12L, or STA92L transmitter, you must ensure that the transmitter is vertical when mounting it. You do this by leveling the transmitter side-to-side and front-to-back. See Figure 9 for suggestions on how to level the transmitter using a spirit balance.

Figure 9 Leveling an Absolute Pressure Transmitter.

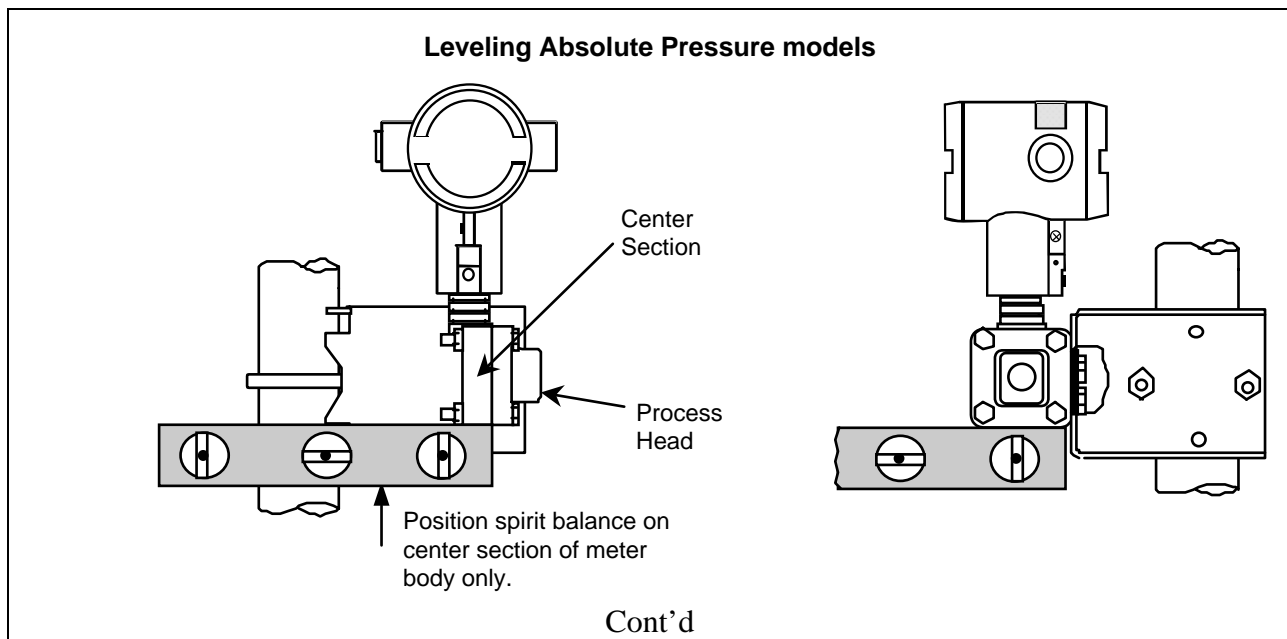

Continued on next page

4.2 Mounting ST 3000 Transmitter Continued

Figure 9 Leveling an Absolute Pressure Transmitter (cont'd)

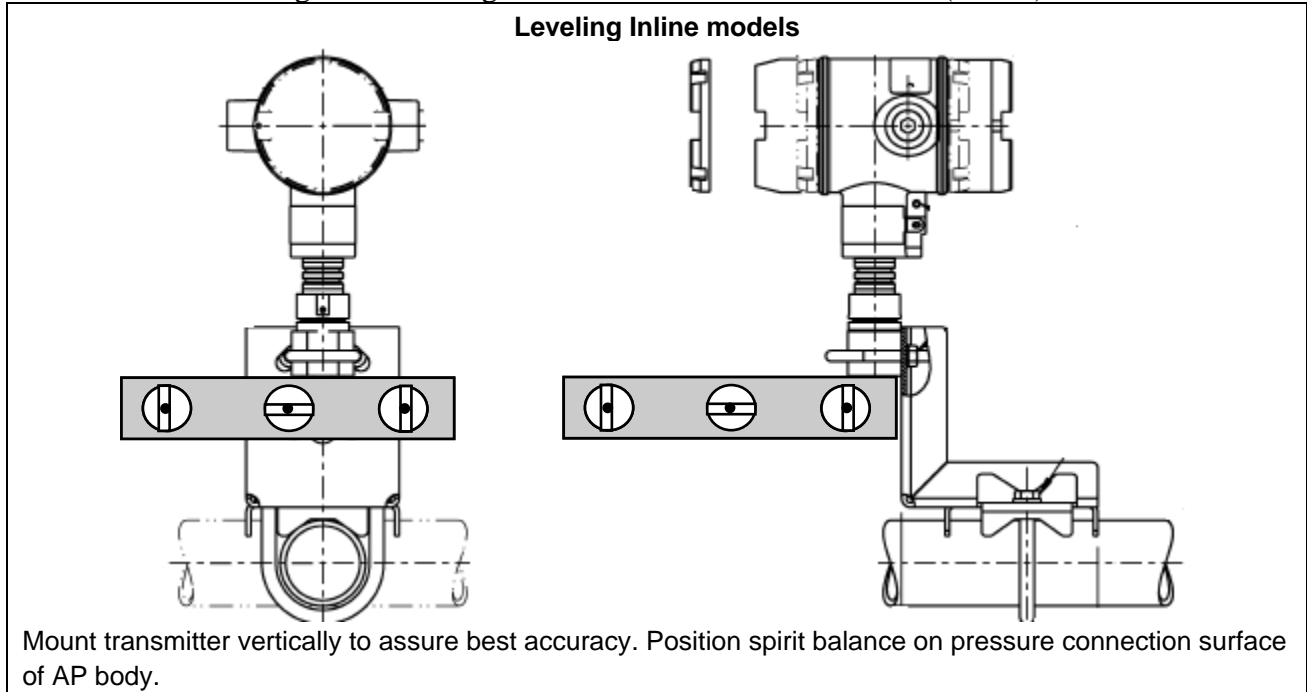





4.2 Mounting ST 3000 Transmitter, Continued

Precautions for Mounting Transmitters with Small Absolute or Differential Pressure Spans, continued

For a transmitter with a small differential pressure span, you must ensure that the transmitter is vertical when mounting it. You do this by leveling the transmitter side-to-side and front-to-back. See Figure 9 for suggestions on how to level the transmitter using a spirit balance. You must also zero the transmitter by following the steps in Table 10 below.

Table 10 Zero Corrects Procedure for STD110

Step	Action
1	Attach the transmitter to the mounting bracket but do not completely tighten the mounting bolts
2	Connect a tube between the input connections in the high pressure (HP) and low pressure (LP) heads to eliminate the affects of any surrounding air currents.
3	Connect 24 Vdc power to the transmitter and connect a digital voltmeter or SFC to read the transmitter's output. See Figures 18 and 38 for typical SFC connection or connect a voltmeter across the 250 ohm resistor, if desired.
4	Use the SFC and establish communications with the transmitter. Follow the steps in Table 17, if needed.
5	While reading the transmitter's output on an SFC or a voltmeter, position the transmitter so the output reading is at or near zero and then completely tighten the mounting bolts.
6	Perform an input zero correct function using the SFC and following the steps below. This corrects the transmitter for any minor error that may occur after the mounting bolts are tightened.
7	<p>Initiate shift key selection. Press  key</p> <p>Press  key. Read applied input pressure.</p> <p>Press  key. Prompt asks if the applied input pressure equals zero input. If it is zero input, go to next keystroke. If it is not, press [CLR] key to exit function and repeat keystrokes.</p> <p>Press  key. Zero input is set equal to applied input pressure.</p>
8	Remove the tube from between the input connections, the power, and the digital voltmeter or SFC.
9	Continue with the remaining installation tasks.

Continued on next page

4.2 Mounting ST 3000 Transmitter, Continued

Flange mounting

To mount a flange mounted transmitter model, bolt the transmitter's flange to the flange pipe on the wall of the tank.

ATTENTION

On insulated tanks, remove enough insulation to accommodate the flange extension.

Figure 10 shows a typical installation for a transmitter with the flange on the high pressure (HP) side so the HP diaphragm is in direct contact with the process fluid. The low pressure (LP) side of the transmitter is vented to atmosphere (no connection).

It is the End User's responsibility to provide a flange gasket and mounting hardware that are suitable for the transmitter's service condition.

To prevent degradation of performance in Flush-Mounted Flanged Transmitters, exercise care to ensure that the internal diameter of the flange gasket does not obstruct the sensing diaphragm.

To prevent degradation of performance in Extended Mount Flanged Transmitters, ensure that there is sufficient clearance in front of the sensing diaphragm body.

Figure 10 Typical Flange Mounted Transmitter Installation

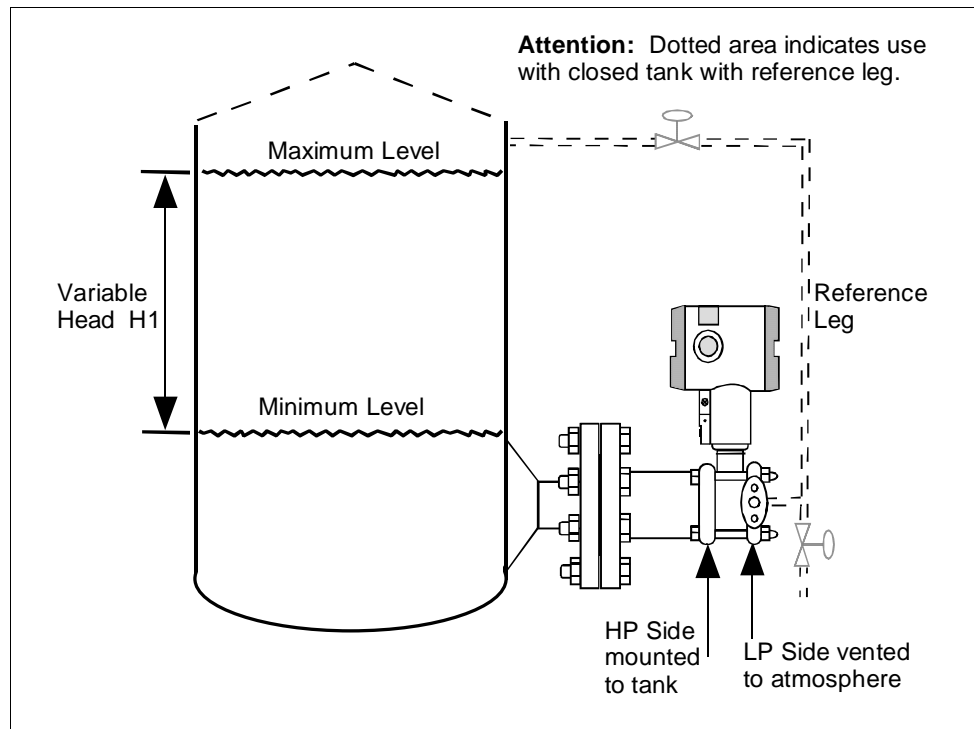

Continued on next page

4.2 Mounting ST 3000 Transmitter, Continued

Flush mounting

To mount a flush mounted model, cut a hole for a 1" standard pipe in the tank or pipe where the transmitter is to be mounted. Weld the 1" mounting sleeve to the wall of the tank or to the hole cut on the pipe. Insert the meter body of the transmitter into the mounting sleeve and secure with the locking bolt. Tighten the bolt to a torque of 6,4 Nm +/- 0,30 Nm (4.7 ft-lbs +/- 0.2 ft.-lbs.). Figure 11 shows a typical installation for a transmitter with a flush mount on a pipe.

Once the transmitter is mounted, the electronics housing can be rotated to the desired position. See Table 9, Step 4 for details.

ATTENTION

On insulated tanks, remove enough insulation to accommodate the mounting sleeve.

Figure 11 Typical Flush Mounted Transmitter Installation

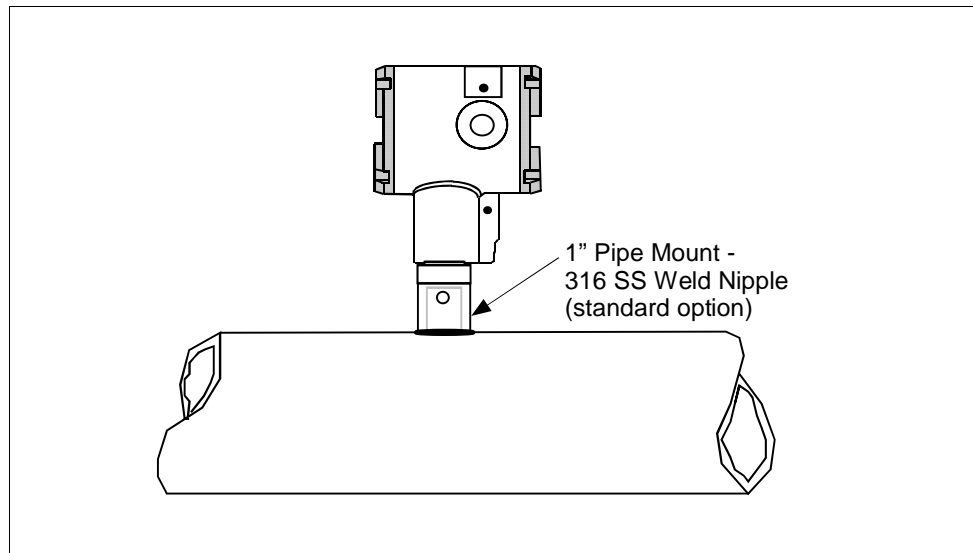

Continued on next page

4.2 Mounting ST 3000 Transmitter, Continued

High Temperature Transmitter Mounting

You can mount the High Temperature transmitter directly to the process flange connection or the process piping. Figure 12 shows typical pipe and flange mounted transmitter installations for comparison.

To mount a flange mounted transmitter model, bolt the transmitter's flange to the flange on the wall of the tank or process pipe.

It is the End User's responsibility to provide a flange gasket and mounting hardware that are suitable for the transmitter's service condition.

Once the transmitter is mounted, the electronics housing can be rotated to the desired position. See Table 9, step 4.

ATTENTION

On insulated tanks, remove enough insulation to accommodate the flange extension.

Figure 12 Typical Pipe and Flange Mounted Installations

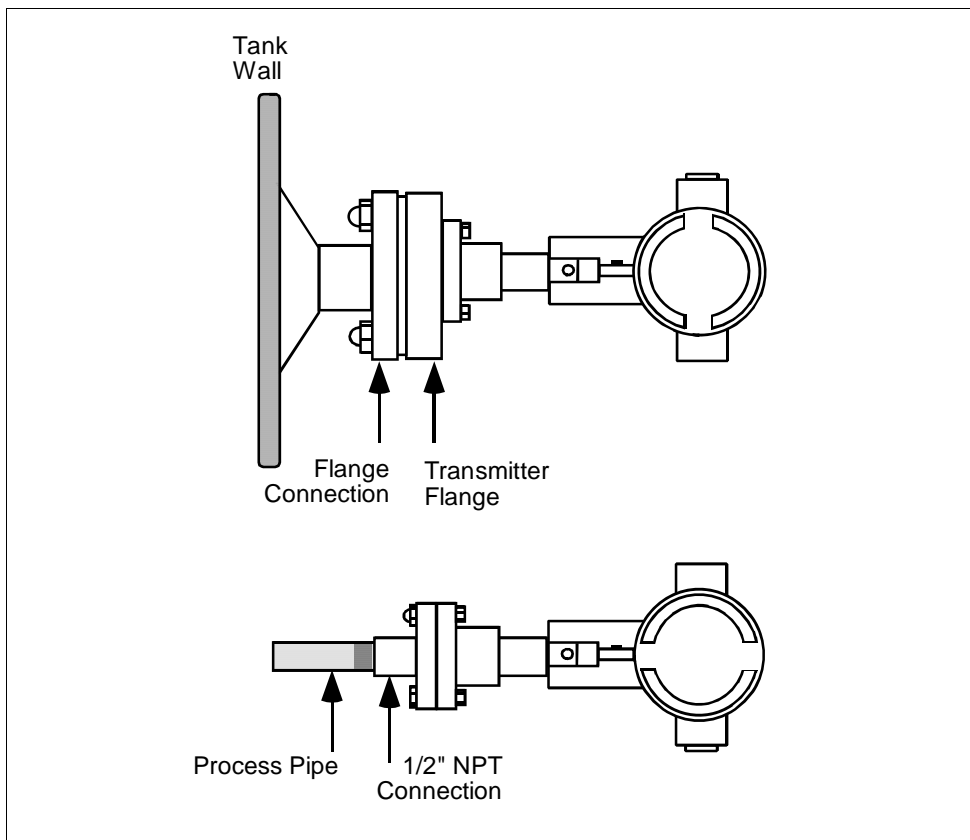

Continued on next page

4.2 Mounting ST 3000 Transmitter, Continued

Remote seal mounting

Use the procedure in Table 11 to mount a remote diaphragm seal transmitter model. Figure 13 shows a typical installation for a remote diaphragm seal transmitter for reference.

WARNING

Mount the transmitter flanges within the limits stated here for the given fill-fluid in the capillary tubes with a tank at one atmosphere.

IF the fill fluid is...	THEN mount the flange...
Silicone DC 200 Oil	no greater than 22 feet (6.7 meters) below the transmitter
Silicone DC 704 Oil	no greater than 19 feet (5.8 meters) below the transmitter
Chlorotrifluorethylene	no greater than 11 feet (3.4 meters) below the transmitter.

NOTE: The combination of tank vacuum and high pressure capillary head effect should not exceed 9 psi (300 mm Hg) absolute.

Table 11 Mounting Remote Diaphragm Seal Transmitter

Step	Action						
1	Mount transmitter at a remote distance determined by length of capillary tubing.						
2	<table border="1" style="margin-left: 20px;"> <thead> <tr> <th>If Transmitter Model Number is...</th> <th>Then Connect Remote Seal on...</th> </tr> </thead> <tbody> <tr> <td>STR93D or STR12D</td> <td>high pressure (HP) side of transmitter to lower flange mounting on tank wall for variable head H1.</td> </tr> <tr> <td>STR13D</td> <td>low pressure (LP) side of transmitter to lower flange mounting on tank wall for variable head H1.</td> </tr> </tbody> </table> <p>ATTENTION On insulated tanks, remove enough insulation to accommodate the flange extension.</p>	If Transmitter Model Number is...	Then Connect Remote Seal on...	STR93D or STR12D	high pressure (HP) side of transmitter to lower flange mounting on tank wall for variable head H1.	STR13D	low pressure (LP) side of transmitter to lower flange mounting on tank wall for variable head H1.
If Transmitter Model Number is...	Then Connect Remote Seal on...						
STR93D or STR12D	high pressure (HP) side of transmitter to lower flange mounting on tank wall for variable head H1.						
STR13D	low pressure (LP) side of transmitter to lower flange mounting on tank wall for variable head H1.						

Continued on next page

4.2 Mounting ST 3000 Transmitter, Continued

Remote seal mounting, continued

Table 11 Mounting Remote Diaphragm Seal Transmitter, continued

Step	Action						
3	<table border="1"> <thead> <tr> <th>If Transmitter Model Number is...</th> <th>Then Connect Remote Seal on...</th> </tr> </thead> <tbody> <tr> <td>STR93D or STR12D</td> <td>low pressure (LP) side of transmitter to upper flange mounting on tank wall for fixed or constant head H2.</td> </tr> <tr> <td>STR13D</td> <td>high pressure (HP) side of transmitter to upper flange mounting on tank wall for fixed or constant head H2.</td> </tr> </tbody> </table>	If Transmitter Model Number is...	Then Connect Remote Seal on...	STR93D or STR12D	low pressure (LP) side of transmitter to upper flange mounting on tank wall for fixed or constant head H2.	STR13D	high pressure (HP) side of transmitter to upper flange mounting on tank wall for fixed or constant head H2.
	If Transmitter Model Number is...	Then Connect Remote Seal on...					
	STR93D or STR12D	low pressure (LP) side of transmitter to upper flange mounting on tank wall for fixed or constant head H2.					
STR13D	high pressure (HP) side of transmitter to upper flange mounting on tank wall for fixed or constant head H2.						
<p>ATTENTION On insulated tanks, remove enough insulation to accommodate the flange extension.</p>							
4	It is the End User's responsibility to provide a flange gasket and mounting hardware that are suitable for the transmitter's service condition						

Figure 13 Typical Remote Diaphragm Seal Transmitter Installation.

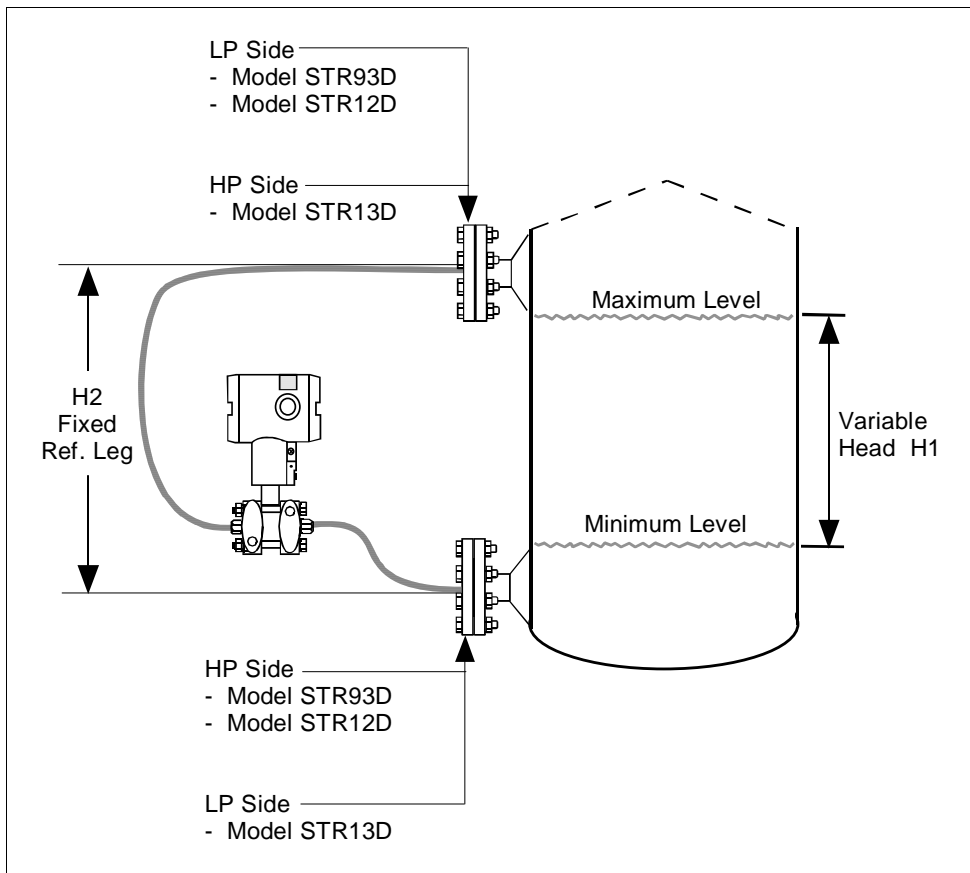

4.3 Piping ST 3000 Transmitter

Piping arrangements

The actual piping arrangement will vary depending upon the process measurement requirements and the transmitter model. Except for flanged and remote diaphragm seal connections, process connections are made to $\frac{1}{4}$ inch or $\frac{1}{2}$ inch NPT female connections in the process head of the transmitter's meter body. For example, a differential pressure transmitter comes with double-ended process heads with $\frac{1}{4}$ inch NPT connections but they can be modified to accept $\frac{1}{2}$ inch NPT through optional flange adapters. Some gauge pressure transmitters may have a $\frac{1}{2}$ inch NPT connection which mounts directly to a process pipe.

The most common type of pipe used is $\frac{1}{2}$ inch schedule 80 steel pipe. Many piping arrangements use a three-valve manifold to connect the process piping to the transmitter. A manifold makes it easy to install and remove or rezero a transmitter without interrupting the process. It also accommodates the installation of blow-down valves to clear debris from pressure lines to the transmitter.

Figure 14 shows a diagram of a typical piping arrangement using a three-valve manifold and blow-down lines for a differential pressure transmitter being used to measure flow.

Figure 14 Typical 3-Valve Manifold and Blow-Down Piping Arrangement.

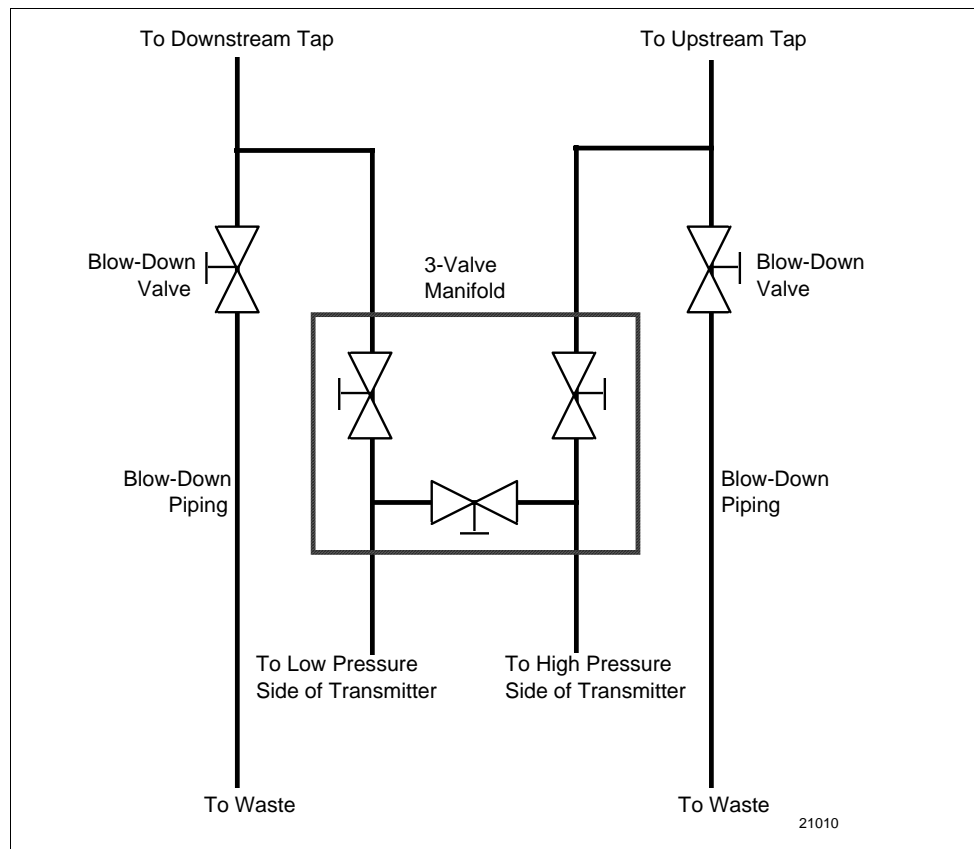

Continued on next page

4.3 Piping ST 3000 Transmitter, Continued

Piping arrangements, continued Another piping arrangement uses a block-off valve and a tee connector in the process piping to the transmitter as shown in Figure 15.

Figure 15 Typical Piping Arrangement for 1/2" NPT Process Connection

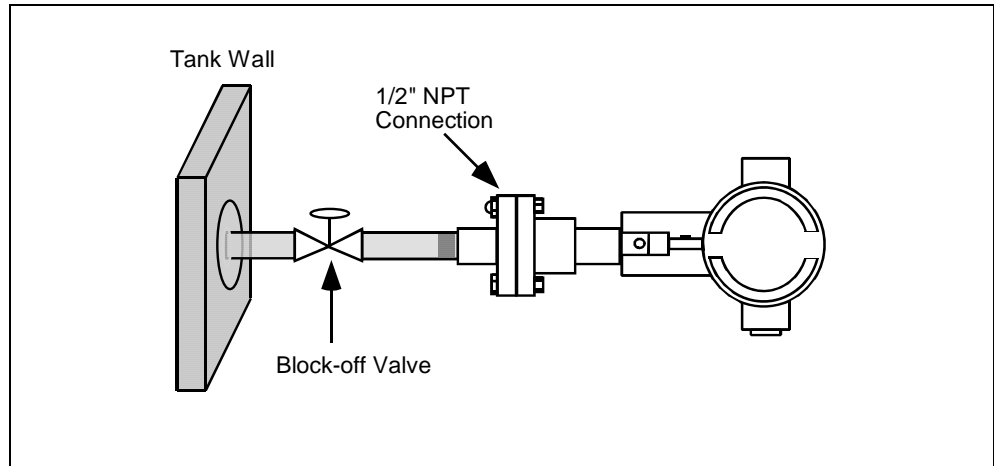

Transmitter location Table 12 lists the mounting location for the transmitter depending on the process.

Table 12 Suggested Transmitter Location for Given Process

Process	Suggested Location	Explanation
Gases	Above the gas line	The condensate drains away from the transmitter.
Liquids	<ol style="list-style-type: none"> Below but close to the elevation of the process connection. Level with or above the process connection. 	<ol style="list-style-type: none"> This minimizes the static head effect of the condensate. This requires a siphon to protect the transmitter from process steam. The siphon retains water as a "fill fluid."

ATTENTION

For liquid or steam, the piping should slope a minimum of 25.4 mm (1 inch) per 305 mm (1 foot). Slope the piping down towards the transmitter if the transmitter is below the process connection so the bubbles may rise back into the piping through the liquid. If the transmitter is located above the process connection, the piping should rise vertically above the transmitter; then slope down towards the flowline with a vent valve at the high point. For gas measurement, use a condensate leg and drain at the low point (freeze protection may be required here).

See Appendix B for some suggested freeze protection solutions.

4.3 Piping ST 3000 Transmitter, Continued

ATTENTION

Care must be taken when installing transmitters on hot processes. The operating temperature limits for the device (as outlined in Table 5) must not be exceeded. Impulse piping may be used to reduce the temperature of the process that comes into contact with the transmitter meter body. As a general rule there is a 56 degree C drop (100 degree F) in the temperature of the process for every foot of ½ inch uninsulated piping.

Process connections Table 13 describes typical process connections for a given type of transmitter.

Table 13 Process Connections

Transmitter Type	Process Connection
Differential Pressure	<ul style="list-style-type: none"> • Process heads with 1/4-inch NPT female connection. • Flange adapters and manifolds with 1/2-inch female connection are optional. • Models with pseudo flange on one side include 2- or 3-inch ANSI class 150 flange.
Gauge Pressure	<ul style="list-style-type: none"> • Process head with 1/2-inch NPT female connection (Series 100). • In-line 1/2-inch NPT female connection (STGxxL). • In-line ½ inch NPT male • 9/16 AMINCO • DIN 19213 • Process heads with 1/4-inch NPT female connection (STG9x4). • Flange adapters and manifolds with 1/2-inch female connections are optional (STG9x4). • 2-inch Sanitary Tri-Clamp (STGxxT) • Flush mount in 1-inch weld sleeve, with O-ring and locking bolt (STGxxP).
Absolute Pressure	<ul style="list-style-type: none"> • Process head with 1/2-inch NPT female connection. (STAx22, x40). • In-line ½ inch NPT male • 9/16 AMINCO • DIN 19213
Flange Mounted Liquid Level	<ul style="list-style-type: none"> • Small flange 1/2-inch, 1-, 1 ½ - and 2-inch (STFxxT) • 2, 3- or 4-inch flange with flush or 2-, 4- or 6-inch extended diaphragm (See Table 14) on high pressure side.* • DN 50, 80, or 100 PN 40 flange with flush or 2, 4 or 6 inch extended diaphragm (See Table 14) on High Pressure Side*.
Remote Diaphragm Seals	See Model Selection Guide for description of available Flanged, Threaded, Chemical Tee, Saddle, and Sanitary process connections.

* Reference side has standard differential pressure process head.

4.3 Piping ST 3000 Transmitter, Continued

Flange descriptions Table 14 describes the available flange connections for flange mounted liquid level transmitters.

Table 14 Flange Description

Transmitter Type	Description
Flush or Extended Diaphragm	2-inch 150# serrated-face flange with 4 holes 19 mm (3/4 in) diameter on 120.7 mm (4.75 in) diameter bolt circle and an outside diameter of 150 mm (5.91 in).
	2-inch 150# serrated-face flange with 8 holes 19 mm (3/4 in) diameter on 127 mm (5.00 in) diameter bolt circle and an outside diameter of 165 mm (6.50 in).
	3-inch 150# serrated-face flange with 4 holes 19 mm (3/4 in) diameter on 152.4 mm (6.00 in) diameter bolt circle and an outside diameter of 190 mm (7.48 in).
	3-inch 300# serrated-face flange with 8 holes 22.2 mm (7/8 in) diameter on 168.3 mm (6.62 in) diameter bolt circle and an outside diameter of 210 mm (8.27 in).
	4-inch 150# serrated-face flange with 4 holes 19 mm (3/4 in) diameter on 190.5 mm (7.50 in) diameter bolt circle and an outside diameter of 230 mm (9.05 in).
	4-inch 300# serrated-face flange with 8 holes 22.2 mm (7/8 in) diameter on 255 mm (10.04 in) diameter bolt circle and an outside diameter of 200 mm (7.87 in).
	DN 50 PN 40 serrated-face flange with 4 holes 18 mm (0.71 in) diameter on 125 mm (4.92 in) diameter bolt circle and an outside diameter of 165 mm (6.50 in).
	DN 80 PN 40 serrated-face flange with 8 holes 18 mm (0.71 in) diameter on 160 mm (6.30 in) diameter bolt circle and an outside diameter of 200 mm (7.87 in).
	DN 100 PN 40 serrated-face flange with 8 holes 22 mm (0.87 in) diameter on 190 mm (7.48 in) diameter bolt circle and an outside diameter of 235 mm (9.25 in).
Pseudo Flange Head	2-inch, 150 lbs serrated-face flange with 4 holes 15.9 mm (5/8 in) diameter on 120.6 mm (4-3/4 in) diameter bolt circle and an outside diameter of 152.4 mm (6 in).
	3-inch, 150 lbs serrated-face flange with 4 holes 19 mm (3/4 in) diameter on 152 mm (6 in) diameter bolt circle and an outside diameter of 190 mm (7-1/2 in).
Flush Mount Gauge STG93P	25.4 mm (1" pipe mount) (316L SS standard option.)

General piping guidelines

- When measuring fluids containing suspended solids, install permanent valves at regular intervals to blow-down piping.
- Blow-down all lines on new installations with compressed air or steam and flush them with process fluids (where possible) before connecting these lines to the transmitter's meter body.
- Be sure all the valves in the blow-down lines are closed tight after the initial blow-down procedure and each maintenance procedure after that.

Continued on next page

4.3 Piping ST 3000 Transmitter, Continued

Installing flange adapter

Table 15 gives the steps for an optional flange adapter on the process head.

ATTENTION

Slightly deforming the gasket supplied with the adapter before you insert it into the adapter may aid in retaining the gasket in the groove while you align the adapter to the process head. To deform the gasket, submerge it in hot water for a few minutes then firmly press it into its recessed mounting groove in the adapter.

Table 15 Installing Flange Adapter

Step	Action
1	Insert filter screen (if supplied) into inlet cavity of process head.
2	Carefully seat Teflon (white) gasket into adapter groove.
3	Thread adapter onto 1/2-inch process pipe and align mounting holes in adapter with holes in end of process head as required.
4	Secure adapter to process head by hand tightening 7/16-20 hex-head bolts. Example – Installing adapter on process head.
<p>ATTENTION Apply an anti-seize compound on the stainless steel bolts prior to threading them into the process head.</p>	
5	Evenly torque flange adapter bolts to a torque of 27,1 Nm +/- 1,4 Nm (20 ft lbs +/- 1.0 ft lbs)

4.4 Wiring ST 3000 Transmitter

Summary

The transmitter is designed to operate in a two-wire power/current loop with loop resistance and power supply voltage within the operating range shown in Figure 16.

Figure 16 Operating Range for ST 3000 Transmitters.

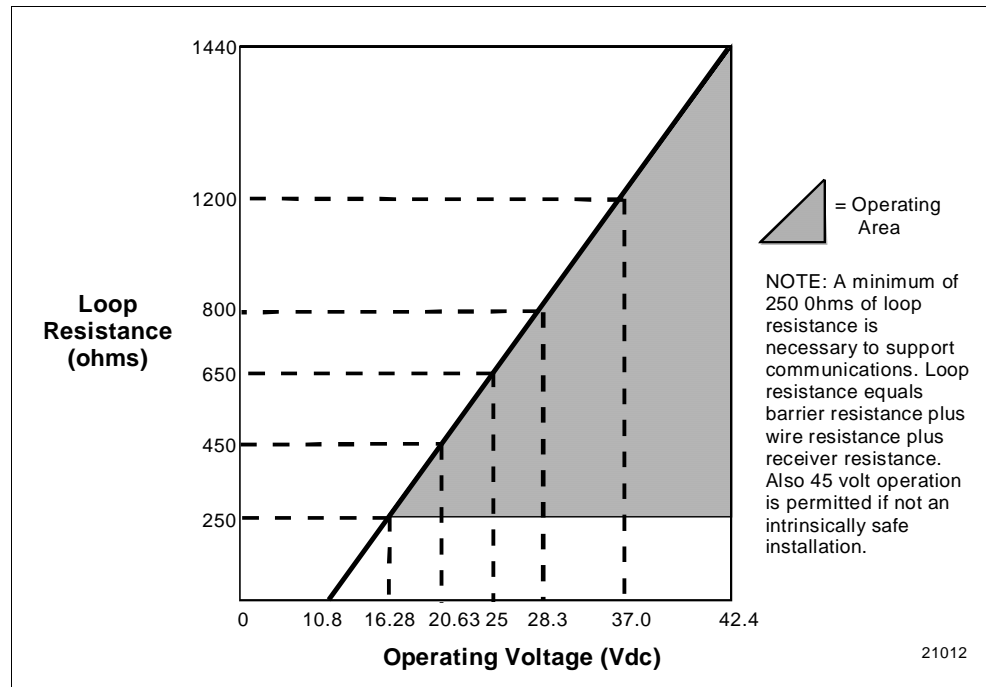

Loop wiring is connected to the transmitter by simply attaching the positive (+) and negative (-) loop wires to the positive (+) and negative (-) SIGNAL screw terminals on the terminal block in the transmitter's electronics housing shown in Figure 17.

Each transmitter includes an internal ground terminal to connect the transmitter to earth ground. A ground terminal can be optionally added to the outside of the electronics housing. While it is not necessary to ground the transmitter for proper operation, we suggest that you do so to minimize the possible effects of "noise" on the output signal and provide additional protection against lightning and static discharge damage.

Note that grounding may be required to meet optional approval body certification. Refer to section 3.2 CE Conformity (Europe) Notice for special conditions.

Optional lightning protection (option LP) can be ordered for transmitters that will be installed in areas highly susceptible to lightning strikes. Figure 17 shows the 5-screw terminal block used when the lightning protection option is ordered.

Continued on next page

4.4 Wiring ST 3000 Transmitter, Continued

Summary, continued Barriers can be installed per manufacturer's instructions for transmitters to be used in intrinsically safe applications.

Figure 17 ST 3000 Transmitter Terminal Block

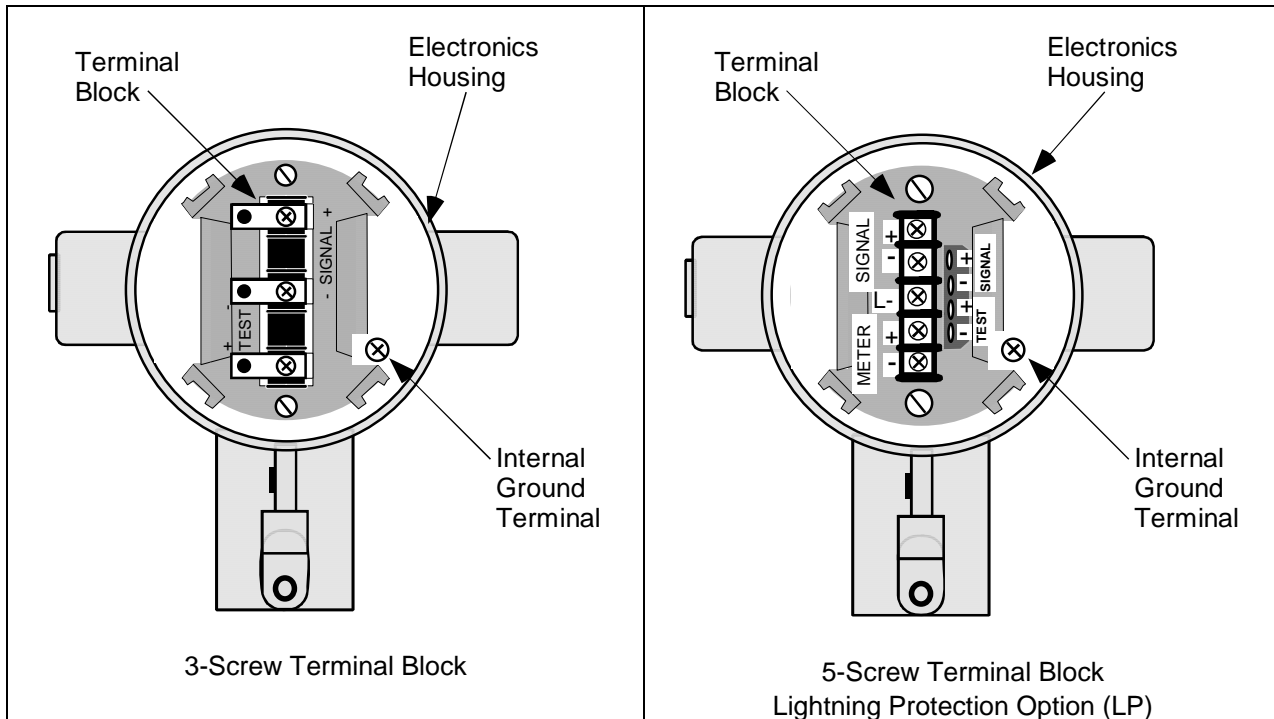

TPS reference

Transmitters that are to be digitally integrated to Honeywell's TPS system will be connected to the Smart Transmitter Interface Module in the Process Manager, Advanced Process Manager or High Performance Process Manager through a Field Termination Assembly. Details about the TPS system connections are given in the *PM/APM Smartline Transmitter Integration Manual PM12-410* which is part of the TDC 3000^X system bookset.

Allen-Bradley PLC

If you are digitally integrating the ST 3000 to an Allen Bradley PLC, the same FTA and wiring procedures used with Honeywell's TPS system are also used with the Allen-Bradley 1771 and 1746 platforms.

For more information, contact:

ProSoft Technology, Inc.
(800) 326-7066 or
<http://www.psft.com>

Continued on next page

4.4 Wiring ST 3000 Transmitter, Continued

Wiring connections and installation drawings

The procedure in Table 16 shows the steps for connecting power to the transmitter. For loop wiring and external wiring diagrams, refer to the installation drawings presented in Section 13. Detailed drawings are provided for transmitter installation in non-intrinsically safe areas and for intrinsically safe loops in hazardous area locations. If you are using the transmitter with Honeywell's TPS system, see the previous TPS reference.

ATTENTION

- All wiring must comply with local codes, regulations, and ordinances.
- If you will be using the transmitter in a hazardous area, be sure to review the hazardous location reference data included in Appendix D of this manual before operating the transmitter.

Table 16 Wiring the Transmitter

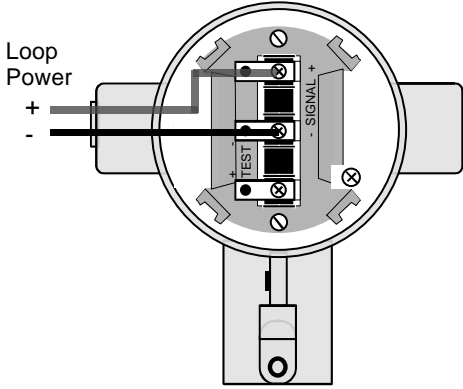
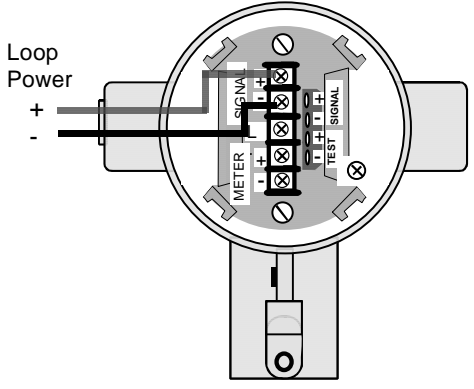
Step	Action
1	Loosen end-cap lock using a 1.5 mm allen wrench and remove end-cap cover from terminal block end of electronics housing.
2	Feed loop power leads through one of conduit entrances on either side of electronics housing. Plug whichever entrance you do not use. ATTENTION The transmitter accepts up to 16 AWG wire.
3	Observing polarity, connect positive loop power lead to SIGNAL + terminal and negative loop power lead to SIGNAL – terminal. Example – Connecting loop power to transmitter.
	<div style="display: flex; justify-content: space-around;"> <div style="text-align: center;"> <p>3-screw terminal block</p>  </div> <div style="text-align: center;"> <p>5-screw terminal (option LP)</p>  </div> </div>
4	Replace end-cap, and tighten end-cap lock.

Continued on next page

4.4 Wiring ST 3000 Transmitter, Continued

Approval body requirements

If your transmitter was ordered with Table III option 3N for self-declared approval per 94/9/EC (ATEX4), you must use a power supply that includes a voltage limiting device that will keep the voltage to the transmitter from exceeding 42 Vdc. You can achieve this by using a battery as the supply or one of these voltage limiting means.

- Double wound mains transformer per BS 3535 or equivalent.
- An adequately rated zener diode whose voltage is not significantly higher than the rated voltage.
- An adequately rated semiconductor voltage regulator.

Lightning protection

When your transmitter is equipped with optional lightning protection, you must connect a wire from the transmitter to ground as shown in Figure 18 to make the protection effective. We recommend that you use a size 8 AWG (American Wire Gage) or (8.37mm²) bare or green covered wire.

Figure 18 Ground Connection for Lightning Protection.

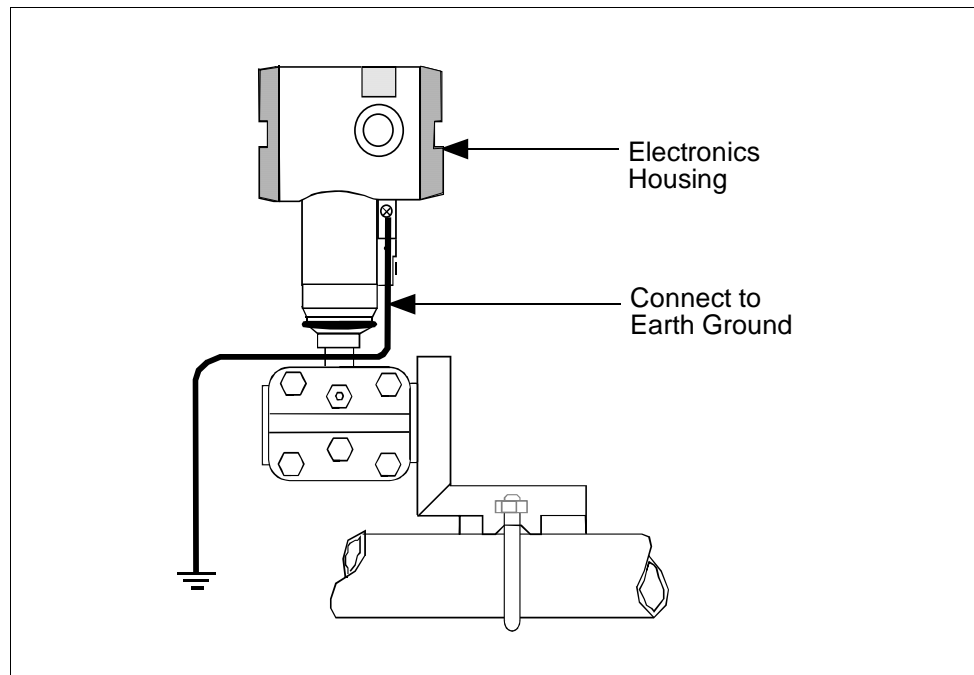

Continued on next page

4.4 Wiring ST 3000 Transmitter, Continued

Process Sealing

The ST 3000, Series 100, 100e, 600, and 900, Smart Pressure Transmitters are CSA certified as “Dual Seal” devices in accordance with ANSI/ISA–12.27.01–2003, Requirements for Process Sealing between Electrical Systems and Flammable or Combustible Process Fluids.

Explosionproof Conduit seal

Transmitters installed as explosionproof in a Class I, Division 1, Group A Hazardous (Classified) Location in accordance with ANSI/NFPA 70, the US National Electrical Code (NEC), require a “LISTED” explosionproof seal to be installed in the conduit, within 18 inches of the transmitter. Crouse-Hinds® type EYS/EYD or EYSX/EYDX are examples of “LISTED” explosionproof seals that meets this requirement.

Transmitters installed as explosionproof in a Class I, Division 1, Group B, C or D Hazardous (Classified) Locations do not require an explosionproof seal to be installed in the conduit.

NOTE: Installation should conform to all national and local electrical code requirements.

WARNING

When installed as explosionproof in a Division 1 Hazardous Location, keep covers tight while the transmitter is energized. Disconnect power to the transmitter in the non-hazardous area prior to removing end caps for service.

When installed as nonincendive equipment in a Division 2 Hazardous Location, disconnect power to the transmitter in the non-hazardous area, or determine that the location is non-hazardous prior to disconnecting or connecting the transmitter wires.

Continued on next page

4.4 Wiring ST 3000 Transmitter, Continued

Existing meter connections

Existing analog meters and SM 3000 Smart Meters can be connected to Release 300 transmitters. Examples of each meter type are shown below.

Analog Meter

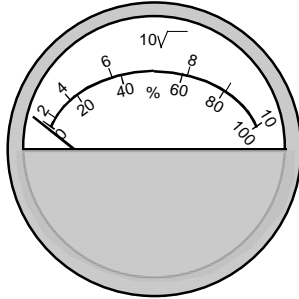

Analog Meter Connections —You can connect the analog meter (2-wires) integrally to Release 300 transmitter's terminal block inside the electronics housing. However, there are alternate wiring methods for connecting an analog meter remotely with the loop wiring. Section 13 in this manual illustrates alternate wiring methods for connecting an analog meter to Release 300 transmitters.

Smart Meter

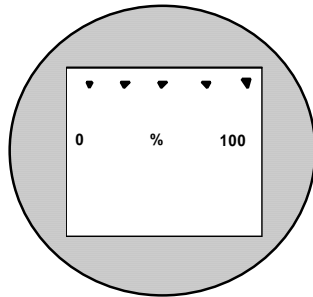

SM 3000 Smart Meter Connections —The smart meter (3-wires) can be connected remotely to a Release 300 transmitter. Section 13 in this manual illustrates alternate wiring methods for connecting this smart meter to Release 300 transmitters.

New Smart Meter with Local Zero and Span

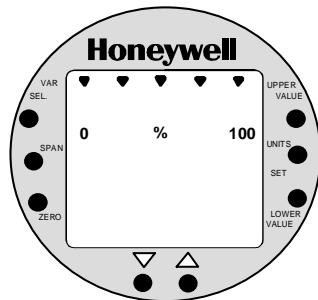

New Smart Meter Connections – The new integral smart meter (8-wires) is connected directly to the transmitter's PWA and is mounted to the electronics module assembly inside the electronics housing. The new integral smart meter is designed for the ST 3000 Release 300 transmitter and provides functionality not available with other smart meter designs.

NOTE: Only one smart meter should be installed integrally to the transmitter.

ATTENTION

Be aware that the RMA 300 remote meter does not have custom and flow units capability like the new smart meter. Therefore, if you use a local smart meter that is configured to display readings in custom or flow units in conjunction with an RMA 300 remote meter, the readings of the two meters will be in different units.

Section 5 —Getting Started

5.1 Introduction

Section Contents This section includes these topics:

Section	Topic	See Page
5.1	Introduction	49
5.2	Establishing Communications	50
5.3	Making Initial Checks	54
5.4	Changing Mode of Operation	57

About this section If you have never used an SFC to “talk” to an ST 3000 transmitter, this section tells you how to establish communications, make initial checks, and change the transmitter’s mode of operation.

5.2 Establishing Communications

- SFC connection rules**
- Always plug the SFC leads into the jack on the SFC before you connect them to the transmitter.
 - Use this formula to find the maximum filter capacitance allowed across the sense resistor (250 ohm minimum) for SFC communications to work.

$$C (\mu\text{F}) = 1000 / R_{\text{sense}}$$

Connecting SFC

Using either leads with alligator clips or easy-hooks supplied with the SFC, you connect the SFC directly to signal terminals on the transmitter's terminal block or at any convenient location in the 4 to 20 milliamper line. Observing polarity, connect the red lead to positive (+) and the black lead to negative (-).

WARNING

When the transmitter's end-cap is removed, the housing is not explosionproof.

Figure 19 shows typical SFC connections across loop wiring to the ST 3000 transmitter. (Non-lightning protection terminal connections shown.)

Figure 19 Typical SFC Connections.

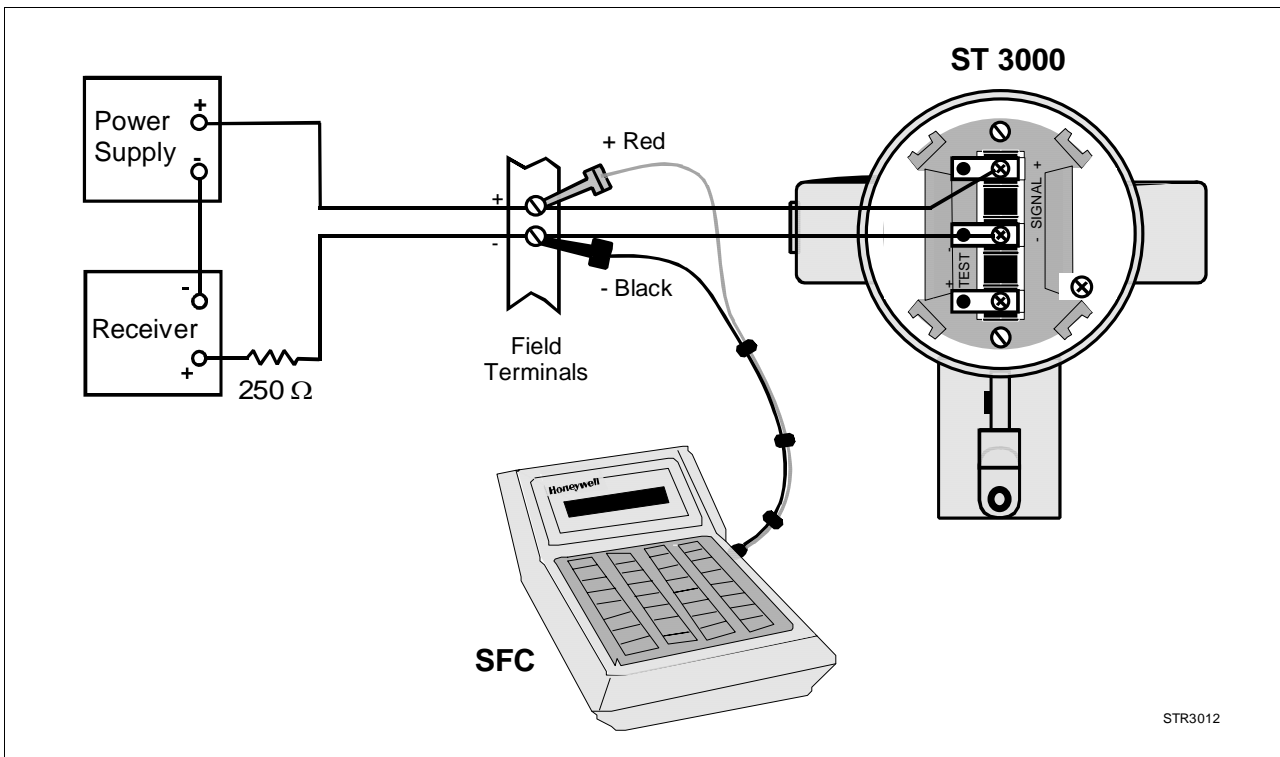

Continued on next page

5.2 Establishing Communications, Continued

Starting communications

Once you connect the SFC to the transmitter or loop wiring, you are ready to start communicating with the transmitter. The procedure in Table 17 outlines the steps for communications with an ST 3000 transmitter without an assigned tag number.

Table 17 Starting Communications with Transmitter.

Step	Press Key	Read Display or Action	Description
1		Slide power switch on left side of SFC to ON position.	SFC runs its self check and displays initial prompt.
2		<div style="border: 1px solid black; padding: 2px; display: inline-block; margin-bottom: 10px;"> P U T L O O P I N M A N </div> <p style="text-align: center;">OR</p> <div style="border: 1px solid black; padding: 2px; display: inline-block;"> D E - X M T R P R E S S I D </div>	<p>If this prompt appears, transmitter is in Analog mode of operation. This is the factory default mode of operation setting. Put your control loop in the manual mode of operation before initiating SFC communications. Note that you must do this separately through the receiving device in the loop.</p> <p>If this prompt appears, transmitter is in Digital (DE) mode of operation.</p>
3	DE READ <div style="border: 1px solid black; padding: 2px; display: inline-block;"> ID^A </div>	<div style="border: 1px solid black; padding: 2px; display: inline-block; margin-bottom: 10px;"> T A G N O . </div> <div style="border: 1px solid black; padding: 2px; display: inline-block;"> T R I P S S E C U R E D ? ? </div> <p style="text-align: center;">OR</p> <p style="text-align: center;">Go to Step 5</p>	<p>Be sure any switches that may trip alarms or interlocks associated with analog loop are secured or turned off. Go to Step 4.</p> <p>This prompt does not appear for transmitters operating in DE mode. See DE transmitter display response in Step 5.</p>
4	NON-VOL <div style="border: 1px solid black; padding: 2px; display: inline-block;"> ENTER (Yes) </div>	Confirms that "TRIPS" are secured. Go to Step 5 for display response.	Required for transmitters operating in analog mode only.

Continued on next page

5.2 Establishing Communications, Continued

Starting communications, continued

Table 17 Starting Communications with Transmitter, continued

Step	Press Key	Read Display or Action	Description																																																																																																																								
5		<table border="1" style="margin-bottom: 10px;"> <tr><td>T</td><td>A</td><td>G</td><td>N</td><td>O</td><td>.</td><td></td><td></td><td></td><td></td><td></td><td></td><td></td><td></td><td></td></tr> <tr><td>S</td><td>F</td><td>C</td><td>W</td><td>O</td><td>R</td><td>K</td><td>I</td><td>N</td><td>G</td><td>.</td><td>.</td><td>.</td><td></td><td></td></tr> </table> <table border="1" style="margin-bottom: 10px;"> <tr><td>L</td><td>I</td><td>N</td><td></td><td></td><td></td><td>D</td><td>P</td><td>T</td><td>A</td><td>G</td><td>N</td><td>O</td><td>.</td><td></td></tr> <tr><td></td><td></td><td></td><td></td><td></td><td></td><td></td><td></td><td>-</td><td></td><td></td><td></td><td></td><td></td><td></td></tr> </table> <p style="text-align: center;">OR</p> <table border="1" style="margin-bottom: 10px;"> <tr><td>D</td><td>E</td><td>-</td><td>X</td><td>M</td><td>T</td><td>R</td><td>T</td><td>A</td><td>G</td><td>N</td><td>O</td><td>.</td><td></td><td></td></tr> <tr><td></td><td></td><td></td><td></td><td></td><td></td><td></td><td></td><td>-</td><td></td><td></td><td></td><td></td><td></td><td></td></tr> </table> <p style="text-align: center;">OR</p> <table border="1"> <tr><td>T</td><td>A</td><td>G</td><td>N</td><td>O</td><td>.</td><td></td><td></td><td></td><td></td><td></td><td></td><td></td><td></td><td></td></tr> <tr><td>N</td><td>O</td><td>X</td><td>M</td><td>T</td><td>R</td><td>R</td><td>E</td><td>S</td><td>P</td><td>O</td><td>N</td><td>S</td><td>E</td><td></td></tr> </table>	T	A	G	N	O	.										S	F	C	W	O	R	K	I	N	G	.	.	.			L	I	N				D	P	T	A	G	N	O	.										-							D	E	-	X	M	T	R	T	A	G	N	O	.											-							T	A	G	N	O	.										N	O	X	M	T	R	R	E	S	P	O	N	S	E		<p>Message exchange is taking place Note that communications with transmitter are blocked until [ID] key is pressed.</p> <p>Transmitter is in analog transmission mode. "LIN" means transmitter is set for linear output instead of square root (SQRT). "DP" means transmitter is differential pressure type instead of gauge pressure (GP) or absolute pressure (AP). Last eight columns in bottom row are blank when no tag number has been assigned to this transmitter. Go to Step 8.</p> <p>Transmitter is in digital (DE) transmission mode. Last eight columns in bottom row are blank when no tag number has been assigned to this transmitter. Go to Step 7.</p> <p>Communication error messages are cycled at two second intervals and display returns to initial prompt. Go to Step 6.</p>
T	A	G	N	O	.																																																																																																																						
S	F	C	W	O	R	K	I	N	G	.	.	.																																																																																																															
L	I	N				D	P	T	A	G	N	O	.																																																																																																														
								-																																																																																																																			
D	E	-	X	M	T	R	T	A	G	N	O	.																																																																																																															
								-																																																																																																																			
T	A	G	N	O	.																																																																																																																						
N	O	X	M	T	R	R	E	S	P	O	N	S	E																																																																																																														
6		<p>There is a communication problem, check the</p> <ul style="list-style-type: none"> • power and SFC connections - Is the polarity correct; red to positive and black to negative? • loop resistance - Is there a minimum of 250 ohms resistance between the SFC and the power supply? • power supply - Is power applied, is there greater than 11 volts at the transmitter, and are you within the operating area on the curve in Figure 16? 	<p>Correct any wiring, resistance, or power supply problems, and try communicating again - Press [ID] key.</p> <p>If you are still not getting the correct display, note error messages and refer to Troubleshooting section in this manual for probable cause.</p>																																																																																																																								

Continued on next page

5.2 Establishing Communications, Continued

Starting communications, continued

Table 17 Starting Communications with Transmitter, continued







Step	Press Key	Read Display or Action	Description
7	<div style="border: 1px solid black; padding: 2px; display: inline-block; text-align: center;"> [^] SHIFT </div> DE READ <div style="border: 1px solid black; padding: 2px; display: inline-block; text-align: center;"> ^A ID </div>	<div style="border: 1px solid black; padding: 2px; display: inline-block; text-align: center;"> D E - X M T R T A G N O . S H I F T - </div> <div style="border: 1px solid black; padding: 2px; display: inline-block; text-align: center;"> T A G N O . S F C W O R K I N G - . 3 3 % </div> <div style="border: 1px solid black; padding: 2px; display: inline-block; text-align: center;"> L I N D P T A G N O . - </div>	<p>Initiates shift key selection.</p> <p>Begins upload of configuration database from transmitter. Operation completion rate is shown in percent. Note that display for ID response reverts to style used for transmitter in analog mode when upload is completed.</p>
8	<div style="border: 1px solid black; padding: 2px; display: inline-block; text-align: center;"> F/S DIR ^U STAT </div>	<div style="border: 1px solid black; padding: 2px; display: inline-block; text-align: center;"> S T A T U S S F C W O R K I N G . . . </div> <div style="border: 1px solid black; padding: 2px; display: inline-block; text-align: center;"> S T A T U S S T A T U S C H E C K = O K </div> <div style="border: 1px solid black; padding: 2px; display: inline-block; text-align: center;"> L I N D P R E A D Y . . . </div>	<p>Initiates status check.</p> <p>If messages other than this one are cycled in display, refer to the Troubleshooting section in this manual for an explanation of the message, the probable cause, and any corrective action.</p> <p>Signals end of status messages for display.</p> <p>ATTENTION When assigned, the transmitter's tag number also appears in the top row of the display.</p>
9		You have established communications with transmitter and are ready to initiate other SFC operations.	

5.3 Making Initial Checks

Checking mode and software

Before doing anything else, it is a good idea to confirm the transmitter's mode of operation and identify the version of software being used in the SFC and the transmitter. Table 18 outlines the steps for quickly checking the transmitter's mode of operation and software versions of the SFC and the transmitter.

Table 18 Confirming Mode of Operation and Identifying Software Versions.

Step	Press Key	Read Display or Action	Description																																																																									
1	 	<table border="1" style="width: 100%; text-align: center;"> <tr><td>L</td><td>I</td><td>N</td><td></td><td>D</td><td>P</td><td>S</td><td>T</td><td>3</td><td>0</td><td>0</td><td>0</td></tr> <tr><td></td><td></td><td></td><td></td><td>S</td><td>H</td><td>I</td><td>F</td><td>T</td><td>-</td><td></td><td></td></tr> </table> <table border="1" style="width: 100%; text-align: center;"> <tr><td>A</td><td>/</td><td>D</td><td>E</td><td></td><td></td><td>S</td><td>T</td><td>3</td><td>0</td><td>0</td><td>0</td></tr> <tr><td>C</td><td>H</td><td>N</td><td>G</td><td>T</td><td>O</td><td>D</td><td>E</td><td>?</td><td></td><td></td><td></td></tr> </table> <p style="text-align: center;">OR</p> <table border="1" style="width: 100%; text-align: center;"> <tr><td>A</td><td>/</td><td>D</td><td>E</td><td></td><td></td><td>S</td><td>T</td><td>3</td><td>0</td><td>0</td><td>0</td></tr> <tr><td>C</td><td>H</td><td>N</td><td>G</td><td>T</td><td>O</td><td>A</td><td>N</td><td>A</td><td>L</td><td>O</td><td>G</td><td>?</td></tr> </table>	L	I	N		D	P	S	T	3	0	0	0					S	H	I	F	T	-			A	/	D	E			S	T	3	0	0	0	C	H	N	G	T	O	D	E	?				A	/	D	E			S	T	3	0	0	0	C	H	N	G	T	O	A	N	A	L	O	G	?	<p>Initiates shift key selection. Note that transmitter tag number ST 3000 in top row is used for example purposes only.</p> <p>Asks if you want to change to DE (digital) mode. This means transmitter is in analog mode of operation.</p> <p>Asks if you want to change to analog mode. This means transmitter is in DE (digital) mode of operation.</p>
L	I	N		D	P	S	T	3	0	0	0																																																																	
				S	H	I	F	T	-																																																																			
A	/	D	E			S	T	3	0	0	0																																																																	
C	H	N	G	T	O	D	E	?																																																																				
A	/	D	E			S	T	3	0	0	0																																																																	
C	H	N	G	T	O	A	N	A	L	O	G	?																																																																
2		<table border="1" style="width: 100%; text-align: center;"> <tr><td>L</td><td>I</td><td>N</td><td></td><td>D</td><td>P</td><td>S</td><td>T</td><td>3</td><td>0</td><td>0</td><td>0</td></tr> <tr><td></td><td></td><td></td><td></td><td>R</td><td>E</td><td>A</td><td>D</td><td>Y</td><td>.</td><td>.</td><td>.</td></tr> </table>	L	I	N		D	P	S	T	3	0	0	0					R	E	A	D	Y	.	.	.	Exits analog to DE change function.																																																	
L	I	N		D	P	S	T	3	0	0	0																																																																	
				R	E	A	D	Y	.	.	.																																																																	
3	 	<table border="1" style="width: 100%; text-align: center;"> <tr><td>L</td><td>I</td><td>N</td><td></td><td>D</td><td>P</td><td>S</td><td>T</td><td>3</td><td>0</td><td>0</td><td>0</td></tr> <tr><td></td><td></td><td></td><td></td><td>S</td><td>H</td><td>I</td><td>F</td><td>T</td><td>-</td><td></td><td></td></tr> </table> <table border="1" style="width: 100%; text-align: center;"> <tr><td>S</td><td>/</td><td>W</td><td>N</td><td>O</td><td>.</td><td>S</td><td>T</td><td>3</td><td>0</td><td>0</td><td>0</td></tr> <tr><td>S</td><td>F</td><td>C</td><td>=</td><td>4</td><td>.</td><td>5</td><td>X</td><td>M</td><td>T</td><td>R</td><td>=</td><td>3</td><td>.</td><td>0</td></tr> </table>	L	I	N		D	P	S	T	3	0	0	0					S	H	I	F	T	-			S	/	W	N	O	.	S	T	3	0	0	0	S	F	C	=	4	.	5	X	M	T	R	=	3	.	0	<p>Initiates shift key selection.</p> <p>Both SFC and XMTR software versions appear in display. Note that only SFC version appears when SFC is not connected to transmitter or [SHIFT] and [ID] keys have not yet been pressed for transmitter in DE mode.</p>																						
L	I	N		D	P	S	T	3	0	0	0																																																																	
				S	H	I	F	T	-																																																																			
S	/	W	N	O	.	S	T	3	0	0	0																																																																	
S	F	C	=	4	.	5	X	M	T	R	=	3	.	0																																																														
4		<table border="1" style="width: 100%; text-align: center;"> <tr><td>L</td><td>I</td><td>N</td><td></td><td>D</td><td>P</td><td>S</td><td>T</td><td>3</td><td>0</td><td>0</td><td>0</td></tr> <tr><td></td><td></td><td></td><td></td><td>R</td><td>E</td><td>A</td><td>D</td><td>Y</td><td>.</td><td>.</td><td>.</td></tr> </table>	L	I	N		D	P	S	T	3	0	0	0					R	E	A	D	Y	.	.	.	Exit function. SFC is "READY" for next operation.																																																	
L	I	N		D	P	S	T	3	0	0	0																																																																	
				R	E	A	D	Y	.	.	.																																																																	

Analog and DE modes

In the analog transmission mode, the transmitter sends a proportional 4 to 20 milliampere output signal that can be used as a compatible analog input signal to a controller or a recorder in the control room

Continued on next page

5.3 Making Initial Checks, Continued

Analog and DE modes, continued

A transmitter in the digital (DE) mode can communicate in a direct digital fashion with Honeywell's TPS system and Allen-Bradley PLCs. The digital signal can include process variable as well as configuration database data depending upon the broadcast format selected during configuration.

Software version compatibility

The SFC model STS103 with software version 5.0 or greater is fully compatible with all Series 100 and Series 900 Release 300 transmitters. The SFC will operate with transmitters that have older software versions, but functions will be limited to those applicable for the transmitter software.

Write protect option

The ST 3000 transmitters are available with what is called a "write protect option". It consists of a jumper located on the transmitter's PWA that you can position to allow read and write access or read only access to the transmitter's configuration database. When the write protect option is ordered, transmitters are shipped with a default jumper position for read-only. This means that the transmitter's configuration database can not be overwritten. To allow read/write access, the jumper can be moved to the read/write position. When the write protect option is not ordered access is read/write.

Figure 20 shows the location of the write protect jumper on the PWA for Release 300 transmitters.

Figure 20 Write Protect Jumper Location and Selections.

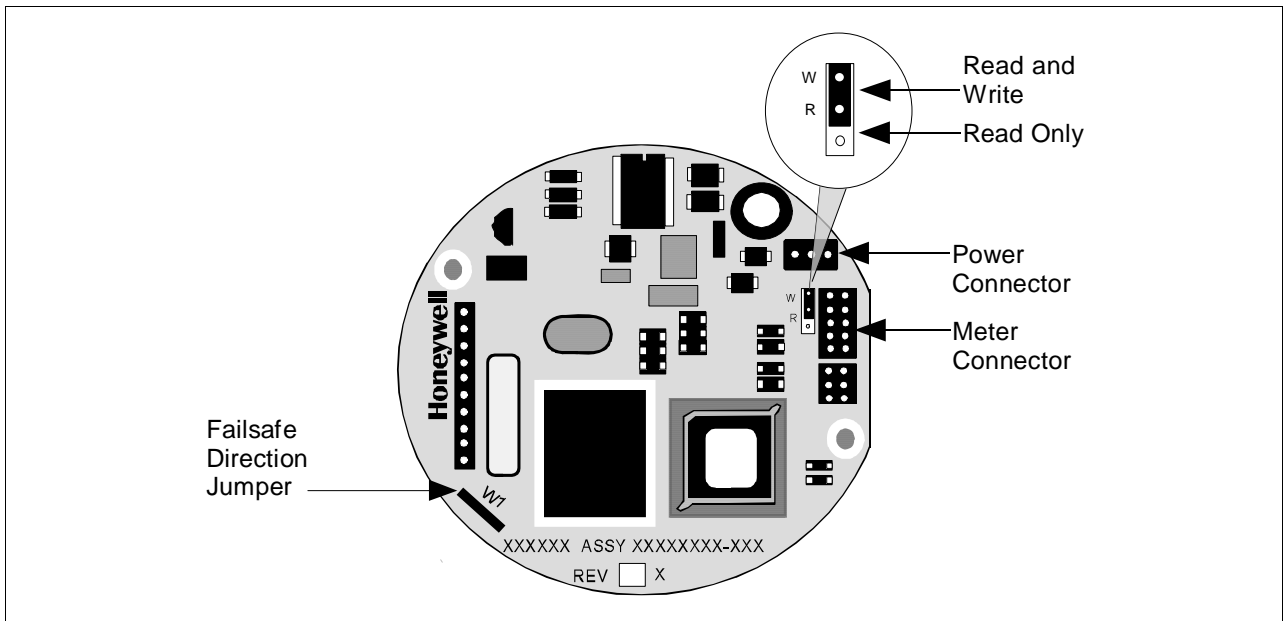

5.3 Making Initial Checks, Continued

Local smart meter display indications

You can check the status of all the indicators on the Local Smart Meter LCD display by cycling power to the transmitter. The meter runs a brief self-test whenever power is applied to the transmitter. All the display indicators are lit during the self-test as shown in Figure 21.

Figure 21 Display With All Indicators Lit.

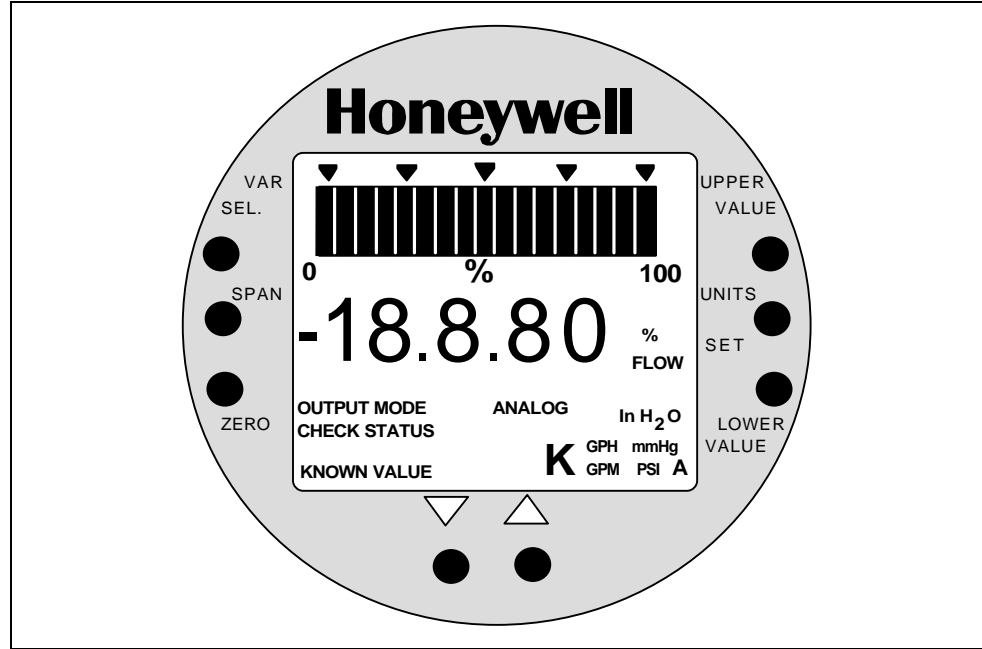

Please refer to Table 31 in this manual for a description of the pushbuttons on the meter face. See Section 8.6 for a description of the indicators with examples of typical display indications and error codes. (Note that the display may revert to dashes (---) after the self-test until the transmitter initializes all its functions.) Use the SFC to check the transmitter's status.





5.4 Changing Mode of Operation

Procedure

If you need to change your transmitter's mode of operation, use the steps in Table 19 to change the mode from analog to digital or digital to analog. If you have an optional Local Smart Meter, you can readily tell your transmitter's present mode of operation by checking whether the ANALOG indicator on the meter display is lit or not.

Attention: Only transmitters with Option DE can be set to DE Mode.

Table 19 Changing Mode of Operation.

Step	Press Key	Read Display or Action	Description
1	 	<pre>L I N D P S T 3 0 0 0 S H I F T -</pre> <pre>A / D E S T 3 0 0 0 C H N G T O D E ?</pre> <p style="text-align: center;">OR</p> <pre>A / D E S T 3 0 0 0 C H N G T O A N A L O G ?</pre>	<p>Initiates shift key selection. Note that transmitter tag number ST 3000 in top row is used for example purposes only.</p> <p>Asks if you want to change to DE (digital) mode. If you want to change mode, go to Step 2. If you do not want to change mode, press [CLR] key to exit function.</p> <p>Asks if you want to change to analog mode. If you want to change mode, go to Step 2. If you do not want to change mode, press [CLR] key to exit function.</p>
2	NON-VOL 	<pre>A / D E S T 3 0 0 0 A R E Y O U S U R E ?</pre>	<p>Prompt asks for confirmation of mode change.</p>
3	NON-VOL 	<pre>A / D E S T 3 0 0 0 S F C W O R K I N G . . .</pre> <pre>A / D E S T 3 0 0 0 D E X M T R</pre> <p style="text-align: center;">OR</p> <pre>A / D E S T 3 0 0 0 A N A L O G X M T R</pre> <pre>L I N D P S T 3 0 0 0 R E A D Y . . .</pre>	<p>Message exchange is working.</p> <p>Mode of operation is now DE (digital).</p> <p>Mode of operation is now analog.</p> <p>Ready for next function.</p>

Continued on next page

5.4 Changing Mode of Operation, Continued

Keystroke summary Figure 22 shows keystroke summary for changing mode of operation for quick reference.

Figure 22 Keystroke Summary for Changing Mode of Operation.

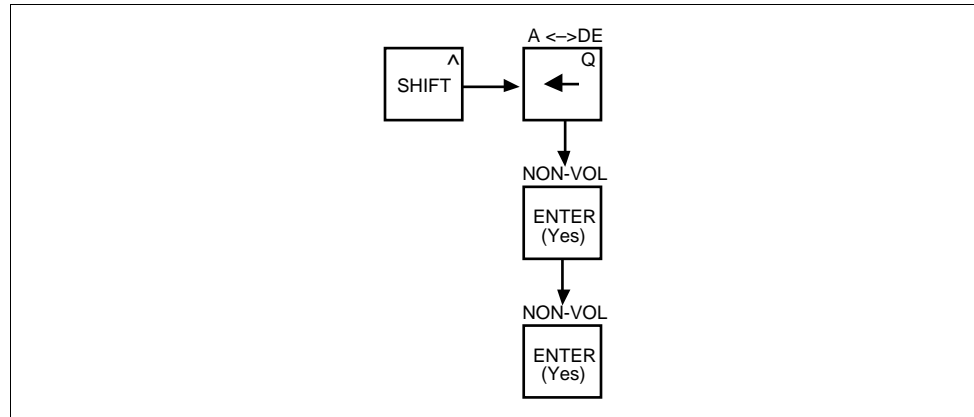

Section 6 —Configuration

6.1 Introduction

Section Contents This section includes these topics:

Section	Topic	See Page
6.1	Introduction	59
6.2	Overview	60
6.3	Entering a Tag Number	71
6.4	Selecting Output Form	73
6.5	Adjusting Damping Time	76
6.6	Selecting Unit of Measurement	78
6.7	Setting Range Values Using SFC	80
6.8	Setting Range Values Using Local Adjustments	84
6.9	Selecting Output Signal Mode (DE Mode Only)	91
6.10	Selecting Message Format (DE Mode Only)	94
6.11	Configuring Smart Meter Using SFC	96
6.12	Configuring Smart Meter Using Pushbuttons	103
6.13	Disconnecting SFC	122

About this section This section introduces you to ST 3000 transmitter configuration. It identifies the parameters that make up the transmitter’s configuration database and provides procedures for entering values/selections for the given configuration parameters.

ATTENTION

If you will be using the SCT 3000 software Release 3.12.2 or greater instead of an SFC to configure the transmitter, follow the SCT 3000 on-line help and on-line documentation to configure the transmitter’s database.

6.2 Overview

About configuration

Each ST 3000 Transmitter includes a configuration database which defines its particular operating characteristics. You can use an SFC to change selected parameters within a given transmitter's database to alter its operating characteristics. We call this process of viewing and/or changing database parameters "configuration".

Figure 23 shows a graphic summation of the configuration process.

Figure 23 Summary of Configuration Process

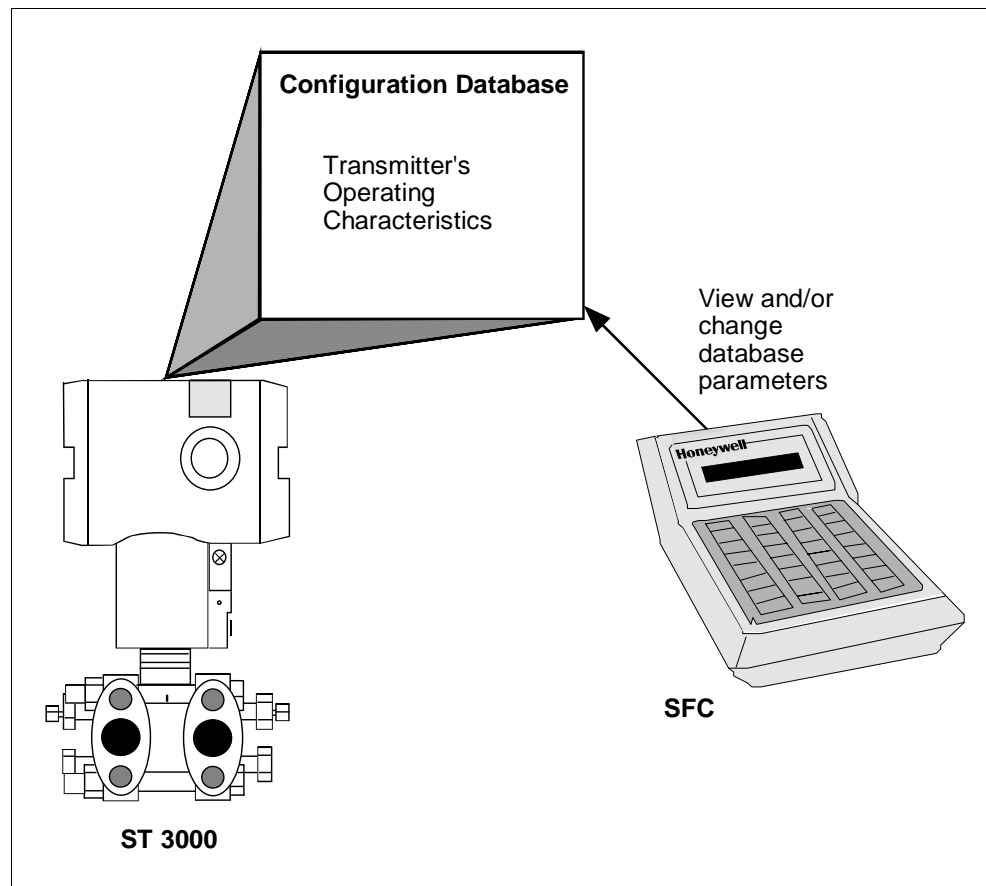

ATTENTION

If the transmitter is operating in the DE mode, you can also configure the transmitter's configuration database through displays at the Universal Station or GUS. See the *PM/APM Smartline Integration Manual PM12-410* for details.

Continued on next page

6.2 Overview, Continued

SFC and ST 3000 transmitter memories

Both the SFC and the ST 3000 transmitter have working memories as shown in Figure 24. They serve as temporary storage areas for data exchanged between the SFC and the transmitter during communications.

The transmitter also has a non-volatile memory as the permanent storage area for a backup copy of all the data held in the working memory. This memory retains its data even if the transmitter loses power.

The SFC has a second temporary storage area called the hold memory. This memory supports the SFC's save and restore functions. It serves as the temporary storage area for a configuration database saved from a transmitter until it can be restored in a transmitter. Data in this memory can not be displayed or altered, and it will be lost if the SFC is turned off.

Figure 24 shows the working relationship between SFC and transmitter memories during communications.

Figure 24 SFC and ST 3000 Transmitter Memories.

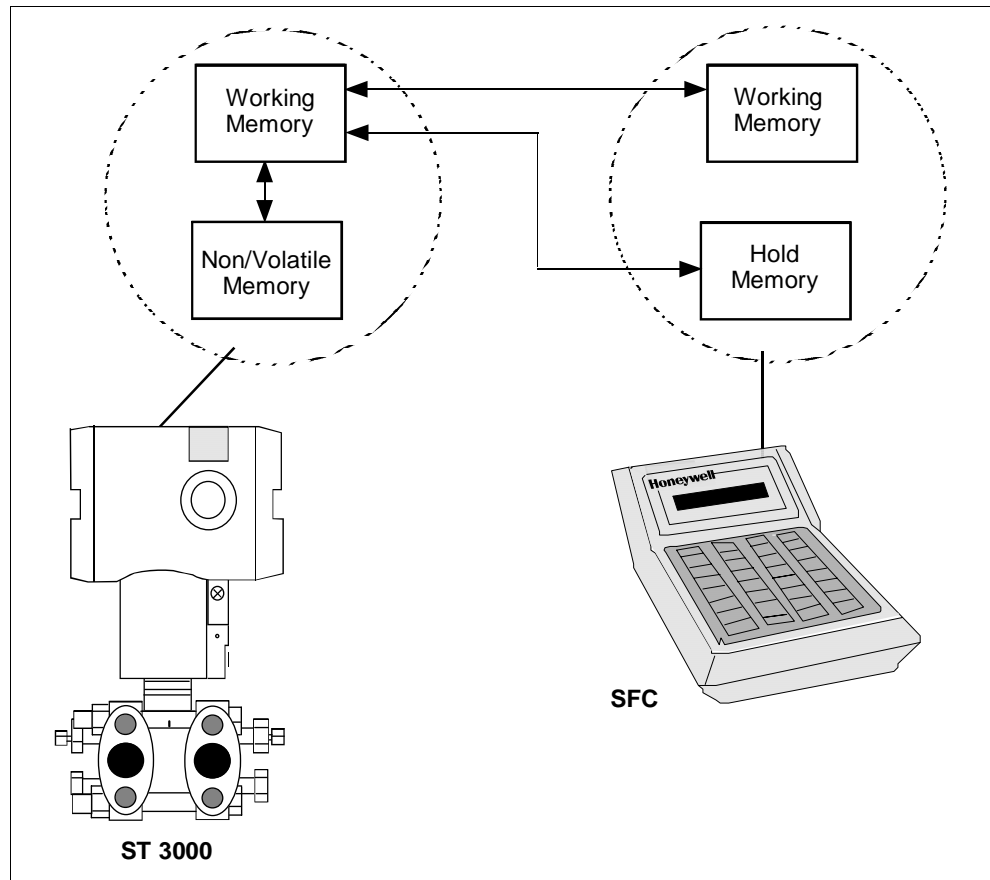

Continued on next page

6.2 Overview, Continued

Copying data into non-volatile memory

When setting-up or configuring a ST 3000, whether you are changing one element or a full database, all configuration data must be copied into the transmitter's non-volatile memory.

Normally, thirty seconds after a value is changed the transmitter automatically copies it into the non-volatile memory. But, if you change an element and power goes down before the change is copied to non-volatile memory, you will lose the data in the working memory.

ATTENTION

Therefore, whenever you make any changes in the transmitter using the SFC, always end your procedure by pressing **SHIFT** and **ENTER**. This action immediately copies the changes from working memory to non-volatile memory.

Continued on next page

6.2 Overview, Continued

What to configure

Table 20 summarizes the parameters that are included in the configuration database for an ST 3000 pressure transmitter in either the analog or DE mode of operation.

Be aware that configuration data for the transmitter as well as for the Local Smart Meter is stored in a non-volatile memory on the transmitter's PWA and make up the transmitter's configuration database. Therefore, the transmitter and meter configuration are lost if the PWA is replaced. Performing a save and restore function using the SFC will preserve the transmitter's configuration database. See Section 8.5 for the steps to perform save and restore functions using the SFC.

ATTENTION

Since the SFC is compatible with other Honeywell Smartline transmitters, be sure all configuration data applies to a pressure transmitter.

Table 20 Summary of Pressure Transmitter Configuration Parameters

Configuration Data	Setting or Selection
Transmitter Tag Number	Up to eight characters
Damping Time Constant	Any one of these value selections in seconds: 0.00 0.5 4.0 32.0 0.2 1.0 8.0 0.3 2.0 16.0
Type of Output Conformity	LIN (Linear) SQRT (Square Root)
Unit of Measurement	ATTENTION Note that ST 3000 transmitters with inches of water ranges are factory calibrated using pressure referenced to a temperature of 39.2°F (4°C). Pressure readings can be displayed in any one of these pre-programmed engineering units: "H2O_39F PSI MPa bar KG/cm^2 mmH2O_4C mmHg_0C KPa mbar G/cm^2 inHg_32F mH2O_4C "H2O_68F ATM "H2O_60F
LRV (Lower Range Value) (Process input for 4 mAdc (0%) output)	Key in desired value through SFC keyboard or set LRV to applied pressure.
URV (Upper Range Value) (Process input for 20 mAdc (100%) output)	Key in desired value through SFC keyboard or set URV to applied pressure.

Continued on next page

6.2 Overview, Continued

What to configure, continued

Table 20 Summary of Pressure Transmitter Configuration Parameters, continued

Configuration Data	Setting or Selection																													
<i>The following parameters are for transmitters in DE mode of operation only.</i>																														
<p>Mode of Output Signal Indication</p>	<p>Any one of these selections based on control system information needs:</p> <p>Single Range Sends the PV value corresponding to the transmitter's working range (PVw) to the control system for display. For systems using STDC card or STIMV IOP module (also called STIM Smart Transmitter Interface Module).</p> <p>Dual Range (STDC) Sends the PV values corresponding to the transmitter's full range (PVt) and working range (PVw) measurements to the control system for display. For systems using STDC card only.</p> <p>Single Rng W/SV Sends PV value corresponding to the transmitter's working range (PVw) and temperature value from the transmitter's sensor to the control system for display. For systems using STDC card or STIMV IOP module.</p>																													
<p>Message Format</p>	<p>Choose one of these broadcast types for data transmission to the digital control system: Note that "DB" in following selection prompt stands for "database".</p> <p>w/oDB (4 Byte) Byte 1 is output signal mode Bytes 2 to 4 are PV value</p> <table border="1" data-bbox="769 1234 1053 1299"> <tr> <td style="text-align: center;">1</td> <td style="text-align: center;">2</td> <td style="text-align: center;">3</td> <td style="text-align: center;">4</td> </tr> <tr> <td style="text-align: center;">FLAG</td> <td style="text-align: center;">PV</td> <td style="text-align: center;">PV</td> <td style="text-align: center;">PV</td> </tr> </table> <p>w/DB (6 Byte) Byte 1 is output signal mode Bytes 2 to 4 are PV value Byte 5 is data type identifier (LRV, URV span, etc.) Byte 6 is data being sent</p> <table border="1" data-bbox="769 1444 1196 1509"> <tr> <td style="text-align: center;">1</td> <td style="text-align: center;">2</td> <td style="text-align: center;">3</td> <td style="text-align: center;">4</td> <td style="text-align: center;">5</td> <td style="text-align: center;">6</td> </tr> <tr> <td style="text-align: center;">FLAG</td> <td style="text-align: center;">PV</td> <td style="text-align: center;">PV</td> <td style="text-align: center;">PV</td> <td style="text-align: center;">ID</td> <td style="text-align: center;">DB</td> </tr> </table> <p>ATTENTION The approximate rates of transmission in repeats per second are:</p> <table border="1" data-bbox="591 1612 1365 1719"> <thead> <tr> <th>Data</th> <th>4 - Byte</th> <th>6 - Byte</th> </tr> </thead> <tbody> <tr> <td>PV value</td> <td>3 rpts/sec</td> <td>2.5 rpts/sec</td> </tr> <tr> <td>Temperature</td> <td>1 rpt/2.5 sec</td> <td>1 rpt/3 sec</td> </tr> </tbody> </table>	1	2	3	4	FLAG	PV	PV	PV	1	2	3	4	5	6	FLAG	PV	PV	PV	ID	DB	Data	4 - Byte	6 - Byte	PV value	3 rpts/sec	2.5 rpts/sec	Temperature	1 rpt/2.5 sec	1 rpt/3 sec
1	2	3	4																											
FLAG	PV	PV	PV																											
1	2	3	4	5	6																									
FLAG	PV	PV	PV	ID	DB																									
Data	4 - Byte	6 - Byte																												
PV value	3 rpts/sec	2.5 rpts/sec																												
Temperature	1 rpt/2.5 sec	1 rpt/3 sec																												

Continued on next page

6.2 Overview, Continued

What to configure,
continued

Table 20 Summary of Pressure Transmitter Configuration Parameters, continued

Configuration Data	Setting or Selection																						
Failsafe Mode	<p>NOTE: This parameter is valid only to select the failsafe action for the STDC card in a controller - not the transmitter. If you are using the STDC card to interface with the ST 3000 transmitter, contact Honeywell Technical Assistance in using this parameter.</p> <p>ATTENTION An STIMV IOP module has built-in failsafe capabilities and ignores this parameter.</p>																						
<i>The following parameters are only for transmitters with optional Local Smart Meter.</i>																							
Meter Engineering Units	<p>If the transmitter is set for LINEAR output conformity, you can choose to have the Local Smart Meter display pressure readings in one of these engineering units:</p> <table border="0" data-bbox="592 888 1429 1003"> <tr> <td>"H2O_39F</td> <td>PSI</td> <td>MPa</td> <td>BAR</td> <td>Kg/cm^2</td> <td>inHg_32F</td> </tr> <tr> <td>mmHg_0C</td> <td>KPa</td> <td>mBAR</td> <td>g/cm^2</td> <td>mmH2O_4C</td> <td>mH2O_4C</td> </tr> <tr> <td>Custom</td> <td>%</td> <td></td> <td></td> <td></td> <td></td> </tr> </table> <p>If the transmitter is set for SQUARE ROOT output conformity, you can choose to have the Local Smart Meter display flow readings in one of these engineering units:</p> <table border="0" data-bbox="592 1150 1071 1182"> <tr> <td>GPM</td> <td>GPH</td> <td>Custom</td> <td>%</td> </tr> </table>	"H2O_39F	PSI	MPa	BAR	Kg/cm^2	inHg_32F	mmHg_0C	KPa	mBAR	g/cm^2	mmH2O_4C	mH2O_4C	Custom	%					GPM	GPH	Custom	%
"H2O_39F	PSI	MPa	BAR	Kg/cm^2	inHg_32F																		
mmHg_0C	KPa	mBAR	g/cm^2	mmH2O_4C	mH2O_4C																		
Custom	%																						
GPM	GPH	Custom	%																				
Engineering Units High and Low	<p>You can enter desired lower and upper (high) display limits to scale flow (GPM, GPH) or Custom engineering units to represent the transmitter's 0 to 100% output within the meter's display range of $\pm 19,990,000$.</p> <p>ATTENTION When the transmitter is set to SQUARE ROOT output conformity, the lower display limit for flow units (GPM, GPH) and Custom unit must equal zero (0).</p>																						

Continued on next page

6.2 Overview, Continued

Configuration decision summary

The flowchart in Figure 25 summarizes the typical entries/selections decisions associated with configuring an ST 3000 pressure transmitter.

Figure 25 Flowchart — ST 3000 Pressure Transmitter Configuration.

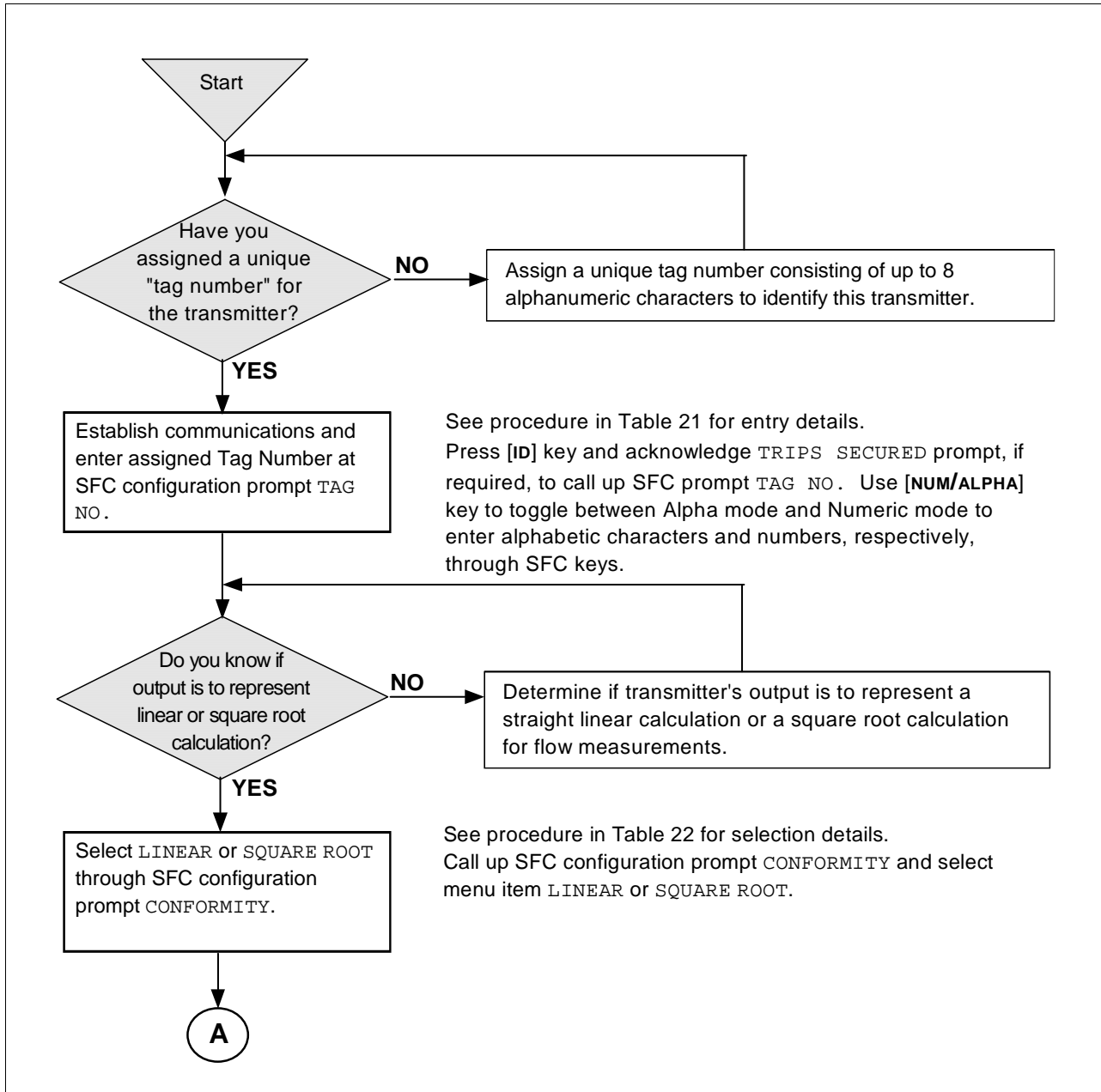

Continued on next page

6.2 Overview, Continued

Configuration decision summary, continued

Figure 25 Flowchart — ST 3000 Pressure Transmitter Configuration, continued.

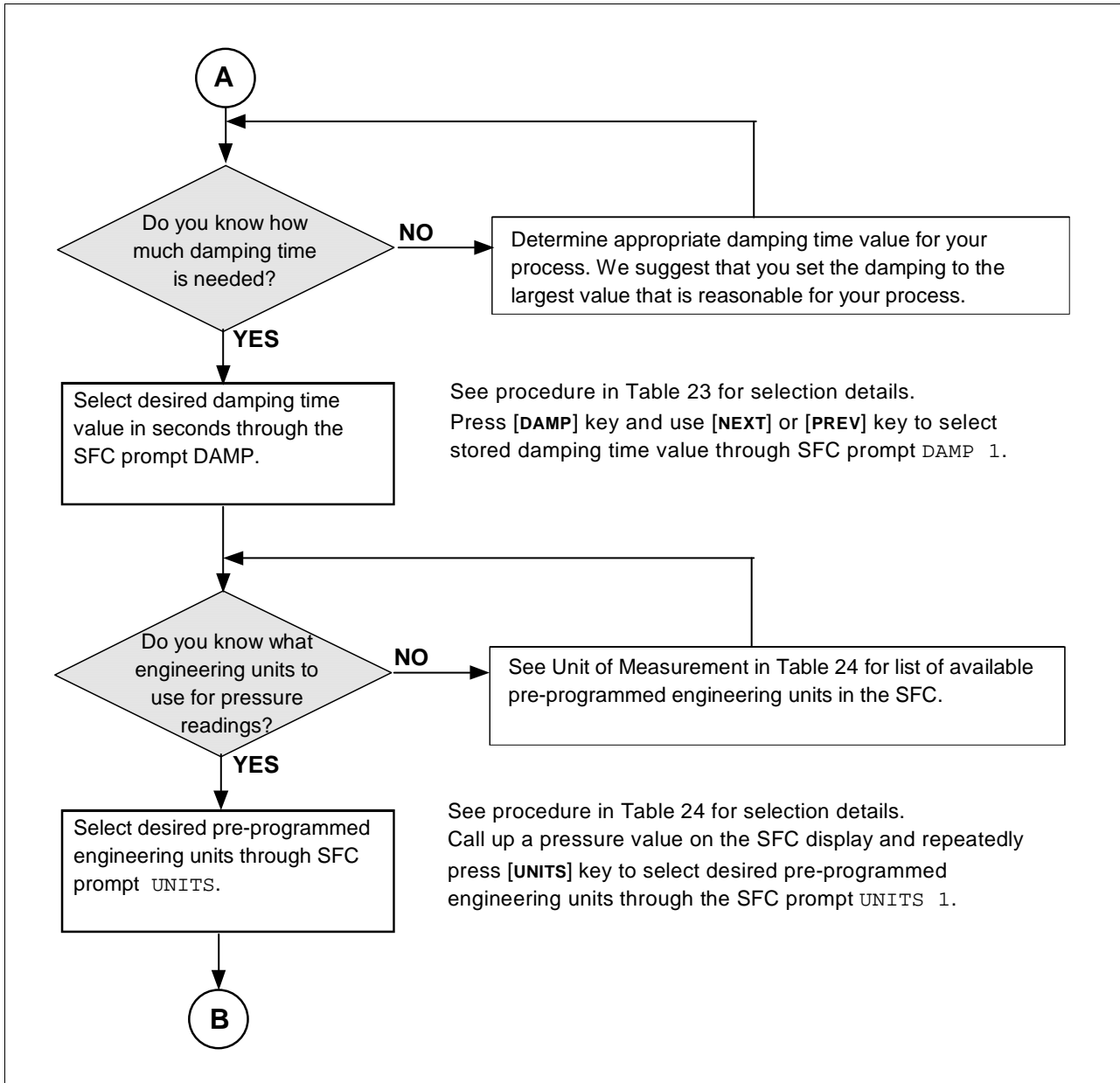

Continued on next page

6.2 Overview, Continued

Configuration decision summary, continued

Figure 25 Flowchart — ST 3000 Pressure Transmitter Configuration, continued.

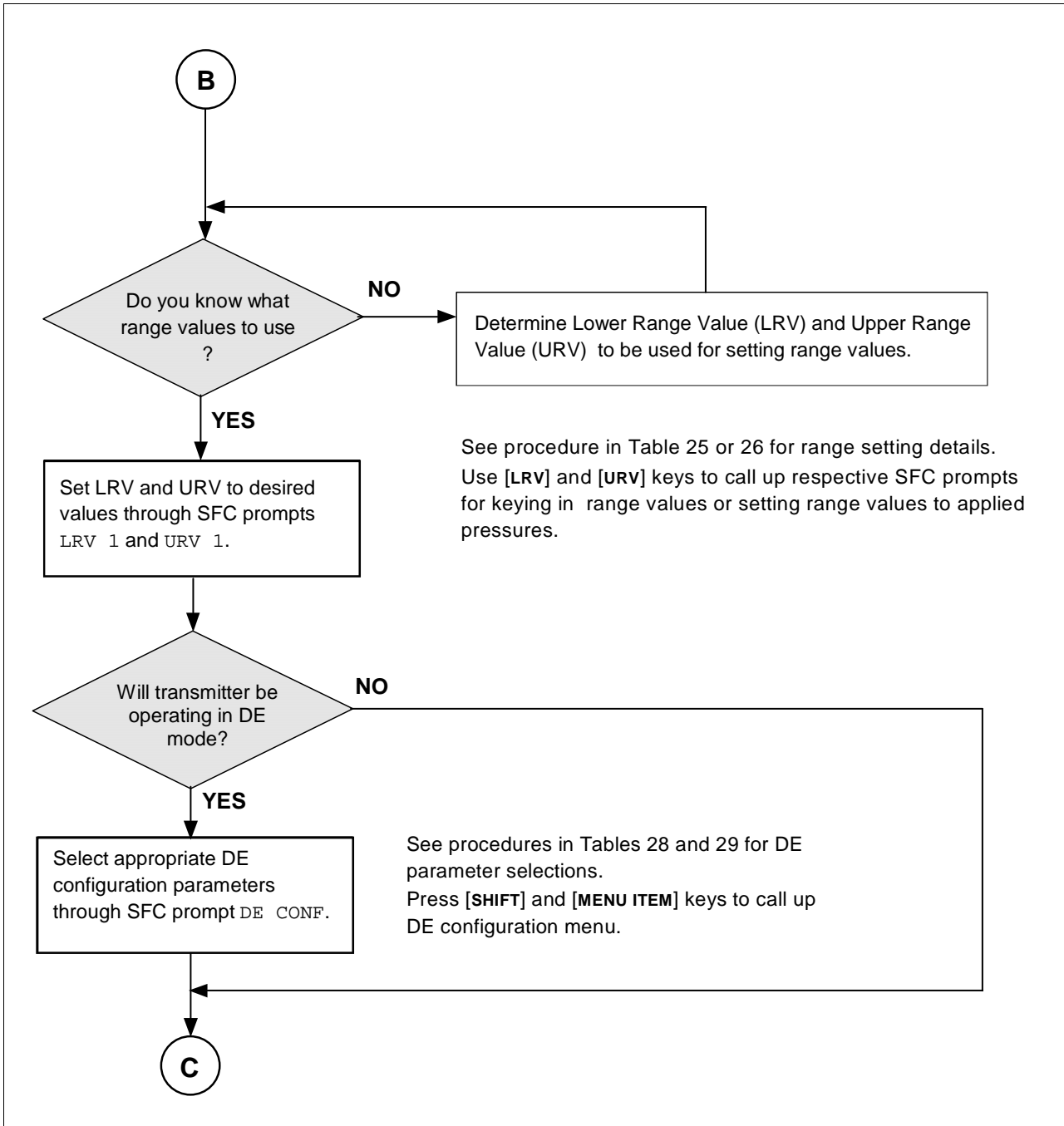

continued on next page

6.2 Overview, Continued

Configuration decision summary, continued

Figure 25 Flowchart — ST 3000 Pressure Transmitter Configuration, Continued.

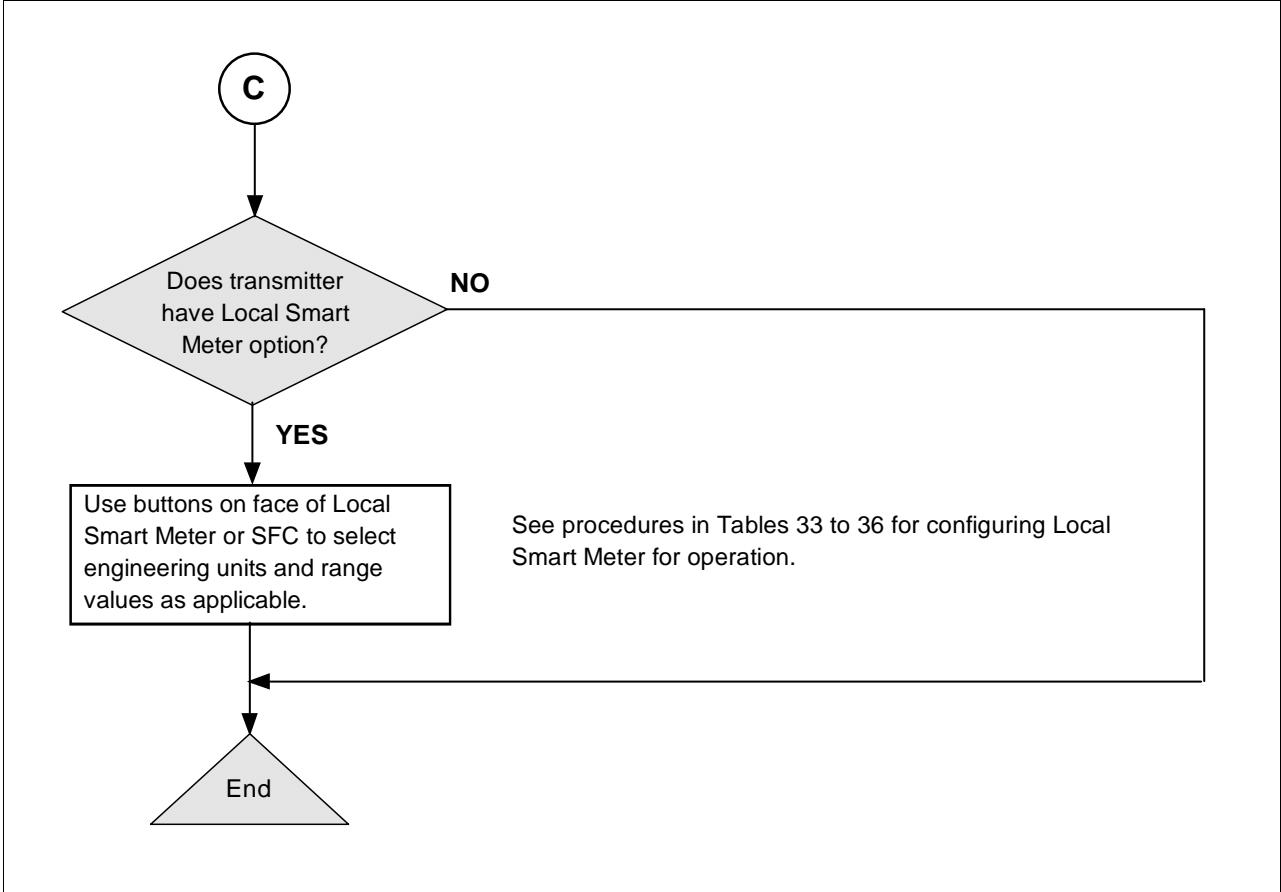

6.2 Overview, Continued

SFC interface characteristics

Keep these three basic interface characteristics in mind when you use the SFC to configure a transmitter.

- If the displayed prompt contains a cursor, you can key in a number or an alphabetic character in that space. However, to key in an alphabetic character, you must first press the [NUM/ALPHA] key to initiate the alphabet selection or alpha mode.

- Example:

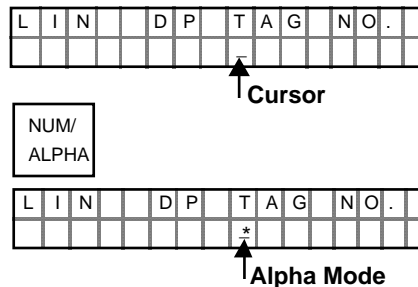

- If the displayed prompt includes an equal sign (=), you can make another selection after the equal sign by pressing the [MENU ITEM] key to call up the next selection. Note that you can use the [s NEXT] key to call up the next parameter or the [t PREV] key to return to the previous parameter.

- Example:

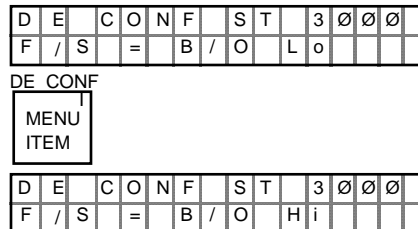

- If the displayed prompt contains a question mark (?), you can initiate the action in question by pressing the [ENTER] key to answer yes or abort it by pressing the [CLR] key to answer no.

- Example:

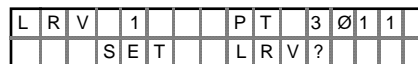

To initiate setting of LRV to applied pressure, press



To abort setting of LRV to applied pressure, press



6.3 Entering a Tag Number

ATTENTION

There is a Configuration Record Sheet provided in Appendix C, if you want to record the configuration data for your transmitter.

Procedure

The procedure in Table 21 shows how to enter a sample tag number of PT 3011 into the transmitter's configuration database.

Table 21 Entering Tag Number

Step	Press Key	Read Display or Action	Description																																																																																																
1	DE READ 	<table border="1"> <tr><td>T</td><td>A</td><td>G</td><td>N</td><td>O</td><td>.</td><td></td><td></td><td></td><td></td><td></td><td></td><td></td><td></td><td></td><td></td></tr> <tr><td>T</td><td>R</td><td>I</td><td>P</td><td>S</td><td></td><td>S</td><td>E</td><td>C</td><td>U</td><td>R</td><td>E</td><td>D</td><td>?</td><td>?</td><td></td></tr> </table>	T	A	G	N	O	.											T	R	I	P	S		S	E	C	U	R	E	D	?	?		Be sure any switches that may trip alarms or interlocks associated with analog loop are secured or turned off. This prompt only appears for transmitters in analog mode																																																																
T	A	G	N	O	.																																																																																														
T	R	I	P	S		S	E	C	U	R	E	D	?	?																																																																																					
2	NON-VOL 	<table border="1"> <tr><td>T</td><td>A</td><td>G</td><td>N</td><td>O</td><td>.</td><td></td><td></td><td></td><td></td><td></td><td></td><td></td><td></td><td></td><td></td></tr> <tr><td>S</td><td>F</td><td>C</td><td>W</td><td>O</td><td>R</td><td>K</td><td>I</td><td>N</td><td>G</td><td>.</td><td>.</td><td>.</td><td></td><td></td><td></td></tr> </table> <table border="1"> <tr><td>L</td><td>I</td><td>N</td><td></td><td>D</td><td>P</td><td>T</td><td>A</td><td>G</td><td>N</td><td>O</td><td>.</td><td></td><td></td><td></td><td></td></tr> <tr><td></td><td></td><td></td><td></td><td></td><td></td><td></td><td>-</td><td></td><td></td><td></td><td></td><td></td><td></td><td></td><td></td></tr> </table>	T	A	G	N	O	.											S	F	C	W	O	R	K	I	N	G	.	.	.				L	I	N		D	P	T	A	G	N	O	.												-									Confirm that "TRIPS" are secured and establish transmitter communications ATTENTION This procedure also applies for transmitters in DE mode. The prompt may show DE - XMTR instead of output form and transmitter type in top row, if you have not established communications as previously described in Section 5.2 of this manual.																																
T	A	G	N	O	.																																																																																														
S	F	C	W	O	R	K	I	N	G	.	.	.																																																																																							
L	I	N		D	P	T	A	G	N	O	.																																																																																								
							-																																																																																												
2		<table border="1"> <tr><td>L</td><td>I</td><td>N</td><td></td><td>D</td><td>P</td><td>T</td><td>A</td><td>G</td><td>N</td><td>O</td><td>.</td><td></td><td></td><td></td><td></td></tr> <tr><td></td><td></td><td></td><td></td><td></td><td></td><td></td><td>*</td><td></td><td></td><td></td><td></td><td></td><td></td><td></td><td></td></tr> </table>	L	I	N		D	P	T	A	G	N	O	.												*									Put SFC keyboard into alpha mode. Activates alphabetic characters in upper right hand corner of keys.																																																																
L	I	N		D	P	T	A	G	N	O	.																																																																																								
							*																																																																																												
3	 SCR PAD 	<table border="1"> <tr><td>L</td><td>I</td><td>N</td><td></td><td>D</td><td>P</td><td>T</td><td>A</td><td>G</td><td>N</td><td>O</td><td>.</td><td></td><td></td><td></td><td></td></tr> <tr><td></td><td></td><td></td><td></td><td></td><td></td><td></td><td>P</td><td>*</td><td></td><td></td><td></td><td></td><td></td><td></td><td></td></tr> </table> <table border="1"> <tr><td>L</td><td>I</td><td>N</td><td></td><td>D</td><td>P</td><td>T</td><td>A</td><td>G</td><td>N</td><td>O</td><td>.</td><td></td><td></td><td></td><td></td></tr> <tr><td></td><td></td><td></td><td></td><td></td><td></td><td></td><td>P</td><td>T</td><td>*</td><td></td><td></td><td></td><td></td><td></td><td></td></tr> </table> <table border="1"> <tr><td>L</td><td>I</td><td>N</td><td></td><td>D</td><td>P</td><td>T</td><td>A</td><td>G</td><td>N</td><td>O</td><td>.</td><td></td><td></td><td></td><td></td></tr> <tr><td></td><td></td><td></td><td></td><td></td><td></td><td></td><td>P</td><td>T</td><td>*</td><td></td><td></td><td></td><td></td><td></td><td></td></tr> </table>	L	I	N		D	P	T	A	G	N	O	.												P	*								L	I	N		D	P	T	A	G	N	O	.												P	T	*							L	I	N		D	P	T	A	G	N	O	.												P	T	*							Key in P, T, and space as first characters in tag number.
L	I	N		D	P	T	A	G	N	O	.																																																																																								
							P	*																																																																																											
L	I	N		D	P	T	A	G	N	O	.																																																																																								
							P	T	*																																																																																										
L	I	N		D	P	T	A	G	N	O	.																																																																																								
							P	T	*																																																																																										
4		<table border="1"> <tr><td>L</td><td>I</td><td>N</td><td></td><td>D</td><td>P</td><td>T</td><td>A</td><td>G</td><td>N</td><td>O</td><td>.</td><td></td><td></td><td></td><td></td></tr> <tr><td></td><td></td><td></td><td></td><td></td><td></td><td></td><td>P</td><td>T</td><td>-</td><td></td><td></td><td></td><td></td><td></td><td></td></tr> </table>	L	I	N		D	P	T	A	G	N	O	.												P	T	-							Take SFC keyboard out of alpha mode and put it into numeric mode.																																																																
L	I	N		D	P	T	A	G	N	O	.																																																																																								
							P	T	-																																																																																										

Continued on next page

6.3 Entering a Tag Number, Continued

Procedure, continued

Table 21 Entering Tag Number, continued

Step	Press Key	Read Display or Action	Description
5	SW VER X 3	L I N D P T A G N O . P T 3 _	Key in "3011" as numbers in Tag number.
	Z 0	L I N D P T A G N O . P T 3 Ø _	
	V 1	L I N D P T A G N O . P T 3 Ø 1 _	
	V 1	L I N D P T A G N O . P T 3 Ø 1 1 _	
6	NON-VOL ENTER (Yes)	L I N D P T A G N O . S F C W O R K I N G . . . L I N D P T A G N O . P T 3 Ø 1 1	Message exchange is working. Loads tag number into transmitter's working memory.

Keystroke summary

Figure 26 shows keystroke summary for entering tag number for quick reference.

Figure 26 Keystroke Summary for Entering Tag Number

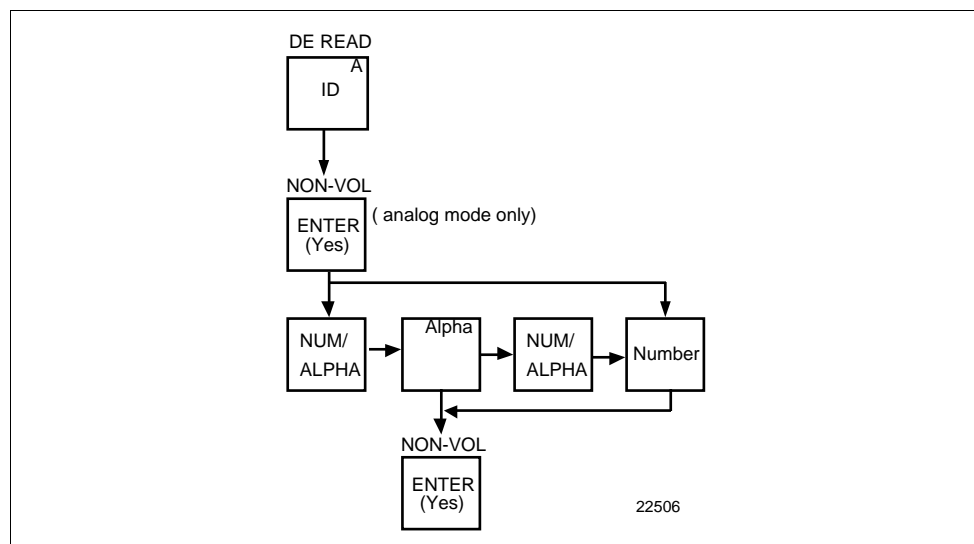

6.4 Selecting Output Form

Background

You can select the transmitter's output to represent a straight linear calculation or a square root calculation for flow measurement applications using a differential pressure type transmitter. Thus, we refer to the linear or the square root selection as the output conformity or the output form.















Procedure

The procedure in Table 22 shows how to select the desired output conformity.

ATTENTION

If the transmitter is equipped with a local smart meter, you must reconfigure the smart meter as described in Section 6.11 or 6.12 of this manual whenever you change the transmitter's output conformity.

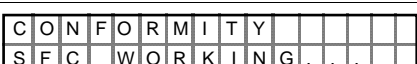
Table 22 Selecting Output Conformity

Step	Press Key	Read Display or Action	Description
1			Prompt asks if you want to access configuration parameter called conformity. If you want to access it, go to Step 2. If you do not want to access it, press [CLR] key to exit function or [s NEXT] key to call up next configuration parameter.
2		 OR 	Present output conformity is linear. Present output conformity is square root.
3		 OR 	Change output conformity to square root. Change output conformity to linear.
4		 	Conformity change is entered in SFC. Prompt asks if you want to download change to transmitter. If you want to download change, go to Step 5. If you do not want to download change, press [CLR] key to return to initial prompt in Step 1.
5		 	Message exchange is working. Output conformity is changed in transmitter. Press [s NEXT] key to call up next parameter or [CLR] key to exit function.

Continued on next page

6.4 Selecting Output Form, Continued

Keystroke summary Figure 27 shows keystroke summary for selecting output conformity for quick reference.

Figure 27 Keystroke Summary for Selecting Output Conformity.

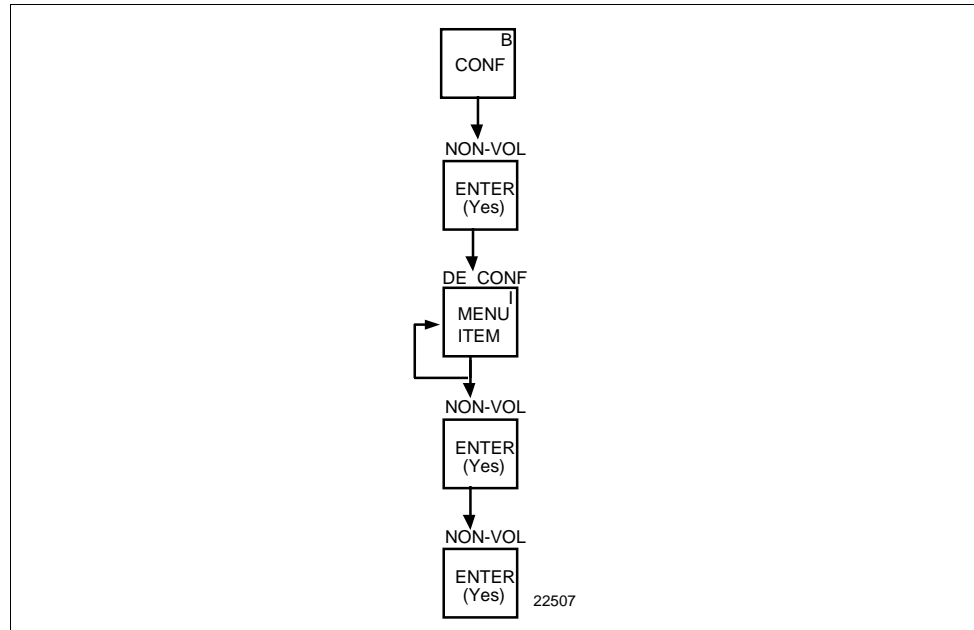

About square root output

For differential pressure transmitters measuring the pressure drop across a primary element, the flow rate is directly proportional to the square root of the differential or pressure drop. The ST 3000 transmitter's output is automatically converted to equal percent of flow when its output conformity is configured as square root.

You can use these formulas to manually calculate the percent of flow for comparison purposes.

$$\frac{\Delta P}{\text{Span}} \cdot 100 = \% P$$

Where,

- ΔP = Differential pressure input in engineering units
- Span = Transmitter's measurement span (URV – LRV)
- $\% P$ = Pressure input in percent of span

Therefore, $\sqrt{\frac{\% P}{100}} \cdot 100 = \% \text{ Flow}$

And, you can use the following formula to determine the corresponding current output in milliamperes direct current.

$$(\% \text{ Flow} \cdot 16) + 4 = \text{mA dc Output}$$

Continued on next page

6.4 Selecting Output Form, Continued

About square root output, continued

Example: If you have a differential pressure transmitter with a range of 0 to 100 inches of water with an input of 49 inches of water, substituting into the above formulas yields:

$$\frac{49}{100} \cdot 100 = 49\%$$

$$\sqrt{\frac{49\%}{100}} \cdot 100 = 70\% \text{ Flow, and}$$

$$70\% \cdot 16 + 4 = 15.2 \text{ mA dc Output}$$

Square root dropout

To avoid unstable output at readings near zero, the ST 3000 transmitter automatically drops square root conformity and changes to linear conformity for low differential pressure readings. As shown in Figure 28, the dropout point is between 0.4 and 0.5 % of differential pressure input depending on direction.

Figure 28 Square Root Dropout Points.

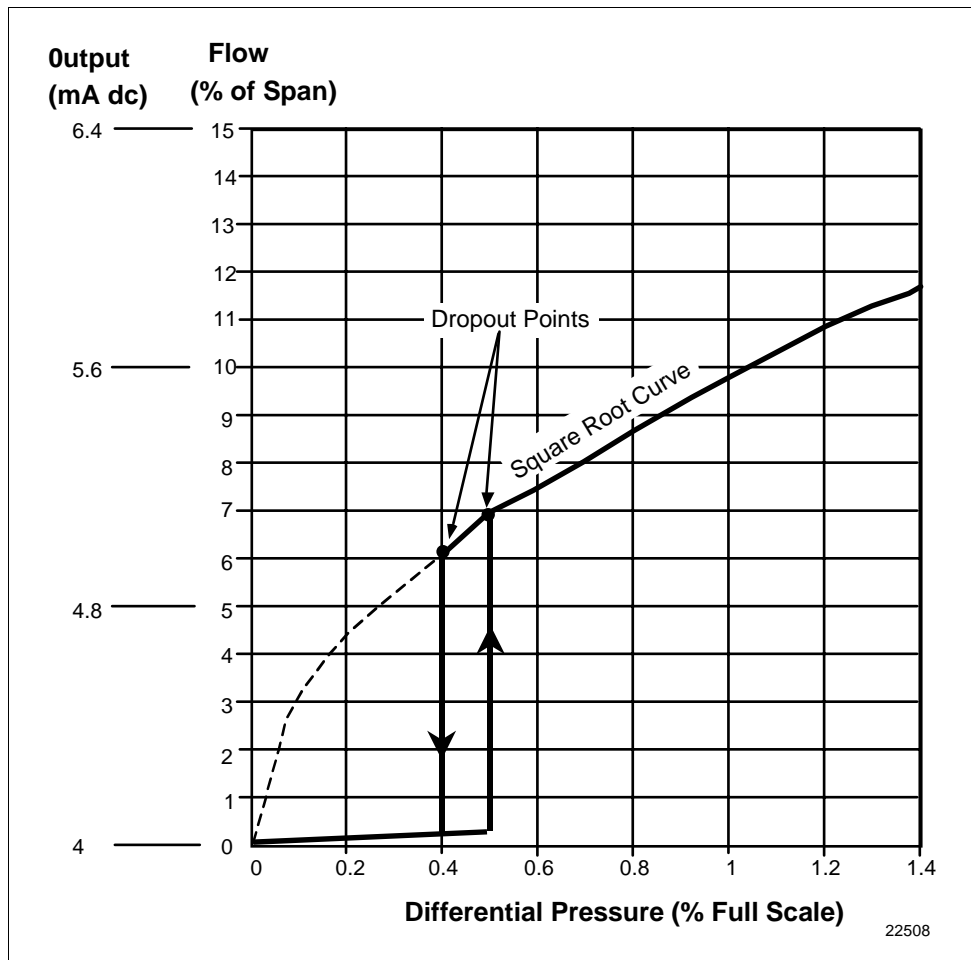

6.5 Adjusting Damping Time

Background

You can adjust the damping time to reduce the output noise. We suggest that you set the damping to the smallest value that is reasonable for your process.

ATTENTION

The electrical noise effect on the output signal is partially related to the turndown ratio of the transmitter. As the turndown ratio increases, the peak-to-peak noise on the output signal increases. You can use this formula to find the turndown ratio using the range information for your transmitter.

$$\text{Turndown Ratio} = \frac{\text{Upper Range Limit}}{(\text{Upper Range Value} - \text{Lower Range Value})}$$



Example: The turndown ratio for a 400 inH₂O transmitter with a range of 0 to 50 inH₂O would be:

$$\text{Turndown Ratio} = \frac{400}{(50 - 0)} = \frac{8}{1} \text{ or } 8:1$$

Procedure

The procedure in Table 23 outlines the keystrokes used to adjust the damping time to two seconds as an example.

Table 23 Adjusting Damping Time

Step	Press Key	Read Display or Action	Description																																																						
1		<table border="1" style="font-family: monospace; font-size: 0.8em;"> <tr><td>D</td><td>A</td><td>M</td><td>P</td><td>1</td><td></td><td>P</td><td>T</td><td>3</td><td>0</td><td>1</td><td>1</td></tr> <tr><td></td><td></td><td></td><td></td><td>.</td><td>3</td><td></td><td></td><td>S</td><td>E</td><td>C</td><td>O</td><td>N</td><td>D</td><td>S</td></tr> </table>	D	A	M	P	1		P	T	3	0	1	1					.	3			S	E	C	O	N	D	S	Present damping time in seconds																											
D	A	M	P	1		P	T	3	0	1	1																																														
				.	3			S	E	C	O	N	D	S																																											
2		<table border="1" style="font-family: monospace; font-size: 0.8em;"> <tr><td>D</td><td>A</td><td>M</td><td>P</td><td>1</td><td></td><td>P</td><td>T</td><td>3</td><td>0</td><td>1</td><td>1</td></tr> <tr><td>S</td><td>F</td><td>C</td><td></td><td>W</td><td>O</td><td>R</td><td>K</td><td>I</td><td>N</td><td>G</td><td>.</td><td>.</td><td>.</td><td></td></tr> </table> <table border="1" style="font-family: monospace; font-size: 0.8em;"> <tr><td>D</td><td>A</td><td>M</td><td>P</td><td>1</td><td></td><td>P</td><td>T</td><td>3</td><td>0</td><td>1</td><td>1</td></tr> <tr><td></td><td></td><td></td><td></td><td>.</td><td>5</td><td></td><td></td><td>S</td><td>E</td><td>C</td><td>O</td><td>N</td><td>D</td><td>S</td></tr> </table>	D	A	M	P	1		P	T	3	0	1	1	S	F	C		W	O	R	K	I	N	G	.	.	.		D	A	M	P	1		P	T	3	0	1	1					.	5			S	E	C	O	N	D	S	Message exchange is working. Next highest damping time value in seconds.
D	A	M	P	1		P	T	3	0	1	1																																														
S	F	C		W	O	R	K	I	N	G	.	.	.																																												
D	A	M	P	1		P	T	3	0	1	1																																														
				.	5			S	E	C	O	N	D	S																																											
3		Repeat Step 2 until display shows <table border="1" style="font-family: monospace; font-size: 0.8em;"> <tr><td>D</td><td>A</td><td>M</td><td>P</td><td>1</td><td></td><td>P</td><td>T</td><td>3</td><td>0</td><td>1</td><td>1</td></tr> <tr><td></td><td></td><td></td><td></td><td>.</td><td>2</td><td></td><td></td><td>S</td><td>E</td><td>C</td><td>O</td><td>N</td><td>D</td><td>S</td></tr> </table>	D	A	M	P	1		P	T	3	0	1	1					.	2			S	E	C	O	N	D	S	Transmitter's damping time is now set to two seconds.																											
D	A	M	P	1		P	T	3	0	1	1																																														
				.	2			S	E	C	O	N	D	S																																											

ATTENTION The [s NEXT] key raises the setting while the [t PREV] key lowers the setting. Or, you can key in a number that will be converted to closest damping value listed in Table 20.

ATTENTION You do not need to press the [ENTER] key to store the damping time in the transmitter's memory.

Continued on next page

6.5 Adjusting Damping Time, Continued

Keystroke summary Figure 29 shows keystroke summary for adjusting damping time for quick reference.

Figure 29 Keystroke Summary for Adjusting Damping Time

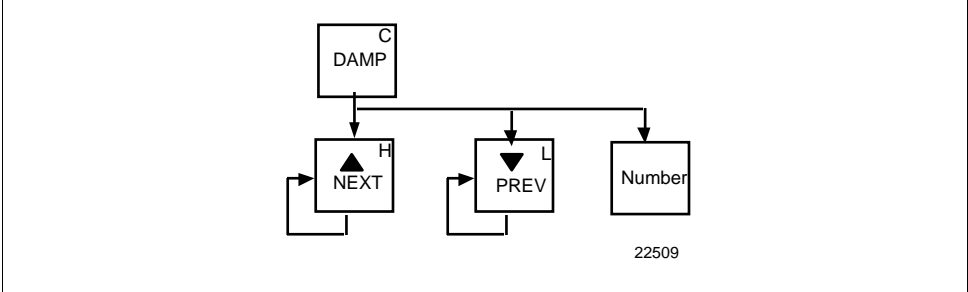

6.6 Selecting Unit of Measurement

Background

You can choose to have the pressure measurements displayed in one of the preprogrammed engineering units in the SFC.

Procedure

Table 24 lists the pre-programmed units and shows how to select them.

ATTENTION

The engineering units shown in Table 23 are only available in an SFC with software version 3.2 or greater. The selections are similar in other software versions but without temperature references and minus the inches of water at 68°F (20°C) engineering units.

Table 24 Pre-Programmed Engineering Units for Selection

IF you want URV, LRV, etc. displayed in ...	THEN sequentially press <table border="1" style="display: inline-table; vertical-align: middle;"><tr><td>U</td><td>N</td><td>I</td><td>T</td><td>S</td></tr><tr><td> </td><td> </td><td> </td><td> </td><td> </td></tr></table> key until display shows...	U	N	I	T	S																											
U	N	I	T	S																													
inches of water at 39.2°F (4°C)	<table border="1" style="display: inline-table; vertical-align: middle;"> <tr><td>U</td><td>N</td><td>I</td><td>T</td><td>S</td><td> </td><td>1</td><td> </td><td>P</td><td>T</td><td> </td><td>3</td><td>0</td><td>1</td><td> </td><td>1</td></tr> <tr><td> </td><td> </td><td> </td><td> </td><td> </td><td> </td><td> </td><td> </td><td>"</td><td>H</td><td>2</td><td>O</td><td>-</td><td>3</td><td>9</td><td>F</td></tr> </table>	U	N	I	T	S		1		P	T		3	0	1		1									"	H	2	O	-	3	9	F
U	N	I	T	S		1		P	T		3	0	1		1																		
								"	H	2	O	-	3	9	F																		
inches of water at 68°F (20°C)	<table border="1" style="display: inline-table; vertical-align: middle;"> <tr><td>U</td><td>N</td><td>I</td><td>T</td><td>S</td><td> </td><td>1</td><td> </td><td>P</td><td>T</td><td> </td><td>3</td><td>0</td><td>1</td><td> </td><td>1</td></tr> <tr><td> </td><td> </td><td> </td><td> </td><td> </td><td> </td><td> </td><td> </td><td>"</td><td>H</td><td>2</td><td>O</td><td>-</td><td>6</td><td>8</td><td>F</td></tr> </table>	U	N	I	T	S		1		P	T		3	0	1		1									"	H	2	O	-	6	8	F
U	N	I	T	S		1		P	T		3	0	1		1																		
								"	H	2	O	-	6	8	F																		
millimeters of mercury at 0°C (32°F)	<table border="1" style="display: inline-table; vertical-align: middle;"> <tr><td>U</td><td>N</td><td>I</td><td>T</td><td>S</td><td> </td><td>1</td><td> </td><td>P</td><td>T</td><td> </td><td>3</td><td>0</td><td>1</td><td> </td><td>1</td></tr> <tr><td> </td><td> </td><td> </td><td> </td><td> </td><td> </td><td> </td><td> </td><td>m</td><td>m</td><td>H</td><td>g</td><td>-</td><td>Ø</td><td>C</td><td> </td></tr> </table>	U	N	I	T	S		1		P	T		3	0	1		1									m	m	H	g	-	Ø	C	
U	N	I	T	S		1		P	T		3	0	1		1																		
								m	m	H	g	-	Ø	C																			
pounds per square inch	<table border="1" style="display: inline-table; vertical-align: middle;"> <tr><td>U</td><td>N</td><td>I</td><td>T</td><td>S</td><td> </td><td>1</td><td> </td><td>P</td><td>T</td><td> </td><td>3</td><td>0</td><td>1</td><td> </td><td>1</td></tr> <tr><td> </td><td> </td><td> </td><td> </td><td> </td><td> </td><td> </td><td> </td><td>P</td><td>S</td><td>I</td><td> </td><td> </td><td> </td><td> </td><td> </td></tr> </table>	U	N	I	T	S		1		P	T		3	0	1		1									P	S	I					
U	N	I	T	S		1		P	T		3	0	1		1																		
								P	S	I																							
kilopascals	<table border="1" style="display: inline-table; vertical-align: middle;"> <tr><td>U</td><td>N</td><td>I</td><td>T</td><td>S</td><td> </td><td>1</td><td> </td><td>P</td><td>T</td><td> </td><td>3</td><td>0</td><td>1</td><td> </td><td>1</td></tr> <tr><td> </td><td> </td><td> </td><td> </td><td> </td><td> </td><td> </td><td> </td><td>K</td><td>P</td><td>a</td><td> </td><td> </td><td> </td><td> </td><td> </td></tr> </table>	U	N	I	T	S		1		P	T		3	0	1		1									K	P	a					
U	N	I	T	S		1		P	T		3	0	1		1																		
								K	P	a																							
megapascals	<table border="1" style="display: inline-table; vertical-align: middle;"> <tr><td>U</td><td>N</td><td>I</td><td>T</td><td>S</td><td> </td><td>1</td><td> </td><td>P</td><td>T</td><td> </td><td>3</td><td>0</td><td>1</td><td> </td><td>1</td></tr> <tr><td> </td><td> </td><td> </td><td> </td><td> </td><td> </td><td> </td><td> </td><td>M</td><td>P</td><td>a</td><td> </td><td> </td><td> </td><td> </td><td> </td></tr> </table>	U	N	I	T	S		1		P	T		3	0	1		1									M	P	a					
U	N	I	T	S		1		P	T		3	0	1		1																		
								M	P	a																							
millibar	<table border="1" style="display: inline-table; vertical-align: middle;"> <tr><td>U</td><td>N</td><td>I</td><td>T</td><td>S</td><td> </td><td>1</td><td> </td><td>P</td><td>T</td><td> </td><td>3</td><td>0</td><td>1</td><td> </td><td>1</td></tr> <tr><td> </td><td> </td><td> </td><td> </td><td> </td><td> </td><td> </td><td> </td><td>m</td><td>B</td><td>A</td><td>R</td><td> </td><td> </td><td> </td><td> </td></tr> </table>	U	N	I	T	S		1		P	T		3	0	1		1									m	B	A	R				
U	N	I	T	S		1		P	T		3	0	1		1																		
								m	B	A	R																						
bar	<table border="1" style="display: inline-table; vertical-align: middle;"> <tr><td>U</td><td>N</td><td>I</td><td>T</td><td>S</td><td> </td><td>1</td><td> </td><td>P</td><td>T</td><td> </td><td>3</td><td>0</td><td>1</td><td> </td><td>1</td></tr> <tr><td> </td><td> </td><td> </td><td> </td><td> </td><td> </td><td> </td><td> </td><td>B</td><td>A</td><td>R</td><td> </td><td> </td><td> </td><td> </td><td> </td></tr> </table>	U	N	I	T	S		1		P	T		3	0	1		1									B	A	R					
U	N	I	T	S		1		P	T		3	0	1		1																		
								B	A	R																							
grams per square centimeter	<table border="1" style="display: inline-table; vertical-align: middle;"> <tr><td>U</td><td>N</td><td>I</td><td>T</td><td>S</td><td> </td><td>1</td><td> </td><td>P</td><td>T</td><td> </td><td>3</td><td>0</td><td>1</td><td> </td><td>1</td></tr> <tr><td> </td><td> </td><td> </td><td> </td><td> </td><td> </td><td> </td><td> </td><td>g</td><td>/</td><td>c</td><td>m</td><td>^</td><td>2</td><td> </td><td> </td></tr> </table>	U	N	I	T	S		1		P	T		3	0	1		1									g	/	c	m	^	2		
U	N	I	T	S		1		P	T		3	0	1		1																		
								g	/	c	m	^	2																				
kilograms per square centimeter	<table border="1" style="display: inline-table; vertical-align: middle;"> <tr><td>U</td><td>N</td><td>I</td><td>T</td><td>S</td><td> </td><td>1</td><td> </td><td>P</td><td>T</td><td> </td><td>3</td><td>0</td><td>1</td><td> </td><td>1</td></tr> <tr><td> </td><td> </td><td> </td><td> </td><td> </td><td> </td><td> </td><td> </td><td>K</td><td>G</td><td>/</td><td>c</td><td>m</td><td>^</td><td>2</td><td> </td></tr> </table>	U	N	I	T	S		1		P	T		3	0	1		1									K	G	/	c	m	^	2	
U	N	I	T	S		1		P	T		3	0	1		1																		
								K	G	/	c	m	^	2																			

Continued on next page

6.6 Selecting Unit of Measurement, Continued

Procedure, continued

Table 24 Pre-Programmed Engineering Units for Selection, continued

IF you want URV, LRV, etc. displayed in ...	THEN sequentially press  key until display shows...																										
inches of mercury at 32°F (0°C)	<table border="1" data-bbox="935 527 1349 585"> <tr> <td>U</td><td>N</td><td>I</td><td>T</td><td>S</td><td>1</td><td>P</td><td>T</td><td>3</td><td>0</td><td>1</td><td>1</td> </tr> <tr> <td></td><td></td><td></td><td></td><td></td><td></td><td>i</td><td>n</td><td>H</td><td>g</td><td>-</td><td>3</td><td>2</td><td>F</td> </tr> </table>	U	N	I	T	S	1	P	T	3	0	1	1							i	n	H	g	-	3	2	F
U	N	I	T	S	1	P	T	3	0	1	1																
						i	n	H	g	-	3	2	F														
millimeters of water at 4°C (39.2°F)	<table border="1" data-bbox="935 625 1349 684"> <tr> <td>U</td><td>N</td><td>I</td><td>T</td><td>S</td><td>1</td><td>P</td><td>T</td><td>3</td><td>0</td><td>1</td><td>1</td> </tr> <tr> <td></td><td></td><td></td><td></td><td></td><td></td><td>m</td><td>m</td><td>H</td><td>2</td><td>O</td><td>-</td><td>4</td><td>C</td> </tr> </table>	U	N	I	T	S	1	P	T	3	0	1	1							m	m	H	2	O	-	4	C
U	N	I	T	S	1	P	T	3	0	1	1																
						m	m	H	2	O	-	4	C														
meters of water at 4°C (39.2°F)	<table border="1" data-bbox="935 724 1349 783"> <tr> <td>U</td><td>N</td><td>I</td><td>T</td><td>S</td><td>1</td><td>P</td><td>T</td><td>3</td><td>0</td><td>1</td><td>1</td> </tr> <tr> <td></td><td></td><td></td><td></td><td></td><td></td><td>m</td><td>H</td><td>2</td><td>O</td><td>-</td><td>4</td><td>C</td> </tr> </table>	U	N	I	T	S	1	P	T	3	0	1	1							m	H	2	O	-	4	C	
U	N	I	T	S	1	P	T	3	0	1	1																
						m	H	2	O	-	4	C															
normal atmospheres	<table border="1" data-bbox="935 810 1349 869"> <tr> <td>U</td><td>N</td><td>I</td><td>T</td><td>S</td><td>1</td><td>P</td><td>T</td><td>3</td><td>0</td><td>1</td><td>1</td> </tr> <tr> <td></td><td></td><td></td><td></td><td></td><td></td><td>A</td><td>T</td><td>M</td><td></td><td></td><td></td> </tr> </table>	U	N	I	T	S	1	P	T	3	0	1	1							A	T	M					
U	N	I	T	S	1	P	T	3	0	1	1																
						A	T	M																			
inches of water at 60°F (15.6°C)	<table border="1" data-bbox="935 896 1349 955"> <tr> <td>U</td><td>N</td><td>I</td><td>T</td><td>S</td><td>1</td><td>P</td><td>T</td><td>3</td><td>0</td><td>1</td><td>1</td> </tr> <tr> <td></td><td></td><td></td><td></td><td></td><td></td><td>"</td><td>H</td><td>2</td><td>O</td><td>-</td><td>6</td><td>0</td><td>F</td> </tr> </table>	U	N	I	T	S	1	P	T	3	0	1	1							"	H	2	O	-	6	0	F
U	N	I	T	S	1	P	T	3	0	1	1																
						"	H	2	O	-	6	0	F														

6.7 Setting Range Values Using SFC

Background

You can set the LRV and URV by either keying in the desired values through the SFC keyboard or applying the corresponding LRV and URV pressures directly to the transmitter.







ATTENTION

- We factory calibrate ST 3000 Smart Transmitters with inches of water ranges using inches of water pressure referenced to a temperature of 39.2°F (4°C).
- For a reverse range, enter the upper range value as the LRV and the lower range value as the URV. For example, to make a 0 to 50 psi range a reverse range, enter 50 as the LRV and 0 as the URV.
- The URV changes automatically to compensate for any changes in the LRV and maintain the present span (URV – LRV).
- If you must change both the LRV and URV, always change the LRV first.

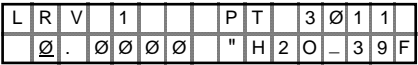
Procedure 1

Table 25 gives the procedure for the range values for a sample 5 to 45 inH₂O at 39.2°F (4°C) range.

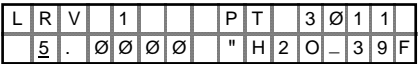
Table 25 Keying in LRV and URV

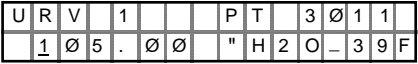
Step	Press Key	Read Display or Action	Description
1			Present LRV setting. (Pressure for 4 mA dc (0%) output.)
2			Key in desired LRV setting. (It is not necessary to key in a decimal point and zeros for a whole number.)
3	NON-VOL 	 	Message exchange is working. New LRV setting stored in transmitter's working memory.
4			Present URV setting. (Pressure for 20 mA dc (100%) output.)

Continued on next page

6.7 Setting Range Values Using SFC, Continued

Procedure 1, continued

Table 25 Keying in LRV and URV, continued

Step	Press Key	Read Display or Action	Description																										
5		<table border="1"> <tr><td>U</td><td>R</td><td>V</td><td>1</td><td></td><td></td><td>P</td><td>T</td><td>3</td><td>Ø</td><td>1</td><td>1</td></tr> <tr><td>4</td><td>-</td><td></td><td></td><td></td><td></td><td>"</td><td>H</td><td>2</td><td>O</td><td>-</td><td>3</td><td>9</td><td>F</td></tr> </table>	U	R	V	1			P	T	3	Ø	1	1	4	-					"	H	2	O	-	3	9	F	Key in 45 as desired URV setting.
	U	R	V	1			P	T	3	Ø	1	1																	
4	-					"	H	2	O	-	3	9	F																
	<table border="1"> <tr><td>U</td><td>R</td><td>V</td><td>1</td><td></td><td></td><td>P</td><td>T</td><td>3</td><td>Ø</td><td>1</td><td>1</td></tr> <tr><td>4</td><td>5</td><td>-</td><td></td><td></td><td></td><td>"</td><td>H</td><td>2</td><td>O</td><td>-</td><td>3</td><td>9</td><td>F</td></tr> </table>	U	R	V	1			P	T	3	Ø	1	1	4	5	-				"	H	2	O	-	3	9	F		
U	R	V	1			P	T	3	Ø	1	1																		
4	5	-				"	H	2	O	-	3	9	F																
6	NON-VOL	<table border="1"> <tr><td>U</td><td>R</td><td>V</td><td>1</td><td></td><td></td><td>P</td><td>T</td><td>3</td><td>Ø</td><td>1</td><td>1</td></tr> <tr><td>S</td><td>F</td><td>C</td><td>W</td><td>O</td><td>R</td><td>K</td><td>I</td><td>N</td><td>G</td><td>.</td><td>.</td><td>.</td><td>.</td></tr> </table>	U	R	V	1			P	T	3	Ø	1	1	S	F	C	W	O	R	K	I	N	G	Message exchange is working. New URV setting stored in transmitter's working memory.
	U	R	V	1			P	T	3	Ø	1	1																	
S	F	C	W	O	R	K	I	N	G																
	<table border="1"> <tr><td>U</td><td>R</td><td>V</td><td>1</td><td></td><td></td><td>P</td><td>T</td><td>3</td><td>Ø</td><td>1</td><td>1</td></tr> <tr><td>4</td><td>5</td><td>.</td><td>Ø</td><td>Ø</td><td>Ø</td><td>"</td><td>H</td><td>2</td><td>O</td><td>-</td><td>3</td><td>9</td><td>F</td></tr> </table>	U	R	V	1			P	T	3	Ø	1	1	4	5	.	Ø	Ø	Ø	"	H	2	O	-	3	9	F		
U	R	V	1			P	T	3	Ø	1	1																		
4	5	.	Ø	Ø	Ø	"	H	2	O	-	3	9	F																

Keystroke 1 summary Figure 30 shows keystroke summary for keying in LRV and URV for quick reference.

Figure 30 Keystroke Summary for Keying in LRV and URV.

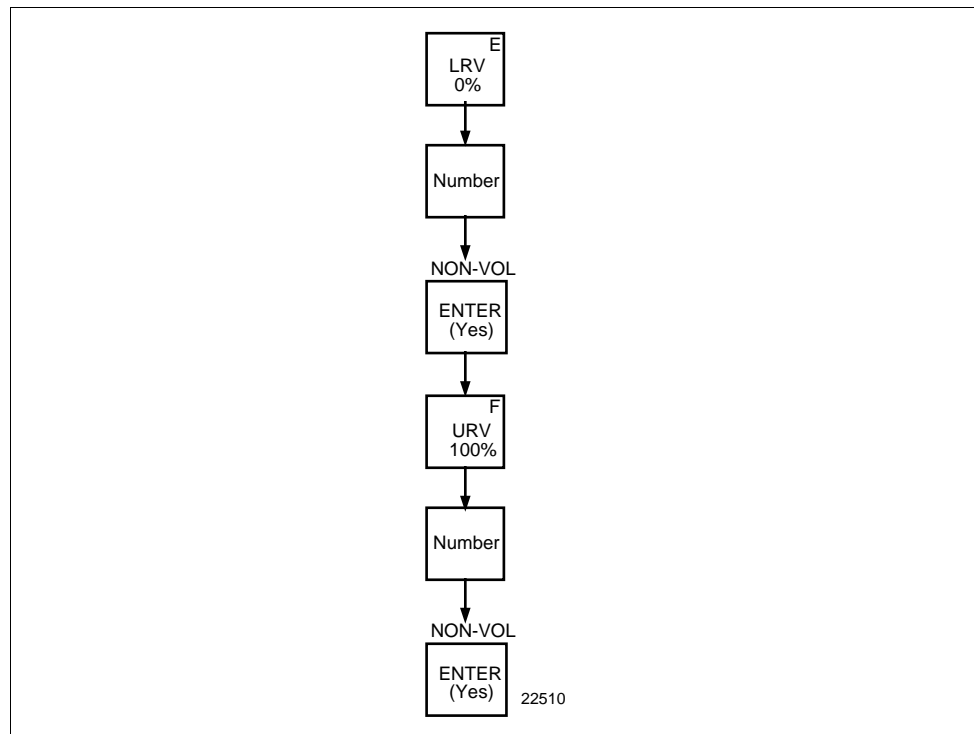







Continued on next page

6.7 Setting Range Values Using SFC, Continued

Procedure 2

Table 26 gives the procedure for setting range values to sample applied pressures.

Table 26 Setting LRV and URV to Applied Pressures









Step	Press Key	Read Display or Action	Description																																																			
1		Apply known input pressure to transmitter that represents LRV for 0% (4 mAdc) output.																																																				
2		<table border="1" data-bbox="511 640 925 703"> <tr><td>L</td><td>R</td><td>V</td><td>1</td><td></td><td></td><td>P</td><td>T</td><td>3</td><td>0</td><td>1</td><td>1</td></tr> <tr><td>.</td><td>5</td><td>.</td><td>0</td><td>0</td><td>0</td><td>"</td><td>H</td><td>2</td><td>O</td><td>-</td><td>3</td><td>9</td><td>F</td></tr> </table>	L	R	V	1			P	T	3	0	1	1	.	5	.	0	0	0	"	H	2	O	-	3	9	F	Present LRV setting. (Pressure for 4 mAdc (0%) output.)																									
L	R	V	1			P	T	3	0	1	1																																											
.	5	.	0	0	0	"	H	2	O	-	3	9	F																																									
3		<table border="1" data-bbox="511 745 925 808"> <tr><td>L</td><td>R</td><td>V</td><td>1</td><td></td><td></td><td>P</td><td>T</td><td>3</td><td>0</td><td>1</td><td>1</td></tr> <tr><td></td><td></td><td></td><td>S</td><td>E</td><td>T</td><td>L</td><td>R</td><td>V</td><td>?</td><td></td><td></td></tr> </table>	L	R	V	1			P	T	3	0	1	1				S	E	T	L	R	V	?			Prompt asks if you want to set LRV to applied pressure. If you don't want to set LRV, press [CLR] key to exit function. Otherwise, go to Step 4.																											
L	R	V	1			P	T	3	0	1	1																																											
			S	E	T	L	R	V	?																																													
4		<table border="1" data-bbox="511 913 925 976"> <tr><td>L</td><td>R</td><td>V</td><td>1</td><td></td><td></td><td>P</td><td>T</td><td>3</td><td>0</td><td>1</td><td>1</td></tr> <tr><td>S</td><td>F</td><td>C</td><td>W</td><td>O</td><td>R</td><td>K</td><td>I</td><td>N</td><td>G</td><td>.</td><td>.</td><td>.</td></tr> </table> <table border="1" data-bbox="511 997 925 1060"> <tr><td>L</td><td>R</td><td>V</td><td>1</td><td></td><td></td><td>P</td><td>T</td><td>3</td><td>0</td><td>1</td><td>1</td></tr> <tr><td>Z</td><td>.</td><td>8</td><td>3</td><td>7</td><td>7</td><td>"</td><td>H</td><td>2</td><td>O</td><td>-</td><td>3</td><td>9</td><td>F</td></tr> </table>	L	R	V	1			P	T	3	0	1	1	S	F	C	W	O	R	K	I	N	G	.	.	.	L	R	V	1			P	T	3	0	1	1	Z	.	8	3	7	7	"	H	2	O	-	3	9	F	Message exchange is working. Applied LRV setting stored in transmitter's working memory.
L	R	V	1			P	T	3	0	1	1																																											
S	F	C	W	O	R	K	I	N	G	.	.	.																																										
L	R	V	1			P	T	3	0	1	1																																											
Z	.	8	3	7	7	"	H	2	O	-	3	9	F																																									
5		Apply known input pressure to transmitter that represents URV for 100% (20 mAdc) output.																																																				
6		<table border="1" data-bbox="511 1207 925 1270"> <tr><td>U</td><td>R</td><td>V</td><td>1</td><td></td><td></td><td>P</td><td>T</td><td>3</td><td>0</td><td>1</td><td>1</td></tr> <tr><td>.</td><td>4</td><td>7</td><td>.</td><td>8</td><td>3</td><td>7</td><td>"</td><td>H</td><td>2</td><td>O</td><td>-</td><td>3</td><td>9</td><td>F</td></tr> </table>	U	R	V	1			P	T	3	0	1	1	.	4	7	.	8	3	7	"	H	2	O	-	3	9	F	Present URV setting. (Pressure for 20 mAdc (100%) output.)																								
U	R	V	1			P	T	3	0	1	1																																											
.	4	7	.	8	3	7	"	H	2	O	-	3	9	F																																								
7		<table border="1" data-bbox="511 1312 925 1375"> <tr><td>U</td><td>R</td><td>V</td><td>1</td><td></td><td></td><td>P</td><td>T</td><td>3</td><td>0</td><td>1</td><td>1</td></tr> <tr><td></td><td></td><td></td><td>S</td><td>E</td><td>T</td><td>U</td><td>R</td><td>V</td><td>?</td><td></td><td></td></tr> </table>	U	R	V	1			P	T	3	0	1	1				S	E	T	U	R	V	?			Prompt asks if you want to set URV to applied pressure. If you don't want to set URV, press [CLR] key to exit function. Otherwise, go to Step 8.																											
U	R	V	1			P	T	3	0	1	1																																											
			S	E	T	U	R	V	?																																													
8		<table border="1" data-bbox="511 1480 925 1543"> <tr><td>U</td><td>R</td><td>V</td><td>1</td><td></td><td></td><td>P</td><td>T</td><td>3</td><td>0</td><td>1</td><td>1</td></tr> <tr><td>S</td><td>F</td><td>C</td><td>W</td><td>O</td><td>R</td><td>K</td><td>I</td><td>N</td><td>G</td><td>.</td><td>.</td><td>.</td></tr> </table> <table border="1" data-bbox="511 1575 925 1638"> <tr><td>U</td><td>R</td><td>V</td><td>1</td><td></td><td></td><td>P</td><td>T</td><td>3</td><td>0</td><td>1</td><td>1</td></tr> <tr><td>.</td><td>5</td><td>5</td><td>.</td><td>4</td><td>8</td><td>2</td><td></td><td></td><td></td><td></td><td></td></tr> </table>	U	R	V	1			P	T	3	0	1	1	S	F	C	W	O	R	K	I	N	G	.	.	.	U	R	V	1			P	T	3	0	1	1	.	5	5	.	4	8	2						Message exchange is working. Applied URV setting stored in transmitter's working memory.		
U	R	V	1			P	T	3	0	1	1																																											
S	F	C	W	O	R	K	I	N	G	.	.	.																																										
U	R	V	1			P	T	3	0	1	1																																											
.	5	5	.	4	8	2																																																

Continued on next page

6.7 Setting Range Values Using SFC, Continued

Procedure 2,
continued

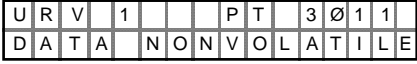
Table 26 Setting LRV and URV to Applied Pressures, continued

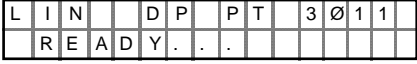
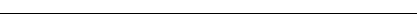
Step	Press Key	Read Display or Action	Description
9	 NON-VOL 	 	Initiates shift key selection. Saves data in transmitter's non-volatile memory. This takes approximately 8 seconds.
		 	
		 	
		 	

Keystroke 2 summary Figure 31 shows keystroke summary for setting LRV and URV to applied pressures for quick reference.

Figure 31 Keystroke Summary for Setting LRV and URV to Applied Pressures.

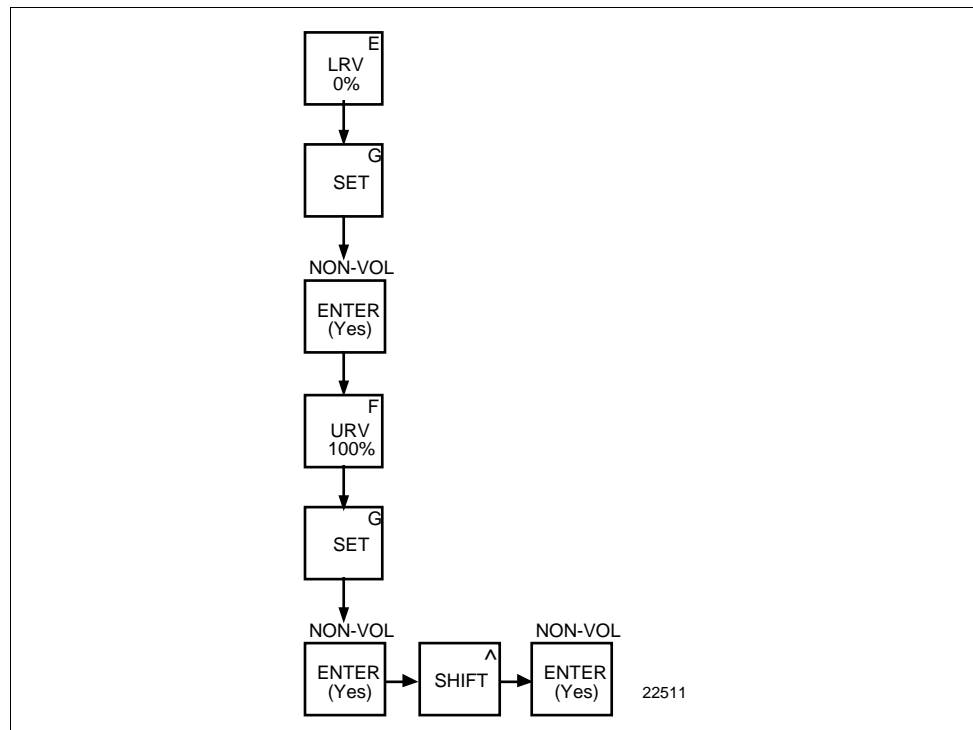

6.8 Setting Range Values Using Local Adjustments

Local zero and span option

ST 3000 Release 300 transmitters are available with optional local zero and span adjustments. This option is for applications that do not require an SFC nor digital integration with our TPS system.

About local adjustments

You must apply equivalent zero and span pressures to make the local zero and span adjustments. This is similar to setting the LRV and URV to applied pressures using the SFC.

ATTENTION

After making any adjustments to the Smart Meter, keep the transmitter powered for at least 30 seconds so that the new meter configuration is written to non-volatile memory. If power is turned off before 30 seconds, the changes may not be saved so that when the transmitter power is restored, the meter configuration will revert to the previous settings.

Procedure

The procedure in Table 27 shows the steps for setting the range values to applied pressures using local zero and span adjustments. See Figure 32 for typical local adjustment connections and setup details.

Table 27 Setting Range Values Using Local Zero and Span Adjustments

Step	Action
1	Turn OFF transmitter power. Loosen end-cap lock and remove end-cap from terminal block side of electronics housing.
2	Observing polarity, connect a milliammeter across positive (+) and negative (-) TEST terminals. ATTENTION If you have the Local Smart Meter with Zero and Span adjustment option, you may use the Local Smart Meter in place of the milliammeter.

Continued on next page

6.8 Setting Range Values Using Local Adjustments, Continued

Procedure, continued

Table 27 Setting Range Values Using Local Zero and Span Adjustments, continued

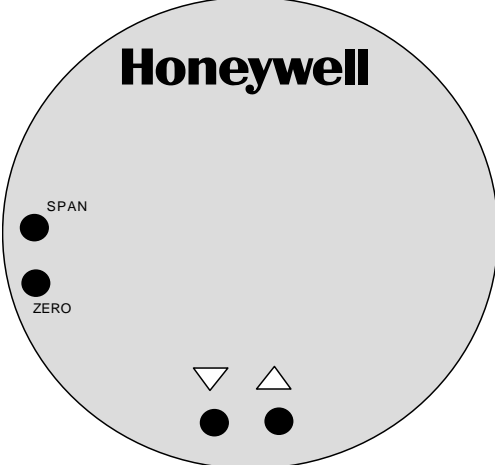
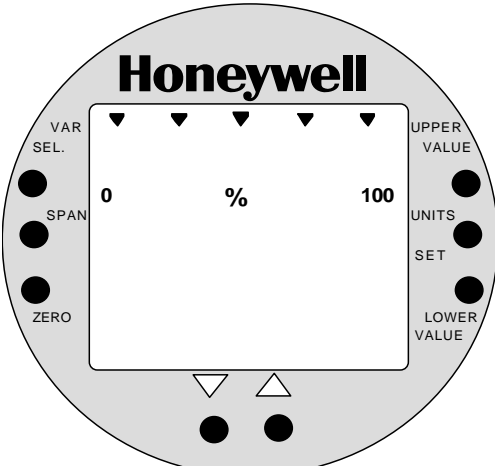
Step	Action
3	<p>Loosen end-cap lock and remove end-cap from PWA side of electronics housing to expose Local Zero and Span assembly or Local Smart meter with Zero and Span adjustments.</p> <p>Example – Local Zero and Span Assembly.</p>  <p>Example –Local Smart Meter with Zero and Span adjustments.</p> 

Continued on next page

6.8 Setting Range Values Using Local Adjustments,

Continued

Procedure, continued

Table 27 Setting Range Values Using Local Zero and Span Adjustments, continued

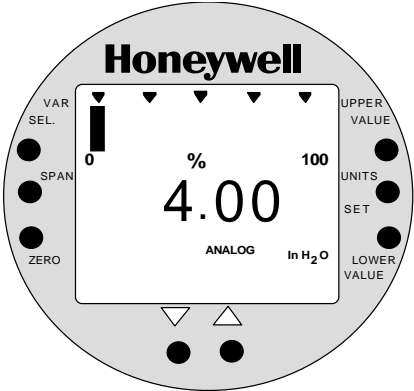
Step	Action						
4	<p>Turn ON transmitter power and let it warm up for a few minutes. Using an accurate pressure source, apply desired zero equivalent pressure to transmitter.</p> <p>ATTENTION For differential pressure transmitters, apply pressure to the high pressure head for positive range values or vent both heads to atmosphere for zero. If zero is to equal a negative value, apply the equivalent pressure to the low pressure head. For example, if zero is to equal $-10 \text{ inH}_2\text{O}$, you would apply $10 \text{ inH}_2\text{O}$ to the low pressure head and vent the high pressure head for the zero adjustment.</p>						
5	<p>Check that milliammeter reading is 4 mA.</p> <table border="1" data-bbox="641 890 1365 995"> <thead> <tr> <th data-bbox="641 890 1003 926">If reading ...</th> <th data-bbox="1003 890 1365 926">Then...</th> </tr> </thead> <tbody> <tr> <td data-bbox="641 926 1003 961">is less or greater than 4 mA</td> <td data-bbox="1003 926 1365 961">go to Step 6.</td> </tr> <tr> <td data-bbox="641 961 1003 995">is correct</td> <td data-bbox="1003 961 1365 995">go to Step 7.</td> </tr> </tbody> </table> <p>ATTENTION If you have the Local Smart Meter with Zero and Span adjustment option, you may substitute the Local Smart Meter readings for the milliammeter readings. For example, with zero input pressure applied assume that the meter reads 4 inH₂O instead of 0 inH₂O. In this case, the meter reading is greater than 0 (or 4 mA).</p> <p>Example – Local Smart Meter displaying transmitter output in inches of water.</p> 	If reading ...	Then...	is less or greater than 4 mA	go to Step 6.	is correct	go to Step 7.
If reading ...	Then...						
is less or greater than 4 mA	go to Step 6.						
is correct	go to Step 7.						

Continued on next page

6.8 Setting Range Values Using Local Adjustments,

Continued

Procedure, continued

Table 27 Setting Range Values Using Local Zero and Span Adjustments, continued

Step	Action
6	<p>a. Press and hold ZERO button on Local Zero and Span assembly or Local Smart Meter.</p> <div data-bbox="808 520 1289 884" data-label="Image"> <p>The diagram shows a circular Honeywell meter face. The central LCD display shows '1.00' with '%' symbols on either side and 'ANALOG' at the bottom. The top of the display has '0' on the left and '100' on the right. The meter face has several buttons: VAR SEL., SPAN, ZERO, UPPER VALUE, UNITS, SET, and LOWER VALUE. An arrow points to the ZERO button with the text 'Press & Hold'.</p> </div> <p>ATTENTION The Local Smart Meter readings revert to the default unit of percent (%) during this operation. If the error code E_{r0} appears on the display, you are working with a model STD110 transmitter that does not support the Local Zero and Span adjustments.</p> <p>b. Press Decrease τ button once to complete this function.</p> <p>ATTENTION The Local Smart Meter display goes blank for a 1/2 second and then returns reading 0%.</p> <div data-bbox="808 1205 1289 1675" data-label="Image"> <p>The diagram shows the same Honeywell meter face as above, but the LCD display now shows '0.00' with '%' symbols on either side and 'ANALOG' at the bottom. The top of the display has '0' on the left and '100' on the right. An arrow points to the Decrease button (the left of the two bottom buttons) with the text 'Press once'. A separate arrow points to the display with the text 'Display goes blank for 1/2 second and returns with zero reading'.</p> </div> <p>c. Check that milliammeter reading equals 4 mA and release ZERO button.</p> <p>ATTENTION If milliammeter reading doesn't change, be sure you are not working with a model STD110 transmitter that ignores local adjustments. The Local Smart Meter readings return to the set engineering units after you release the ZERO button.</p>

Continued on next page

6.8 Setting Range Values Using Local Adjustments,

Continued

Procedure, continued

Table 27 Setting Range Values Using Local Zero and Span Adjustments, continued

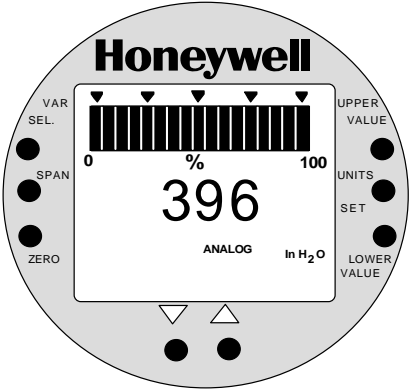
Step	Action						
7	<p>Using an accurate pressure source, apply pressure equivalent to desired upper range value to transmitter.</p> <p>ATTENTION For differential pressure transmitters, apply pressure to the high pressure head and be sure that the pressure to the low pressure head is at its reference value.</p>						
8	<p>Check that milliammeter reading is 20 mA.</p> <table border="1" data-bbox="639 743 1365 850"> <thead> <tr> <th data-bbox="639 743 1003 779">If reading ...</th> <th data-bbox="1003 743 1365 779">Then...</th> </tr> </thead> <tbody> <tr> <td data-bbox="639 779 1003 814">is not exactly 20 mA</td> <td data-bbox="1003 779 1365 814">go to Step 9.</td> </tr> <tr> <td data-bbox="639 814 1003 850">is correct</td> <td data-bbox="1003 814 1365 850">go to Step 10.</td> </tr> </tbody> </table> <p>ATTENTION If you have the Local Smart Meter with Zero and Span adjustment option, you may substitute the Local Smart Meter readings for the milliammeter readings. For example, with URV input pressure applied assume that the meter reads 396 inH₂O instead of 400 inH₂O. In this case, the meter reading is less than 100% (or 20 mA).</p> <p>Example – Local Smart Meter displaying transmitter output in inches of water.</p> 	If reading ...	Then...	is not exactly 20 mA	go to Step 9.	is correct	go to Step 10.
If reading ...	Then...						
is not exactly 20 mA	go to Step 9.						
is correct	go to Step 10.						

Continued on next page

6.8 Setting Range Values Using Local Adjustments,

Continued

Procedure, continued

Table 27 Setting Range Values Using Local Zero and Span Adjustments, continued

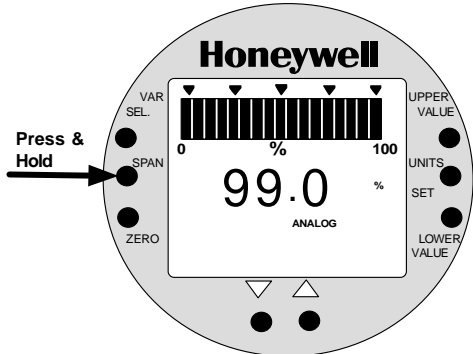
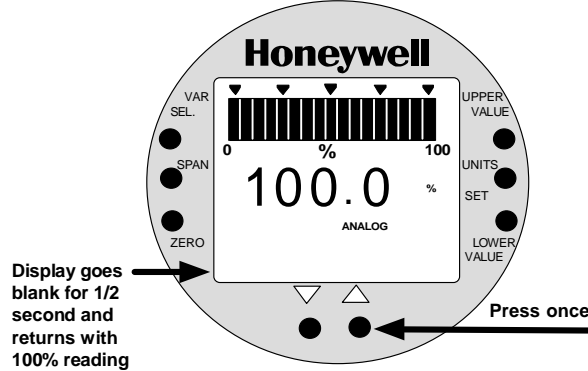
Step	Action
9	<p>a. Press and hold SPAN button on Local Zero and Span assembly or Local Smart Meter.</p>  <p>ATTENTION The Local Smart Meter readings revert to the default unit of percent (%) during this operation. If the error code $Er0$ appears on the display, you are working with a model STD110 transmitter that does not support the Local Zero and Span adjustments. If the error code $Er4$ appears, you are trying to set a SPAN value that is outside acceptable limits for your transmitter. Readjust applied pressure to be within acceptable range limits and repeat this procedure.</p> <p>b. Press Increase σ button once to complete this function.</p> <p>ATTENTION The Local Smart Meter display goes blank for a 1/2 second and then returns reading 100%.</p>  <p>c. Check that milliammeter reading equals 20 mA and release SPAN button.</p> <p>ATTENTION If milliammeter reading doesn't change, be sure you are not working with a model STD110 transmitter that ignores local adjustments. The Local Smart Meter readings return to the set engineering units after you release the SPAN button.</p>

Continued on next page

6.8 Setting Range Values Using Local Adjustments,

Continued

Procedure, continued

Table 27 Setting Range Values Using Local Zero and Span Adjustments, continued

Step	Action
10	Wait 30 seconds so that changes have been copied to the transmitter's non-volatile memory.
11	Remove applied pressure and turn OFF transmitter power.
12	Replace end-cap on PWA side of electronics housing and tighten lock.
13	Remove milliammeter from TEST terminals and replace end-cap and tighten lock.
14	Turn ON transmitter power and check Local Smart Meter reading, if applicable.

Figure 32 Typical Setup for Setting Range Values Using Local Zero and Span Adjustments.

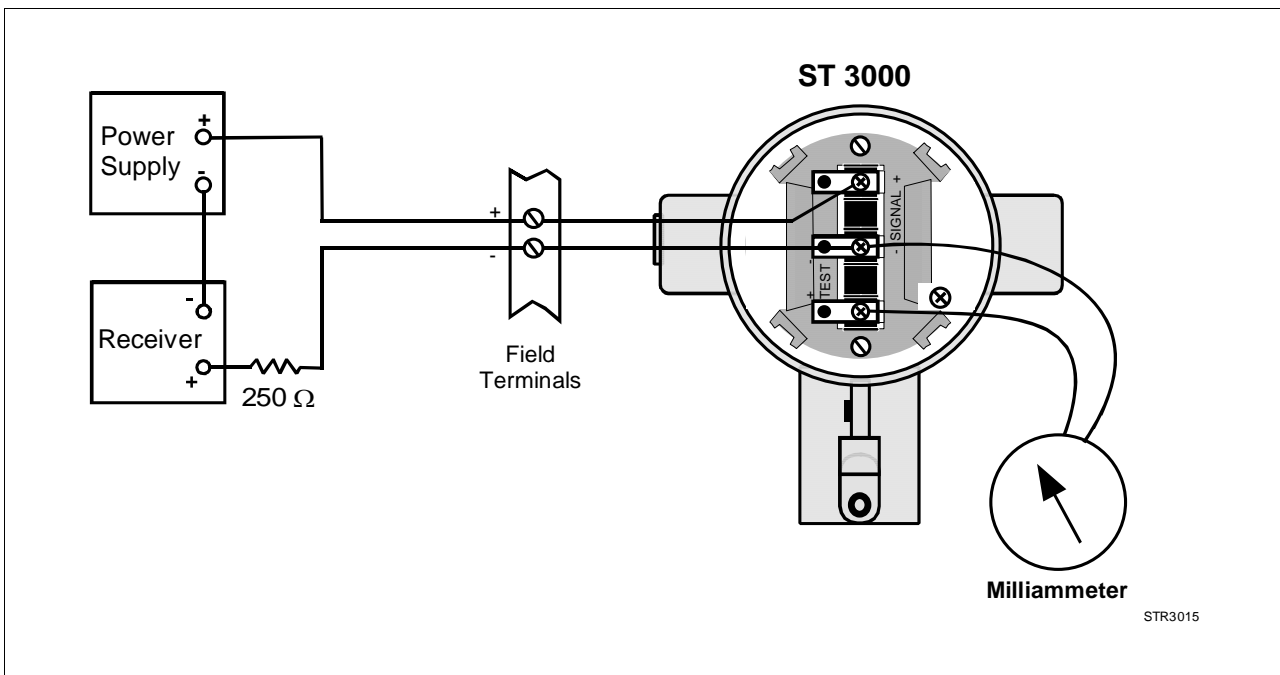

6.9 Selecting Output Signal Mode (DE Mode Only)

DE configuration parameters

You must configure these additional parameters for a transmitter in the DE mode of operation.

- Mode of Output Signal Indication
- Message Format

This section and the next section cover how to configure these parameters individually. However, once you enter the DE configuration function, you can access all DE configuration parameters serially without exiting the function. Just use the [s NEXT] and [t PREV] keys to step through the parameter selections.

Background



You can select the output signal mode for digital transmission to be one of these three modes as described in Table 20.

- Single Range
- Dual Range (STDC)
- Single Range W/SV

Procedure

The procedure in Table 28 outlines the steps for selecting a Single Range W/SV mode for example purposes only.

Table 28 Selecting Mode of Output Signal Indication

Step	Press Key	Read Display or Action	Description
1		<pre> L I N D P P T 3 0 1 1 S H I F T - DE CONF P T 3 0 1 1 S F C W O R K I N G . . . DE CONF P T 3 0 1 1 S i n g l e R a n g e </pre>	<p>Initiate shift key selection.</p> <p>Calls up DE CONFIG menu. Output signal mode selection appears.</p>
2		<pre> DE CONF P T 3 0 1 1 S i n g l e R n g w / S V DE CONF P T 3 0 1 1 D u a l R a n g e (S T D C) </pre>	<p>Calls up next output signal mode selection.</p> <p>Repeatedly press [MENU ITEM] key to step through all output signal mode selections listed in Table 20 in sequence. Stop when “Single Range W/SV” mode is on display.</p>

Continued on next page

6.9 Selecting Output Signal Mode (DE Mode Only), Continued

Procedure , continued

Table 28 Selecting Mode of Output Signal Indication, continued

Step	Press Key	Read Display or Action	Description																																																
3	NON-VOL ENTER (Yes)	<table border="1"> <tr><td>D</td><td>E</td><td>C</td><td>O</td><td>N</td><td>F</td><td>P</td><td>T</td><td>3</td><td>0</td><td>1</td><td>1</td></tr> <tr><td>E</td><td>N</td><td>T</td><td>E</td><td>R</td><td>E</td><td>D</td><td>I</td><td>N</td><td>S</td><td>F</td><td>C</td></tr> </table> <table border="1"> <tr><td>D</td><td>E</td><td>C</td><td>O</td><td>N</td><td>F</td><td>P</td><td>T</td><td>3</td><td>0</td><td>1</td><td>1</td></tr> <tr><td>w</td><td>/</td><td>o</td><td>D</td><td>B</td><td>(</td><td>4</td><td>B</td><td>y</td><td>t</td><td>e</td><td>)</td></tr> </table>	D	E	C	O	N	F	P	T	3	0	1	1	E	N	T	E	R	E	D	I	N	S	F	C	D	E	C	O	N	F	P	T	3	0	1	1	w	/	o	D	B	(4	B	y	t	e)	Enters change in SFC and calls up next DE configuration parameter. This action only applies if selection is changed. Otherwise, must press [CLR] key to exit function or [s NEXT] key to call up next parameter.
D	E	C	O	N	F	P	T	3	0	1	1																																								
E	N	T	E	R	E	D	I	N	S	F	C																																								
D	E	C	O	N	F	P	T	3	0	1	1																																								
w	/	o	D	B	(4	B	y	t	e)																																								
4	CLR (NO)	<table border="1"> <tr><td>D</td><td>E</td><td>C</td><td>O</td><td>N</td><td>F</td><td>P</td><td>T</td><td>3</td><td>0</td><td>1</td><td>1</td></tr> <tr><td>D</td><td>O</td><td>W</td><td>N</td><td>L</td><td>O</td><td>A</td><td>D</td><td>C</td><td>H</td><td>A</td><td>N</td><td>G</td><td>E</td><td>?</td></tr> </table>	D	E	C	O	N	F	P	T	3	0	1	1	D	O	W	N	L	O	A	D	C	H	A	N	G	E	?	Prompt asks if change entered in SFC is to be downloaded to transmitter. If you want to download change, go to Step 5. If you do not want to download change, press [CLR] key to exit function. This action only applies when Step 3 is valid. Otherwise, this keystroke exits DE CONF function.																					
D	E	C	O	N	F	P	T	3	0	1	1																																								
D	O	W	N	L	O	A	D	C	H	A	N	G	E	?																																					
5	NON-VOL ENTER (Yes)	<table border="1"> <tr><td>D</td><td>E</td><td>C</td><td>O</td><td>N</td><td>F</td><td>P</td><td>T</td><td>3</td><td>0</td><td>1</td><td>1</td></tr> <tr><td>S</td><td>F</td><td>C</td><td>W</td><td>O</td><td>R</td><td>K</td><td>I</td><td>N</td><td>G</td><td>.</td><td>.</td><td>.</td></tr> </table> <table border="1"> <tr><td>L</td><td>I</td><td>N</td><td>D</td><td>P</td><td>P</td><td>T</td><td>3</td><td>Ø</td><td>1</td><td>1</td></tr> <tr><td>R</td><td>E</td><td>A</td><td>D</td><td>Y</td><td>.</td><td>.</td><td>.</td><td>.</td><td>.</td><td>.</td><td>.</td></tr> </table>	D	E	C	O	N	F	P	T	3	0	1	1	S	F	C	W	O	R	K	I	N	G	.	.	.	L	I	N	D	P	P	T	3	Ø	1	1	R	E	A	D	Y	Message exchange is working. Parameter change is loaded in transmitter. SFC is ready for next function.
D	E	C	O	N	F	P	T	3	0	1	1																																								
S	F	C	W	O	R	K	I	N	G	.	.	.																																							
L	I	N	D	P	P	T	3	Ø	1	1																																									
R	E	A	D	Y																																								

Continued on next page

6.9 Selecting Output Signal Mode (DE Mode Only), Continued

Keystroke summary Figure 33 shows keystroke summary for selecting the mode of output signal indication for transmitter in DE mode for quick reference.

Figure 33 Keystroke Summary for Selecting Mode of Output Signal Indication.

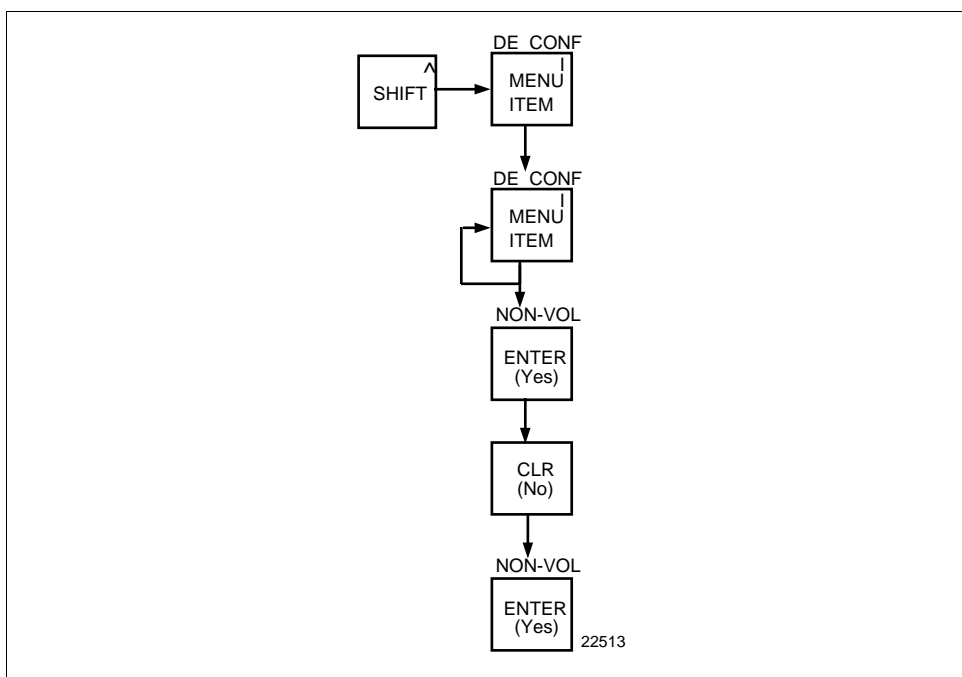

6.10 Selecting Message Format (DE Mode Only)

Background





You can select one of these broadcast formats for the digital signal transmission as described in Table 20.

- 4-Byte type
- 6-Byte type

Procedure

The procedure in Table 29 outlines the steps for selecting a 6-Byte type format for example purposes only.

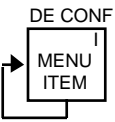
Table 29 Selecting Message Format

Step	Press Key	Read Display or Action	Description																																																																									
1	 	<table border="1" style="width: 100%; text-align: center;"> <tr><td>L</td><td>I</td><td>N</td><td></td><td>D</td><td>P</td><td>P</td><td>T</td><td>3</td><td>Ø</td><td>1</td><td>1</td></tr> <tr><td></td><td></td><td></td><td></td><td>S</td><td>H</td><td>I</td><td>F</td><td>T</td><td>-</td><td></td><td></td></tr> </table> <table border="1" style="width: 100%; text-align: center;"> <tr><td>D</td><td>E</td><td>C</td><td>O</td><td>N</td><td>F</td><td>P</td><td>T</td><td>3</td><td>0</td><td>1</td><td>1</td></tr> <tr><td>S</td><td>F</td><td>C</td><td>W</td><td>O</td><td>R</td><td>K</td><td>I</td><td>N</td><td>G</td><td>.</td><td>.</td></tr> </table> <table border="1" style="width: 100%; text-align: center;"> <tr><td>D</td><td>E</td><td>C</td><td>O</td><td>N</td><td>F</td><td>P</td><td>T</td><td>3</td><td>0</td><td>1</td><td>1</td></tr> <tr><td>S</td><td>i</td><td>n</td><td>g</td><td>l</td><td>e</td><td>R</td><td>n</td><td>g</td><td>w</td><td>/</td><td>S</td><td>V</td></tr> </table>	L	I	N		D	P	P	T	3	Ø	1	1					S	H	I	F	T	-			D	E	C	O	N	F	P	T	3	0	1	1	S	F	C	W	O	R	K	I	N	G	.	.	D	E	C	O	N	F	P	T	3	0	1	1	S	i	n	g	l	e	R	n	g	w	/	S	V	<p>Initiate shift key selection.</p> <p>Calls up DE CONFIG menu. Output signal mode selection appears.</p>
L	I	N		D	P	P	T	3	Ø	1	1																																																																	
				S	H	I	F	T	-																																																																			
D	E	C	O	N	F	P	T	3	0	1	1																																																																	
S	F	C	W	O	R	K	I	N	G	.	.																																																																	
D	E	C	O	N	F	P	T	3	0	1	1																																																																	
S	i	n	g	l	e	R	n	g	w	/	S	V																																																																
2		<table border="1" style="width: 100%; text-align: center;"> <tr><td>D</td><td>E</td><td>C</td><td>O</td><td>N</td><td>F</td><td>P</td><td>T</td><td>3</td><td>0</td><td>1</td><td>1</td></tr> <tr><td>w</td><td>/</td><td>o</td><td>D</td><td>B</td><td>(</td><td>4</td><td>B</td><td>y</td><td>t</td><td>e</td><td>)</td></tr> </table>	D	E	C	O	N	F	P	T	3	0	1	1	w	/	o	D	B	(4	B	y	t	e)	<p>Calls up next DE CONFIG menu item - Message format selection appears.</p>																																																	
D	E	C	O	N	F	P	T	3	0	1	1																																																																	
w	/	o	D	B	(4	B	y	t	e)																																																																	
3		<table border="1" style="width: 100%; text-align: center;"> <tr><td>D</td><td>E</td><td>C</td><td>O</td><td>N</td><td>F</td><td>P</td><td>T</td><td>3</td><td>0</td><td>1</td><td>1</td></tr> <tr><td>w</td><td>/</td><td>D</td><td>B</td><td>(</td><td>6</td><td>B</td><td>y</td><td>t</td><td>e</td><td>)</td><td></td></tr> </table>	D	E	C	O	N	F	P	T	3	0	1	1	w	/	D	B	(6	B	y	t	e)		<p>Calls up next message format selection. Repeatedly press [MENU ITEM] key to cycle between two format selections. See Table 19 for details. Stop when “w/DB (6 Byte)” selection is on display.</p>																																																	
D	E	C	O	N	F	P	T	3	0	1	1																																																																	
w	/	D	B	(6	B	y	t	e)																																																																		
4		<table border="1" style="width: 100%; text-align: center;"> <tr><td>D</td><td>E</td><td>C</td><td>O</td><td>N</td><td>F</td><td>P</td><td>T</td><td>3</td><td>0</td><td>1</td><td>1</td></tr> <tr><td>E</td><td>N</td><td>T</td><td>E</td><td>R</td><td>E</td><td>D</td><td>I</td><td>N</td><td>S</td><td>F</td><td>C</td></tr> </table> <table border="1" style="width: 100%; text-align: center;"> <tr><td>D</td><td>E</td><td>C</td><td>O</td><td>N</td><td>F</td><td>P</td><td>T</td><td>3</td><td>0</td><td>1</td><td>1</td></tr> <tr><td>F</td><td>/</td><td>S</td><td>=</td><td>B</td><td>/</td><td>O</td><td>L</td><td>o</td><td></td><td></td><td></td></tr> </table>	D	E	C	O	N	F	P	T	3	0	1	1	E	N	T	E	R	E	D	I	N	S	F	C	D	E	C	O	N	F	P	T	3	0	1	1	F	/	S	=	B	/	O	L	o				<p>Enters change in SFC and calls up next DE configuration parameter. This action only applies if selection is changed. Otherwise, must press [CLR] key to exit function, [s NEXT] key to call up next parameter, or [t PREV] key to call up previous parameter.</p>																									
D	E	C	O	N	F	P	T	3	0	1	1																																																																	
E	N	T	E	R	E	D	I	N	S	F	C																																																																	
D	E	C	O	N	F	P	T	3	0	1	1																																																																	
F	/	S	=	B	/	O	L	o																																																																				
5		<table border="1" style="width: 100%; text-align: center;"> <tr><td>D</td><td>E</td><td>C</td><td>O</td><td>N</td><td>F</td><td>P</td><td>T</td><td>3</td><td>0</td><td>1</td><td>1</td></tr> <tr><td>D</td><td>O</td><td>W</td><td>N</td><td>L</td><td>O</td><td>A</td><td>D</td><td>C</td><td>H</td><td>A</td><td>N</td><td>G</td><td>E</td><td>?</td></tr> </table>	D	E	C	O	N	F	P	T	3	0	1	1	D	O	W	N	L	O	A	D	C	H	A	N	G	E	?	<p>Prompt asks if change entered in SFC is to be downloaded to transmitter. If you want to download change, go to Step 6. If you do not want to download change, press [CLR] key to exit function. This action only applies when Step 4 is valid. Otherwise, this keystroke exits DE CONF function.</p>																																														
D	E	C	O	N	F	P	T	3	0	1	1																																																																	
D	O	W	N	L	O	A	D	C	H	A	N	G	E	?																																																														

Continued on next page

6.10 Selecting Message Format (DE Mode Only), Continued

Procedure , continued

Table 29 Selecting Message Format, continued

Step	Press Key	Read Display or Action	Description																																																
6	NON-VOL ENTER (Yes)	<table border="1" style="margin-bottom: 5px;"> <tr><td>D</td><td>E</td><td>C</td><td>O</td><td>N</td><td>F</td><td>P</td><td>T</td><td>3</td><td>0</td><td>1</td><td>1</td></tr> <tr><td>S</td><td>F</td><td>C</td><td>W</td><td>O</td><td>R</td><td>K</td><td>I</td><td>N</td><td>G</td><td>.</td><td>.</td></tr> </table> <table border="1"> <tr><td>L</td><td>I</td><td>N</td><td></td><td>D</td><td>P</td><td>P</td><td>T</td><td>3</td><td>Ø</td><td>1</td><td>1</td></tr> <tr><td>R</td><td>E</td><td>A</td><td>D</td><td>Y</td><td>.</td><td>.</td><td></td><td></td><td></td><td></td><td></td></tr> </table>	D	E	C	O	N	F	P	T	3	0	1	1	S	F	C	W	O	R	K	I	N	G	.	.	L	I	N		D	P	P	T	3	Ø	1	1	R	E	A	D	Y	.	.						<p>Message exchange is working.</p> <p>Parameter change is loaded in transmitter. SFC is ready for next function.</p>
D	E	C	O	N	F	P	T	3	0	1	1																																								
S	F	C	W	O	R	K	I	N	G	.	.																																								
L	I	N		D	P	P	T	3	Ø	1	1																																								
R	E	A	D	Y	.	.																																													

Keystroke summary Figure 34 shows keystroke summary for selecting the message format for transmitter in DE mode for quick reference.

Figure 34 Keystroke Summary for Selecting Message Format.

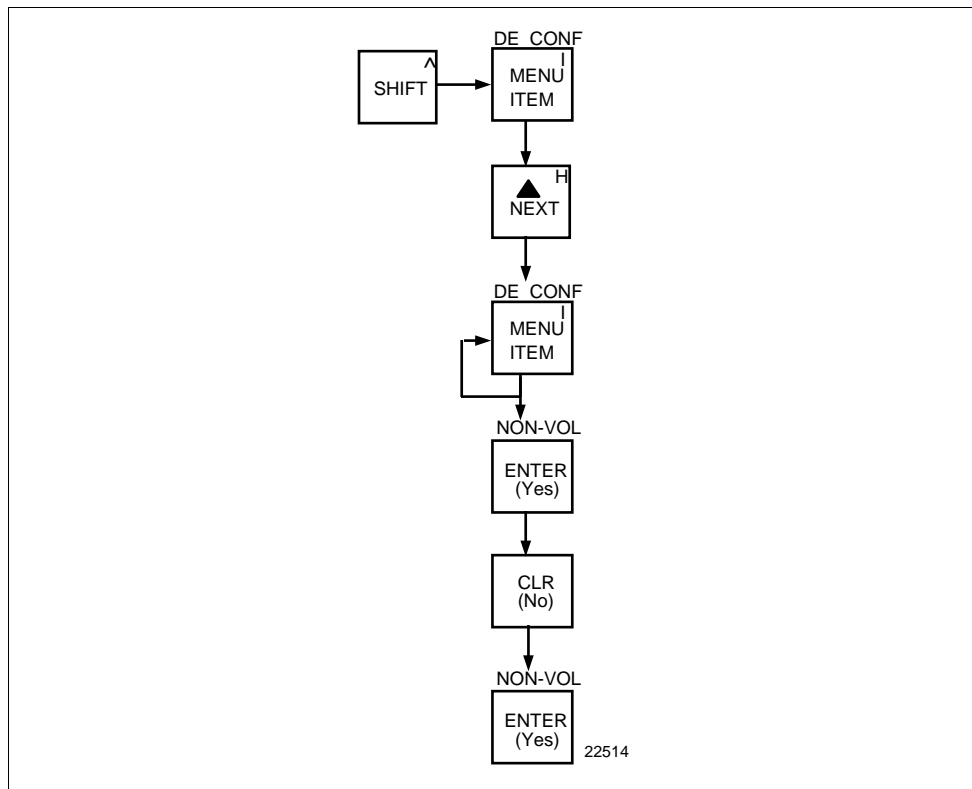

6.11 Configuring Smart Meter Using SFC

Background

You can select an available engineering unit or enter a custom one including upper and lower limit settings for the Local Smart Meter's digital readout through the SFC.

Configuring the Smart Meter

- If you initiate an SFC command at the same time a button is pressed on the Local Smart Meter, the Local Smart Meter will respond to the command it receives last. In other words, the last command wins.
 - The Local Smart Meter does **not** have to be installed for you to configure it through the SFC. The meter's configuration data is stored in memory on the transmitter's PWA rather than in the meter itself.
-

Transmitter Output Conformity and Smart Meter Configuration

Normally when using a differential type transmitter, you can select the transmitter's output to represent a straight linear calculation or a square root calculation for flow measurement applications. This linear or square root output parameter selection is called output conformity or output form. (See Subsection 6.4 for more details.)

When configuring the smart meter to display the transmitter output measurement, there are certain rules to keep in mind which are dependent on the output conformity selection. These rules are described in the following paragraphs.

1. The output conformity setting of the transmitter restricts the engineering units you can select for the smart meter display.
 - When the transmitter is configured for an output conformity of **LINEAR**, you can select only pressure type engineering units. (See Table 31.)
 - When the transmitter is configured for an output conformity of **SQUARE ROOT**, you can select only flow type engineering units GPM and GPH.
 - The percent and custom engineering units can be selected regardless of output conformity configuration.
 2. Additionally, the output conformity setting restricts the setting of the lower and upper display limits to represent transmitter's 0 to 100% output.
 - If you select pressure type engineering units, you cannot set the lower or upper display limits. These values are automatically set when you select the engineering units.
 - You can set only the upper display limit when the transmitter is configured for **SQUARE ROOT** output conformity. The lower display limit is fixed at zero (0) for a transmitter in square root mode and cannot be changed.
-

Continued on next page

6.11 Configuring Smart Meter Using SFC, Continued

Transmitter Output Conformity and Smart Meter Configuration, continued

- You can set both the lower and upper display limits when you have selected custom engineering units (Custom) and the transmitter output conformity is set to **LINEAR**.
When setting the lower and upper display limits, if you let either the lower or upper display limit setting time out (after thirty seconds), the meter will discard the newly set values and will revert to its previous settings. The meter forces you to set both limits by automatically initiating the next limit setting, either lower or upper, depending upon which limit you set first.

- If you change the transmitter's output conformity, you must reconfigure the local smart meter as outlined in Table 30.



ATTENTION

After making any adjustments to the smart meter, keep the transmitter powered for at least 30 seconds so that the new meter configuration is written to non-volatile memory. If power is turned off before 30 seconds, the changes may not be saved so that when the transmitter power is restored, the meter configuration will revert to the previous settings.

Procedure

The procedure in Table 30 outlines the steps for setting up the configuration for a Local Smart Meter using an SFC.

Table 30 Setting Up Local Smart Meter Configuration Using an SFC

Step	Press Key	Read Display or Action	Description																														
1		<table border="1" style="border-collapse: collapse; text-align: center;"> <tr><td> </td><td> </td><td> </td><td>S</td><td>T</td><td> </td><td>C</td><td>O</td><td>N</td><td>F</td><td>I</td><td>G</td><td> </td><td> </td><td> </td></tr> <tr><td>C</td><td>O</td><td>N</td><td>F</td><td>O</td><td>R</td><td>M</td><td>I</td><td>T</td><td>Y</td><td>?</td><td> </td><td> </td><td> </td><td> </td></tr> </table>				S	T		C	O	N	F	I	G				C	O	N	F	O	R	M	I	T	Y	?					Calls up first configuration prompt.
			S	T		C	O	N	F	I	G																						
C	O	N	F	O	R	M	I	T	Y	?																							
2		<table border="1" style="border-collapse: collapse; text-align: center;"> <tr><td> </td><td> </td><td> </td><td>S</td><td>T</td><td> </td><td>C</td><td>O</td><td>N</td><td>F</td><td>I</td><td>G</td><td> </td><td> </td><td> </td></tr> <tr><td> </td><td>M</td><td>e</td><td>t</td><td>e</td><td>r</td><td> </td><td>C</td><td>o</td><td>n</td><td>f</td><td>i</td><td>g</td><td>?</td><td> </td></tr> </table>				S	T		C	O	N	F	I	G					M	e	t	e	r		C	o	n	f	i	g	?		Calls up next configuration prompt. Prompt asks if you want to access meter configuration function. If you want to access it, go to Step 3. If you do not want to access it, press [CLR] key to exit function or [s NEXT] key to call up next configuration parameter.
			S	T		C	O	N	F	I	G																						
	M	e	t	e	r		C	o	n	f	i	g	?																				

Continued on next page

6.11 Configuring Smart Meter Using SFC, Continued

Procedure, continued

Table 30 Setting Up Local Smart Meter Configuration Using an SFC, continued

Step	Press Key	Read Display or Action	Description																																																					
3	NON-VOL <input type="button" value="ENTER (YES)"/>	<table border="1" data-bbox="509 459 924 520"> <tr><td>M</td><td>e</td><td>t</td><td>e</td><td>r</td><td>C</td><td>o</td><td>n</td><td>f</td><td>i</td><td>g</td><td></td><td></td></tr> <tr><td>S</td><td>F</td><td>C</td><td>W</td><td>O</td><td>R</td><td>K</td><td>I</td><td>N</td><td>G</td><td>.</td><td>.</td><td>.</td></tr> </table> <table border="1" data-bbox="509 548 924 609"> <tr><td>M</td><td>e</td><td>t</td><td>e</td><td>r</td><td>C</td><td>o</td><td>n</td><td>f</td><td>i</td><td>g</td><td></td><td></td></tr> <tr><td>M</td><td>e</td><td>t</td><td>e</td><td>r</td><td>B</td><td>d</td><td>P</td><td>r</td><td>e</td><td>s</td><td>e</td><td>n</td><td>t</td></tr> </table>	M	e	t	e	r	C	o	n	f	i	g			S	F	C	W	O	R	K	I	N	G	.	.	.	M	e	t	e	r	C	o	n	f	i	g			M	e	t	e	r	B	d	P	r	e	s	e	n	t	<p>Enters meter configuration function and confirms that Local Smart Meter is present. Timed prompt - Proceed to Step 4.</p> <p>ATTENTION If prompt “No Meter Present” appears, prompt times out in a few seconds, as described above, and calls up the Configure Meter? prompt. This means that you can access the meter configuration function without the Local Smart Meter installed. Proceed to Step 4. If prompt “Mtr not Supportd” appears, prompt times out and returns to previous ST CONFIG prompt (See Step 2.). This means that you are working with a pre-release 300 transmitter that does not support the Local Smart Meter option and, therefore, can not access the meter configuration function.</p>
M	e	t	e	r	C	o	n	f	i	g																																														
S	F	C	W	O	R	K	I	N	G	.	.	.																																												
M	e	t	e	r	C	o	n	f	i	g																																														
M	e	t	e	r	B	d	P	r	e	s	e	n	t																																											
4		<table border="1" data-bbox="509 1188 924 1249"> <tr><td>M</td><td>e</td><td>t</td><td>e</td><td>r</td><td>C</td><td>o</td><td>n</td><td>f</td><td>i</td><td>g</td><td></td><td></td></tr> <tr><td>C</td><td>o</td><td>n</td><td>f</td><td>i</td><td>g</td><td>u</td><td>r</td><td>e</td><td>M</td><td>e</td><td>t</td><td>e</td><td>r</td><td>?</td></tr> </table>	M	e	t	e	r	C	o	n	f	i	g			C	o	n	f	i	g	u	r	e	M	e	t	e	r	?	<p>Prompt asks if you want to configure Local Smart Meter. If you want to configure it, go to Step 5. If you do not want to configure it, press [CLR] key to exit function.</p>																									
M	e	t	e	r	C	o	n	f	i	g																																														
C	o	n	f	i	g	u	r	e	M	e	t	e	r	?																																										

Continued on next page

6.11 Configuring Smart Meter Using SFC, Continued

Procedure, continued

Table 30 Setting Up Local Smart Meter Configuration Using an SFC, continued

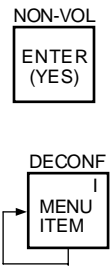
Step	Press Key	Read Display or Action	Description																										
5		<table border="1" data-bbox="560 464 971 525"> <tr> <td>M</td><td>e</td><td>t</td><td>e</td><td>r</td><td>E</td><td>n</td><td>g</td><td>U</td><td>n</td><td>i</td><td>t</td><td>s</td> </tr> <tr> <td>"</td><td>H</td><td>2</td><td>O</td><td>_</td><td>3</td><td>9</td><td>F</td><td></td><td></td><td></td><td></td><td></td> </tr> </table> <p data-bbox="690 573 836 1171"> MmHg_0C PSI KPa MPa mBAR BAR g/cm^2 Kg/cm^2 mmH2O_4C inHg_32F mH2O_4C GPM GPH Custom % </p>	M	e	t	e	r	E	n	g	U	n	i	t	s	"	H	2	O	_	3	9	F						<p data-bbox="1024 464 1446 583">Calls up present meter Engineering Unit selection. (Note that unit "H2O_39F is shown for example purposes only.)</p> <p data-bbox="1024 606 1455 726">Repeatedly press [MENU ITEM] key to step through other selections. For example purposes, stop when PSI unit is on display.</p>
M	e	t	e	r	E	n	g	U	n	i	t	s																	
"	H	2	O	_	3	9	F																						
6		<table border="1" data-bbox="545 1213 984 1423"> <thead> <tr> <th data-bbox="545 1213 764 1247">If EU is ...</th> <th data-bbox="764 1213 984 1247">Then...</th> </tr> </thead> <tbody> <tr> <td data-bbox="545 1247 764 1318">Custom, GPM, or GPH</td> <td data-bbox="764 1247 984 1318">go to Step 7.</td> </tr> <tr> <td data-bbox="545 1318 764 1423">other than Custom, GPM, or GPH</td> <td data-bbox="764 1318 984 1423">go to Step 13.</td> </tr> </tbody> </table>	If EU is ...	Then...	Custom, GPM, or GPH	go to Step 7.	other than Custom, GPM, or GPH	go to Step 13.																					
If EU is ...	Then...																												
Custom, GPM, or GPH	go to Step 7.																												
other than Custom, GPM, or GPH	go to Step 13.																												

Continued on next page

6.11 Configuring Smart Meter Using SFC, Continued

Procedure, continued

Table 30 Setting Up Local Smart Meter Configuration Using an SFC, continued

Step	Press Key	Read Display or Action	Description																																																																																																										
7	NON-VOL ENTER (YES)	<table border="1"> <tr><td>M</td><td>e</td><td>t</td><td>e</td><td>r</td><td>E</td><td>n</td><td>g</td><td>U</td><td>n</td><td>i</td><td>t</td><td>s</td></tr> <tr><td>S</td><td>F</td><td>C</td><td>W</td><td>O</td><td>R</td><td>K</td><td>I</td><td>N</td><td>G</td><td>.</td><td>.</td><td>.</td></tr> </table> <table border="1"> <tr><td>M</td><td>e</td><td>t</td><td>e</td><td>r</td><td>E</td><td>n</td><td>g</td><td>U</td><td>n</td><td>i</td><td>t</td><td>s</td></tr> <tr><td>D</td><td>a</td><td>t</td><td>a</td><td>D</td><td>o</td><td>w</td><td>n</td><td>l</td><td>a</td><td>d</td><td>e</td><td>d</td></tr> </table> <table border="1"> <tr><td>E</td><td>n</td><td>g</td><td>U</td><td>n</td><td>i</td><td>t</td><td>s</td><td>H</td><td>i</td><td>-</td><td>L</td><td>o</td></tr> <tr><td>S</td><td>F</td><td>C</td><td>W</td><td>O</td><td>R</td><td>K</td><td>I</td><td>N</td><td>G</td><td>.</td><td>.</td><td>.</td></tr> </table> <table border="1"> <tr><td>E</td><td>U</td><td>H</td><td>i</td><td></td><td></td><td></td><td></td><td>C</td><td>u</td><td>s</td><td>t</td><td>o</td><td>m</td></tr> <tr><td>></td><td>R</td><td>A</td><td>N</td><td>G</td><td>E</td><td></td><td></td><td></td><td></td><td></td><td></td><td></td><td></td></tr> </table>	M	e	t	e	r	E	n	g	U	n	i	t	s	S	F	C	W	O	R	K	I	N	G	.	.	.	M	e	t	e	r	E	n	g	U	n	i	t	s	D	a	t	a	D	o	w	n	l	a	d	e	d	E	n	g	U	n	i	t	s	H	i	-	L	o	S	F	C	W	O	R	K	I	N	G	.	.	.	E	U	H	i					C	u	s	t	o	m	>	R	A	N	G	E									<p>Selected engineering unit is downloaded to transmitter and high/low display limit setting function is initiated. (Note that Custom unit is shown for example purposes only.)</p> <p>ATTENTION If you select GPM or GPH unit with the transmitter in its LINEAR mode, the prompts “INVALID REQUEST”, “Download Error”, and “MtrNotInFlowMode” are sequentially displayed after the SFC WORKING. . . prompt and display returns to the Configure Meter prompt. Transmitter must be in its SQUARE ROOT (Flow) mode for GPM or GPH to be a valid unit selection.</p> <p>Press [τ PREV] key , if you want to view present high and low display limits loaded in the transmitter.</p>
M	e	t	e	r	E	n	g	U	n	i	t	s																																																																																																	
S	F	C	W	O	R	K	I	N	G	.	.	.																																																																																																	
M	e	t	e	r	E	n	g	U	n	i	t	s																																																																																																	
D	a	t	a	D	o	w	n	l	a	d	e	d																																																																																																	
E	n	g	U	n	i	t	s	H	i	-	L	o																																																																																																	
S	F	C	W	O	R	K	I	N	G	.	.	.																																																																																																	
E	U	H	i					C	u	s	t	o	m																																																																																																
>	R	A	N	G	E																																																																																																								
8	<table border="1"> <tr><td>S</td></tr> <tr><td>5</td></tr> </table> <table border="1"> <tr><td>W</td></tr> <tr><td>2</td></tr> </table> <table border="1"> <tr><td>S</td></tr> <tr><td>5</td></tr> </table>	S	5	W	2	S	5	<table border="1"> <tr><td>E</td><td>U</td><td>H</td><td>i</td><td></td><td></td><td></td><td></td><td>C</td><td>u</td><td>s</td><td>t</td><td>o</td><td>m</td></tr> <tr><td>5</td><td>_</td><td></td><td></td><td></td><td></td><td></td><td></td><td></td><td></td><td></td><td></td><td></td><td></td></tr> </table> <table border="1"> <tr><td>E</td><td>U</td><td>H</td><td>i</td><td></td><td></td><td></td><td></td><td>C</td><td>u</td><td>s</td><td>t</td><td>o</td><td>m</td></tr> <tr><td>5</td><td>2</td><td>_</td><td></td><td></td><td></td><td></td><td></td><td></td><td></td><td></td><td></td><td></td><td></td></tr> </table> <table border="1"> <tr><td>E</td><td>U</td><td>H</td><td>i</td><td></td><td></td><td></td><td></td><td>C</td><td>u</td><td>s</td><td>t</td><td>o</td><td>m</td></tr> <tr><td>5</td><td>2</td><td>5</td><td>_</td><td></td><td></td><td></td><td></td><td></td><td></td><td></td><td></td><td></td><td></td></tr> </table>	E	U	H	i					C	u	s	t	o	m	5	_													E	U	H	i					C	u	s	t	o	m	5	2	_												E	U	H	i					C	u	s	t	o	m	5	2	5	_											<p>Key in 525 as upper display limit for Custom unit.</p> <p>ATTENTION The display range of the meter is $\pm 19,990,000$. If you enter larger values, they will not be displayed.</p>																
S																																																																																																													
5																																																																																																													
W																																																																																																													
2																																																																																																													
S																																																																																																													
5																																																																																																													
E	U	H	i					C	u	s	t	o	m																																																																																																
5	_																																																																																																												
E	U	H	i					C	u	s	t	o	m																																																																																																
5	2	_																																																																																																											
E	U	H	i					C	u	s	t	o	m																																																																																																
5	2	5	_																																																																																																										
9	NON-VOL ENTER (YES)	<table border="1"> <tr><td>E</td><td>U</td><td>H</td><td>i</td><td></td><td></td><td></td><td></td><td>C</td><td>u</td><td>s</td><td>t</td><td>o</td><td>m</td></tr> <tr><td>E</td><td>N</td><td>T</td><td>E</td><td>R</td><td>E</td><td>D</td><td>I</td><td>N</td><td>S</td><td>F</td><td>C</td><td></td><td></td></tr> </table> <table border="1"> <tr><td>E</td><td>U</td><td>L</td><td>o</td><td></td><td></td><td></td><td></td><td>C</td><td>u</td><td>s</td><td>t</td><td>o</td><td>m</td></tr> <tr><td>></td><td>R</td><td>A</td><td>N</td><td>G</td><td>E</td><td></td><td></td><td></td><td></td><td></td><td></td><td></td><td></td></tr> </table>	E	U	H	i					C	u	s	t	o	m	E	N	T	E	R	E	D	I	N	S	F	C			E	U	L	o					C	u	s	t	o	m	>	R	A	N	G	E									<p>Enters upper display limit in SFC and calls up lower display limit setting.</p>																																																		
E	U	H	i					C	u	s	t	o	m																																																																																																
E	N	T	E	R	E	D	I	N	S	F	C																																																																																																		
E	U	L	o					C	u	s	t	o	m																																																																																																
>	R	A	N	G	E																																																																																																								
10	<table border="1"> <tr><td>+</td><td>/</td><td>-</td></tr> </table> <table border="1"> <tr><td>S</td></tr> <tr><td>5</td></tr> </table>	+	/	-	S	5	<table border="1"> <tr><td>E</td><td>U</td><td>L</td><td>o</td><td></td><td></td><td></td><td></td><td>C</td><td>u</td><td>s</td><td>t</td><td>o</td><td>m</td></tr> <tr><td>-</td><td>-</td><td></td><td></td><td></td><td></td><td></td><td></td><td></td><td></td><td></td><td></td><td></td><td></td></tr> </table> <table border="1"> <tr><td>E</td><td>U</td><td>L</td><td>o</td><td></td><td></td><td></td><td></td><td>C</td><td>u</td><td>s</td><td>t</td><td>o</td><td>m</td></tr> <tr><td>-</td><td>5</td><td>_</td><td></td><td></td><td></td><td></td><td></td><td></td><td></td><td></td><td></td><td></td><td></td></tr> </table>	E	U	L	o					C	u	s	t	o	m	-	-													E	U	L	o					C	u	s	t	o	m	-	5	_												<p>Key in -5 as lower display limit for Custom unit in transmitter configured for LINEAR output mode. (Note that lower limit value is referenced to configured LRV.)</p> <p>ATTENTION Zero (0) is only valid entry for GPM or GPH unit, or CUSTOM unit with transmitter in SQUARE ROOT output mode.</p>																																													
+	/	-																																																																																																											
S																																																																																																													
5																																																																																																													
E	U	L	o					C	u	s	t	o	m																																																																																																
-	-																																																																																																												
E	U	L	o					C	u	s	t	o	m																																																																																																
-	5	_																																																																																																											

Continued on next page

6.11 Configuring Smart Meter Using SFC, Continued

Procedure, continued

Table 30 Setting Up Local Smart Meter Configuration Using an SFC, continued

Step	Press Key	Read Display or Action	Description																																																																																																														
11	NON-VOL ENTER (YES)	<table border="1"> <tr><td>E</td><td>U</td><td>L</td><td>o</td><td></td><td></td><td>C</td><td>u</td><td>s</td><td>t</td><td>o</td><td>m</td></tr> <tr><td>E</td><td>N</td><td>T</td><td>E</td><td>R</td><td>E</td><td>D</td><td>I</td><td>N</td><td>S</td><td>F</td><td>C</td></tr> </table> <table border="1"> <tr><td>E</td><td>n</td><td>g</td><td>U</td><td>n</td><td>i</td><td>t</td><td>s</td><td>H</td><td>i</td><td>-</td><td>L</td><td>o</td></tr> <tr><td>E</td><td>N</td><td>T</td><td>E</td><td>R</td><td>C</td><td>H</td><td>A</td><td>N</td><td>G</td><td>E</td><td>S</td><td>?</td></tr> </table>	E	U	L	o			C	u	s	t	o	m	E	N	T	E	R	E	D	I	N	S	F	C	E	n	g	U	n	i	t	s	H	i	-	L	o	E	N	T	E	R	C	H	A	N	G	E	S	?	Enters lower display limit in SFC and prompts if you want to enter changes in transmitter. If you want to enter changes, go to Step 12. If you do not want to enter changes, press [CLR] key to exit function.																																																												
E	U	L	o			C	u	s	t	o	m																																																																																																						
E	N	T	E	R	E	D	I	N	S	F	C																																																																																																						
E	n	g	U	n	i	t	s	H	i	-	L	o																																																																																																					
E	N	T	E	R	C	H	A	N	G	E	S	?																																																																																																					
12	NON-VOL ENTER (YES)	<table border="1"> <tr><td>E</td><td>n</td><td>g</td><td>U</td><td>n</td><td>i</td><td>t</td><td>s</td><td>H</td><td>i</td><td>-</td><td>L</td><td>o</td></tr> <tr><td>S</td><td>F</td><td>C</td><td>W</td><td>O</td><td>R</td><td>K</td><td>I</td><td>N</td><td>G</td><td>.</td><td>.</td><td>.</td></tr> </table> <table border="1"> <tr><td>E</td><td>n</td><td>g</td><td>U</td><td>n</td><td>i</td><td>t</td><td>s</td><td>H</td><td>i</td><td>-</td><td>L</td><td>o</td></tr> <tr><td>D</td><td>a</td><td>t</td><td>a</td><td>D</td><td>o</td><td>w</td><td>n</td><td>l</td><td>o</td><td>a</td><td>d</td><td>e</td><td>d</td></tr> </table> <table border="1"> <tr><td>M</td><td>e</td><td>t</td><td>e</td><td>r</td><td>C</td><td>o</td><td>n</td><td>f</td><td>i</td><td>g</td><td></td><td></td></tr> <tr><td>C</td><td>o</td><td>n</td><td>f</td><td>i</td><td>g</td><td>u</td><td>r</td><td>e</td><td>M</td><td>e</td><td>t</td><td>e</td><td>r</td><td>?</td></tr> </table>	E	n	g	U	n	i	t	s	H	i	-	L	o	S	F	C	W	O	R	K	I	N	G	.	.	.	E	n	g	U	n	i	t	s	H	i	-	L	o	D	a	t	a	D	o	w	n	l	o	a	d	e	d	M	e	t	e	r	C	o	n	f	i	g			C	o	n	f	i	g	u	r	e	M	e	t	e	r	?	Downloads changes to transmitter and returns to Configure Meter? prompt. Press [CLR] key to return to ST CONFIG menu. Skip Step 13.																													
E	n	g	U	n	i	t	s	H	i	-	L	o																																																																																																					
S	F	C	W	O	R	K	I	N	G	.	.	.																																																																																																					
E	n	g	U	n	i	t	s	H	i	-	L	o																																																																																																					
D	a	t	a	D	o	w	n	l	o	a	d	e	d																																																																																																				
M	e	t	e	r	C	o	n	f	i	g																																																																																																							
C	o	n	f	i	g	u	r	e	M	e	t	e	r	?																																																																																																			
13	NON-VOL ENTER (YES)	<table border="1"> <tr><td>M</td><td>e</td><td>t</td><td>e</td><td>r</td><td>E</td><td>n</td><td>g</td><td>U</td><td>n</td><td>i</td><td>t</td><td>s</td></tr> <tr><td>S</td><td>F</td><td>C</td><td>W</td><td>O</td><td>R</td><td>K</td><td>I</td><td>N</td><td>G</td><td>.</td><td>.</td><td>.</td></tr> </table> <table border="1"> <tr><td>M</td><td>e</td><td>t</td><td>e</td><td>r</td><td>E</td><td>n</td><td>g</td><td>U</td><td>n</td><td>i</td><td>t</td><td>s</td></tr> <tr><td>D</td><td>a</td><td>t</td><td>a</td><td>D</td><td>o</td><td>w</td><td>n</td><td>l</td><td>o</td><td>a</td><td>d</td><td>e</td><td>d</td></tr> </table> <table border="1"> <tr><td>M</td><td>e</td><td>t</td><td>e</td><td>r</td><td>E</td><td>n</td><td>g</td><td>U</td><td>n</td><td>i</td><td>t</td><td>s</td></tr> <tr><td>M</td><td>t</td><td>r</td><td>N</td><td>o</td><td>t</td><td>I</td><td>n</td><td>F</td><td>l</td><td>o</td><td>w</td><td>M</td><td>o</td><td>d</td><td>e</td></tr> </table> <table border="1"> <tr><td>M</td><td>e</td><td>t</td><td>e</td><td>r</td><td>C</td><td>o</td><td>n</td><td>f</td><td>i</td><td>g</td><td></td><td></td></tr> <tr><td>C</td><td>o</td><td>n</td><td>f</td><td>i</td><td>g</td><td>u</td><td>r</td><td>e</td><td>M</td><td>e</td><td>t</td><td>e</td><td>r</td><td>?</td></tr> </table>	M	e	t	e	r	E	n	g	U	n	i	t	s	S	F	C	W	O	R	K	I	N	G	.	.	.	M	e	t	e	r	E	n	g	U	n	i	t	s	D	a	t	a	D	o	w	n	l	o	a	d	e	d	M	e	t	e	r	E	n	g	U	n	i	t	s	M	t	r	N	o	t	I	n	F	l	o	w	M	o	d	e	M	e	t	e	r	C	o	n	f	i	g			C	o	n	f	i	g	u	r	e	M	e	t	e	r	?	Downloads selected pressure engineering unit to transmitter. Press [CLR] key to return to ST CONFIG menu. ATTENTION If you select a pressure unit with the transmitter in its SQUARE ROOT (Flow) mode, the prompts "INVALID REQUEST" and "Download Error" are sequentially displayed after the SFC WORKING. . . prompt and the EU Hi prompt is called up for display. At this point, you can change the upper display limit as shown in Step 8 or press the [σ NEXT] key to call up the EU Lo prompt. See Step 10 to change the lower display limit or press the [σ NEXT] key and then the [CLR] key to exit the function.
M	e	t	e	r	E	n	g	U	n	i	t	s																																																																																																					
S	F	C	W	O	R	K	I	N	G	.	.	.																																																																																																					
M	e	t	e	r	E	n	g	U	n	i	t	s																																																																																																					
D	a	t	a	D	o	w	n	l	o	a	d	e	d																																																																																																				
M	e	t	e	r	E	n	g	U	n	i	t	s																																																																																																					
M	t	r	N	o	t	I	n	F	l	o	w	M	o	d	e																																																																																																		
M	e	t	e	r	C	o	n	f	i	g																																																																																																							
C	o	n	f	i	g	u	r	e	M	e	t	e	r	?																																																																																																			
14		If you selected one of these engineering units: %, inH ₂ O, mmHg, PSI, GPM, or GPH; verify that corresponding unit indicator is lit on Local Smart Meter display.	If selected engineering unit does not match one of six unit indicators on meter, you can use a stick-on label from Honeywell drawing 30756918-001. Just peel off matching engineering unit label from drawing and carefully paste it in lower right hand corner of display.																																																																																																														

Continued on next page

6.11 Configuring Smart Meter Using SFC, Continued

Keystroke summary Figure 35 shows the keystroke summary for configuring the Local Smart Meter using the SFC for quick reference.

Figure 35 Keystroke Summary for Configuring Local Smart Meter.

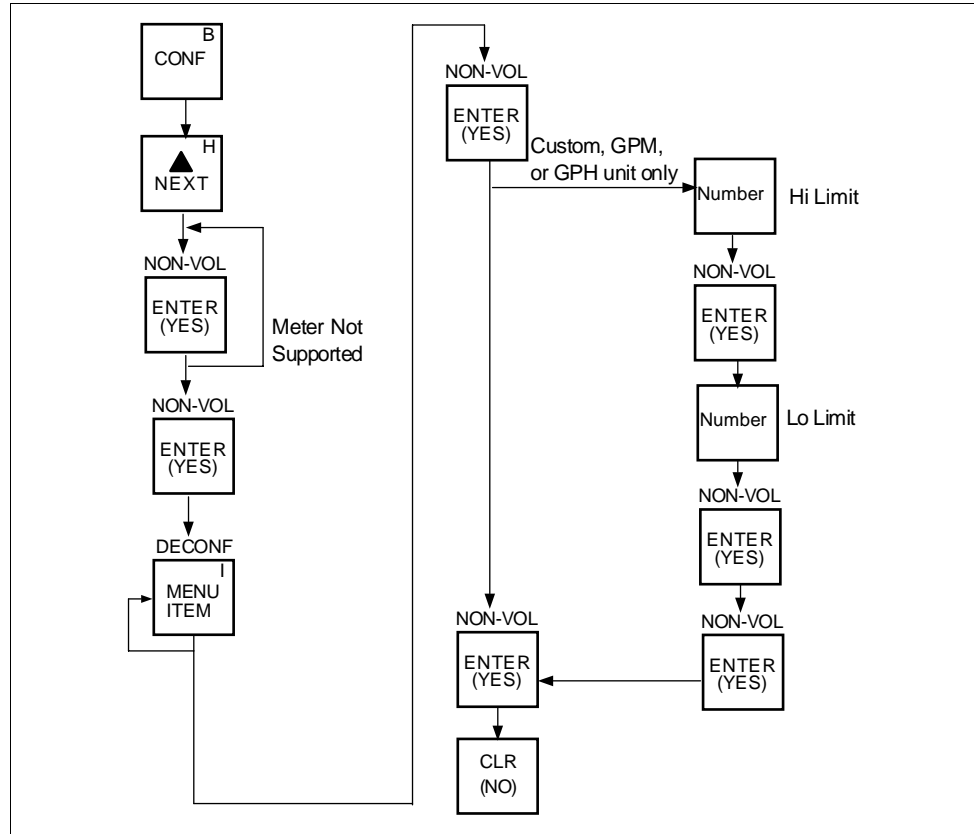

6.12 Configuring Smart Meter Using Pushbuttons

Background

The local smart meter can be set to show the PV out in engineering units that are appropriate for your process application. You can select an available engineering unit or enter a custom one including upper and lower display limit settings for the local smart meter's digital readout using buttons on the face of the meter.

Using the Smart Meter

Follow these guidelines when configuring the local smart meter:

- If you initiate an SFC command at the same time a button is pressed on the local smart meter, the local smart meter will respond to the command it receives last. In other words, the last command wins.
- In most cases, you can press and release a button for one-shot operation, or press and hold a button for continuous, 1/2 second, repetitive operation.
- Active setup field will begin to flash at one second rate if next action is not initiated within one second. And, if no action is taken within 30 seconds, the setup function will time out and the meter will return to its previous state.

Table 31 shows an illustration of the local smart meter and a description of the pushbuttons on the meter face.

Table 31 Smart Meter Pushbutton Description

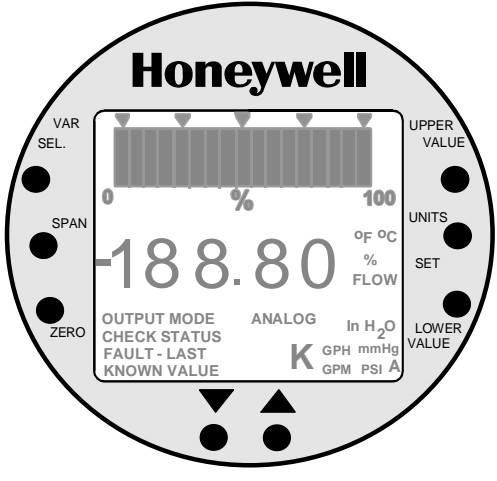
Smart Meter Pushbuttons	Pushbutton	Function
	VAR SEL.	Not functional when installed with ST 3000 transmitters.
	SPAN	Selects Span range setting (URV).
	ZERO	Selects Zero range setting (LRV).
	UPPER VALUE	Selects Upper Range Value setting (URV).
	UNITS SET	Selects engineering units for meter display.
	LOWER VALUE	Selects Lower Range Value (LRV).
	τ	Decrease pushbutton
	σ	Increase pushbutton

Continued on next page

6.12 Configuring Smart Meter Using Pushbuttons, Continued

Transmitter Output Conformity and Smart Meter Configuration

Normally when using a differential type transmitter, you can select the transmitter's output to represent a straight linear calculation or a square root calculation for flow measurement applications. This linear or square root output parameter selection is called output conformity or output form. (See Subsection 6.4 for more details.)

When configuring the smart meter to display the transmitter output measurement, there are certain rules to keep in mind which are dependent on the output conformity selection. These rules are described in the following paragraphs.

1. The output conformity setting of the transmitter restricts the engineering units you can select for the smart meter display.
 - When the transmitter is configured for an output conformity of **LINEAR**, you can select only pressure type engineering units. (See Table 32.)
 - When the transmitter is configured for an output conformity of **SQUARE ROOT**, you can select only flow type engineering units GPM and GPH.
 - The percent and custom engineering units can be selected regardless of output conformity configuration.
2. Additionally, the output conformity setting restricts the setting of the lower and upper display limits to represent transmitter's 0 to 100% output.
 - If you select pressure type engineering units, you cannot set the lower or upper display limits. These values are automatically set when you select the engineering units.
 - You can set only the upper display limit when the transmitter is configured for **SQUARE ROOT** output conformity. The lower display limit is fixed at zero (0) for a transmitter in square root mode and cannot be changed.
 - You can set both the lower and upper display limits when you have selected custom engineering units (EUF) and the transmitter output conformity is set to **LINEAR**.

When setting the lower and upper display limits, if you let either the lower or upper display limit setting time out (after thirty seconds), the meter will discard the newly set values and will revert to its previous settings. The meter forces you to set both limits by automatically initiating the next limit setting, either lower or upper, depending upon which limit you set first.

3. If you change the transmitter's output conformity, you must reconfigure the Local Smart meter as outlined in Tables 33 to 36.

Continued on next page

6.12 Configuring Smart Meter Using Pushbuttons, Continued

Transmitter Output
Conformity and Smart
Meter Configuration,
continued

Table 32 Smart Meter Engineering Units Code

Smart Meter Code	Engineering Unit	Transmitter Output Conformity
EU0	% *	Linear or Square Root
EU1	in H ₂ O *	Linear
EU2	mmHg *	
EU3	PSI *	
EU4	kPa †	
EU5	MPa †	
EU6	mbar †	
EU7	bar †	
EU8	g/cm ² †	
EU9	kg/cm ² †	
EUA	mmH ₂ O †	
EUB	inHg †	
EUC	mH ₂ O †	
EUD	GPM *	
EUE	GPH *	Square Root
EUF	Custom †	Linear or Square Root

* These selections have indicators on smart meter display.

† Use stick-on labels provided for other engineering units.

Selecting Engineering Units

The procedure in Table 33 outlines the steps for selecting the desired engineering units for a Local Smart Meter using its local adjustments on the face of the meter. **You will be selecting the unit of measurement that you want the smart meter to indicate during normal operation.**

WARNING

When the transmitter's end-cap is removed, the housing is not explosionproof.

Continued on next page

6.12 Configuring Smart Meter Using Pushbuttons, Continued

Selecting Engineering Units, continued

Table 33 Selecting Engineering Units

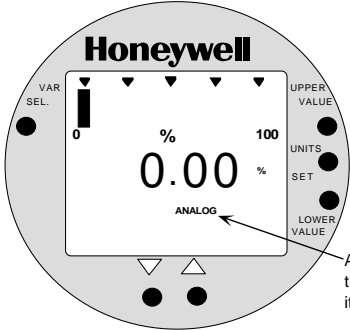
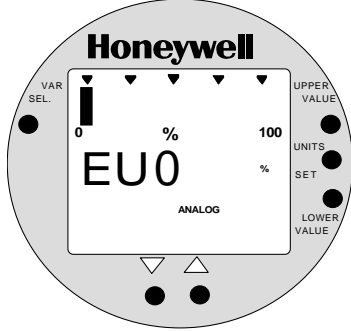
Step	Action	Meter Display
1	Loosen lock on meter end-cap and unscrew cap from housing. Be sure transmitter power is ON.	<p>Typical display for meter in transmitter that has no previous meter configuration stored in its memory.</p>  <p>The diagram shows a circular Honeywell meter display. At the top, it says "Honeywell". Below that is a scale from 0 to 100 with a vertical bar. The main display shows "0.00 %". Below the display, it says "ANALOG". To the right of the display are four buttons labeled "UPPER VALUE", "UNITS SET", and "LOWER VALUE". An arrow points from the text "Appears when transmitter is in its Analog mode." to the "ANALOG" label on the display.</p>
2	Press UNITS SET button.	<p>Display shows code for current engineering units setting.</p>  <p>The diagram shows the same Honeywell meter display. The main display now shows "EU0". The "ANALOG" label is still present at the bottom of the display area.</p>

Continued on next page

6.12 Configuring Smart Meter Using Pushbuttons, Continued

Selecting Engineering Units, continued

Table 33 Selecting Engineering Units, continued

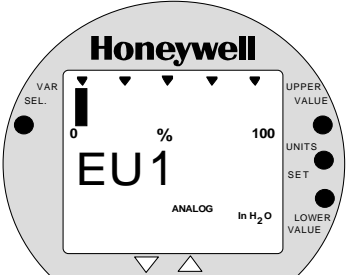
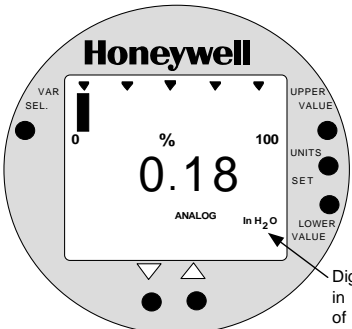
Step	Action	Meter Display
<p>3</p> <p>Press Increase σ key to call up next code or Decrease τ button call up previous code. Repeat this action until desired code is on display.</p> <p>You can hold down the Increase or Decrease key to scroll forward or backward through the codes.</p> <p>ATTENTION Remember that if transmitter is configured for SQUARE ROOT output conformity the only valid code selections are EU0 (%) EUD (GPM) EUE (GPH) EUF (Custom)</p> <p>If transmitter is configured for LINEAR output conformity EU0 (%) to EUC and EUF (CUSTOM) are valid code selections.</p>		<p>Selection codes for engineering units</p>  <p>Press and hold to scroll backward through selections</p> <p>Press and hold to scroll forward through selections</p> <ul style="list-style-type: none"> EU0 = %* EU1 = inH₂O* EU2 = mmHg* EU3 = PSI* EU4 = KPa EU5 = MPa EU6 = mbar EU7 = bar EU8 = g/cm² EU9 = Kg/cm² EUA = mmH₂O EUB = inHg EUC = mH₂O EUD = GPM* EUE = GPH* EUF = Custom <p>*These selections have indicators on the display.</p>
<p>4</p> <p>Press UNITS SET button to lock in selected code.</p> <p>ATTENTION If you select an invalid code according to the selections in Step 3, the meter display will show an error code Er1 for one second and then return to the previous engineering units selection.</p>		<p>Goes blank for 1/2 second and returns with reading in engineering units</p>  <p>Digital reading now in engineering units of inches of water</p>

Continued on next page

6.12 Configuring Smart Meter Using Pushbuttons, Continued

Selecting Engineering Units, continued

Table 33 Selecting Engineering Units, continued

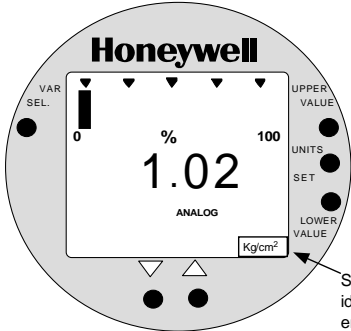
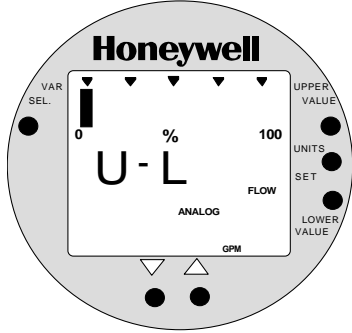
Step	Action	Meter Display
5	If selected engineering unit does not match one of six unit indicators on meter, peel off matching stick-on unit label from sheet (drawing number 30756918-001) and paste it in lower right hand corner of meter.	<p>Use stick-on label for engineering units without indicators on display.</p>  <p>Stick-on label identifies selected engineering units</p>
6	If you selected Custom or Flow engineering units, go to Tables 35 and 36 to set lower and upper display limits for smart meter display.	<p>Lower and upper display limits have not been set for Custom or Flow engineering units.</p> 

6.12 Configuring Smart Meter Using Pushbuttons, Continued

Setting Lower and Upper Display Values

The Table 34 shows the restrictions on setting the display values for given engineering units and output conformity selections.

Table 34 Smart Meter Restrictions for Setting Display Values

Engineering Units code	Output Conformity	Set	
		Lower Display Value?	Upper Display Value?
EU0 through EUC (Pressure type units)	Linear	No (set automatically)	No (set automatically)
EU0, EUD, EUE, and EUF (%, GPM, GPH, or Custom)	Square root	No (fixed at zero)	Yes Use Table 36
EUF (Custom)	Linear	Yes Use Table 35	Yes Use Table 36

Setting Lower and Upper Display Values

To set the lower and upper display limit values for the meter display perform the procedures in Tables 35 and 36. Also note that in each procedure you must:

- First set the **magnitude range** for each display value. This enables the multiplier (K) on the display for indicating larger ranges (greater than 19999 and shifts the decimal point of the digital display left or right depending on the precision you want to show for that value).
- Next set the **display value**. This procedure sets the display limit of the meter to represent minimum and maximum transmitter output (0% and 100 % output).

Note: Magnitude range and display values are set for both upper and lower (if applicable) display limits.

During normal operation, the display range of the meter digital readout is $\pm 19,990,000$ and is automatically ranged to provide the best precision possible for the digits available up to 1/100th of a unit.

Setting Lower Display Values

The procedure in Table 35 outlines the steps for setting the lower display limit to represent the 0 percent (LRV) output of the transmitter.

ATTENTION

For example purposes, the procedures in Tables 35 and 36 assume that the lower value is to be set at 0 and the upper value is to be set at 19,990,000 for a CUSTOM unit in a transmitter with a LINEAR output, and the transmitter's present output is exactly 50 percent.

Continued on next page

6.12 Configuring Smart Meter Using Pushbuttons, Continued

Setting Lower Display Values, continued

Table 35 Setting Lower Display Values for Smart Meter Display

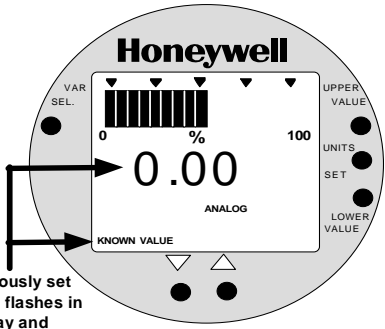
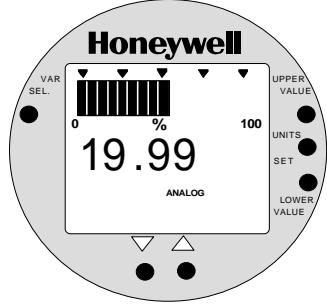
Step	Action	Meter Display
<p>1</p>	<p>You have completed units selection in Table 33 and U-L appears on the display. Press LOWER VALUE button to initiate lower display limit setting function.</p> <p>ATTENTION This procedure is only applicable for Custom (EUF) engineering unit selection in a transmitter configured for LINEAR output conformity.</p> <p>The lower display value for transmitters configured for SQUARE ROOT output conformity is fixed at zero (0.00) and cannot be changed.</p>	<p>If lower limit display value was previously set, KNOWN VALUE indicator lights and set value flashes in display.</p>  <p>The diagram shows a circular Honeywell smart meter display. The screen displays '0.00' with a '%' symbol and 'ANALOG' below it. A bar graph at the top shows a full scale from 0 to 100. On the left side of the display, there is a 'VAR SEL.' button and a 'KNOWN VALUE' indicator light. On the right side, there are buttons for 'UPPER VALUE', 'UNITS', 'SET', and 'LOWER VALUE'. Below the screen are two arrow buttons (up and down). A text box with an arrow points to the 'KNOWN VALUE' indicator, stating 'Previously set value flashes in display and indicator lights'.</p>
<p>2</p>	<p>Press LOWER VALUE button again within 5 seconds. Otherwise, meter exits limit setting function.</p>	<p>Display shows magnitude range selection.</p>  <p>ATTENTION The magnitude range selection only applies for setting the display limits. This selection does not affect the normal operation of the meter. During normal operation, the display is automatically ranged to provide the best precision possible.</p> <p>The diagram shows the same Honeywell smart meter display as in step 1, but the screen now displays '19.99' with a '%' symbol and 'ANALOG' below it. The 'KNOWN VALUE' indicator is no longer present.</p>

Continued on next page

6.12 Configuring Smart Meter Using Pushbuttons, Continued

Setting Lower Display Values, continued

Table 35 Setting Lower Display Values for Smart Meter Display, continued

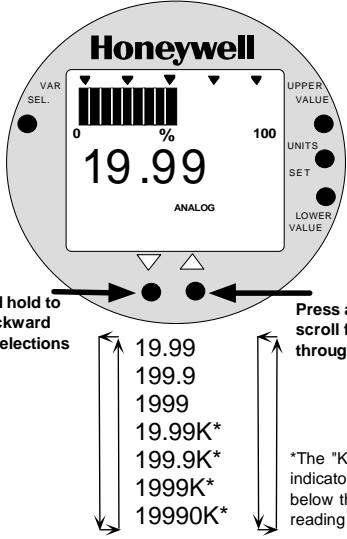
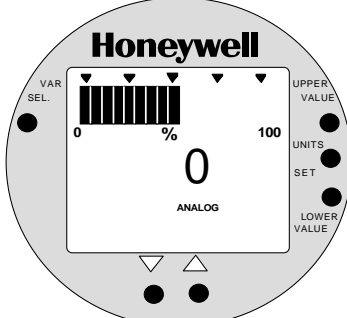
Step	Action	Meter Display
<p>3</p> <p>Press Increase σ button to call up next available magnitude range selection or Decrease τ button to call up previous magnitude range selection.</p> <p>NOTE: This action enables the multiplier (K) for indicating larger ranges and shifts the decimal point of the digital display left or right depending on which button is pushed. The display shows largest positive number for given range selection so you can select a range that is just larger than the range to be set for best display precision. Hold respective key to scroll forward or backward through the selections.</p> <p>Repeat this action until desired selection is on display.</p>		<p>Magnitude range selections.</p>  <p>Press and hold to scroll backward through selections</p> <p>Press and hold to scroll forward through selections</p> <p>*The "K" multiplier indicator appears below the digital reading on the display.</p>
<p>4</p> <p>Press LOWER VALUE button to initiate lower value setting.</p>		<p>Readout goes blank except for first active digit which will be 0 unless lower value was set before.</p> 

Continued on next page

6.12 Configuring Smart Meter Using Pushbuttons, Continued

Setting Lower Display Values, continued

Table 35 Setting Lower Display Values for Smart Meter Display, continued

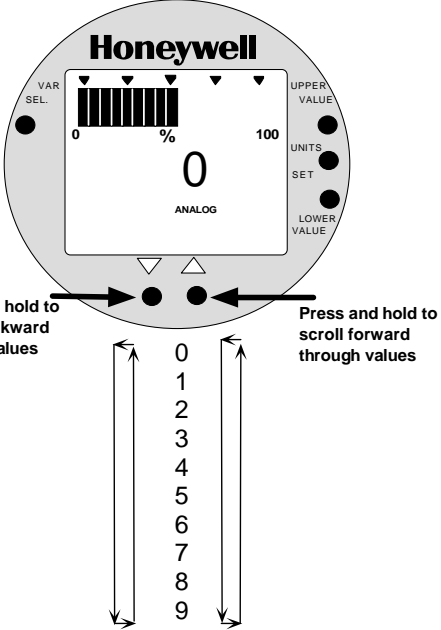
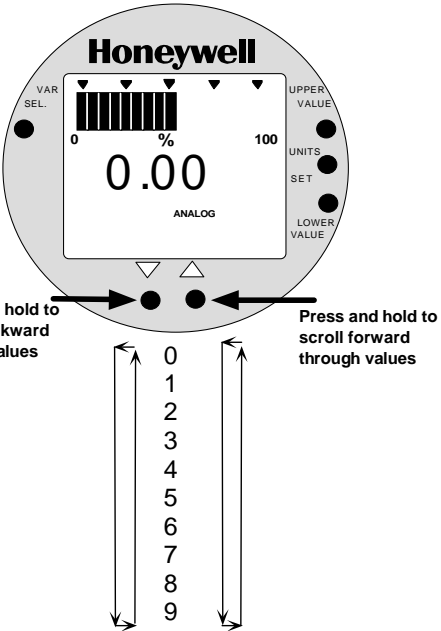
Step	Action	Meter Display
5	<p>Press Increase σ button to select the next available digit value or Decrease τ button to select the previous digit value.</p> <p>Repeat this action until desired value is on display.</p>	<p>First digit value setting.</p> 
6	<p>Press LOWER VALUE button to lock-in first digit and activate next active digit.</p> <p>Readout now displays next active digit which will be zero unless lower value was set before.</p>	
7	<p>Press Increase σ button to select the next available digit value or Decrease τ button to select the previous digit value.</p> <p>Repeat this action until desired value is on display.</p>	
8	<p>Press LOWER VALUE button to lock-in second digit and activate next active digit.</p> <p>Readout now displays next active digit which will be zero unless lower value was set before.</p>	
9	<p>Press Increase σ button to select the next available digit value or Decrease τ button to select the previous digit value.</p> <p>Repeat this action until desired value is on display.</p>	<p>Third digit value setting.</p> 

6.12 Configuring Smart Meter Using Pushbuttons, Continued

Setting Lower Display Values, continued

Table 35 Setting Lower Display Values for Smart Meter Display, continued

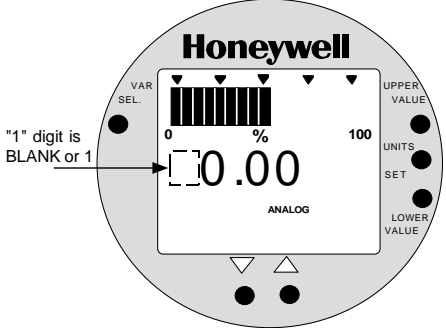
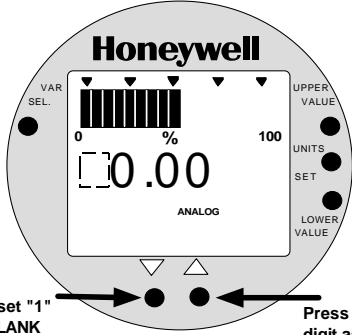
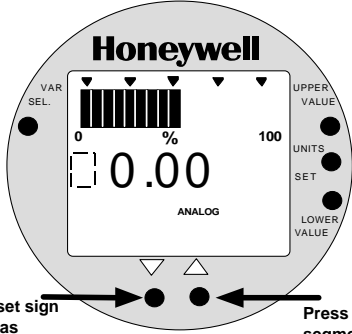
Step	Action	Meter Display
10	<p>Press LOWER VALUE button to lock-in third digit and activate next active digit.</p> <p>Readout now displays next active digit which will be BLANK unless lower value was set to 1 before.</p>	
11	<p>Press Increase σ button to set digit to 1 or Decrease τ button to set it to BLANK.</p>	<p>“1” digit value setting.</p>
12	<p>Press LOWER VALUE button to lock-in “1” digit and activate sign segment.</p> <p>Readout now displays sign segment which will be BLANK for positive values unless lower value was set for negative (-) values before.</p>	
13	<p>Press Increase σ button to set sign segment to minus sign for negative values or Decrease τ button to set it to BLANK for positive values.</p>	<p>Sign segment setting.</p>
14	<p>Press LOWER VALUE button to lock in current settings as lower display value limit.</p> <p>ATTENTION For CUSTOM unit in transmitter with LINEAR output, you must set both lower and upper display limits for values to take effect. If you let either the lower or upper display limit time out (after 30 seconds), the meter discards both newly set values and reverts back to the previously set values.</p>	
<ul style="list-style-type: none"> If you have not yet set the upper display limit value, the meter automatically enters the upper display setting function after it displays previously set value, if applicable. Go to Table 36. If you have already set the upper display limit value, this completes the lower and upper display limits setting function for Custom engineering units in the transmitter. Meter returns to normal operation. 		

Continued on next page

6.12 Configuring Smart Meter Using Pushbuttons, Continued

Setting Upper Display Values

The procedure in Table 36 outlines the steps for setting the upper display limit to represent the 100 percent (URV) output of the transmitter.

ATTENTION

This procedure applies only for Flow units (GPM or GPH) in a transmitter configured for SQUARE ROOT output conformity, or CUSTOM unit in a transmitter configured for linear or square root output conformity.

Table 36 Setting Upper Display Value for Smart Meter Display

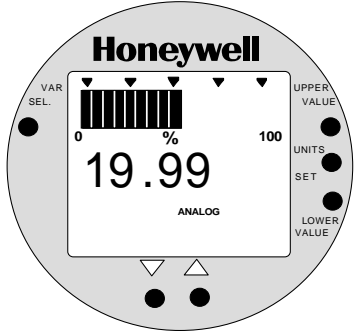
Step	Action	Meter Display
1	Press UPPER VALUE button to initiate upper display limit setting function.	If upper limit display value was previously set, KNOWN VALUE indicator lights and set value flashes in display.
2	Press UPPER VALUE button again within 5 seconds. Otherwise, meter exits limit setting function.	<p>Display shows magnitude range selection.</p>  <p>ATTENTION The magnitude range selection only applies for setting the display limits. This selection does not affect the normal operation of the meter. During normal operation, the display is automatically ranged to provide the best precision possible.</p>

Continued on next page

6.12 Configuring Smart Meter Using Pushbuttons, Continued

Setting Upper Display Values, continued

Table 36 Setting Upper Display Value for Smart Meter Display, continued

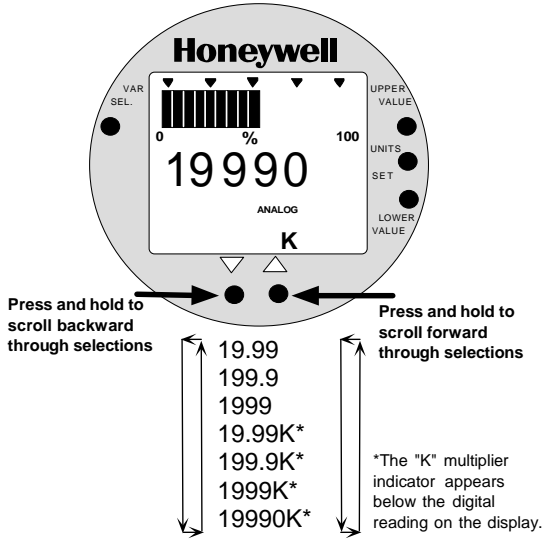
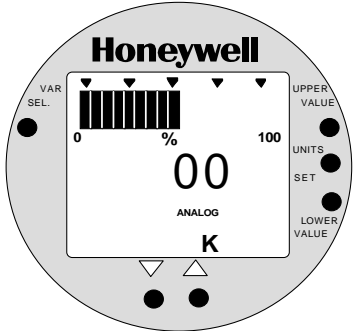
Step	Action	Meter Display
<p>3</p> <p>Press Increase σ button to call up next available magnitude range selection or Decrease τ button to call up previous magnitude range selection.</p> <p>NOTE: This action enables the multiplier (K) for indicating larger ranges and shifts the decimal point of the digital display left or right depending on which button is pushed. The display shows largest positive number for given range selection so you can select a range that is just larger than the range to be set for best display precision. Hold respective key to scroll forward or backward through the selections.</p> <p>Repeat this action until desired selection is on display. For example purposes only, largest range 19990K is selected in this procedure.</p>	<p>Magnitude range selections with largest range selected.</p>  <p>Press and hold to scroll backward through selections</p> <p>Press and hold to scroll forward through selections</p> <p>*The "K" multiplier indicator appears below the digital reading on the display.</p>	
<p>4</p> <p>Press UPPER VALUE button to initiate upper value setting.</p>	<p>Readout goes blank except for first active digit which will be 0 unless upper value was set before.</p> 	

Continued on next page

6.12 Configuring Smart Meter Using Pushbuttons, Continued

Setting Upper Display Values, continued

Table 36 Setting Upper Display Value for Smart Meter Display, continued

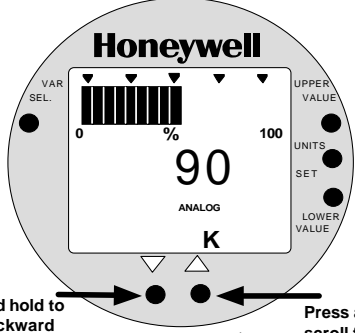
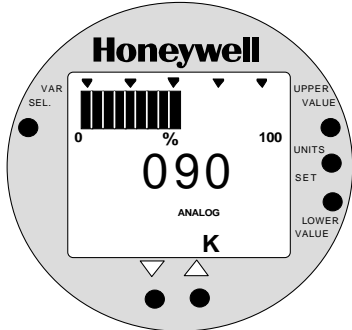
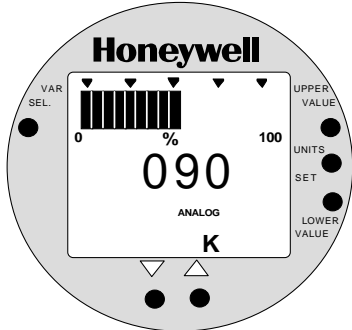
Step	Action	Meter Display
5	<p>Press Increase σ button to select the next available digit value or Decrease τ button to select the previous digit value.</p> <p>Repeat this action until desired value is on display – use 9 for example purposes.</p>	<p>First digit value setting is set to 9.</p>  <p>The diagram shows a circular Honeywell smart meter display. The screen displays '90' and 'K'. Above the screen is a bar graph with a percentage sign. To the left of the screen is a 'VAR SEL.' button. To the right are 'UPPER VALUE', 'UNITS', 'SET', and 'LOWER VALUE' buttons. Below the screen are two arrow buttons. Below these are two vertical double-headed arrows pointing to a numeric keypad with digits 0-9. Labels indicate 'Press and hold to scroll backward through values' for the left arrow and 'Press and hold to scroll forward through values' for the right arrow.</p>
6	<p>Press UPPER VALUE button to lock-in first digit and activate next active digit.</p> <p>Readout now displays next active digit which will be zero unless upper value was set before.</p>	 <p>The diagram shows the same Honeywell smart meter display. The screen now displays '090' and 'K'. The bar graph and buttons are the same as in the previous diagram.</p>
7	<p>Press Increase σ button to select the next available digit value or Decrease τ button to select the previous digit value.</p> <p>Repeat this action until desired value is on display – use 9 for example purposes.</p>	 <p>The diagram shows the same Honeywell smart meter display as in the previous row, with '090' and 'K' on the screen.</p>

Continued on next page

6.12 Configuring Smart Meter Using Pushbuttons, Continued

Setting Upper Display Values, continued

Table 36 Setting Upper Display Value for Smart Meter Display, continued

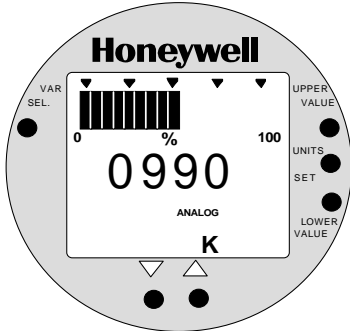
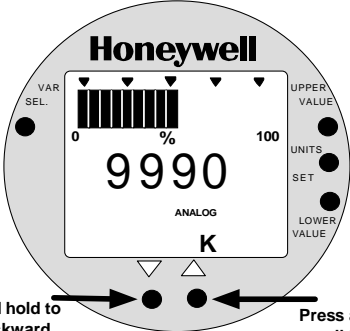
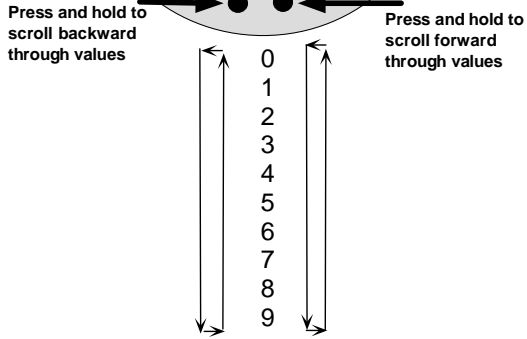
Step	Action	Meter Display
8	<p>Press UPPER VALUE button to lock-in second digit and activate next active digit.</p> <p>Readout now displays next active digit which will be zero unless upper value was set before.</p>	
9	<p>Press Increase σ button to select the next available digit value or Decrease τ button to select the previous digit value.</p> <p>Repeat this action until desired value is on display – use 9 for example purposes.</p>	<p>Next digit value setting is set to 9.</p> 
10	<p>Press UPPER VALUE button to lock-in third digit and activate next active digit.</p> <p>Readout now displays next active digit which will be BLANK unless upper value was set to 1 before.</p>	

Continued on next page

6.12 Configuring Smart Meter Using Pushbuttons, Continued

Setting Upper Display Values, continued

Table 36 Setting Upper Display Value for Smart Meter Display, continued

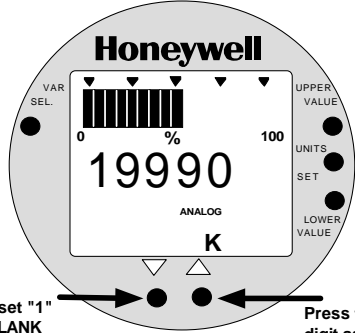
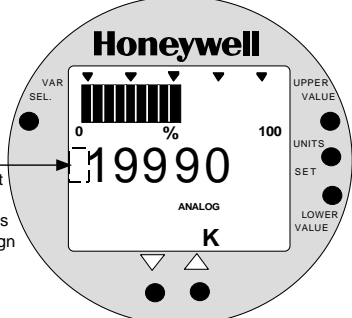
Step	Action	Meter Display
11	Press Increase σ button to set digit to 1 or Decrease τ button to set it to BLANK.	<p>"1" digit value setting is set to 1.</p> 
12	Press UPPER VALUE button to lock-in "1" digit and activate sign segment.	<p>Readout now displays sign segment which will be BLANK for positive values unless upper value was set for negative (-) values before.</p>
13	Press Increase σ button to set sign segment to minus sign for negative values or Decrease τ button to set it to BLANK. for positive values.	

Continued on next page

6.12 Configuring Smart Meter Using Pushbuttons, Continued

Setting Upper Display Values, continued

Table 36 Setting Upper Display Value for Smart Meter Display, continued

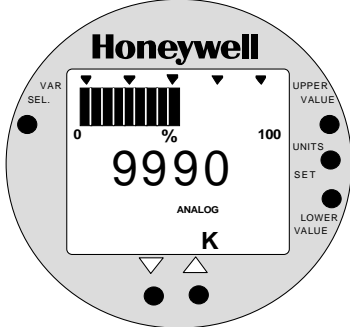
Step	Action	Meter Display
14	<p>Press UPPER VALUE button to lock in current settings as upper display value and return to previous display. Upper display limit setting is now complete.</p> <p>ATTENTION For CUSTOM unit in transmitter with LINEAR output, you must set both lower and upper display limits for values to take effect. If you let either the lower or upper display limit time out (after 30 seconds), the meter discards both newly set values and reverts back to the previously set values.</p>	<p>Display goes blank for a 1/2 second and returns to display readout equal to 50% output.</p> <p>In this example, readout is 9,990,000 CUSTOM unit for 50% display range of 0 to 19,990,000 CUSTOM for transmitter with LINEAR output.</p> 
<ul style="list-style-type: none"> • If you have not yet set the lower display limit value for CUSTOM unit in a transmitter configured for LINEAR output mode, the meter automatically enters the lower display setting function after it displays previously set value, if applicable. Go to Table 35, Step 3. • If you have already set the lower display limit value, this completes the lower and upper display limits setting function for CUSTOM unit in transmitter configured for LINEAR output mode. Meter returns to normal operation as shown in example display below. • If you have just set the upper display limit for Flow unit or CUSTOM unit in transmitter configured for SQUARE ROOT output mode, this completes the limit setting function. Meter returns to normal operation as shown in example display below. 		

Continued on next page

6.12 Configuring Smart Meter Using Pushbuttons, Continued

Button Pushing Summary

Figure 36 shows button pushing summary for the smart meter display to select the engineering units.

Figure 36 Button Pushing Summary for Selecting Engineering Units.

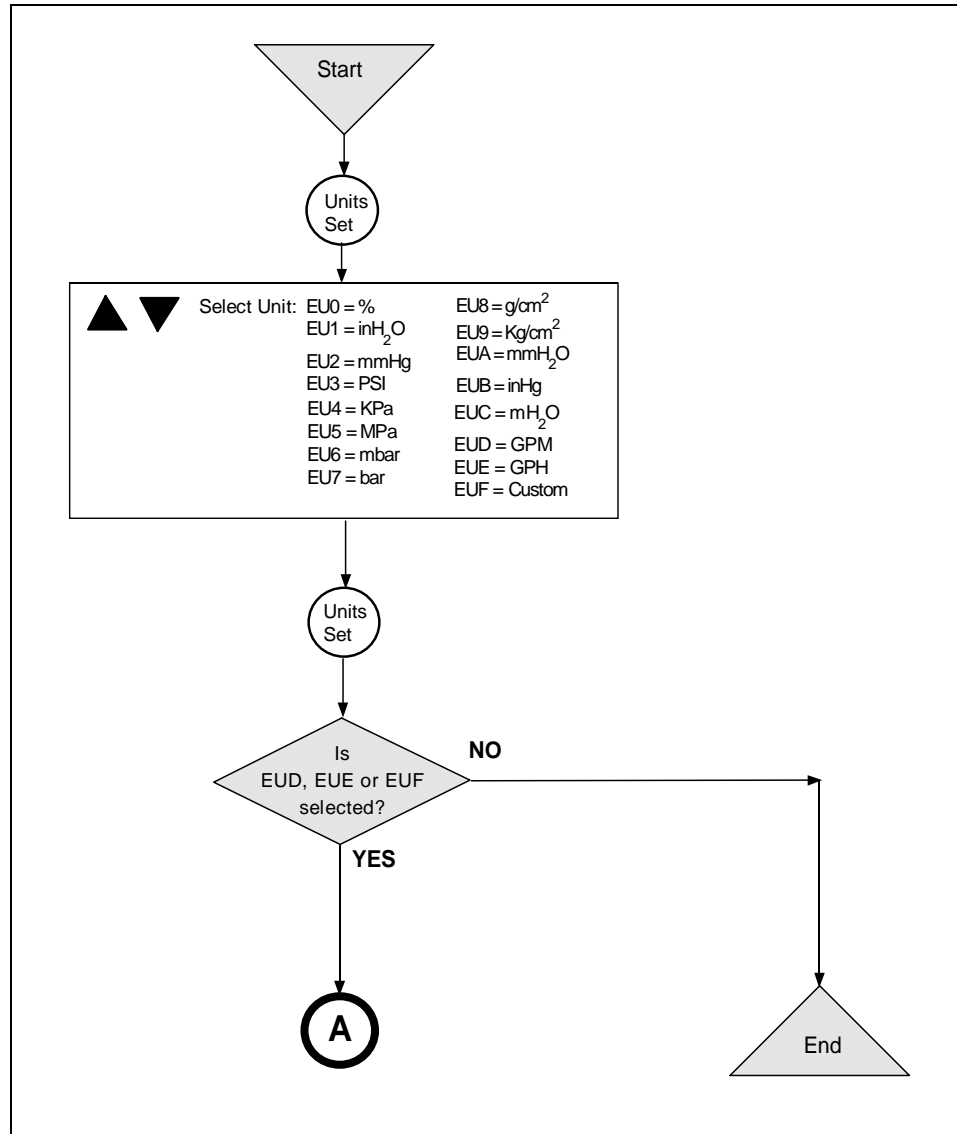

Continued on next page

6.12 Configuring Smart Meter Using Pushbuttons, Continued

Button Pushing Summary

Figure 37 shows button pushing summary for the smart meter display to set the lower and upper display limits.

Figure 37 Button Pushing Summary for Setting Lower and Upper Display Limits.

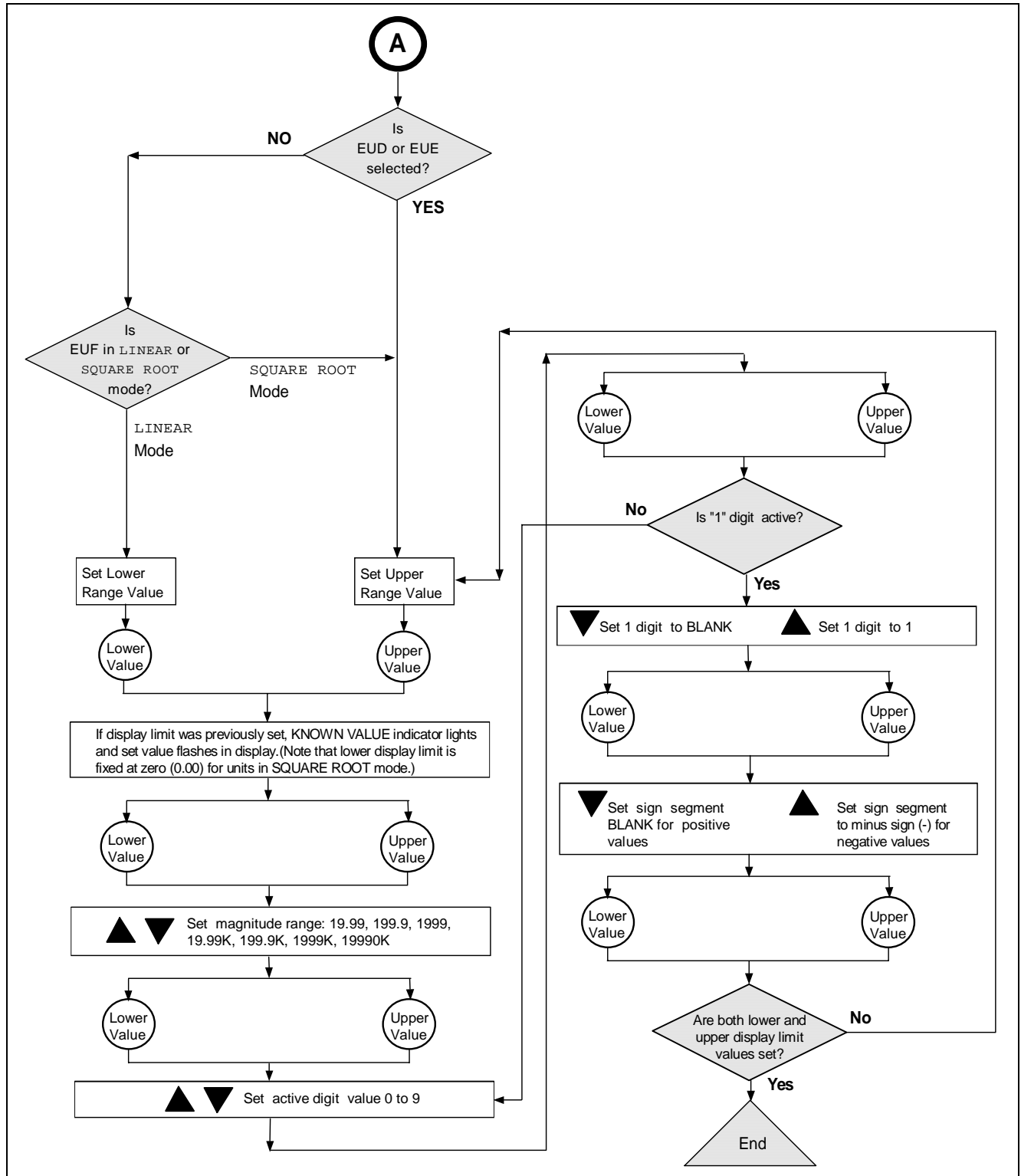

6.13 Disconnecting SFC

Considerations

- Be sure a “#” character does not appear on the right side of the SFC display indicating that the transmitter may be in its current output mode, or the SFC has detected a non-critical status condition.

– Example:

L	R	V	1			P	T	3	0	1	1	#
5	.	∅	∅	∅		i	n	H	2	O		

If the # character is on the display, press the [OUTPUT] key and then the [CLR] key to remove the transmitter from the current output mode, or press the [STAT] key to check the operating status of the transmitter.

– Example:

INPUT	
OUT- PUT	J

O	U	T	P	1		P	T	3	0	1	1	#
S	F	C	W	O	R	K	I	N	G	.	.	.

O	U	T	P	1		P	T	3	0	1	1	#
		5	∅	.	∅	∅	%					

CLR (NO)	
-------------	--

O	U	T	P	1		P	T	3	0	1	1	#
S	F	C	W	O	R	K	I	N	G	.	.	.

L	I	N		D	P	P	T	3	0	1	1	
R	E	A	D	Y	.	.	.					

- Be sure to store all changes in the transmitters non-volatile memory by pressing the [SHIFT] key and then the [ENTER] key.

– Example:

SHIFT		^
-------	--	---

L	I	N		D	P	P	T	3	0	1	1	
				S	H	I	F	T	-			

NON-VOL	
ENTER (Yes)	

L	I	N		D	P	P	T	3	0	1	1	
S	F	C	W	O	R	K	I	N	G	.	.	.

L	I	N		D	P	P	T	3	0	1	1			
D	A	T	A	N	O	N	V	O	L	A	T	I	L	E

L	I	N		D	P	P	T	3	0	1	1	
R	E	A	D	Y	.	.	.					

WARNING

- Be sure to disconnect the SFC leads from the transmitter before unplugging them from the SFC.
- Be sure the SFC is disconnected from a transmitter in the analog mode before returning the loop to the automatic operating mode.

Section 7 —Startup

7.1 Introduction

Section Contents This section includes these topics

Section	Topic	See Page
7.1	Introduction	123
7.2	Startup Tasks	124
7.3	Running Analog Output Check.....	125
7.4	Flow Measurement with DP Transmitter	128
7.5	Pressure Measurement with DP Transmitter	131
7.6	Liquid Level Measurement - Vented Tank.....	133
7.7	Liquid Level Measurement - Pressurized Tank.....	136
7.8	Pressure or Liquid Level Measurement with GP Transmitter.....	140
7.9	Pressure or Liquid Level Measurement with Flush Mount Transmitter	144
7.10	Pressure Measurement with AP Transmitter.....	145
7.11	Liquid Level Measurement with DP Transmitter with Remote Seals.....	147

About this section This section identifies typical startup tasks associated with several generic pressure measurement applications. It also includes the procedure for running an optional analog output check.

7.2 Startup Tasks

About startup

Once you have installed and configured a transmitter, you are ready to start up the process loop. Startup usually includes

- Applying process pressure to the transmitter,
- Checking zero input, and
- Reading input and output.

You can also run an optional output check to “ring out” an analog loop prior to startup.

Procedure reference

The actual steps in a startup procedure will vary based on the type of transmitter and the measurement application. In general, we use the SFC to check the transmitter’s input and output under static process conditions, and make adjustments as required before putting the transmitter into full operation with the running process.

Choose the applicable procedure to reference in this section from Table 37 based on your type of transmitter and the measurement application. The reference procedure will give you some idea of the typical tasks associated with starting up a transmitter in a given application.

Table 37 Startup Procedure Reference

IF transmitter type is . . .	AND application is . . .	THEN reference procedure in section . . .
Differential Pressure (DP)	Flow Measurement	7.4
	Pressure Measurement	7.5
	Liquid Level Measurement for Vented Tank with Dry Reference Leg*	7.6
	Liquid Level Measurement for Pressurized Tank with Liquid-Filled Reference Leg*	7.7
Gauge Pressure (GP)	Pressure or Liquid Level Measurement**	7.8
Flush Mount	Pressure or Liquid Level Measurement	7.9
Absolute Pressure (AP)	Pressure Measurement**	7.10
DP with Remote Seals	Liquid Level Measurement	7.11

* These applications also apply for flange-mounted liquid level type transmitters that are usually mounted directly to a flange at the zero level of the tank.

** These applications also apply for GP and AP type transmitters equipped with remote seals. However, you can only confirm that input pressure correlates with transmitter output in processes using remote seal connections.

7.3 Running Analog Output Check

Background

You can put the transmitter into a constant-current source mode to checkout other instruments in the loop such as recorders, controllers, and positioners. Using the SFC, you can tell the transmitter to change its output to any value between 0 (4mA) and 100 (20mA) percent and maintain that output. This makes it easy to verify loop operation through the accurate simulation of transmitter output signals before bringing the loop on line. Note that the constant-current source mode is also referred to as the output mode.

ATTENTION

The transmitter does not measure the input or update the output while it is in the constant-current source mode.

Procedure

The procedure in Table 38 outlines the steps for using a transmitter in its output mode and clearing the output mode.

Table 38 Using Transmitter in Constant-Current Source Mode

Step	Press Key	Read Display or Action	Description
1		Connect SFC across loop wiring and turn it on. If possible, locate SFC where you can also view receiver instrument in loop. If you want to verify loop calibration, connect a precision milliammeter or a voltmeter across a 250 ohm resistor in loop to compare readings.	See Figure 38 for sample SFC and meter connections in a typical analog loop with a differential pressure type transmitter.
2	DE READ A ID	T A G N O . T R I P S S E C U R E D ? ?	Be sure any switches that may trip alarms or interlocks associated with analog loop are secured or turned off.
3	NON-VOL ENTER (Yes)	T A G N O . S F C W O R K I N G . . . L I N D P T A G N O . P T 3 0 1 1	Confirm that "TRIPS" are secured and establish communications with sample transmitter PT 3011
4	INPUT J OUT- PUT	L I N D P P T 3 0 1 1 S F C W O R K I N G . . . O U T P 1 P T 3 0 1 1 3 2 . 4 %	Display shows current transmitter output level and it will update every six seconds. Be sure to time your next key press with an updated display.
5	SW VER X 3 Z 0	O U T P 1 P T 3 0 1 1 3 _ % O U T P 1 P T 3 0 1 1 3 0 _ %	Key in 30% for desired output signal level of 8.8 mA (2.2V).

Continued on next page

7.3 Running Analog Output Check, Continued

Procedure, continued

Table 38 Using Transmitter in Constant-Current Source Mode, continued

Step	Press Key	Read Display or Action	Description																																																																																																												
6	NON-VOL ENTER (Yes)	<table border="1"> <tr><td>O</td><td>U</td><td>T</td><td>P</td><td>1</td><td></td><td>P</td><td>T</td><td>3</td><td>0</td><td>1</td><td>1</td><td>#</td></tr> <tr><td>S</td><td>F</td><td>C</td><td></td><td>W</td><td>O</td><td>R</td><td>K</td><td>I</td><td>N</td><td>G</td><td>.</td><td>.</td><td>.</td></tr> </table> <table border="1"> <tr><td>O</td><td>U</td><td>T</td><td>P</td><td>1</td><td></td><td>P</td><td>T</td><td>3</td><td>0</td><td>1</td><td>1</td><td>#</td></tr> <tr><td></td><td></td><td></td><td></td><td>3</td><td>0</td><td>.</td><td>0</td><td>0</td><td>%</td><td></td><td></td><td></td><td></td></tr> </table>	O	U	T	P	1		P	T	3	0	1	1	#	S	F	C		W	O	R	K	I	N	G	.	.	.	O	U	T	P	1		P	T	3	0	1	1	#					3	0	.	0	0	%					Output signal is set at 30% (8.8 mA/2.2 V). A “#” character appears on right side of display to remind you that transmitter is in its output mode.																																																						
O	U	T	P	1		P	T	3	0	1	1	#																																																																																																			
S	F	C		W	O	R	K	I	N	G	.	.	.																																																																																																		
O	U	T	P	1		P	T	3	0	1	1	#																																																																																																			
				3	0	.	0	0	%																																																																																																						
7		Check that receiving device indication is at its 30% point. If applicable, check that milliammeter reading is 8.8 mA or voltmeter reading is 2.2 V across 250 ohm resistor.	If indication is inaccurate, check calibration of receiving device.																																																																																																												
8		Repeat Steps 5 and 6 to check indications at these output percentages. <table border="1"> <thead> <tr> <th>If output is ...</th> <th>Then meter reads...</th> </tr> </thead> <tbody> <tr><td>0%</td><td>4.0mA/1.0V</td></tr> <tr><td>25%</td><td>8.0mA/2V</td></tr> <tr><td>50%</td><td>12.0mA/3V</td></tr> <tr><td>60%</td><td>13.6mA/3.4V</td></tr> <tr><td>80%</td><td>16.8mA/4.2V</td></tr> <tr><td>100%</td><td>20.0mA/5.0V</td></tr> </tbody> </table>	If output is ...	Then meter reads...	0%	4.0mA/1.0V	25%	8.0mA/2V	50%	12.0mA/3V	60%	13.6mA/3.4V	80%	16.8mA/4.2V	100%	20.0mA/5.0V	Use transmitter output as a calibration input source for instruments in loop.																																																																																														
If output is ...	Then meter reads...																																																																																																														
0%	4.0mA/1.0V																																																																																																														
25%	8.0mA/2V																																																																																																														
50%	12.0mA/3V																																																																																																														
60%	13.6mA/3.4V																																																																																																														
80%	16.8mA/4.2V																																																																																																														
100%	20.0mA/5.0V																																																																																																														
9	INPUT OUT- PUT CLR (NO)	<table border="1"> <tr><td>O</td><td>U</td><td>T</td><td>P</td><td>1</td><td></td><td>P</td><td>T</td><td>3</td><td>0</td><td>1</td><td>1</td><td>#</td></tr> <tr><td>S</td><td>F</td><td>C</td><td></td><td>W</td><td>O</td><td>R</td><td>K</td><td>I</td><td>N</td><td>G</td><td>.</td><td>.</td><td>.</td></tr> </table> <table border="1"> <tr><td>O</td><td>U</td><td>T</td><td>P</td><td>1</td><td></td><td>P</td><td>T</td><td>3</td><td>0</td><td>1</td><td>1</td><td>#</td></tr> <tr><td></td><td></td><td></td><td></td><td>1</td><td>0</td><td>.</td><td>0</td><td></td><td>%</td><td></td><td></td><td></td><td></td></tr> </table> <table border="1"> <tr><td>O</td><td>U</td><td>T</td><td>P</td><td>1</td><td></td><td>P</td><td>T</td><td>3</td><td>0</td><td>1</td><td>1</td><td>#</td></tr> <tr><td>S</td><td>F</td><td>C</td><td></td><td>W</td><td>O</td><td>R</td><td>K</td><td>I</td><td>N</td><td>G</td><td>.</td><td>.</td><td>.</td></tr> </table> <table border="1"> <tr><td>L</td><td>I</td><td>N</td><td></td><td>D</td><td>P</td><td>P</td><td>T</td><td>3</td><td>0</td><td>1</td><td>1</td><td></td></tr> <tr><td></td><td>R</td><td>E</td><td>A</td><td>D</td><td>Y</td><td>.</td><td>.</td><td>.</td><td></td><td></td><td></td><td></td><td></td></tr> </table>	O	U	T	P	1		P	T	3	0	1	1	#	S	F	C		W	O	R	K	I	N	G	.	.	.	O	U	T	P	1		P	T	3	0	1	1	#					1	0	.	0		%					O	U	T	P	1		P	T	3	0	1	1	#	S	F	C		W	O	R	K	I	N	G	.	.	.	L	I	N		D	P	P	T	3	0	1	1			R	E	A	D	Y	.	.	.						Exit constant-current source mode. Check that # character disappears from right side of display since transmitter is no longer in output mode.
O	U	T	P	1		P	T	3	0	1	1	#																																																																																																			
S	F	C		W	O	R	K	I	N	G	.	.	.																																																																																																		
O	U	T	P	1		P	T	3	0	1	1	#																																																																																																			
				1	0	.	0		%																																																																																																						
O	U	T	P	1		P	T	3	0	1	1	#																																																																																																			
S	F	C		W	O	R	K	I	N	G	.	.	.																																																																																																		
L	I	N		D	P	P	T	3	0	1	1																																																																																																				
	R	E	A	D	Y	.	.	.																																																																																																							

Continued on next page

7.3 Running Analog Output Check, Continued

Procedure, continued

Figure 38 Typical SFC and Meter Connections for Constant-Current Source Mode.

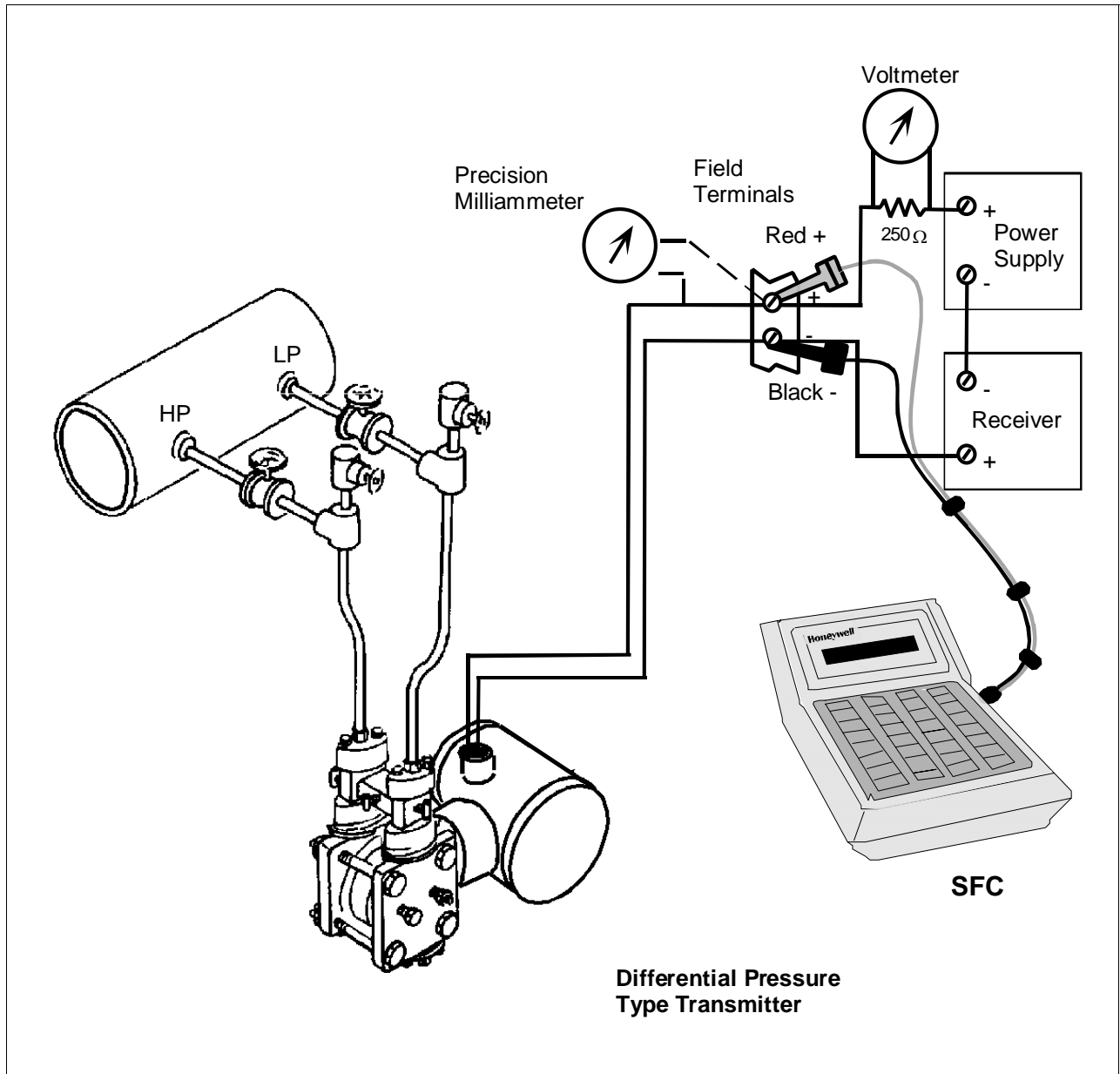

7.4 Flow Measurement with DP Transmitter

Procedure

The procedure in Table 39 outlines the steps for starting up a differential pressure (DP) type transmitter in a flow measurement application. Refer to Figure 39 for the piping arrangement identification and Figure 38 for typical SFC and meter connections.

Figure 39 Typical Piping Arrangement for Flow Measurement with DP Type Transmitter

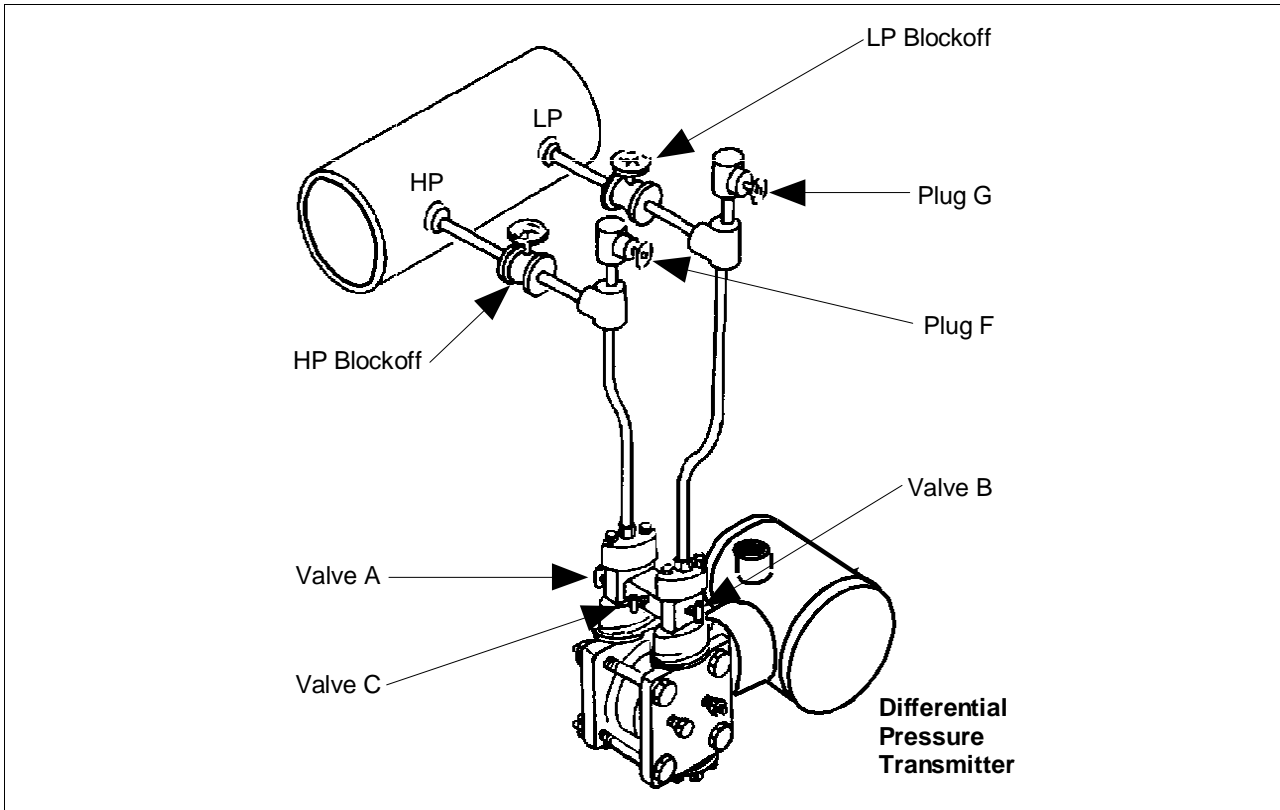

ATTENTION

For the procedure in Table 39, we are assuming that all the valves on the three-valve manifold and the block-off valves were closed at installation.

Table 39 Starting Up DP Transmitter for Flow Measurement With SFC





Step	Press Key	Read Display or Action	Description
1		Connect SFC across loop wiring and turn it on. If possible, locate SFC where you can also view receiver instrument in loop. If you want to verify transmitter output, connect a precision milliammeter or voltmeter in loop to compare readings.	See Figure 38 for sample SFC and meter connections in a typical analog loop with a differential pressure type transmitter.
2		Open equalizer valve C.	See Figure 39 for sample piping arrangement.

Continued on next page

7.4 Flow Measurement with DP Transmitter, Continued

Procedure, continued

Table 39 Starting Up DP Transmitter for Flow Measurement With SFC, continued





Step	Press Key	Read Display or Action	Description																																																																																																																								
3		Open valves A and HP block-off to make differential pressure zero (0) by applying same pressure to both sides of meter body.	Allow system to stabilize at full static pressure - zero differential.																																																																																																																								
4	DE READ 	<table border="1"> <tr><td>T</td><td>A</td><td>G</td><td>N</td><td>O</td><td>.</td><td></td><td></td><td></td><td></td><td></td><td></td><td></td><td></td><td></td><td></td><td></td><td></td><td></td><td></td></tr> <tr><td>T</td><td>R</td><td>I</td><td>P</td><td>S</td><td></td><td>S</td><td>E</td><td>C</td><td>U</td><td>R</td><td>E</td><td>D</td><td>?</td><td>?</td><td></td><td></td><td></td><td></td><td></td></tr> </table>	T	A	G	N	O	.															T	R	I	P	S		S	E	C	U	R	E	D	?	?						Be sure any switches that may trip alarms or interlocks associated with analog loop are secured or turned off.																																																																																
T	A	G	N	O	.																																																																																																																						
T	R	I	P	S		S	E	C	U	R	E	D	?	?																																																																																																													
5	NON-VOL 	<table border="1"> <tr><td>T</td><td>A</td><td>G</td><td>N</td><td>O</td><td>.</td><td></td><td></td><td></td><td></td><td></td><td></td><td></td><td></td><td></td><td></td><td></td><td></td><td></td><td></td></tr> <tr><td>S</td><td>F</td><td>C</td><td>W</td><td>O</td><td>R</td><td>K</td><td>I</td><td>N</td><td>G</td><td>.</td><td>.</td><td>.</td><td></td><td></td><td></td><td></td><td></td><td></td><td></td></tr> </table> <table border="1"> <tr><td>L</td><td>I</td><td>N</td><td></td><td>D</td><td>P</td><td>T</td><td>A</td><td>G</td><td>N</td><td>O</td><td>.</td><td></td><td></td><td></td><td></td><td></td><td></td><td></td><td></td></tr> <tr><td></td><td></td><td></td><td></td><td></td><td></td><td>E</td><td>T</td><td></td><td>3</td><td>Ø</td><td>1</td><td>1</td><td></td><td></td><td></td><td></td><td></td><td></td><td></td></tr> </table>	T	A	G	N	O	.															S	F	C	W	O	R	K	I	N	G	.	.	.								L	I	N		D	P	T	A	G	N	O	.															E	T		3	Ø	1	1								Confirm that "TRIPS" are secured and establish communications with sample transmitter PT 3011																																								
T	A	G	N	O	.																																																																																																																						
S	F	C	W	O	R	K	I	N	G	.	.	.																																																																																																															
L	I	N		D	P	T	A	G	N	O	.																																																																																																																
						E	T		3	Ø	1	1																																																																																																															
6	 INPUT 	<table border="1"> <tr><td>L</td><td>I</td><td>N</td><td></td><td>D</td><td>P</td><td>T</td><td>A</td><td>G</td><td>N</td><td>O</td><td>.</td><td></td><td></td><td></td><td></td><td></td><td></td><td></td><td></td></tr> <tr><td></td><td></td><td></td><td></td><td></td><td></td><td>S</td><td>H</td><td>I</td><td>F</td><td>T</td><td>-</td><td></td><td></td><td></td><td></td><td></td><td></td><td></td><td></td></tr> </table> <table border="1"> <tr><td>I</td><td>N</td><td>P</td><td>U</td><td>T</td><td>1</td><td>P</td><td>T</td><td>3</td><td>Ø</td><td>1</td><td>1</td><td></td><td></td><td></td><td></td><td></td><td></td><td></td><td></td></tr> <tr><td>S</td><td>F</td><td>C</td><td>W</td><td>O</td><td>R</td><td>K</td><td>I</td><td>N</td><td>G</td><td>.</td><td>.</td><td>.</td><td></td><td></td><td></td><td></td><td></td><td></td><td></td></tr> </table> <table border="1"> <tr><td>I</td><td>N</td><td>P</td><td>U</td><td>T</td><td>1</td><td>P</td><td>T</td><td>3</td><td>Ø</td><td>1</td><td>1</td><td></td><td></td><td></td><td></td><td></td><td></td><td></td><td></td></tr> <tr><td>.</td><td>9</td><td>Ø</td><td>3</td><td>5</td><td>1</td><td>"</td><td>H</td><td>2</td><td>O</td><td>_</td><td>3</td><td>9</td><td>F</td><td></td><td></td><td></td><td></td><td></td><td></td></tr> </table>	L	I	N		D	P	T	A	G	N	O	.															S	H	I	F	T	-									I	N	P	U	T	1	P	T	3	Ø	1	1									S	F	C	W	O	R	K	I	N	G	.	.	.								I	N	P	U	T	1	P	T	3	Ø	1	1									.	9	Ø	3	5	1	"	H	2	O	_	3	9	F							Initiate shift key selection. Read applied input pressure. Reading is updated every six seconds.
L	I	N		D	P	T	A	G	N	O	.																																																																																																																
						S	H	I	F	T	-																																																																																																																
I	N	P	U	T	1	P	T	3	Ø	1	1																																																																																																																
S	F	C	W	O	R	K	I	N	G	.	.	.																																																																																																															
I	N	P	U	T	1	P	T	3	Ø	1	1																																																																																																																
.	9	Ø	3	5	1	"	H	2	O	_	3	9	F																																																																																																														
7	INPUT 	<table border="1"> <tr><td>O</td><td>U</td><td>T</td><td>P</td><td>1</td><td>P</td><td>T</td><td>3</td><td>Ø</td><td>1</td><td>1</td><td></td><td></td><td></td><td></td><td></td><td></td><td></td><td></td><td></td></tr> <tr><td>S</td><td>F</td><td>C</td><td>W</td><td>O</td><td>R</td><td>K</td><td>I</td><td>N</td><td>G</td><td>.</td><td>.</td><td>.</td><td></td><td></td><td></td><td></td><td></td><td></td><td></td></tr> </table> <table border="1"> <tr><td>O</td><td>U</td><td>T</td><td>P</td><td>1</td><td>P</td><td>T</td><td>3</td><td>Ø</td><td>1</td><td>1</td><td></td><td></td><td></td><td></td><td></td><td></td><td></td><td></td><td></td></tr> <tr><td></td><td></td><td></td><td>Ø</td><td>.</td><td>Ø</td><td></td><td>%</td><td></td><td></td><td></td><td></td><td></td><td></td><td></td><td></td><td></td><td></td><td></td><td></td></tr> </table>	O	U	T	P	1	P	T	3	Ø	1	1										S	F	C	W	O	R	K	I	N	G	.	.	.								O	U	T	P	1	P	T	3	Ø	1	1													Ø	.	Ø		%													Call up output for display. Read 0% output on display for corresponding zero input pressure. For analog transmission, check that milliammeter reading is 4 mA (0%) output.																																								
O	U	T	P	1	P	T	3	Ø	1	1																																																																																																																	
S	F	C	W	O	R	K	I	N	G	.	.	.																																																																																																															
O	U	T	P	1	P	T	3	Ø	1	1																																																																																																																	
			Ø	.	Ø		%																																																																																																																				
8		<table border="1"> <tr> <td>If SFC and milliammeter readings...</td> <td>Then...</td> </tr> <tr> <td>are exactly zero (4mA)</td> <td>go to Step 11.</td> </tr> <tr> <td>are not exactly zero (4mA)</td> <td>go to Step 9.</td> </tr> </table>	If SFC and milliammeter readings...	Then...	are exactly zero (4mA)	go to Step 11.	are not exactly zero (4mA)	go to Step 9.																																																																																																																			
If SFC and milliammeter readings...	Then...																																																																																																																										
are exactly zero (4mA)	go to Step 11.																																																																																																																										
are not exactly zero (4mA)	go to Step 9.																																																																																																																										

Continued on next page

7.4 Flow Measurement with DP Transmitter, Continued

Procedure, continued

Table 39 Starting Up DP Transmitter for Flow Measurement With SFC, continued

Step	Press Key	Read Display or Action	Description																								
9		<table border="1"> <tr><td>O</td><td>U</td><td>T</td><td>P</td><td>1</td><td></td><td>P</td><td>T</td><td>3</td><td>∅</td><td>1</td><td>1</td></tr> <tr><td></td><td></td><td></td><td></td><td>S</td><td>H</td><td>I</td><td>F</td><td>T</td><td>-</td><td></td><td></td></tr> </table>	O	U	T	P	1		P	T	3	∅	1	1					S	H	I	F	T	-			Initiate shift key selection.
		O	U	T	P	1		P	T	3	∅	1	1														
					S	H	I	F	T	-																	
		<table border="1"> <tr><td>I</td><td>N</td><td>P</td><td>U</td><td>T</td><td>1</td><td>P</td><td>T</td><td>3</td><td>∅</td><td>1</td><td>1</td></tr> <tr><td>S</td><td>F</td><td>C</td><td>W</td><td>O</td><td>R</td><td>K</td><td>I</td><td>N</td><td>G</td><td>.</td><td>.</td></tr> </table>	I	N	P	U	T	1	P	T	3	∅	1	1	S	F	C	W	O	R	K	I	N	G	.	.	Read applied input pressure.
		I	N	P	U	T	1	P	T	3	∅	1	1														
	S	F	C	W	O	R	K	I	N	G	.	.															
	<table border="1"> <tr><td>I</td><td>N</td><td>P</td><td>U</td><td>T</td><td>1</td><td>P</td><td>T</td><td>3</td><td>∅</td><td>1</td><td>1</td></tr> <tr><td>.</td><td>9</td><td>∅</td><td>3</td><td>5</td><td>1</td><td>"</td><td>H</td><td>2</td><td>O</td><td>-</td><td>3</td></tr> </table>	I	N	P	U	T	1	P	T	3	∅	1	1	.	9	∅	3	5	1	"	H	2	O	-	3	Prompt asks if the applied input pressure equals zero input. If it is zero input, go to next keystroke. If it is not, press [CLR] key to exit function and try again.	
	I	N	P	U	T	1	P	T	3	∅	1	1															
.	9	∅	3	5	1	"	H	2	O	-	3																
	<table border="1"> <tr><td>I</td><td>N</td><td>P</td><td>U</td><td>T</td><td>1</td><td>P</td><td>T</td><td>3</td><td>∅</td><td>1</td><td>1</td></tr> <tr><td></td><td></td><td></td><td></td><td>Z</td><td>E</td><td>R</td><td>O</td><td>I</td><td>N</td><td>P</td><td>U</td></tr> </table>	I	N	P	U	T	1	P	T	3	∅	1	1					Z	E	R	O	I	N	P	U	Prompt asks if the applied input pressure equals zero input. If it is zero input, go to next keystroke. If it is not, press [CLR] key to exit function and try again.	
	I	N	P	U	T	1	P	T	3	∅	1	1															
					Z	E	R	O	I	N	P	U															
<table border="1"> <tr><td>I</td><td>N</td><td>P</td><td>U</td><td>T</td><td>1</td><td>P</td><td>T</td><td>3</td><td>∅</td><td>1</td><td>1</td></tr> <tr><td>S</td><td>F</td><td>C</td><td>W</td><td>O</td><td>R</td><td>K</td><td>I</td><td>N</td><td>G</td><td>.</td><td>.</td></tr> </table>	I	N	P	U	T	1	P	T	3	∅	1	1	S	F	C	W	O	R	K	I	N	G	.	.	Zero input is set equal to applied input pressure.		
I	N	P	U	T	1	P	T	3	∅	1	1																
S	F	C	W	O	R	K	I	N	G	.	.																
<table border="1"> <tr><td>I</td><td>N</td><td>P</td><td>U</td><td>T</td><td>1</td><td>P</td><td>T</td><td>3</td><td>∅</td><td>1</td><td>1</td></tr> <tr><td></td><td></td><td></td><td></td><td>I</td><td>N</td><td>P</td><td>U</td><td>T</td><td>Z</td><td>E</td><td>R</td></tr> </table>	I	N	P	U	T	1	P	T	3	∅	1	1					I	N	P	U	T	Z	E	R	Zero input is set equal to applied input pressure.		
I	N	P	U	T	1	P	T	3	∅	1	1																
				I	N	P	U	T	Z	E	R																
<table border="1"> <tr><td>I</td><td>N</td><td>P</td><td>U</td><td>T</td><td>1</td><td>P</td><td>T</td><td>3</td><td>∅</td><td>1</td><td>1</td></tr> <tr><td>.</td><td>∅</td><td>∅</td><td>∅</td><td>4</td><td>2</td><td>"</td><td>H</td><td>2</td><td>O</td><td>-</td><td>3</td></tr> </table>	I	N	P	U	T	1	P	T	3	∅	1	1	.	∅	∅	∅	4	2	"	H	2	O	-	3	Zero input is set equal to applied input pressure.		
I	N	P	U	T	1	P	T	3	∅	1	1																
.	∅	∅	∅	4	2	"	H	2	O	-	3																
10		Repeat Steps 6 to 8.																									
11		Close equalizer valve C.																									
12		Open valve B and LP block-off valve to begin measuring process differential pressure.																									
13		Take SFC and milliammeter readings to check that output signal does correspond to applied input pressure. If readings don't correspond, check that transmitter has been installed correctly. If applicable, blow down piping to be sure no foreign matter is entrapped in it. Check SFC and milliammeter readings again. If readings are still not correct, verify transmitter's configuration data and change its range setting if needed.																									
14		Remove SFC and milliammeter from loop.																									

7.5 Pressure Measurement with DP Transmitter

Procedure

The procedure in Table 40 outlines the steps for starting up a differential pressure (DP) type transmitter in a pressure measurement application. Refer to Figure 40 for the piping arrangement identification and Figure 38 for typical SFC and meter connections.

Figure 40 Typical Piping Arrangement for Pressure Measurement with DP Type Transmitter.

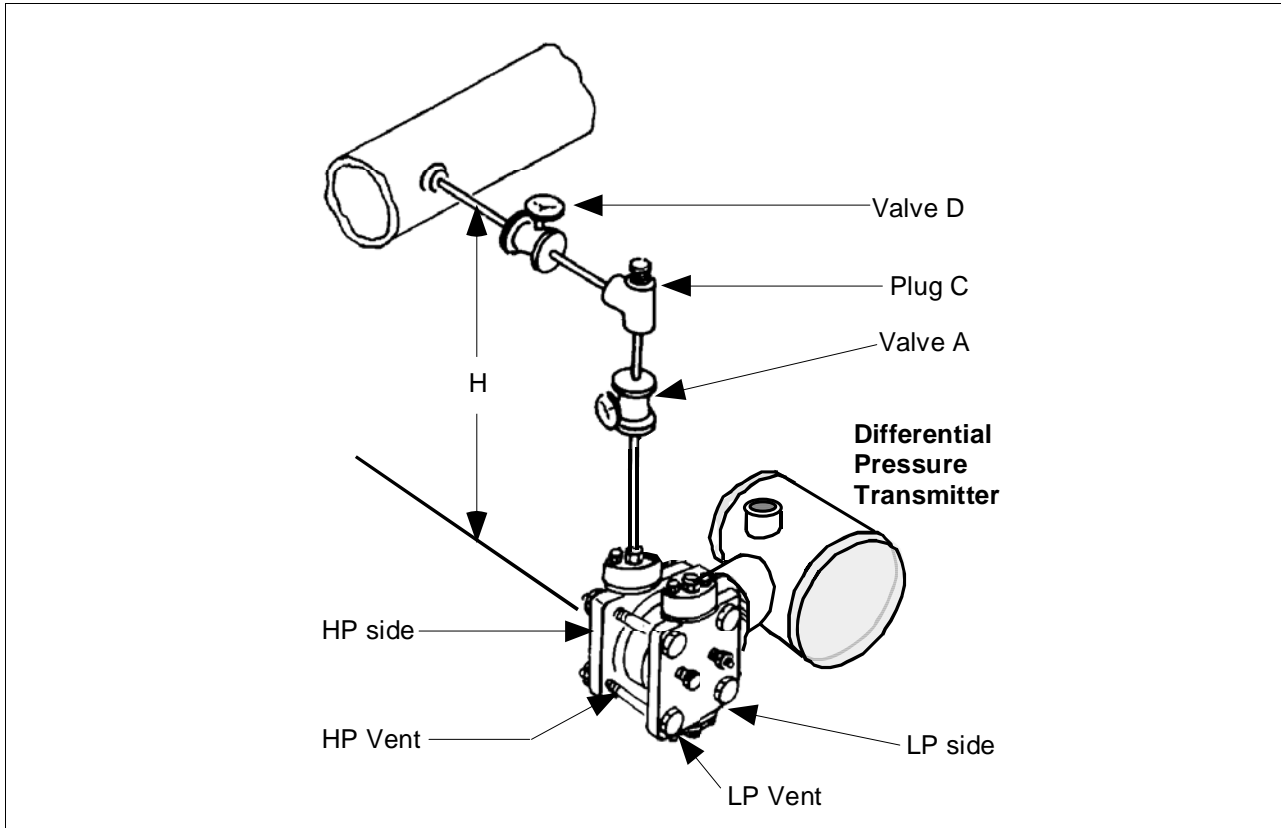

Table 40 Starting Up DP Transmitter for Pressure Measurement With SFC

Step	Press Key	Read Display or Action	Description
1		Connect SFC across loop wiring and turn it on. If possible, locate SFC where you can also view receiver instrument in loop. If you want to verify transmitter output, connect a precision milliammeter or voltmeter in loop to compare readings.	See Figure 38 for sample SFC and meter connections in a typical analog loop with a differential pressure type transmitter.
2		Close valve D.	See Figure 40 for sample piping arrangement.
3		Open plug C and valve A to apply head pressure H to meter body. Then, open LP vent.	Allow system to stabilize at head pressure.

Continued on next page

7.5 Pressure Measurement with DP Transmitter, Continued

Procedure, continued

Table 40 Starting Up DP Transmitter for Pressure Measurement With SFC, continued

Step	Press Key	Read Display or Action	Description
4	DE READ A ID	T A G N O . T R I P S S E C U R E D ? ?	Be sure any switches that may trip alarms or interlocks associated with analog loop are secured or turned off.
5	NON-VOL ENTER (Yes)	T A G N O . S F C W O R K I N G . . . L I N D P T A G N O . P T 3 0 1 1	Confirm that "TRIPS" are secured and establish communications with sample transmitter PT 3011
6	E LRV 0% G SET NON-VOL ENTER (Yes)	L R V 1 P T 3 0 1 1 0 . 0 0 0 P S I L R V 1 P T 3 0 1 1 S E T L R V ? L R V 1 P T 3 0 1 1 1 . 8 3 1 5 P S I	Read present LRV setting. Prompt asks if you want to set LRV to applied pressure. LRV is set to applied head pressure.
7	INPUT J OUT- PUT	O U T P 1 P T 3 0 1 1 S F C W O R K I N G . . . O U T P 1 P T 3 0 1 1 0 . 0 0 0 %	Call up output for display. Read 0% output on display for corresponding zero line pressure plus head pressure H. For analog transmission, check that milliammeter reading is 4 mA (0%) output.
8		Close plug C	
9		Open valve D to begin measuring process line pressure.	
10		Take SFC and milliammeter readings to check that output signal does correspond to applied line pressure. If readings don't correspond, check that transmitter has been installed correctly. If applicable, blow down piping to be sure no foreign matter is entrapped in it. Check SFC and milliammeter readings again. If readings are still not correct, verify transmitter's configuration data and change its range setting if needed.	
11		Remove SFC and milliammeter from loop.	

7.6 Liquid Level Measurement - Vented Tank

Procedure

The procedure in Table 41 outlines the steps for starting up a differential pressure (DP) type transmitter in a liquid level measurement application for a vented tank with a dry reference leg. Refer to Figure 41 for the piping arrangement identification and Figure 38 for typical SFC and meter connections.

Figure 41 Typical Piping Arrangement for Liquid Level Measurement with DP Type Transmitter and Vented Tank

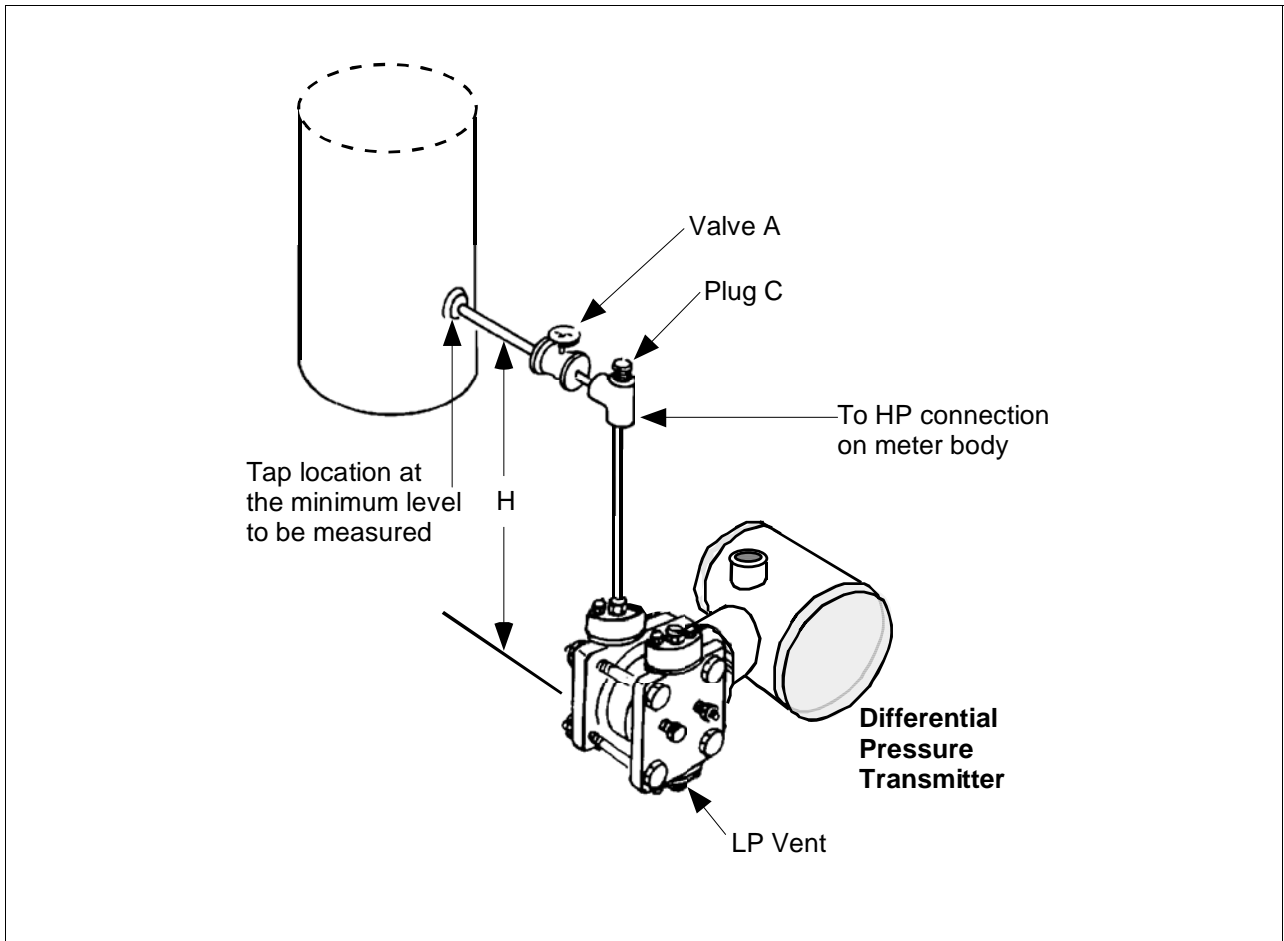

ATTENTION

For the procedure in Table 41, we are assuming that the tank is empty and the piping arrangement includes a block-off valve.

Continued on next page

7.6 Liquid Level Measurement - Vented Tank, Continued

Procedure, continued

Table 41 Starting Up DP Transmitter for Liquid Level Measurement in Vented Tank

Step	Press Key	Read Display or Action	Description																																																																																																																		
1		Connect SFC across loop wiring and turn it on. If possible, locate SFC where you can also view receiver instrument in loop. If you want to verify transmitter output, connect a precision milliammeter or voltmeter in loop to compare readings.	See Figure 38 for sample SFC and meter connections in a typical analog loop with a differential pressure type transmitter.																																																																																																																		
2		Close block-off valve A.	See Figure 41 for sample piping arrangement.																																																																																																																		
3		Open plug C.	Allow system to stabilize at head pressure.																																																																																																																		
4	DE READ A ID	<table border="1" style="font-family: monospace; border-collapse: collapse; text-align: center;"> <tr><td>T</td><td>A</td><td>G</td><td>N</td><td>O</td><td>.</td><td></td><td></td><td></td><td></td><td></td><td></td><td></td><td></td><td></td><td></td><td></td><td></td><td></td></tr> <tr><td>T</td><td>R</td><td>I</td><td>P</td><td>S</td><td>S</td><td>E</td><td>C</td><td>U</td><td>R</td><td>E</td><td>D</td><td>?</td><td>?</td><td></td><td></td><td></td><td></td><td></td></tr> </table>	T	A	G	N	O	.														T	R	I	P	S	S	E	C	U	R	E	D	?	?						Be sure any switches that may trip alarms or interlocks associated with analog loop are secured or turned off.																																																																												
T	A	G	N	O	.																																																																																																																
T	R	I	P	S	S	E	C	U	R	E	D	?	?																																																																																																								
5	NON-VOL ENTER (Yes)	<table border="1" style="font-family: monospace; border-collapse: collapse; text-align: center;"> <tr><td>T</td><td>A</td><td>G</td><td>N</td><td>O</td><td>.</td><td></td><td></td><td></td><td></td><td></td><td></td><td></td><td></td><td></td><td></td><td></td><td></td><td></td></tr> <tr><td>S</td><td>F</td><td>C</td><td>W</td><td>O</td><td>R</td><td>K</td><td>I</td><td>N</td><td>G</td><td>.</td><td>.</td><td>.</td><td></td><td></td><td></td><td></td><td></td><td></td></tr> </table> <table border="1" style="font-family: monospace; border-collapse: collapse; text-align: center;"> <tr><td>L</td><td>I</td><td>N</td><td>D</td><td>P</td><td>T</td><td>A</td><td>G</td><td>N</td><td>O</td><td>.</td><td></td><td></td><td></td><td></td><td></td><td></td><td></td><td></td></tr> <tr><td></td><td></td><td></td><td></td><td></td><td></td><td></td><td></td><td></td><td></td><td></td><td></td><td></td><td></td><td></td><td></td><td></td><td></td><td></td></tr> </table>	T	A	G	N	O	.														S	F	C	W	O	R	K	I	N	G	.	.	.							L	I	N	D	P	T	A	G	N	O	.																												Confirm that "TRIPS" are secured and establish communications with sample transmitter PT 3011																																						
T	A	G	N	O	.																																																																																																																
S	F	C	W	O	R	K	I	N	G	.	.	.																																																																																																									
L	I	N	D	P	T	A	G	N	O	.																																																																																																											
6	E LRV 0% G SET NON-VOL ENTER (Yes)	<table border="1" style="font-family: monospace; border-collapse: collapse; text-align: center;"> <tr><td>L</td><td>R</td><td>V</td><td>1</td><td></td><td></td><td>P</td><td>T</td><td>3</td><td>0</td><td>1</td><td>1</td><td></td><td></td><td></td><td></td><td></td><td></td><td></td></tr> <tr><td>0</td><td>.</td><td>0</td><td>0</td><td>0</td><td></td><td>"</td><td>H</td><td>2</td><td>O</td><td>-</td><td>3</td><td>9</td><td>F</td><td></td><td></td><td></td><td></td><td></td></tr> </table> <table border="1" style="font-family: monospace; border-collapse: collapse; text-align: center;"> <tr><td>L</td><td>R</td><td>V</td><td>1</td><td></td><td></td><td>P</td><td>T</td><td>3</td><td>0</td><td>1</td><td>1</td><td></td><td></td><td></td><td></td><td></td><td></td><td></td></tr> <tr><td></td><td></td><td></td><td></td><td></td><td></td><td>S</td><td>E</td><td>T</td><td>L</td><td>R</td><td>V</td><td>?</td><td></td><td></td><td></td><td></td><td></td><td></td></tr> </table> <table border="1" style="font-family: monospace; border-collapse: collapse; text-align: center;"> <tr><td>L</td><td>R</td><td>V</td><td>1</td><td></td><td></td><td>P</td><td>T</td><td>3</td><td>0</td><td>1</td><td>1</td><td></td><td></td><td></td><td></td><td></td><td></td><td></td></tr> <tr><td>1</td><td>0</td><td>.</td><td>6</td><td>2</td><td>4</td><td>"</td><td>H</td><td>2</td><td>O</td><td>-</td><td>3</td><td>9</td><td>F</td><td></td><td></td><td></td><td></td><td></td></tr> </table>	L	R	V	1			P	T	3	0	1	1								0	.	0	0	0		"	H	2	O	-	3	9	F						L	R	V	1			P	T	3	0	1	1														S	E	T	L	R	V	?							L	R	V	1			P	T	3	0	1	1								1	0	.	6	2	4	"	H	2	O	-	3	9	F						Read present LRV setting. Prompt asks if you want to set LRV to applied pressure. LRV is set to applied head pressure.
L	R	V	1			P	T	3	0	1	1																																																																																																										
0	.	0	0	0		"	H	2	O	-	3	9	F																																																																																																								
L	R	V	1			P	T	3	0	1	1																																																																																																										
						S	E	T	L	R	V	?																																																																																																									
L	R	V	1			P	T	3	0	1	1																																																																																																										
1	0	.	6	2	4	"	H	2	O	-	3	9	F																																																																																																								
7	INPUT J OUT- PUT	<table border="1" style="font-family: monospace; border-collapse: collapse; text-align: center;"> <tr><td>O</td><td>U</td><td>T</td><td>P</td><td>1</td><td></td><td>P</td><td>T</td><td>3</td><td>0</td><td>1</td><td>1</td><td></td><td></td><td></td><td></td><td></td><td></td><td></td></tr> <tr><td>S</td><td>F</td><td>C</td><td>W</td><td>O</td><td>R</td><td>K</td><td>I</td><td>N</td><td>G</td><td>.</td><td>.</td><td>.</td><td></td><td></td><td></td><td></td><td></td><td></td></tr> </table> <table border="1" style="font-family: monospace; border-collapse: collapse; text-align: center;"> <tr><td>O</td><td>U</td><td>T</td><td>P</td><td>1</td><td></td><td>P</td><td>T</td><td>3</td><td>0</td><td>1</td><td>1</td><td></td><td></td><td></td><td></td><td></td><td></td><td></td></tr> <tr><td></td><td></td><td></td><td></td><td></td><td></td><td>0</td><td>.</td><td>0</td><td>0</td><td>0</td><td>%</td><td></td><td></td><td></td><td></td><td></td><td></td><td></td></tr> </table>	O	U	T	P	1		P	T	3	0	1	1								S	F	C	W	O	R	K	I	N	G	.	.	.							O	U	T	P	1		P	T	3	0	1	1														0	.	0	0	0	%								Call up output for display. Read 0% output on display for corresponding empty tank pressure plus head pressure H. For analog transmission, check that milliammeter reading is 4 mA (0%) output.																																						
O	U	T	P	1		P	T	3	0	1	1																																																																																																										
S	F	C	W	O	R	K	I	N	G	.	.	.																																																																																																									
O	U	T	P	1		P	T	3	0	1	1																																																																																																										
						0	.	0	0	0	%																																																																																																										
8		Close plug C																																																																																																																			

Continued on next page

7.6 Liquid Level Measurement - Vented Tank, Continued

Procedure, continued

Table 38 Starting Up DP Transmitter for Liquid Level Measurement in Vented Tank, Continued

Step	Press Key	Read Display or Action	Description
9		Open valve A to begin measuring tank pressure. Leave LP side vented to atmosphere.	ATTENTION If the URV was calculated on the approximate density of the liquid and/or tank height, the exact URV can be set by filling the tank to the desired full scale level and then setting the URV through the SFC. See section 6.7 in this manual for details.
10		Take SFC and milliammeter readings to check that output signal does correspond to applied tank level pressure. If readings don't correspond, check that transmitter has been installed correctly. If applicable, blow down piping to be sure no foreign matter is entrapped in it. Check SFC and milliammeter readings again. If readings are still not correct, verify transmitter's configuration data and change its range setting if needed.	
11		Remove SFC and milliammeter from loop.	

7.7 Liquid Level Measurement - Pressurized Tank

Procedure

The procedure in Table 42 outlines the steps for starting up a differential pressure (DP) type transmitter in a liquid level measurement application for a pressurized tank with a liquid-filled (wet) reference leg. Refer to Figure 42 for the piping arrangement identification and Figure 38 for typical SFC and meter connections.

Figure 42 Typical Piping Arrangement for Liquid Level Measurement with DP Type Transmitter and Pressurized Tank

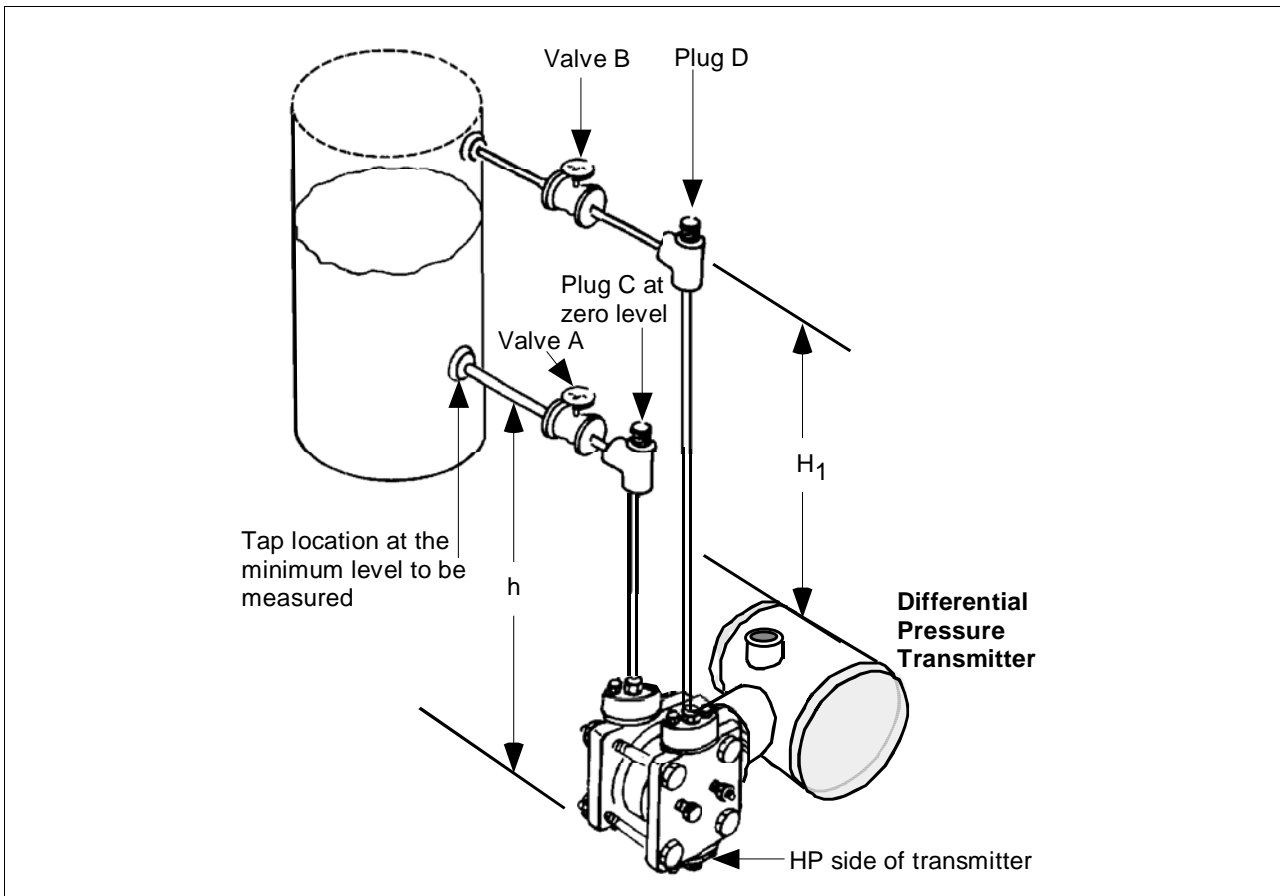

ATTENTION

For the procedure in Table 42, we are assuming that:

- The tank is empty and the reference leg is filled.
- The high pressure (HP) side of the transmitter is connected to the wet reference leg. Note that the transmitter will work if the HP side is connected to the bottom of the tank, but not within the guaranteed accuracy specifications.
- The transmitter is mounted below the zero level of the tank, so “h” is greater than zero. If h equals zero, plug C is eliminated from the piping and the LP vent is opened instead.

Continued on next page

7.7 Liquid Level Measurement - Pressurized Tank, Continued

Procedure, continued

Table 42 Starting Up DP Transmitter for Liquid Level Measurement in Pressurized Tank

Step	Press Key	Read Display or Action	Description																																																																																																
1		Connect SFC across loop wiring and turn it on. If possible, locate SFC where you can also view receiver instrument in loop. If you want to verify transmitter output, connect a precision milliammeter or voltmeter in loop to compare readings.	See Figure 38 for sample SFC and meter connections in a typical analog loop with a differential pressure type transmitter.																																																																																																
2		Close block-off valves A and B.	See Figure 42 for sample piping arrangement.																																																																																																
3		Open plugs C and D.	Allow system to stabilize at head pressure.																																																																																																
4	DE READ ^A <input type="button" value="ID"/>	<table border="1"> <tr><td>T</td><td>A</td><td>G</td><td>N</td><td>O</td><td>.</td><td></td><td></td><td></td><td></td><td></td><td></td><td></td><td></td><td></td><td></td></tr> <tr><td>T</td><td>R</td><td>I</td><td>P</td><td>S</td><td>S</td><td>E</td><td>C</td><td>U</td><td>R</td><td>E</td><td>D</td><td>?</td><td>?</td><td></td><td></td></tr> </table>	T	A	G	N	O	.											T	R	I	P	S	S	E	C	U	R	E	D	?	?			Be sure any switches that may trip alarms or interlocks associated with analog loop are secured or turned off.																																																																
T	A	G	N	O	.																																																																																														
T	R	I	P	S	S	E	C	U	R	E	D	?	?																																																																																						
5	NON-VOL <input type="button" value="ENTER (Yes)"/>	<table border="1"> <tr><td>T</td><td>A</td><td>G</td><td>N</td><td>O</td><td>.</td><td></td><td></td><td></td><td></td><td></td><td></td><td></td><td></td><td></td><td></td></tr> <tr><td>S</td><td>F</td><td>C</td><td>W</td><td>O</td><td>R</td><td>K</td><td>I</td><td>N</td><td>G</td><td>.</td><td>.</td><td>.</td><td></td><td></td><td></td></tr> <tr><td>L</td><td>I</td><td>N</td><td></td><td>D</td><td>P</td><td>T</td><td>A</td><td>G</td><td>N</td><td>O</td><td>.</td><td></td><td></td><td></td><td></td></tr> <tr><td></td><td></td><td></td><td></td><td></td><td></td><td>E</td><td>T</td><td>3</td><td>0</td><td>1</td><td>1</td><td></td><td></td><td></td><td></td></tr> </table>	T	A	G	N	O	.											S	F	C	W	O	R	K	I	N	G	.	.	.				L	I	N		D	P	T	A	G	N	O	.											E	T	3	0	1	1					Confirm that "TRIPS" are secured and establish communications with sample transmitter PT 3011																																
T	A	G	N	O	.																																																																																														
S	F	C	W	O	R	K	I	N	G	.	.	.																																																																																							
L	I	N		D	P	T	A	G	N	O	.																																																																																								
						E	T	3	0	1	1																																																																																								
6	<input type="button" value="LRV 0%"/> ^E <input type="button" value="SET"/> ^G NON-VOL <input type="button" value="ENTER (Yes)"/>	<table border="1"> <tr><td>L</td><td>R</td><td>V</td><td>1</td><td></td><td></td><td>P</td><td>T</td><td>3</td><td>0</td><td>1</td><td>1</td><td></td><td></td><td></td><td></td></tr> <tr><td>0</td><td>.</td><td>0</td><td>0</td><td>0</td><td>0</td><td>"</td><td>H</td><td>2</td><td>O</td><td>-</td><td>3</td><td>9</td><td>F</td><td></td><td></td></tr> </table> <table border="1"> <tr><td>L</td><td>R</td><td>V</td><td>1</td><td></td><td></td><td>P</td><td>T</td><td>3</td><td>0</td><td>1</td><td>1</td><td></td><td></td><td></td><td></td></tr> <tr><td></td><td></td><td></td><td></td><td>S</td><td>E</td><td>T</td><td>L</td><td>R</td><td>V</td><td>?</td><td></td><td></td><td></td><td></td><td></td></tr> </table> <table border="1"> <tr><td>L</td><td>R</td><td>V</td><td>1</td><td></td><td></td><td>P</td><td>T</td><td>3</td><td>0</td><td>1</td><td>1</td><td></td><td></td><td></td><td></td></tr> <tr><td>1</td><td>0</td><td>5</td><td>.</td><td>3</td><td>2</td><td>"</td><td>H</td><td>2</td><td>O</td><td>-</td><td>3</td><td>9</td><td>F</td><td></td><td></td></tr> </table>	L	R	V	1			P	T	3	0	1	1					0	.	0	0	0	0	"	H	2	O	-	3	9	F			L	R	V	1			P	T	3	0	1	1									S	E	T	L	R	V	?						L	R	V	1			P	T	3	0	1	1					1	0	5	.	3	2	"	H	2	O	-	3	9	F			<p>Read present LRV setting.</p> <p>Prompt asks if you want to set LRV to applied pressure.</p> <p>LRV is set to applied head pressure H_1 times density of liquid in reference leg.</p>
L	R	V	1			P	T	3	0	1	1																																																																																								
0	.	0	0	0	0	"	H	2	O	-	3	9	F																																																																																						
L	R	V	1			P	T	3	0	1	1																																																																																								
				S	E	T	L	R	V	?																																																																																									
L	R	V	1			P	T	3	0	1	1																																																																																								
1	0	5	.	3	2	"	H	2	O	-	3	9	F																																																																																						
7	<input type="button" value="INPUT OUTPUT"/> ^J	<table border="1"> <tr><td>O</td><td>U</td><td>T</td><td>P</td><td>1</td><td></td><td>P</td><td>T</td><td>3</td><td>0</td><td>1</td><td>1</td><td></td><td></td><td></td><td></td></tr> <tr><td>S</td><td>F</td><td>C</td><td>W</td><td>O</td><td>R</td><td>K</td><td>I</td><td>N</td><td>G</td><td>.</td><td>.</td><td>.</td><td></td><td></td><td></td></tr> </table> <table border="1"> <tr><td>O</td><td>U</td><td>T</td><td>P</td><td>1</td><td></td><td>P</td><td>T</td><td>3</td><td>0</td><td>1</td><td>1</td><td></td><td></td><td></td><td></td></tr> <tr><td></td><td></td><td>0</td><td>.</td><td>0</td><td>0</td><td>0</td><td>%</td><td></td><td></td><td></td><td></td><td></td><td></td><td></td><td></td></tr> </table>	O	U	T	P	1		P	T	3	0	1	1					S	F	C	W	O	R	K	I	N	G	.	.	.				O	U	T	P	1		P	T	3	0	1	1							0	.	0	0	0	%									<p>Call up output for display.</p> <p>Read 0% output on display for corresponding empty tank pressure plus head pressure H_1. For analog transmission, check that milliammeter reading is 4 mA (0%) output.</p>																																
O	U	T	P	1		P	T	3	0	1	1																																																																																								
S	F	C	W	O	R	K	I	N	G	.	.	.																																																																																							
O	U	T	P	1		P	T	3	0	1	1																																																																																								
		0	.	0	0	0	%																																																																																												

Continued on next page

7.7 Liquid Level Measurement - Pressurized Tank, Continued

Procedure, continued

Table 42 Starting Up DP Transmitter for Liquid Level Measurement in Pressurized Tank, continued

Step	Press Key	Read Display or Action	Description						
8		<table border="1"> <thead> <tr> <th>If you ...</th> <th>Then...</th> </tr> </thead> <tbody> <tr> <td>can not fill tank</td> <td>go to Step 9.</td> </tr> <tr> <td>can fill tank to desired full-scale level</td> <td>go to Step 10.</td> </tr> </tbody> </table>	If you ...	Then...	can not fill tank	go to Step 9.	can fill tank to desired full-scale level	go to Step 10.	
		If you ...	Then...						
can not fill tank	go to Step 9.								
can fill tank to desired full-scale level	go to Step 10.								
9	Key in URV that is equal to full tank pressure. See section 6.7 in this manual for details on keying in a range value.	Go to Step 14.							
10		Close plugs C and D.							
11		Open valves A and B. Fill tank to desired full scale level.							
12	<div style="border: 1px solid black; padding: 2px; display: inline-block; text-align: center;"> F URV 100% </div> <div style="border: 1px solid black; padding: 2px; display: inline-block; text-align: center;"> G SET </div> NON-VOL <div style="border: 1px solid black; padding: 2px; display: inline-block; text-align: center;"> ENTER (Yes) </div>	<div style="border: 1px solid black; padding: 2px; display: inline-block; text-align: center;"> U R V 1 P T 3 0 1 1 5 0 . 0 0 0 " H 2 O _ 3 9 F </div> <div style="border: 1px solid black; padding: 2px; display: inline-block; text-align: center;"> U R V 1 P T 3 0 1 1 S E T U R V ? </div> <div style="border: 1px solid black; padding: 2px; display: inline-block; text-align: center;"> U R V 1 P T 3 0 1 1 5 . 3 2 0 0 " H 2 O _ 3 9 F </div>	<p>Read present URV setting.</p> <p>Prompt asks if you want to set URV to applied pressure.</p> <p>URV is set to full tank pressure.</p>						
13	INPUT <div style="border: 1px solid black; padding: 2px; display: inline-block; text-align: center;"> J OUT- PUT </div>	<div style="border: 1px solid black; padding: 2px; display: inline-block; text-align: center;"> O U T P 1 P T 3 0 1 1 S F C W O R K I N G . . </div> <div style="border: 1px solid black; padding: 2px; display: inline-block; text-align: center;"> O U T P 1 P T 3 0 1 1 1 0 0 . 0 0 % </div>	<p>Call up output for display, with full tank pressure applied.</p> <p>Read 100% output on display for corresponding full tank pressure. For analog transmission, check that milliammeter reading is 20 mA (100%) output.</p>						

Continued on next page

7.7 Liquid Level Measurement - Pressurized Tank, Continued

Procedure, continued

Table 42 Starting Up DP Transmitter for Liquid Level Measurement in Pressurized Tank, continued

Step	Press Key	Read Display or Action	Description
14		Take SFC and milliammeter readings to check that output signal does correspond to empty and full tank pressures. If readings don't correspond, check that transmitter has been installed correctly. If applicable, blow down piping to be sure no foreign matter is entrapped in it. Check SFC and milliammeter readings again. If readings are still not correct, verify transmitter's configuration data and change its range setting if needed.	ATTENTION Ranging the transmitter in this way makes it reverse acting.
15		Remove SFC and milliammeter from loop.	

7.8 Pressure or Liquid Level Measurement with GP Transmitter

Procedure

The procedure in Table 43 outlines the steps for starting up a gauge pressure (GP) type transmitter in a pressure or liquid level measurement application. Refer to Figures 43 and 44 for the piping arrangement identification and Figure 38 for typical SFC and meter connections.

Figure 43 Typical Piping Arrangement for Pressure Measurement with GP Type Transmitter

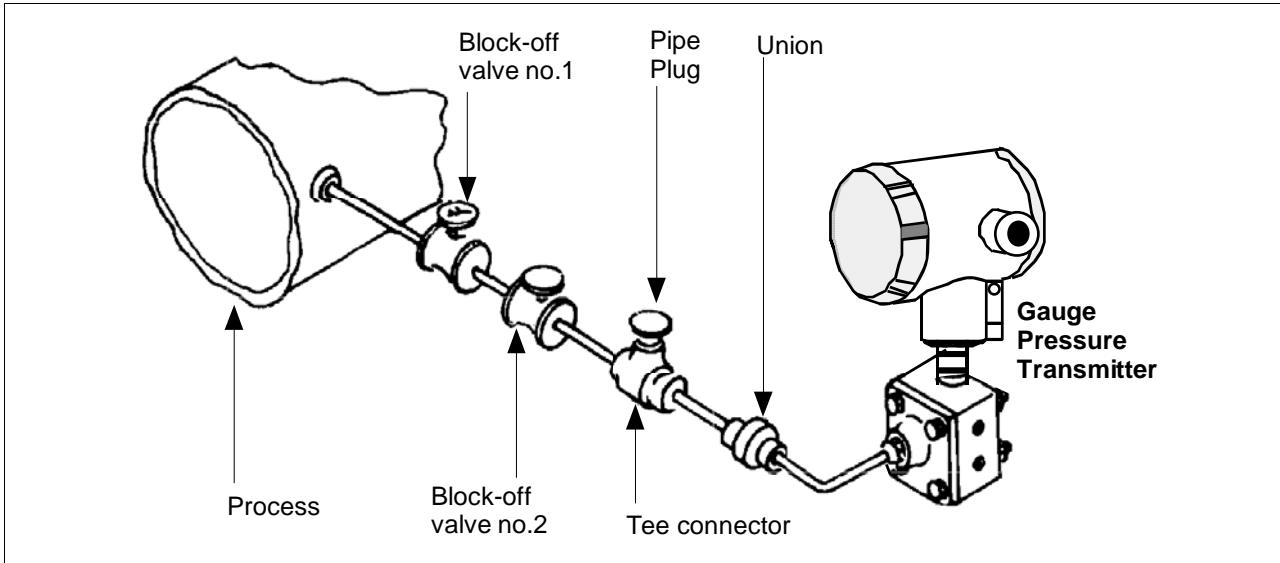
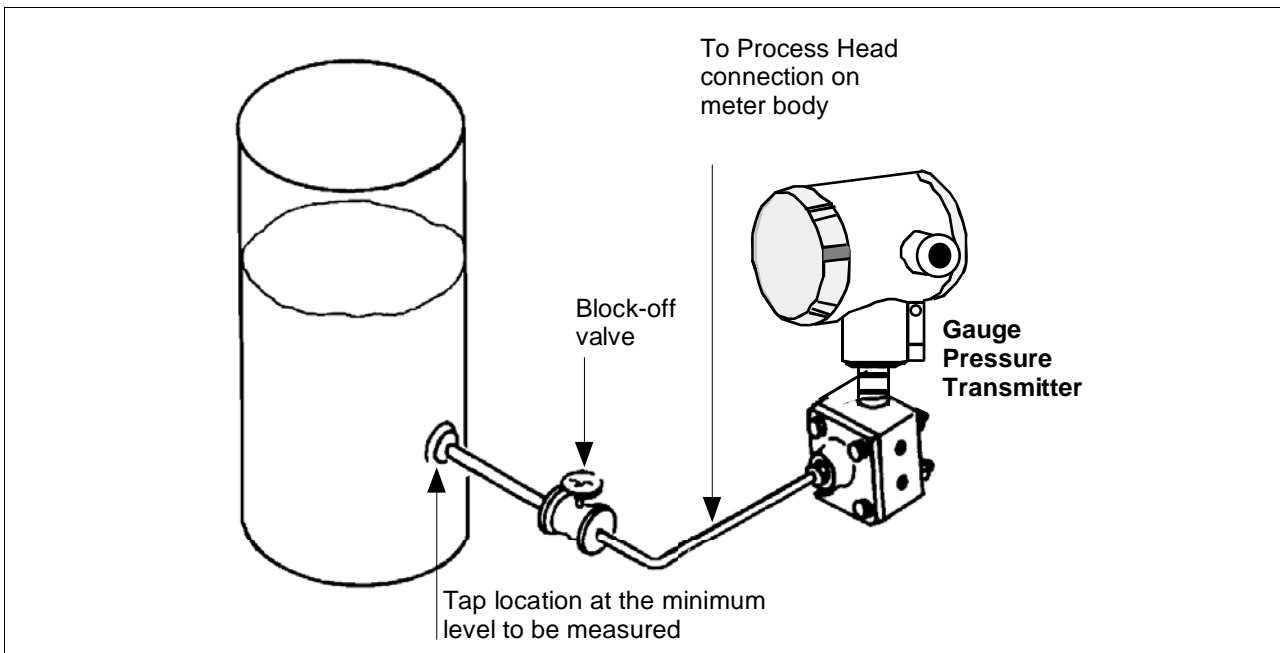

Figure 44 Typical Piping Arrangement for Liquid Level Measurement with GP Type Transmitter



Continued on next page

7.8 Pressure or Liquid Level Measurement with GP Transmitter, Continued

Procedure, continued

ATTENTION

For the procedure in Table 43, we are assuming that piping arrangement includes a block-off valve and a Tee-connector. If your piping does not include a Tee-connector, you can only verify that the input and output readings correlate.

Table 43 Starting Up GP Transmitter for Pressure or Liquid Level Measurement With SFC

















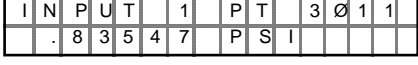

Step	Press Key	Read Display or Action	Description
1		Connect SFC across loop wiring and turn it on. If possible, locate SFC where you can also view receiver instrument in loop. If you want to verify transmitter output, connect a precision milliammeter or voltmeter in loop to compare readings.	See Figure 38 for sample SFC and meter connections in a typical analog loop with a differential pressure type transmitter.
2		Close block-off valve.	See Figure 43 or 44 for sample piping arrangement.
3		Remove plug from Tee-connector to vent it to atmosphere, if applicable.	Allow system to stabilize at static pressure.
4	DE READ ID ^A	T A G N O . T R I P S S E C U R E D ? ?	Be sure any switches that may trip alarms or interlocks associated with analog loop are secured or turned off.
5	NON-VOL ENTER (Yes)	T A G N O . S F C W O R K I N G . . . L I N D P T A G N O . P T 3 0 1 1	Confirm that "TRIPS" are secured and establish communications with sample transmitter PT 3011
6	SHIFT [^] INPUT OUT-PUT ^J	O U T P 1 P T 3 0 1 1 S H I F T - I N P U T 1 P T 3 0 1 1 S F C W O R K I N G . . . I N P U T 1 P T 3 0 1 1 . 0 0 0 4 2 P S I	Initiate shift key selection. Read applied input pressure which should be zero.
7	INPUT OUT-PUT ^J	O U T P 1 P T 3 0 1 1 S F C W O R K I N G . . . O U T P 1 P T 3 0 1 1 0 . 0 0 0 %	Call up output for display. Read 0% output on display for corresponding input pressure. For analog transmission, check that milliammeter reading is 4 mA (0%) output.

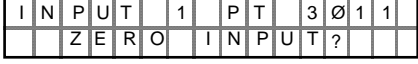
Continued on next page

7.8 Pressure or Liquid Level Measurement with GP Transmitter, Continued

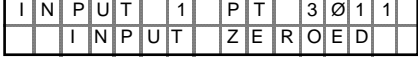
Procedure, continued

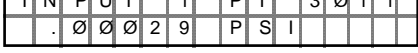
Table 43 Starting Up GP Transmitter for Pressure or Liquid Level Measurement With SFC, continued

Step	Press Key	Read Display or Action	Description								
8		<table border="1"> <tr> <th data-bbox="474 604 678 695">If SFC and milliammeter readings...</th> <th data-bbox="682 604 943 695">Then...</th> </tr> <tr> <td data-bbox="474 699 678 730">are zero (4mA)</td> <td data-bbox="682 699 943 730">go to Step 11.</td> </tr> <tr> <td data-bbox="474 735 678 884">are not zero (4mA) and Tee-connector is level with transmitter</td> <td data-bbox="682 735 943 884">go to Step 9.</td> </tr> <tr> <td data-bbox="474 888 678 1037">are not zero (4mA) and Tee-connector is above transmitter</td> <td data-bbox="682 888 943 1037">go to Step 10.</td> </tr> </table>	If SFC and milliammeter readings...	Then...	are zero (4mA)	go to Step 11.	are not zero (4mA) and Tee-connector is level with transmitter	go to Step 9.	are not zero (4mA) and Tee-connector is above transmitter	go to Step 10.	
If SFC and milliammeter readings...	Then...										
are zero (4mA)	go to Step 11.										
are not zero (4mA) and Tee-connector is level with transmitter	go to Step 9.										
are not zero (4mA) and Tee-connector is above transmitter	go to Step 10.										
9	<p data-bbox="332 1094 410 1167">  </p> <p data-bbox="332 1178 410 1272"> INPUT  </p> <p data-bbox="332 1377 410 1472"> RESET  </p> <p data-bbox="332 1587 410 1682"> NON-VOL  </p>	<p data-bbox="511 1094 925 1157">   </p> <p data-bbox="511 1188 925 1251">   </p> <p data-bbox="511 1272 925 1335">   </p> <p data-bbox="511 1377 925 1440">   </p> <p data-bbox="511 1587 925 1650">   </p> <p data-bbox="511 1671 925 1734">   </p> <p data-bbox="511 1755 925 1818">   </p>	<p data-bbox="976 1094 1279 1125">Initiate shift key selection.</p> <p data-bbox="976 1209 1317 1241">Read applied input pressure.</p> <p data-bbox="976 1367 1398 1524">Prompt asks if the applied input pressure equals zero input. If it is zero input, go to next keystroke. If it is not, press [CLR] key to exit function and try again.</p> <p data-bbox="976 1587 1360 1640">Zero input is set equal to applied input pressure. Go to Step 11.</p>								

Continued on next page

7.8 Pressure or Liquid Level Measurement with GP Transmitter, Continued

Procedure, continued

Table 43 Starting Up GP Transmitter for Pressure or Liquid Level Measurement With SFC, continued

Step	Press Key	Read Display or Action	Description																																																																								
10	<div style="border: 1px solid black; padding: 2px; width: fit-content; margin-bottom: 5px;">E LRV 0%</div> <div style="border: 1px solid black; padding: 2px; width: fit-content; margin-bottom: 5px;">G SET</div> <div style="border: 1px solid black; padding: 2px; width: fit-content; margin-bottom: 5px;">NON-VOL</div> <div style="border: 1px solid black; padding: 2px; width: fit-content;">ENTER (Yes)</div>	<div style="border: 1px solid black; padding: 2px; margin-bottom: 5px;"> <table style="width: 100%; border-collapse: collapse; text-align: center;"> <tr><td>L</td><td>R</td><td>V</td><td>1</td><td></td><td></td><td>P</td><td>T</td><td>3</td><td>0</td><td>1</td><td>1</td></tr> <tr><td>0</td><td>.</td><td>0</td><td>0</td><td>0</td><td>0</td><td>P</td><td>S</td><td>I</td><td></td><td></td><td></td></tr> </table> </div> <div style="border: 1px solid black; padding: 2px; margin-bottom: 5px;"> <table style="width: 100%; border-collapse: collapse; text-align: center;"> <tr><td>L</td><td>R</td><td>V</td><td>1</td><td></td><td></td><td>P</td><td>T</td><td>3</td><td>0</td><td>1</td><td>1</td></tr> <tr><td></td><td></td><td></td><td>S</td><td>E</td><td>T</td><td>L</td><td>R</td><td>V</td><td>?</td><td></td><td></td></tr> </table> </div> <div style="border: 1px solid black; padding: 2px;"> <table style="width: 100%; border-collapse: collapse; text-align: center;"> <tr><td>L</td><td>R</td><td>V</td><td>1</td><td></td><td></td><td>P</td><td>T</td><td>3</td><td>0</td><td>1</td><td>1</td></tr> <tr><td>1</td><td>0</td><td>.</td><td>0</td><td>0</td><td>5</td><td>P</td><td>S</td><td>I</td><td></td><td></td><td></td></tr> </table> </div>	L	R	V	1			P	T	3	0	1	1	0	.	0	0	0	0	P	S	I				L	R	V	1			P	T	3	0	1	1				S	E	T	L	R	V	?			L	R	V	1			P	T	3	0	1	1	1	0	.	0	0	5	P	S	I				<p>Read present LRV setting.</p> <p>Prompt asks if you want to set LRV to applied pressure.</p> <p>LRV is set to applied pressure.</p>
L	R	V	1			P	T	3	0	1	1																																																																
0	.	0	0	0	0	P	S	I																																																																			
L	R	V	1			P	T	3	0	1	1																																																																
			S	E	T	L	R	V	?																																																																		
L	R	V	1			P	T	3	0	1	1																																																																
1	0	.	0	0	5	P	S	I																																																																			
11		Close Tee-connector and slowly open block-off valve to apply process pressure to transmitter.																																																																									
12		Take SFC and milliammeter readings to check that output signal does correspond to zero and full-scale pressures. If readings don't correspond, check that transmitter has been installed correctly. If applicable, blow down piping to be sure no foreign matter is entrapped in it. Check SFC and milliammeter readings again. If readings are still not correct, verify transmitter's configuration data and change its range setting if needed.																																																																									
13		Remove SFC and milliammeter from loop.																																																																									

7.9 Pressure or Liquid Level Measurement with Flush Mount Transmitter

Procedure

The procedure in Table 43 outlines the steps for starting up a gauge pressure (GP) type transmitter in a pressure or liquid level measurement application. Refer to Figures 45 and 46 for the flush mount transmitter arrangement and Figure 38 for typical SFC and meter connections.

ATTENTION

For the procedure in Table 43, we are assuming that piping arrangement includes a block-off valve and a Tee-connector. If your piping does not include a Tee-connector, you can only verify that the input and output readings correlate.

Figure 45 Typical Arrangement for Pressure Measurement with Flush Mount Transmitter

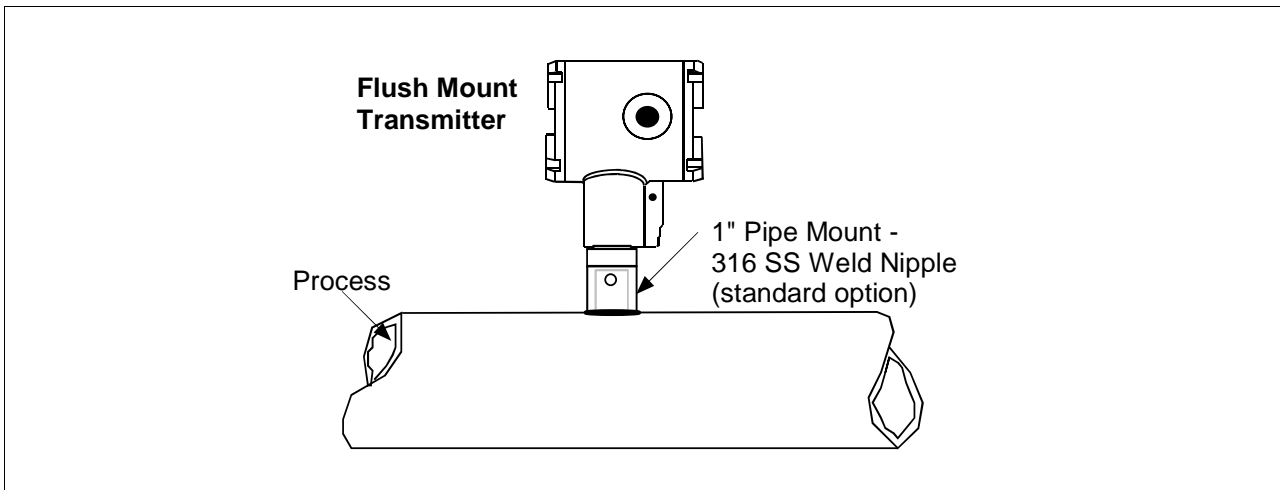
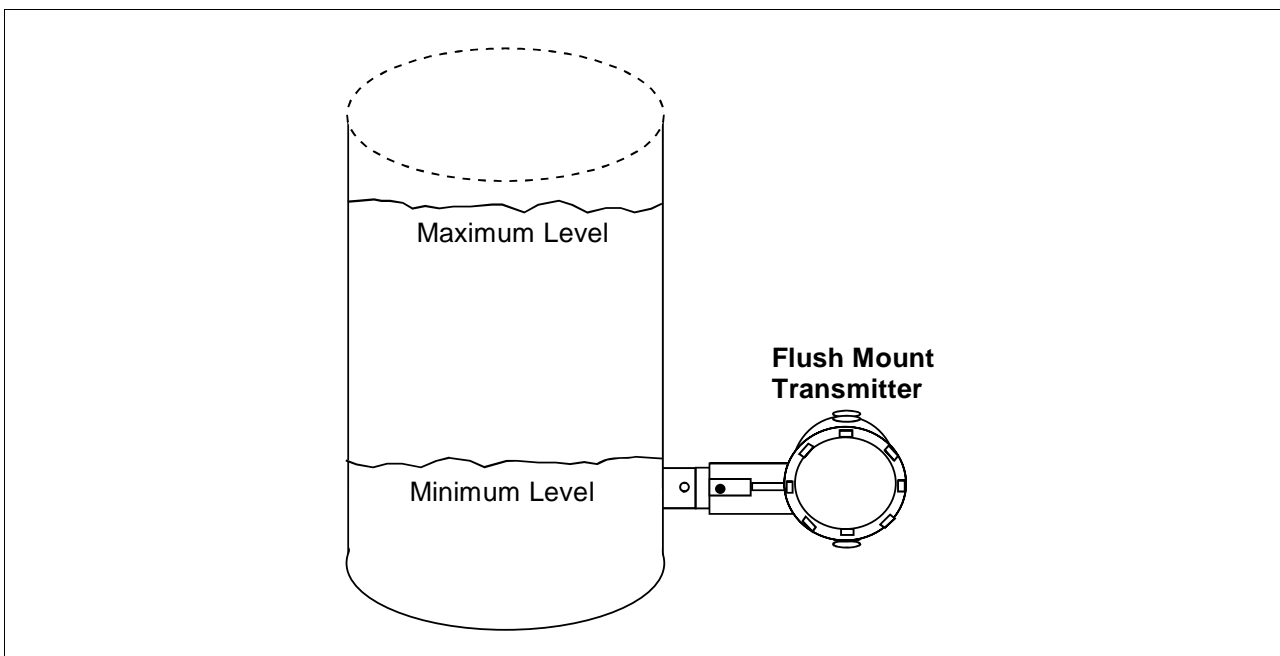

Figure 46 Typical Arrangement for Liquid Level Measurement with Flush Mount Transmitter



7.10 Pressure Measurement with AP Transmitter

Procedure

The procedure in Table 44 outlines the steps for starting up an absolute pressure (AP) type transmitter in a pressure measurement application. Refer to Figure 47 for the piping arrangement identification and Figure 38 for typical SFC and meter connections.

Figure 47 Typical Piping Arrangement for Pressure Measurement with AP Type Transmitter.

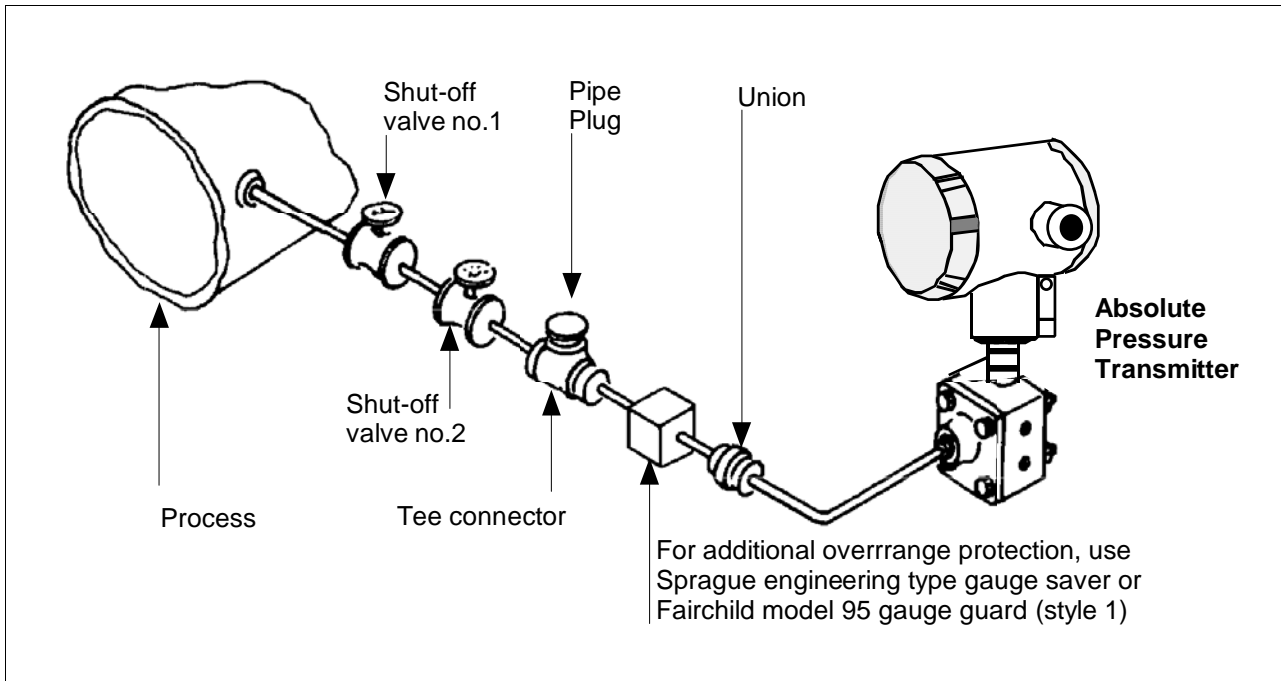

ATTENTION

For AP transmitters, you can only verify that the input and output readings correlate.

Table 44 Starting Up AP Transmitter for Pressure Measurement With SFC

Step	Press Key	Read Display or Action	Description																																								
1		Connect SFC across loop wiring and turn it on. If possible, locate SFC where you can also view receiver instrument in loop. If you want to verify transmitter output, connect a precision milliammeter or voltmeter in loop to compare readings.	See Figure 38 for sample SFC and meter connections in a typical analog loop with a differential pressure type transmitter.																																								
2		Set process pressure to zero level	Allow system to stabilize at zero pressure.																																								
3	DE READ ID	<table border="1"> <tr> <td>T</td><td>A</td><td>G</td><td>N</td><td>O</td><td>.</td><td></td><td></td><td></td><td></td><td></td><td></td><td></td><td></td><td></td><td></td><td></td><td></td><td></td><td></td> </tr> <tr> <td>T</td><td>R</td><td>I</td><td>P</td><td>S</td><td></td><td>S</td><td>E</td><td>C</td><td>U</td><td>R</td><td>E</td><td>D</td><td>?</td><td>?</td><td></td><td></td><td></td><td></td><td></td> </tr> </table>	T	A	G	N	O	.															T	R	I	P	S		S	E	C	U	R	E	D	?	?						Be sure any switches that may trip alarms or interlocks associated with analog loop are secured or turned off.
T	A	G	N	O	.																																						
T	R	I	P	S		S	E	C	U	R	E	D	?	?																													

Continued on next page

7.10 Pressure Measurement with AP Transmitter, Continued

Procedure,
continued

Table 44 Starting Up AP Transmitter for Pressure Measurement With SFC, continued

Step	Press Key	Read Display or Action	Description																																																																																																																																			
4	NON-VOL ENTER (Yes)	<table border="1"> <tr><td>T</td><td>A</td><td>G</td><td>N</td><td>O</td><td>.</td><td></td><td></td><td></td><td></td><td></td><td></td><td></td><td></td><td></td><td></td><td></td><td></td><td></td><td></td></tr> <tr><td>S</td><td>F</td><td>C</td><td>W</td><td>O</td><td>R</td><td>K</td><td>I</td><td>N</td><td>G</td><td>.</td><td>.</td><td>.</td><td></td><td></td><td></td><td></td><td></td><td></td><td></td><td></td></tr> <tr><td>L</td><td>I</td><td>N</td><td></td><td>D</td><td>P</td><td>T</td><td>A</td><td>G</td><td>N</td><td>O</td><td>.</td><td></td><td></td><td></td><td></td><td></td><td></td><td></td><td></td><td></td></tr> <tr><td></td><td></td><td></td><td></td><td></td><td></td><td></td><td>P</td><td>T</td><td>3</td><td>0</td><td>1</td><td>1</td><td></td><td></td><td></td><td></td><td></td><td></td><td></td><td></td></tr> </table>	T	A	G	N	O	.															S	F	C	W	O	R	K	I	N	G	.	.	.									L	I	N		D	P	T	A	G	N	O	.																	P	T	3	0	1	1									Confirm that "TRIPS" are secured and establish communications with sample transmitter PT 3011																																																
T	A	G	N	O	.																																																																																																																																	
S	F	C	W	O	R	K	I	N	G	.	.	.																																																																																																																										
L	I	N		D	P	T	A	G	N	O	.																																																																																																																											
							P	T	3	0	1	1																																																																																																																										
5	SHIFT INPUT OUT-PUT	<table border="1"> <tr><td>O</td><td>U</td><td>T</td><td>P</td><td>1</td><td></td><td>P</td><td>T</td><td>3</td><td>0</td><td>1</td><td>1</td><td></td><td></td><td></td><td></td><td></td><td></td><td></td><td></td><td></td></tr> <tr><td></td><td></td><td></td><td></td><td></td><td></td><td>S</td><td>H</td><td>I</td><td>F</td><td>T</td><td>-</td><td></td><td></td><td></td><td></td><td></td><td></td><td></td><td></td><td></td><td></td></tr> <tr><td>I</td><td>N</td><td>P</td><td>U</td><td>T</td><td>1</td><td></td><td>P</td><td>T</td><td>3</td><td>0</td><td>1</td><td>1</td><td></td><td></td><td></td><td></td><td></td><td></td><td></td><td></td><td></td></tr> <tr><td>S</td><td>F</td><td>C</td><td>W</td><td>O</td><td>R</td><td>K</td><td>I</td><td>N</td><td>G</td><td>.</td><td>.</td><td>.</td><td></td><td></td><td></td><td></td><td></td><td></td><td></td><td></td><td></td></tr> <tr><td>I</td><td>N</td><td>P</td><td>U</td><td>T</td><td>1</td><td></td><td>P</td><td>T</td><td>3</td><td>0</td><td>1</td><td>1</td><td></td><td></td><td></td><td></td><td></td><td></td><td></td><td></td><td></td></tr> <tr><td>.</td><td>0</td><td>0</td><td>0</td><td>4</td><td>2</td><td>P</td><td>S</td><td>I</td><td></td><td></td><td></td><td></td><td></td><td></td><td></td><td></td><td></td><td></td><td></td><td></td><td></td></tr> </table>	O	U	T	P	1		P	T	3	0	1	1																S	H	I	F	T	-											I	N	P	U	T	1		P	T	3	0	1	1										S	F	C	W	O	R	K	I	N	G	.	.	.										I	N	P	U	T	1		P	T	3	0	1	1										.	0	0	0	4	2	P	S	I														Initiate shift key selection. Read applied input pressure which should be zero.
O	U	T	P	1		P	T	3	0	1	1																																																																																																																											
						S	H	I	F	T	-																																																																																																																											
I	N	P	U	T	1		P	T	3	0	1	1																																																																																																																										
S	F	C	W	O	R	K	I	N	G	.	.	.																																																																																																																										
I	N	P	U	T	1		P	T	3	0	1	1																																																																																																																										
.	0	0	0	4	2	P	S	I																																																																																																																														
6	INPUT OUT-PUT	<table border="1"> <tr><td>O</td><td>U</td><td>T</td><td>P</td><td>1</td><td></td><td>P</td><td>T</td><td>3</td><td>0</td><td>1</td><td>1</td><td></td><td></td><td></td><td></td><td></td><td></td><td></td><td></td><td></td></tr> <tr><td>S</td><td>F</td><td>C</td><td>W</td><td>O</td><td>R</td><td>K</td><td>I</td><td>N</td><td>G</td><td>.</td><td>.</td><td>.</td><td></td><td></td><td></td><td></td><td></td><td></td><td></td><td></td><td></td></tr> <tr><td>O</td><td>U</td><td>T</td><td>P</td><td>1</td><td></td><td>P</td><td>T</td><td>3</td><td>0</td><td>1</td><td>1</td><td></td><td></td><td></td><td></td><td></td><td></td><td></td><td></td><td></td><td></td></tr> <tr><td></td><td></td><td></td><td></td><td>0</td><td>.</td><td>0</td><td>0</td><td>0</td><td>%</td><td></td><td></td><td></td><td></td><td></td><td></td><td></td><td></td><td></td><td></td><td></td><td></td></tr> </table>	O	U	T	P	1		P	T	3	0	1	1										S	F	C	W	O	R	K	I	N	G	.	.	.										O	U	T	P	1		P	T	3	0	1	1															0	.	0	0	0	%													Call up output for display. Read 0% output on display for corresponding input pressure. For analog transmission, check that milliammeter reading is 4 mA (0%) output.																																												
O	U	T	P	1		P	T	3	0	1	1																																																																																																																											
S	F	C	W	O	R	K	I	N	G	.	.	.																																																																																																																										
O	U	T	P	1		P	T	3	0	1	1																																																																																																																											
				0	.	0	0	0	%																																																																																																																													
7		Take SFC and milliammeter readings to check that output signal does correspond to zero and full-scale pressures. If readings don't correspond, check that transmitter has been installed correctly. If applicable, blow down piping to be sure no foreign matter is entrapped in it. Check SFC and milliammeter readings again. If readings are still not correct, verify transmitter's configuration data and change its range setting if needed.																																																																																																																																				
8		Remove SFC and milliammeter from loop.																																																																																																																																				

7.11 Liquid Level Measurement with DP Transmitter with Remote Seals

Procedure

The procedure in Table 45 outlines the steps for starting up a differential pressure (DP) type transmitter with remote diaphragm seals in a liquid level measurement application. Refer to Figure 48 for the piping arrangement identification and Figure 38 for typical SFC and meter connections.

Figure 48 Typical Piping Arrangement for Liquid Level Measurement with DP Type Transmitter with Remote Seals

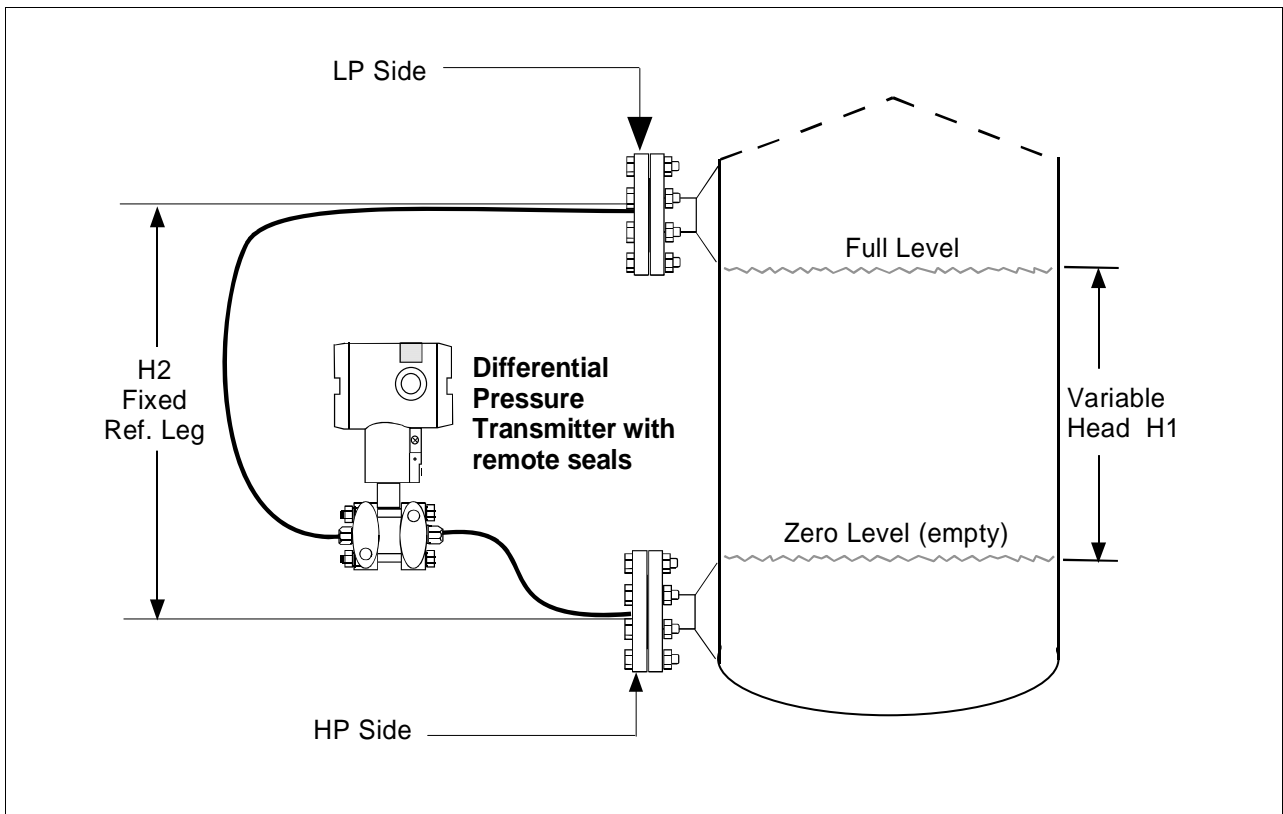

ATTENTION



For the procedure in Table 45, we are assuming that the tank is empty and the remote seal flanges are installed at their final positions. The transmitter is a model STR93D or STR12D with a compound characterized meter body. The DP transmitter has its high pressure (HP) side connected to the tank's lower flange and low pressure (LP) side connected to the upper flange. (Note that connections would be reversed for a model STR13D transmitter or a model STR12D transmitter without a compound characterized meter body.)

Continued on next page

7.11 Liquid Level Measurement with DP Transmitter with Remote Seals, Continued

Procedure, continued

Table 45 Starting Up DP Transmitter with Remote Seals for Liquid Level Measurement with SFC

Step	Press Key	Read Display or Action	Description																																																																
1		Connect SFC across loop wiring and turn it on. If possible, locate SFC where you can also view receiver instrument in loop. If you want to verify transmitter output, connect a precision milliammeter or voltmeter in loop to compare readings.	See Figure 38 for sample SFC and meter connections in a typical analog loop with a differential pressure type transmitter.																																																																
2		<table border="1" style="border-collapse: collapse; text-align: center;"> <tr><td>T</td><td>A</td><td>G</td><td>N</td><td>O</td><td>.</td><td></td><td></td><td></td><td></td><td></td><td></td><td></td><td></td><td></td><td></td></tr> <tr><td>T</td><td>R</td><td>I</td><td>P</td><td>S</td><td>S</td><td>E</td><td>C</td><td>U</td><td>R</td><td>E</td><td>D</td><td>?</td><td>?</td><td></td><td></td></tr> </table>	T	A	G	N	O	.											T	R	I	P	S	S	E	C	U	R	E	D	?	?			Be sure any switches that may trip alarms or interlocks associated with analog loop are secured or turned off.																																
T	A	G	N	O	.																																																														
T	R	I	P	S	S	E	C	U	R	E	D	?	?																																																						
3		<table border="1" style="border-collapse: collapse; text-align: center;"> <tr><td>T</td><td>A</td><td>G</td><td>N</td><td>O</td><td>.</td><td></td><td></td><td></td><td></td><td></td><td></td><td></td><td></td><td></td><td></td></tr> <tr><td>S</td><td>F</td><td>C</td><td>W</td><td>O</td><td>R</td><td>K</td><td>I</td><td>N</td><td>G</td><td>.</td><td>.</td><td>.</td><td></td><td></td><td></td></tr> <tr><td>L</td><td>I</td><td>N</td><td></td><td>D</td><td>P</td><td>T</td><td>A</td><td>G</td><td>N</td><td>O</td><td>.</td><td></td><td></td><td></td><td></td></tr> <tr><td></td><td></td><td></td><td></td><td></td><td></td><td>P</td><td>T</td><td>3</td><td>Ø</td><td>1</td><td>1</td><td></td><td></td><td></td><td></td></tr> </table>	T	A	G	N	O	.											S	F	C	W	O	R	K	I	N	G	.	.	.				L	I	N		D	P	T	A	G	N	O	.											P	T	3	Ø	1	1					Confirm that “TRIPS” are secured and establish communications with sample transmitter PT 3011
T	A	G	N	O	.																																																														
S	F	C	W	O	R	K	I	N	G	.	.	.																																																							
L	I	N		D	P	T	A	G	N	O	.																																																								
						P	T	3	Ø	1	1																																																								
4		<table border="1" style="border-collapse: collapse; text-align: center;"> <thead> <tr> <th>If you ...</th> <th>Then...</th> </tr> </thead> <tbody> <tr> <td>can not empty tank</td> <td>go to Step 5.</td> </tr> <tr> <td>can empty tank</td> <td>go to Step 6.</td> </tr> </tbody> </table>	If you ...	Then...	can not empty tank	go to Step 5.	can empty tank	go to Step 6.	See Figure 48 for sample piping arrangement.																																																										
If you ...	Then...																																																																		
can not empty tank	go to Step 5.																																																																		
can empty tank	go to Step 6.																																																																		
5		Key in LRV that is equal to empty tank pressure. See section 6.7 in this manual for details on keying in a range value. Go to Step 8.	<p>You can use this formula to calculate LRV in inH₂O.</p> $LRV = H_2 \times S_f \times -1$ <p>H₂ = Height of fixed reference leg in inches.</p> <p>S_f = Specific gravity of remote seal fill fluid.</p> <p>-1 = Required for LRV calculation since pressure is on low side of meter body.</p> <p>Example: If H₂ equaled 12 feet and the fill fluid was silicone oil, substituting into the formula yields.</p> $LRV = 12 \text{ ft} \times 12 \text{ in} \times 0.94 \times -1$ $LRV = -135.36 \text{ inH}_2\text{O}$ <p>ATTENTION The specific gravity of silicone oil fill fluid is 0.94 and florolube fill fluid is 1.84.</p>																																																																

Continued on next page

7.11 Liquid Level Measurement with DP Transmitter with Remote Seals, Continued

Procedure, continued

Table 45 Starting Up DP Transmitter with Remote Seals for Liquid Level Measurement with SFC, continued

Step	Press Key	Read Display or Action	Description																																																																															
6	<div style="border: 1px solid black; padding: 2px; display: inline-block; margin-bottom: 5px;">E LRV 0%</div> <div style="border: 1px solid black; padding: 2px; display: inline-block; margin-bottom: 5px;">G SET</div> <div style="border: 1px solid black; padding: 2px; display: inline-block; margin-bottom: 5px;">NON-VOL</div> <div style="border: 1px solid black; padding: 2px; display: inline-block;">ENTER (Yes)</div>	<table border="1" style="width: 100%; border-collapse: collapse; text-align: center;"> <tr><td>L</td><td>R</td><td>V</td><td>1</td><td></td><td></td><td>P</td><td>T</td><td>3</td><td>0</td><td>1</td><td>1</td></tr> <tr><td>0</td><td>.</td><td>0</td><td>0</td><td>0</td><td>0</td><td>"</td><td>H</td><td>2</td><td>O</td><td>-</td><td>3</td><td>9</td><td>F</td></tr> </table> <table border="1" style="width: 100%; border-collapse: collapse; text-align: center;"> <tr><td>L</td><td>R</td><td>V</td><td>1</td><td></td><td></td><td>P</td><td>T</td><td>3</td><td>0</td><td>1</td><td>1</td></tr> <tr><td></td><td></td><td></td><td>S</td><td>E</td><td>T</td><td>L</td><td>R</td><td>V</td><td>?</td><td></td><td></td><td></td><td></td></tr> </table> <table border="1" style="width: 100%; border-collapse: collapse; text-align: center;"> <tr><td>L</td><td>R</td><td>V</td><td>1</td><td></td><td></td><td>P</td><td>T</td><td>3</td><td>0</td><td>1</td><td>1</td></tr> <tr><td>-</td><td>1</td><td>3</td><td>5</td><td>.</td><td>3</td><td>6</td><td>"</td><td>H</td><td>2</td><td>O</td><td>-</td><td>3</td><td>9</td><td>F</td></tr> </table>	L	R	V	1			P	T	3	0	1	1	0	.	0	0	0	0	"	H	2	O	-	3	9	F	L	R	V	1			P	T	3	0	1	1				S	E	T	L	R	V	?					L	R	V	1			P	T	3	0	1	1	-	1	3	5	.	3	6	"	H	2	O	-	3	9	F	<p>Read present LRV setting.</p> <p>Prompt asks if you want to set LRV to applied pressure.</p> <p>LRV is set to fixed reference leg pressure H2 times specific gravity of remote seal fill fluid and -1 for pressure on low side of meter body.</p>
L	R	V	1			P	T	3	0	1	1																																																																							
0	.	0	0	0	0	"	H	2	O	-	3	9	F																																																																					
L	R	V	1			P	T	3	0	1	1																																																																							
			S	E	T	L	R	V	?																																																																									
L	R	V	1			P	T	3	0	1	1																																																																							
-	1	3	5	.	3	6	"	H	2	O	-	3	9	F																																																																				
7	<div style="border: 1px solid black; padding: 2px; display: inline-block; margin-bottom: 5px;">INPUT J</div> <div style="border: 1px solid black; padding: 2px; display: inline-block;">OUT-PUT</div>	<table border="1" style="width: 100%; border-collapse: collapse; text-align: center;"> <tr><td>O</td><td>U</td><td>T</td><td>P</td><td>1</td><td></td><td>P</td><td>T</td><td>3</td><td>0</td><td>1</td><td>1</td></tr> <tr><td>S</td><td>F</td><td>C</td><td>W</td><td>O</td><td>R</td><td>K</td><td>I</td><td>N</td><td>G</td><td>.</td><td>.</td><td>.</td><td>.</td><td>.</td></tr> </table> <table border="1" style="width: 100%; border-collapse: collapse; text-align: center;"> <tr><td>O</td><td>U</td><td>T</td><td>P</td><td>1</td><td></td><td>P</td><td>T</td><td>3</td><td>0</td><td>1</td><td>1</td></tr> <tr><td></td><td></td><td></td><td>0</td><td>.</td><td>0</td><td>0</td><td>0</td><td>%</td><td></td><td></td><td></td><td></td><td></td><td></td></tr> </table>	O	U	T	P	1		P	T	3	0	1	1	S	F	C	W	O	R	K	I	N	G	O	U	T	P	1		P	T	3	0	1	1				0	.	0	0	0	%							<p>Call up output for display.</p> <p>Read 0% output on display for corresponding empty tank pressure plus reference pressure H2. For analog transmission, check that milliammeter reading is 4 mA (0%) output.</p>																									
O	U	T	P	1		P	T	3	0	1	1																																																																							
S	F	C	W	O	R	K	I	N	G																																																																				
O	U	T	P	1		P	T	3	0	1	1																																																																							
			0	.	0	0	0	%																																																																										
8		<table border="1" style="width: 100%; border-collapse: collapse;"> <thead> <tr> <th style="width: 50%;">If you ...</th> <th style="width: 50%;">Then...</th> </tr> </thead> <tbody> <tr> <td>can not fill tank</td> <td>go to Step 9.</td> </tr> <tr> <td>can fill tank</td> <td>go to Step 10.</td> </tr> </tbody> </table>	If you ...	Then...	can not fill tank	go to Step 9.	can fill tank	go to Step 10.																																																																										
If you ...	Then...																																																																																	
can not fill tank	go to Step 9.																																																																																	
can fill tank	go to Step 10.																																																																																	
9		<p>Key in URV that is equal to full tank pressure. See section 6.7 in this manual for details on keying in a range value. Go to Step 12.</p>	<p>You can use these formulas to calculate URV in inH₂O.</p> <p>Span = H₁ x S_L</p> <p>H₁ = Height of variable head in inches.</p> <p>S_L = Specific gravity of measured liquid.</p> <p>URV = Span + LRV</p> <p>Example: If H₁ equaled 10 feet, the measured liquid was water, and the LRV equaled -135.36 inH₂O; substituting into the formulas yields.</p> <p>Span = 10 ft x 12 in x 1.00 Span = 120 inH₂O</p> <p>URV = 120 inH₂O + -135.36 inH₂O URV = -15.36 inH₂O</p> <div style="border: 1px solid black; padding: 2px; display: inline-block; margin-top: 10px;">ATTENTION</div> The specific gravity of water at 60 °F (15.6 °C) is 1.00.																																																																															

Continued on next page

7.11 Liquid Level Measurement with DP Transmitter with Remote Seals, Continued

Procedure, continued

Table 45 Starting Up DP Transmitter with Remote Seals for Liquid Level Measurement with SFC, continued

Step	Press Key	Read Display or Action	Description
10	<div style="border: 1px solid black; padding: 2px; width: fit-content; margin-bottom: 5px;">F URV 100%</div> <div style="border: 1px solid black; padding: 2px; width: fit-content; margin-bottom: 5px;">G SET</div> <div style="border: 1px solid black; padding: 2px; width: fit-content; margin-bottom: 5px;">NON-VOL</div> <div style="border: 1px solid black; padding: 2px; width: fit-content;">ENTER (Yes)</div>	<div style="border: 1px solid black; padding: 2px; margin-bottom: 5px;">U R V 1 P T 3 0 1 1 5 0 . 0 0 0 " H 2 O _ 3 9 F</div> <div style="border: 1px solid black; padding: 2px; margin-bottom: 5px;">U R V 1 P T 3 0 1 1 S E T U R V ?</div> <div style="border: 1px solid black; padding: 2px;">U R V 1 P T 3 0 1 1 - 1 5 . 3 6 0 " H 2 O _ 3 9 F</div>	<p>Read present URV setting.</p> <p>Prompt asks if you want to set URV to applied pressure.</p> <p>URV is set to full tank pressure.</p>
11	<div style="border: 1px solid black; padding: 2px; width: fit-content; margin-bottom: 5px;">INPUT</div> <div style="border: 1px solid black; padding: 2px; width: fit-content;">J OUT- PUT</div>	<div style="border: 1px solid black; padding: 2px; margin-bottom: 5px;">O U T P 1 P T 3 0 1 1 S F C W O R K I N G . . .</div> <div style="border: 1px solid black; padding: 2px;">O U T P 1 P T 3 0 1 1 1 0 0 . 0 0 %</div>	<p>Call up output for display, with full tank pressure applied.</p> <p>Read 100% output on display for corresponding full tank pressure. For analog transmission, check that milliammeter reading is 20 mA (100%) output.</p>
12		Take SFC and milliammeter readings to check that output signal does correspond to empty and full tank pressures. If readings don't correspond, check that transmitter has been installed correctly. If applicable, blow down piping to be sure no foreign matter is entrapped in it. Check SFC and milliammeter readings again. If readings are still not correct, verify transmitter's configuration data and change its range setting if needed.	
13		Remove SFC and milliammeter from loop.	

Section 8 —Operation

8.1 Introduction

Section Contents This section includes these topics:

Section	Topic	See Page
8.1	Introduction	151
8.2	Accessing Operation Data	152
8.3	Changing Default Failsafe Direction.....	155
8.4	Writing Data in Scratch Pad Area.....	157
8.5	Saving and Restoring a Database.....	159
8.6	Monitoring Local Smart Meter Display	163

About this section This section identifies how to access typical data associated with the operation of an ST 3000 transmitter. It also includes procedures for:

- Changing the default failsafe direction,
 - Writing data in the scratch pad area,
 - Saving and Restoring a database, and
 - Monitoring optional Local Smart Meter display.
-

8.2 Accessing Operation Data

Summary

You can access this data relevant to the operation of the transmitter using an SFC.

- Input
- Output
- Span
- Upper Range Limit
- Status
- Failsafe Output Direction
- Sensor Temperature
- Scratch Pad Messages
- PROM Serial Number

Procedure

Table 46 summarizes the keystrokes required to access given operation data from the transmitter using an SFC. These keystrokes assume that SFC communications have been established with the transmitter by pressing the [ID] key. The values shown in displays are for example purposes only.

Table 46 Summary of Keystrokes for Operation Data Access

IF you want to view...	THEN use these keystrokes...																																																																																																
the present input pressure, which is updated every six seconds	<div style="display: flex; align-items: flex-start;"> <div style="margin-right: 10px;"> <div style="border: 1px solid black; padding: 2px; text-align: center;"> [^] SHIFT </div> <div style="margin-top: 10px;">INPUT</div> <div style="border: 1px solid black; padding: 2px; text-align: center;"> ^J OUT-PUT </div> </div> <div> <table border="1" style="border-collapse: collapse; text-align: center; width: 100%;"> <tr><td>L</td><td>I</td><td>N</td><td></td><td>D</td><td>P</td><td>P</td><td>T</td><td>3</td><td>0</td><td>1</td><td>1</td></tr> <tr><td></td><td></td><td></td><td></td><td>S</td><td>H</td><td>I</td><td>F</td><td>T</td><td>-</td><td></td><td></td></tr> </table> <table border="1" style="border-collapse: collapse; text-align: center; width: 100%;"> <tr><td>I</td><td>N</td><td>P</td><td>U</td><td>T</td><td>1</td><td>P</td><td>T</td><td>3</td><td>0</td><td>1</td><td>1</td></tr> <tr><td>S</td><td>F</td><td>C</td><td>W</td><td>O</td><td>R</td><td>K</td><td>I</td><td>N</td><td>G</td><td>.</td><td>.</td></tr> </table> <table border="1" style="border-collapse: collapse; text-align: center; width: 100%;"> <tr><td>I</td><td>N</td><td>P</td><td>U</td><td>T</td><td>1</td><td>P</td><td>T</td><td>3</td><td>Ø</td><td>1</td><td>1</td></tr> <tr><td>1</td><td>3</td><td>2</td><td>.</td><td>7</td><td>Ø</td><td>"</td><td>H</td><td>2</td><td>O</td><td>-</td><td>3</td></tr> <tr><td></td><td></td><td></td><td></td><td></td><td></td><td></td><td></td><td></td><td></td><td></td><td>9</td></tr> <tr><td></td><td></td><td></td><td></td><td></td><td></td><td></td><td></td><td></td><td></td><td></td><td>F</td></tr> </table> </div> </div>	L	I	N		D	P	P	T	3	0	1	1					S	H	I	F	T	-			I	N	P	U	T	1	P	T	3	0	1	1	S	F	C	W	O	R	K	I	N	G	.	.	I	N	P	U	T	1	P	T	3	Ø	1	1	1	3	2	.	7	Ø	"	H	2	O	-	3												9												F
L	I	N		D	P	P	T	3	0	1	1																																																																																						
				S	H	I	F	T	-																																																																																								
I	N	P	U	T	1	P	T	3	0	1	1																																																																																						
S	F	C	W	O	R	K	I	N	G	.	.																																																																																						
I	N	P	U	T	1	P	T	3	Ø	1	1																																																																																						
1	3	2	.	7	Ø	"	H	2	O	-	3																																																																																						
											9																																																																																						
											F																																																																																						
the present transmitter output in percent, which is updated every six seconds	<div style="display: flex; align-items: flex-start;"> <div style="margin-right: 10px;"> <div style="margin-top: 10px;">INPUT</div> <div style="border: 1px solid black; padding: 2px; text-align: center;"> ^J OUT-PUT </div> </div> <div> <table border="1" style="border-collapse: collapse; text-align: center; width: 100%;"> <tr><td>O</td><td>U</td><td>T</td><td>P</td><td>1</td><td></td><td>P</td><td>T</td><td>3</td><td>0</td><td>1</td><td>1</td></tr> <tr><td>S</td><td>F</td><td>C</td><td>W</td><td>O</td><td>R</td><td>K</td><td>I</td><td>N</td><td>G</td><td>.</td><td>.</td></tr> </table> <table border="1" style="border-collapse: collapse; text-align: center; width: 100%;"> <tr><td>O</td><td>U</td><td>T</td><td>P</td><td>1</td><td></td><td>P</td><td>T</td><td>3</td><td>0</td><td>1</td><td>1</td></tr> <tr><td></td><td>6</td><td>5</td><td>.</td><td>7</td><td>4</td><td></td><td>%</td><td></td><td></td><td></td><td></td></tr> </table> </div> </div>	O	U	T	P	1		P	T	3	0	1	1	S	F	C	W	O	R	K	I	N	G	.	.	O	U	T	P	1		P	T	3	0	1	1		6	5	.	7	4		%																																																				
O	U	T	P	1		P	T	3	0	1	1																																																																																						
S	F	C	W	O	R	K	I	N	G	.	.																																																																																						
O	U	T	P	1		P	T	3	0	1	1																																																																																						
	6	5	.	7	4		%																																																																																										

Continued on next page

8.2 Accessing Operation Data, Continued

Procedure, continued

Table 46 Summary of Keystrokes for Operation Data Access, continued











IF you want to view...	THEN use these keystrokes...
the span, which is the URV minus the LRV	URL SPAN S P A N 1 P T 3 0 1 1 2 0 0 . 0 0 " H 2 O - 3 9 F
the Upper Range Limit of the transmitter	^ SHIFT L I N D P P T 3 0 1 1 S H I F T - URL SPAN U R L 1 P T 3 0 1 1 4 0 0 . 0 0 " H 2 O - 3 9 F
the status of transmitter operation at the present time	F/S DIR U STAT S T A T U S P T 3 0 1 1 S F C W O R K I N G . . . S T A T U S P T 3 0 1 1 S T A T U S C H E C K = O K L I N D P P T 3 0 1 1 R E A D Y . . .
the present failsafe output direction for the transmitter ATTENTION You can change the default failsafe direction from upscale to downscale. See Changing default failsafe direction in this section.	^ SHIFT F/S DIR U STAT L I N D P P T 3 0 1 1 S H I F T - F / S D I R P T 3 0 1 1 S F C W O R K I N G . . . F / S D I R P T 3 0 1 1 F / S A F E U P S C A L E OR F / S D I R P T 3 0 1 1 F / S A F E D O W N S C A L E

Continued on next page

8.2 Accessing Operation Data, Continued

Procedure, continued

Table 46 Summary of Keystrokes for Operation Data Access, continued

IF you want to view...	THEN use these keystrokes...																																																																																																																																												
<p>the present temperature (± 5 °C) measured by circuitry in the transmitter's sensor</p> <p>ATTENTION You can change the temperature engineering units to °F, °R or °K by pressing the [UNITS] key to select and then the [CONF] key to return to the temperature display.</p>	<div style="display: flex; flex-direction: column; gap: 10px;"> <div>  <table border="1" data-bbox="971 478 1385 541"> <tr><td></td><td></td><td>S</td><td>T</td><td>C</td><td>O</td><td>N</td><td>F</td><td>I</td><td>G</td><td></td><td></td><td></td><td></td></tr> <tr><td>C</td><td>O</td><td>N</td><td>F</td><td>O</td><td>R</td><td>M</td><td>I</td><td>T</td><td>Y</td><td>?</td><td></td><td></td><td></td></tr> </table> </div> <div>  <table border="1" data-bbox="971 575 1385 638"> <tr><td></td><td></td><td>S</td><td>T</td><td>C</td><td>O</td><td>N</td><td>F</td><td>I</td><td>G</td><td></td><td></td><td></td><td></td></tr> <tr><td>M</td><td>e</td><td>t</td><td>e</td><td>r</td><td>C</td><td>o</td><td>n</td><td>f</td><td>i</td><td>g</td><td>?</td><td></td><td></td></tr> </table> </div> <div>  <table border="1" data-bbox="971 676 1385 739"> <tr><td></td><td></td><td>S</td><td>T</td><td>C</td><td>O</td><td>N</td><td>F</td><td>I</td><td>G</td><td></td><td></td><td></td><td></td></tr> <tr><td>S</td><td>E</td><td>N</td><td>S</td><td>O</td><td>R</td><td>T</td><td>E</td><td>M</td><td>P</td><td>?</td><td></td><td></td><td></td></tr> </table> </div> <div> <p>NON-VOL</p>  <table border="1" data-bbox="971 779 1385 842"> <tr><td></td><td></td><td>S</td><td>T</td><td>C</td><td>O</td><td>N</td><td>F</td><td>I</td><td>G</td><td></td><td></td><td></td><td></td></tr> <tr><td>S</td><td>F</td><td>C</td><td>W</td><td>O</td><td>R</td><td>K</td><td>I</td><td>N</td><td>G</td><td>.</td><td>.</td><td>.</td><td></td></tr> </table> <table border="1" data-bbox="971 869 1385 932"> <tr><td>S</td><td>E</td><td>N</td><td>S</td><td>O</td><td>R</td><td>T</td><td>E</td><td>M</td><td>P</td><td>.</td><td></td><td></td><td></td></tr> <tr><td>1</td><td>6</td><td>.</td><td>2</td><td>9</td><td>6</td><td>°</td><td>C</td><td></td><td></td><td></td><td></td><td></td><td></td></tr> </table> </div> </div>			S	T	C	O	N	F	I	G					C	O	N	F	O	R	M	I	T	Y	?						S	T	C	O	N	F	I	G					M	e	t	e	r	C	o	n	f	i	g	?					S	T	C	O	N	F	I	G					S	E	N	S	O	R	T	E	M	P	?						S	T	C	O	N	F	I	G					S	F	C	W	O	R	K	I	N	G	.	.	.		S	E	N	S	O	R	T	E	M	P	.				1	6	.	2	9	6	°	C						
		S	T	C	O	N	F	I	G																																																																																																																																				
C	O	N	F	O	R	M	I	T	Y	?																																																																																																																																			
		S	T	C	O	N	F	I	G																																																																																																																																				
M	e	t	e	r	C	o	n	f	i	g	?																																																																																																																																		
		S	T	C	O	N	F	I	G																																																																																																																																				
S	E	N	S	O	R	T	E	M	P	?																																																																																																																																			
		S	T	C	O	N	F	I	G																																																																																																																																				
S	F	C	W	O	R	K	I	N	G	.	.	.																																																																																																																																	
S	E	N	S	O	R	T	E	M	P	.																																																																																																																																			
1	6	.	2	9	6	°	C																																																																																																																																						
<p>the present message in the scratch pad area of memory</p>	<div style="display: flex; flex-direction: column; gap: 10px;"> <div>  <table border="1" data-bbox="971 976 1385 1039"> <tr><td>L</td><td>I</td><td>N</td><td></td><td>D</td><td>P</td><td>P</td><td>T</td><td></td><td>3</td><td>0</td><td>1</td><td>1</td><td></td></tr> <tr><td></td><td></td><td></td><td></td><td>S</td><td>H</td><td>I</td><td>F</td><td>T</td><td>-</td><td></td><td></td><td></td><td></td></tr> </table> </div> <div> <p>SCR PAD</p>  <table border="1" data-bbox="971 1079 1385 1142"> <tr><td>S</td><td>C</td><td>R</td><td>P</td><td>A</td><td>D</td><td>P</td><td>T</td><td></td><td>3</td><td>0</td><td>1</td><td>1</td><td></td></tr> <tr><td>S</td><td>F</td><td>C</td><td>W</td><td>O</td><td>R</td><td>K</td><td>I</td><td>N</td><td>G</td><td>.</td><td>.</td><td>.</td><td></td></tr> </table> <table border="1" data-bbox="971 1169 1385 1232"> <tr><td>S</td><td>C</td><td>R</td><td>A</td><td>T</td><td>C</td><td>H</td><td>P</td><td>A</td><td>D</td><td></td><td>1</td><td></td><td></td></tr> <tr><td>C</td><td>A</td><td>L</td><td>I</td><td>B</td><td>O</td><td>N</td><td></td><td>3</td><td>/</td><td>2</td><td>2</td><td>/</td><td>9</td><td>3</td></tr> </table> </div> <div>  <table border="1" data-bbox="971 1266 1385 1329"> <tr><td>S</td><td>C</td><td>R</td><td>A</td><td>T</td><td>C</td><td>H</td><td>P</td><td>A</td><td>D</td><td></td><td>2</td><td></td><td></td></tr> <tr><td>B</td><td>Y</td><td>J</td><td>O</td><td>H</td><td>N</td><td></td><td>2</td><td>n</td><td>d</td><td>S</td><td>H</td><td>F</td><td>T</td></tr> </table> </div> </div>	L	I	N		D	P	P	T		3	0	1	1						S	H	I	F	T	-					S	C	R	P	A	D	P	T		3	0	1	1		S	F	C	W	O	R	K	I	N	G	.	.	.		S	C	R	A	T	C	H	P	A	D		1			C	A	L	I	B	O	N		3	/	2	2	/	9	3	S	C	R	A	T	C	H	P	A	D		2			B	Y	J	O	H	N		2	n	d	S	H	F	T																											
L	I	N		D	P	P	T		3	0	1	1																																																																																																																																	
				S	H	I	F	T	-																																																																																																																																				
S	C	R	P	A	D	P	T		3	0	1	1																																																																																																																																	
S	F	C	W	O	R	K	I	N	G	.	.	.																																																																																																																																	
S	C	R	A	T	C	H	P	A	D		1																																																																																																																																		
C	A	L	I	B	O	N		3	/	2	2	/	9	3																																																																																																																															
S	C	R	A	T	C	H	P	A	D		2																																																																																																																																		
B	Y	J	O	H	N		2	n	d	S	H	F	T																																																																																																																																
<p>the PROM serial number</p>	<div style="display: flex; flex-direction: column; gap: 10px;"> <div>  <table border="1" data-bbox="971 1375 1385 1438"> <tr><td></td><td></td><td>S</td><td>T</td><td>C</td><td>O</td><td>N</td><td>F</td><td>I</td><td>G</td><td></td><td></td><td></td><td></td></tr> <tr><td>C</td><td>O</td><td>N</td><td>F</td><td>O</td><td>R</td><td>M</td><td>I</td><td>T</td><td>Y</td><td>?</td><td></td><td></td><td></td></tr> </table> </div> <div>  <table border="1" data-bbox="971 1457 1385 1520"> <tr><td></td><td></td><td>S</td><td>T</td><td>C</td><td>O</td><td>N</td><td>F</td><td>I</td><td>G</td><td></td><td></td><td></td><td></td></tr> <tr><td>M</td><td>e</td><td>t</td><td>e</td><td>r</td><td>C</td><td>o</td><td>n</td><td>f</td><td>i</td><td>g</td><td>?</td><td></td><td></td></tr> </table> </div> <div>  <table border="1" data-bbox="971 1558 1385 1621"> <tr><td></td><td></td><td>S</td><td>T</td><td>C</td><td>O</td><td>N</td><td>F</td><td>I</td><td>G</td><td></td><td></td><td></td><td></td></tr> <tr><td>S</td><td>E</td><td>N</td><td>S</td><td>O</td><td>R</td><td>T</td><td>E</td><td>M</td><td>P</td><td>?</td><td></td><td></td><td></td></tr> </table> </div> <div>  <table border="1" data-bbox="971 1659 1385 1722"> <tr><td></td><td></td><td>S</td><td>T</td><td>C</td><td>O</td><td>N</td><td>F</td><td>I</td><td>G</td><td></td><td></td><td></td><td></td></tr> <tr><td>S</td><td>E</td><td>R</td><td>#</td><td></td><td>1</td><td>Ø</td><td>7</td><td>7</td><td>5</td><td>1</td><td>2</td><td>Ø</td><td>Ø</td></tr> </table> </div> </div>			S	T	C	O	N	F	I	G					C	O	N	F	O	R	M	I	T	Y	?						S	T	C	O	N	F	I	G					M	e	t	e	r	C	o	n	f	i	g	?					S	T	C	O	N	F	I	G					S	E	N	S	O	R	T	E	M	P	?						S	T	C	O	N	F	I	G					S	E	R	#		1	Ø	7	7	5	1	2	Ø	Ø																												
		S	T	C	O	N	F	I	G																																																																																																																																				
C	O	N	F	O	R	M	I	T	Y	?																																																																																																																																			
		S	T	C	O	N	F	I	G																																																																																																																																				
M	e	t	e	r	C	o	n	f	i	g	?																																																																																																																																		
		S	T	C	O	N	F	I	G																																																																																																																																				
S	E	N	S	O	R	T	E	M	P	?																																																																																																																																			
		S	T	C	O	N	F	I	G																																																																																																																																				
S	E	R	#		1	Ø	7	7	5	1	2	Ø	Ø																																																																																																																																

8.3 Changing Default Failsafe Direction

Background

Transmitters are shipped with a default failsafe direction of upscale. This means that the transmitter's output will be driven upscale (maximum output) when the transmitter detects a critical status.

You can change the direction from upscale to downscale (minimum output) by cutting jumper W1 on the Printed Wiring Assembly (PWA)

Analog and DE mode differences

If your transmitter is operating in the analog mode, an upscale failsafe action will drive the transmitter's output to greater than 21 mA or a downscale action will drive its output to less than 3.8 mA.

If your transmitter is operating in the DE mode, an upscale failsafe action will cause the transmitter to generate a "+ infinity" digital signal, or a downscale failsafe action will cause it to generate a "- infinity" digital signal. The STIMV IOP module interprets either signal as "not a number" and initiates its own configured failsafe action for the control system. The STDC card initiates the failsafe mode configured through the transmitter when either signal is generated.

ATTENTION

The failsafe direction display that you can access through the SFC only shows the state of the failsafe jumper in the transmitter as it correlates to analog transmitter operation. The failsafe action of the digital control system may be configured to operate differently than indicated by the state of the jumper in the transmitter.

Procedure

The procedure in Table 47 outlines the steps for cutting the failsafe direction jumper on the transmitter's PWA. Figure 49 shows the location of the failsafe direction jumper on the PWA of, Release 300 transmitters.



The nature of the integrated circuitry used in the transmitter's PWA makes it susceptible to damage by stray static discharges when it is removed from the transmitter. Follow these tips to minimize chances of static electricity damage when handling the PWA.

- Never touch terminals, connectors, component leads, or circuits when handling the PWA.
 - When removing or installing the PWA, hold it by its edges or bracket section only. If you must touch the PWA circuits, be sure you are grounded by staying in contact with a grounded surface or wearing a grounded wrist strap.
 - As soon as the PWA is removed from the transmitter, put it in an electrically conductive bag or wrap it in aluminum foil to protect it.
-

Continued on next page

8.3 Changing Default Failsafe Direction, Continued

Procedure, continued

Table 47 Cutting Failsafe Direction Jumper

Step	Action
1	Turn OFF transmitter power. Loosen end-cap lock and unscrew end cap from electronics side of transmitter housing.
2	If applicable, carefully turn Local Smart Meter counterclockwise to remove it from PWA mounting bracket and unplug cable from connector on back of meter assembly. Loosen two retaining screws and carefully pull mounting bracket and PWA from housing. Unplug flex tape and power connectors from component side of PWA, and remove PWA.
3	With component side of PWA facing you, locate failsafe direction jumper W1 and cut it in half with small wire cutter such as dykes. See Figure 48. This changes failsafe action from upscale to downscale.
4	Reverse applicable previous steps to replace PWA.
5	Turn ON transmitter power.

Figure 49 Location of Failsafe Direction Jumper on PWA.

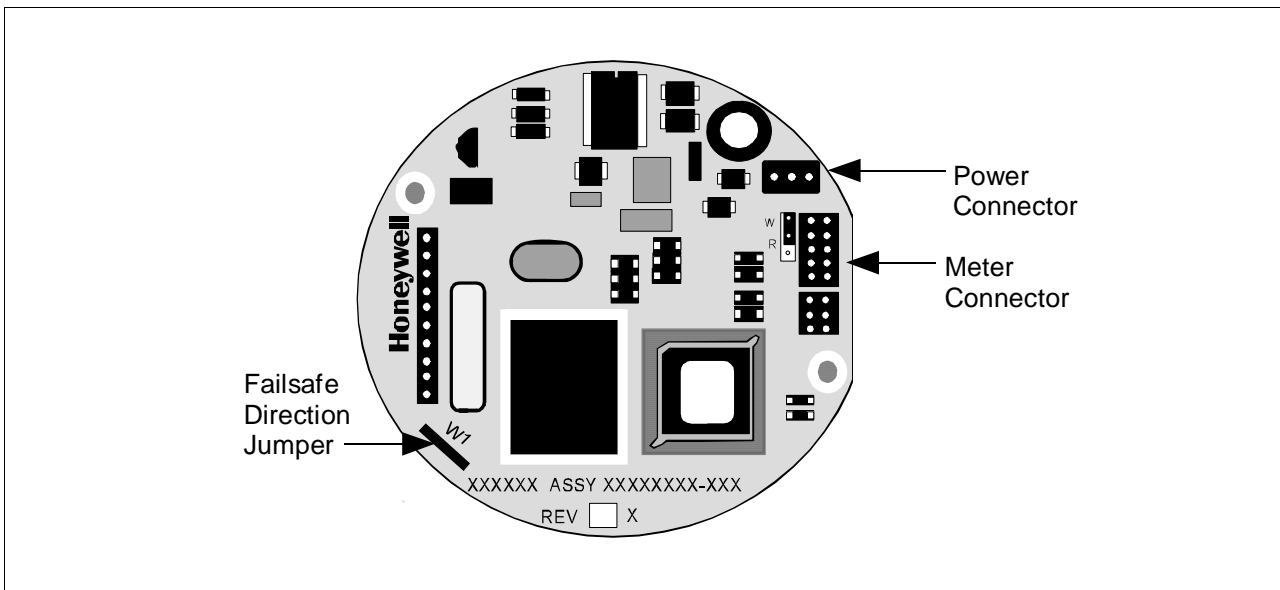

8.4 Writing Data in Scratch Pad Area







Background

You can enter or edit a message in the scratch pad area of memory consisting of two groups of 16 characters each through the SFC.

Procedure

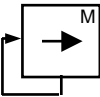
The procedure in Table 48 outlines the steps for editing a sample message in the scratch pad area. This procedure assumes that SFC communications have been established with the transmitter by pressing the [ID] key

Table 48 Writing Data in Scratch Pad Area





Step	Press Key	Read Display or Action	Description																																																																
1		<table border="1"><tr><td>L</td><td>I</td><td>N</td><td></td><td>D</td><td>P</td><td>P</td><td>T</td><td>3</td><td>0</td><td>1</td><td>1</td><td></td><td></td><td></td><td></td></tr><tr><td></td><td></td><td></td><td></td><td>S</td><td>H</td><td>I</td><td>F</td><td>T</td><td>-</td><td></td><td></td><td></td><td></td><td></td><td></td></tr></table>	L	I	N		D	P	P	T	3	0	1	1									S	H	I	F	T	-							Initiate shift key selection.																																
	L	I	N		D	P	P	T	3	0	1	1																																																							
				S	H	I	F	T	-																																																										
		<table border="1"><tr><td>S</td><td>C</td><td>R</td><td></td><td>P</td><td>A</td><td>D</td><td></td><td>P</td><td>T</td><td>3</td><td>0</td><td>1</td><td>1</td><td></td><td></td></tr><tr><td>S</td><td>F</td><td>C</td><td></td><td>W</td><td>O</td><td>R</td><td>K</td><td>I</td><td>N</td><td>G</td><td>.</td><td>.</td><td>.</td><td></td><td></td></tr><tr><td>S</td><td>C</td><td>R</td><td>A</td><td>T</td><td>C</td><td>H</td><td></td><td>P</td><td>A</td><td>D</td><td>1</td><td></td><td></td><td></td><td></td></tr><tr><td>C</td><td>A</td><td>L</td><td>I</td><td>B</td><td></td><td>O</td><td>N</td><td>3</td><td>/</td><td>2</td><td>2</td><td>/</td><td>9</td><td>3</td><td></td></tr></table>	S	C	R		P	A	D		P	T	3	0	1	1			S	F	C		W	O	R	K	I	N	G	.	.	.			S	C	R	A	T	C	H		P	A	D	1					C	A	L	I	B		O	N	3	/	2	2	/	9	3		Call up first group of 16 characters.
S	C	R		P	A	D		P	T	3	0	1	1																																																						
S	F	C		W	O	R	K	I	N	G	.	.	.																																																						
S	C	R	A	T	C	H		P	A	D	1																																																								
C	A	L	I	B		O	N	3	/	2	2	/	9	3																																																					
2		<table border="1"><tr><td>S</td><td>C</td><td>R</td><td>A</td><td>T</td><td>C</td><td>H</td><td></td><td>P</td><td>A</td><td>D</td><td>2</td><td></td><td></td><td></td><td></td></tr><tr><td>B</td><td>Y</td><td></td><td>J</td><td>O</td><td>H</td><td>N</td><td></td><td>2</td><td>n</td><td>d</td><td>S</td><td>H</td><td>F</td><td>T</td><td></td></tr></table>	S	C	R	A	T	C	H		P	A	D	2					B	Y		J	O	H	N		2	n	d	S	H	F	T		Call up second group of 16 characters																																
S	C	R	A	T	C	H		P	A	D	2																																																								
B	Y		J	O	H	N		2	n	d	S	H	F	T																																																					
3		<table border="1"><tr><td>S</td><td>C</td><td>R</td><td>A</td><td>T</td><td>C</td><td>H</td><td></td><td>P</td><td>A</td><td>D</td><td>2</td><td></td><td></td><td></td><td></td></tr><tr><td>B</td><td>Y</td><td></td><td>J</td><td>O</td><td>H</td><td>N</td><td></td><td>2</td><td>n</td><td>d</td><td>S</td><td>H</td><td>F</td><td>T</td><td></td></tr></table>	S	C	R	A	T	C	H		P	A	D	2					B	Y		J	O	H	N		2	n	d	S	H	F	T		Move cursor to 6th character "H". Cursor moves one character space to right with each press. Use [←] key to move cursor one character space to left with each press. Note that cursor keys will automatically toggle between pad 1 and 2 when moving forward or backward through message as applicable.																																
S	C	R	A	T	C	H		P	A	D	2																																																								
B	Y		J	O	H	N		2	n	d	S	H	F	T																																																					
4		<table border="1"><tr><td>S</td><td>C</td><td>R</td><td>A</td><td>T</td><td>C</td><td>H</td><td></td><td>P</td><td>A</td><td>D</td><td>2</td><td></td><td></td><td></td><td></td></tr><tr><td>B</td><td>Y</td><td></td><td>J</td><td>O</td><td>*</td><td>N</td><td></td><td>2</td><td>n</td><td>d</td><td>S</td><td>H</td><td>F</td><td>T</td><td></td></tr></table>	S	C	R	A	T	C	H		P	A	D	2					B	Y		J	O	*	N		2	n	d	S	H	F	T		Enter alpha mode so you can use SFC keyboard to enter alphabetic characters.																																
S	C	R	A	T	C	H		P	A	D	2																																																								
B	Y		J	O	*	N		2	n	d	S	H	F	T																																																					
5		<table border="1"><tr><td>S</td><td>C</td><td>R</td><td>A</td><td>T</td><td>C</td><td>H</td><td></td><td>P</td><td>A</td><td>D</td><td>2</td><td></td><td></td><td></td><td></td></tr><tr><td>B</td><td>Y</td><td></td><td>J</td><td>O</td><td>E</td><td>*</td><td></td><td>2</td><td>n</td><td>d</td><td>S</td><td>H</td><td>F</td><td>T</td><td></td></tr></table>	S	C	R	A	T	C	H		P	A	D	2					B	Y		J	O	E	*		2	n	d	S	H	F	T		Key in "E" and "space" to change name from JOHN to JOE																																
	S	C	R	A	T	C	H		P	A	D	2																																																							
B	Y		J	O	E	*		2	n	d	S	H	F	T																																																					
	<table border="1"><tr><td>S</td><td>C</td><td>R</td><td>A</td><td>T</td><td>C</td><td>H</td><td></td><td>P</td><td>A</td><td>D</td><td>2</td><td></td><td></td><td></td><td></td></tr><tr><td>B</td><td>Y</td><td></td><td>J</td><td>O</td><td>E</td><td></td><td>*</td><td>2</td><td>n</td><td>d</td><td>S</td><td>H</td><td>F</td><td>T</td><td></td></tr></table>	S	C	R	A	T	C	H		P	A	D	2					B	Y		J	O	E		*	2	n	d	S	H	F	T																																			
S	C	R	A	T	C	H		P	A	D	2																																																								
B	Y		J	O	E		*	2	n	d	S	H	F	T																																																					
6		<table border="1"><tr><td>S</td><td>C</td><td>R</td><td>A</td><td>T</td><td>C</td><td>H</td><td></td><td>P</td><td>A</td><td>D</td><td>2</td><td></td><td></td><td></td><td></td></tr><tr><td>B</td><td>Y</td><td></td><td>J</td><td>O</td><td>E</td><td></td><td>-</td><td>2</td><td>n</td><td>d</td><td>S</td><td>H</td><td>F</td><td>T</td><td></td></tr></table>	S	C	R	A	T	C	H		P	A	D	2					B	Y		J	O	E		-	2	n	d	S	H	F	T		Exit alpha mode.																																
S	C	R	A	T	C	H		P	A	D	2																																																								
B	Y		J	O	E		-	2	n	d	S	H	F	T																																																					

Continued on next page

8.4 Writing Data in Scratch Pad Area, Continued

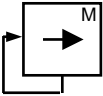
Procedure, continued

Table 48 Writing Data in Scratch Pad Area, continued

Step	Press Key	Read Display or Action	Description																																																																																										
7		<table border="1" style="font-family: monospace; font-size: small;"> <tr><td>S</td><td>C</td><td>R</td><td>A</td><td>T</td><td>C</td><td>H</td><td>P</td><td>A</td><td>D</td><td>1</td><td></td><td></td><td></td><td></td></tr> <tr><td>C</td><td>A</td><td>L</td><td>I</td><td>B</td><td></td><td>O</td><td>N</td><td>3</td><td>/</td><td>2</td><td>2</td><td>/</td><td>9</td><td>3</td></tr> </table>	S	C	R	A	T	C	H	P	A	D	1					C	A	L	I	B		O	N	3	/	2	2	/	9	3	Return to first group of 16 characters.																																																												
S	C	R	A	T	C	H	P	A	D	1																																																																																			
C	A	L	I	B		O	N	3	/	2	2	/	9	3																																																																															
8		<table border="1" style="font-family: monospace; font-size: small;"> <tr><td>S</td><td>C</td><td>R</td><td>A</td><td>T</td><td>C</td><td>H</td><td>P</td><td>A</td><td>D</td><td>1</td><td></td><td></td><td></td><td></td></tr> <tr><td>C</td><td>A</td><td>L</td><td>I</td><td>B</td><td></td><td>O</td><td>N</td><td><u>3</u></td><td>/</td><td>2</td><td>2</td><td>/</td><td>9</td><td>3</td></tr> </table>	S	C	R	A	T	C	H	P	A	D	1					C	A	L	I	B		O	N	<u>3</u>	/	2	2	/	9	3	Move cursor to 10th character "3".																																																												
S	C	R	A	T	C	H	P	A	D	1																																																																																			
C	A	L	I	B		O	N	<u>3</u>	/	2	2	/	9	3																																																																															
9	SEC VAR 	<table border="1" style="font-family: monospace; font-size: small;"> <tr><td>S</td><td>C</td><td>R</td><td>A</td><td>T</td><td>C</td><td>H</td><td>P</td><td>A</td><td>D</td><td>1</td><td></td><td></td><td></td><td></td></tr> <tr><td>C</td><td>A</td><td>L</td><td>I</td><td>B</td><td></td><td>O</td><td>N</td><td>6</td><td>/</td><td>2</td><td>2</td><td>/</td><td>9</td><td>3</td></tr> </table>	S	C	R	A	T	C	H	P	A	D	1					C	A	L	I	B		O	N	6	/	2	2	/	9	3	Change "3" to "6" to reflect revised calibration date.																																																												
S	C	R	A	T	C	H	P	A	D	1																																																																																			
C	A	L	I	B		O	N	6	/	2	2	/	9	3																																																																															
10	NON-VOL  OR 	<table border="1" style="font-family: monospace; font-size: small;"> <tr><td>S</td><td>C</td><td>R</td><td></td><td>P</td><td>A</td><td>D</td><td></td><td></td><td></td><td></td><td></td><td></td><td></td><td></td></tr> <tr><td>S</td><td>F</td><td>C</td><td></td><td>W</td><td>O</td><td>R</td><td>K</td><td>I</td><td>N</td><td>G</td><td>.</td><td>.</td><td>.</td><td></td></tr> </table> <table border="1" style="font-family: monospace; font-size: small;"> <tr><td>S</td><td>C</td><td>R</td><td>A</td><td>T</td><td>C</td><td>H</td><td>P</td><td>A</td><td>D</td><td>1</td><td></td><td></td><td></td><td></td></tr> <tr><td>C</td><td>A</td><td>L</td><td>I</td><td>B</td><td></td><td>O</td><td>N</td><td>6</td><td>/</td><td>2</td><td>2</td><td>/</td><td>9</td><td>3</td></tr> </table> <table border="1" style="font-family: monospace; font-size: small;"> <tr><td>L</td><td>I</td><td>N</td><td></td><td>D</td><td>P</td><td>P</td><td>T</td><td>3</td><td>0</td><td>1</td><td>1</td><td></td><td></td><td></td></tr> <tr><td></td><td>R</td><td>E</td><td>A</td><td>D</td><td>Y</td><td>.</td><td>.</td><td>.</td><td></td><td></td><td></td><td></td><td></td><td></td></tr> </table>	S	C	R		P	A	D									S	F	C		W	O	R	K	I	N	G	.	.	.		S	C	R	A	T	C	H	P	A	D	1					C	A	L	I	B		O	N	6	/	2	2	/	9	3	L	I	N		D	P	P	T	3	0	1	1					R	E	A	D	Y	.	.	.							Save changes in message. Exit scratch pad without saving changes in message.
S	C	R		P	A	D																																																																																							
S	F	C		W	O	R	K	I	N	G	.	.	.																																																																																
S	C	R	A	T	C	H	P	A	D	1																																																																																			
C	A	L	I	B		O	N	6	/	2	2	/	9	3																																																																															
L	I	N		D	P	P	T	3	0	1	1																																																																																		
	R	E	A	D	Y	.	.	.																																																																																					

8.5 Saving and Restoring a Database

Background

If it ever became necessary to replace a damaged transmitter with a spare, you could save the configuration database from the damaged transmitter to the HOLD memory in the SFC and then restore the saved configuration database from the HOLD memory in the spare transmitter. In fact, you could restore the saved configuration database in any number of transmitters as long as you change the tag number (ID) in the restored database.

NOTE: The configuration data for the optional Local Smart Meter is stored in a memory located on the transmitter's PWA. If a database save and restore is done with the SFC, then the meter configuration is restored along with the transmitter configuration.

Figure 50 shows a graphical summation of the save and restore database function.

Figure 50 Summary of Save and Restore Database Function.

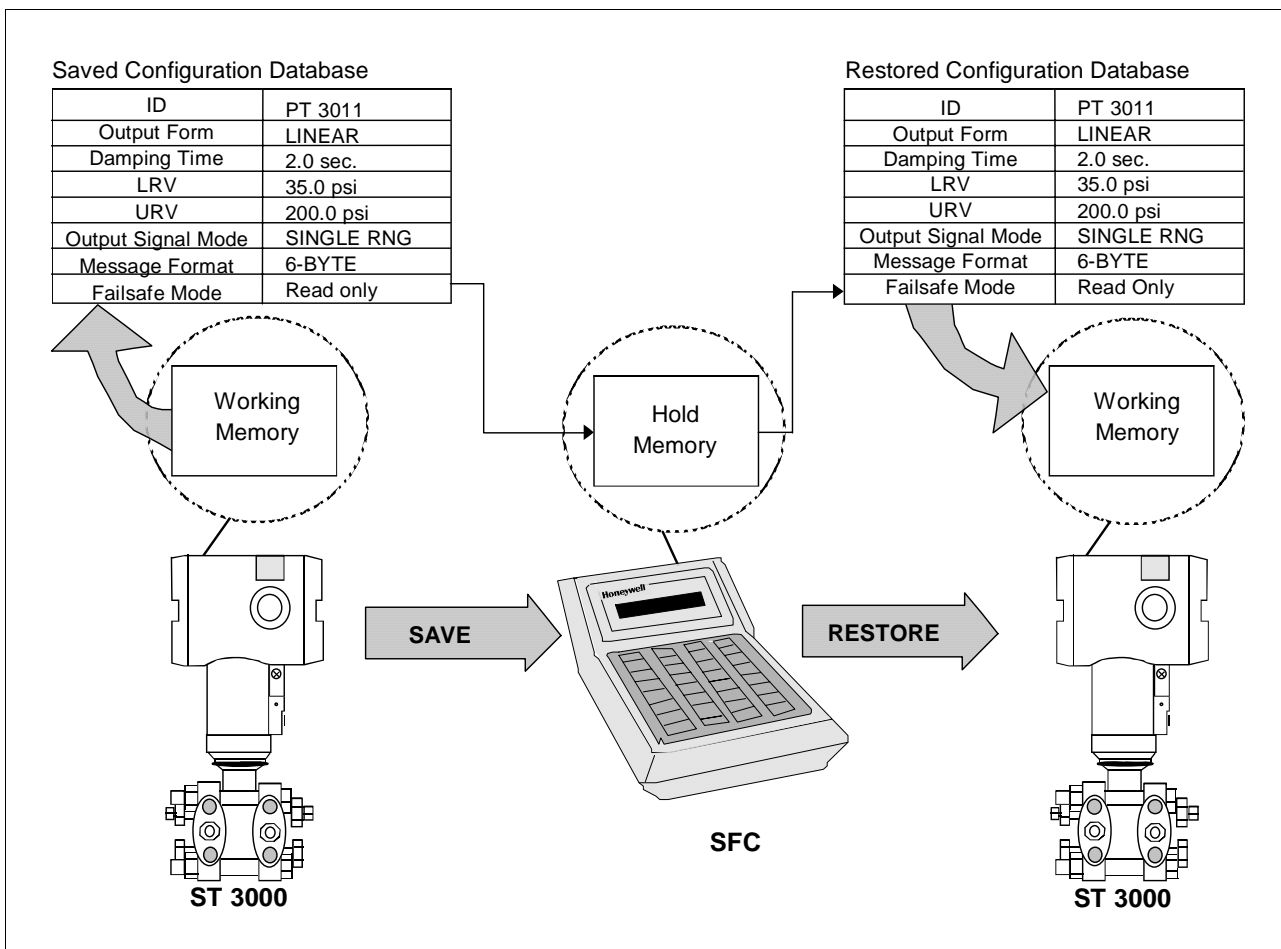

Continued on next page

8.5 Saving and Restoring a Database, Continued

Procedure

The procedure in Table 49 outlines the steps for saving a database from one transmitter and restoring it in another.

Table 49 Saving and Restoring a Database

Step	Press Key	Read Display or Action	Description
1		Connect SFC across loop wiring for transmitter with database to be saved and turn it on.	Be sure to put analog loop into manual mode.
2	DE READ A ID	T A G N O . T R I P S S E C U R E D ? ?	Be sure any switches that may trip alarms or interlocks associated with analog loop are secured or turned off.
3	NON-VOL ENTER (Yes)	T A G N O . S F C W O R K I N G . . . L I N D P T A G N O . P T 3 0 1 1	Confirm that "TRIPS" are secured and establish communications with sample transmitter PT 3011
4	B CONF	S T C O N F I G C O N F O R M I T Y ?	Call up first configuration parameter.
5	H NEXT	S T C O N F I G M e t e r C o n f i g ?	Call up next configuration parameter.
6	H NEXT	S T C O N F I G S E N S O R T E M P ?	Call up next configuration parameter.
7	H NEXT	S T C O N F I G S E R # 1 0 7 7 5 1 2 0 0	Call up next configuration parameter.
8	H NEXT	S T C O N F I G S A V E R E S T O R E ?	Call up save/restore function.
9	NON-VOL ENTER (Yes)	S A V E / R E S T O R E S A V E D A T A ?	Prompt asks if you want to save database from this transmitter.
10	NON-VOL ENTER (Yes)	S A V E D A T A A R E Y O U S U R E ?	Prompt asks for confirmation of database save function.

Continued on next page

8.5 Saving and Restoring a Database, Continued

Procedure, continued

Table 49 Saving and Restoring a Database, continued







Step	Press Key	Read Display or Action	Description																																																																																																												
11	NON-VOL ENTER (Yes)	<table border="1"> <tr><td>S</td><td>A</td><td>V</td><td>E</td><td>D</td><td>A</td><td>T</td><td>A</td><td></td><td></td><td></td><td></td><td></td><td></td><td></td><td></td><td></td><td></td></tr> <tr><td>S</td><td>F</td><td>C</td><td></td><td>W</td><td>O</td><td>R</td><td>K</td><td>I</td><td>N</td><td>G</td><td>.</td><td>.</td><td>.</td><td></td><td></td><td></td><td></td></tr> </table> <table border="1"> <tr><td>S</td><td>A</td><td>V</td><td>E</td><td>D</td><td>A</td><td>T</td><td>A</td><td></td><td></td><td></td><td></td><td></td><td></td><td></td><td></td><td></td><td></td></tr> <tr><td>D</td><td>A</td><td>T</td><td>A</td><td>S</td><td>A</td><td>V</td><td>E</td><td>D</td><td></td><td></td><td></td><td></td><td></td><td></td><td></td><td></td><td></td></tr> </table> <table border="1"> <tr><td>S</td><td>A</td><td>V</td><td>E</td><td>/</td><td>R</td><td>E</td><td>S</td><td>T</td><td>O</td><td>R</td><td>E</td><td></td><td></td><td></td><td></td><td></td><td></td></tr> <tr><td>S</td><td>A</td><td>V</td><td>E</td><td>D</td><td>A</td><td>T</td><td>A</td><td>?</td><td></td><td></td><td></td><td></td><td></td><td></td><td></td><td></td><td></td></tr> </table>	S	A	V	E	D	A	T	A											S	F	C		W	O	R	K	I	N	G	.	.	.					S	A	V	E	D	A	T	A											D	A	T	A	S	A	V	E	D										S	A	V	E	/	R	E	S	T	O	R	E							S	A	V	E	D	A	T	A	?										<p>Answer yes to prompt and initiate database save function.</p> <p>Database saved to SFC HOLD memory.</p>
S	A	V	E	D	A	T	A																																																																																																								
S	F	C		W	O	R	K	I	N	G	.	.	.																																																																																																		
S	A	V	E	D	A	T	A																																																																																																								
D	A	T	A	S	A	V	E	D																																																																																																							
S	A	V	E	/	R	E	S	T	O	R	E																																																																																																				
S	A	V	E	D	A	T	A	?																																																																																																							
12		<p>Disconnect SFC and connect it to loop wiring for transmitter whose database is to be restored.</p> <p>ATTENTION Be sure to leave SFC power on. The saved database will be lost if the SFC power is turned off.</p>	<p>Be sure to put analog loop into manual mode.</p>																																																																																																												
13	DE READ A ID	<table border="1"> <tr><td>T</td><td>A</td><td>G</td><td></td><td>N</td><td>O</td><td>.</td><td></td><td></td><td></td><td></td><td></td><td></td><td></td><td></td><td></td><td></td><td></td></tr> <tr><td>T</td><td>R</td><td>I</td><td>P</td><td>S</td><td></td><td>S</td><td>E</td><td>C</td><td>U</td><td>R</td><td>E</td><td>D</td><td>?</td><td>?</td><td></td><td></td><td></td></tr> </table>	T	A	G		N	O	.												T	R	I	P	S		S	E	C	U	R	E	D	?	?				<p>Be sure any switches that may trip alarms or interlocks associated with analog loop are secured or turned off.</p>																																																																								
T	A	G		N	O	.																																																																																																									
T	R	I	P	S		S	E	C	U	R	E	D	?	?																																																																																																	
14	NON-VOL ENTER (Yes)	<table border="1"> <tr><td>T</td><td>A</td><td>G</td><td></td><td>N</td><td>O</td><td>.</td><td></td><td></td><td></td><td></td><td></td><td></td><td></td><td></td><td></td><td></td><td></td></tr> <tr><td>S</td><td>F</td><td>C</td><td></td><td>W</td><td>O</td><td>R</td><td>K</td><td>I</td><td>N</td><td>G</td><td>.</td><td>.</td><td>.</td><td></td><td></td><td></td><td></td></tr> </table> <table border="1"> <tr><td>L</td><td>I</td><td>N</td><td></td><td>D</td><td>P</td><td></td><td>T</td><td>A</td><td>G</td><td></td><td>N</td><td>O</td><td>.</td><td></td><td></td><td></td><td></td></tr> <tr><td></td><td></td><td></td><td></td><td></td><td></td><td></td><td>-</td><td></td><td></td><td></td><td></td><td></td><td></td><td></td><td></td><td></td><td></td></tr> </table>	T	A	G		N	O	.												S	F	C		W	O	R	K	I	N	G	.	.	.					L	I	N		D	P		T	A	G		N	O	.												-											<p>Confirm that "TRIPS" are secured and establish communications with sample transmitter without a tag number (ID) whose database is to be restored.</p>																																				
T	A	G		N	O	.																																																																																																									
S	F	C		W	O	R	K	I	N	G	.	.	.																																																																																																		
L	I	N		D	P		T	A	G		N	O	.																																																																																																		
							-																																																																																																								
15	B CONF	<table border="1"> <tr><td></td><td></td><td>S</td><td>T</td><td>C</td><td>O</td><td>N</td><td>F</td><td>I</td><td>G</td><td></td><td></td><td></td><td></td><td></td><td></td><td></td><td></td></tr> <tr><td>C</td><td>O</td><td>N</td><td>F</td><td>O</td><td>R</td><td>M</td><td>I</td><td>T</td><td>Y</td><td>?</td><td></td><td></td><td></td><td></td><td></td><td></td><td></td></tr> </table>			S	T	C	O	N	F	I	G									C	O	N	F	O	R	M	I	T	Y	?								<p>Call up first configuration parameter.</p>																																																																								
		S	T	C	O	N	F	I	G																																																																																																						
C	O	N	F	O	R	M	I	T	Y	?																																																																																																					
16	H NEXT	<table border="1"> <tr><td></td><td></td><td>S</td><td>T</td><td>C</td><td>O</td><td>N</td><td>F</td><td>I</td><td>G</td><td></td><td></td><td></td><td></td><td></td><td></td><td></td><td></td></tr> <tr><td>M</td><td>e</td><td>t</td><td>e</td><td>r</td><td></td><td>C</td><td>o</td><td>n</td><td>f</td><td>i</td><td>g</td><td>?</td><td></td><td></td><td></td><td></td><td></td></tr> </table>			S	T	C	O	N	F	I	G									M	e	t	e	r		C	o	n	f	i	g	?						<p>Call up next configuration parameter.</p>																																																																								
		S	T	C	O	N	F	I	G																																																																																																						
M	e	t	e	r		C	o	n	f	i	g	?																																																																																																			
17	H NEXT	<table border="1"> <tr><td></td><td></td><td>S</td><td>T</td><td>C</td><td>O</td><td>N</td><td>F</td><td>I</td><td>G</td><td></td><td></td><td></td><td></td><td></td><td></td><td></td><td></td></tr> <tr><td>S</td><td>E</td><td>N</td><td>S</td><td>O</td><td>R</td><td></td><td>T</td><td>E</td><td>M</td><td>P</td><td>?</td><td></td><td></td><td></td><td></td><td></td><td></td></tr> </table>			S	T	C	O	N	F	I	G									S	E	N	S	O	R		T	E	M	P	?							<p>Call up next configuration parameter.</p>																																																																								
		S	T	C	O	N	F	I	G																																																																																																						
S	E	N	S	O	R		T	E	M	P	?																																																																																																				
18	H NEXT	<table border="1"> <tr><td></td><td></td><td>S</td><td>T</td><td>C</td><td>O</td><td>N</td><td>F</td><td>I</td><td>G</td><td></td><td></td><td></td><td></td><td></td><td></td><td></td><td></td></tr> <tr><td>S</td><td>E</td><td>R</td><td>#</td><td></td><td>1</td><td>Ø</td><td>7</td><td>7</td><td>5</td><td>1</td><td>2</td><td>Ø</td><td>Ø</td><td></td><td></td><td></td><td></td></tr> </table>			S	T	C	O	N	F	I	G									S	E	R	#		1	Ø	7	7	5	1	2	Ø	Ø					<p>Call up next configuration parameter.</p>																																																																								
		S	T	C	O	N	F	I	G																																																																																																						
S	E	R	#		1	Ø	7	7	5	1	2	Ø	Ø																																																																																																		

Continued on next page

8.5 Saving and Restoring a Database, Continued

Procedure, continued

Table 49 Saving and Restoring a Database, continued

Step	Press Key	Read Display or Action	Description																																																																																										
19		<table border="1" style="border-collapse: collapse; text-align: center;"> <tr><td> </td><td> </td><td> </td><td>S</td><td>T</td><td>C</td><td>O</td><td>N</td><td>F</td><td>I</td><td>G</td><td> </td><td> </td><td> </td><td> </td></tr> <tr><td>S</td><td>A</td><td>V</td><td>E</td><td> </td><td>R</td><td>E</td><td>S</td><td>T</td><td>O</td><td>R</td><td>E</td><td>?</td><td> </td><td> </td></tr> </table>				S	T	C	O	N	F	I	G					S	A	V	E		R	E	S	T	O	R	E	?			Call up save/restore function.																																																												
			S	T	C	O	N	F	I	G																																																																																			
S	A	V	E		R	E	S	T	O	R	E	?																																																																																	
20	NON-VOL 	<table border="1" style="border-collapse: collapse; text-align: center;"> <tr><td>S</td><td>A</td><td>V</td><td>E</td><td> </td><td>/</td><td>R</td><td>E</td><td>S</td><td>T</td><td>O</td><td>R</td><td>E</td><td> </td><td> </td></tr> <tr><td>S</td><td>A</td><td>V</td><td>E</td><td> </td><td>D</td><td>A</td><td>T</td><td>A</td><td>?</td><td> </td><td> </td><td> </td><td> </td><td> </td></tr> </table>	S	A	V	E		/	R	E	S	T	O	R	E			S	A	V	E		D	A	T	A	?						Prompt asks if you want to save database from this transmitter.																																																												
S	A	V	E		/	R	E	S	T	O	R	E																																																																																	
S	A	V	E		D	A	T	A	?																																																																																				
21		<table border="1" style="border-collapse: collapse; text-align: center;"> <tr><td>S</td><td>A</td><td>V</td><td>E</td><td> </td><td>/</td><td>R</td><td>E</td><td>S</td><td>T</td><td>O</td><td>R</td><td>E</td><td> </td><td> </td></tr> <tr><td>R</td><td>E</td><td>S</td><td>T</td><td>O</td><td>R</td><td>E</td><td> </td><td>D</td><td>A</td><td>T</td><td>A</td><td>?</td><td> </td><td> </td></tr> </table>	S	A	V	E		/	R	E	S	T	O	R	E			R	E	S	T	O	R	E		D	A	T	A	?			Call up prompt for restore function. It asks if you want to restore saved database in this transmitter.																																																												
S	A	V	E		/	R	E	S	T	O	R	E																																																																																	
R	E	S	T	O	R	E		D	A	T	A	?																																																																																	
22	NON-VOL 	<table border="1" style="border-collapse: collapse; text-align: center;"> <tr><td>R</td><td>E</td><td>S</td><td>T</td><td>O</td><td>R</td><td>E</td><td> </td><td>D</td><td>A</td><td>T</td><td>A</td><td> </td><td> </td><td> </td></tr> <tr><td>A</td><td>R</td><td>E</td><td> </td><td>Y</td><td>O</td><td>U</td><td> </td><td>S</td><td>U</td><td>R</td><td>E</td><td>?</td><td> </td><td> </td></tr> </table>	R	E	S	T	O	R	E		D	A	T	A				A	R	E		Y	O	U		S	U	R	E	?			Prompt asks for confirmation of database restore function.																																																												
R	E	S	T	O	R	E		D	A	T	A																																																																																		
A	R	E		Y	O	U		S	U	R	E	?																																																																																	
23	NON-VOL 	<table border="1" style="border-collapse: collapse; text-align: center;"> <tr><td>R</td><td>E</td><td>S</td><td>T</td><td>O</td><td>R</td><td>E</td><td> </td><td>D</td><td>A</td><td>T</td><td>A</td><td> </td><td> </td><td> </td></tr> <tr><td>S</td><td>F</td><td>C</td><td> </td><td>W</td><td>O</td><td>R</td><td>K</td><td>I</td><td>N</td><td>G</td><td>.</td><td>.</td><td>.</td><td> </td></tr> </table> <table border="1" style="border-collapse: collapse; text-align: center;"> <tr><td>R</td><td>E</td><td>S</td><td>T</td><td>O</td><td>R</td><td>E</td><td> </td><td>D</td><td>A</td><td>T</td><td>A</td><td> </td><td> </td><td> </td></tr> <tr><td>D</td><td>A</td><td>T</td><td>A</td><td> </td><td>R</td><td>E</td><td>S</td><td>T</td><td>O</td><td>R</td><td>E</td><td>D</td><td> </td><td> </td></tr> </table> <table border="1" style="border-collapse: collapse; text-align: center;"> <tr><td>S</td><td>A</td><td>V</td><td>E</td><td> </td><td>/</td><td>R</td><td>E</td><td>S</td><td>T</td><td>O</td><td>R</td><td>E</td><td> </td><td> </td></tr> <tr><td>R</td><td>E</td><td>S</td><td>T</td><td>O</td><td>R</td><td>E</td><td> </td><td>D</td><td>A</td><td>T</td><td>A</td><td>?</td><td> </td><td> </td></tr> </table>	R	E	S	T	O	R	E		D	A	T	A				S	F	C		W	O	R	K	I	N	G	.	.	.		R	E	S	T	O	R	E		D	A	T	A				D	A	T	A		R	E	S	T	O	R	E	D			S	A	V	E		/	R	E	S	T	O	R	E			R	E	S	T	O	R	E		D	A	T	A	?			Answer yes to prompt and initiate database restore function. Saved database has been restored (written) to transmitter's memory.
R	E	S	T	O	R	E		D	A	T	A																																																																																		
S	F	C		W	O	R	K	I	N	G	.	.	.																																																																																
R	E	S	T	O	R	E		D	A	T	A																																																																																		
D	A	T	A		R	E	S	T	O	R	E	D																																																																																	
S	A	V	E		/	R	E	S	T	O	R	E																																																																																	
R	E	S	T	O	R	E		D	A	T	A	?																																																																																	
24		<table border="1" style="border-collapse: collapse; text-align: center;"> <tr><td> </td><td> </td><td> </td><td>S</td><td>T</td><td>C</td><td>O</td><td>N</td><td>F</td><td>I</td><td>G</td><td> </td><td> </td><td> </td><td> </td></tr> <tr><td>S</td><td>A</td><td>V</td><td>E</td><td> </td><td>/</td><td>R</td><td>E</td><td>S</td><td>T</td><td>O</td><td>R</td><td>E</td><td>?</td><td> </td><td> </td></tr> </table>				S	T	C	O	N	F	I	G					S	A	V	E		/	R	E	S	T	O	R	E	?			Return to configuration parameter menu selection.																																																											
			S	T	C	O	N	F	I	G																																																																																			
S	A	V	E		/	R	E	S	T	O	R	E	?																																																																																
25		<table border="1" style="border-collapse: collapse; text-align: center;"> <tr><td>L</td><td>I</td><td>N</td><td> </td><td>D</td><td>P</td><td>P</td><td>T</td><td> </td><td>3</td><td>0</td><td>1</td><td>1</td><td> </td><td> </td></tr> <tr><td>R</td><td>E</td><td>A</td><td>D</td><td>Y</td><td>.</td><td>.</td><td>.</td><td> </td><td> </td><td> </td><td> </td><td> </td><td> </td><td> </td></tr> </table>	L	I	N		D	P	P	T		3	0	1	1			R	E	A	D	Y	.	.	.								Exit configuration and verify that transmitter's ID now reflects ID from restored database. Tag number PT 3011 is used for example purposes only. Change tag number and other configuration data as required.																																																												
L	I	N		D	P	P	T		3	0	1	1																																																																																	
R	E	A	D	Y	.	.	.																																																																																						

8.6 Monitoring Local Smart Meter Display

Display description Figure 51 shows a Local Smart Meter display with all its indicators and segments lit for reference and Table 50 gives a brief description of what the indications mean.

Figure 51 Display With All Indicators Lit.

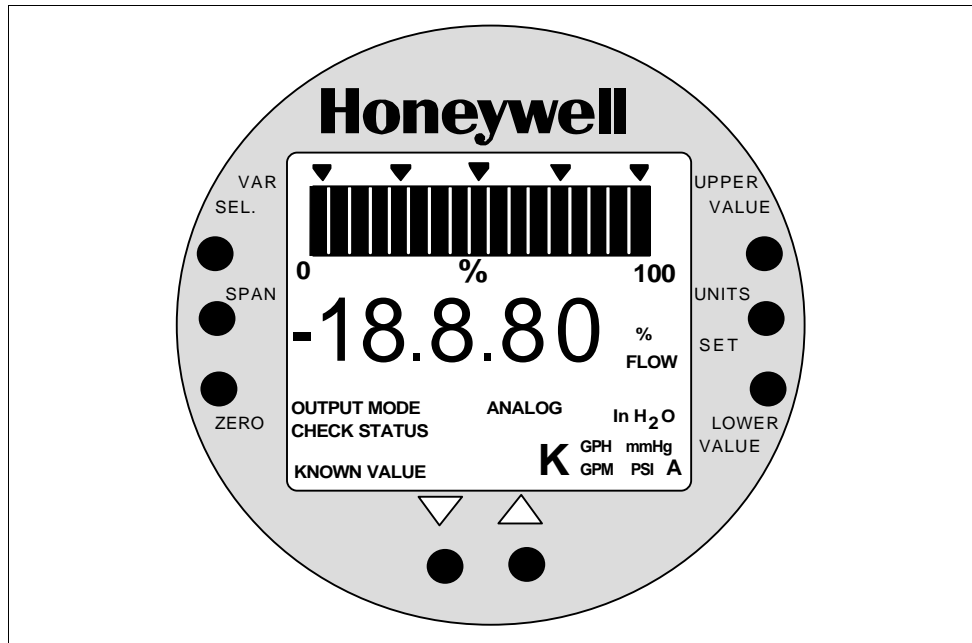

Table 50 Description of Display Indicators Shown in Figure 51

Display Indicator	What It Means When Lit
17-Segment Bargraph	Gives a gross indication of the transmitter's PV output from 0 to 100%.
Digital Readout	Gives an indication of the transmitter's PV output in either percent of span or actual engineering units. The display range is $\pm 19,990,000$ and it is automatically ranged to provide the best precision possible within the limits of the display. A second decimal place expands the precision of range values within ± 19.99 to 1/100th of a unit.
%	Digital readout represents output in percent of span. This is the default engineering units selection.
FLOW	Transmitter is configured for Square Root output conformity.
OUTPUT MODE	Transmitter is in its output mode and it is not sending a real PV signal.
CHECK STATUS	Transmitter in DE mode is broadcasting a critical status or transmitter in Analog mode has an output that is less than -2.0% or greater than 106% . Use the SFC to check transmitter's status.

Continued on next page

8.6 Monitoring Local Smart Meter Display, Continued

Display description,
continued

Table 50 Description of Display Indicators Shown in Figure 51, continued

Display Indicator	What It Means When Lit
KNOWN VALUE	The Upper Value or Lower Value being displayed has previously been configured to the value shown.
ANALOG	Transmitter is in its Analog mode. (When indicator is OFF, transmitter is in its DE mode)
inH2O	Inches of Water is selected engineering units for digital readout
K	Multiplies digital reading by 1,000. Turns on automatically when reading exceeds 1999.
GPH	Gallons per hour is selected engineering units for digital readout. (Note that the FLOW indicator must also be lit to allow this selection.)
GPM	Gallons per minute is selected engineering units for digital readout. (Note that the FLOW indicator must also be lit to allow this selection.)
mmHg	Millimeters of Mercury is selected engineering units for digital readout.
PSI	Pounds per Square Inch is selected engineering units for digital readout.
A	Transmitter is absolute pressure type. Digital readout represents absolute values.
Stick-On Label (not shown)	Selected engineering unit equals one of these units which is available as a stick-on label from Honeywell drawing number 30756918-001. Kpa = Kilopascals Mpa = Megapascals mbar = Millibar bar = Bar g/cm2 = Grams per Square Centimeter Kg/cm2 = Kilograms per Square Centimeter mmH2O = Millimeters of Water inHg = Inches of Mercury mH2O = Meters of Water

Typical operation
indications

Table 51 summarizes typical Local Smart Meter indications. Note that other combinations of status messages are possible.

Continued on next page

8.6 Monitoring Local Smart Meter Display, Continued

Typical operation indications, continued

Table 51 Summary of Typical Local Smart Meter Indications.

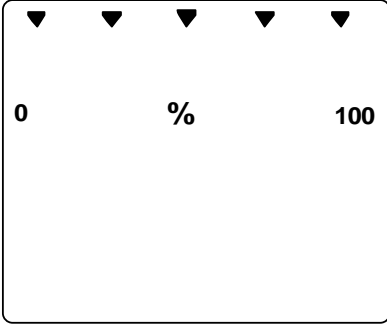
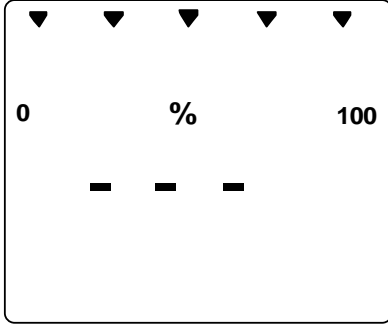
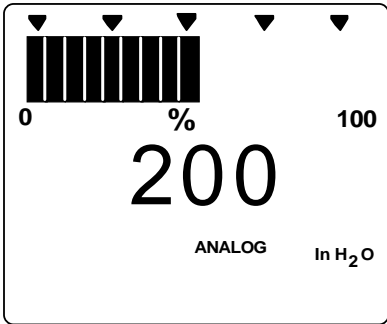
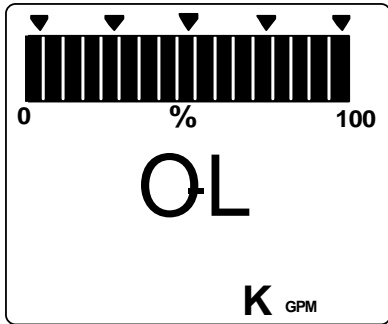
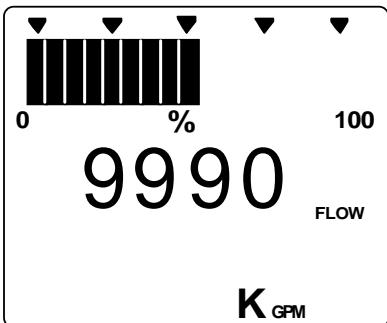
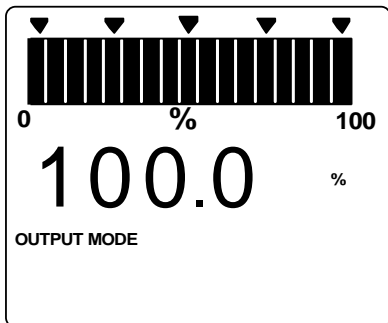
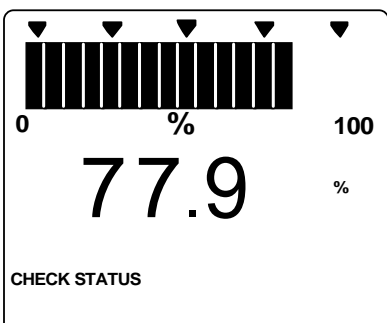
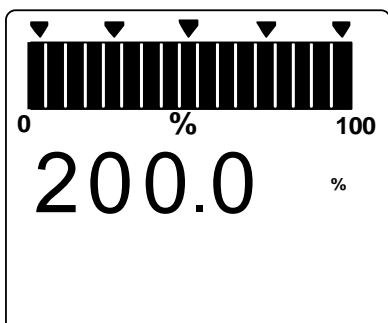
Meter Indication	What It Means	Meter Indication	What It Means
	No power applied.		Meter has detected transmitter output that is not-a-number.
	Normal display for transmitter in Analog mode with digital readout in inches of water.		Display range is Over Limit. Upper value is 19,990,000 and transmitter output is over 100%.
	Normal display for transmitter in DE mode and square root output. Digital readout is gallons per minute with 1000 multiplier.		Transmitter is in output mode. Bargraph and readout show value that was entered through SFC.
	Transmitter in DE mode is in non-critical status. Displayed value may not be valid. If display is "- - -" instead of a value, transmitter is in critical status.		Input pressure equal to or greater than 200%. Display flashes between 200% (or twice current URV in EU) and O-L. Transmitter locks output at 200% and will go no higher regardless of input.

Continued on next page

8.6 Monitoring Local Smart Meter Display, Continued

Operation error codes Table 52 identifies possible meter error codes and what they mean.

Table 52 Possible Smart Meter Error Codes.

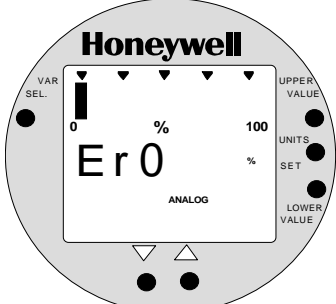
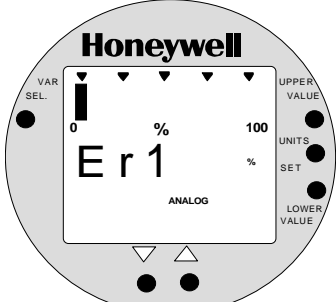
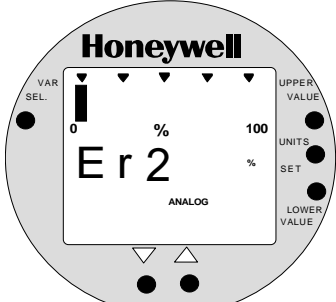
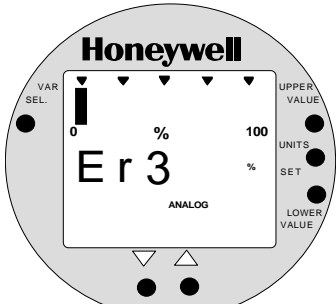
If error indication is . . .	Then, it means
	<p>You have tried to set local Zero or Span adjustment in a Series 100 transmitter which does not support this option.</p>
	<p>You have tried to set a pressure type engineering unit for a transmitter in SQUARE ROOT mode (FLOW) or have tried to set a flow type engineering unit for a transmitter in LINEAR mode (pressure). After this error is displayed, the meter will return to the unit # (EU#) of the Engineering Unit it was displaying before the set function was invoked. You may then select another unit or exit in the normal fashion.</p>
	<p>You have tried to select a process variable for the transmitter using the VAR SEL. button. The Variable Select button is non-functioning on the ST 3000 R300 transmitter.</p>
	<p>You have tried to set Lower or Upper display limit for pressure type engineering units (EU1 to EUC), or Lower display limit for flow type engineering units (EUD, EUE) or CUSTOM unit (EUF) in transmitter configured for SQUARE ROOT output. Or, you have tried to set upper display limit for flow or Custom unit in transmitter with SQUARE ROOT output and URV set to zero (0). In SQUARE ROOT mode, the transmitter's URV cannot equal zero. The Lower and Upper display limits only apply for CUSTOM (EUF) unit in transmitter configured for LINEAR output. The Upper display limit also applies for FLOW (EUD,EUE) and CUSTOM (EUF) units with transmitter in SQUARE ROOT mode, but the Lower display limit is fixed at zero (0) and cannot be changed.</p>

Continued on next page

8.6 Monitoring Local Smart Meter Display, Continued

Operation error codes,
continued

Table 52 Possible Smart Meter Error Codes, continued.

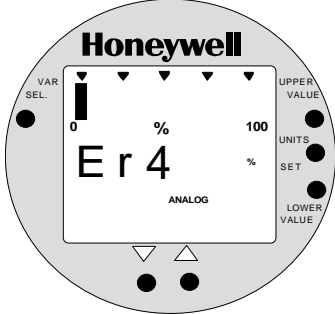
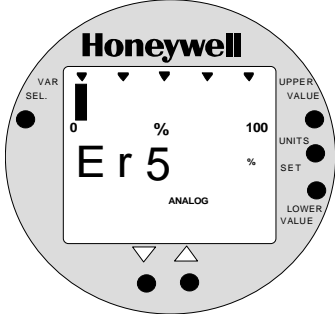
If error indication is . . .	Then, it means
	<p>You have tried to set a span value that is outside acceptable limits for your transmitter.</p>
	<p>You have tried to invoke a Local Smart Meter set function with the transmitter's Write Protect jumper in its Read Only position. You cannot make changes in the Local Smart Meter settings when the transmitter's configuration is write protected.</p>

Meter/transmitter interaction

- Cycling transmitter power OFF/ON will have no affect on meter configuration. The meter digital readout will be in the previously set engineering units and applicable upper and lower display limits will be intact when transmitter power is restored. (See **ATTENTION** in Section 6.8 when setting range values and configuring the meter display.)
- If you switch the transmitter mode from Analog to DE, the ANALOG indicator on the meter will go out. If you switch from DE to Analog mode, the ANALOG indicator will light.
- If you reconfigure the transmitter output conformity from SQUARE ROOT to LINEAR, the meter's digital readout will automatically revert to the default engineering unit of percent and the FLOW indicator will go out when the change is downloaded to the transmitter. Likewise, if you reconfigure the transmitter output conformity from LINEAR to SQUARE ROOT, the meter's digital readout will automatically revert to the default engineering unit of percent and the FLOW indicator will light when the change is downloaded to the transmitter. In either case, you must reconfigure the transmitter as outlined in Section 6.11 or 6.12 of this manual.

Section 9 —Maintenance

9.1 Introduction

Section Contents This section includes these topics

Section	Topic	See Page
9.1	Introduction	169
9.2	Preventive Maintenance.....	170
9.3	Inspecting and Cleaning Barrier Diaphragms.....	171
9.4	Replacing PWA	175
9.5	Replacing Meter Body	178

About this section This section provides information about preventive maintenance routines, cleaning barrier diaphragms, and replacing damaged parts.

9.2 Preventive Maintenance

Maintenance routines and schedules

The ST 3000 transmitter itself does not require any specific maintenance routine at regularly scheduled intervals. However, you should consider carrying out these typical inspection and maintenance routines on a schedule that is dictated by the characteristics of the process medium being measured and whether blow-down facilities or purge systems are being used.

- Check piping for leaks
 - Clear the piping of sediment or other foreign matter
 - Clean the transmitter's pressure chambers including the barrier diaphragms
-

9.3 Inspecting and Cleaning Barrier Diaphragms

Background

Depending on the characteristics of the process medium being measured, sediment or other foreign particles may collect in the process head cavity/chamber and cause faulty measurement. In addition, the barrier diaphragm or diaphragms in the transmitter's meter body may become coated with a residue from the process medium. The latter is also true for external diaphragms on flange mount and remote seal type transmitters.

In most cases, you can readily remove the process head or heads from the transmitter's meter body to clean the process head cavity and inspect the barrier diaphragm or diaphragms. For flange mount and remote seal diaphragms, you may only need to run a purge line in the tank to rinse off the face of the diaphragm.

Procedure

The procedure in Table 53 outlines the general steps for inspecting and cleaning barrier diaphragms. You may have to modify the steps to meet your particular process or transmitter model requirements.

Table 53 Inspecting and Cleaning Barrier Diaphragms

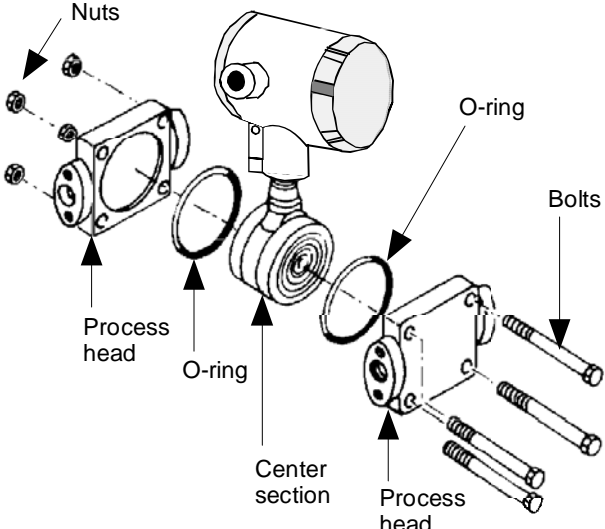
Step	Action
1	<p>Close all valves and isolate transmitter from process. Open vent in process head to drain fluid from transmitter's meter body, if required.</p> <p>ATTENTION We recommend that you remove the transmitter from service and move it to a clean area before taking it apart.</p>
2	<p>Remove nuts from bolts that hold process head or heads to meter body. Remove process heads and bolts.</p>  <p>The diagram shows an exploded view of the transmitter assembly. On the left, a process head is shown with several nuts being removed from its mounting bolts. In the center is the main transmitter body with a center section and an O-ring. On the right, another process head is shown with its mounting bolts and nuts being removed. Labels with arrows point to 'Nuts', 'Process head', 'O-ring', 'Center section', 'Process head', and 'Bolts'.</p>

Continued on next page

9.3 Inspecting and Cleaning Barrier Diaphragms, Continued

Procedure, continued

Table 53 Inspecting and Cleaning Barrier Diaphragms, continued

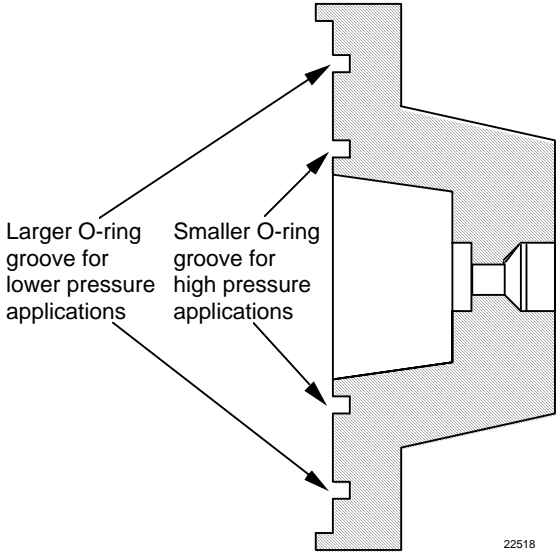
Step	Action
3	Remove O-ring and clean interior of process head using soft bristle brush and suitable solvent.
4	Inspect barrier diaphragm for any signs of deterioration or corrosion. Look for possible residue and clean if necessary. NOTE: If diaphragm is dented, has distorted convolutions or radial wrinkles, performance may be affected. Contact TAC for assistance.
5	Replace O-ring. <div style="border: 1px solid black; padding: 2px; width: fit-content; margin-bottom: 10px;">ATTENTION</div> <ul style="list-style-type: none"> • We recommend that you install a new O-ring whenever a process head is removed for cleaning. • The process head for a GP or an AP transmitter with single-head design has two O-ring grooves. A large one which is 2 in (50.8 mm) in diameter and a small one which is 1.3 in (33 mm) in diameter as shown in the following illustration. On high-pressure, model STG180, GP transmitters, be sure to use a small O-ring in the smaller/inner groove. On other models of GP and AP transmitters, use a large O-ring in the larger/outer groove. Never use both O-rings together. <div style="text-align: center; margin: 10px 0;">  <p style="text-align: right; margin-right: 50px;"><small>22518</small></p> </div> <p style="text-align: center;">GP/AP Process Head</p> <ul style="list-style-type: none"> • For process heads of a GP or AP transmitter with dual-head design, see detail illustration for differential pressure transmitters in Step 2.

Continued on next page

9.3 Inspecting and Cleaning Barrier Diaphragms, Continued

Procedure, continued

Table 53 Inspecting and Cleaning Barrier Diaphragms, continued

Step	Action
6	Coat threads on process head bolts with anti-seize compound such as "Neverseize" or equivalent.
7	Replace process head or heads and bolts. Finger tighten nuts.
8	<p>Use a torque wrench to gradually tighten nuts to torque rating shown in Table 48 in sequence shown in following illustration. Tighten head bolts in stages of 1/3 full torque, 2/3 full torque, and then full torque.</p> <div style="display: flex; justify-content: space-around; align-items: center;"> <div data-bbox="727 1039 1063 1228" style="text-align: center;"> <p>Always tighten head bolts in sequence shown and in these stages:</p> <ol style="list-style-type: none"> 1. 1/3 full torque 2. 2/3 full torque 3. Full torque </div> <div data-bbox="1112 777 1347 1228"> </div> </div>
9	<p>Return transmitter to service.</p> <p>CAUTION Do not exceed the overload rating when placing the transmitter back into service or during cleaning operations. See Overpressure ratings in Section 3 of this manual.</p>

Continued on next page

9.3 Inspecting and Cleaning Barrier Diaphragms, Continued

Torque ratings Table 54 lists process head bolt torque ratings for given transmitter type.

Table 54 Process Head Bolt Torque Ratings

Meter Body Type	Process Head Bolting Size	Bolting Type			
		Carbon Steel – Standard; no option specified	B7M Bolting ["B7" Option]	Stainless Steel NACE ["CR" Option]	316 Stainless Steel Non-NACE ["SS" Option]
Draft Range Transmitter	7/16 x 14 UNC	20,3 N-m +/- 1,0 N-m [15.0 Lb-Ft +/- 0.8 Lb-Ft]	20,3 N-m +/- 1,0 N-m [15.0 Lb-Ft +/- 0.8 Lb-Ft]	20,3 N-m +/- 1,0 N-m [15.0 Lb-Ft +/- 0.8 Lb-Ft]	20,3 N-m +/- 1,0 N-m [15.0 Lb-Ft +/- 0.8 Lb-Ft]
	7/16 x 20 UNF	NA	NA	25,8 N-m +/- 1,3 N-m [19.0 Lb-Ft +/- 1.0 Lb-Ft]	NA
	M12 x 1.75	25,8 N-m +/- 1,3 N-m [19.0 Lb-Ft +/- 1.0 Lb-Ft]	NA	NA	NA
All Other DP, GP and AP Transmitters	M12 x 1.75	63,7 N-m +/- 3,2 N-m [47.0 Lb-Ft +/- 2.4 Lb-Ft]	NA	NA	NA
	7/16 x 20 UNF	NA	NA	63,7 N-m +/- 3,2 N-m [47.0 Lb-Ft +/- 2.4 Lb-Ft]	NA
	7/16 x 14 UNC	67,8 N-m +/- 3,4 N-m [50.0 Lb-Ft +/- 2.5 Lb-Ft]	48,8 N-m +/- 2,4 N-m [36.0 Lb-Ft +/- 1.8 Lb-Ft]	56,9 N-m +/- 2,8 N-m [42.0 Lb-Ft +/- 2.1 Lb-Ft]	56,9 N-m +/- 2,8 N-m [42.0 Lb-Ft +/- 2.1 Lb-Ft]
	3/8 x 16 UNC	39,3 N-m +/- 2,0 N-m [29 Lb-Ft +/- 1.5 Lb-Ft]	NA	39,3 N-m +/- 2,0 N-m [29 Lb-Ft +/- 1.5 Lb-Ft]	39,3 N-m +/- 2,0 N-m [29 Lb-Ft +/- 1.5 Lb-Ft]
	M8 x 1.25	27,1 N-m +/- 1,4 N-m [20.0 Lb-Ft +/- 1.0 Lb-Ft]	NA	NA	NA
	5/16 x 18 UNC	NA	NA	20,3 N-m +/- 1,0 N-m [15.0 Lb-Ft +/- 0.8 Lb-Ft]	20,3 N-m +/- 1,0 N-m [15.0 Lb-Ft +/- 0.8 Lb-Ft]

9.4 Replacing PWA

About the PWA Electronics Board

The circuitry in the ST 3000 Release 300 transmitters is of the single PWA design. The PWA contains connectors for the flex-tape conductor from the sensor, the loop power wires and a connector for the optional smart meter cable.

Procedure

The procedure in Table 55 outlines the steps for replacing the PWA.

Table 55 Replacing PWA.

Step	Action
1	Turn OFF transmitter power. ATTENTION We recommend that you remove the transmitter from service and move it to a clean area before taking it apart.
2	Loosen end cap lock and unscrew end cap from electronics side of transmitter housing.
	We recommend that you use a ground strap or ionizer when handling the PWA, since electrostatic discharges can damage certain circuit components.
3	<ul style="list-style-type: none"> If equipped with a Local Smart Meter, carefully turn Smart Meter counterclockwise to remove it from PWA mounting bracket and unplug cable from connector on back of meter assembly. Loosen two retaining screws and carefully pull mounting bracket and PWA from housing. Using the retaining clip, unplug flex tape connector and 2-wire power connector from PWA, and remove PWA.

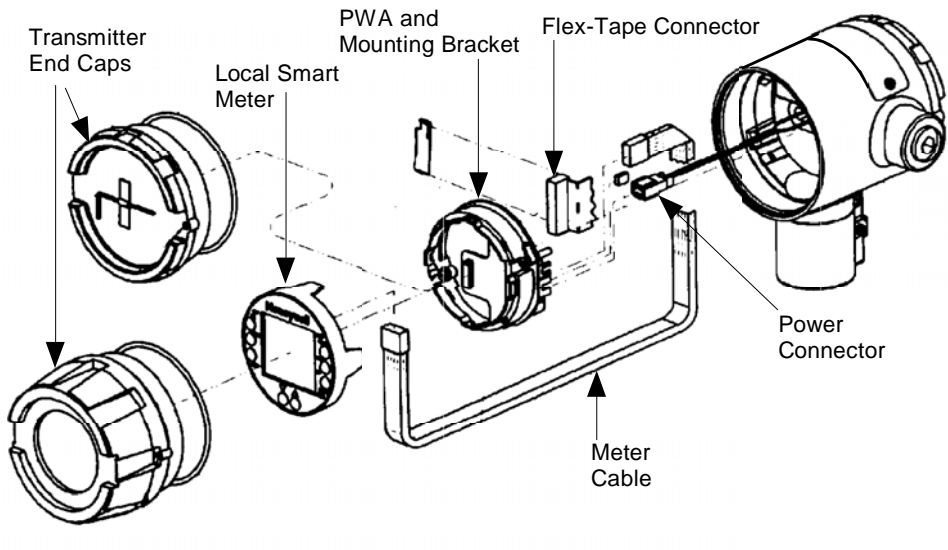

Continued on next page

9.4 Replacing PWA, Continued

Procedure, continued

Table 55 Replacing PWA, continued

Step	Action						
4	<table border="1" style="width: 100%; border-collapse: collapse;"> <thead> <tr> <th style="width: 50%; text-align: left;">If your transmitter...</th> <th style="width: 50%; text-align: left;">Then...</th> </tr> </thead> <tbody> <tr> <td>has Local Smart Meter Option</td> <td>go to Step 5</td> </tr> <tr> <td>does not have Local Smart Meter Option</td> <td>go to Step 7</td> </tr> </tbody> </table>	If your transmitter...	Then...	has Local Smart Meter Option	go to Step 5	does not have Local Smart Meter Option	go to Step 7
If your transmitter...	Then...						
has Local Smart Meter Option	go to Step 5						
does not have Local Smart Meter Option	go to Step 7						
5	<p>Note orientation of mounting bracket on PWA (side without cable connectors). Unplug meter cable from connector on PWA. Remove screw retainers from other side of mounting screws so you can remove screws and mounting bracket from PWA. Set PWA aside.</p>						
6	<p>Orient mounting bracket as noted above with meter cable still located in slot on its right-hand side, install mounting screws through bracket and replacement PWA, and install retainers to hold screws in place. Plug meter cable into connector J4 on PWA and be sure cable is still under restraining clip on front of bracket. Go to Step 9.</p>						

Continued on next page

9.4 Replacing PWA, Continued

Procedure, continued

Table 55 Replacing PWA, continued

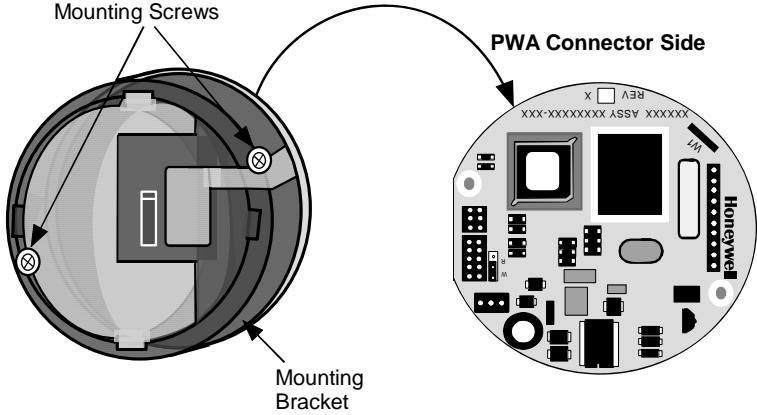
Step	Action
7	<p>Note orientation of mounting bracket on PWA (side without cable connectors). Remove screw retainers from other side of mounting screws so you can remove screws and mounting bracket from PWA. Set PWA aside.</p> 
8	<p>Orient mounting bracket as noted above, install mounting screws through bracket and replacement PWA, and install retainers to hold screws in place.</p>
9	<p>Reverse actions in Steps 2 and 3, as applicable, to install PWA and bracket to transmitter housing.</p> <p>We recommend that you lubricate end-cap O-ring with silicon grease such as Dow Corning #33 or equivalent before you replace end cap.</p> <p>ATTENTION Be sure to orient Local Smart Meter for proper viewing through end-cap window. You can rotate the meter mounting orientation in 90 degree increments.</p>
10	<p>Return transmitter to service and turn ON power.</p>
11	<p>If applicable, verify Local Smart Meter configuration data. Reconfigure selected engineering units and lower and upper display range values as required. (See Subsections 6.11 and/or 6.12 for details.)</p>

9.5 Replacing Meter Body

Procedure

You can replace the complete meter body including process heads or only the meter body on selected DP, GP and AP transmitters by using the existing process head(s).

Use the procedure in Table 56 to install a meter body only.

Table 56 Replacing Meter Body Only

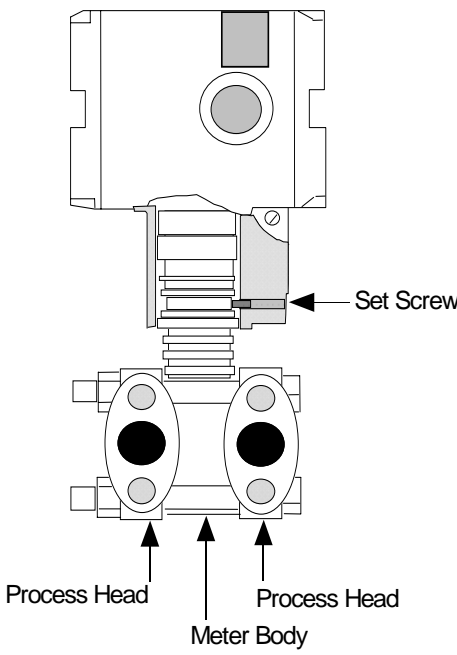
Step	Action
1	Complete first 3 Steps in Table 55, as applicable, to remove PWA.
2	<p>Use 4 mm size hex wrench to completely loosen set screw outside housing.</p>  <p>The diagram shows a cross-section of the transmitter assembly. At the top is the electronics housing. Below it is the meter body, which is secured by a set screw on its side. At the bottom are two process heads. Arrows point to the set screw, the two process heads, and the meter body.</p>
3	Carefully turn complete meter body counterclockwise to unscrew it from electronics housing.
4	Remove nuts from bolts that hold process head or heads to center section. Remove process heads and bolts

Continued on next page

9.5 Replacing Meter Body, Continued

Procedure, continued

Table 56 Replacing Meter Body Only, continued

Step	Action
5	Remove O-ring and clean interior of process head using soft bristle brush and suitable solvent.
6	<p>Replace O-ring.</p> <p>ATTENTION The process head for a GP or an AP transmitter with single-head design has two O-ring grooves. A large one which is 2 in (50.8 mm) in diameter and a small one which is 1.3 in (33 mm) in diameter as shown in the following illustration. On high-pressure, model STG180, GP transmitters, be sure to use a small O-ring in the smaller/inner groove. On other models of GP and AP transmitters, use a large O-ring in the larger/outer groove. Never use both O-rings together.</p> <div data-bbox="727 905 1279 1493" style="text-align: center;"> <p>GP/AP Process Head</p> <p>22518</p> </div> <ul style="list-style-type: none"> For process heads of a GP or AP transmitter with dual-head design, see detail illustration for differential pressure transmitters in Step 8.
7	Coat threads on process head bolts with anti-seize compound such as "Neverseize" or equivalent.

Continued on next page

9.5 Replacing Meter Body, Continued

Procedure, continued

Table 56 Replacing Meter Body Only, continued

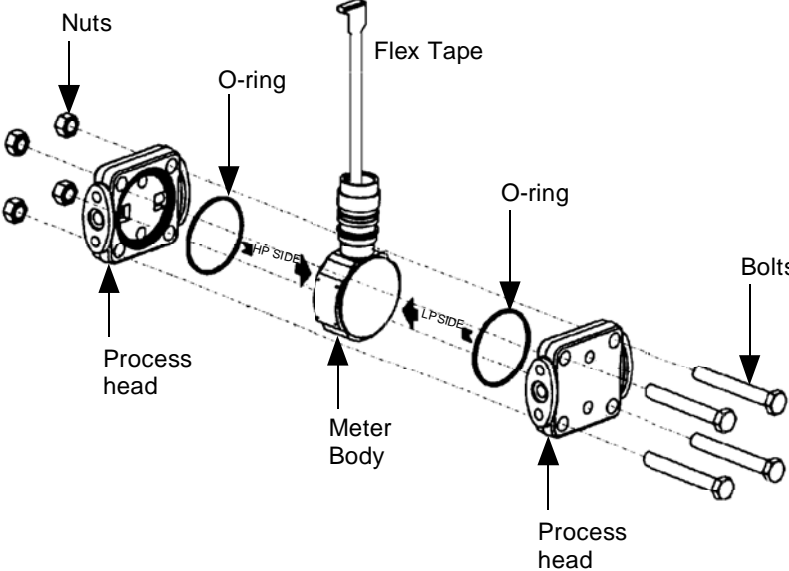
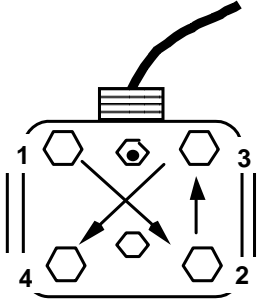
Step	Action
<p>8</p>	<p>Carefully assemble process head or heads and bolts to new meter body. Finger tighten nuts.</p> <p style="text-align: center;">Typical Series 100 DP Transmitter Meter Body</p> 
<p>9</p>	<p>Use a torque wrench to gradually tighten nuts to torque rating shown in Table 48 in sequence shown in following illustration. Tighten head bolts in stages of 1/3 full torque, 2/3 full torque, and then full torque.</p> <p>Always tighten head bolts in sequence shown and in these stages:</p> <ol style="list-style-type: none"> 1. 1/3 full torque 2. 2/3 full torque 3. Full torque  <p style="text-align: right;">22519</p>

Continued on next page

9.5 Replacing Meter Body, Continued

Procedure, continued

Table 56 Replacing Meter Body Only, continued

Step	Action
10	Feed flex tape on new meter body through neck of housing and screw new meter body into housing until bottom of header portion of center section is approximately flush with neck of electronics housing.
11	Tighten outside set screw to be sure it is fully seated in slot in header. Loosen set screw half turn, rotate housing to desired position and tighten set screw.
12	<p>Reverse actions in Steps 2 and 3 in Table 52, as applicable, to return PWA and bracket to transmitter housing.</p> <p>We recommend that you lubricate end-cap O-ring with silicon grease such as Dow Corning #33 or equivalent before you replace end cap.</p> <p>ATTENTION Be sure to orient Local Smart Meter for proper viewing through end-cap window. You can rotate the meter mounting orientation in 90 degree increments.</p>
13	Return transmitter to service and turn ON power.
14	Verify transmitter's configuration data. Restore saved database, if applicable.

Section 10 —Calibration

10.1 Introduction

Section Contents

This section includes these topics

Section	Topic	See Page
10.1	Introduction	183
10.2	Overview	184
10.3	Calibrating Analog Output Signal	185
10.4	Calibrating Range with SFC	189
10.5	Resetting Calibration	192

About this section

This section provides information about calibrating the transmitter's analog output and measurement range. It also covers the procedure for resetting calibration to default values as a quick alternative to measurement range calibration.

10.2 Overview

About calibration

The ST 3000 Smart Transmitter does not require recalibration at periodic intervals to maintain accuracy. If a recalibration is required, we recommend that you do a bench calibration with the transmitter removed from the process and located in a controlled environment to get the best accuracy.

If the transmitter will be operating in the analog mode, you must calibrate its output signal before you calibrate the transmitter's measurement range using the SFC. While it is not required to calibrate the output signal first for transmitter's operating in the DE mode, you can do it by using the SFC to read the output in percent.

You can also use the SFC to reset the calibration data to default values, if it is corrupted, until the transmitter can be recalibrated. See Table 59 in this section for details.

ATTENTION

If the transmitter is digitally integrated with our TPS system, you can initiate range calibration and calibration reset functions through displays at the Universal Station, GUS and Allen-Bradley PLCs. However, we still recommend that you do a range calibration using an SFC with the transmitter removed from service and moved to a controlled environment. Details about doing a calibration reset through the Universal Station are given in the *PM/APM Smartline Transmitter Integration Manual PM12-410* which is part of the TDC 3000^X system bookset.

Test Equipment Required

Depending upon the type of calibration you choose, you may need any of the following test equipment to accurately calibrate the transmitter:

- Digital Voltmeter or milliammeter with 0.02% accuracy or better
 - SFC Smart Field Communicator
 - Calibration-standard input source with a 0.02% accuracy
 - 250 ohm resistor with 0.01% tolerance or better.
-

10.3 Calibrating Analog Output Signal

Background

You can calibrate the transmitter's analog output circuit at its 0 and 100% levels by using the transmitter in its constant-current source mode. It is not necessary to remove the transmitter from service.

Procedure

The procedure in Table 57 shows the steps for calibrating the output signal for a transmitter in the analog mode. Note that the procedure is similar for a transmitter in the DE mode, but the SFC must be used to read the output in percent in place of the milliammeter or voltmeter readings.

Table 57 Calibrating Output Signal for Transmitter in Analog Mode





Step	Press Key	Read Display or Action	Description
1		Connect SFC across loop wiring and turn it on. Connect a precision milliammeter or voltmeter (0.02% accuracy or better) in loop to check readings.	See Figure 38 for sample test equipment hookup. ATTENTION Be sure the accuracy of the resistor is 0.01% or better for current measurements made by voltage drop.
2	DE READ A ID	T A G N O . T R I P S S E C U R E D ? ?	Be sure any switches that may trip alarms or interlocks associated with analog loop are secured or turned off.
3	NON-VOL ENTER (Yes)	T A G N O . S F C W O R K I N G . . . L I N D P T A G N O . P T 3 0 1 1	Confirm that "TRIPS" are secured and establish communications with sample transmitter PT 3011
4	INPUT J OUT- PUT	O U T P 1 P T 3 0 1 1 S F C W O R K I N G . . . O U T P 1 P T 3 0 1 1 3 2 . 4 0 %	Display shows current transmitter output level and it will update every six seconds. Be sure to time your next key press with an updated display.
5	Z 0	O U T P 1 P T 3 0 1 1 0 - %	Key in 0 (zero) as desired output signal level in percent.
6	NON-VOL ENTER (Yes)	O U T P 1 P T 3 0 1 1 S F C W O R K I N G . . . O U T P 1 P T 3 0 1 1 # 0 . 0 0 %	Put transmitter into constant-current source mode as noted by "#" sign in display and set output to 0%.

Continued on next page

10.3 Calibrating Analog Output Signal, Continued

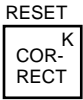
Procedure, continued

Table 57 Calibrating Output Signal for Transmitter in Analog Mode, continued

Step	Press Key	Read Display or Action	Description																																																																																																										
7		<table border="1" style="width: 100%; text-align: center;"> <tr><td>O</td><td>U</td><td>T</td><td>P</td><td>1</td><td></td><td>P</td><td>T</td><td>3</td><td>0</td><td>1</td><td>1</td></tr> <tr><td>S</td><td>F</td><td>C</td><td></td><td>W</td><td>O</td><td>R</td><td>K</td><td>I</td><td>N</td><td>G</td><td>.</td><td>.</td><td>.</td></tr> </table> <table border="1" style="width: 100%; text-align: center;"> <tr><td>O</td><td>U</td><td>T</td><td>P</td><td>1</td><td></td><td>P</td><td>T</td><td>3</td><td>0</td><td>1</td><td>1</td><td>#</td></tr> <tr><td>C</td><td>O</td><td>R</td><td>R</td><td>E</td><td>C</td><td>T</td><td>D</td><td>A</td><td>C</td><td>Z</td><td>E</td><td>R</td><td>O</td></tr> </table>	O	U	T	P	1		P	T	3	0	1	1	S	F	C		W	O	R	K	I	N	G	.	.	.	O	U	T	P	1		P	T	3	0	1	1	#	C	O	R	R	E	C	T	D	A	C	Z	E	R	O	Calibrate output signal to 0%.																																																					
O	U	T	P	1		P	T	3	0	1	1																																																																																																		
S	F	C		W	O	R	K	I	N	G	.	.	.																																																																																																
O	U	T	P	1		P	T	3	0	1	1	#																																																																																																	
C	O	R	R	E	C	T	D	A	C	Z	E	R	O																																																																																																
8		Check that millimeter or voltmeter reading is 4mA or 1V.	<table border="1" style="width: 100%; text-align: center;"> <thead> <tr> <th>If reading is ...</th> <th>Then...</th> </tr> </thead> <tbody> <tr> <td>correct</td> <td>go to Step 11.</td> </tr> <tr> <td>lower than 4mA or 1V</td> <td>go to Step 9.</td> </tr> <tr> <td>higher than 4mA or 1V</td> <td>go to Step 10.</td> </tr> </tbody> </table>	If reading is ...	Then...	correct	go to Step 11.	lower than 4mA or 1V	go to Step 9.	higher than 4mA or 1V	go to Step 10.																																																																																																		
If reading is ...	Then...																																																																																																												
correct	go to Step 11.																																																																																																												
lower than 4mA or 1V	go to Step 9.																																																																																																												
higher than 4mA or 1V	go to Step 10.																																																																																																												
9		<table border="1" style="width: 100%; text-align: center;"> <tr><td>O</td><td>U</td><td>T</td><td>P</td><td>1</td><td></td><td>P</td><td>T</td><td>3</td><td>0</td><td>1</td><td>1</td><td>#</td></tr> <tr><td>I</td><td>N</td><td>C</td><td></td><td></td><td>1</td><td>C</td><td>O</td><td>U</td><td>N</td><td>T</td><td>S</td><td></td></tr> </table> <table border="1" style="width: 100%; text-align: center;"> <tr><td>O</td><td>U</td><td>T</td><td>P</td><td>1</td><td></td><td>P</td><td>T</td><td>3</td><td>0</td><td>1</td><td>1</td><td>#</td></tr> <tr><td>S</td><td>F</td><td>C</td><td></td><td>W</td><td>O</td><td>R</td><td>K</td><td>I</td><td>N</td><td>G</td><td>.</td><td>.</td><td>.</td></tr> </table> <table border="1" style="width: 100%; text-align: center;"> <tr><td>O</td><td>U</td><td>T</td><td>P</td><td>1</td><td></td><td>P</td><td>T</td><td>3</td><td>0</td><td>1</td><td>1</td><td>#</td></tr> <tr><td></td><td>I</td><td>N</td><td>C</td><td>R</td><td>E</td><td>A</td><td>S</td><td>E</td><td>D</td><td>4</td><td>m</td><td>A</td></tr> </table> <table border="1" style="width: 100%; text-align: center;"> <tr><td>O</td><td>U</td><td>T</td><td>P</td><td>1</td><td></td><td>P</td><td>T</td><td>3</td><td>0</td><td>1</td><td>1</td><td>#</td></tr> <tr><td>C</td><td>O</td><td>R</td><td>R</td><td>E</td><td>C</td><td>T</td><td>D</td><td>A</td><td>C</td><td>Z</td><td>E</td><td>R</td><td>O</td></tr> </table>	O	U	T	P	1		P	T	3	0	1	1	#	I	N	C			1	C	O	U	N	T	S		O	U	T	P	1		P	T	3	0	1	1	#	S	F	C		W	O	R	K	I	N	G	.	.	.	O	U	T	P	1		P	T	3	0	1	1	#		I	N	C	R	E	A	S	E	D	4	m	A	O	U	T	P	1		P	T	3	0	1	1	#	C	O	R	R	E	C	T	D	A	C	Z	E	R	O	Gradually raise output to 4mA or 1V reading. Repeat this Step as required.
O	U	T	P	1		P	T	3	0	1	1	#																																																																																																	
I	N	C			1	C	O	U	N	T	S																																																																																																		
O	U	T	P	1		P	T	3	0	1	1	#																																																																																																	
S	F	C		W	O	R	K	I	N	G	.	.	.																																																																																																
O	U	T	P	1		P	T	3	0	1	1	#																																																																																																	
	I	N	C	R	E	A	S	E	D	4	m	A																																																																																																	
O	U	T	P	1		P	T	3	0	1	1	#																																																																																																	
C	O	R	R	E	C	T	D	A	C	Z	E	R	O																																																																																																
10		<table border="1" style="width: 100%; text-align: center;"> <tr><td>O</td><td>U</td><td>T</td><td>P</td><td>1</td><td></td><td>P</td><td>T</td><td>3</td><td>0</td><td>1</td><td>1</td><td>#</td></tr> <tr><td>D</td><td>E</td><td>C</td><td></td><td></td><td>1</td><td>C</td><td>O</td><td>U</td><td>N</td><td>T</td><td>S</td><td></td></tr> </table> <table border="1" style="width: 100%; text-align: center;"> <tr><td>O</td><td>U</td><td>T</td><td>P</td><td>1</td><td></td><td>P</td><td>T</td><td>3</td><td>0</td><td>1</td><td>1</td><td>#</td></tr> <tr><td>S</td><td>F</td><td>C</td><td></td><td>W</td><td>O</td><td>R</td><td>K</td><td>I</td><td>N</td><td>G</td><td>.</td><td>.</td><td>.</td></tr> </table> <table border="1" style="width: 100%; text-align: center;"> <tr><td>O</td><td>U</td><td>T</td><td>P</td><td>1</td><td></td><td>P</td><td>T</td><td>3</td><td>0</td><td>1</td><td>1</td><td>#</td></tr> <tr><td></td><td>D</td><td>E</td><td>C</td><td>R</td><td>E</td><td>A</td><td>S</td><td>E</td><td>D</td><td>4</td><td>m</td><td>A</td></tr> </table> <table border="1" style="width: 100%; text-align: center;"> <tr><td>O</td><td>U</td><td>T</td><td>P</td><td>1</td><td></td><td>P</td><td>T</td><td>3</td><td>0</td><td>1</td><td>1</td><td>#</td></tr> <tr><td>C</td><td>O</td><td>R</td><td>R</td><td>E</td><td>C</td><td>T</td><td>D</td><td>A</td><td>C</td><td>Z</td><td>E</td><td>R</td><td>O</td></tr> </table>	O	U	T	P	1		P	T	3	0	1	1	#	D	E	C			1	C	O	U	N	T	S		O	U	T	P	1		P	T	3	0	1	1	#	S	F	C		W	O	R	K	I	N	G	.	.	.	O	U	T	P	1		P	T	3	0	1	1	#		D	E	C	R	E	A	S	E	D	4	m	A	O	U	T	P	1		P	T	3	0	1	1	#	C	O	R	R	E	C	T	D	A	C	Z	E	R	O	Gradually decrease output to 4mA or 1V reading. Repeat this Step as required.
O	U	T	P	1		P	T	3	0	1	1	#																																																																																																	
D	E	C			1	C	O	U	N	T	S																																																																																																		
O	U	T	P	1		P	T	3	0	1	1	#																																																																																																	
S	F	C		W	O	R	K	I	N	G	.	.	.																																																																																																
O	U	T	P	1		P	T	3	0	1	1	#																																																																																																	
	D	E	C	R	E	A	S	E	D	4	m	A																																																																																																	
O	U	T	P	1		P	T	3	0	1	1	#																																																																																																	
C	O	R	R	E	C	T	D	A	C	Z	E	R	O																																																																																																
11		<table border="1" style="width: 100%; text-align: center;"> <tr><td>O</td><td>U</td><td>T</td><td>P</td><td>1</td><td></td><td>P</td><td>T</td><td>3</td><td>0</td><td>1</td><td>1</td><td>#</td></tr> <tr><td>S</td><td>F</td><td>C</td><td></td><td>W</td><td>O</td><td>R</td><td>K</td><td>I</td><td>N</td><td>G</td><td>.</td><td>.</td><td>.</td></tr> </table> <table border="1" style="width: 100%; text-align: center;"> <tr><td>O</td><td>U</td><td>T</td><td>P</td><td>1</td><td></td><td>P</td><td>T</td><td>3</td><td>0</td><td>1</td><td>1</td><td>#</td></tr> <tr><td></td><td></td><td></td><td></td><td>Ø</td><td>.</td><td>Ø</td><td>Ø</td><td>%</td><td></td><td></td><td></td><td></td></tr> </table>	O	U	T	P	1		P	T	3	0	1	1	#	S	F	C		W	O	R	K	I	N	G	.	.	.	O	U	T	P	1		P	T	3	0	1	1	#					Ø	.	Ø	Ø	%					<p>Call up output for display.</p> <p>Present output signal level in percent.</p>																																																					
O	U	T	P	1		P	T	3	0	1	1	#																																																																																																	
S	F	C		W	O	R	K	I	N	G	.	.	.																																																																																																
O	U	T	P	1		P	T	3	0	1	1	#																																																																																																	
				Ø	.	Ø	Ø	%																																																																																																					

Continued on next page

10.3 Calibrating Analog Output Signal, Continued

Procedure, continued

Table 57 Calibrating Output Signal for Transmitter in Analog Mode, continued

Step	Press Key	Read Display or Action	Description																																																																																																										
12		<table border="1"> <tr><td>O</td><td>U</td><td>T</td><td>P</td><td>1</td><td></td><td>P</td><td>T</td><td>3</td><td>0</td><td>1</td><td>1</td><td>#</td></tr> <tr><td>1</td><td>-</td><td></td><td></td><td></td><td></td><td>%</td><td></td><td></td><td></td><td></td><td></td><td></td></tr> </table>	O	U	T	P	1		P	T	3	0	1	1	#	1	-					%							Key in 100 as desired output level in percent.																																																																																
	O	U	T	P	1		P	T	3	0	1	1	#																																																																																																
	1	-					%																																																																																																						
	<table border="1"> <tr><td>O</td><td>U</td><td>T</td><td>P</td><td>1</td><td></td><td>P</td><td>T</td><td>3</td><td>0</td><td>1</td><td>1</td><td>#</td></tr> <tr><td>1</td><td>∅</td><td>-</td><td></td><td></td><td></td><td>%</td><td></td><td></td><td></td><td></td><td></td><td></td></tr> </table>	O	U	T	P	1		P	T	3	0	1	1	#	1	∅	-				%																																																																																								
O	U	T	P	1		P	T	3	0	1	1	#																																																																																																	
1	∅	-				%																																																																																																							
	<table border="1"> <tr><td>O</td><td>U</td><td>T</td><td>P</td><td>1</td><td></td><td>P</td><td>T</td><td>3</td><td>0</td><td>1</td><td>1</td><td>#</td></tr> <tr><td>1</td><td>∅</td><td>∅</td><td>-</td><td></td><td></td><td>%</td><td></td><td></td><td></td><td></td><td></td><td></td></tr> </table>	O	U	T	P	1		P	T	3	0	1	1	#	1	∅	∅	-			%																																																																																								
O	U	T	P	1		P	T	3	0	1	1	#																																																																																																	
1	∅	∅	-			%																																																																																																							
13	NON-VOL 	<table border="1"> <tr><td>O</td><td>U</td><td>T</td><td>P</td><td>1</td><td></td><td>P</td><td>T</td><td>3</td><td>0</td><td>1</td><td>1</td><td>#</td></tr> <tr><td>S</td><td>F</td><td>C</td><td>W</td><td>O</td><td>R</td><td>K</td><td>I</td><td>N</td><td>G</td><td>.</td><td>.</td><td></td></tr> </table> <table border="1"> <tr><td>O</td><td>U</td><td>T</td><td>P</td><td>1</td><td></td><td>P</td><td>T</td><td>3</td><td>0</td><td>1</td><td>1</td><td>#</td></tr> <tr><td></td><td>1</td><td>∅</td><td>∅</td><td>.</td><td>∅</td><td>∅</td><td>%</td><td></td><td></td><td></td><td></td><td></td></tr> </table>	O	U	T	P	1		P	T	3	0	1	1	#	S	F	C	W	O	R	K	I	N	G	.	.		O	U	T	P	1		P	T	3	0	1	1	#		1	∅	∅	.	∅	∅	%						Set output to 100%.																																																						
O	U	T	P	1		P	T	3	0	1	1	#																																																																																																	
S	F	C	W	O	R	K	I	N	G	.	.																																																																																																		
O	U	T	P	1		P	T	3	0	1	1	#																																																																																																	
	1	∅	∅	.	∅	∅	%																																																																																																						
14	RESET 	<table border="1"> <tr><td>O</td><td>U</td><td>T</td><td>P</td><td>1</td><td></td><td>P</td><td>T</td><td>3</td><td>0</td><td>1</td><td>1</td><td>#</td></tr> <tr><td>S</td><td>F</td><td>C</td><td>W</td><td>O</td><td>R</td><td>K</td><td>I</td><td>N</td><td>G</td><td>.</td><td>.</td><td></td></tr> </table> <table border="1"> <tr><td>O</td><td>U</td><td>T</td><td>P</td><td>1</td><td></td><td>P</td><td>T</td><td>3</td><td>0</td><td>1</td><td>1</td><td>#</td></tr> <tr><td>C</td><td>O</td><td>R</td><td>R</td><td>E</td><td>C</td><td>T</td><td>D</td><td>A</td><td>C</td><td>S</td><td>P</td><td>A</td><td>N</td></tr> </table>	O	U	T	P	1		P	T	3	0	1	1	#	S	F	C	W	O	R	K	I	N	G	.	.		O	U	T	P	1		P	T	3	0	1	1	#	C	O	R	R	E	C	T	D	A	C	S	P	A	N	Calibrate output to 100%.																																																					
O	U	T	P	1		P	T	3	0	1	1	#																																																																																																	
S	F	C	W	O	R	K	I	N	G	.	.																																																																																																		
O	U	T	P	1		P	T	3	0	1	1	#																																																																																																	
C	O	R	R	E	C	T	D	A	C	S	P	A	N																																																																																																
15		Check that milliammeter or voltmeter reading is 20mA or 5V.	<table border="1"> <thead> <tr> <th>If reading is ...</th> <th>Then...</th> </tr> </thead> <tbody> <tr> <td>correct</td> <td>go to Step 18.</td> </tr> <tr> <td>lower than 20mA or 5V</td> <td>go to Step 16.</td> </tr> <tr> <td>higher than 20mA or 5V</td> <td>go to Step 17.</td> </tr> </tbody> </table>	If reading is ...	Then...	correct	go to Step 18.	lower than 20mA or 5V	go to Step 16.	higher than 20mA or 5V	go to Step 17.																																																																																																		
If reading is ...	Then...																																																																																																												
correct	go to Step 18.																																																																																																												
lower than 20mA or 5V	go to Step 16.																																																																																																												
higher than 20mA or 5V	go to Step 17.																																																																																																												
16		<table border="1"> <tr><td>O</td><td>U</td><td>T</td><td>P</td><td>1</td><td></td><td>P</td><td>T</td><td>3</td><td>0</td><td>1</td><td>1</td><td>#</td></tr> <tr><td>I</td><td>N</td><td>C</td><td></td><td></td><td>1</td><td>C</td><td>O</td><td>U</td><td>N</td><td>T</td><td>S</td><td></td></tr> </table> <table border="1"> <tr><td>O</td><td>U</td><td>T</td><td>P</td><td>1</td><td></td><td>P</td><td>T</td><td>3</td><td>0</td><td>1</td><td>1</td><td>#</td></tr> <tr><td>S</td><td>F</td><td>C</td><td>W</td><td>O</td><td>R</td><td>K</td><td>I</td><td>N</td><td>G</td><td>.</td><td>.</td><td></td></tr> </table> <table border="1"> <tr><td>O</td><td>U</td><td>T</td><td>P</td><td>1</td><td></td><td>P</td><td>T</td><td>3</td><td>0</td><td>1</td><td>1</td><td>#</td></tr> <tr><td></td><td>I</td><td>N</td><td>C</td><td>R</td><td>E</td><td>A</td><td>S</td><td>E</td><td>D</td><td>2</td><td>∅</td><td>m</td><td>A</td></tr> </table> <table border="1"> <tr><td>O</td><td>U</td><td>T</td><td>P</td><td>1</td><td></td><td>P</td><td>T</td><td>3</td><td>0</td><td>1</td><td>1</td><td>#</td></tr> <tr><td>C</td><td>O</td><td>R</td><td>R</td><td>E</td><td>C</td><td>T</td><td>D</td><td>A</td><td>C</td><td>S</td><td>P</td><td>A</td><td>N</td></tr> </table>	O	U	T	P	1		P	T	3	0	1	1	#	I	N	C			1	C	O	U	N	T	S		O	U	T	P	1		P	T	3	0	1	1	#	S	F	C	W	O	R	K	I	N	G	.	.		O	U	T	P	1		P	T	3	0	1	1	#		I	N	C	R	E	A	S	E	D	2	∅	m	A	O	U	T	P	1		P	T	3	0	1	1	#	C	O	R	R	E	C	T	D	A	C	S	P	A	N	Gradually raise output to 20mA or 5V reading. Repeat this Step as required.
O	U	T	P	1		P	T	3	0	1	1	#																																																																																																	
I	N	C			1	C	O	U	N	T	S																																																																																																		
O	U	T	P	1		P	T	3	0	1	1	#																																																																																																	
S	F	C	W	O	R	K	I	N	G	.	.																																																																																																		
O	U	T	P	1		P	T	3	0	1	1	#																																																																																																	
	I	N	C	R	E	A	S	E	D	2	∅	m	A																																																																																																
O	U	T	P	1		P	T	3	0	1	1	#																																																																																																	
C	O	R	R	E	C	T	D	A	C	S	P	A	N																																																																																																

Continued on next page

10.3 Calibrating Analog Output Signal, Continued

Procedure, continued

Table 57 Calibrating Output Signal for Transmitter in Analog Mode, continued

Step	Press Key	Read Display or Action	Description
17		<p>O U T P 1 P T 3 0 1 1 # D E C 1 C O U N T S</p> <p>O U T P 1 P T 3 0 1 1 # S F C W O R K I N G . . .</p> <p>O U T P 1 P T 3 0 1 1 # D E C R E A S E D 2 0 m A</p> <p>O U T P 1 P T 3 0 1 1 # C O R R E C T D A C S P A N</p>	Gradually decrease output to 20mA or 5V reading. Repeat this Step as required.
18	 NON-VOL 	<p>O U T P 1 P T 3 0 1 1 # S H I F T -</p> <p>O U T P 1 P T 3 0 1 1 # S F C W O R K I N G . . .</p> <p>O U T P 1 P T 3 0 1 1 # D A T A N O N V O L A T I L E</p> <p>L I N D P P T 3 0 1 1 # R E A D Y . . .</p>	Initiate shift key selection Saves data in transmitter's nonvolatile memory. This takes approximately 8 seconds.
19	 	<p>O U T P 1 P T 3 0 1 1 # S F C W O R K I N G . . .</p> <p>O U T P 1 P T 3 0 1 1 # 1 0 0 . 0 0 %</p>	Call up output for display. Present output signal level in percent.
20		<p>O U T P 1 P T 3 0 1 1 # S F C W O R K I N G . . .</p> <p>L I N D P P T 3 0 1 1 # R E A D Y . . .</p>	Exit constant-current source mode.

10.4 Calibrating Range with SFC

Background

The ST 3000 Smart Transmitter has two-point calibration. This means when you calibrate two points in the calibration range all the points in that range adjust to that calibration.







Procedure

The procedure in Table 58 shows the steps for calibrating a differential pressure (DP) type transmitter to a range of 0 to 200 inH₂O for example purposes. This procedure assumes that the transmitter is removed from the process and located in a controlled environment.

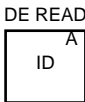
ATTENTION

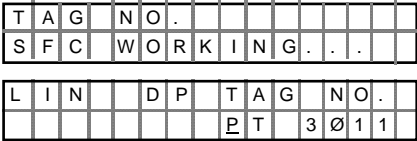
You must have a precision pressure source with an accuracy of 0.04% or better to do a range calibration. Note that we factory calibrate ST 3000 Smart Transmitters with inches of water ranges using inches of water pressure referenced to a temperature of 39.2 °F (4°C).

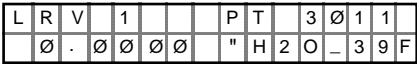
Table 58 Calibrating Measurement Range With SFC

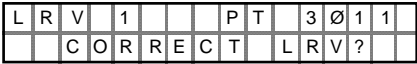
Step	Press Key	Read Display or Action	Description
1		Connect power supply and SFC to signal terminals on transmitter's terminal block. Connect a calibration-standard pressure source to high pressure side of DP type transmitter.	See Figure 52 for typical SFC, power supply, and pressure source hookup for calibration.
2		Turn on power supply and allow transmitter to stabilize its operation for approximately 30 minutes.	
3		Turn on SFC.	
4			Does not apply for bench calibration.
5			Acknowledge prompt and establish communications with sample transmitter PT 3011 to be calibrated.
6		Adjust pressure source to apply pressure equal to LRV (0%)	
7			Present LRV setting. If displayed value does not match applied pressure, key in matching LRV value or adjust pressure accordingly.
8			Prompt asks if LRV is to be calibrated to applied reference pressure. If it is to be calibrated, go to next Step. If it isn't, press [CLR] key and try again.

Continued on next page

10.4 Calibrating Range with SFC, Continued

Procedure, continued

Table 58 Calibrating Measurement Range With SFC, continued

Step	Press Key	Read Display or Action	Description
9	NON-VOL ENTER (Yes)	<pre>L R V 1 P T 3 0 1 1 S F C W O R K I N G . . . L R V 1 P T 3 0 1 1 L R V C O R R E C T E D L R V 1 P T 3 0 1 1 0 . 0 0 0 0 " H 2 O _ 3 9 F</pre>	Calibrates LRV to reference input pressure for zero calibration.
10		Adjust pressure source to apply pressure equal to URV (100%)	
11	F URV 100%	<pre>U R V 1 P T 3 0 1 1 2 0 0 . 0 0 " H 2 O _ 3 9 F</pre>	Present URV setting. If displayed value does not match applied pressure, key in matching URV value or adjust pressure accordingly before you press [CORRECT] key in next step.
12	RESET K COR- RECT	<pre>U R V 1 P T 3 0 1 1 C O R R E C T U R V ?</pre>	Prompt asks if URV is to be calibrated to applied reference pressure. If it is to be calibrated, go to next Step. If it isn't, press [CLR] key and try again.
13	NON-VOL ENTER (Yes)	<pre>U R V 1 P T 3 0 1 1 S F C W O R K I N G . . . U R V C O R R E C T E D U R V 1 P T 3 0 1 1 2 0 0 . 0 0 " H 2 O _ 3 9 F</pre>	Calibrates URV to reference input pressure for span (100%) calibration.
14	SHIFT NON-VOL ENTER (Yes)	<pre>U R V 1 P T 3 0 1 1 S H I F T - U R V 1 P T 3 0 1 1 S F C W O R K I N G . . . U R V 1 P T 3 0 1 1 D A T A N O N V O L A T I L E L I N D P R E A D Y . . .</pre>	Initiate shift key selection Saves data in transmitter's nonvolatile memory. This takes approximately 8 seconds.

Continued on next page

10.4 Calibrating Range with SFC, Continued

Procedure, continued

Figure 52 Typical Calibration Hookup.

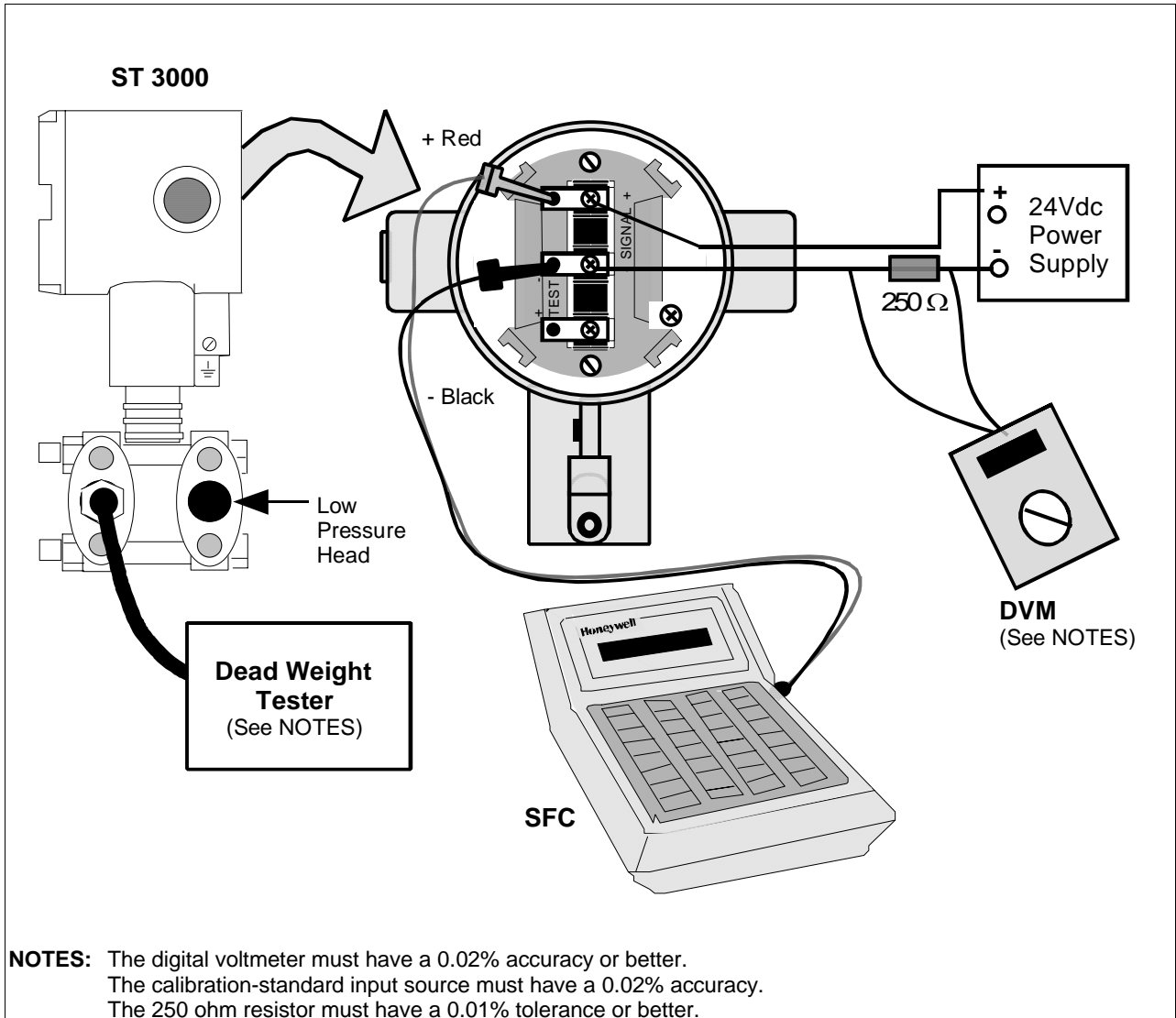

10.5 Resetting Calibration

Background

You can erase incorrect calibration data by resetting the data to default values through the SFC. The default values return the transmitter calibration to the original factory “characterization” values. Characterization calculates a mathematical model of the performance of the transmitter’s sensors and then stores that data in the transmitter’s memory. Note that this is **not** the “final calibration” which is done at the end of the process against the ordered range.

While resetting the calibration will return the transmitter to a close approximation of the previous calibration using its stored characterization data, the accuracy of the “reset” transmitter will be lower than the specified final calibrated accuracy. The calibration is not exact since the transmitter mounting angle may be different than the factory mounting angle. This means that the transmitter is calculating its output based on the characterization equation alone without any compensation for the small residual errors of zero offset and span correction.

For example, a typical zero offset correction is less than 0.1 inH₂O for a 400 inH₂O range and a typical span correction is less than 0.2% regardless of the range (down to the point where specification turndown begins). The typical performance of a 400 inH₂O transmitter after a calibration reset (or a “Corrects Reset” as it is often called) can be expressed as:

$$\text{Accuracy} = 0.2\% + \left(\frac{0.1 \text{ inH}_2\text{O}}{\text{Span inH}_2\text{O}} \right) \cdot 100\%$$

By correcting the zero input, the typical performance will be 0.2% or better.

For other transmitter ranges, the initial zero offset will be scaled by the ratio of the Upper Range Limit (URL) to 400 inH₂O at 39.2°F (4°C). Thus, for a 100 psi range, the initial zero offset can be expressed by:

$$0.1\text{inH}_2\text{O} \cdot \frac{2768\text{inH}_2\text{O}}{400\text{inH}_2\text{O}} = 0.7\text{inH}_2\text{O} \text{ or } 0.025\text{psi}$$

Note that these are **typical** values and they may vary. However, our patented characterization method includes several techniques which help to ensure that this level of performance can be achieved.

Continued on next page

10.5 Resetting Calibration, Continued

Procedure

The procedure in Table 59 shows how to reset calibration data in a transmitter with an SFC.

Table 59 Resetting Calibration Data With SFC

Step	Press Key	Read Display or Action	Description																																																																																																												
1		Connect SFC across loop wiring and turn it on.																																																																																																													
2	DE READ A ID	<table border="1"> <tr><td>T</td><td>A</td><td>G</td><td>N</td><td>O</td><td>.</td><td></td><td></td><td></td><td></td><td></td><td></td><td></td><td></td><td></td><td></td><td></td><td></td></tr> <tr><td>T</td><td>R</td><td>I</td><td>P</td><td>S</td><td>S</td><td>E</td><td>C</td><td>U</td><td>R</td><td>E</td><td>D</td><td>?</td><td>?</td><td></td><td></td><td></td><td></td></tr> </table>	T	A	G	N	O	.													T	R	I	P	S	S	E	C	U	R	E	D	?	?					Be sure any switches that may trip alarms or interlocks associated with analog loop are secured or turned off.																																																																								
T	A	G	N	O	.																																																																																																										
T	R	I	P	S	S	E	C	U	R	E	D	?	?																																																																																																		
3	NON-VOL ENTER (Yes)	<table border="1"> <tr><td>T</td><td>A</td><td>G</td><td>N</td><td>O</td><td>.</td><td></td><td></td><td></td><td></td><td></td><td></td><td></td><td></td><td></td><td></td><td></td><td></td></tr> <tr><td>S</td><td>F</td><td>C</td><td>W</td><td>O</td><td>R</td><td>K</td><td>I</td><td>N</td><td>G</td><td>.</td><td>.</td><td>.</td><td></td><td></td><td></td><td></td><td></td></tr> </table> <table border="1"> <tr><td>L</td><td>I</td><td>N</td><td></td><td>D</td><td>P</td><td>T</td><td>A</td><td>G</td><td>N</td><td>O</td><td>.</td><td></td><td></td><td></td><td></td><td></td><td></td></tr> <tr><td></td><td></td><td></td><td></td><td></td><td></td><td>P</td><td>T</td><td>3</td><td>Ø</td><td>1</td><td>1</td><td></td><td></td><td></td><td></td><td></td><td></td></tr> </table>	T	A	G	N	O	.													S	F	C	W	O	R	K	I	N	G	.	.	.						L	I	N		D	P	T	A	G	N	O	.													P	T	3	Ø	1	1							Confirm that "TRIPS" are secured and establish communications with sample transmitter PT 3011																																				
T	A	G	N	O	.																																																																																																										
S	F	C	W	O	R	K	I	N	G	.	.	.																																																																																																			
L	I	N		D	P	T	A	G	N	O	.																																																																																																				
						P	T	3	Ø	1	1																																																																																																				
4	^ SHIFT RESET K COR- RECT	<table border="1"> <tr><td>L</td><td>I</td><td>N</td><td></td><td>D</td><td>P</td><td>P</td><td>T</td><td>3</td><td>0</td><td>1</td><td>1</td><td></td><td></td><td></td><td></td><td></td><td></td></tr> <tr><td></td><td></td><td></td><td></td><td></td><td></td><td>S</td><td>H</td><td>I</td><td>F</td><td>T</td><td>-</td><td></td><td></td><td></td><td></td><td></td><td></td></tr> </table> <table border="1"> <tr><td></td><td></td><td></td><td></td><td></td><td></td><td>P</td><td>T</td><td>3</td><td>0</td><td>1</td><td>1</td><td></td><td></td><td></td><td></td><td></td><td></td></tr> <tr><td>R</td><td>E</td><td>S</td><td>E</td><td>T</td><td>C</td><td>O</td><td>R</td><td>R</td><td>E</td><td>C</td><td>T</td><td>S</td><td>?</td><td></td><td></td><td></td><td></td></tr> </table>	L	I	N		D	P	P	T	3	0	1	1													S	H	I	F	T	-													P	T	3	0	1	1							R	E	S	E	T	C	O	R	R	E	C	T	S	?					Initiate shift key selection Prompt asks if you want to correct calibration data by resetting it to default values. If you do want to reset data, go to next Step. If you don't, press [CLR] key to exit function.																																				
L	I	N		D	P	P	T	3	0	1	1																																																																																																				
						S	H	I	F	T	-																																																																																																				
						P	T	3	0	1	1																																																																																																				
R	E	S	E	T	C	O	R	R	E	C	T	S	?																																																																																																		
5	NON-VOL ENTER (Yes)	<table border="1"> <tr><td></td><td></td><td></td><td></td><td></td><td></td><td>P</td><td>T</td><td>3</td><td>0</td><td>1</td><td>1</td><td>#</td><td></td><td></td><td></td><td></td><td></td></tr> <tr><td>S</td><td>F</td><td>C</td><td>W</td><td>O</td><td>R</td><td>K</td><td>I</td><td>N</td><td>G</td><td>.</td><td>.</td><td>.</td><td></td><td></td><td></td><td></td><td></td></tr> </table> <table border="1"> <tr><td></td><td></td><td></td><td></td><td></td><td></td><td>P</td><td>T</td><td>3</td><td>0</td><td>1</td><td>1</td><td>#</td><td></td><td></td><td></td><td></td><td></td></tr> <tr><td>C</td><td>O</td><td>R</td><td>R</td><td>E</td><td>C</td><td>T</td><td>S</td><td></td><td>R</td><td>E</td><td>S</td><td>E</td><td>T</td><td></td><td></td><td></td><td></td></tr> </table> <table border="1"> <tr><td>L</td><td>I</td><td>N</td><td></td><td>D</td><td>P</td><td>P</td><td>T</td><td>3</td><td>0</td><td>1</td><td>1</td><td>#</td><td></td><td></td><td></td><td></td><td></td></tr> <tr><td></td><td></td><td></td><td></td><td></td><td></td><td>R</td><td>E</td><td>A</td><td>D</td><td>Y</td><td>.</td><td>.</td><td></td><td></td><td></td><td></td><td></td></tr> </table>							P	T	3	0	1	1	#						S	F	C	W	O	R	K	I	N	G	.	.	.												P	T	3	0	1	1	#						C	O	R	R	E	C	T	S		R	E	S	E	T					L	I	N		D	P	P	T	3	0	1	1	#												R	E	A	D	Y	.	.						Previous calibration "CORRECTS" are removed and calibration is reset to default characterization values as indicated by non-critical status symbol "#" on right-hand side of display. Symbol remains on display until transmitter is recalibrated. ATTENTION The accuracy of the reset transmitter will be approximately 0.2% at reference conditions – See the Background paragraph in this section for more details. .
						P	T	3	0	1	1	#																																																																																																			
S	F	C	W	O	R	K	I	N	G	.	.	.																																																																																																			
						P	T	3	0	1	1	#																																																																																																			
C	O	R	R	E	C	T	S		R	E	S	E	T																																																																																																		
L	I	N		D	P	P	T	3	0	1	1	#																																																																																																			
						R	E	A	D	Y	.	.																																																																																																			

Section 11 —Troubleshooting

11.1 Introduction

Section Contents

This section includes these topics

Section	Topic	See Page
11.1	Introduction	195
11.2	Overview	196
11.3	Clearing the “#” Symbol From SFC Display	197
11.4	Diagnostic Messages	199
11.5	Running Status Check	202
11.6	Interpreting Messages.....	203
11.7	Checking SFC Display and Keyboard	207

About this section

This section identifies diagnostic messages that may appear in the SFC and describes what they mean. An interpretation of diagnostic messages is given which suggests possible cause and corrective action for each message. Procedures are provided for running a status check and testing the SFC keyboard.

11.2 Overview

Diagnostics

The SFC and ST 3000 transmitter are constantly running internal diagnostics to monitor the functions and status of the control loop and their communications link.

When a diagnostic failure is detected, a corresponding message is generated for the SFC display. See Section 11.4 Diagnostic Messages for details.

ATTENTION

There are additional diagnostics provided by the STIMV IOP for transmitters integrated with the TPS system and any message will appear in the TRANSMITTER STATUS field of the Detail Display in the Universal Station. Details about the STIMV IOP diagnostic messages are given in the *PM/APM Smartline Transmitter Integration Manual PM12-410* which is part of the TDC 3000^X system bookset.

Troubleshooting tool

Your primary troubleshooting tool is using the SFC to run a status check, recording displayed diagnostic messages, and then interpreting the diagnostic messages. See Table 66 to run a status check using an SFC.

You should also use the SFC to verify the transmitter's configuration data and check to be sure your process is operating correctly.

11.3 Clearing the “#” Symbol From SFC Display

About the “#” symbol When transmitter diagnostics detect a non-critical status condition, the number symbol “#” appears as the last character in the top row of the SFC display along with whatever you are displaying at the time. Thus, the purpose of the # symbol is simply to let you know that a non-critical status condition exists.

Procedure To clear the # symbol from the SFC display, you must first determine what non-critical status condition exists and then correct it. The general procedure would be:

- Press [STAT] key on SFC and record diagnostic messages that appear in bottom row of display.
- Use Table 60 as an aid in determining the possible cause of the diagnostic message and the suggested corrective action to take to clear the # symbol.
- The # symbol will disappear from the display when the diagnostic condition is corrected.

Table 60 Clearing the # Symbol from the SFC Display

If Message is . . .	Then, Possible Cause is . . .	And, Suggested Corrective Action is . . .																													
<table border="1"> <tr><td>S</td><td>T</td><td>A</td><td>T</td><td>U</td><td>S</td><td></td><td>P</td><td>T</td><td>3</td><td>0</td><td>1</td><td>1</td><td>#</td></tr> <tr><td>C</td><td>O</td><td>R</td><td>R</td><td>E</td><td>C</td><td>T</td><td>S</td><td></td><td>R</td><td>E</td><td>S</td><td>E</td><td>T</td></tr> </table>	S	T	A	T	U	S		P	T	3	0	1	1	#	C	O	R	R	E	C	T	S		R	E	S	E	T	All calibration “CORRECTS” were deleted and data was reset to default characterization values.	Recalibrate transmitter.	
S	T	A	T	U	S		P	T	3	0	1	1	#																		
C	O	R	R	E	C	T	S		R	E	S	E	T																		
<table border="1"> <tr><td>S</td><td>T</td><td>A</td><td>T</td><td>U</td><td>S</td><td></td><td>P</td><td>T</td><td>3</td><td>0</td><td>1</td><td>1</td><td>#</td></tr> <tr><td>E</td><td>X</td><td>C</td><td>E</td><td>S</td><td>S</td><td></td><td>S</td><td>P</td><td>A</td><td>N</td><td>C</td><td>O</td><td>R</td><td>R</td></tr> </table>	S	T	A	T	U	S		P	T	3	0	1	1	#	E	X	C	E	S	S		S	P	A	N	C	O	R	R	SPAN correction factor is outside acceptable limits. Could be that transmitter was in output mode.	Check input pressure and be sure it matches calibrated range value. Check meter body. Do a URV CORRECT procedure.
S	T	A	T	U	S		P	T	3	0	1	1	#																		
E	X	C	E	S	S		S	P	A	N	C	O	R	R																	
<table border="1"> <tr><td>S</td><td>T</td><td>A</td><td>T</td><td>U</td><td>S</td><td></td><td>P</td><td>T</td><td>3</td><td>0</td><td>1</td><td>1</td><td>#</td></tr> <tr><td>E</td><td>X</td><td>C</td><td>E</td><td>S</td><td>S</td><td></td><td>Z</td><td>E</td><td>R</td><td>O</td><td>C</td><td>O</td><td>R</td><td>R</td></tr> </table>	S	T	A	T	U	S		P	T	3	0	1	1	#	E	X	C	E	S	S		Z	E	R	O	C	O	R	R	ZERO correction factor is outside acceptable limits. Could be that either INPUT was zero or transmitter was in output mode during a CORRECT procedure.	Check input pressure and be sure it matches calibrated range value. Check meter body. Do a LRV CORRECT procedure.
S	T	A	T	U	S		P	T	3	0	1	1	#																		
E	X	C	E	S	S		Z	E	R	O	C	O	R	R																	
<table border="1"> <tr><td>S</td><td>T</td><td>A</td><td>T</td><td>U</td><td>S</td><td></td><td>P</td><td>T</td><td>3</td><td>0</td><td>1</td><td>1</td><td>#</td></tr> <tr><td></td><td>I</td><td>N</td><td>O</td><td>U</td><td>T</td><td>P</td><td>U</td><td>T</td><td>M</td><td>O</td><td>D</td><td>E</td><td></td></tr> </table>	S	T	A	T	U	S		P	T	3	0	1	1	#		I	N	O	U	T	P	U	T	M	O	D	E		Transmitter is operating as a current source.	Press [OUTPUT] and [CLR] keys to tell transmitter to exit output mode.	
S	T	A	T	U	S		P	T	3	0	1	1	#																		
	I	N	O	U	T	P	U	T	M	O	D	E																			

Continued on next page

11.3 Clearing the “#” Symbol From SFC Display, Continued

Procedure, continued

Table 60 Clearing the # Symbol from the SFC Display, continued

If Message is. . .	Then, Possible Cause is. . .	And, Suggested Corrective Action is. . .																																																								
<table border="1" style="width: 100%; text-align: center;"> <tr><td>S</td><td>T</td><td>A</td><td>T</td><td>U</td><td>S</td><td></td><td>P</td><td>T</td><td>3</td><td>0</td><td>1</td><td>1</td><td>#</td></tr> <tr><td>M</td><td>.</td><td>B</td><td>.</td><td>O</td><td>V</td><td>E</td><td>R</td><td>L</td><td>O</td><td>A</td><td>D</td><td></td><td></td></tr> </table> <p style="text-align: center;">OR</p> <table border="1" style="width: 100%; text-align: center;"> <tr><td>S</td><td>T</td><td>A</td><td>T</td><td>U</td><td>S</td><td></td><td>P</td><td>T</td><td>3</td><td>0</td><td>1</td><td>1</td><td>#</td></tr> <tr><td>M</td><td>E</td><td>T</td><td>E</td><td>R</td><td>B</td><td>O</td><td>D</td><td>Y</td><td>F</td><td>A</td><td>U</td><td>L</td><td>T</td></tr> </table>	S	T	A	T	U	S		P	T	3	0	1	1	#	M	.	B	.	O	V	E	R	L	O	A	D			S	T	A	T	U	S		P	T	3	0	1	1	#	M	E	T	E	R	B	O	D	Y	F	A	U	L	T	<p>Pressure input is two times greater than URL of transmitter.</p>	<ul style="list-style-type: none"> • Check range and, if required, replace transmitter with one that has a wider range. • Meter body may have been damaged. Check the transmitter for accuracy and linearity. Replace meter body and recalibrate, if needed.
S	T	A	T	U	S		P	T	3	0	1	1	#																																													
M	.	B	.	O	V	E	R	L	O	A	D																																															
S	T	A	T	U	S		P	T	3	0	1	1	#																																													
M	E	T	E	R	B	O	D	Y	F	A	U	L	T																																													
<table border="1" style="width: 100%; text-align: center;"> <tr><td>S</td><td>T</td><td>A</td><td>T</td><td>U</td><td>S</td><td></td><td>P</td><td>T</td><td>3</td><td>0</td><td>1</td><td>1</td><td>#</td></tr> <tr><td>N</td><td>O</td><td>D</td><td>A</td><td>C</td><td>T</td><td>E</td><td>M</td><td>P</td><td>C</td><td>O</td><td>M</td><td>P</td><td></td></tr> </table>	S	T	A	T	U	S		P	T	3	0	1	1	#	N	O	D	A	C	T	E	M	P	C	O	M	P		<p>No temperature compensation data exists for D/A converter.</p>	<p>Effect will be minor degradation of ambient temperature influence specifications. Replace electronics module</p>																												
S	T	A	T	U	S		P	T	3	0	1	1	#																																													
N	O	D	A	C	T	E	M	P	C	O	M	P																																														
<table border="1" style="width: 100%; text-align: center;"> <tr><td>S</td><td>T</td><td>A</td><td>T</td><td>U</td><td>S</td><td></td><td>P</td><td>T</td><td>3</td><td>0</td><td>1</td><td>1</td><td>#</td></tr> <tr><td>S</td><td>E</td><td>N</td><td>S</td><td>O</td><td>R</td><td></td><td>O</td><td>V</td><td>E</td><td>R</td><td>T</td><td>E</td><td>M</td><td>P</td></tr> </table>	S	T	A	T	U	S		P	T	3	0	1	1	#	S	E	N	S	O	R		O	V	E	R	T	E	M	P	<p>Meter body temperature is too high. Accuracy and life span may decrease if it remains high.</p>	<p>Take steps to insulate meter body from temperature source.</p>																											
S	T	A	T	U	S		P	T	3	0	1	1	#																																													
S	E	N	S	O	R		O	V	E	R	T	E	M	P																																												
<table border="1" style="width: 100%; text-align: center;"> <tr><td>S</td><td>T</td><td>A</td><td>T</td><td>U</td><td>S</td><td></td><td>P</td><td>T</td><td>3</td><td>0</td><td>1</td><td>1</td><td>#</td></tr> <tr><td>U</td><td>N</td><td>K</td><td>N</td><td>O</td><td>W</td><td>N</td><td></td><td></td><td></td><td></td><td></td><td></td><td></td></tr> </table>	S	T	A	T	U	S		P	T	3	0	1	1	#	U	N	K	N	O	W	N								<p>Selection is unknown</p>	<p>Be sure SFC software is latest version. Press SHIFT and 3 to view SFC software version.</p>																												
S	T	A	T	U	S		P	T	3	0	1	1	#																																													
U	N	K	N	O	W	N																																																				

11.4 Diagnostic Messages

Summary

The diagnostic messages can be grouped into one of these five categories.

- Non-Critical Failures — Transmitter continues to calculate PV output.
- Critical Failures — Transmitter drives PV output to failsafe state.
- Communications Errors
- Invalid Key Entry Errors
- Interrupt Messages

A description of the messages in each category is given in the following paragraphs. Note that there also a few messages that we have grouped as general interrupt messages at the end of this section.

Non-critical failures

Table 61 summarizes the non-critical SFC status message displays. All SFC functions remain operational during a non-critical failure and the “#” sign appears on the right hand side of the display.

Table 61 Summary of Diagnostic Messages for Non-Critical Failures

Message	Description																																																								
<table border="1"> <tr><td>S</td><td>T</td><td>A</td><td>T</td><td>U</td><td>S</td><td></td><td>P</td><td>T</td><td>3</td><td>0</td><td>1</td><td>1</td><td>#</td></tr> <tr><td>C</td><td>O</td><td>R</td><td>R</td><td>E</td><td>C</td><td>T</td><td>S</td><td></td><td>R</td><td>E</td><td>S</td><td>E</td><td>T</td></tr> </table>	S	T	A	T	U	S		P	T	3	0	1	1	#	C	O	R	R	E	C	T	S		R	E	S	E	T	Must recalibrate transmitter to attain required accuracy.																												
S	T	A	T	U	S		P	T	3	0	1	1	#																																												
C	O	R	R	E	C	T	S		R	E	S	E	T																																												
<table border="1"> <tr><td>S</td><td>T</td><td>A</td><td>T</td><td>U</td><td>S</td><td></td><td>P</td><td>T</td><td>3</td><td>0</td><td>1</td><td>1</td><td>#</td></tr> <tr><td>E</td><td>X</td><td>C</td><td>E</td><td>S</td><td>S</td><td>S</td><td>P</td><td>A</td><td>N</td><td>C</td><td>O</td><td>R</td><td>R</td></tr> </table>	S	T	A	T	U	S		P	T	3	0	1	1	#	E	X	C	E	S	S	S	P	A	N	C	O	R	R	SPAN correction factor is outside the acceptable limits for accurate operation.																												
S	T	A	T	U	S		P	T	3	0	1	1	#																																												
E	X	C	E	S	S	S	P	A	N	C	O	R	R																																												
<table border="1"> <tr><td>S</td><td>T</td><td>A</td><td>T</td><td>U</td><td>S</td><td></td><td>P</td><td>T</td><td>3</td><td>0</td><td>1</td><td>1</td><td>#</td></tr> <tr><td>E</td><td>X</td><td>C</td><td>E</td><td>S</td><td>S</td><td>Z</td><td>E</td><td>R</td><td>O</td><td>C</td><td>O</td><td>R</td><td>R</td></tr> </table>	S	T	A	T	U	S		P	T	3	0	1	1	#	E	X	C	E	S	S	Z	E	R	O	C	O	R	R	Zero calibration value is too large. Excess zero correction may be an indication of a problem with the process or installation.																												
S	T	A	T	U	S		P	T	3	0	1	1	#																																												
E	X	C	E	S	S	Z	E	R	O	C	O	R	R																																												
<table border="1"> <tr><td>S</td><td>T</td><td>A</td><td>T</td><td>U</td><td>S</td><td></td><td>P</td><td>T</td><td>3</td><td>0</td><td>1</td><td>1</td><td>#</td></tr> <tr><td>I</td><td>N</td><td>O</td><td>U</td><td>T</td><td>P</td><td>U</td><td>T</td><td>M</td><td>O</td><td>D</td><td>E</td><td></td><td></td></tr> </table>	S	T	A	T	U	S		P	T	3	0	1	1	#	I	N	O	U	T	P	U	T	M	O	D	E			Transmitter is operating as current source.																												
S	T	A	T	U	S		P	T	3	0	1	1	#																																												
I	N	O	U	T	P	U	T	M	O	D	E																																														
<table border="1"> <tr><td>S</td><td>T</td><td>A</td><td>T</td><td>U</td><td>S</td><td></td><td>P</td><td>T</td><td>3</td><td>0</td><td>1</td><td>1</td><td>#</td></tr> <tr><td>M</td><td>.</td><td>B</td><td>.</td><td>O</td><td>V</td><td>E</td><td>R</td><td>L</td><td>O</td><td>A</td><td>D</td><td></td><td></td></tr> </table> <p style="text-align: center;">OR</p> <table border="1"> <tr><td>S</td><td>T</td><td>A</td><td>T</td><td>U</td><td>S</td><td></td><td>P</td><td>T</td><td>3</td><td>0</td><td>1</td><td>1</td><td>#</td></tr> <tr><td>M</td><td>E</td><td>T</td><td>E</td><td>R</td><td>B</td><td>O</td><td>D</td><td>Y</td><td>F</td><td>A</td><td>U</td><td>L</td><td>T</td></tr> </table>	S	T	A	T	U	S		P	T	3	0	1	1	#	M	.	B	.	O	V	E	R	L	O	A	D			S	T	A	T	U	S		P	T	3	0	1	1	#	M	E	T	E	R	B	O	D	Y	F	A	U	L	T	Input pressure is more that 2 times greater than the Upper Range Limit of the transmitter.
S	T	A	T	U	S		P	T	3	0	1	1	#																																												
M	.	B	.	O	V	E	R	L	O	A	D																																														
S	T	A	T	U	S		P	T	3	0	1	1	#																																												
M	E	T	E	R	B	O	D	Y	F	A	U	L	T																																												
<table border="1"> <tr><td>S</td><td>T</td><td>A</td><td>T</td><td>U</td><td>S</td><td></td><td>P</td><td>T</td><td>3</td><td>0</td><td>1</td><td>1</td><td>#</td></tr> <tr><td>N</td><td>O</td><td>D</td><td>A</td><td>C</td><td>T</td><td>E</td><td>M</td><td>P</td><td>C</td><td>O</td><td>M</td><td>P</td><td></td></tr> </table>	S	T	A	T	U	S		P	T	3	0	1	1	#	N	O	D	A	C	T	E	M	P	C	O	M	P		No temperature compensation data exists for D/A converter.																												
S	T	A	T	U	S		P	T	3	0	1	1	#																																												
N	O	D	A	C	T	E	M	P	C	O	M	P																																													
<table border="1"> <tr><td>S</td><td>T</td><td>A</td><td>T</td><td>U</td><td>S</td><td></td><td>P</td><td>T</td><td>3</td><td>0</td><td>1</td><td>1</td><td>#</td></tr> <tr><td>S</td><td>E</td><td>N</td><td>S</td><td>O</td><td>R</td><td>O</td><td>V</td><td>E</td><td>R</td><td>T</td><td>E</td><td>M</td><td>P</td></tr> </table>	S	T	A	T	U	S		P	T	3	0	1	1	#	S	E	N	S	O	R	O	V	E	R	T	E	M	P	Meter body temperature is too high.																												
S	T	A	T	U	S		P	T	3	0	1	1	#																																												
S	E	N	S	O	R	O	V	E	R	T	E	M	P																																												
<table border="1"> <tr><td>S</td><td>T</td><td>A</td><td>T</td><td>U</td><td>S</td><td></td><td>P</td><td>T</td><td>3</td><td>0</td><td>1</td><td>1</td><td>#</td></tr> <tr><td>U</td><td>N</td><td>K</td><td>N</td><td>O</td><td>W</td><td>N</td><td></td><td></td><td></td><td></td><td></td><td></td><td></td></tr> </table>	S	T	A	T	U	S		P	T	3	0	1	1	#	U	N	K	N	O	W	N								Status is unknown.																												
S	T	A	T	U	S		P	T	3	0	1	1	#																																												
U	N	K	N	O	W	N																																																			

Continued on next page

11.4 Diagnostic Messages, Continued

Critical failures

Table 62 summarizes the critical SFC status message displays. A critical failure has these effects on SFC operation.

- Only ID, OUTPUT, and STATUS functions remain operational.
- The critical status message is displayed for three seconds followed by the applicable status message. Run the status check to view messages again.
- The transmitter's output is driven to its failsafe direction - upscale or downscale.

Table 62 Summary of Diagnostic Messages for Critical Failures

Message	Description																											
<table border="1"> <tr><td>O</td><td>U</td><td>T</td><td>P</td><td>1</td><td></td><td>P</td><td>T</td><td>3</td><td>0</td><td>1</td><td>1</td></tr> <tr><td>C</td><td>H</td><td>A</td><td>R</td><td>P</td><td>R</td><td>O</td><td>M</td><td>F</td><td>A</td><td>U</td><td>L</td><td>T</td></tr> </table>	O	U	T	P	1		P	T	3	0	1	1	C	H	A	R	P	R	O	M	F	A	U	L	T	Characterization PROM failure.		
O	U	T	P	1		P	T	3	0	1	1																	
C	H	A	R	P	R	O	M	F	A	U	L	T																
<table border="1"> <tr><td>O</td><td>U</td><td>T</td><td>P</td><td>1</td><td></td><td>P</td><td>T</td><td>3</td><td>0</td><td>1</td><td>1</td></tr> <tr><td>E</td><td>L</td><td>E</td><td>C</td><td>T</td><td>R</td><td>O</td><td>N</td><td>I</td><td>C</td><td>S</td><td><</td><td>A</td><td>></td></tr> </table>	O	U	T	P	1		P	T	3	0	1	1	E	L	E	C	T	R	O	N	I	C	S	<	A	>	No temperature compensation data exists for calculations.	
O	U	T	P	1		P	T	3	0	1	1																	
E	L	E	C	T	R	O	N	I	C	S	<	A	>															
<table border="1"> <tr><td>O</td><td>U</td><td>T</td><td>P</td><td>1</td><td></td><td>P</td><td>T</td><td>3</td><td>0</td><td>1</td><td>1</td></tr> <tr><td>E</td><td>L</td><td>E</td><td>C</td><td>T</td><td>R</td><td>O</td><td>N</td><td>I</td><td>C</td><td>S</td><td><</td><td>B</td><td>></td></tr> </table>	O	U	T	P	1		P	T	3	0	1	1	E	L	E	C	T	R	O	N	I	C	S	<	B	>	Transmitter's nonvolatile memory (NVM) fault.	
O	U	T	P	1		P	T	3	0	1	1																	
E	L	E	C	T	R	O	N	I	C	S	<	B	>															
<table border="1"> <tr><td>O</td><td>U</td><td>T</td><td>P</td><td>1</td><td></td><td>P</td><td>T</td><td>3</td><td>0</td><td>1</td><td>1</td></tr> <tr><td>E</td><td>L</td><td>E</td><td>C</td><td>T</td><td>R</td><td>O</td><td>N</td><td>I</td><td>C</td><td>S</td><td><</td><td>C</td><td>></td></tr> </table>	O	U	T	P	1		P	T	3	0	1	1	E	L	E	C	T	R	O	N	I	C	S	<	C	>	Transmitter's random access memory (RAM) fault.	
O	U	T	P	1		P	T	3	0	1	1																	
E	L	E	C	T	R	O	N	I	C	S	<	C	>															
<table border="1"> <tr><td>O</td><td>U</td><td>T</td><td>P</td><td>1</td><td></td><td>P</td><td>T</td><td>3</td><td>0</td><td>1</td><td>1</td></tr> <tr><td>E</td><td>L</td><td>E</td><td>C</td><td>T</td><td>R</td><td>O</td><td>N</td><td>I</td><td>C</td><td>S</td><td><</td><td>D</td><td>></td></tr> </table>	O	U	T	P	1		P	T	3	0	1	1	E	L	E	C	T	R	O	N	I	C	S	<	D	>	Transmitter's programmable read only memory (PROM) fault.	
O	U	T	P	1		P	T	3	0	1	1																	
E	L	E	C	T	R	O	N	I	C	S	<	D	>															
<table border="1"> <tr><td>S</td><td>T</td><td>A</td><td>T</td><td>U</td><td>S</td><td></td><td>P</td><td>T</td><td>3</td><td>0</td><td>1</td><td>1</td></tr> <tr><td>M</td><td>E</td><td>T</td><td>E</td><td>R</td><td>B</td><td>O</td><td>D</td><td>Y</td><td>F</td><td>A</td><td>U</td><td>L</td><td>T</td></tr> </table>	S	T	A	T	U	S		P	T	3	0	1	1	M	E	T	E	R	B	O	D	Y	F	A	U	L	T	Electronics (PWA) and meter body are incompatible.
S	T	A	T	U	S		P	T	3	0	1	1																
M	E	T	E	R	B	O	D	Y	F	A	U	L	T															
<table border="1"> <tr><td>O</td><td>U</td><td>T</td><td>P</td><td>1</td><td></td><td>P</td><td>T</td><td>3</td><td>0</td><td>1</td><td>1</td></tr> <tr><td>S</td><td>U</td><td>S</td><td>P</td><td>E</td><td>C</td><td>T</td><td>I</td><td>N</td><td>P</td><td>U</td><td>T</td><td></td><td></td></tr> </table>	O	U	T	P	1		P	T	3	0	1	1	S	U	S	P	E	C	T	I	N	P	U	T			Possible meter body or electronics based problem.	
O	U	T	P	1		P	T	3	0	1	1																	
S	U	S	P	E	C	T	I	N	P	U	T																	

Communication errors

Table 63 summarizes the message displays associated with communication errors. A communication error has these effects on SFC operation.

- All the SFC functions are disabled.
- Communication error messages are cycled in the display at two second intervals. Press [ID] and then [ENTER] to view messages again.

Table 63 Summary of Diagnostic Messages for Communication Errors

Message	Description																													
<table border="1"> <tr><td>T</td><td>A</td><td>G</td><td>N</td><td>O</td><td>.</td><td></td><td></td><td></td><td></td><td></td><td></td><td></td><td></td></tr> <tr><td>E</td><td>N</td><td>D</td><td>A</td><td>R</td><td>O</td><td>U</td><td>N</td><td>D</td><td>E</td><td>R</td><td>R</td><td></td><td></td></tr> </table>	T	A	G	N	O	.									E	N	D	A	R	O	U	N	D	E	R	R			Communications is unsuccessful.	
T	A	G	N	O	.																									
E	N	D	A	R	O	U	N	D	E	R	R																			
<table border="1"> <tr><td>T</td><td>A</td><td>G</td><td>N</td><td>O</td><td>.</td><td></td><td></td><td></td><td></td><td></td><td></td><td></td><td></td></tr> <tr><td>F</td><td>A</td><td>I</td><td>L</td><td>E</td><td>D</td><td>C</td><td>O</td><td>M</td><td>M</td><td>C</td><td>H</td><td>K</td><td></td></tr> </table>	T	A	G	N	O	.									F	A	I	L	E	D	C	O	M	M	C	H	K		SFC failed a communication diagnostic test.	
T	A	G	N	O	.																									
F	A	I	L	E	D	C	O	M	M	C	H	K																		
<table border="1"> <tr><td>T</td><td>A</td><td>G</td><td>N</td><td>O</td><td>.</td><td></td><td></td><td></td><td></td><td></td><td></td><td></td><td></td></tr> <tr><td>H</td><td>I</td><td>R</td><td>E</td><td>S</td><td>/</td><td>L</td><td>O</td><td>V</td><td>O</td><td>L</td><td>T</td><td></td><td></td></tr> </table>	T	A	G	N	O	.									H	I	R	E	S	/	L	O	V	O	L	T			Loop resistance is too large or supply voltage is too low.	
T	A	G	N	O	.																									
H	I	R	E	S	/	L	O	V	O	L	T																			
<table border="1"> <tr><td>T</td><td>A</td><td>G</td><td>N</td><td>O</td><td>.</td><td></td><td></td><td></td><td></td><td></td><td></td><td></td><td></td></tr> <tr><td>I</td><td>L</td><td>L</td><td>E</td><td>G</td><td>A</td><td>L</td><td>R</td><td>E</td><td>S</td><td>P</td><td>O</td><td>N</td><td>S</td><td>E</td></tr> </table>	T	A	G	N	O	.									I	L	L	E	G	A	L	R	E	S	P	O	N	S	E	Illegal response from transmitter.
T	A	G	N	O	.																									
I	L	L	E	G	A	L	R	E	S	P	O	N	S	E																

Continued on next page

11.4 Diagnostic Messages, Continued

Communication errors, continued

Table 63 Summary of Diagnostic Messages for Communication Errors, continued

Message	Description
T A G N O . I N V A L I D D A T A B A S E	Transmitter database was incorrect at powerup.
T A G N O . I N V A L I D R E Q U E S T	Request is invalid.
T A G N O . L O W L O O P R E S	Loop resistance is too low.
T A G N O . N O X M T R R E S P O N S E	No response from transmitter.
T A G N O . S F C F A U L T	SFC is not operating properly.

Invalid key entry errors

Table 64 summarizes the message displays for possible invalid key entry errors.

Table 64 Summary of Diagnostic Messages for Invalid Key Entry Errors

Message	Description
None - Keystroke makes display blink	Invalid keystroke
U R V 1 . P T 3 0 1 1 > R A N G E " H 2 O _ 3 9 F	The computed SFC value is outside the display range.

Interrupt messages

Table 65 summarizes messages that may interrupt the SFC display.

Table 65 Summary of Interrupt Messages For SFC Display

Message	Meaning	Remedy
O U T P 1 P T 3 0 1 1 C R I T I C A L S T A T U S	Diagnostics has detected a critical failure.	Press [STAT] key to retrieve messages.
L I N D P : A G N O . P T 3 0 1 1 Colon	The SFC battery is low.	Recharge the battery.
L I N D P P T 3 0 1 1 # R E A D Y . . . Number Symbol	Diagnostics has detected a non-critical failure. Or, the transmitter is in its output mode.	Press [STAT] key to retrieve messages or exit the output mode.

11.5 Running Status Check

Procedure The procedure in Table 66 shows how to run a status check using the SFC.

Table 66 Running a Status Check With SFC

Step	Press Key	Read Display or Action	Description																																																																																																																																																																																																
1		Connect SFC across loop wiring for transmitter whose status is to be checked	Be sure to put analog loop into manual mode.																																																																																																																																																																																																
2	DE READ ID	<table border="1"> <tr><td>T</td><td>A</td><td>G</td><td>N</td><td>O</td><td>.</td><td></td><td></td><td></td><td></td><td></td><td></td><td></td><td></td><td></td><td></td></tr> <tr><td>T</td><td>R</td><td>I</td><td>P</td><td>S</td><td>S</td><td>E</td><td>C</td><td>U</td><td>R</td><td>E</td><td>D</td><td>?</td><td>?</td><td></td><td></td></tr> </table>	T	A	G	N	O	.											T	R	I	P	S	S	E	C	U	R	E	D	?	?			Be sure any switches that may trip alarms or interlocks associated with analog loop are secured or turned off.																																																																																																																																																																
T	A	G	N	O	.																																																																																																																																																																																														
T	R	I	P	S	S	E	C	U	R	E	D	?	?																																																																																																																																																																																						
3	NON-VOL ENTER (Yes)	<table border="1"> <tr><td>T</td><td>A</td><td>G</td><td>N</td><td>O</td><td>.</td><td></td><td></td><td></td><td></td><td></td><td></td><td></td><td></td><td></td><td></td></tr> <tr><td>S</td><td>F</td><td>C</td><td>W</td><td>O</td><td>R</td><td>K</td><td>I</td><td>N</td><td>G</td><td>.</td><td>.</td><td>.</td><td></td><td></td><td></td></tr> </table> <table border="1"> <tr><td>L</td><td>I</td><td>N</td><td></td><td>D</td><td>P</td><td>T</td><td>A</td><td>G</td><td>N</td><td>O</td><td>.</td><td></td><td></td><td></td><td></td></tr> <tr><td></td><td></td><td></td><td></td><td></td><td></td><td>P</td><td>T</td><td>3</td><td>Ø</td><td>1</td><td>1</td><td></td><td></td><td></td><td></td></tr> </table>	T	A	G	N	O	.											S	F	C	W	O	R	K	I	N	G	.	.	.				L	I	N		D	P	T	A	G	N	O	.											P	T	3	Ø	1	1					<p>Confirm that "TRIPS" are secured and establish communications with sample transmitter PT 3011</p> <p>ATTENTION If a communications error is detected, applicable diagnostic messages will cycle at two-second intervals in the display and then display returns to the prompt PUT LOOP IN MAN. Repeat Steps 2 and 3 to view messages again. Communications is not established and all SFC functions are disabled.</p>																																																																																																																																
T	A	G	N	O	.																																																																																																																																																																																														
S	F	C	W	O	R	K	I	N	G	.	.	.																																																																																																																																																																																							
L	I	N		D	P	T	A	G	N	O	.																																																																																																																																																																																								
						P	T	3	Ø	1	1																																																																																																																																																																																								
4	F/S DIR STAT	<table border="1"> <tr><td>S</td><td>T</td><td>A</td><td>T</td><td>U</td><td>S</td><td></td><td>P</td><td>T</td><td>3</td><td>0</td><td>1</td><td>1</td><td></td><td></td><td></td></tr> <tr><td>S</td><td>F</td><td>C</td><td>W</td><td>O</td><td>R</td><td>K</td><td>I</td><td>N</td><td>G</td><td>.</td><td>.</td><td>.</td><td></td><td></td><td></td></tr> </table> <table border="1"> <tr><td>S</td><td>T</td><td>A</td><td>T</td><td>U</td><td>S</td><td></td><td>P</td><td>T</td><td>3</td><td>0</td><td>1</td><td>1</td><td></td><td></td><td></td></tr> <tr><td>S</td><td>T</td><td>A</td><td>T</td><td>U</td><td>S</td><td></td><td>C</td><td>H</td><td>E</td><td>C</td><td>K</td><td>=</td><td>O</td><td>K</td><td></td></tr> </table> <p>OR</p> <table border="1"> <tr><td>S</td><td>T</td><td>A</td><td>T</td><td>U</td><td>S</td><td></td><td>P</td><td>T</td><td>3</td><td>0</td><td>1</td><td>1</td><td>#</td><td></td><td></td></tr> <tr><td>S</td><td>E</td><td>N</td><td>S</td><td>O</td><td>R</td><td></td><td>O</td><td>V</td><td>E</td><td>R</td><td>T</td><td>E</td><td>M</td><td>P</td><td></td></tr> </table> <p>OR</p> <table border="1"> <tr><td>S</td><td>T</td><td>A</td><td>T</td><td>U</td><td>S</td><td></td><td>P</td><td>T</td><td>3</td><td>0</td><td>1</td><td>1</td><td></td><td></td><td></td></tr> <tr><td>C</td><td>R</td><td>I</td><td>T</td><td>I</td><td>C</td><td>A</td><td>L</td><td></td><td>S</td><td>T</td><td>A</td><td>T</td><td>U</td><td>S</td><td></td></tr> </table> <table border="1"> <tr><td>S</td><td>T</td><td>A</td><td>T</td><td>U</td><td>S</td><td></td><td>P</td><td>T</td><td>3</td><td>0</td><td>1</td><td>1</td><td></td><td></td><td></td></tr> <tr><td>S</td><td>S</td><td>U</td><td>S</td><td>P</td><td>E</td><td>C</td><td>T</td><td></td><td>I</td><td>N</td><td>P</td><td>U</td><td>T</td><td></td><td></td></tr> </table> <p>THEN</p> <table border="1"> <tr><td>L</td><td>I</td><td>N</td><td></td><td>D</td><td>P</td><td>P</td><td>T</td><td>3</td><td>0</td><td>1</td><td>1</td><td></td><td></td><td></td><td></td></tr> <tr><td>R</td><td>E</td><td>A</td><td>D</td><td>Y</td><td>.</td><td>.</td><td>.</td><td></td><td></td><td></td><td></td><td></td><td></td><td></td><td></td></tr> </table>	S	T	A	T	U	S		P	T	3	0	1	1				S	F	C	W	O	R	K	I	N	G	.	.	.				S	T	A	T	U	S		P	T	3	0	1	1				S	T	A	T	U	S		C	H	E	C	K	=	O	K		S	T	A	T	U	S		P	T	3	0	1	1	#			S	E	N	S	O	R		O	V	E	R	T	E	M	P		S	T	A	T	U	S		P	T	3	0	1	1				C	R	I	T	I	C	A	L		S	T	A	T	U	S		S	T	A	T	U	S		P	T	3	0	1	1				S	S	U	S	P	E	C	T		I	N	P	U	T			L	I	N		D	P	P	T	3	0	1	1					R	E	A	D	Y	.	.	.									<p>Initiate status check.</p> <p>Transmitter and SFC are operating normally.</p> <p>Diagnostic message appears for detected fault.</p> <p>Critical status appears followed by applicable diagnostic messages.</p> <p>Signals end of status messages for display. Press [STAT] key to display messages again. When there are two or more messages, they are cycled in display at 5-second intervals.</p>
S	T	A	T	U	S		P	T	3	0	1	1																																																																																																																																																																																							
S	F	C	W	O	R	K	I	N	G	.	.	.																																																																																																																																																																																							
S	T	A	T	U	S		P	T	3	0	1	1																																																																																																																																																																																							
S	T	A	T	U	S		C	H	E	C	K	=	O	K																																																																																																																																																																																					
S	T	A	T	U	S		P	T	3	0	1	1	#																																																																																																																																																																																						
S	E	N	S	O	R		O	V	E	R	T	E	M	P																																																																																																																																																																																					
S	T	A	T	U	S		P	T	3	0	1	1																																																																																																																																																																																							
C	R	I	T	I	C	A	L		S	T	A	T	U	S																																																																																																																																																																																					
S	T	A	T	U	S		P	T	3	0	1	1																																																																																																																																																																																							
S	S	U	S	P	E	C	T		I	N	P	U	T																																																																																																																																																																																						
L	I	N		D	P	P	T	3	0	1	1																																																																																																																																																																																								
R	E	A	D	Y	.	.	.																																																																																																																																																																																												

11.6 Interpreting Messages

Interpretation table Most of the diagnostic messages that can be displayed on the SFC are listed in alphabetical order in Table 67 along with a description and suggested action to be taken.

Table 67 Diagnostic Message Interpretation Table

Message	Possible Cause	What to Do
S T A T U S P T 3 0 1 1 C H A R P R O M F A U L T	Characterization PROM is not functioning correctly.	Replace meter body.
S T A T U S P T 3 0 1 1 # C O R R E C T S R E S E T	All calibration "CORRECTS" were deleted and data was reset to default values.	Recalibrate transmitter.
O U T P 1 P T 3 0 1 1 E L E C T R O N I C S < A >	No temperature compensation data exists for calculations.	Effect will be minor degradation of ambient temperature influence specifications. Replace electronics module (PWA).
O U T P 1 P T 3 0 1 1 E L E C T R O N I C S < B >	Transmitter's nonvolatile memory fault.	Replace electronics module (PWA).
O U T P 1 P T 3 0 1 1 E L E C T R O N I C S < C >	Transmitter's random access memory (RAM) fault.	Replace electronics module (PWA).
O U T P 1 P T 3 0 1 1 E L E C T R O N I C S < D >	Transmitter's programmable read only memory (PROM) fault.	Replace electronics module (PWA).
T A G N O . E N D A R O U N D E R R	Communications unsuccessful.	Check loop wiring and SFC connections. If error persists, replace transmitter.
S T A T U S P T 3 0 1 1 # E X C E S S S P A N C O R R	SPAN correction factor is outside acceptable limits. Could be that transmitter was in output mode.	Check input pressure and be sure it matches calibrated range value. Check meter body. Do a URV CORRECT procedure.
S T A T U S P T 3 0 1 1 # E X C E S S Z E R O C O R R	ZERO correction factor is outside acceptable limits. Could be that either INPUT was incorrect or transmitter was in output mode during a CORRECT procedure.	Check input pressure and be sure it matches calibrated range value. Check meter body. Do an LRV CORRECT procedure.
T A G N O . F A I L E D C O M M C H K	SFC failed a communications diagnostic check. Could be an SFC electronic problem or a faulty or dead communication loop.	<ul style="list-style-type: none"> • Check polarity and try again. • Press [STAT] and do any corrective action required and try again. • Check communication loop. • Replace SFC.
T A G N O . H I R E S / L O V O L T	Either there is too much resistance in loop (open circuit), voltage is too low, or both.	Check polarity, wiring, and power supply. There must be 11 volts minimum at transmitter to permit operation. Check for defective or misapplied capacitive or inductive devices (I/Ps) on the loop wiring.

Continued on next page

11.6 Interpreting Messages, Continued

Interpretation table,
continued

Table 67 Diagnostic Message Interpretation Table, continued

Message	Possible Cause	What to Do
S A V E / R E S T O R E H . W . M I S M A T C H	Hardware mismatch. Part of Save/Restore function.	Nothing – SFC tried to restore as much of database as possible.
S T A T U S P T 3 0 1 1 # I N O U T P U T M O D E	Transmitter is operating as a current source.	Press [OUTPUT] and [CLR] keys to tell transmitter to exit output mode.
T A G N O . I L L E G A L R E S P O N S E	Transmitter sent illegal response to SFC	Try communicating again.
T A G N O . I N V A L I D D A T A B A S E	Transmitter database was incorrect at powerup.	<ul style="list-style-type: none"> Try communicating again. Verify database configuration. Manually update non-volatile memory with each parameter.
U R V 1 . P T 3 0 1 1 I N V A L I D R E Q U E S T	<ul style="list-style-type: none"> Requesting transmitter to correct or set its URV to a value which results in too small a span, or correct its LRV or URV while in output mode. Keystroke is not valid for given transmitter. 	<ul style="list-style-type: none"> Check that correct URV calibration pressure is being applied to transmitter, or that transmitter is not in output mode. Check that keystroke is applicable for given transmitter.
T A G N O . L O W L O O P R E S	Not enough resistance in series with communication loop.	Check sensing resistor and increase resistance to at least 250Ω.
S T A T U S P T 3 0 1 1 # M . B . O V E R L O A D OR S T A T U S P T 3 0 1 1 # M E T E R B O D Y F A U L T	Pressure input is two times greater than URL of transmitter.	<ul style="list-style-type: none"> Check range and, if required, replace transmitter with one that has a wider range. Meter body may have been damaged. Check the transmitter for accuracy and linearity. Replace meter body and recalibrate, if needed.
S T A T U S P T 3 0 1 1 M E T E R B O D Y F A U L T	Electronics (PWA) and meter body are incompatible.	Obtain matching meter body for given transmitter model and series. Check transmitter nameplate for model number data.
S T A T U S P T 3 0 1 1 N A C K R E S P O N S E	Transmitter sent a negative response because it could not process one or more commands.	Check configuration and try again.

Continued on next page

11.6 Interpreting Messages, Continued

Interpretation table,
continued

Table 67 Diagnostic Message Interpretation Table, continued

Message	Possible Cause	What to Do
T A G N O . N O X M T R R E S P O N S E	No response from transmitter. Could be transmitter or loop failure.	<ul style="list-style-type: none"> Try communicating again. Press [ID] key and do any corrective action required and try again. Check that transmitter's loop integrity has been maintained, that SFC is connected properly, and that loop resistance is at least 250 Ω.
S T A T U S P T 3 0 1 1 N V M O N S E E M A N	SFC's CPU is misconfigured.	Replace SFC.
S A V E / R E S T O R E O P T I O N M I S M A T C H	On a database restore, one or more options do not match.	Nothing - SFC tried to restore as much of database as possible.
S A V E / R E S T O R E R E S T O R E F A I L E D	Database restore function failed.	Check transmitter and try again.
S T A T U S P T 3 0 1 1 # S E N S O R O V E R T E M P	Meter body temperature is too high. Accuracy and life span may decrease if it remains high.	Take steps to insulate meter body from temperature source.
S T A T U S P T 3 0 1 1 # S E N S O R T E M P F A I L	Transmitter's temperature sensor has failed.	Replace transmitter.
T A G N O . S F C F A U L T	SFC is operating incorrectly.	Try communicating again. If error still exists, replace SFC.
O U T P 1 P T 3 0 1 1 S U S P E C T I N P U T	Input data seems wrong. Could be a process problem, but it could also be a meter body or PWA problem.	Put transmitter in output mode and press [STAT] key. Diagnostic messages should identify where problem is. If no other diagnostic message is given, condition is most likely meter body related. Check installation and replace meter body if condition persists.
S A V E / R E S T O R E T Y P E M I S M A T C H	On database restore, transmitter types do not match.	Nothing - SFC tried to restore as much of database as possible.

Continued on next page

11.6 Interpreting Messages, Continued

Interpretation table,
continued

Table 67 Diagnostic Message Interpretation Table, continued

Message	Possible Cause	What to Do																													
<table border="1"> <tr> <td>S</td><td>T</td><td>A</td><td>T</td><td>U</td><td>S</td><td></td><td>P</td><td>T</td><td>3</td><td>0</td><td>1</td><td>1</td><td>#</td> </tr> <tr> <td>U</td><td>N</td><td>K</td><td>N</td><td>O</td><td>W</td><td>N</td><td></td><td></td><td></td><td></td><td></td><td></td><td></td> </tr> </table>	S	T	A	T	U	S		P	T	3	0	1	1	#	U	N	K	N	O	W	N								Selection is unknown.	Be sure SFC software is latest version. Press SHIFT and 3 to view SFC software version.	
S	T	A	T	U	S		P	T	3	0	1	1	#																		
U	N	K	N	O	W	N																									
<table border="1"> <tr> <td>U</td><td>R</td><td>V</td><td>1</td><td>.</td><td></td><td>P</td><td>T</td><td>3</td><td>0</td><td>1</td><td>1</td><td></td> </tr> <tr> <td></td><td>W</td><td>R</td><td>I</td><td>T</td><td>E</td><td></td><td>P</td><td>R</td><td>O</td><td>T</td><td>E</td><td>C</td><td>T</td><td>E</td><td>D</td> </tr> </table>	U	R	V	1	.		P	T	3	0	1	1			W	R	I	T	E		P	R	O	T	E	C	T	E	D	Transmitter's write protect jumper is in its read only position.	If authorized, move W/R jumper on PWA, make configuration change, then move back W/R jumper on PWA.
U	R	V	1	.		P	T	3	0	1	1																				
	W	R	I	T	E		P	R	O	T	E	C	T	E	D																
<table border="1"> <tr> <td>U</td><td>R</td><td>V</td><td>1</td><td>.</td><td></td><td>P</td><td>T</td><td>3</td><td>0</td><td>1</td><td>1</td><td></td> </tr> <tr> <td></td><td>></td><td>R</td><td>A</td><td>N</td><td>G</td><td>E</td><td>"</td><td>H</td><td>2</td><td>O</td><td>_</td><td>3</td><td>9</td><td>F</td> </tr> </table>	U	R	V	1	.		P	T	3	0	1	1			>	R	A	N	G	E	"	H	2	O	_	3	9	F	Value calculation is greater than display range.	Press [CLR] key and start again. Be sure special units conversion factor is not greater than display range.	
U	R	V	1	.		P	T	3	0	1	1																				
	>	R	A	N	G	E	"	H	2	O	_	3	9	F																	

11.7 Checking SFC Display and Keyboard

Procedure

The procedure in Table 68 shows how to run an SFC display and keyboard test.

Table 68 Running SFC Display and Keyboard Test

Step	Press Key	Read Display or Action	Description
1		Turn on SFC	
2	<div style="border: 1px solid black; padding: 2px; display: inline-block; text-align: center;"> [^] SHIFT </div> <div style="border: 1px solid black; padding: 2px; display: inline-block; text-align: center;"> ^W 2 </div>	<div style="border: 1px solid black; padding: 2px; display: inline-block; text-align: center;"> P U T L O O P I N M A N S H I F T - </div> <div style="border: 1px solid black; padding: 2px; display: inline-block; text-align: center;"> D I S P L A Y T E S T * * D I S P L A Y O K A Y * * </div> <div style="border: 1px solid black; padding: 2px; display: inline-block; text-align: center;"> K E Y B O A R D T E S T r o w * c o l u m n * </div>	<p>Initiate shift key selection.</p> <p>All display segments are working.</p> <p>Ready to check operation of individual keys.</p>
3	<div style="border: 1px solid black; padding: 2px; display: inline-block; text-align: center;"> ^E LRV 0% </div>	<div style="border: 1px solid black; padding: 2px; display: inline-block; text-align: center;"> K E Y B O A R D T E S T r o w 2 c o l u m n 1 </div>	<p>Confirm key operation by verifying that its row and column location on keyboard are displayed</p>
4		Repeat Step 3 as required to check all keys or go to Step 5 to exit test.	
5	NON-VOL <div style="border: 1px solid black; padding: 2px; display: inline-block; text-align: center;"> ENTER (Yes) </div>	<div style="border: 1px solid black; padding: 2px; display: inline-block; text-align: center;"> K E Y B O A R D T E S T r o w 8 c o l u m n 4 </div> <div style="border: 1px solid black; padding: 2px; display: inline-block; text-align: center;"> P U T L O O P I N M A N </div>	<p>Check [ENTER] key location.</p> <p>Ready for operation.</p>

Section 12 —Parts List

12.1 Replacement Parts

Part identification

- All individually salable parts are indicated in each figure by key number callout. For example, 1, 2, 3, and so on.
- All parts that are supplied in kits are indicated in each Figure by key number callout with the letter “K” prefix. For example, K1, K2, K3, and so on.
- Parts denoted with a “†” are recommended spares. See Table 81 for summary list of recommended spare parts.

Figure 53 shows major parts for given model with parts list Figure references.

Continued on next page

12.1 Replacement Parts, Continued

Figure 53 Major ST 3000 Smart Transmitter Parts Reference.

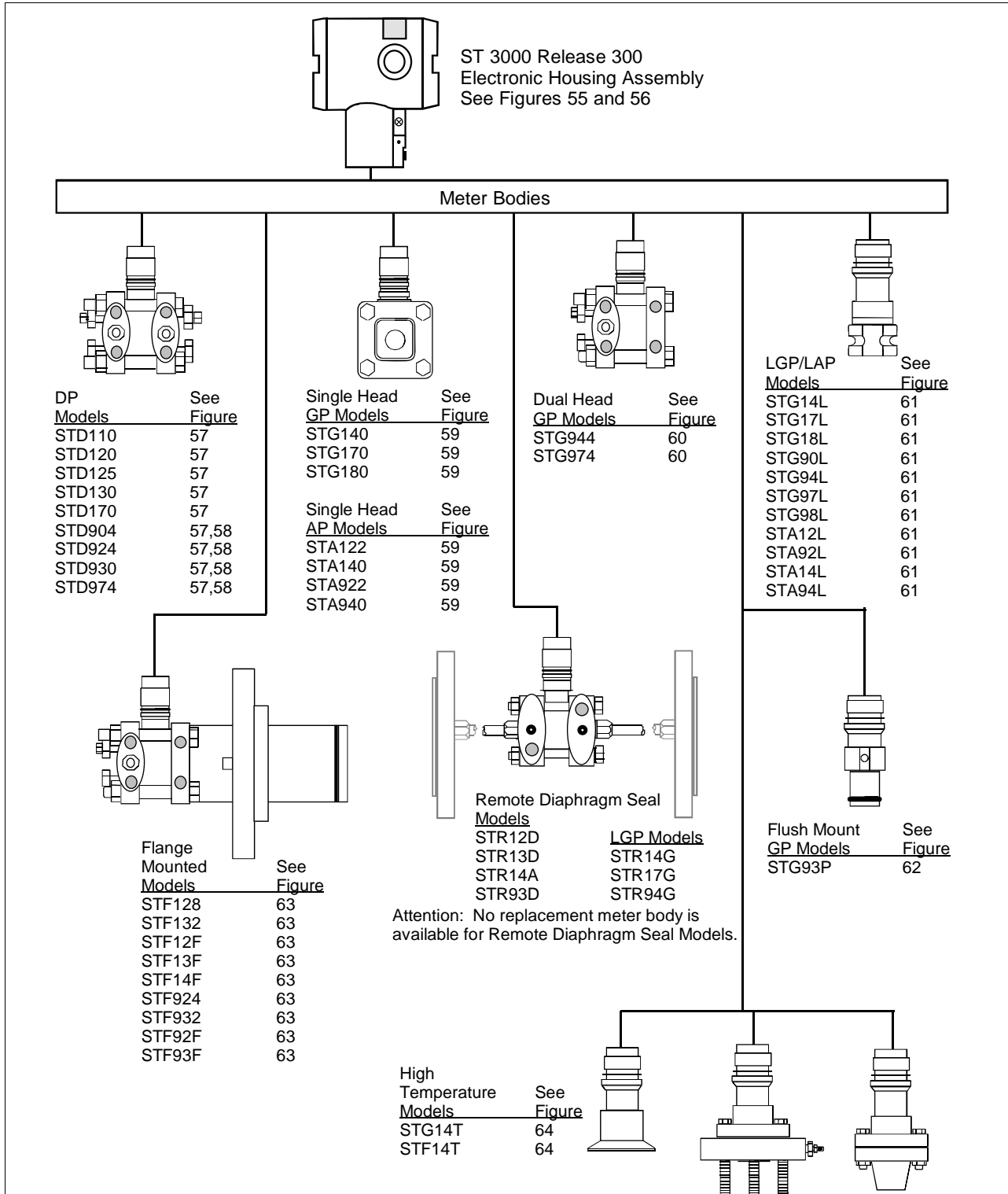

Continued on next page

12.1 Replacement Parts, Continued

Figure 54 ST 3000 Transmitter Mounting Bracket Parts Reference.

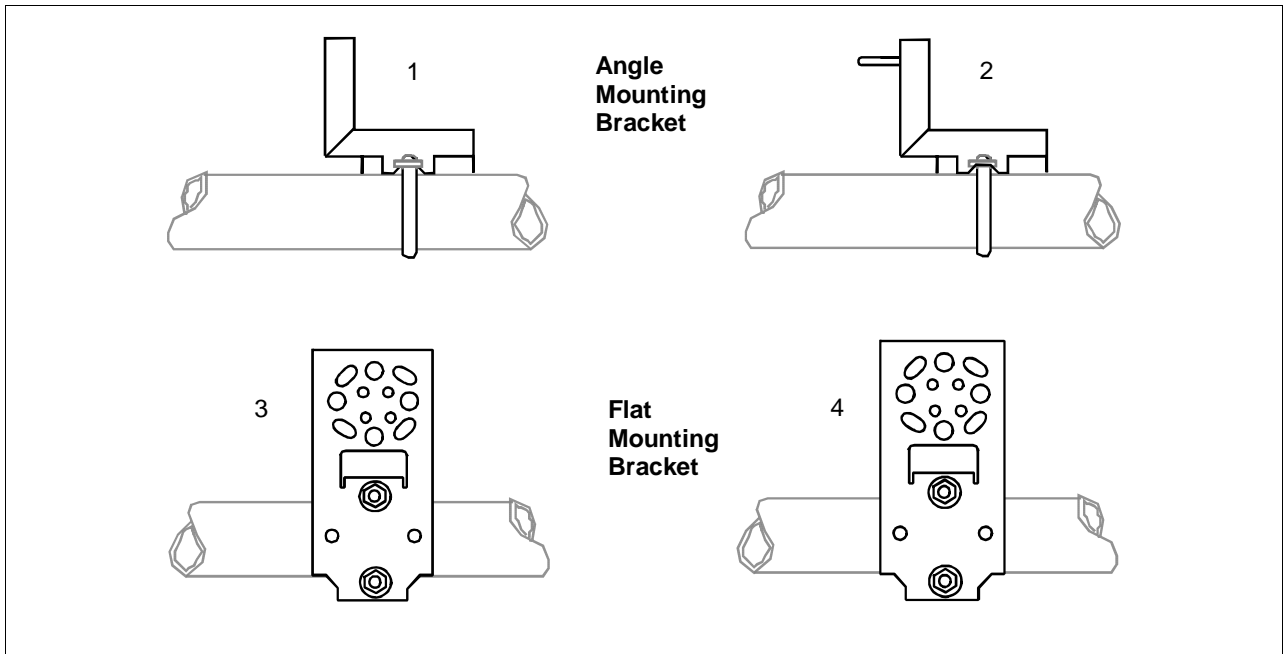

Table 69 Major ST 3000 Smart Transmitter Parts Reference.

Key No.	Part Number	Description	Quantity Per Unit
1	30752770-003	Angle Bracket Mounting Kit for all models except LGP and Flush mount	
2	30752770-004	Angle Bracket Mounting Kit for models LGP, Flush mount, STR14G, STR17G, and STR94G	
3	51196557-001	Flat Bracket Mounting Kit for all models except LGP and Flush Mount	
4	51196557-002	Flat Bracket Mounting Kit for all models LGP, Flush mount, STR14G, STR17G, and STR94G	

12.1 Replacement Parts, Continued

Figure 55 Series 100/900 Electronics Housing - Electronics/Meter End.

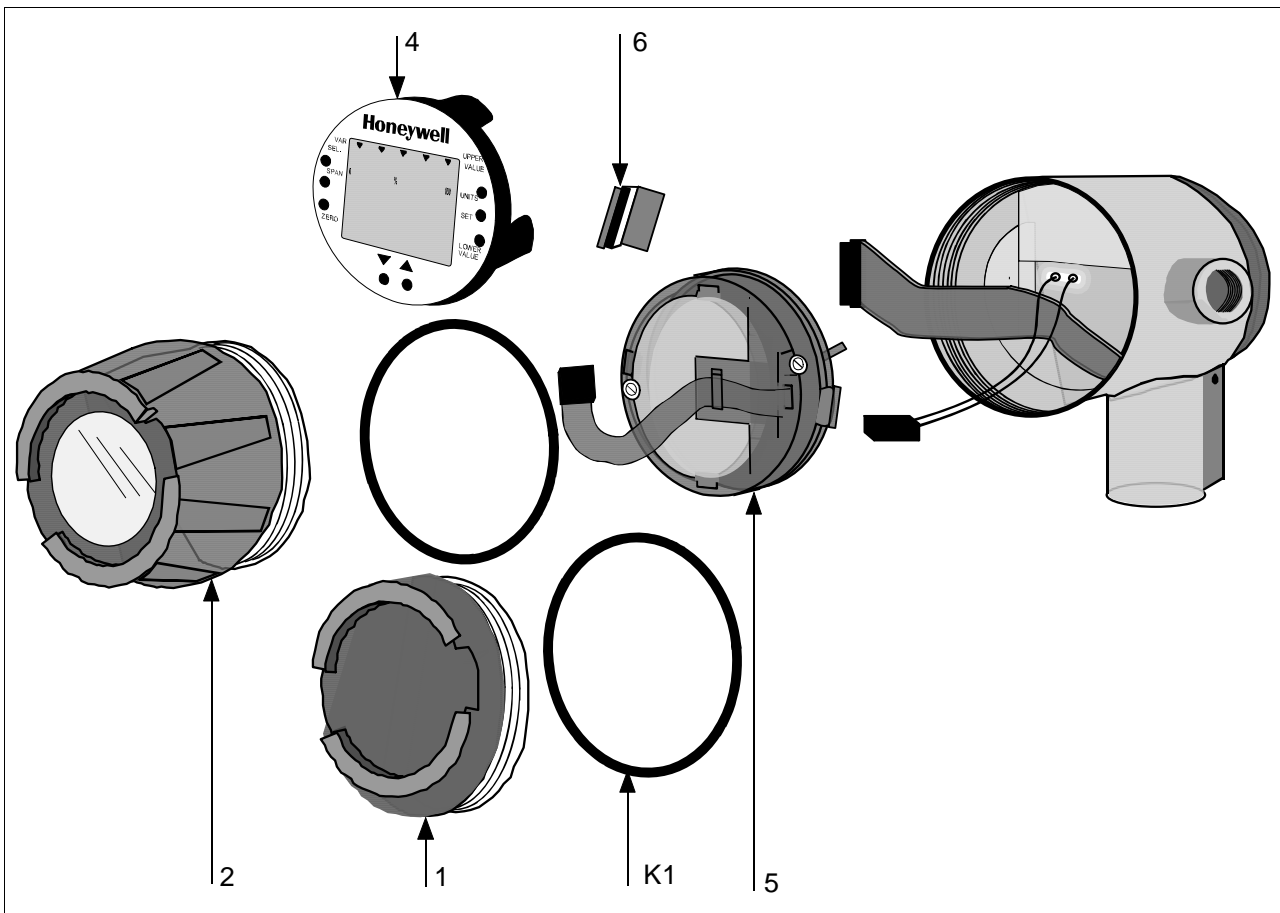
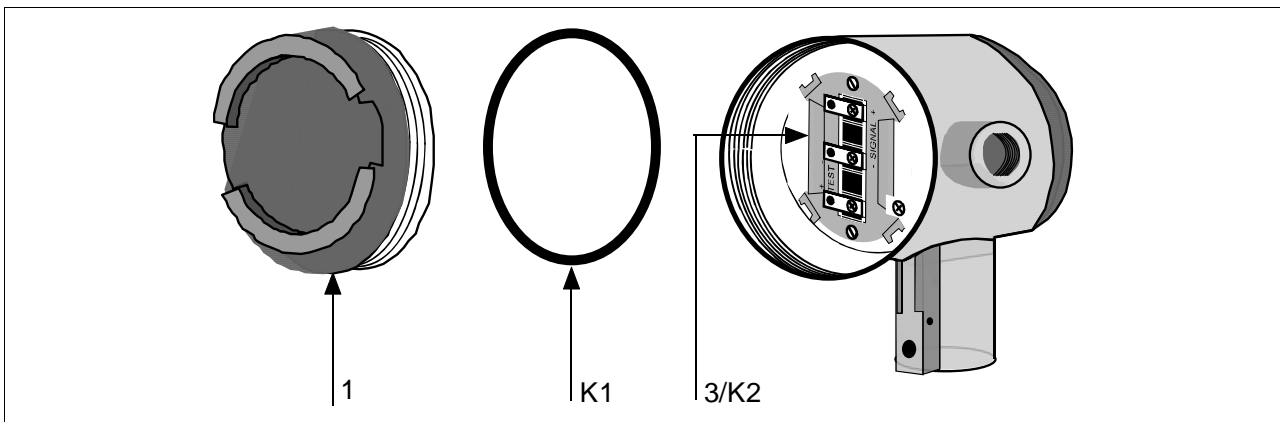

Figure 56 Series 100/900 Electronics Housing - Terminal Block End



Continued on next page

12.1 Replacement Parts, Continued

Table 70 Parts Identification for Callouts in Figures 55 and 56

Key No.	Part Number	Description	Quantity Per Unit
1	30756961-501 30756961-502	Cap for Series 900 only Cap for Series 100 only	1
2	30756996-501 30756996-502	Cap, meter for Series 900 only Cap, meter for Series 100 only	1
3	51205897-501† 51404078-502†	Terminal assembly without lightning protection Terminal assembly with lightning protection	1
4	51309389-501 51309389-502 51309389-503	Local Zero and Span Adjust Only Local Smart Meter Only Local Smart Meter With Zero and Span Adjust	1
5	51309397-501 51309397-504 51309397-511 51309397-514 51309397-506 51309397-507 51309397-516 51309397-517	Analog Only Electronics, Transmitter Option AN Analog Only Electronics, Options AN,4G Analog Only Electronics, Options AN,NE Analog Only Electronics, Options AN,NE,4G DE/Analog Electronics, Option DE DE/Analog Electronics, Options DE,4G DE/Analog Electronics, Options DE,NE DE/Analog Electronics, Options DE,NE,4G	1
6	51204038-001	Retaining Clip	1
7	30756997-501	Analog meter	1
K1	30757503-001†	Electronics housing seals kit (includes O-rings)	
K2	51197425-001 51197425-002	Terminal assembly without lightning protection conversion kit (includes screws, cover, and terminal block) Terminal assembly with lightning protection conversion kit (includes screws, cover, and terminal block)	
Not Shown	30757504-001	Electronics housing hardware kit, DP/I, GP/I, LGP/I (includes screws, gasket, plate, washers, cover terminal, and spacers)	

Continued on next page

12.1 Replacement Parts, Continued

Figure 57 Series 100 and Series 900 DP Meter Body for Models STD924 & STD930 C, D, G, H, K, and L and STD974

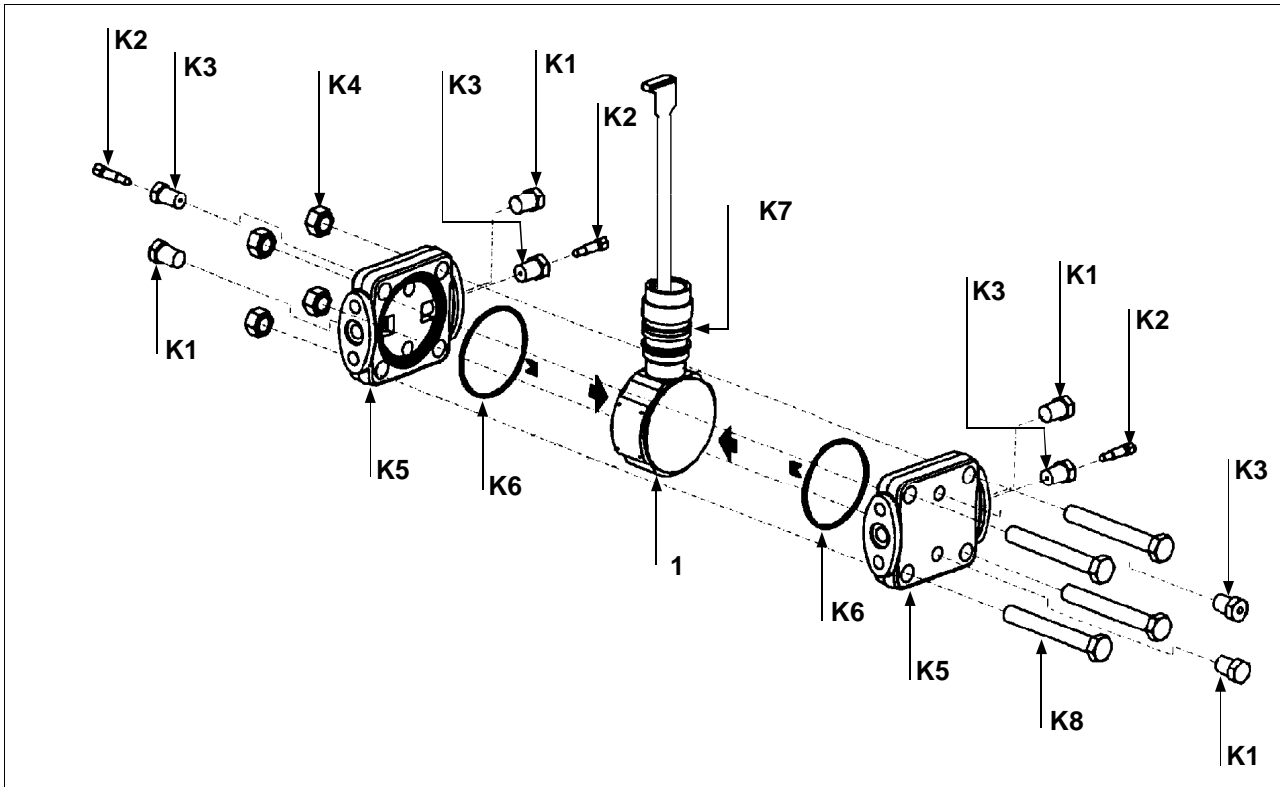

Continued on next page

12.1 Replacement Parts, Continued

Table 71 Parts Identification for Callouts in Figure 57.

Key No.	Part Number	Description	Quantity Per Unit
1	Specify complete model number from nameplate plus R300	Series 100 replacement meter body without heads	1
	Specify complete model number from nameplate plus R300	Series 900 replacement meter body without heads	1
2	30757104-001	Adapter, meter body to electronics housing	1
	30753790-001	Carbon steel bolts and nuts kit	
	Not Shown	Bolt, hex head, 7/16-20 UNF, 1.375 inches lg., flange adapter	4
K4		Nut, hex, metric, M12, process heads	4
K8		Bolt, hex head, metric, M12, 90mm lg., process heads	4
	30753791-002	A286 SS (NACE) bolts and 302/304 SS (NACE) nuts kit	
	Not Shown	Bolt, hex head, 7/16-20 UNF, 1.375 inches lg., flange adapter	4
K4		Nut, hex, metric, M12, process heads	4
K8		Bolt, hex head, metric, M12, 90mm lg., process heads	4
	30753785-001	St. steel vent/drain and plug kit	
K1		Pipe plug	4
K2		Vent plug (all except model STD110)	2
K3		Vent bushing (all except model STD110)	2
	30753787-001	Monel vent/drain and plug kit	
K1		Pipe plug	4
K2		Vent plug (all except model STD110)	2
K3		Vent bushing (all except model STD110)	2
	30753786-001	Hastelloy C vent/drain and plug kit	
K1		Pipe plug	4
K2		Vent plug (all except model STD110)	2
K3		Vent bushing (all except model STD110)	2
	30753788-003†	Process head gasket kit (PTFE material)	
	30753788-004†	Process head gasket kit for (Viton material)	
K6		Head gasket [For gasket only: 30756445-501 (PTFE, quantity 12) or 30749274-501 (6 Viton head O-rings and 6 Viton flange adapter O-rings)]	6
K7		O-ring	3
K9	Not Shown	Gasket, flange adapter (for gasket only: 30679622-501, 6 Teflon; or 30749274-002, 6 Viton)	6

Continued on next page

12.1 Replacement Parts, Continued

Table 71 Parts Identification for Callouts in Figure 57, continued

Key No.	Part Number	Description	Quantity Per Unit
Optional Flange Adapter Kits (two heads) - Not Shown			
	30754419-002	Flange adapter kit (st. steel flange adapters with carbon steel bolts)	
	30754419-004	Flange adapter kit (Monel flange adapters with carbon steel bolts)	
	30754419-018	Flange adapter kit (st. steel flange adapters with 316 st. steel NACE bolts)	
	30754419-020	Flange adapter kit (Monel flange adapters with 316 st. steel NACE bolts)	
K9	Not Shown	Bolt, hex head, 7/16-20 UNF, 1.375 inches lg., flange adapter	4
K11	Not Shown	Gasket, flange adapter	2
K10	Not Shown	Flange adapter	2
K12	Not Shown	Filter screen	2
	30754419-003	Flange adapter kit (Hastelloy C flange adapters with carbon steel bolts)	
	30754419-019	Flange adapter kit (Hastelloy C flange adapters with 316 st. steel NACE bolts)	
K9	Not Shown	Bolt, hex head, 7/16-20 UNF, 1.375 inches lg., optional flange adapter	4
K11	Not Shown	Gasket, flange adapter	2
K10	Not Shown	Flange adapter	2
Process Head Kits (one head with PTFE head gasket)			
	30753908-001	Process head assembly kit (Hastelloy C head)	
	30753908-002	Process head assembly kit (Hastelloy C DIN head)	
	30753908-003	Process head assembly kit (carbon steel head with side vent/drain)	
	30753908-004	Process head assembly kit (st. steel head with side vent/drain)	
	30753908-005	Process head assembly kit (Monel head)	
	30753908-009	Process head assembly kit (carbon steel head without side vent/drain)	
	30753908-010	Process head assembly kit (stainless steel head without side vent/drain)	
	30753908-011	Process head assembly kit (stainless steel DIN head without side vent/drain)	
	30753908-012	Process head assembly kit (carbon steel head - model STD110 only)	
	30753908-013	Process head assembly kit (st. steel head - model STD110 only)	
	30753908-014	Process head assembly kit (carbon steel DIN head - model STD110 only)	
	30753908-015	Process head assembly kit (st. steel DIN head - model STD110 only)	
K1		Pipe plug	2
K2		Vent plug	1
K3		Vent bushing	1
K5		Process head	1
K6		Gasket (PTFE), process head	1
K11		Gasket (PTFE), optional flange adapter	1

Continued on next page

12.1 Replacement Parts, Continued

Table 71 Parts Identification for Callouts in Figure 57, continued

Key No.	Part Number	Description	Quantity Per Unit
Process Head Kits (one head with Viton head gasket)			
	30753908-101	Process head assembly kit (Hastelloy C head)	
	30753908-102	Process head assembly kit (Hastelloy C DIN head)	
	30753908-103	Process head assembly kit (carbon steel head with side vent/drain)	
	30753908-104	Process head assembly kit (st. steel head with side vent/drain)	
	30753908-105	Process head assembly kit (Monel head)	
	30753908-109	Process head assembly kit (carbon steel head without side vent/drain)	
	30753908-110	Process head assembly kit (stainless steel head without side vent/drain)	
	30753908-111	Process head assembly kit (stainless steel DIN head without side vent/drain)	
	30753908-112	Process head assembly kit (carbon steel head - model STD110 only)	
	30753908-113	Process head assembly kit (st. steel head - model STD110 only)	
	30753908-114	Process head assembly kit (carbon steel DIN head - model STD110 only)	
	30753908-115	Process head assembly kit (st. steel DIN head - model STD110 only)	
K1		Pipe plug	2
K2		Vent plug	1
K3		Vent bushing	1
K6		Gasket (Viton), process head	1
K11		Gasket (PTFE), flange adapter	1
K5		Process head	1

Figure 58 Series 900 DP Meter Body for Models Models STD924 & STD930 A, B, E, F, and J

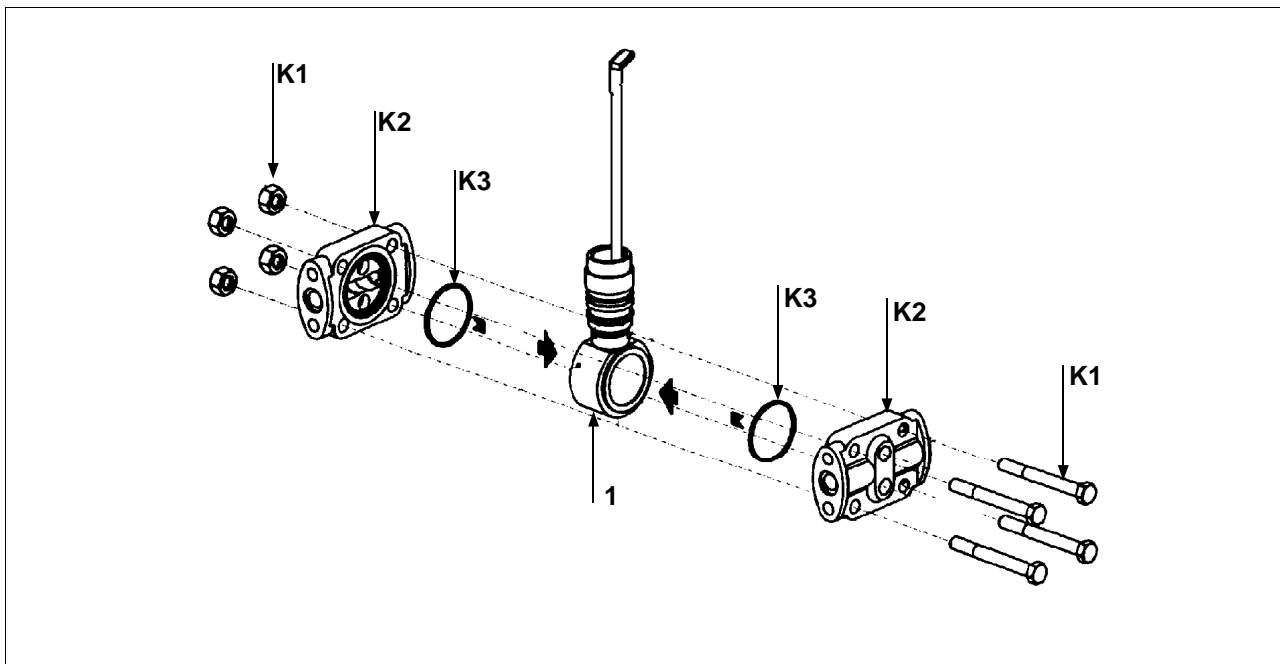

Continued on next page

12.1 Replacement Parts, Continued

Table 72 Parts Identification for Callouts in Figure 58

Key No.	Part Number	Description	Quantity Per Unit
1	Specify complete model number from nameplate plus R300	Series 900 replacement meter body without heads	1
K1	30757506-001	Head bolts carbon steel Kit includes: Bolts, Nuts	4
	30757507-001	Head bolts stainless steel/NACE Kit includes: Bolts, Nuts	4
	30757507-002	Process Head Bolting 3/8 UNC 316 SS Non-NACE Kit Includes: Process Head Bolts and Nuts	4
K2	30757147-001†	Replacement heads carbon steel Kit includes: Heads with side vents, Head gaskets Teflon, head gaskets Viton, Plugs, Bushings, Vent plugs, Gaskets	
	30757147-002	Replacement heads carbon steel Kit includes: Heads without side vents, Head gaskets Teflon, head gaskets Viton, Bushings, Vent plugs, Gaskets	
	30757148-001	Replacement heads stainless steel Kit includes: Heads with side vents, Head gaskets Teflon, Head gaskets Viton, Plugs, Bushings, Vent Plugs, Gaskets	
	30757148-002	Replacement heads stainless steel Kit includes: Heads without side vents, Head gaskets Teflon, Head gaskets Viton, Bushings, Vent Plugs, Gaskets	
	30757149-001	Replacement heads Hastelloy Kit includes: Heads with side vents, Head gaskets Teflon, Head gaskets Viton, Plugs, Bushings, Vent plugs, Gaskets	
	30757500-001	Replacement heads Monel Kit includes: Head with side vents, Head gasket Teflon, Head gasket Viton, Plugs, Bushings, Vent plugs, Gaskets	
K3	30757505-001†	Process Head Gasket Kit Kit includes: 6 Teflon head gaskets (30757100-001), 6 Viton head gaskets (30749274-004), and 6 Teflon flange adapter gaskets (30679622-501)	
Optional Flange Adapter and Flange Adapter Gaskets - Not Shown			
	30679622-501	Flange adapter gaskets Teflon	6
	30749274-502	Flange adapter gaskets Viton	6
	30754419-002	Flange adapter kit (st. steel flange adapters with carbon steel bolts)	
	30754419-018	Flange adapter kit (st. steel flange adapters with 316 st. steel NACE bolts)	
K9	Not Shown	Bolt, hex head, 7/16-20 UNF, 1.375 inches lg., flange adapter	4
K11	Not Shown	Gasket, flange adapter	2
K10	Not Shown	Flange adapter	2
K12	Not Shown	Filter screen	2
	30754419-003	Flange adapter kit (Hastelloy C flange adapters with carbon steel bolts)	
	30754419-019	Flange adapter kit (Hastelloy C flange adapters with 316 st. steel NACE bolts)	
K9	Not Shown	Bolt, hex head, 7/16-20 UNF, 1.375 inches lg., optional flange adapter	4
K11	Not Shown	Gasket, flange adapter	2
K10	Not Shown	Flange adapter	2

Continued on next page

12.1 Replacement Parts, Continued

Figure 59 Series 100 GP and AP Meter Bodies and Series 900 AP Meter Body

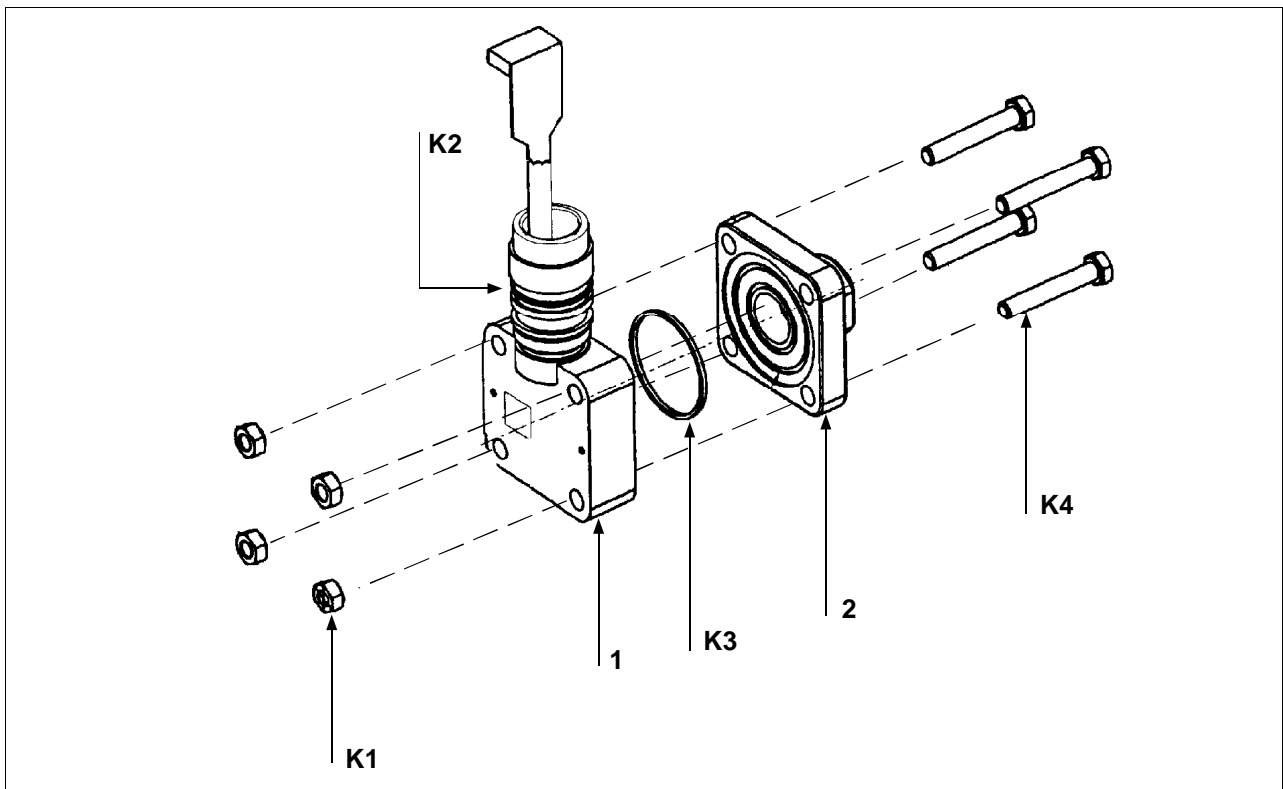

Table 73 Parts Identification for Callouts in Figure 59

Key No.	Part Number	Description	Quantity Per Unit
2	See Table 74	Process head (GP/AP models)	1
1	Specify complete model number from nameplate plus R300	Series 100 replacement meter body without head (GP/AP Models)	1
	Specify complete model number from nameplate plus R300	Series 900 replacement meter body without head (GP/AP Models)	1
	30754154-002†	Head gasket kit for all models with narrow profile meter body except STG180 (3 sets)	
	30754154-003†	Head gasket kit for model STG180 with narrow profile meter body (3 sets)	
K2		O-ring	3

Continued on next page

12.1 Replacement Parts, Continued

Table 73 Parts Identification for Callouts in Figure 59, continued

Key No.	Part Number	Description	Quantity Per Unit
K3		Gasket, Teflon [for gasket only - 30756445-502 (narrow profile L.P), or 30756445-503 (STG180)]	6
		Gasket, Viton [for gasket only - 30756445-504 (narrow profile L.P), or 30756445-505 (STG180)]	6
	30756445-509	Gasket, Graphite (for replacement on existing STG/A X22/X40 Transmitter with Graphite Gasket only)	6
	30753792-001	Bolts & nuts kit, all models - narrow profile (carbon steel). Contains:	
K1		Nut, hex, metric, M8 carbon steel	4
K4		Bolt, hex head, metric, M8, 50 mm long	4
	30753793-002	A286 SS (NACE) Bolts & 304 SS (NACE) nuts kit, all models - narrow profile. Contains:	
K1		Nut, hex, 5/16 (304 stainless steel)	4
K4		Bolt, hex head, 5/16-18	4
	30753793-003	Process Head Bolting 316 SS Non-NACE Kit Includes: Process Head Bolts and Nuts. Contains:	
K1		5/16 –18 UNC 316 SS Non-NACE Heavy Hex Nuts	4
K4		5/16 –18 UNC 316 SS Non-NACE Hex Cap Screw	4

Table 74 Replacement GP and AP Process Head Part Numbers for Narrow Profile Meter Body

Material	Fitting Size	Models: STA122, STA140, STG140, STG170, STG180, STA922, STA940
Carbon steel (Series 100)	9/16 - 18UNF-2B	30755124-001
Stainless steel (Series 100)	9/16 - 18UNF-2B	30755124-002
Carbon steel	1/2 in NPT	30755124-005
Stainless steel	1/2 in NPT	30755124-006
Monel	1/2 in NPT	30755124-008
Hastelloy C	1/2 in NPT	30755124-007

Continued on next page

12.1 Replacement Parts, Continued

Figure 60 Series 900 Dual-Head GP Meter Bodies.

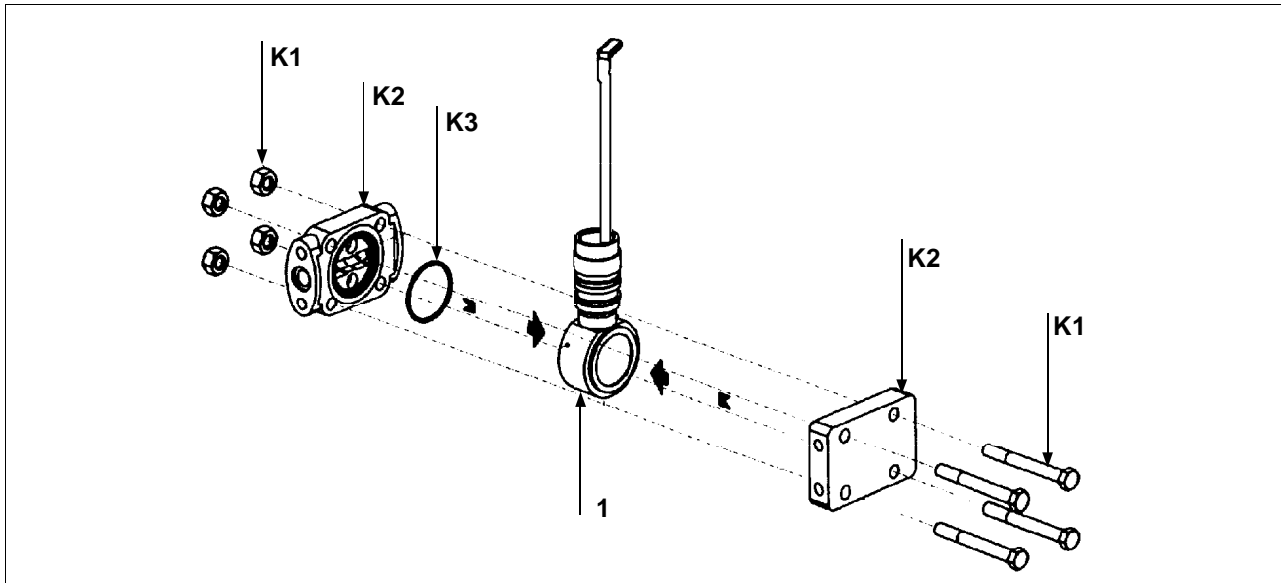

Table 75 Parts Identification for Callouts in Figure 60

Key No.	Part Number	Description	Quantity Per Unit
1	Specify complete model number from nameplate plus R300	Series 900 replacement meter body without heads (GP models)	1
K1	30757506-001	Head bolts carbon steel, 3/8-inch Kit includes: Bolts, Nuts	4
	30757507-001	Head bolts stainless steel/NACE, 3/8-inch Kit includes: Bolts, Nuts	4
	30757507-002	Process Head Bolting 3/8 UNC 316 SS Non-NACE Kit Includes: Process Head Bolts and Nuts	4
K2	30757501-001	Replacement heads carbon steel Kit includes: Head with side vents, Head dummy CS, Head gaskets Teflon, Head gaskets Viton, Plugs, Bushings, Vent Plug, Gasket	
	30757501-002	Replacement heads carbon steel Kit includes: Head without side vents, Head dummy CS, Head gaskets Teflon, Head gaskets Viton, Bushings, Vent Plug, Gasket	
	30757502-001	Replacement heads stainless steel Kit includes: Heads with side vents, Head dummy SS, Head gaskets Teflon, head gaskets Viton, Plugs, Bushings, Vent plugs, Gaskets	
	30757502-002	Replacement heads stainless steel Kit includes: Heads without side vents, Head dummy SS, Head gaskets Teflon, head gaskets Viton, Bushings, Vent plugs, Gaskets	
	30756941-005	Stainless steel blind reference head (HR option)	
K3	30757505-001†	Process head gasket kit Kit includes: 6 Teflon head gaskets (30757100-001), 6 Teflon flange adapter gaskets (30679622-001), 6 Viton head gaskets (30749274-004)	
Optional Flange Adapter - Not Shown			
K4	30679622-501	Flange adapter gaskets Teflon	6
	30749274-502	Flange adapter gaskets Viton	6

Continued on next page

12.1 Replacement Parts, Continued

Figure 61 Series 100 and Series 900 LGP Meter Body.

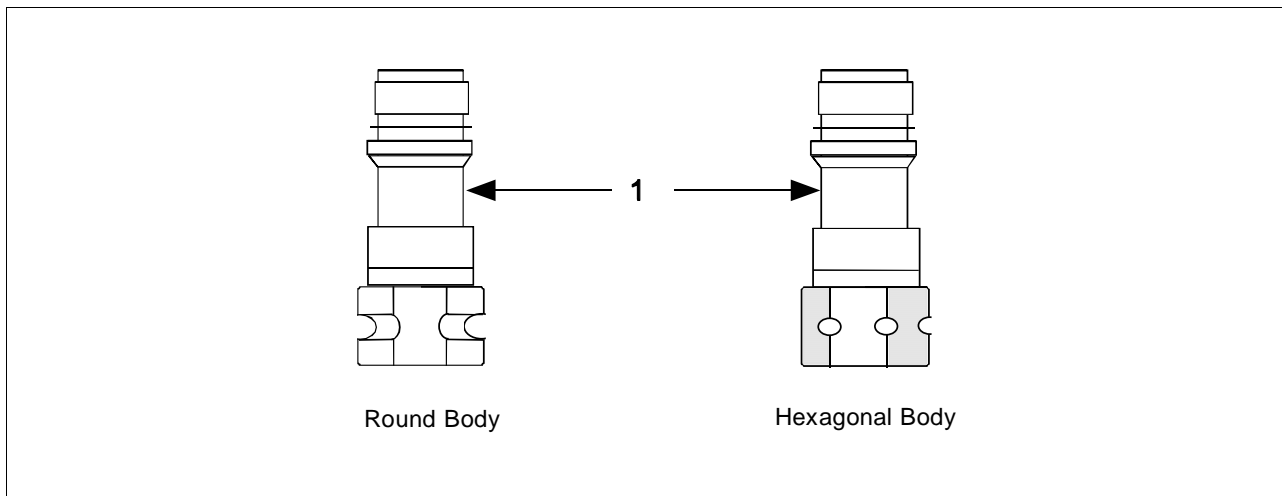

Table 76 Parts Identification for Callouts in Figure 61

Key No.	Part Number	Description	Quantity Per Unit
1	Specify complete model number from nameplate plus R300	Series 100 replacement meter body (LGP and LAP model)	1
	Specify complete model number from nameplate plus R300	Series 900 replacement meter body (LGP and LAP model)	1

Continued on next page

12.1 Replacement Parts, Continued

Figure 62 Series 900 Flush Mount Meter Body.

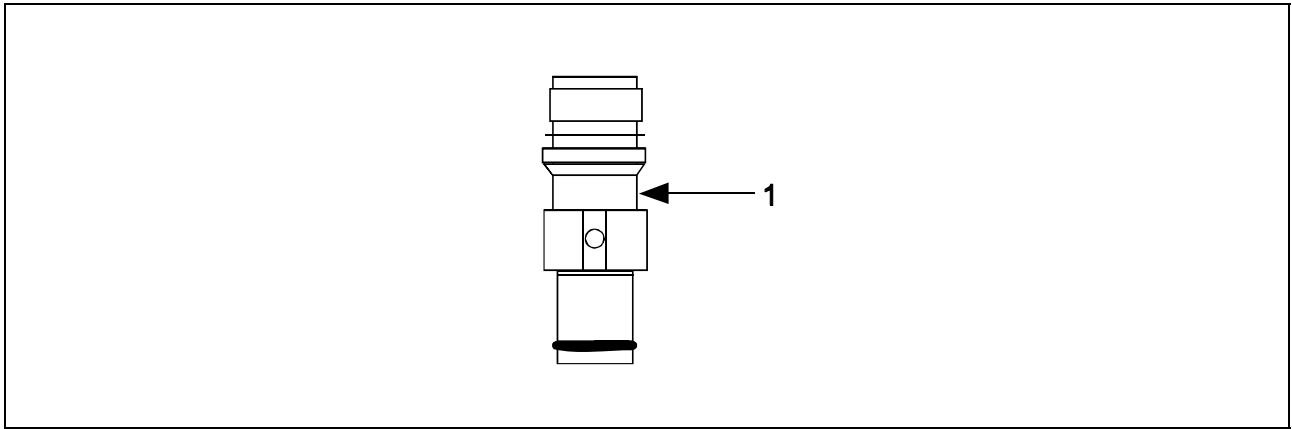

Table 77 Parts Identification for Callouts in Figure 62

Key No.	Part Number	Description	Quantity Per Unit
1	Specify complete model number from nameplate plus R300	Series 900 replacement meter body (Flush Mount model)	1
	30756445-508	Gasket Kit (O-rings)	
	51204496-001	316L SS Mounting Sleeve Kit	
	51204497-001	Calibration Sleeve Kit	

Continued on next page

12.1 Replacement Parts, Continued

Figure 63 Series 100 and Series 900 Flange Mounted Meter Body.

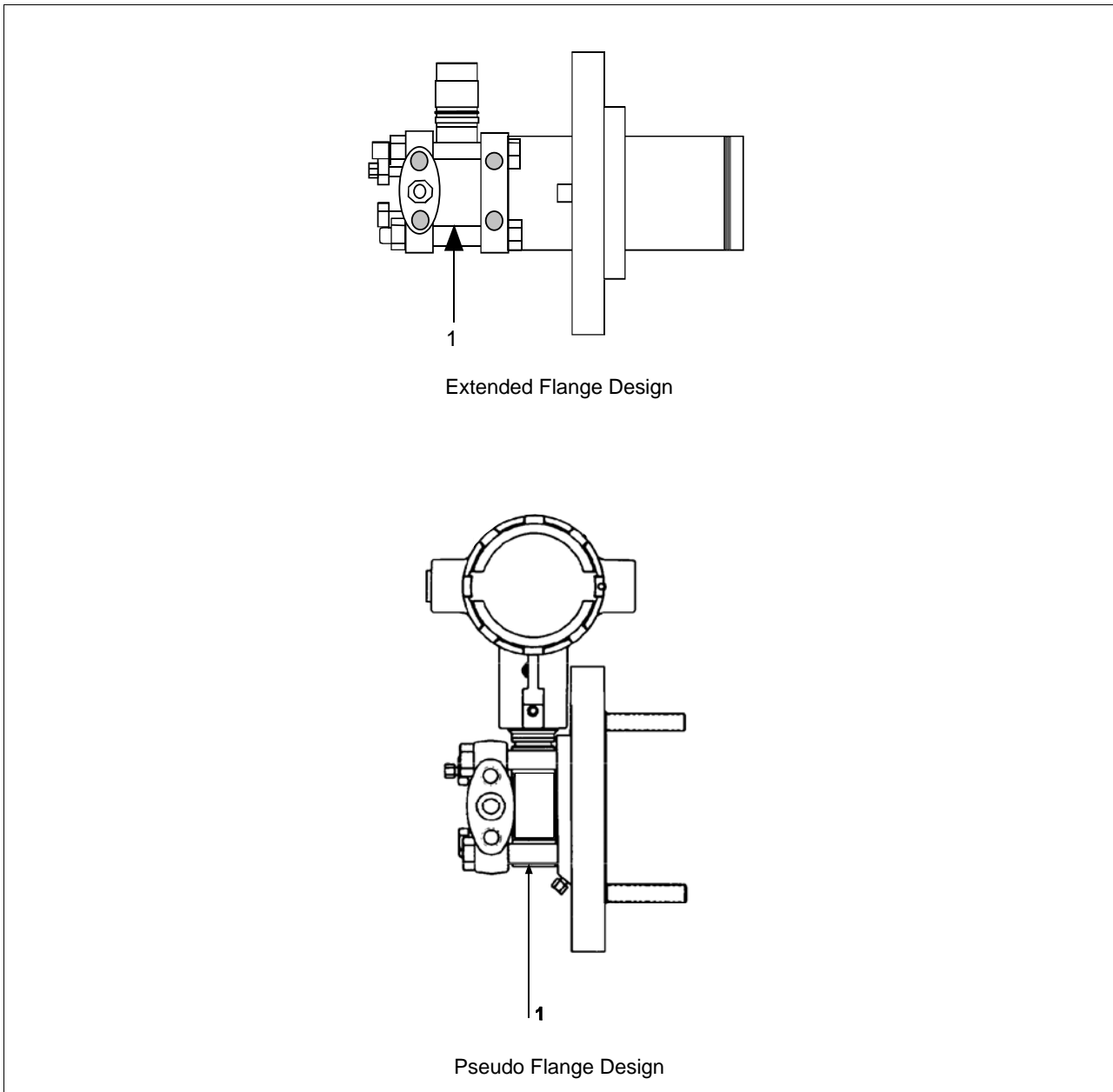

Continued on next page

12.1 Replacement Parts, Continued

Table 78 Parts Identification for Callouts in Figure 63

Key No.	Part Number	Description	Quantity Per Unit
1	Specify complete model number from nameplate plus R300	Series 100 replacement meter body	1
	Specify complete model number from nameplate plus R300	Series 900 replacement meter body	1
	30749372-005	O-ring seal	1
	30749372-001	O-ring seal	1
Optional Flange Adapter - Not Shown			
K1	30754419-006	Flange adapter kit (st. steel flange adapter with carbon steel bolts)	2
	30754419-008	Flange adapter kit (Monel flange adapter with carbon steel bolts)	
	30754419-022	Flange adapter kit (st. steel flange adapter with 316 st. steel NACE bolts)	
	30754419-024	Flange adapter kit (Monel flange adapter with 316 st. steel NACE bolts)	
K2		Bolt, hex head, 7/16-20 UNF, 1.375 inches lg.	1
K3		Flange adapter	1
K4		Gasket	1
K4		Filter screen	1
	30754419-007	Flange adapter kit (Hastelloy C flange adapter with carbon steel bolts)	
	30754419-023	Flange adapter kit (Hastelloy C flange adapter with 316 st. steel NACE bolts)	
K1		Bolt, hex head, 7/16-20 UNF, 1.375 inches lg.	2
K2		Flange adapter	1
K3		Gasket	1
K5	30757503-001	Housing seal kit	1

Continued on next page

12.1 Replacement Parts, Continued

Figure 64 High Temperature Meter Body.

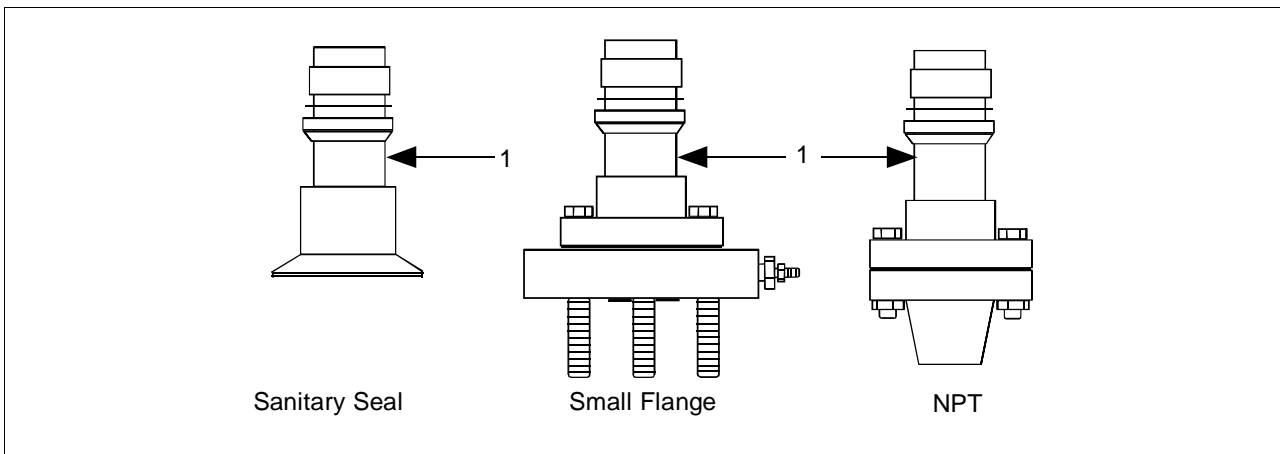

Table 79 Parts Identification for Callouts in Figure 64

Key No.	Part Number	Description	Quantity Per Unit
1	Specify complete model number from nameplate plus R300	Series 100 replacement meter body	1
Sanitary Seal Head and Gasket			
	51204982-001	Sanitary Seal Head GP/I (Stainless Steel Head w/ st.stl. hardware)	
	51204982-003	Sanitary Seal Head GP/I (Stainless Steel Head w/ SS NACE. hardware)	
	51204982-002	Sanitary Seal Head GP/I (Hastelloy Head w/ st.stl. hardware)	
	51204984-001	Gasket GP/I (includes Teflon gasket and Viton O-ring)	
Flange Adapter - Not Shown			
	51204983-001	Flange adapter kit (½" NPT st. stl. 150# w/ st. stl bolts)	
	51204983-002	Flange adapter kit (½" NPT st. stl. 150# w/ st. stl bolts w/ vent/drain)	
	51204983-017	Flange adapter kit (½" NPT st. stl. 150# w/ SS NACE bolts)	
	51204983-018	Flange adapter kit (½" NPT st. stl. 150# w/ SS NACE bolts w/ vent/drain)	
	51204983-003	Flange adapter kit (½" NPT Hastelloy 150# w/ st. stl bolts)	
	51204983-004	Flange adapter kit (½" NPT Hastelloy 150# w/ st. stl bolts w/ vent/drain)	
	51204983-005	Flange adapter kit (1" NPT st. stl. 150# w/ st. stl bolts)	
	51204983-006	Flange adapter kit (1" NPT st. stl. 150# w/ st. stl bolts w/ vent/drain)	
	51204983-019	Flange adapter kit (1" NPT st. stl. 150# w/ SS NACE bolts)	
	51204983-020	Flange adapter kit (1" NPT st. stl. 150# w/ SS NACE bolts w/ vent/drain)	
	51204983-007	Flange adapter kit (1" NPT Hastelloy 150# w/ st. stl bolts)	
	51204983-008	Flange adapter kit (1" NPT Hastelloy 150# w/ st. stl bolts w/ vent/drain)	

Continued on next page

12.1 Replacement Parts, Continued

Table 79 Parts Identification for Callouts in Figure 64, continued

Key No.	Part Number	Description	Quantity Per Unit
	51204983-013	Flange adapter kit (1" NPT st. stl. 300# w/ st. stl bolts)	
	51204983-014	Flange adapter kit (1" NPT st. stl. 300# w/ st. stl bolts w/ vent/drain)	
	51204983-023	Flange adapter kit (1" NPT st. stl. 300# w/ SS NACE bolts)	
	51204983-024	Flange adapter kit (1" NPT st. stl. 300# w/ SS NACE bolts w/ vent/drain)	
	51204983-015	Flange adapter kit (1" NPT Hastelloy 300# w/ st. stl bolts)	
	51204983-016	Flange adapter kit (1" NPT Hastelloy 300# w/ st. stl bolts w/ vent/drain)	
	51204983-009	Flange adapter kit (1½" NPT st. stl. 150# w/ st. stl bolts)	
	51204983-010	Flange adapter kit (1½" NPT st. stl. 150# w/ st. stl bolts w/ vent/drain)	
	51204983-021	Flange adapter kit (1½" NPT st. stl. 150# w/ SS NACE bolts)	
	51204983-022	Flange adapter kit (1½" NPT st. stl. 150# w/ SS NACE bolts w/ vent/drain)	
	51204983-011	Flange adapter kit (1½" NPT Hastelloy 150# w/ st. stl bolts)	
	51204983-012	Flange adapter kit (1½" NPT Hastelloy 150# w/ st. stl bolts w/ vent/drain)	
	51204983-025	Flange adapter kit (2" st. stl. 150# w/ st. stl bolts)	
	51204983-026	Flange adapter kit (2" st. stl. 150# w/ st. stl bolts w/ vent/drain)	
	51204983-037	Flange adapter kit (2" st. stl. 150# w/ SS NACE bolts)	
	51204983-038	Flange adapter kit (2" st. stl. 150# w/ SS NACE bolts w/ vent/drain)	
	51204983-027	Flange adapter kit (2" Hastelloy 150# w/ st. stl bolts)	
	51204983-028	Flange adapter kit (2" Hastelloy 150# w/ st. stl bolts w/ vent/drain)	
	51204983-029	Flange adapter kit (1½" st. stl. 300# w/ st. stl bolts)	
	51204983-030	Flange adapter kit (1½" st. stl. 300# w/ st. stl bolts w/ vent/drain)	
	51204983-039	Flange adapter kit (1½" st. stl. 300# w/ SS NACE bolts)	
	51204983-040	Flange adapter kit (1½" st. stl. 300# w/ SS NACE bolts w/ vent/drain)	
	51204983-031	Flange adapter kit (1½" Hastelloy 300# w/ st. stl bolts)	
	51204983-032	Flange adapter kit (1½" Hastelloy 300# w/ st. stl bolts w/ vent/drain)	
	51204983-033	Flange adapter kit (2" st. stl. 300# w/ st. stl bolts)	
	51204983-034	Flange adapter kit (2" st. stl. 300# w/ st. stl bolts w/ vent/drain)	
	51204983-041	Flange adapter kit (2" st. stl. 300# w/ SS NACE bolts)	
	51204983-042	Flange adapter kit (2" st. stl. 300# w/ SS NACE bolts w/ vent/drain)	
	51204983-035	Flange adapter kit (2" Hastelloy 300# w/ st. stl bolts)	
	51204983-036	Flange adapter kit (2" Hastelloy 300# w/ st. stl bolts w/ vent/drain)	

Continued on next page

12.1 Replacement Parts, Continued

Figure 65 SFC Smart Field Communicator and Accessories.

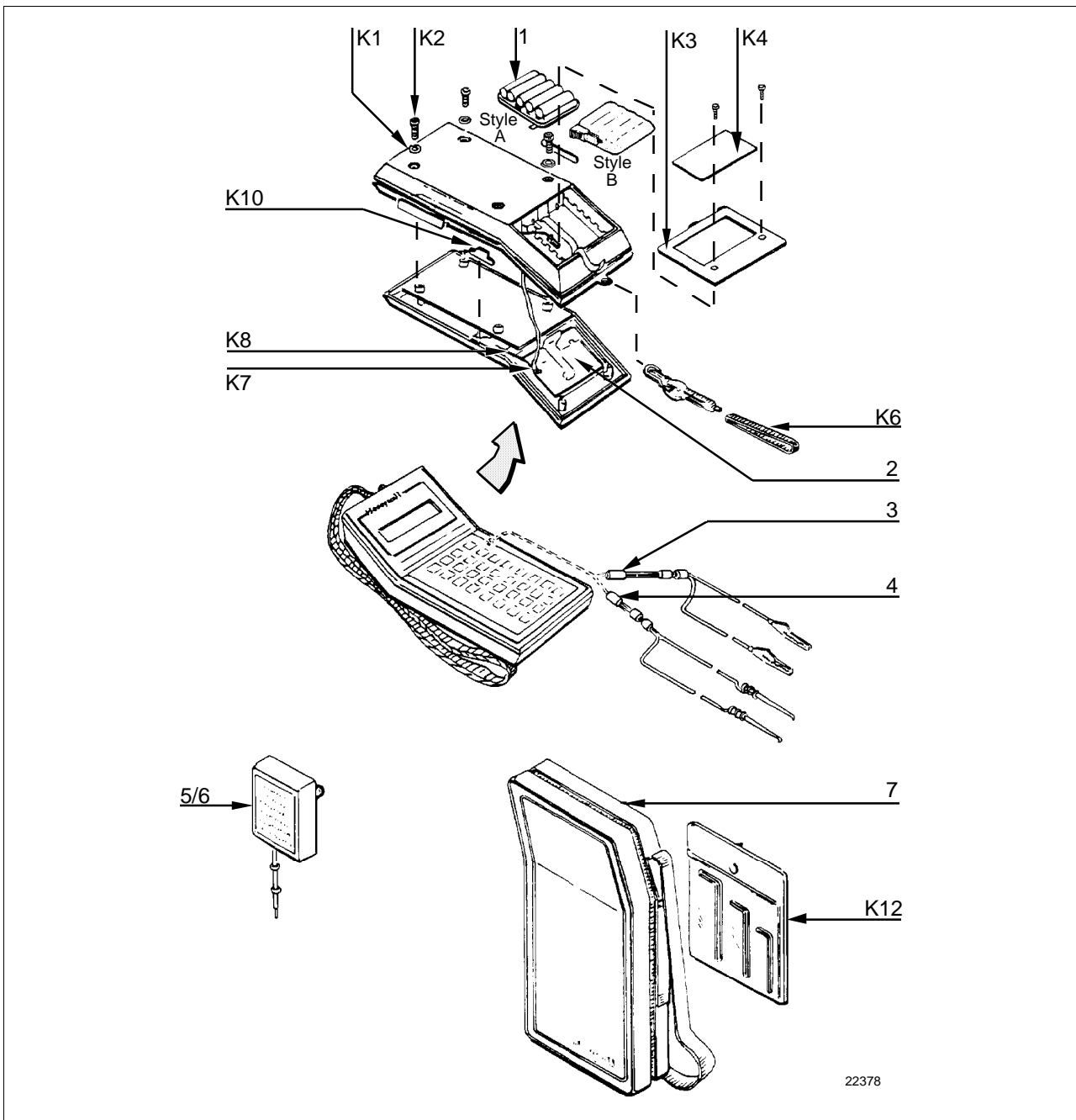

Continued on next page

12.1 Replacement Parts, Continued

Table 80 Parts Identification for Callouts in Figure 65.

Key No.	Part Number	Description	Quantity Per Unit
1		Battery pack assembly	1
	See Figure 62	Style A – No longer available. Order conversion kit 30755131-001	
	30755080-501	Style B	
2	30753046-501	LCD assembly	1
3		Interface cable assembly (with alligator clips)	1
	30752453-501	6 feet (1.8 meters) long	
	30752453-503	12 feet (3.6 meters) long	
	30752453-505	20 feet (6 meters) long	
4		Interface cable assembly (with EZ hooks)	1
	30752453-502	6 feet (1.8 meters) long	
	30752453-504	12 feet (3.6 meters) long	
	30752453-506	20 feet (6 meters) long	
5	30752438-501	DC battery charger, AA Nicad cell , 120 Vac	1
6	30753739-501	DC battery charger, AA Nicad cell, 240 Vac (Universal-European plug)	1
7	30752834-501	Carrying case, vinyl	1
Key No.	Part Number	Description	Quantity Per Kit
	30753194-001	Replacement hardware kit	
K1		Bumper, recess	4
K2		Screw, metric, M3, socket head	6
K3		Cover, battery compartment	1
K4		Label, battery cover	1
K6		Carry strap	1
K7		Harness assembly, power/charger	1
K10		Actuator	1
K12		Socket head wrench kit, metric Contents: (1) Hex head socket wrench, size 2.5 mm (1) Hex head socket wrench, size 3 mm (1) Hex head socket wrench, size 4 mm	1

Continued on next page

12.1 Replacement Parts, Continued

Table 81 Summary of Recommended Spare Parts

Part Number	Description	Reference		Spares for		
		Figure Nbr.	Key Nbr.	1-10 Units	10-100 Units	100-1000 Units
Electronics Housing Assembly		Figs. 55 and 56				
51309397-501	Analog Only Electronics, Transmitter Option AN	55	5	1	1-2	2-4
51309397-504	Analog Only Electronics, Options AN,4G					
51309397-511	Analog Only Electronics, Options AN,NE					
51309397-514	Analog Only Electronics, Options AN,NE,4G					
51309397-506	DE/Analog Electronics, Option DE					
51309397-507	DE/Analog Electronics, Options DE,4G					
51309397-516	DE/Analog Electronics, Options DE,NE					
51309397-517	DE/Analog Electronics, Options DE,NE,4G					
30757503-001	Series 100/900 housing seal kit	55 & 56	K1	1	1-2	2-4
51205897-501	Series 100/900 terminal assembly without lightning protection	56	3/K2	1	1	1-2
51404078-502	Series 100/900 terminal assembly with lightning protection					
Process head gasket kit				1	1-4	4-10
30757505-001	For STD924-A, B, E, F, and J; STD930-A, B, E, F, and J; STG944; STG974 models Teflon and Viton	58,60	K3			
30753788-003	For all other Series 100 DP and STD924-C, D, G, H, K, and L; STD930-C, D, G, H, K, and L; and STD974 models Teflon	57	K6			
30753788-004	Viton					
30754154-002	For STA122, STA140, STA922, STA940, STG140, and STG170 Teflon and Viton	59	K3			
30754154-003	For STG180	59	K3			
Meter Body				1	1-2	2-4
Specify complete model number from nameplate plus R300	Series 100/900 DP Models	57	1			
	Series 900 DP Models	57,58	1			
	Series 100/900 GP/AP Models	59	1			
	Series 900 GP Dual Head Model	60	1			
	Series 100/900 Inline and Series 900 AP Models	61	1			
	Series 900 Flush Mount Models	62	1			
	Series 100/900 Flange Mount Models	63	1			
	Series 100 High Temperature Models	64	1			

Section 13 —Reference Drawings

13.1 Wiring Diagrams

External Wiring Diagrams

Wiring diagram drawing numbers are listed here for ST 3000 Release 300, Series 100 and 900 Transmitters. These wiring diagrams are included in numerical order behind this page for wiring reference.

**ST 3000
Release 300
Series 100, 900
Transmitters**

Description	Drawing Number
For non-intrinsically safe application	30753607
For intrinsically safe application (FM)	51204241
For intrinsically safe application (CSA)	51204242
For intrinsically safe application (CENELEC)	51204243

Transmitter Dimension Drawings

Dimension drawings for individual transmitter models are available and are listed in the ST 3000 Release 300 installation guide document supplied with your transmitter. If you need a copy of a drawing, please determine the appropriate drawing number and contact your Honeywell representative to obtain a copy.



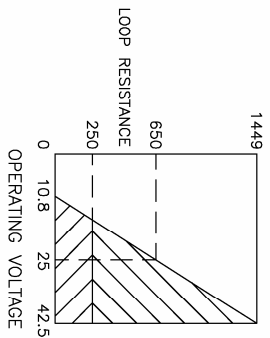
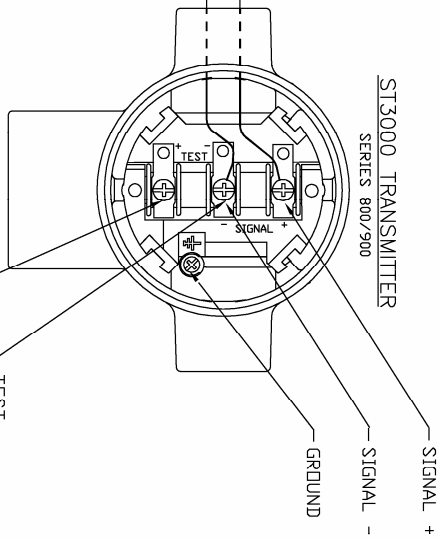
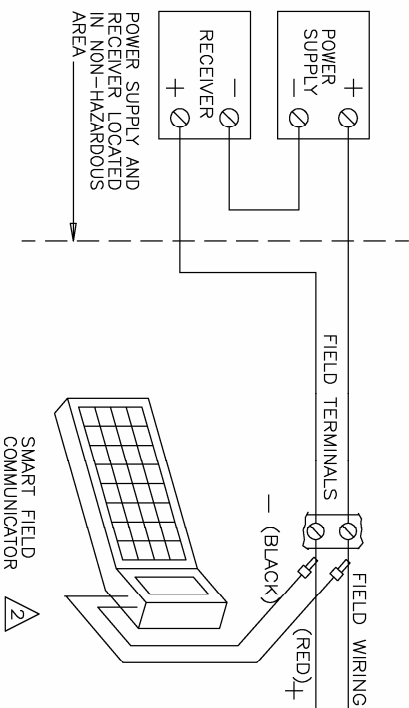

- 1. LOOP RESISTANCE EQUALS WIRE RESISTANCE + RECEIVER RESISTANCE.
- NOTES:**
1. CROSS HATCHED AREA IS USABLE OPERATING AREA; A MINIMUM OF 250 OHMS OF LOOP RESISTANCE IS NECESSARY TO SUPPORT COMMUNICATION.
 2. SMART FIELD COMMUNICATOR MAY BE CONNECTED AT ANY POINT IN THE LOOP BETWEEN THE BARRIERS(S) AND THE ST3000 TRANSMITTER AT WHICH CONNECTIONS ARE ACCESSIBLE. THERE MUST BE A MINIMUM SERIES RESISTANCE OF 250 OHMS BETWEEN THE SMART FIELD COMMUNICATOR CONNECTION POINT AND POWER SUPPLY. SEE INSTRUCTION MANUAL.

CADFILE # 753607-3.DWG

DO NOT SCALE DRAWING

Homeywell

A3

30753607

SCALE NINE REV 4 DATED 07/00 SHT 2 OF 2

30753607

CAD

SHEET	1	2	3	4	5	6	7	8	9
REV	C	C	C	C	C	C	C	C	C

PRE REL				
ISS	REVISION & DATE	APPD		
A	RELEASE 9/29/97	F972430	D.A.	
B	REV'D F992235 10/13/99		WF	
C	REV'D F202130 07/07/00		RGV	
D	REV'D F202165 10/06/00		RGV	

HAZARDOUS (CLASSIFIED) LOCATION

CLASS I, II & III, DIVISION 1
GROUPS A,B,C,D,E,F & G
(NOTE 2)

INTEGRAL
ANALOG METER
30752118 OR
LOCAL SMART
METER 51309389

ST3000
S900/S100
TRANSMITTER

SHIELD
(NOTE 9)

RMA3000 REMOTE METER OPTIONS		
RMA300-ME	RMA300-DM	RMA300-SM
Y R	Y R	Y B R

NON-HAZARDOUS LOCATION

ENTITY PARAMETERS

V_t OR $V_{oc} \leq 42.4V$
 I_t OR $I_{sc} \leq 225mA$
 $C_{a2} \geq C_{cable} + C_i$ OF ALL LOOP DEVICES
 $L_{a2} \geq L_{cable} + L_i$ OF ALL LOOP DEVICES

FMRC ENTITY
APPROVED
ASSOCIATED
APPARATUS
(BARRIER/CONVERTER)
(NOTES 6 & 7)

POWER
SUPPLY
(NOTE 3)

CONTROL
EQUIPMENT
(NOTE 3)

ENTITY PARAMETERS



$V_{max} = 42.4V$
 $I_{max} = 225mA$
 $P_{max} = 1.2W$
 $C_i = 4.2nF$

LOCAL SMART METER, SM, $L_i = 0$
ANALOG METER, ME, $L_i = 150uH$



$V_{max} = 42.4V$
 $I_{max} = 225mA$
 $P_{max} = 1.2W$
 $C_i = 0$
RMA300-ME, $L_i = 150uH$
RMA300-DM, $L_i = 0$
RMA300-SM, $L_i = 0$

INTRINSIC SAFETY &
SHIELD GROUND
(NOTE 8 & 9)



CERTIFICATION DOCUMENT
ENGINEERING CHANGES
(ECO'S) MUST BE
AUTHORIZED BY
APPROVALS SPECIALIST

NOTES:

- $V_{max} \geq V_{oc}$ OR V_t , $I_{max} \geq I_{sc}$ OR I_t , $\Sigma C_i + C_{cable} \leq C_{o2}$ $L_i + L_{cable} \leq L_a$.
- FOR CLASS II & CLASS III INSTALLATIONS WHERE RIGID METAL CONDUIT IS NOT USED, SEAL CABLE ENTRIES AGAINST DUST AND FIBERS USING A NRTL LISTED CABLE GLAND FITTING.
- CONTROL EQUIPMENT CONNECTED TO ASSOCIATED APPARATUS MUST NOT USE OR GENERATE MORE THAN 250V.
- INSTALLATION MUST BE IN ACCORDANCE WITH ARTICLE 504 OF THE NEC®, ANSI/NFPA 70, AND ANSI/ISA RP12.6.
- NO REVISION TO THIS DRAWING IS PERMITTED WITHOUT FMRC APPROVAL.
- ASSOCIATED APPARATUS MUST BE FMRC APPROVED. ASSOCIATED APPARATUS MAY BE INSTALLED IN CLASS I, DIVISION 2 HAZARDOUS (CLASSIFIED) LOCATION IF SO APPROVED.
- ASSOCIATED APPARATUS MANUFACTURER'S INSTALLATION DRAWING MUST BE FOLLOWED WHEN INSTALLING THIS EQUIPMENT.
- NON-GALVANICALLY ISOLATED ASSOCIATED APPARATUS (ZENER BARRIERS) MUST BE CONNECTED TO A SUITABLE GROUND ELECTRODE PER NFPA 70, ARTICLE 504. THE RESISTANCE OF THE GROUND PATH MUST BE LESS THAN 1 OHM.
- SHIELDED WIRE IS REQUIRED FOR CE CONFORMITY AND RECOMMENDED FOR OTHER APPLICATIONS. SHIELD GROUNDED AT SUPPLY (BARRIER) END ONLY.

ST3000 Series 100 / 900 Intrinsically Safe FM			
Lightning Proof Option		Non-Lightning Proof Option	
Sheets 1 to 5		Sheets 6 to 9	
Sheets 1	Intrinsically Safe - FM	Sheets 6	RMA 3000 - SM
Sheets 2	RMA 3000 - SM	Sheets 7	RMA 3000 - ME
Sheets 3	RMA 3000 - ME	Sheets 8	ME (Analog Meter)
Sheets 4	ME (Analog Meter)	Sheets 9	RMA 3000 - DM
Sheets 5	RMA 3000 - DM		

PROJECTION		DRAWN	R.D.G.	5/1/97
LINEAR MEASURE	INCH	CHECKED		
MATERIAL		DEV ENGR	J.G.	9/10/97
		MFG ENGR	F.F.	9/18/97
		QA ENGR	T.H.	9/12/97
FINISH				

Honeywell

ST 3000 S900/S100
CONTROL DRAWING
INTRINSICALLY SAFE-FM

51204241

SCALE NONE USED ON

SHT 1 OF 9

THE COPYRIGHT OF THIS DRAWING IS THE PROPERTY OF HONEYWELL. THE DRAWING IS SUPPLIED IN CONFIDENCE AND MUST NOT BE USED FOR ANY PURPOSE OTHER THAN THAT FOR WHICH IT IS SUPPLIED.

1 2 3 4 5 6 7 8 9 10 11 12 13 14

NON-HAZARDOUS LOCATION

HAZARDOUS (CLASSIFIED) LOCATION

ST3000 TRANSMITTER

CLASS I, II, & III, DIVISION 1
GROUP A,B,C,D,E,F & G
(NOTE 2)

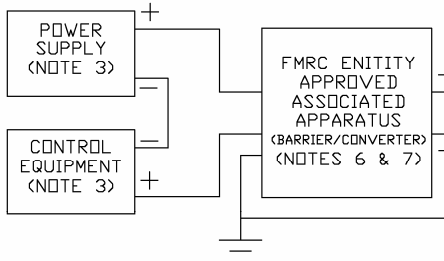

RMA300-SM

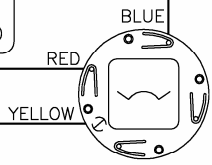
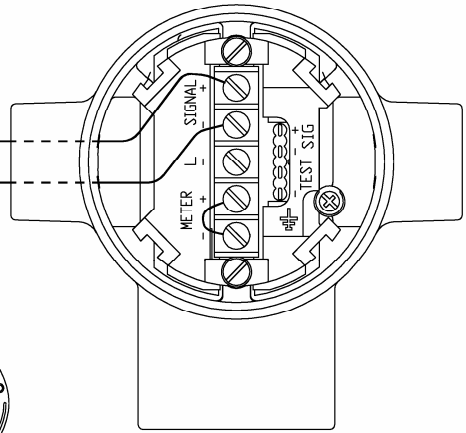
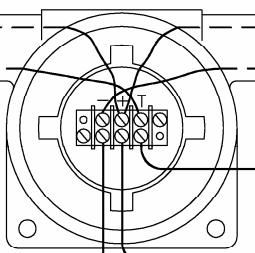

ALTERNATE WIRING #1

ST3000 TRANSMITTER

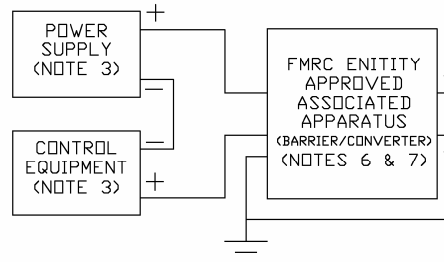

RMA300-SM

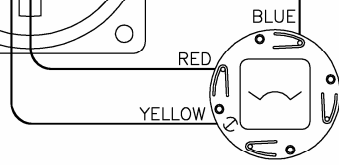
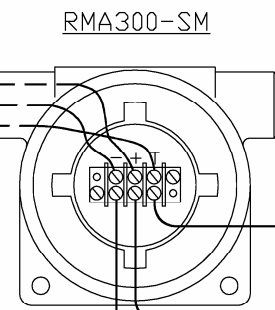
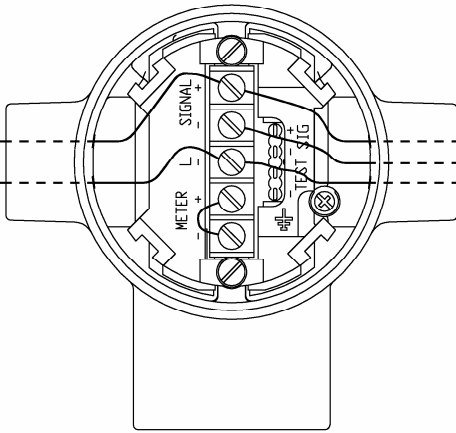

ALTERNATE WIRING #2

RMA3000 REMOTE METER OPTION
SMART METER MODEL RMA300-SM

Honeywell

C/A3

51204241

SCALE NONE REV D DATE10/06/00 SHT 2 OF 9

1 2 3 4 5 6 7 8 9 10 11 12 13 14

NON-HAZARDOUS LOCATION

HAZARDOUS (CLASSIFIED) LOCATION

ST3000 TRANSMITTER

CLASS I, II, & III, DIVISION 1
GROUP A,B,C,D,E,F & G
(NOTE 2)

SERIES 100/900

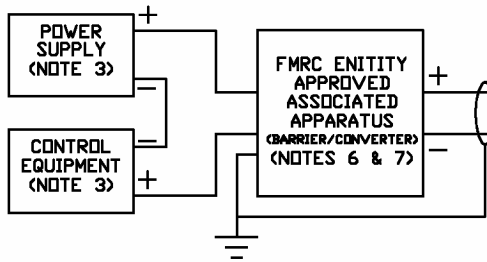

RMA300-ME

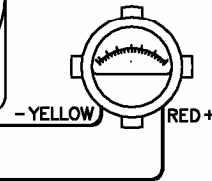
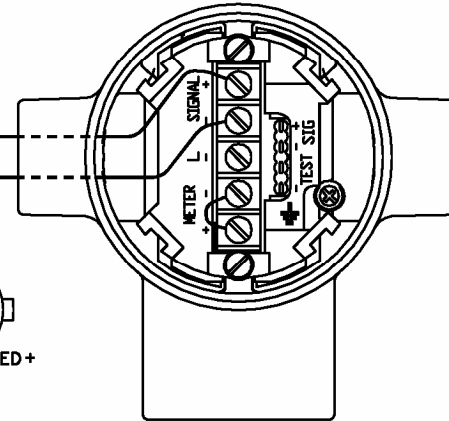

ALTERNATE WIRING #1

ST3000 TRANSMITTER

SERIES 100/900

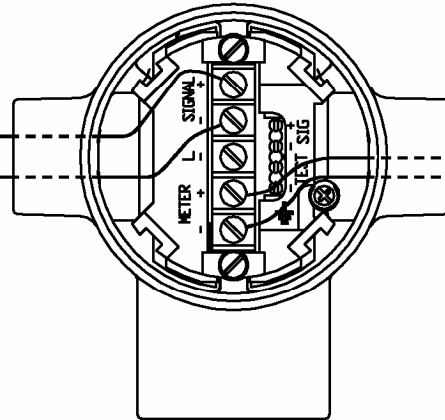
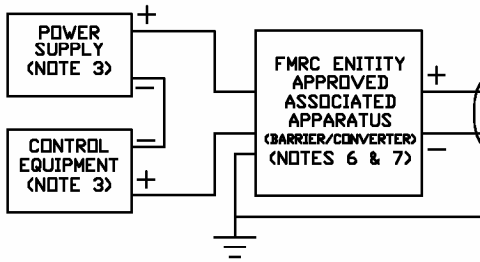

RMA300-ME

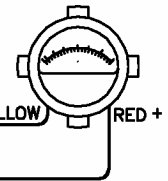

ALTERNATE WIRING #2

RMA3000 REMOTE METER OPTION
ANALOG METER MODEL RMA300-ME

Honeywell

3/43

51204241

SCALE NONE REV D DATE10/08/00 SHEET 3 OF 9

51204241

CAD

1 2 3 4 5 6 7 8 9 10 11 12 13 14

A
B
C
D
E
F
G
H
I
J
K

NON-HAZARDOUS LOCATION

HAZARDOUS (CLASSIFIED) LOCATION

CLASS I, II, & III, DIVISION 1
GROUP A,B,C,D,E,F & G
(NOTE 2)

ST3000 TRANSMITTER
SERIES 100/900

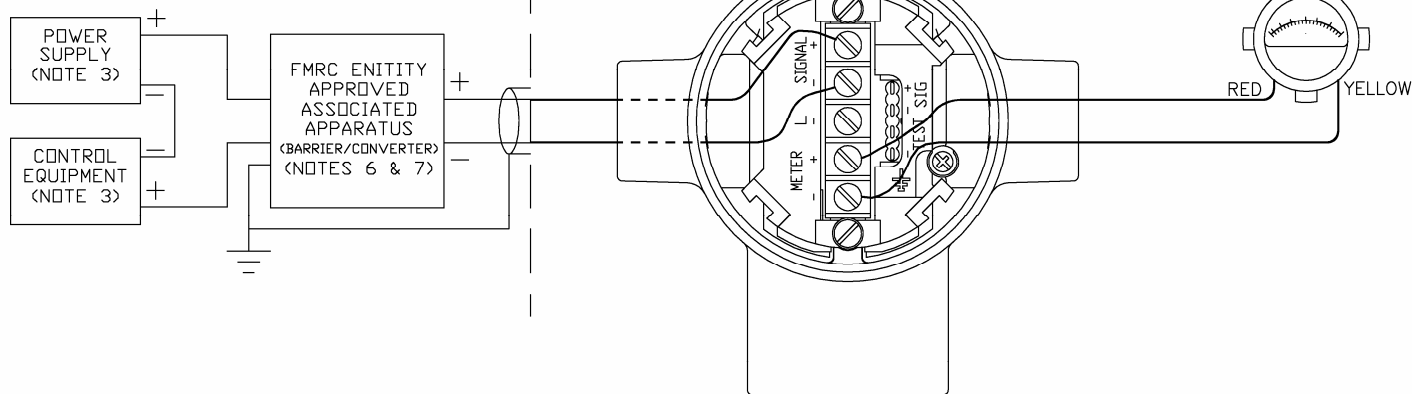

INTEGRAL METER OPTION (ME)

Honeywell

3/A3

51204241

SCALE NONE REV D DATE10/06/00 SHT 4 OF 9

1 2 3 4 5 6 7 8 9 10 11 12 13 14

NON-HAZARDOUS LOCATION

HAZARDOUS (CLASSIFIED) LOCATION

ST3000 TRANSMITTER

CLASS I, II, & III, DIVISION 1
GROUP A,B,C,D,E,F & G
(NOTE 2)

SERIES 100/900

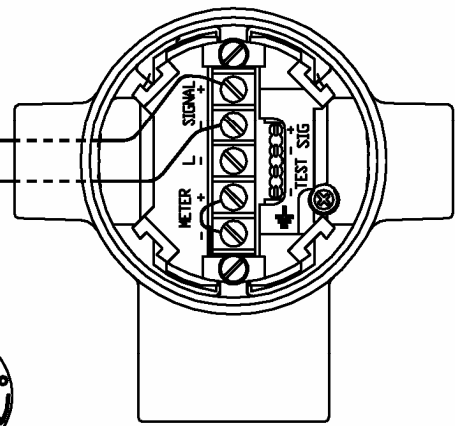
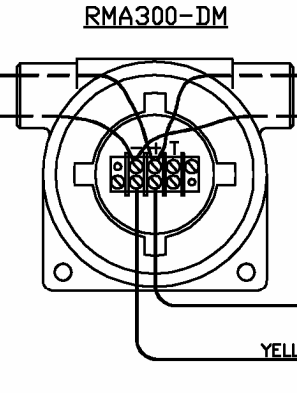
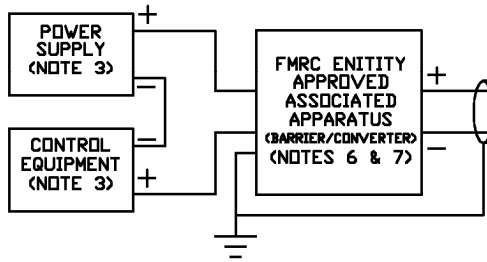

ALTERNATE WIRING #1

ST3000 TRANSMITTER

SERIES 100/900

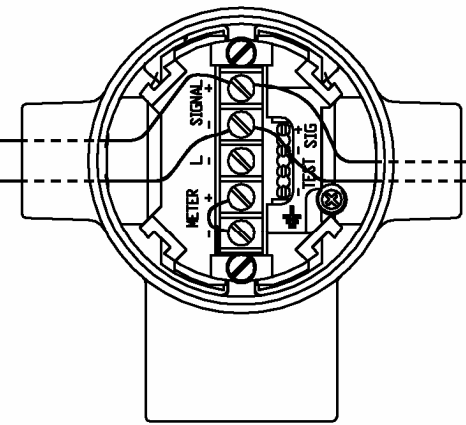
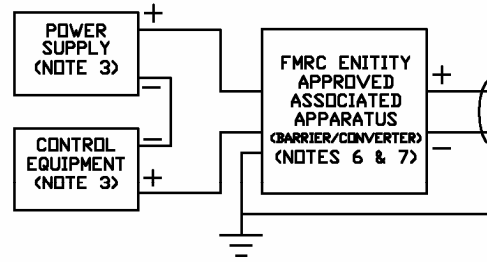

RMA300-DM

ALTERNATE WIRING #2

RMA3000 REMOTE METER OPTION
DIGITAL METER MODEL RMA300-DM

Honeywell	C/A3	51204241
	SCALE NONE REV D DATE 10/06/00 SHT 5 OF 9	

CAD ↑

51204241

I C

I

C

K

1 2 3 4 5 6 7 8 9 10 11 12 13 14

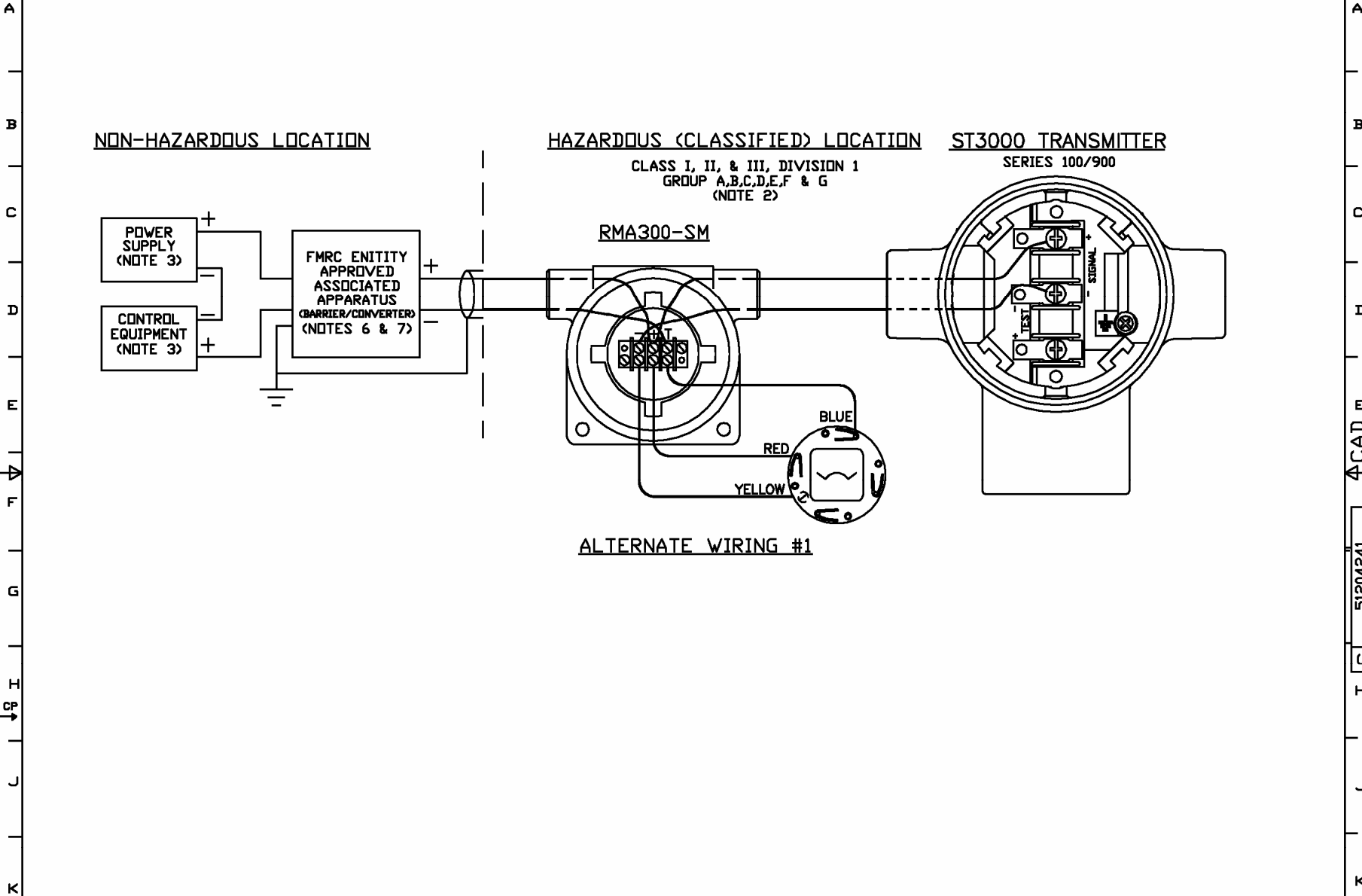

NON-HAZARDOUS LOCATION

HAZARDOUS (CLASSIFIED) LOCATION

ST3000 TRANSMITTER

CLASS I, II, & III, DIVISION 1
GROUP A,B,C,D,E,F & G
(NOTE 2)

POWER SUPPLY
(NOTE 3)

FMRC ENITITY APPROVED
ASSOCIATED APPARATUS
(BARRIER/CONVERTER)
(NOTES 6 & 7)

RMA300-SM

SERIES 100/900

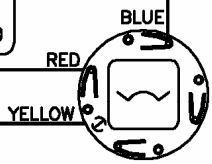

ALTERNATE WIRING #1

CAD ↑

51204241

C

I

C

K

Honeywell

A3

51204241

SCALE NONE | REV D | DATE 10/06/00 | SHEET 6 OF 9

1 2 3 4 5 6 7 8 9 10 11 12 13 14

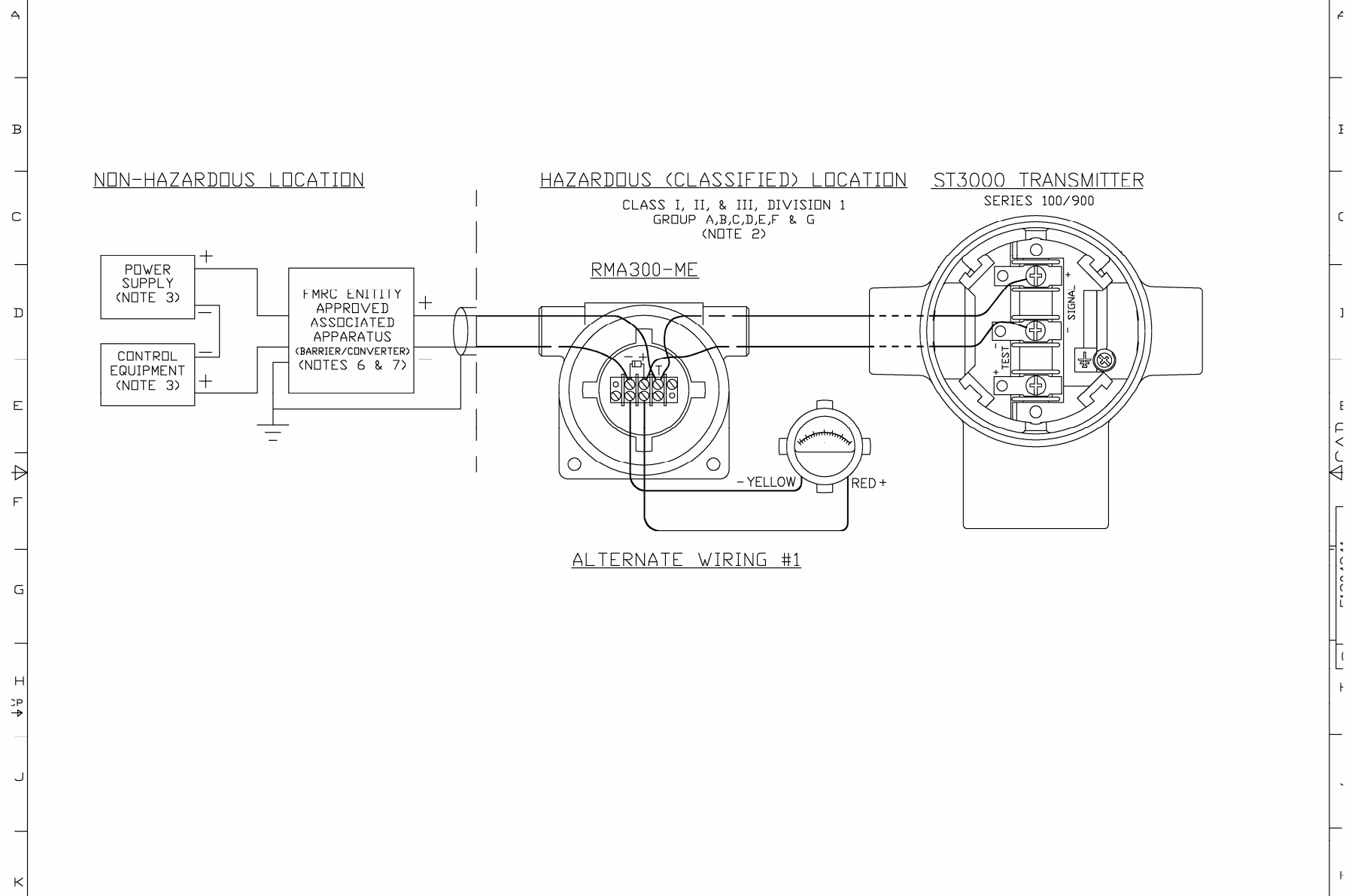

NON-HAZARDOUS LOCATION

HAZARDOUS (CLASSIFIED) LOCATION

ST3000 TRANSMITTER

CLASS I, II, & III, DIVISION 1
GROUP A,B,C,D,E,F & G
(NOTE 2)

POWER
SUPPLY
(NOTE 3)

CONTROL
EQUIPMENT
(NOTE 3)

FMRC ENITIIV
APPROVED
ASSOCIATED
APPARATUS
(BARRIER/CONVERTER)
(NOTES 6 & 7)

RMA300-ME

SERIES 100/900

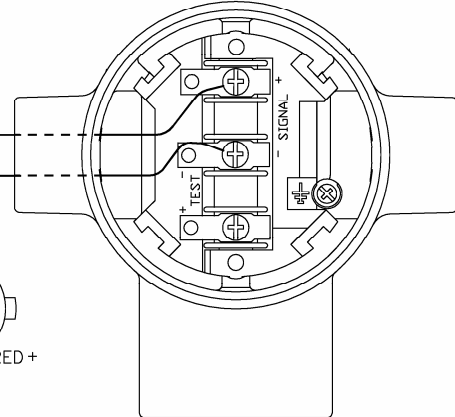

- YELLOW RED +

ALTERNATE WIRING #1

Honeywell	C/A3	51204241
		SCALE NONE REV D DATE 10/06/00 SHT 7 OF 9



NON-HAZARDOUS LOCATION

HAZARDOUS (CLASSIFIED) LOCATION

CLASS I, II, & III, DIVISION 1
GROUP A,B,C,D,E,F & G
(NOTE 2)

ST3000 TRANSMITTER
SERIES 100/900

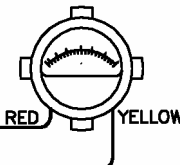
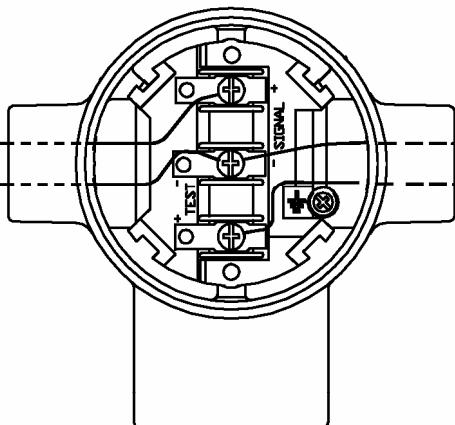
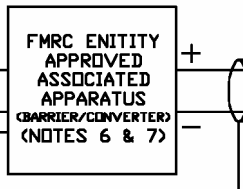
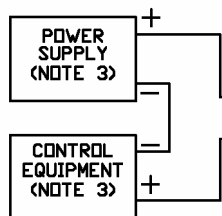

INTEGRAL METER OPTION (ME)

CAD FILE # 51204241

Honeywell	C/A3	51204241
		SCALE NONE REV D DATE 10/06/00 SHT 8 OF 9

1 2 3 4 5 6 7 8 9 10 11 12 13 14

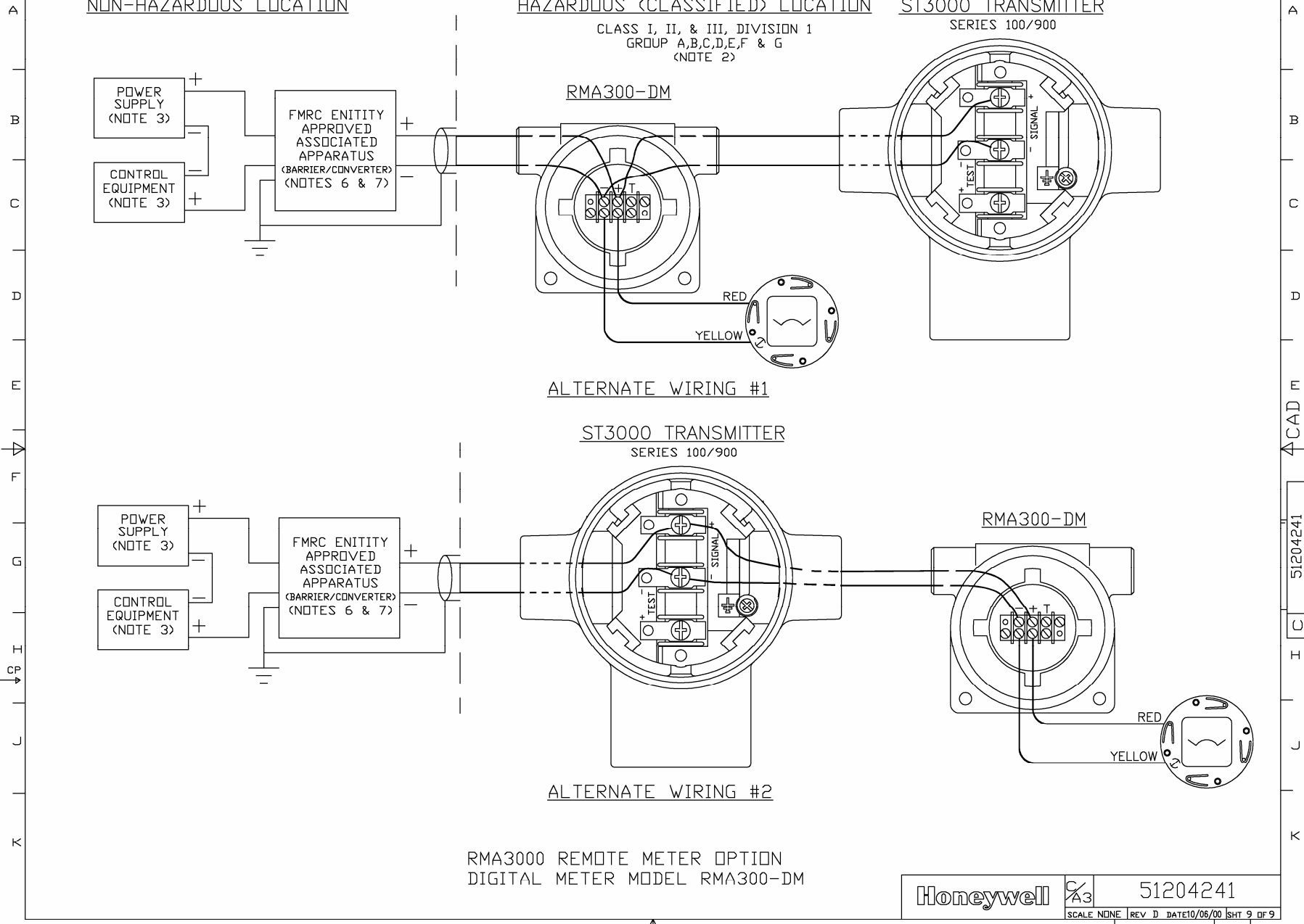

CAD

51204241

C

I

I

C

K

RMA3000 REMOTE METER OPTION
DIGITAL METER MODEL RMA300-DM

Honeywell	C/A3	51204241
		SCALE NONE REV D DATE 10/06/00 SHT 9 OF 9

SHEET	1	2	3	4	5	6	7	8	9
SIZE	C	C	C	C	C	C	C	C	C

ISS	REVISION & DATE	APPD
A	RELEASE 9/29/97 F972430	D.A.
B	REV'D F202130 07/07/00	RGV
C	REV'D F202165 10/06/00	RGV

HAZARDOUS (CLASSIFIED) LOCATION

"Exia"
INTRINSICALLY SAFE/SECURITE INTRINSEQUE
CLASS I, GROUP A,B,C,D
CLASS II, GROUP E,F,G; CLASS III
(NOTE 2)

NON-HAZARDOUS LOCATION

ENTITY PARAMETERS

Voc ≤ 42.4V
Isc ≤ 225mA
Co ≥ Ccable + Ci OF ALL LOOP DEVICES
Lo ≥ Lcable + Li OF ALL LOOP DEVICES

INTEGRAL
ANALOG METER
30752118 OR
LOCAL SMART
METER 51309389

ST3000
S900/S100
TRANSMITTER

SM3000 REMOTE METER OPTIONS

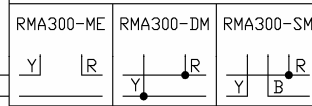

ENTITY PARAMETERS

Vmax = 42.4V
Imax = 225mA
Pmax = 1.2W
Ci = 4.2nF

LOCAL SMART METER, SM, Li = 0
ANALOG METER, ME, Li = 150uH

ENTITY PARAMETERS

Vmax = 42.4V
Imax = 225mA
Pmax = 1.2W
Ci = 0

RMA300-ME, Li = 150uH
RMA300-DM, Li = 0
RMA300-SM, Li = 0

CSA
CERTIFIED
ASSOCIATED
APPARATUS
(BARRIER/CONVERTER)
(NOTES 6 & 7)

POWER
SUPPLY
(NOTE 3)

CONTROL
EQUIPMENT
(NOTE 3)

INTRINSIC SAFETY &
SHIELD GROUND
(NOTE 8 & 9)

NOTES:

1. CSA PARAMETRIC OR ENTITY CERTIFIED BARRIERS MAY BE USED, BARRIERS MUST BE INSTALLED IN ACCORDANCE WITH MANUFACTURERS INSTRUCTIONS, FOR THE ENTITY EVALUATION Vmax ≥ Voc, Imax ≥ Isc, Ci ≤ Co, Li ≤ Lo.
2. FOR CLASS II & CLASS III INSTALLATIONS WHERE RIGID METAL CONDUIT IS NOT USED, SEAL CABLE ENTRIES AGAINST DUST AND FIBERS USING A NRTL LISTED CABLE GLAND FITTING.
3. CONTROL EQUIPMENT CONNECTED TO ASSOCIATED APPARATUS MUST NOT USE OR GENERATE MORE THAN 250V.
4. INSTALLATION MUST BE IN ACCORDANCE WITH THE CANADIAN ELECTRICAL CODE, PART 1.
5. NO REVISION TO THIS DRAWING IS PERMITTED WITHOUT CSA APPROVAL.
6. ASSOCIATED APPARATUS MUST BE CSA CERTIFIED. ASSOCIATED APPARATUS MAY BE INSTALLED IN CLASS I, DIVISION 2 HAZARDOUS (CLASSIFIED) LOCATION IF SO CERTIFIED.
7. ASSOCIATED APPARATUS MANUFACTURER'S INSTALLATION DRAWING MUST BE FOLLOWED WHEN INSTALLING THIS EQUIPMENT.
8. RESISTANCE OF THE GROUND PATH MUST BE LESS THAN 1 OHM.
9. SHIELDED WIRE IS REQUIRED FOR CE CONFORMITY AND RECOMMENDED FOR OTHER APPLICATIONS. SHIELD GROUNDED AT SUPPLY (BARRIER) END ONLY.
10. SUITABLE FOR INSTALLATION WITHOUT BARRIERS IN CLASS I DIV2 GROUPS A,B,C,D WHEN INSTALLED IN (OR THROUGH THE WALL OF) A SUITABLE ENCLOSURE WITH PROVISION FOR CONNECTION OF RIGID CONDUIT PER CANADIAN ELECTRICAL CODE, AS ACCEPTABLE TO THE LOCAL INSPECTION AUTHORITY HAVING JURISDICTION.
11. IN DIV 2 INSTALLATIONS (WITHOUT BARRIERS), OBSERVE THE FOLLOWING WARNINGS.
WARNING EXPLOSION HAZARD
DO NOT DISCONNECT EQUIPMENT UNLESS POWER HAS BEEN SWITCHED OFF OR THE AREA IS KNOWN TO BE NON-HAZARDOUS.

AVERTISSEMENT: RISQUE D'EXPLOSION
AVANT DE DECONNECTER L'EQUIPEMENT, COUPER LE COURANT OU S'ASSURER QUE L'EMPLACEMENT EST DESIGNÉ NON DANGERUX.

12. IF BARRIERS WITH VOLT/OHM PARAMETERS ARE USED, THE FOLLOWING PARAMETERS SHALL APPLY:
30V(MAX), 300 OHMS(MIN)
28V(MAX), 300 OHMS(MIN)
22V(MAX), 180 OHMS(MIN)



CERTIFICATION DOCUMENT
ENGINEERING CHANGES
(ECO'S) MUST BE
AUTHORIZED BY
APPROVALS SPECIALIST

THE COPYRIGHT OF THIS DRAWING IS THE PROPERTY OF HONEYWELL. THE DRAWING IS SUPPLIED IN CONFIDENCE AND MUST NOT BE USED FOR ANY PURPOSE OTHER THAN THAT FOR WHICH IT IS SUPPLIED.

ST3000 Series 100 / 900 Intrinsically Safe CSA			
Lightning Proof Option		Lightning Proof Option	
Sheets 1 to 5		Sheets 6 to 9	
Sheets 1	Intrinsically Safe - CSA	Sheets 6	RMA 3000 - SM
Sheets 2	RMA 3000 - SM	Sheets 7	RMA 3000 - ME
Sheets 3	RMA 3000 - ME	Sheets 8	ME (Analog Meter)
Sheets 4	ME (Analog Meter)	Sheets 9	RMA 3000 - DM
Sheets 5	RMA 3000 - DM		

PROJECTION		DRAWN	R.D.G.	5/1/97
LINEAR MEASURE	INCH	CHECKED		
MATERIAL		DEV ENGR	J.G.	9/10/97
		MFG ENGR	T.H.	9/12/97
		QA ENGR	F.F.	9/18/97
FINISH		TOLERANCE UNLESS NOTED		
		ANGULAR DIMENSION	SCALE NONE	USED ON

Honeywell

ST 3000 S900/S100
CONTROL DRAWING
INTRINSICALLY SAFE-CSA

51204242

SCALE NONE USED ON

SHT 1 OF 9

ACAD-093097

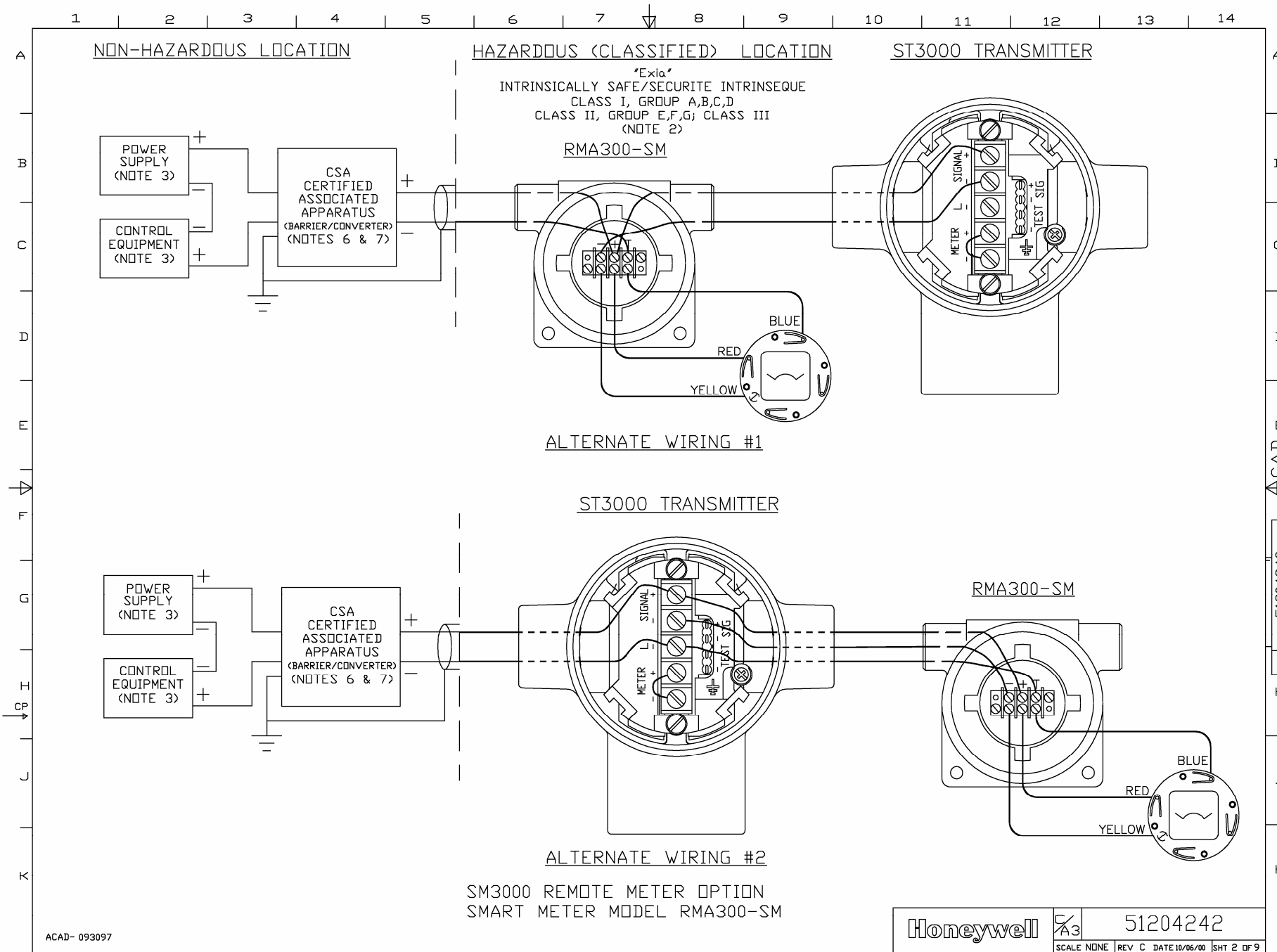

ACAD- 093097

CADFILE #: 204242-2 .DWG

SM3000 REMOTE METER OPTION
SMART METER MODEL RMA300-SM

Honeywell

CA3

51204242

SCALE NONE REV C DATE 10/06/00 SH 2 OF 9

DO NOT SCALE DRAWING

51204242

C

I

S

C

K

K

CAD

1 2 3 4 5 6 7 8 9 10 11 12 13 14

A
B
C
D
E
F
G
H
I
J
K

NON-HAZARDOUS LOCATION

HAZARDOUS (CLASSIFIED) LOCATION

"Exia"
INTRINSICALLY SAFE/SECURITE INTRINSEQUE
CLASS I, GROUP A,B,C,D
CLASS II, GROUP E,F,G; CLASS III
(NOTE 2)

ST3000 TRANSMITTER
SERIES 100/900

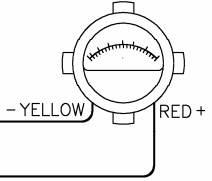
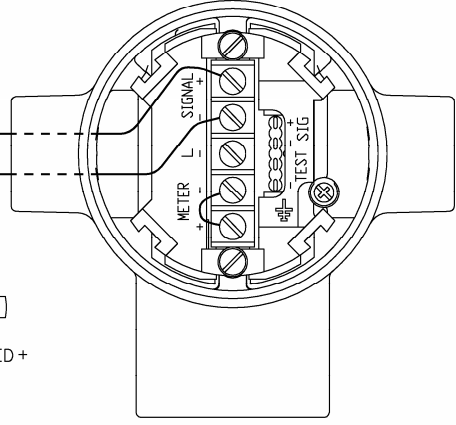
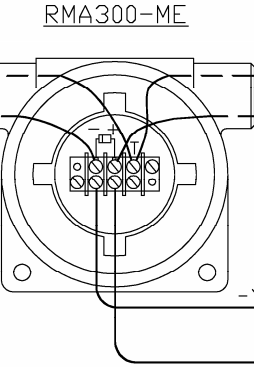
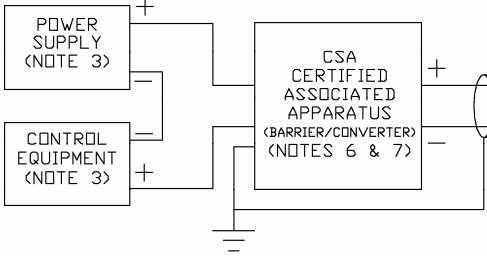

ALTERNATE WIRING #1

ST3000 TRANSMITTER
SERIES 100/900

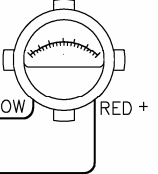
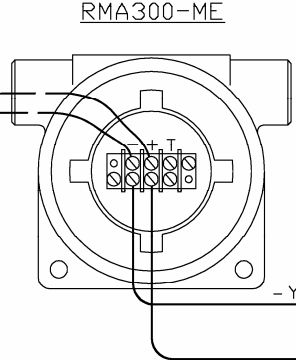
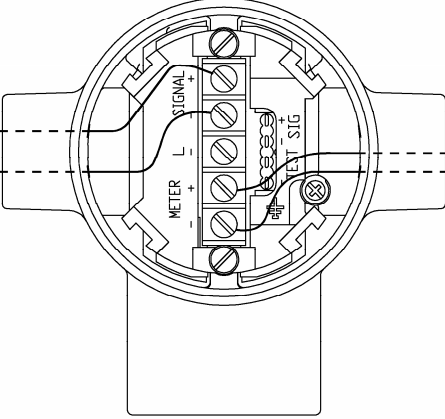
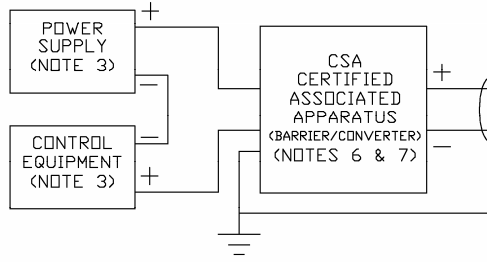

ALTERNATE WIRING #2

SM3000 REMOTE METER OPTION
ANALOG METER MODEL RMA300-ME

ACAD- 070700

CADFILE #: 204242-3 .DWG

Honeywell

C/A3

51204242

SCALE NONE REV. C DATE:10/06/00 SHT 3 OF 9

DO NOT SCALE DRAWING

1 2 3 4 5 6 7 8 9 10 11 12 13 14

A
B
C
D
E
F
G
H
I
J
K

NON-HAZARDOUS LOCATION

HAZARDOUS (CLASSIFIED) LOCATION

"Exia"
INTRINSICALLY SAFE/SECURITE INTRINSEQUE
CLASS I, GROUP A,B,C,D
CLASS II, GROUP E,F,G; CLASS III
(NOTE 2)

ST3000 TRANSMITTER
SERIES 100/900

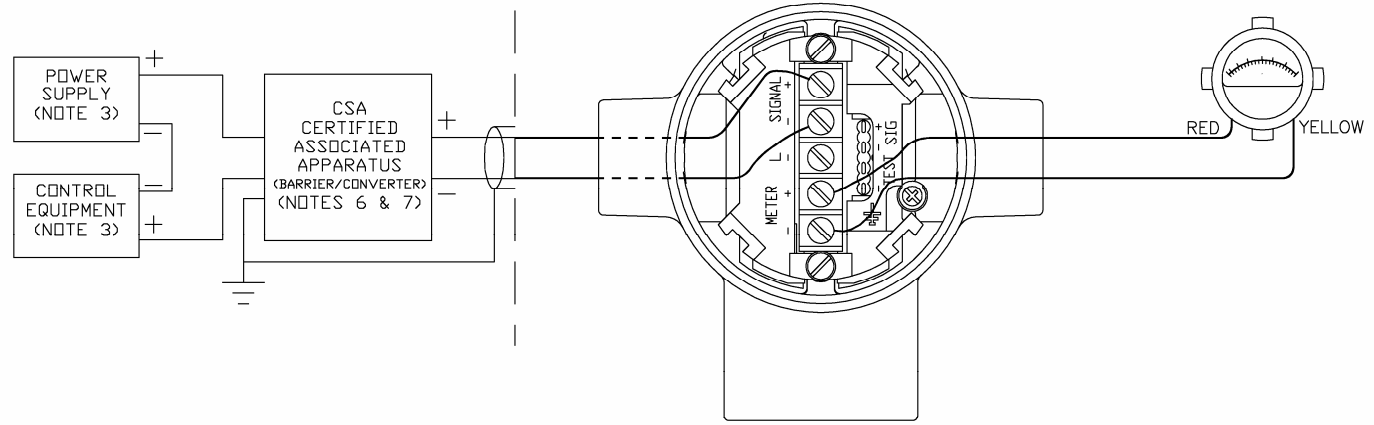

INTEGRAL METER OPTION (ME)

ACAD- 07/07/00

CADFILE #: 204242-4 .DWG

Honeywell	C/A3	51204242
	SCALE NONE	REV C DATE 10/06/00
		SHT 4 OF 9

DO NOT SCALE DRAWING



1 2 3 4 5 6 7 8 9 10 11 12 13 14

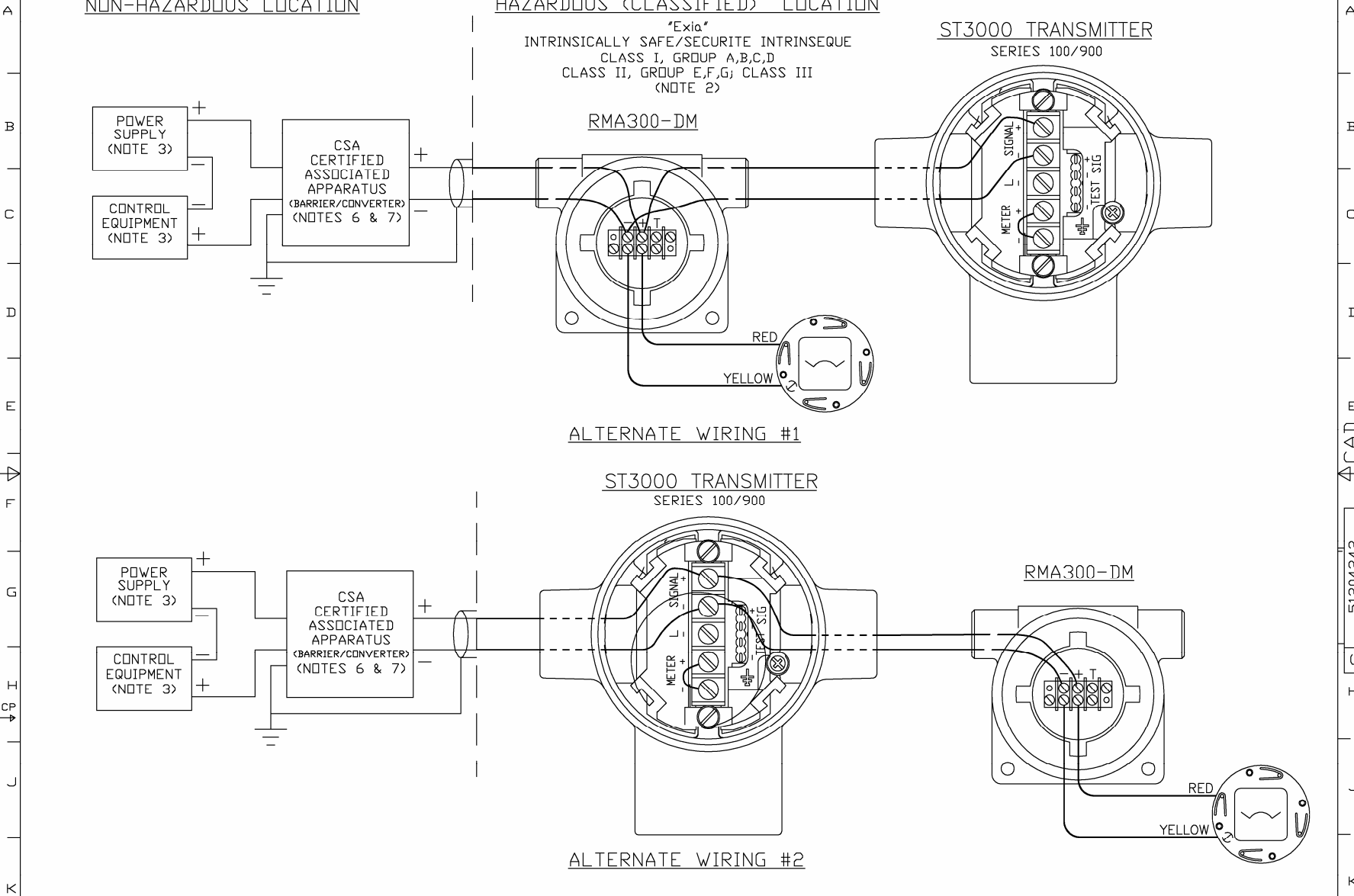

ALTERNATE WIRING #1

ALTERNATE WIRING #2

SM3000 REMOTE METER OPTION
DIGITAL METER MODEL RMA300-DM

ACAD- 07/07/00

CADFILE #: 204242-5 .DWG

DO NOT SCALE DRAWING

Honeywell	C/A3	51204242
		SCALE NONE REV C DATE:10/06/00 SHT 5 OF 9

51204242

C

I

K

CAD



1 2 3 4 5 6 7 8 9 10 11 12 13 14

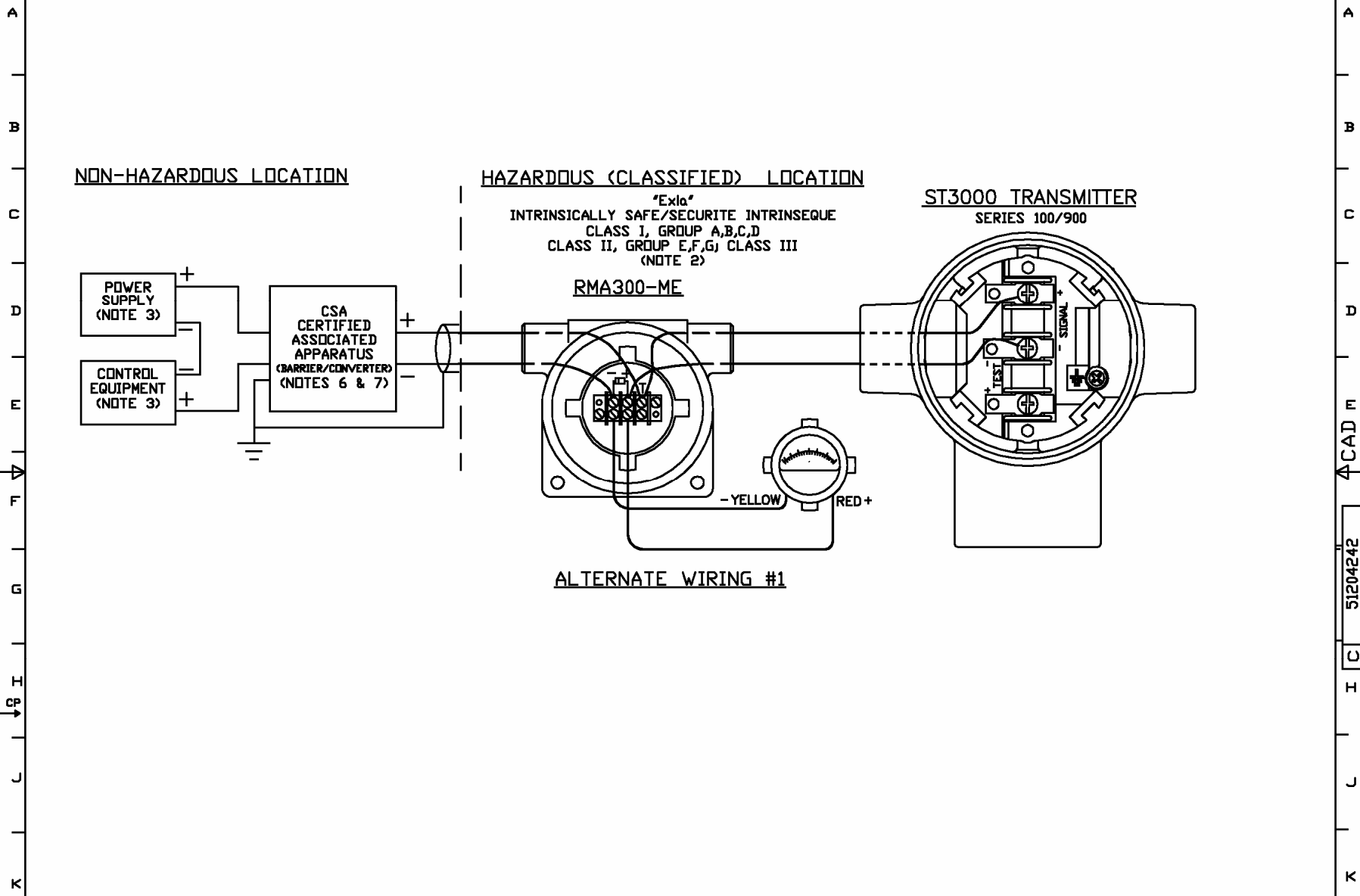

NON-HAZARDOUS LOCATION

HAZARDOUS (CLASSIFIED) LOCATION

"Exia"
INTRINSICALLY SAFE/SECURE INTRINSEQUE
CLASS I, GROUP A,B,C,D
CLASS II, GROUP E,F,G; CLASS III
(NOTE 2)

ST3000 TRANSMITTER
SERIES 100/900

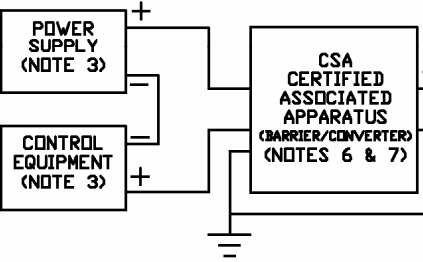

RMA300-ME

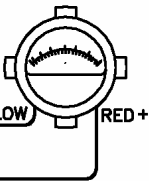

ALTERNATE WIRING #1

A
B
C
D
E
F
G
H
I
J
K

CAD

51204242

I

C

K

ACAD- 07/07/00

CADFILE #: 204242-7.DWG

Honeywell

A3

51204242

SCALE NONE REV C DATE 11/06/00 SHEET 7 OF 9

DO NOT SCALE DRAWING

NON-HAZARDOUS LOCATION

HAZARDOUS (CLASSIFIED) LOCATION

"Exia"
INTRINSICALLY SAFE/SECURITE INTRINSEQUE
CLASS I, GROUP A,B,C,D
CLASS II, GROUP E,F,G; CLASS III
(NOTE 2)

ST3000 TRANSMITTER

SERIES 100/900

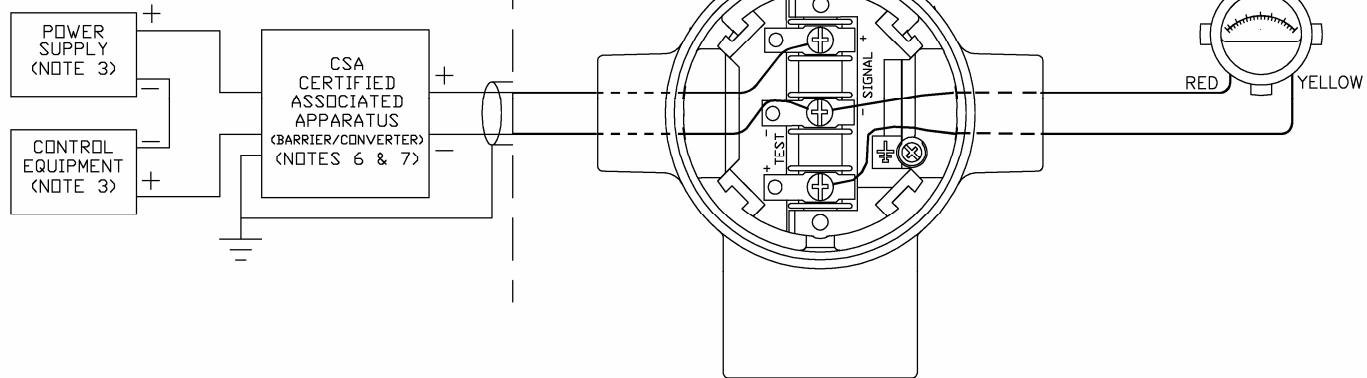

INTEGRAL METER OPTION (ME)

ACAD- 07/07/00

CADFILE #: 204242-8 .DWG

Honeywell

CA3

51204242

SCALE NONE REV C DATE 10/06/00 SHT 8 OF 9

DO NOT SCALE DRAWING

1 2 3 4 5 6 7 8 9 10 11 12 13 14

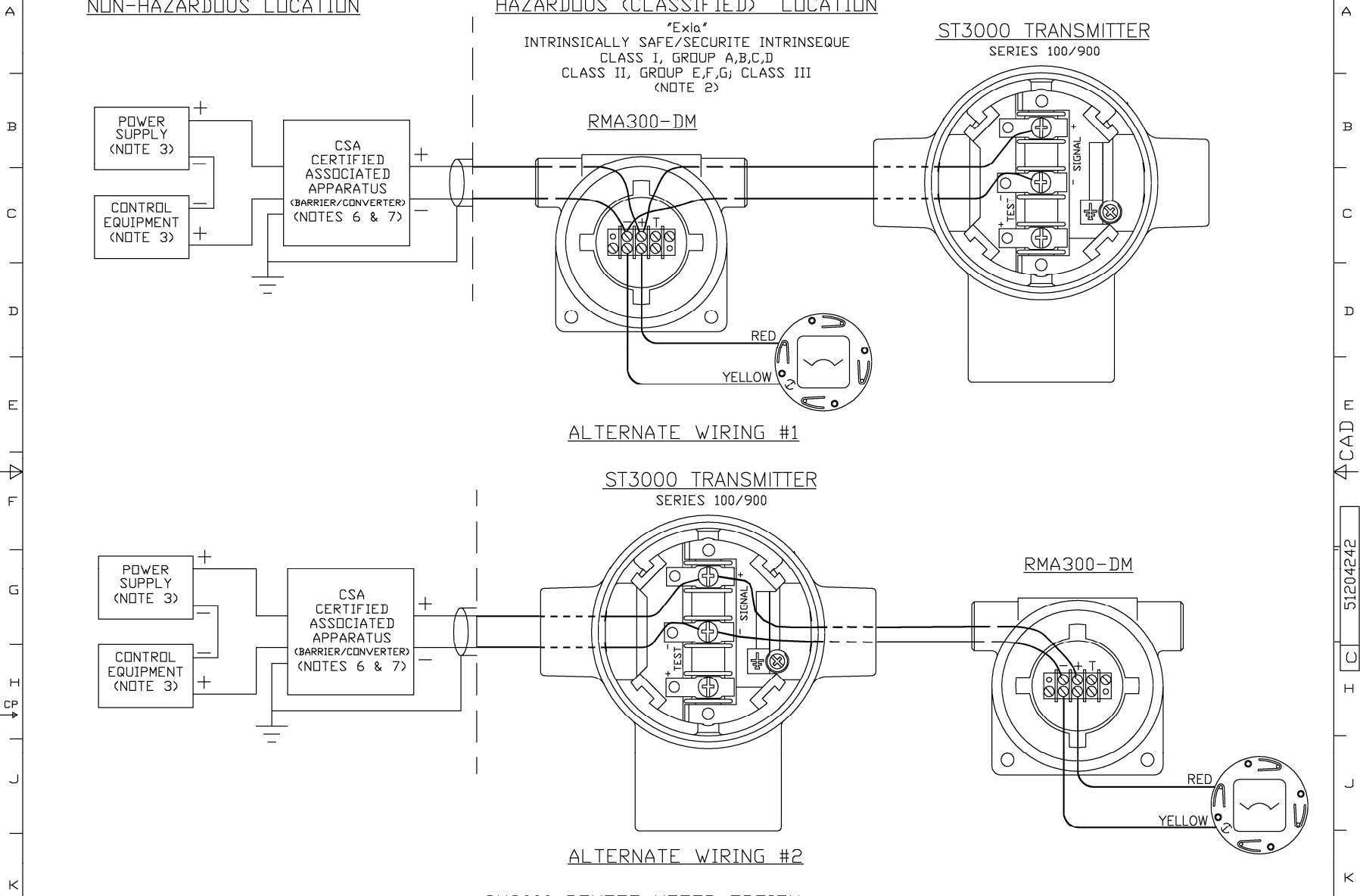

A B C D E F G H I J K

CAD ↑

51204242

ACAD- 07/07/00

CADFILE #: 204242-9 .DWG

SM3000 REMOTE METER OPTION
DIGITAL METER MODEL RMA300-DM

Honeywell	A3	51204242
		SCALE NONE REV. C DATE 10/06/00 SHT 9 OF 9

DO NOT SCALE DRAWING

1 2 3 4 5 6 7 8 9 10 11 12 13 14

PRE REL					
ISS	REVISION & DATE	APPD			
A	RELEASED F992834	072799	W.F.		
B	REV'D 07/07/00	F202130	RGV		
C	REV'D 10/06/00	F202165	RGV		

HAZARDOUS LOCATION
EEx ia IIC T5

NON-HAZARDOUS LOCATION

INTEGRAL
ANALOG METER
30752118 OR
LOCAL SMART
METER 51309389

ST3000
S900/S100
TRANSMITTER

SHIELD
(NOTE 6)

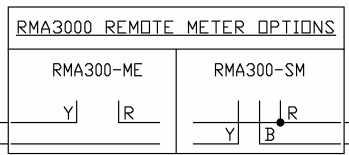

ENTITY PARAMETERS

$U_m \leq 250V$
 $U_o \leq 30V$
 $I_o \leq 100mA$
 $C_o \geq C_{cable} + C_i$ OF ALL LOOP DEVICES
 $L_o \geq L_{cable} + L_i$ OF ALL LOOP DEVICES
 $P_o \leq 1.2 W$

CENELEC
CERTIFIED
ASSOCIATED
APPARATUS
(BARRIER/CONVERTER)
(NOTES 4 & 5)

POWER
SUPPLY
(NOTE 1)

CONTROL
EQUIPMENT
(NOTE 1)

ENTITY PARAMETERS

$U_i = 30V$
 $I_i = 100mA$
 $P_i = 1.2W$
 $C_i = 4.2nF$
 $L_i = 0$
 LOCAL SMART METER, SM, $L_i = 0$
 ANALOG METER, ME, $L_i = 150\mu H$

ENTITY PARAMETERS

$U_i = 30V$
 $I_i = 100mA$
 $P_i = 1.2W$
 RMA300-ME $C_i = 0$
 $L_i = 150\mu H$
 RMA300-SM, $C_i = 18 nF$
 $L_i = 0$

INTRINSIC SAFETY &
SHIELD GROUND
(NOTE 5 & 6)



CERTIFICATION DOCUMENT
ENGINEERING CHANGES
(ECO'S) MUST BE
AUTHORIZED BY
APPROVALS SPECIALIST

NOTES:

- CONTROL EQUIPMENT CONNECTED TO BARRIERS MUST NOT USE OR GENERATE MORE THAN 250V.
- INSTALLATION MUST BE IN ACCORDANCE WITH THE APPLICABLE PORTIONS OF EN 50039 AND EN 60079-14.
- NO REVISION TO THIS DRAWING IS PERMITTED WITHOUT LCIE APPROVAL.
- BARRIERS MUST BE CENELEC CERTIFIED AND THE BARRIER MANUFACTURE'S INSTALLATION DRAWING MUST BE FOLLOWED WHEN INSTALLING THIS EQUIPMENT.
- NON-GALVANICALLY ISOLATED BARRIERS MUST BE CONNECTED TO A SUITABLE EARTH ELECTRODE PER prEN 50154, 12.2.4. THE RESISTANCE OF EARTH GROUND PATH MUST BE LESS THAN 1 OHM.
- SHIELDED WIRE IS REQUIRED FOR CE CONFORMITY AND RECOMMENDED FOR OTHER APPLICATIONS. SHIELD GROUNDED AT SUPPLY (BARRIER) END ONLY.

ST3000 Series 100 / 900 Intrinsically Safe Cenelec			
Lightning Proof Option		Non-Lightning Proof Option	
Sheets 1 to 4		Sheets 5 to 7	
Sheets 1	Intrinsically Safe - Cenelec	Sheets 5	RMA 3000 - SM
Sheets 2	RMA 3000 - SM	Sheets 6	RMA 3000 - ME
Sheets 3	RMA 3000 - ME	Sheets 7	ME (Analog Meter)
Sheets 4	ME (Analog Meter)		

PROJECTION		DRAWN	R.D.G.	10/2/97	Honeywell
LINEAR MEASURE: INCH		CHECKED	W.F.	7/27/99	
MATERIAL		DEV ENGR	R.A.	7/27/99	
FINISH		MFG ENGR	F.X.F.	7/27/99	
		QA ENGR	D.S.	7/27/99	ST3000 S900/S100 CONTROL DRAWING INTRINSICALLY SAFE-CENELEC
					C/A2
					51204243
					SCALE NONE USED ON
					SHT 1 OF 7

THE COPYRIGHT OF THIS DRAWING IS THE PROPERTY OF HONEYWELL. THE DRAWING IS SUPPLIED IN CONFIDENCE AND MUST NOT BE USED FOR ANY PURPOSE OTHER THAN THAT FOR WHICH IT IS SUPPLIED.

51204243

CAD

1 2 3 4 5 6 7 8 9 10 11 12 13 14

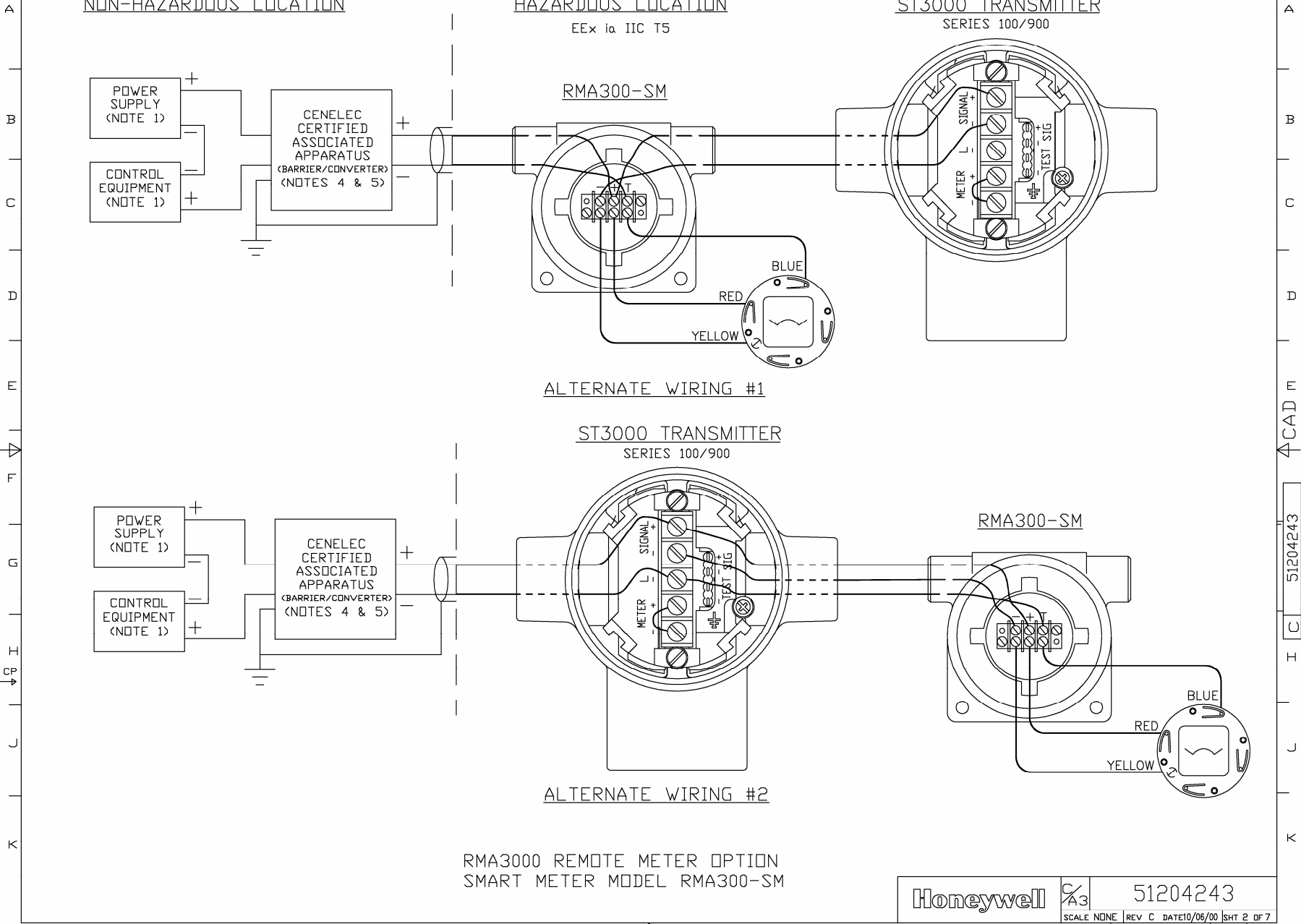

CAD ↑

51204243

C

I

I

C

C

K

Honeywell	C/A3	51204243
		SCALE NONE REV. C DATE 10/06/00 SHT 2 OF 7

1 2 3 4 5 6 7 8 9 10 11 12 13 14

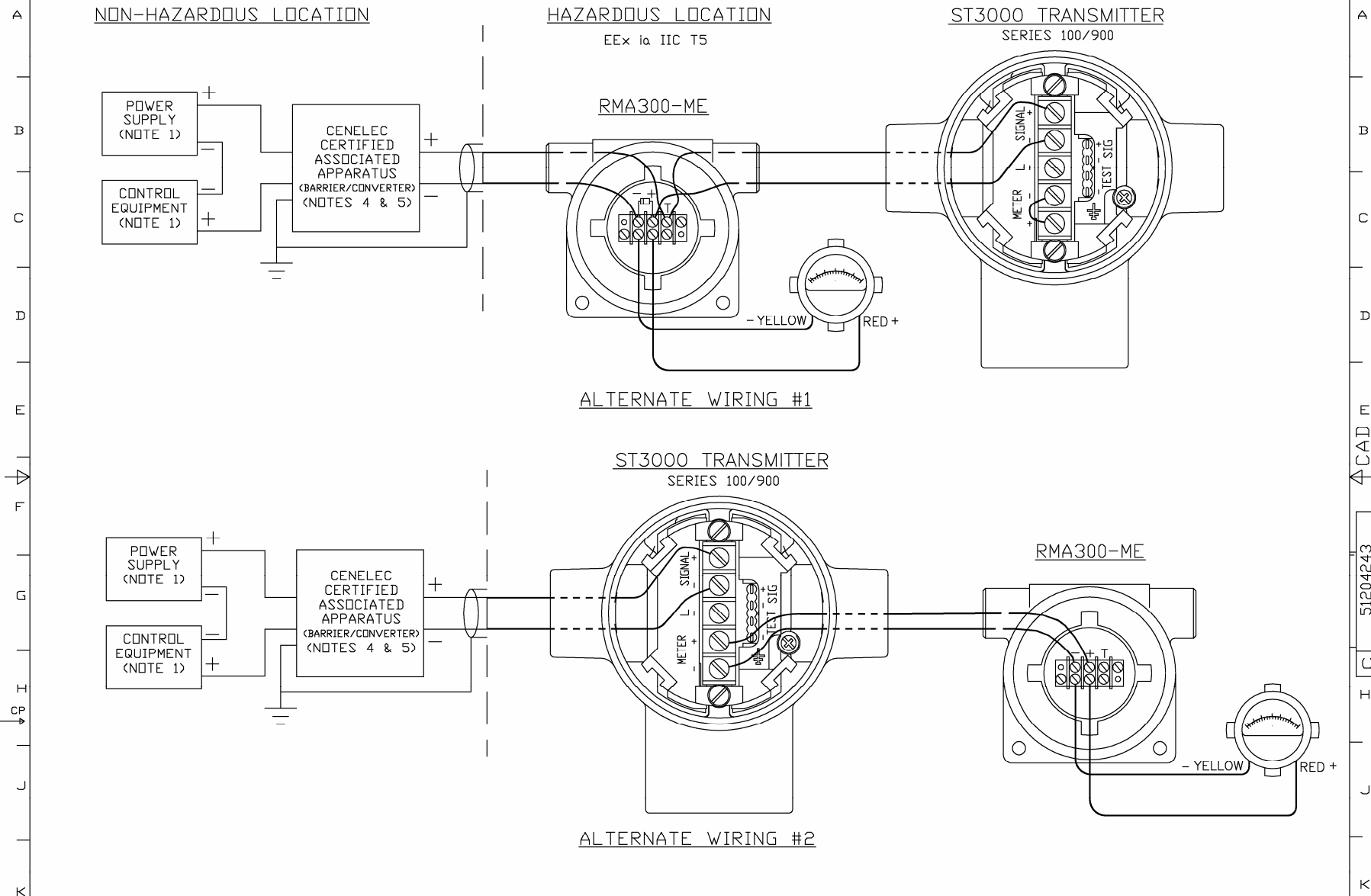

RMA3000 REMOTE METER OPTION
ANALOG METER MODEL RMA300-ME

Honeywell	C/A3	51204243
		SCALE NONE REV C DATE10/06/00 SHT 3 OF 7

CAD 51204243

I C

I I

C C

K K

J J

1 2 3 4 5 6 7 8 9 10 11 12 13 14

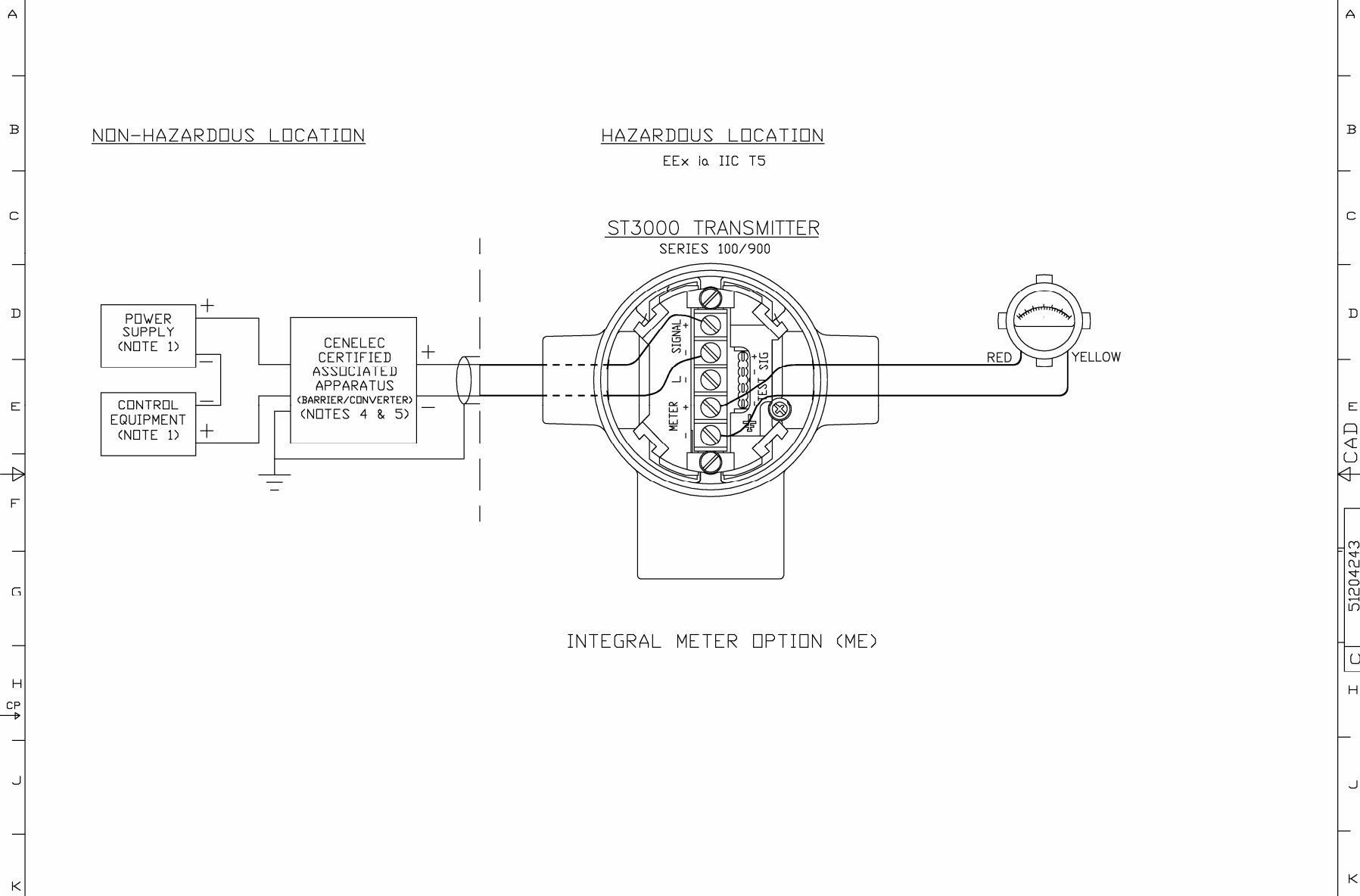

CAD

51204243

I C

Honeywell	C/A3	51204243
		SCALE NONE REV C DATE10/06/00 SHT 4 OF 7

NON-HAZARDOUS LOCATION

HAZARDOUS LOCATION

ST3000 TRANSMITTER

EEEx ia IIC T5

SERIES 100/900

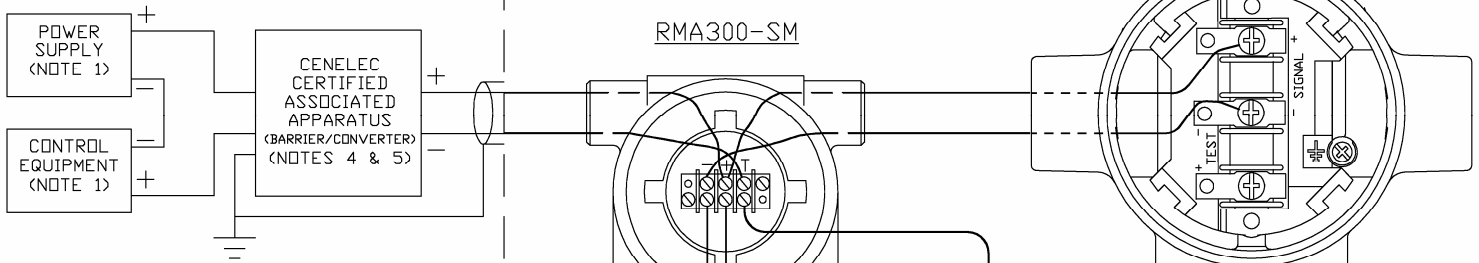

ALTERNATE WIRING #1

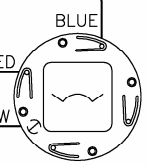

CAD

51204243

C

I

C

K

Honeywell	C/A3	51204243
		SCALE NONE REV C DATE 10/06/00 SHT 5 OF 7

1 2 3 4 5 6 7 8 9 10 11 12 13 14

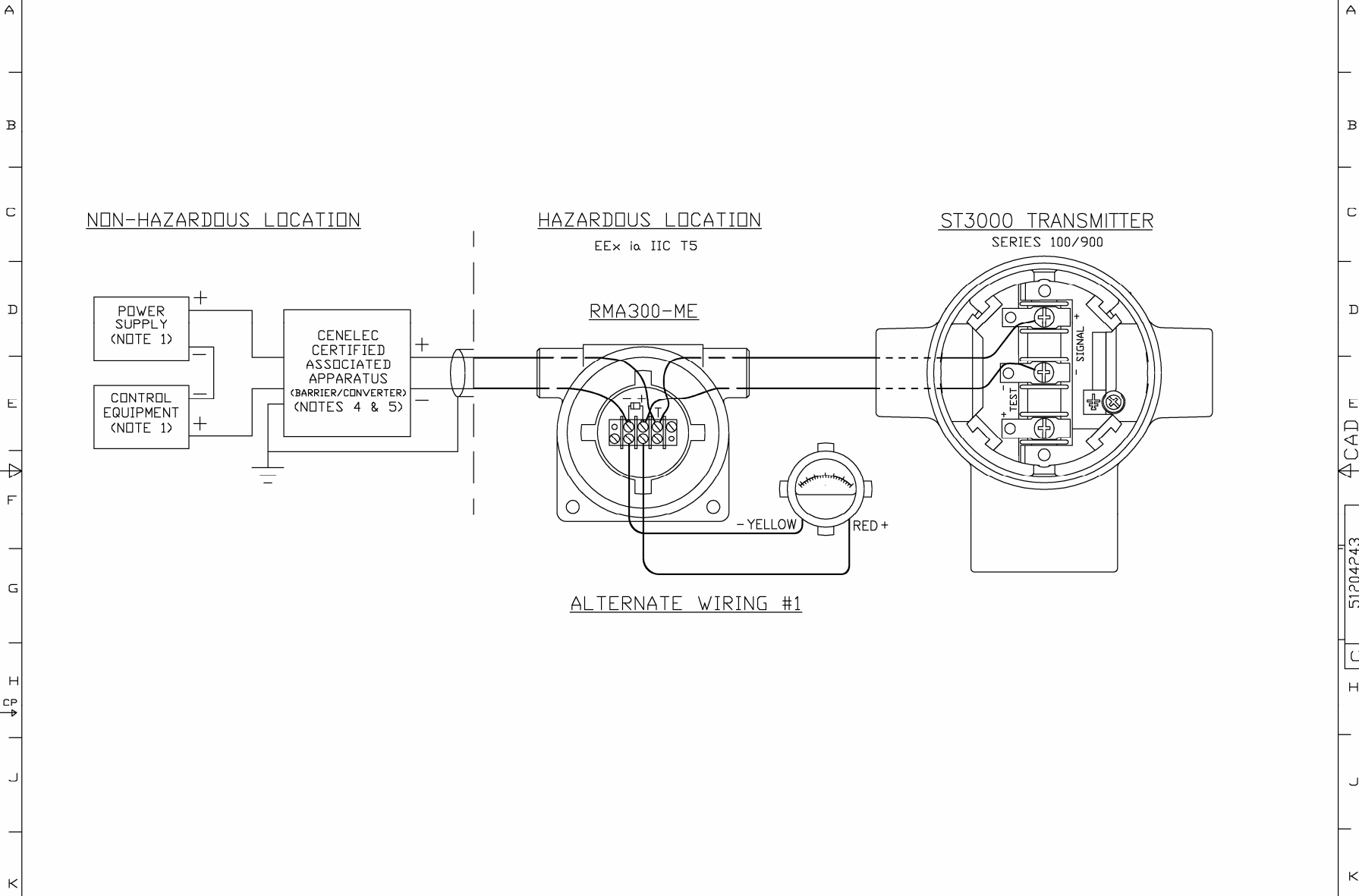

CAD ↑

51204243

C

I

L

K

Honeywell	A3	51204243
		SCALE NONE REV C DATE 10/06/00 SHT 6 OF 7

1 2 3 4 5 6 7 8 9 10 11 12 13 14

A
B
C
D
E
F
G
H
I
J
K

NON-HAZARDOUS LOCATION

HAZARDOUS LOCATION

EEx ia IIC T5

ST3000 TRANSMITTER

SERIES 100/900

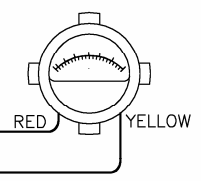
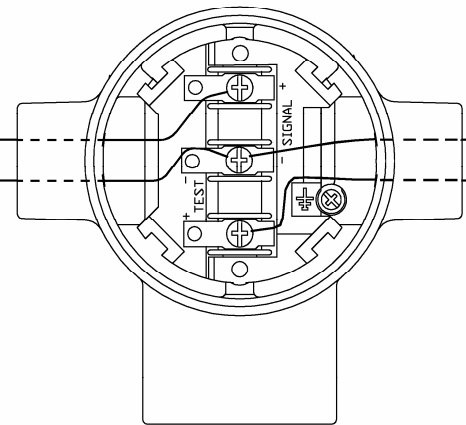
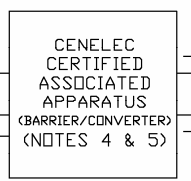
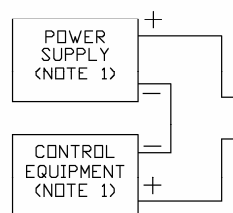

INTEGRAL METER OPTION (ME)

A
B
C
D
E
F
G
H
I
J
K

51204243

Honeywell	C/A3	51204243
		SCALE NONE REV C DATE10/06/00 SH7 7 OF 7



Appendix A – Table III Options in Model Number

A.1 Table III Options Reference

Codes and descriptions

The following table lists available Table III options alphabetically and numerically by their codes and gives a brief description of the options. Note that restrictions do apply based on other as-built transmitter characteristics and some options are mutually exclusive.

If Code is . . .	Then, transmitter option is . . .
A1	1/2-inch NPT to M20 316 stainless steel conduit adapter.
A2	1/2-inch NPT to 3/4-inch NPT 316 stainless steel conduit adapter.
B1 or B2	Blind DIN stainless steel adapter flanges mounted with NACE bolts on process head.
CC	Custom calibration to user specified range and user specified transmitter tag number entered and stored in memory.
CF	Calibration Fixture (with ¼" NPT Port for pressure source) for STG93P only.
CM	Compound characterized meter body.
CV	Stainless steel center vent drain and bushing.
CR	A286 stainless steel and 302/304 stainless steel (NACE) nuts for process heads and 316 stainless steel (NACE) bolts for mounting flange adapter to process head.
DN	316 stainless steel modified DIN process heads.
FB	Flat mounting bracket (carbon steel).
F1	Calibration test report and certificate of conformance (F3399).
F3	Certificate of conformance (F3391).
F5	Certificate of Origin (F0195).
F7	NACE certificate (F0198).
HR	Stainless steel reference head (carbon steel is standard).
LP	Lightning protection.
LT	Low temperature (–50°C) ambient limit.
MB	Angle mounting bracket (carbon steel).
ME	Analog meter (0 to 100% linear, 0 to 10 square root).

Continued on next page

A.1 Table III Options Reference, Continued

Codes and descriptions,
continued

If Code is . . .	Then, transmitter option is . . .
MS	316LSS Mounting Sleeve (requires customer installation to process) for STG93P only.
OX	Clean transmitter for Oxygen or Chlorine service with certificate.
SB	Angle mounting bracket (stainless steel).
SH	316 stainless steel electronics housing with M20 conduit connections.
SM	Local Smart Meter
SV	Side vent/drain in process head (end vent/drain is standard).
S1 or S2	1/2-inch, NPT, stainless steel, adapter flange for process head.
TB	Stainless steel customer wired -on tag (blank).
TC	Factory configured per user supplied data.
TF	Teflon process head gasket (Viton is standard).
TG	Wired-on, stainless steel customer tag (4-lines, 28 characters per line; customer supplied information).
TP	Over-pressure leak test with F3392 certificate.
T1 or T2	1/2-inch, NPT, Hastelloy C, adapter flange for process head.
VT	Viton head gaskets (1/2-inch adapter gaskets are special).
V1 or V2	1/2-inch, NPT, Monel, adapter flange for process head.
WP	Write protection.
W1	Additional warranty for 1 year.
W2	Additional warranty for 2 years.
W3	Additional warranty for 3 years.
W4	Additional warranty for 4 years.
ZS	Local Zero and Span adjustments.
00	None.

Continued on next page

A.1 Table III Options Reference, Continued

Codes and descriptions,
continued

If Code is . . .	Then, transmitter option is . . .
1C	FM approval body certification for: <ul style="list-style-type: none"> • Explosionproof/Flameproof Class I, Division 1, Groups A, B, C, D • Dust Ignition Proof Class II, III, Division 1, Groups E, F, G • Non-Incendive Class I, Division 2, Groups A, B, C, D • Intrinsically Safe Class I, II, III, Division 1, Groups A, B, C, D, E, F, G
1S	FM approval body certification for: <ul style="list-style-type: none"> • Intrinsically Safe Class I, II, III, Division 1, Groups A, B, C, D, E, F, G
2J	CSA approval body certification for : <ul style="list-style-type: none"> • Explosionproof Class I, Division 1, Groups B, C, D • Dust Ignition Proof Class II, III, Division 1, Groups E, F, G • Non-Incendive Class I, Division 2, Groups A, B, C, D • Intrinsically Safe Class I, II, III, Division 1, Groups A, B, C, D, E, F, G
2S	CSA approval body certification for : <ul style="list-style-type: none"> • Intrinsically Safe Class I, II, III, Division 1, Groups A, B, C, D, E, F, G
3A	LCIE approval body certification for: <ul style="list-style-type: none"> • Flame Proof/ CENELEC EEx d IIC T6 • Intrinsically Safe/CENELEC EEx ia IIC T5
3D	LCIE approval body certification for: <ul style="list-style-type: none"> • Flame Proof/ CENELEC EEx d IIC T6
3N	Zone 2 (Europe) certification for: <ul style="list-style-type: none"> • Self-Declared per 94/4/EC (ATEX4) Ex II 3 GD T6 X $U_i \leq 42V \leq$ (Zone 2) $-40 \leq T_a \leq 93^\circ C$ IP66/67
3S	Approval body certification for: <ul style="list-style-type: none"> • Intrinsically Safe/CENELEC EEx ia IIC T5
4G or 4H	SA approval body certification for: <ul style="list-style-type: none"> • Intrinsically Safe Ex ia IIC T4 • Non-Incendive Ex n IIC T6 (T4 with Local Smart Meter option)
5A	VNIIVE approval body certification for: <ul style="list-style-type: none"> • Intrinsically Safe OEx ia IIC T6 X
9X	No certification

Appendix B – Freeze Protection of Transmitters

B.1 Possible Solutions/Methods

Problem

When water is present in the process fluid and ambient temperatures can fall below the freezing point (32°F/0°C), pressure transmitters and their piping require freeze protection. Transmitters may also require continuous heating, if the process fluid is tar, wax, or other medium which will solidify at normal ambient. However, uncontrolled steam or electric heating, in addition to wasting energy, can cause errors and accidentally destroy the transmitter.

Solution

These two basic solutions are possible:

- Eliminate the need for heating the transmitter by keeping the freezable process fluid out of direct contact with transmitter.
- Control the steam or electric heat to prevent overheating on warm days while protecting against freeze-ups under the coldest conditions.

The other paragraphs in this section review a number of methods for implementing both solutions.

Sealing liquid method

The simplest and least costly method is to use a sealing liquid in the transmitter meter body and its impulse piping to the process. The small contact (interface) area between the sealing liquid and the process fluid reduces the mixing of the two fluids.

You should select a sealing liquid that has a greater specific gravity than the process fluid to inhibit mixing. It also must have freezing and boiling temperatures compatible with the range of temperatures existing at the site, including the heated interface.

WARNING

WARNING — The user must verify the compatibility of any sealing liquid with their process fluid.

A reliable sealing liquid is a 50/50 percent (by volume) solution of ethylene-glycol and water. This solution has a specific gravity of 1.070 at 60°F (15°C), a freezing temperature of –34°F (–36°C), and a boiling temperature of +225°F (+106°C) at atmospheric pressure. Conventional antifreeze liquids for automobile coolant systems such as Prestone and

Continued on next page

B.1 Possible Solutions/Methods, Continued

Sealing liquid method, continued

Zerex are solutions of ethylene-glycol with some rust inhibitors and possibly leak sealants added; they may be used in place of pure ethylene-glycol.

Another sealing liquid, used in many chemical plants, is dibutylphalate an oily-type liquid with a specific gravity of 1.045 at 70°F (21°C). It has a boiling point 645°F (340°C) and does not freeze so it can be used down to about -20°F (-30°C).

Figures B-1 and B-2 show typical piping installations for this method. The process fluid must be heated above its freezing point. This is frequently done by lagging in (insulating) the connecting nipple, shut-off valve and "T" connector with the process piping. Where the process piping itself requires heating, a steam or electric trace is run around their components with consideration given to the boiling point of the sealing liquid.

Figure B-1 Piping Installation for Sealing Liquid With Specific Gravity Heavier Than Process Fluid.

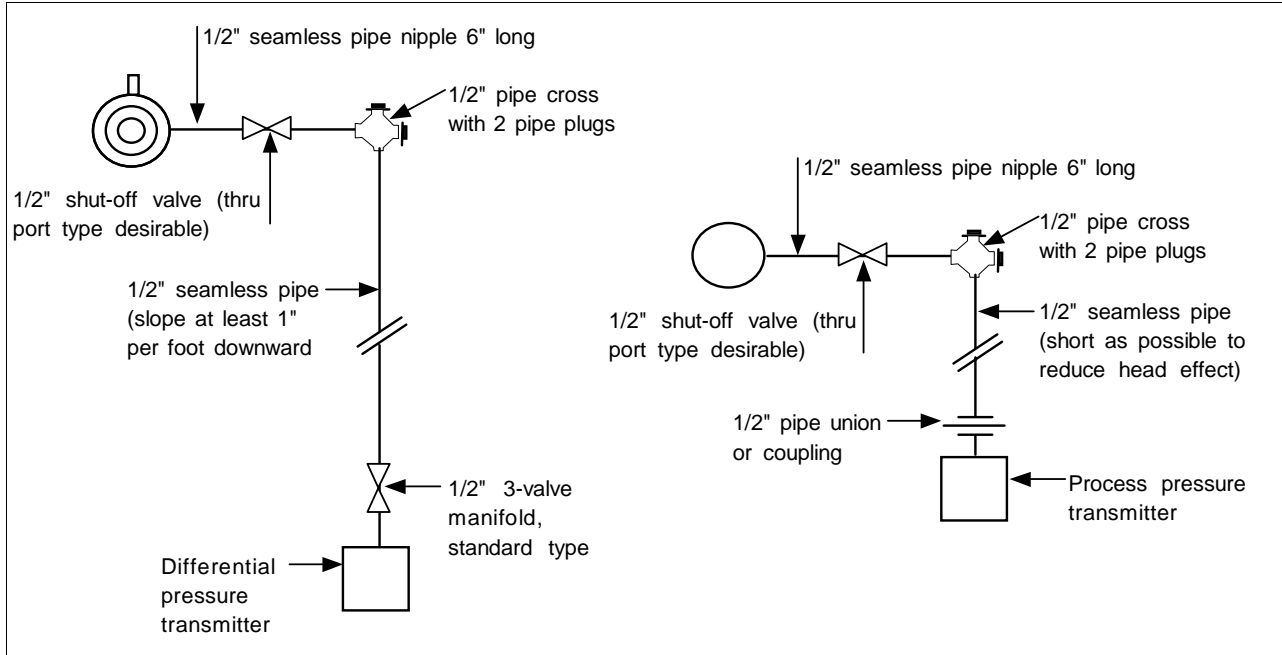

Continued on next page

B.1 Possible Solutions/Methods, Continued

Sealing liquid method, continued

Figure B-2 Piping Installation for Sealing Liquid with Specific Gravity Lighter Than Process Fluid.

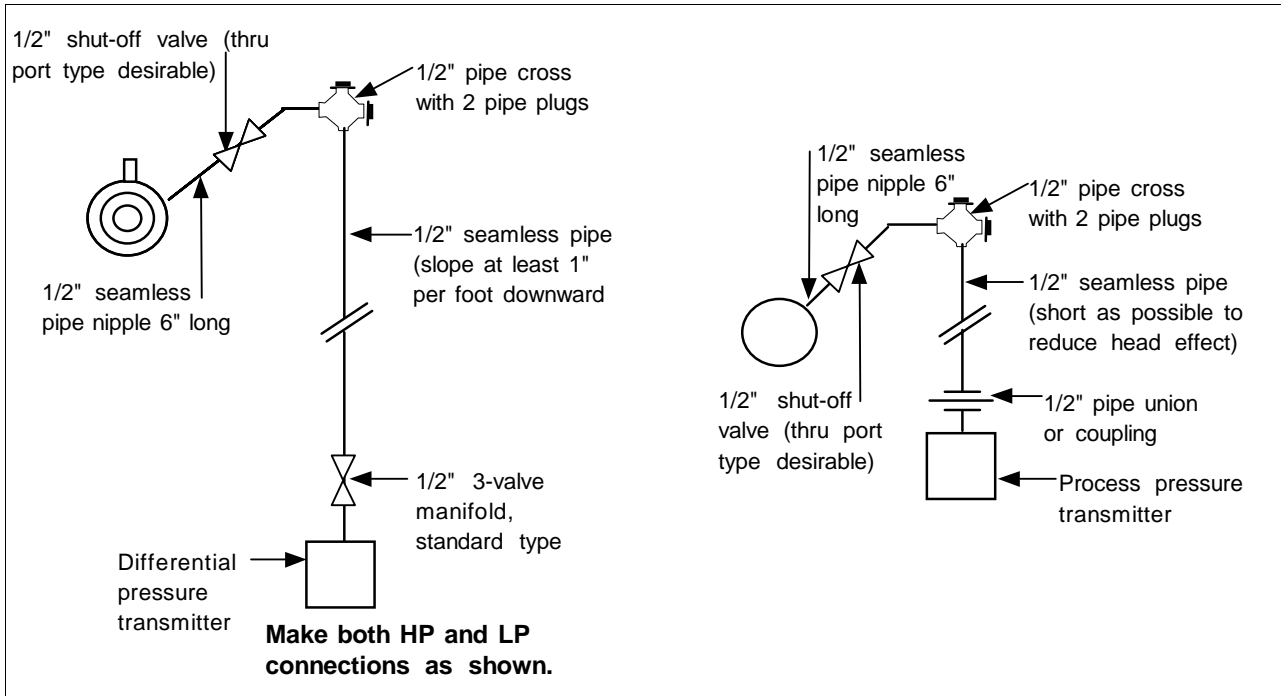

The installation should be checked every 6 to 12 months to verify that the sealing liquid is at its required specific gravity.

Purging

Purging air or water purges are commonly used to prevent viscous materials from clogging the impulse lines to pressure, level, or flow transmitters. The bubbler system, using a constant-air flow regulator, is particularly common on open tank liquid level applications. No heating of impulse lines or transmitter is required, but normal precautions are required to keep water out of the air supply system.

Gas applications

We must not overlook the possibility of condensate freezing in impulse lines to transmitters measuring gas flow or pressure. Although these components could be heated similar to water and steam applications, the simplest and best approach is to install transmitters so that they are self draining. This means that the impulse lines are connected to the lowest

Continued on next page

B.1 Possible Solutions/Methods, Continued

Gas applications, continued

point in the transmitter meter body and the piping is sloped downward at least one inch per foot. (Side-connected transmitters with vent-drains at a lower point in the meter body must be regularly checked to assure condensate removal.) If the transmitter is located below the process taps (not recommended), piping must still run downward from the transmitter to the drain point and then up to the process as shown in Figure B-3. Steam or electric heating of the drain point will prevent pipe rupture due to freezing.

Figure B-3 Piping Installation for Gas Flow.

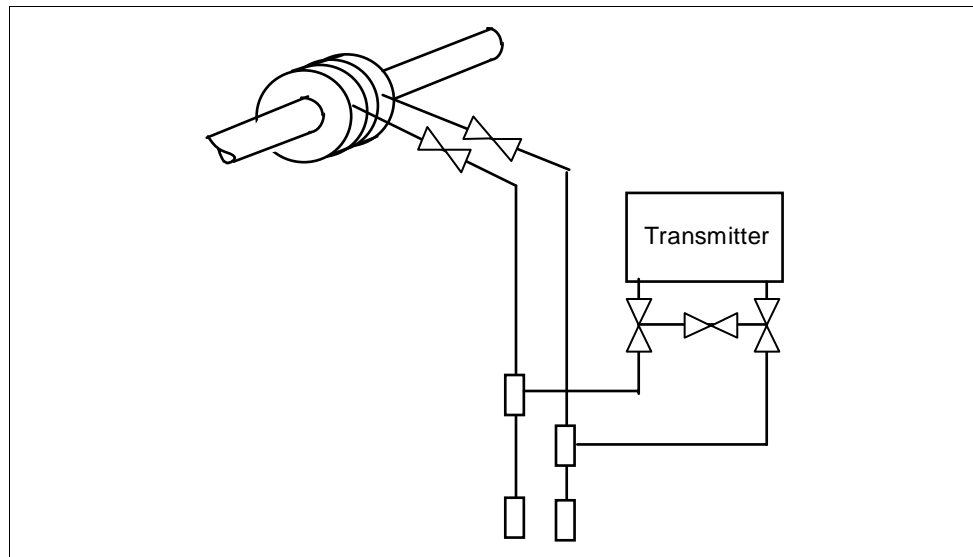

Mechanical (diaphragm) seals

Diaphragm seals on the impulse lines provide the most expensive, yet broadest application of all the methods. Similar in principle to the liquid seals, diaphragm seals eliminate the possibility of seal liquid carry-over into the process fluid. This eliminates the need for periodic maintenance checks to assure full and equal liquid seal legs. Welded diaphragm seals with special fills permit temperatures from -34° to 600°F (-36° to 315°C) at the process interface which can therefore be steam or electrically heated to assure viscosity of tars and similar high-freezing point fluids under the coldest conditions.

Continued on next page

B.1 Possible Solutions/Methods, Continued

Mechanical (diaphragm) seals, continued

You must be careful to specify large enough diaphragms to accommodate expansion and contraction of the fill fluid under varying temperatures without overextending the diaphragm into its stiff area. In general, conventional diaphragm seals are satisfactory for pressure ranges above approximately 75 psig with special large diameter elements required for low pressure or differential pressure measurements.

You can lag (insulate) impulse lines and diaphragm seals with the process piping, but this practice is only common with liquid level applications involving highly viscous materials unsuitable for 1/2-inch impulse lines. Use a tank-mounted flanged seal in such installations. Otherwise, it is more desirable to keep the capillary lengths short, the transmitter accessible for maintenance, and (for flow applications) the normal 3-valve manifold assembly close to the transmitter for normal service checks. Thus, the impulse lines, valving and diaphragm seals with 1/2-inch connections would be electrically or steam traced, with high temperature steam permitted without damage to the transmitter. See Figures B-4 and B-5 for typical piping layouts.

Figure B-4 Piping Installation for Differential Pressure Transmitter with Metal Diaphragm Seals.

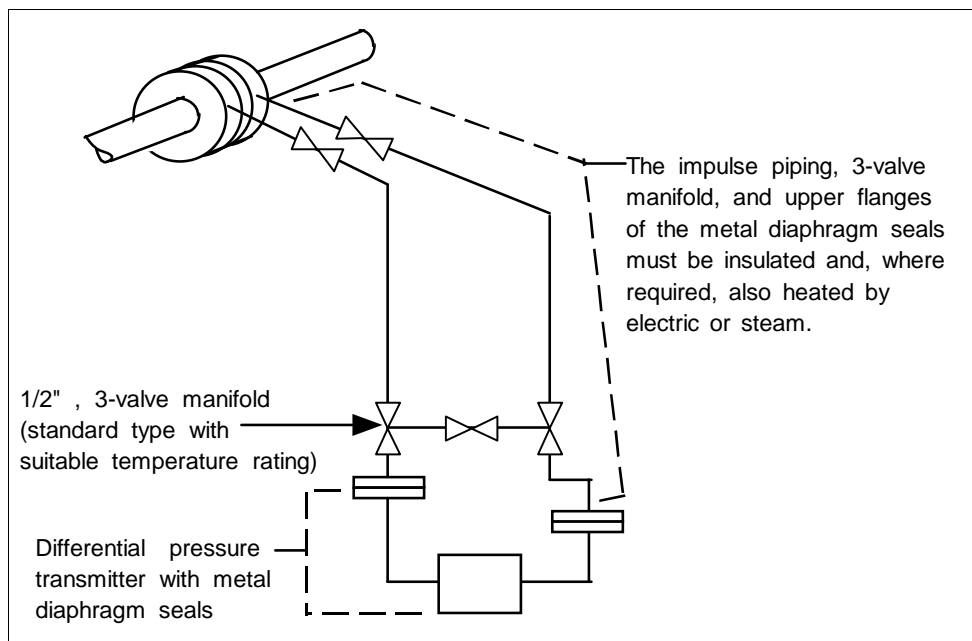

Continued on next page

B.1 Possible Solutions/Methods, Continued

Mechanical (diaphragm) seals, continued

Figure B-5 Piping Installation for Process Pressure Transmitter with Metal Diaphragm Seal.

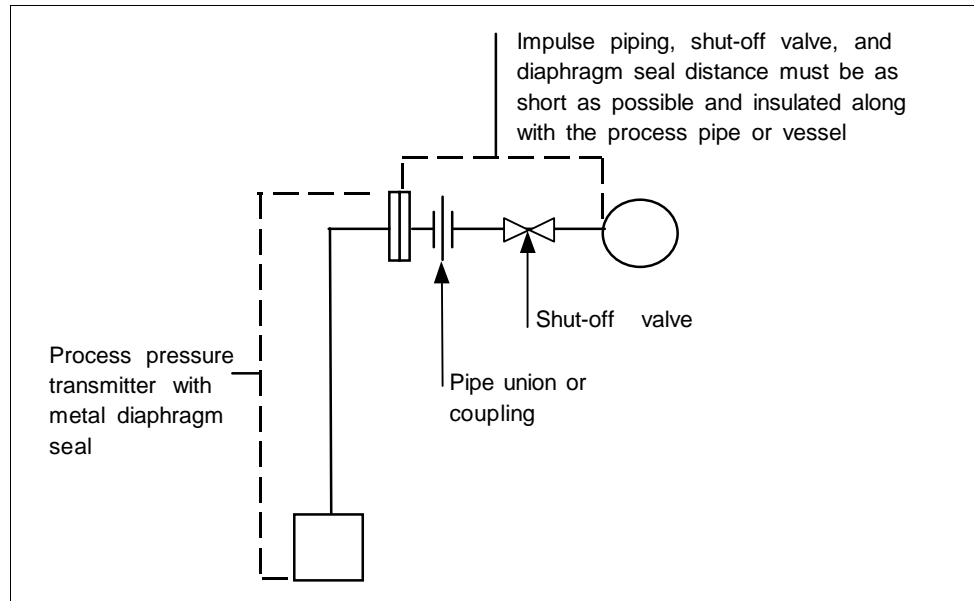

Electric heating

Most transmitters will withstand higher temperatures at their process interfaces (bodies) than at their electronics. Normally, it is impractical to heat transmitter bodies above 225 to 250°F (107 to 121°C) without radiant and conducted heat exceeding the rating at the electronics (normally 200°F/93°C). Prefabricated insulated enclosures with integral heating coils and thermostats set at 200°F (93°C) can assure viscosity of fluids which freeze below 180°F (82°C) while assuring safe transmitter operation. For water or similar lower-temperature mediums, the control can be set at 50°F (10°C) to save energy and call for heat only when temperature and wind conditions require.

Systems can be engineered for uncontrolled, continuous electric heating to prevent water freezing at 0°F (-18°C) and 20 mph wind velocity, while not exceeding 225°F (107°C) at the transmitter body at 90°F (32°C) ambient and zero wind velocity. The operating costs in energy for these systems usually exceed the high initial cost of the thermostat systems. Never attempt to maintain freeze points above 100°F (38°C) without thermostat controls since the Btu required to prevent freezing will normally exceed the body temperature rating under opposite extremes.

Continued on next page

B.1 Possible Solutions/Methods, Continued

Electric heating, continued

Although systems are available with hollow bolts replacing the normal transmitter body bolts and containing electrical heating elements and thermostats, certain precautions are required with such arrangements. Some transmitter meter body bolts are too small to accept the available thermostats. Also thermostat settings should not approach the body temperature limit because the heat gradient across the meter body can be such that limits are exceeded adjacent to the heating elements even when the thermostat setting is lower.

Electrical heating systems are available in explosionproof ratings for Class I, Group D, Division I and II installations.

The possibility of electric supply failure must be considered. For this reason, we recommend using alarm devices with manual acknowledgment and reset.

See Figures B-6 and B-7 for typical piping installations.

Figure B-6 Piping Installation for Differential Pressure Transmitter and Impulse Piping with Electric Heating and Control.

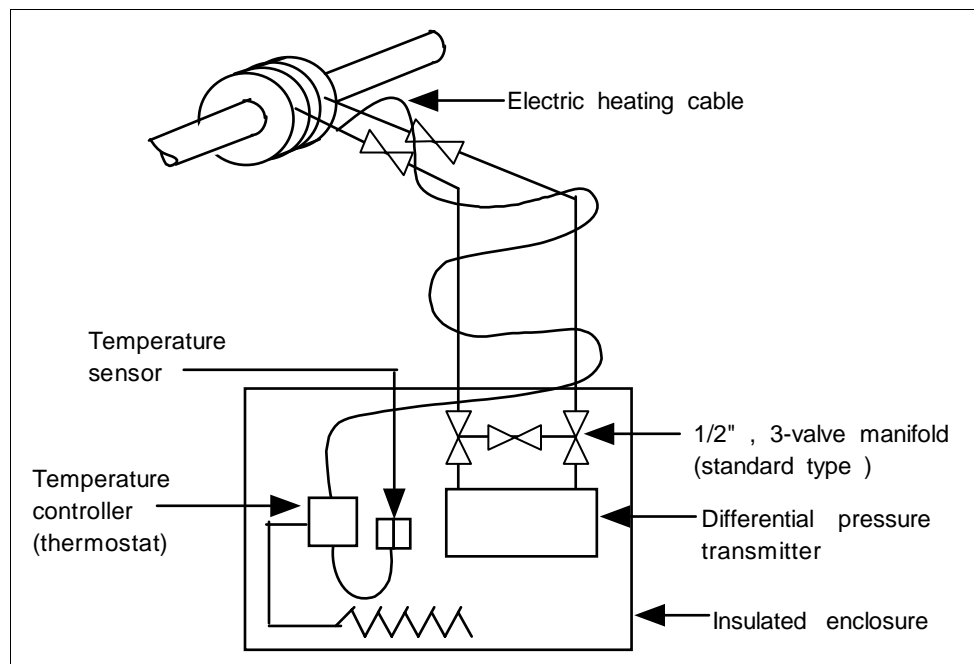

Continued on next page

B.1 Possible Solutions/Methods, Continued

Electric heating, continued

Figure B-7 Piping Installation for Process Pressure Transmitter and Impulse Piping with Electric Heating Control.

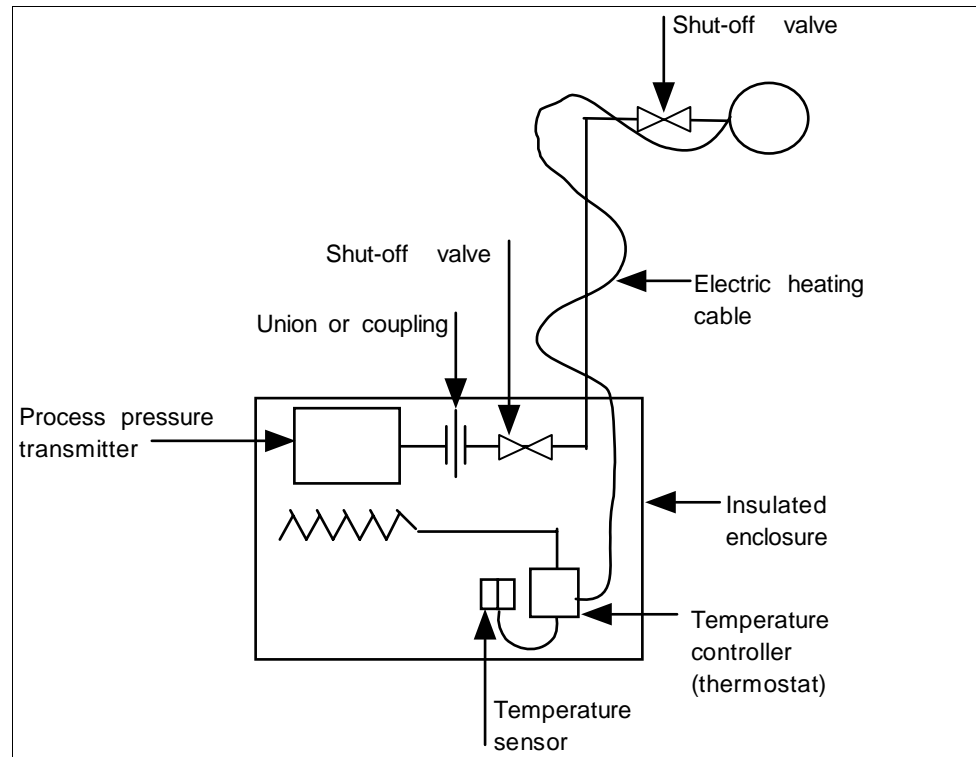

Steam heating

Steam heating is perhaps the most common, yet potentially the most damaging method of protecting transmitters from freeze-ups. Since steam is generated for use in the overall process operation, it is considered an available by-product. The most important point to remember when steam heating transmitter meter bodies is the temperature of the steam that will be used and its pressure. We recommend that you review the next paragraph Superheated steam considerations to get a better understanding of the temperature problem with steam heating. In brief, do not assume that 30 psig steam is 274°F (134°C) and cannot damage a transmitter rated for 250°F (121°C). With steam heating, as with electrical, you should use insulated transmitter body housing, impulse piping and valves.

Continued on next page

B.1 Possible Solutions/Methods, Continued

Steam heating, continued

It is common practice to use conventional steam traps on all steam heating systems. They permit live, superheated steam to enter the heating coils and piping down to the trap. You should also use conventional steam traps with lower pressure desuperheated steam which cannot overheat the transmitter under warm-day conditions. If the heating pipes are not carefully installed to eliminate low spots and trapped condensate in the piping, they could freeze at low temperatures.

All steam traps require a periodic maintenance program. Dirt, scale, and water softeners will cause traps to stick or jam which result in their either blowing steam continuously or not blowing steam, allowing condensate freeze-up in cold weather. When steam traps are used for cold-weather freeze protection of water lines, a thermostat controlled steam supply valve, which will shut off the steam at ambient temperatures higher than 50°F (10°C), will save steam and prevent overheating.

A more general solution is offered by a specialized type of trap which throttles condensate flow based on its temperature. This backs up hot water in the radiator within the insulated transmitter enclosure, assuring temperatures no higher than the saturated steam at the reduced pressure. Models are available to set the condensate temperature from about 70° to 200°F (21° to 93°C). They must be located within 6 to 12 inches (15 to 30 cm) of the transmitter body and, like all steam traps, they also require periodic maintenance. The engineering of this type system is more complex than electric systems since the amount of heat loss upstream of the CTV valve under varying conditions will determine the location of the steam/water interface. It could occur within the heater coil or further up the steam line, thus affecting the heating efficiency within the insulated enclosure. Therefore, steam control of materials which freeze or become too viscous above 100°F (38°C) should probably not be attempted without some experimenting with the specific piping layout used.

Uncontrolled steam heating, even with the best pressure regulation and desuperheating of steam, should not be used to maintain transmitter temperatures above 100°F (38°C), since this type of fixed Btu input must either over or under-heat under normal ambient swings.

As with electric heating, there are many types of commercial steam heating units available such as radiant heaters, hollow meter body studs or just tubing lagged to the impulse piping and transmitter body. The same precaution applies to the use of hollow studs as on the electrical versions.

Continued on next page

B.1 Possible Solutions/Methods, Continued

Steam heating,
continued

See Figure B-8 and B-9 for typical piping installations. Table B-1 summarizes the temperature ranges for the various freeze protection systems.

Table B-1 Temperature Range of Freeze Protection Systems

Operating Temperature Range		Liquid Seals		Diaphragm Seals	Steam Heating		Electric Heat	
		Ethylene Glycol	Dibutyl-Phthalate		No Seals		No Control	Thermo-stated
					Trap	CTV Valve		
°F	°C							
-34	-36	↑	↑	↑	↑	↑	↑	↑
-20	-30							
50	10	↓	↓	↓	↓	↓	↓	↓
100	38							
200	93	↓	↓	↓	↓	↓	↓	↓
225	106							
325	163	↓	↓	↓	↓	↓	↓	↓
600	315							

Note: Broken lines indicate areas of caution.

Continued on next page

B.1 Possible Solutions/Methods, Continued

Steam heating,
continued

Figure B-8 Piping Installation for Differential Pressure Transmitter and Impulse Piping with Steam Heating.

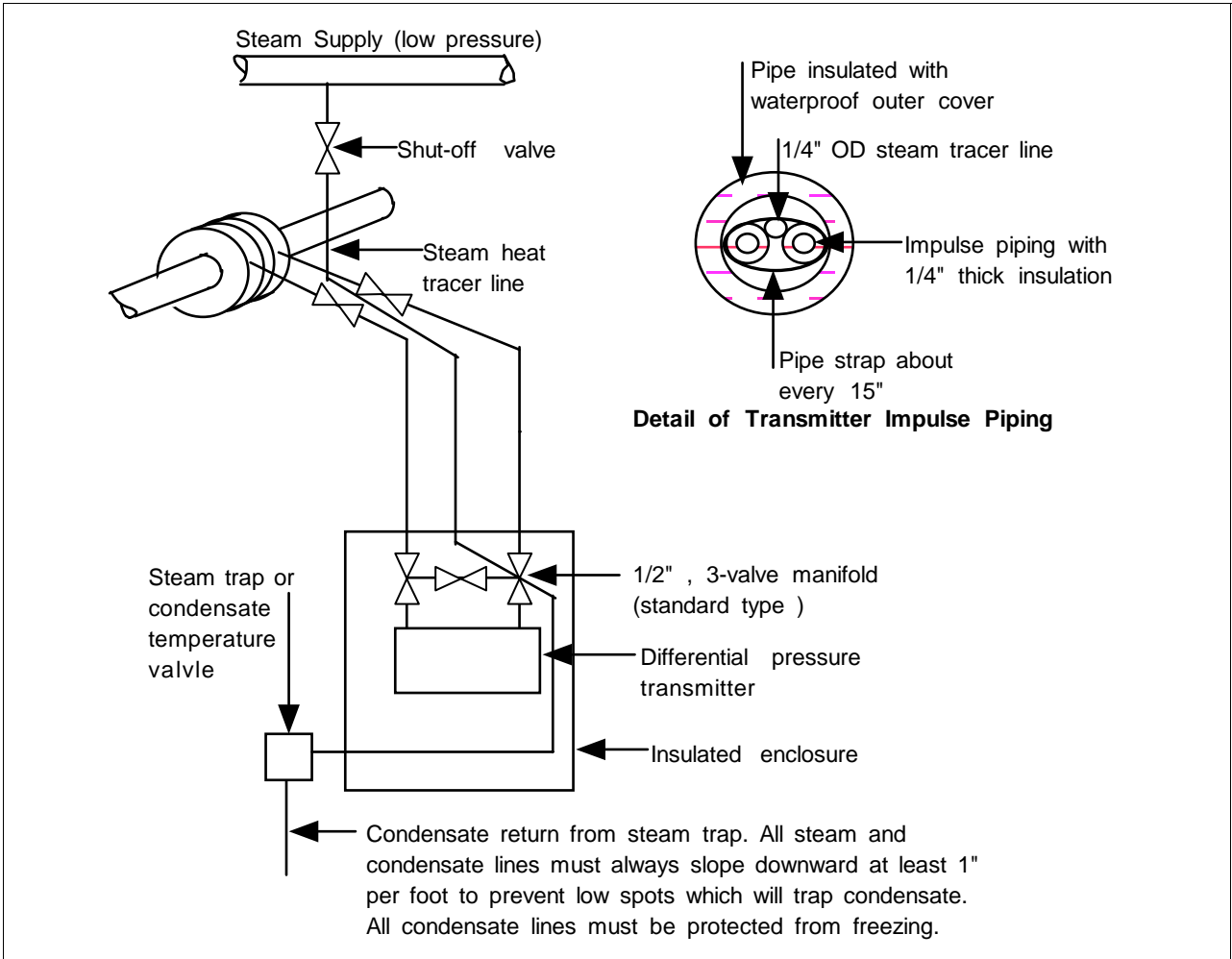

Continued on next page

B.1 Possible Solutions/Methods, Continued

Steam heating, continued

Figure B-9 Piping Installation for Process Pressure Transmitter and Impulse Piping with Steam Heating.

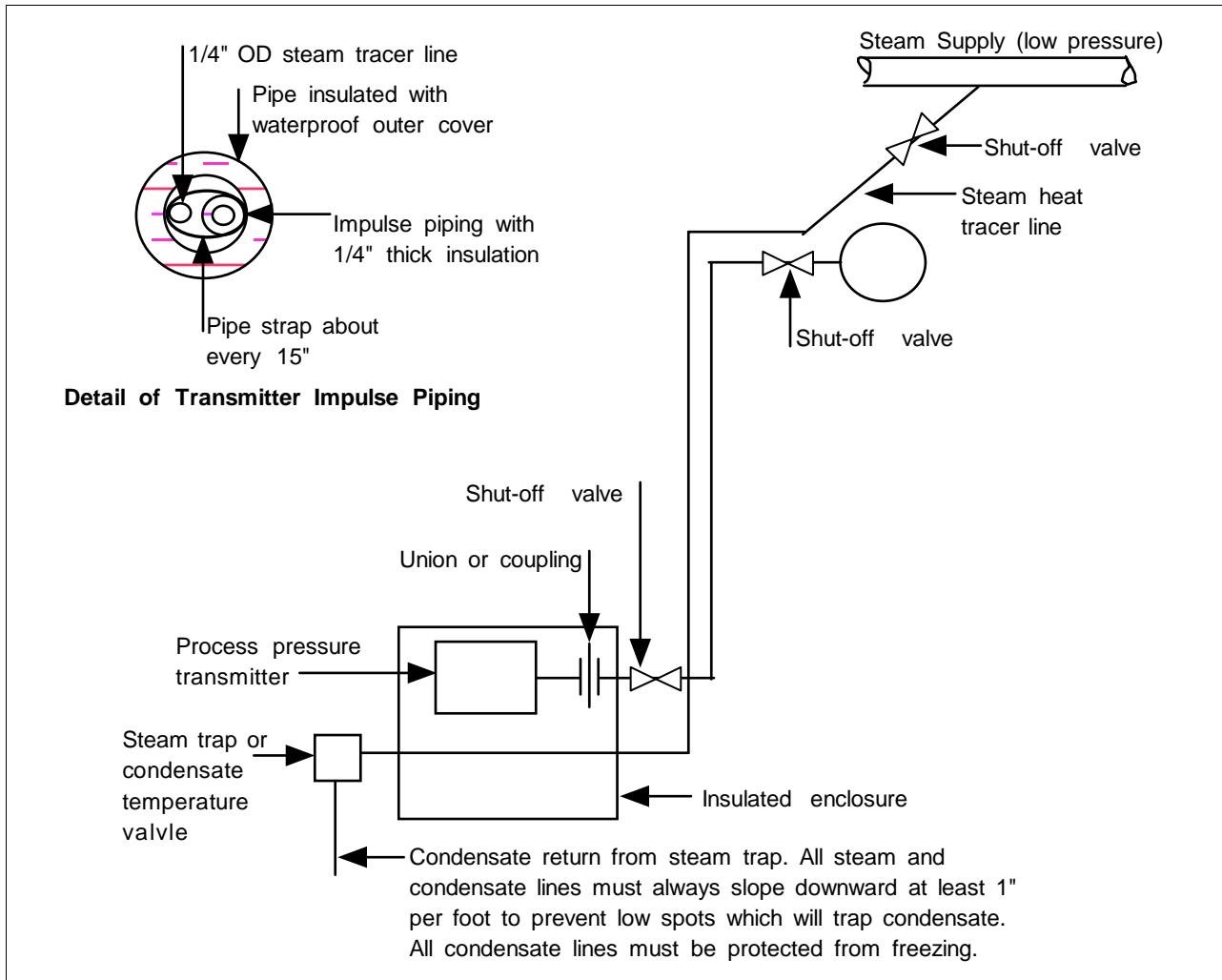

Superheated steam considerations

We must remember that the temperature of steam is 212°F (100°C) only at the normal atmospheric pressure of about 14.7 pounds per square inch absolute (psia). If the pressure of steam is increased above 14.7 psia, the temperature of the steam is also increased. For example, if we have steam at 30 pounds per square inch gage (psig), the steam temperature is 274°F (134°C).

Continued on next page

B.1 Possible Solutions/Methods, Continued

Superheated steam considerations, continued

On industrial flow and pressure measurement applications, we may be required to use steam to heat the impulse piping to the flow or pressure transmitter, as well as the transmitter itself. For these applications, we must verify the temperature of the heating steam used. As an example, assume that steam at 100 psig saturated (338°F/170°C) is to be reduced to 30 psig pressure for the heating system. Too frequently, it is assumed that this pressure reduction will result in steam at 274°F (134°C), the temperature of saturated steam at 30 psig. Wrong! A reduction of the steam pressure will not appreciably decrease the initial steam temperature.

In our example, we were talking about saturated steam in the main header from the boiler. But modern industrial boilers cannot afford to let waste heat go up the stack. After reaching the boiling point in the drum, the steam flows through a series of pipes in the second pass of the flue gas exit, extracting additional heat energy and being raised to a temperature higher than the saturation temperature at the same pressure. This is superheat and, depending on boiler design, it may amount to 50 to 300°F (10 to 149°C) above the saturated steam temperature. It also permits packing more heat energy in a given size pipe for transmission from the process. Thus, in the typical application, the problem of steam heating is compounded by the additional superheat in the main header.

Specifically, when steam is reduced in pressure, it retains about the same latent heat or the same Btu's/pound at the reduced pressure. Therefore, in our example, steam at 100 psig and 338°F (170°C) when reduced to 30 psig steam will have a temperature of 306°F (152°C) or a loss of only 32°F (18°C).

This steam temperature can only be reduced by using a desuperheater. This device mixes cold water with the superheated steam to reduce its temperature by removing Btu's per pound of water (steam). It is also possible to use temperature controlled steam traps, which actually allow the steam to condense to water and therefore reduce its temperature to a pre-set value.

Continued on next page

B.1 Possible Solutions/Methods, Continued

Superheated steam considerations, continued

Table B-2 lists the various values of steam pressure, saturated steam temperatures at these pressures, degrees of superheat added to the saturated steam and finally the actual temperature of each when it is reduced to 30 psig steam.

Table B-2 Steam Pressure Versus Steam Temperature Values

Pressure (1)	Saturated Temperature (2)		Superheat Added (3)		Final Steam Temperature (2) + (3)		Actual Temperature of Steam When Reduced From (1)* to 30 psig	
	psig	°F	°C	°F	°C	°F	°C	°F
50	298	147	None	None	298	147	290	143
100	338	170	100	55	438	225	420	215
150	366	185	120	66	486	251	460	234
200	387	198	150	83	537	281	500	260
400	448	231	200	111	648	342	600	316
600	489	254	250	139	739	393	660	349

*(1) equals pressure in column one with superheat added.

Appendix C – Configuration Record Sheet

ST 3000 Smart Transmitter Configuration Record Sheet

Model Number: _____

Series: 100 900

Type: DP GP AP RS FM

Range: _____

Mode of Operation: Analog DE

Tag Number: _____

Output Conformity: Linear Square Root

Damping Time (Seconds): 0.00 0.2 0.3 0.5 1.0 2.0 4.0
 8.0 16.0 32.0

Engineering Units : "H2O_39F PSI MPa bar KG/cm²
 mmH2O_4C mmHg_0C KPa mbar G/cm²
 inHg_32F mH2O_4C "H2O_68F ATM "H2O_60F

Lower Range Value: 4 mAdc = _____

Upper Range Value: 20 mAdc = _____

Output Signal Mode (DE Mode Only): Single Range Dual Range (STDC)
 Single Range W/SV

Message Format (DE Mode Only): W/O DB (4 Byte) W/DB (6 Byte)

Failsafe Mode STDC Card (DE Mode Only): F/S = B/O Lo F/S = FSO, B/O Lo
 F/S = B/O Hi F/S = FSO, B/O Hi
 F/S = LKG F/S = FSO, LKG

Failsafe Direction (Analog Mode): Upscale Downscale

Write Protect Option: Read and Write Read Only

Configured By: _____

Date: ____ / ____ / ____

Appendix D – Hazardous Locations Reference

Reference Information

Information is provided to clarify the hazardous location installation requirements in North America and internationally. An explanation of the applicable enclosure classification systems is also provided.

D.1 North American Classification of Hazardous Locations

Electrical Codes

Installation of electrical apparatus within hazardous (classified) locations of the United States is conducted under the provisions of the National Electrical Code (NEC), ANSI/NFPA 70, Article 500; and within Canada, under the provisions of the Canadian Electrical Code (CEC) C22.1, Part 1, Section 18.

Classes

Hazardous (classified) locations, in both the United States and Canada, are categorized into one of these three classes.

Class	Description of Hazardous Location
I	Presence of flammable gases or vapors may be present in quantities sufficient to produce explosive or ignitable mixtures.
II	Presence of combustible dusts, powders or grains.
III	Presence of easily ignitable fibers or flyings.

Divisions

The classes listed above are further categorized based upon the level of risk present.

Division	Description of Risk
1	Locations in which hazardous concentrations of flammable gases or vapors, or combustible dust in suspension are continuously, intermittently or periodically present under normal operating conditions.
2	Locations in which flammable gases or vapors are present, but normally confined within closed containers or systems from which they can escape only under abnormal or fault conditions. Combustible dusts are not normally in suspension nor likely to be thrown into suspension.

Continued on next page

D.1 North American Classification of Hazardous Locations, Continued

Examples

Given the criteria above, the following examples are made:

A **Class III, Division 1** location is a location in which easily ignitable fibers or material processing combustible flyings are handled, manufactured or used.

A **Class III, Division 2** location is a location in which easily ignitable fibers are stored or handled.

Groups

Flammable gases, vapors and ignitable dusts, fibers and flyings are classified into groups according to the energy required to ignite the most easily-ignitable mixture within air. Group classifications are as follows:

Class I Group	Description of Atmosphere
A	Atmospheres containing acetylene.
B	Atmospheres containing hydrogen, fuel and combustible process gases containing more than 30 percent hydrogen by volume, or gases or vapors of equivalent hazard.
C	Atmospheres such as ethyl ether, ethylene, or gasses or vapors of equivalent hazard.
D	Atmospheres such as acetone, ammonia, benzene, butane, cyclopropane, ethanol, gasoline, hexane, methanol, methane, natural gas, naphtha, propane or gases or vapors of equivalent hazard.
Class II Group	Description
E	Atmospheres containing combustible metal dusts including aluminum, magnesium, and their commercial alloys, and other metals of similarly hazardous characteristics.
F	Atmospheres containing combustible carbonaceous dusts including carbon black, charcoal, coal or other dusts that have been sensitized by other materials so that they present an explosion hazard.
G	Atmospheres containing combustible dusts not included in Group E or F, including flour wood, grain, and other dusts of similarly hazardous characteristics.

Continued on next page

D.1 North American Classification of Hazardous Locations, Continued

Methods of Protection The following table summarizes available methods of protection for use in given locations.

Protection Concept	Designation	Permitted Use	Principle
Explosionproof	XP	Division 1 & 2	Contains explosion and quenches flame.
Intrinsic Safety	IS	Division 1 & 2	Limit energy of sparks under normal and fault conditions.
Pressurized	Type X and Y	Division 1	Keeps flammable gas out.
Pressurized	Type Z	Division 2	Keeps flammable gas out.
Nonincendive	NI	Division 2	No arcs, sparks or hot surfaces under normal conditions

Temperature Classification

Equipment intended for installation directly within the hazardous (classified) location must also be classified for the maximum surface temperature that can be generated under normal or fault conditions as referenced to either 40°C (104°F) or the maximum operating ambient of the equipment (whichever is greater). The maximum surface temperature must be less than the minimum autoignition temperature of the hazardous atmosphere present. The temperature shall be indicated in identification numbers as listed in the following table.

Maximum Temperature		Temperature Identification Number
Degrees C	Degrees F	
450	842	T1
300	572	T2
280	536	T2A
260	500	T2B
230	446	T2C
215	419	T2D
200	392	T3
180	356	T3A
165	329	T3B
160	320	T3C
135	275	T4
120	248	T4A
100	212	T5
85	185	T6

D.1 North American Classification of Hazardous Locations, Continued

Intrinsically Safe Apparatus Parameters

The **Apparatus Parameters** are defined as follows.

Parameter	Description
V _{max}	Maximum safe voltage that can be applied to the apparatus terminals.
I _{max}	Maximum safe current that can be applied to the apparatus terminals.
C _i	Unprotected capacitance in the apparatus that can be considered present at the terminals.
L _i	Unprotected inductance in the apparatus that can be considered present at the terminals.

Associated Apparatus Parameters

The **Associated Apparatus Parameters** are defined as follows.

Parameter	Description
V _{oc}	Maximum output voltage that can be delivered to the hazardous (classified) location. This voltage is the maximum from a single channel.
I _{sc}	Maximum output current that can be delivered to the hazardous (classified) location. This current is the maximum from a single channel.
*V _t	Maximum output voltage that can be delivered to the hazardous (classified) location. This voltage is the maximum across any combination of terminals of a multiple channel configuration.
*I _t	Maximum output current that can be delivered to the hazardous (classified) location. This current is the maximum through any combination of terminals of a multiple channel configuration.
C _a	Maximum capacitance that can be connected to the apparatus.
L _a	Maximum inductance that can be connected to the apparatus.

*CSA does not recognize these parameters at this time.

Continued on next page

D.1 North American Classification of Hazardous Locations, Continued

Entity Concept

Under entity requirements, the concept allows interconnection of intrinsically safe apparatus to associated apparatus, not specifically examined in such combination. The criteria for interconnection is that the voltage (V_{max}) and current (I_{max}), which intrinsically safe apparatus can receive and remain intrinsically safe, considering faults, must be equal to or greater than the voltage (V_{oc} or V_t) and current (I_{sc} or I_t) levels which can be delivered by the associated apparatus, considering faults and applicable factors. In addition, the maximum unprotected capacitance (C_i) and inductance (L_i) of the intrinsically safe apparatus, including interconnecting wiring, must be less than or equal to the capacitance (C_a) and inductance (L_a) which can be safely connected to the associated apparatus. If these criteria are met, then the combination may be connected and remain intrinsically safe. Both FMRC and CSA define the entity parameters in Tables D-1 and D-2.

Table D-1 Factory Mutual (FM) Entity Parameters

Code	Description
1C	<p>Factory Mutual (FM) Approval</p> <ul style="list-style-type: none"> Explosionproof for Class I, Division 1, Groups A, B, C & D. Dust-Ignitionproof for Class II, Division 1, Groups E, F & G. Suitable for Class III, Division 1. Conduit seals required within 18" of enclosure, Group A only. Intrinsically Safe for use in Class I, Division 1, Groups A, B, C & D; Class II, Division 1, Groups E, F & G; Class III, Division 1, T4 at 40°C, T3A at 93°C maximum ambient, when connected in accordance with Honeywell drawing 51204241. Nonincendive for use in Class I, Division 2, Groups A, B, C & D; Suitable for Classes II & III, Division 2, Groups F & G, T4 at 93°C maximum ambient, hazardous locations. 42 Vdc max. Environmental: Indoor & outdoor hazardous locations (NEMA 4X).

Intrinsic Safety Entity Parameters ⁽¹⁾	Class I, II, III, Divisions 1 and 2, Groups A - G
$V_{Max} \leq 42.4 \text{ V}$	
$I_{Max} = 225 \text{ mA}$	
$P_{Max} = 1.2 \text{ W}$	
$C_i = 4.2 \text{ nF}$	
$L_i = 0$	With no integral indicator, or with integral Smart Meter, option SM.
$L_i = 150 \mu\text{H}$	With Analog Meter, option ME.

(1) Install in accordance with Honeywell drawing 51204241.

D.1 North American Classification of Hazardous Locations, Continued

Table D-2 CSA Entity Parameters

Code	Description
2j	<p>Canadian Standards Association (CSA)</p> <ul style="list-style-type: none"> • Explosion Proof for Class I, Division 1, Groups B, C & D. Dust-Ignition-Proof for Class II, Division 1, Groups E, F & G; Class III, Division 1. Conduit seals not required. 42 Vdc max. • Intrinsically Safe for Class I, Groups A, B, C & D; Class II, Groups E, F & G; Class III, Divisions 1, T4 at 40°C, T3A at 93°C maximum ambient. Install per Honeywell drawing 51204242. • Suitable for Class I, II & III, Division 2, Groups A, B, C, D, E, F & G hazardous locations, T4 at 93°C. 42 Vdc max. • Environmental: Indoor and outdoor hazardous locations (Encl 4X).

CSA Certified Barriers ⁽¹⁾	Class I, II, III, Division 1 and 2, Groups
28V / 200 Ω	A - G
20V / 150 Ω	C - G

(1) Install in accordance with Honeywell drawing 51204242.

D.2 International Electrotechnical Commission (IEC) Classification of Hazardous Locations

About IEC

The IEC has established a number of recommendations applying to the construction of explosion protected electrical apparatus identified. These recommendations are found within IEC 79-0 through 79-15 and 79-28.

For all EC countries as well as various neighboring countries (CENELEC member states), the European Standards EN 50 014 to EN 50 020 and EN 50 039 apply for the construction of explosion protected electrical apparatus. They were established on the basis of the IEC. However these recommendations are much more detailed by comparison.

Zones

Within IEC7-10, hazardous locations are categorized into one of these three zones.

ZONE	Description of Hazardous Location
0	Explosive gas atmosphere is present continuously, or is present for long periods.
1	Explosive gas atmosphere is likely to occur in normal operation.
2	Explosive gas atmosphere is not likely to occur in normal operation and, if it does occur, it will exist for a short period only.

IEC Groups

Flammable gases, vapors and mists are further classified into groups according to the energy required to ignite the most easily-ignitable mixture within air. Apparatus is grouped according to the atmospheres it may be used within as follows:

Group	Description of Atmosphere
IIC	Atmospheres containing acetylene, hydrogen, fuel and combustible process gases or vapors of equivalent hazard.
IIB	Atmospheres such as ethyl ether, ethylene, or gasses or vapors of equivalent hazard.
IIA	Atmospheres such as acetone, benzene, butane, cyclopropane, ethanol, gasoline, hexane, methanol, methane, natural gas, naphtha, propane or gases or vapors of equivalent hazard.

Continued on next page

D.2 International Electrotechnical Commission (IEC) Classification of Hazardous Locations, Continued

IEC Methods of Protection

The following table summarizes available methods of protection for use in given locations.

Protection Concept	Designation	Permitted Use	Principle
Flameproof	d	Zone 1 & 2	Contains explosion and quenches flame.
Intrinsic Safety	ia	Zone 0, 1 & 2	Limits energy of sparks under 2 faults.
Intrinsic Safety	ib	Zone 1 & 2	Limits energy of sparks under 1 fault
Pressurized	p	Zone 1	Keeps flammable gases out.
Encapsulation	m	Zone 1 & 2	Keeps flammable gases out.
Increased Safety	e	Zone 1 & 2	No arcs, sparks or hot surface.
Powder Filled	q	Zone 1 & 2	Contains explosion and quenches flame.
Oil Immersion	o	Zone 1 & 2	Keeps flammable gases out.
Non-sparking	nA	Zone 2	No arcs, sparks or hot surfaces under normal conditions.
Enclosed Break	nC	Zone 2	Contains explosion and quenches flame.
Limited Energy	nA	Zone 2	Limits energy of sparks and surface temperature under normal conditions.
Restricted Breathing	nR	Zone 2	Keeps flammable gases out.

Continued on next page

D.2 International Electrotechnical Commission (IEC) Classification of Hazardous Locations, Continued

IEC Temperature Classification

Equipment intended for installation directly within the hazardous location must also be classified for the maximum surface temperature that can be generated under normal or fault conditions as referenced to the maximum operating ambient of the equipment. The maximum surface temperature must be less than the minimum autoignition temperature of the hazardous atmosphere present. The temperature shall be indicated in identification numbers as listed in the following table.

Maximum Temperature		Temperature Identification Number
Degrees C	Degrees F	
450	842	T1
300	572	T2
200	392	T3
135	275	T4
100	212	T5
85	185	T6

Certification and Conformity Details

Table D-3 CENELEC / LCIE Certification

Code	Description
3D	Flameproof, Supply ≤ 45 Vdc, IP 66/67EEx d IIC T6.
3A	Intrinsically Safe EEx ia IIC T5, $-40 \leq T_a \leq 93^\circ\text{C}$. Flameproof, Supply ≤ 45 Vdc, IP 66/67 EEx d IIC T6.

LCIE Intrinsic Safety Parameters ⁽¹⁾	
$U_i = 30$ V	
$I_i = 100$ mA	
$P_i = 1.2$ W	
$C_i = 4.2$ nF	
$R_i = 0$	
$L_i = 0$	With no integral indicator, or with integral Smart Meter, option SM.
$L_i = 150$ μH	With Analog Meter, option ME.

(1) Install in accordance with Honeywell drawing 51204243.

D.2 International Electrotechnical Commission (IEC) Classification of Hazardous Locations, Continued

Certification and
Conformity Details,
continued

Table D-4 Standards Australia (LOSC) Certification

Code	Description
4H	Intrinsically Safe Ex ia IIC T4 Class I Zone 0. Flameproof Ex d IIC T6 Class I Zone 1 Non-Sparking Apparatus - Type of Protection 'n' Ex n IIC T6 Class I Zone 2

LOSC Intrinsic Safety Parameters ⁽¹⁾	
$U_i = 42.4 \text{ V}$	
$I_i = 225 \text{ mA}$	
$P_i = 1.2 \text{ W}$	
$C_i = 4.2 \text{ nF}$	
$L_i = 0$	With no integral indicator, or with integral Smart Meter, option SM.
$L_i = 150 \mu\text{H}$	With Analog Meter, option ME.

(1) Install in accordance with Honeywell drawing 51204309.

Table D-5 Zone 2 (Europe) Declaration of Conformity

Code	Description
3N	Electrical Apparatus With Type of Protection "n" per IEC 79-15. IP 66/67. Ex II 3 GD T ⁽¹⁾ X (Council Directive 94/9/EC) $-40 \leq T_a \leq 93^\circ\text{C}$.

Zone 2 Parameters	
$U_i \leq 42 \text{ V}$	
$I_i \leq 22 \text{ mA}$	
Temp. Code ⁽¹⁾ T4 at $T_a 93^\circ\text{C}$ Maximum Ambient	
Temp. Code ⁽¹⁾ T5 at $T_a 80^\circ\text{C}$ Maximum Ambient	
Temp. Code ⁽¹⁾ T6 at $T_a 65^\circ\text{C}$ Maximum Ambient	

Continued on next page

D.3 Enclosure Ratings

NEMA and IEC Recognition

The NEMA (National Electrical Manufacturer's Association) enclosure classifications are recognized in the US. The IEC Publication 529 Classifications are recognized throughout Europe and those parts of the world that use the IEC standards as a basis for product certifications. The following paragraphs provide a discussion of the Comparison Between NEMA Enclosure Type Numbers and IEC Enclosure Classification Designations.

IEC Classifications

IEC Publication 529, *Classification of Degrees of Protection Provided by Enclosures*, provides a system for specifying the enclosures of electrical equipment on the basis of the degree of protection provided by the enclosure. IEC 529 does not specify degrees of protection against mechanical damage of equipment, risk of explosion, or conditions such as moisture (produced for example by condensation), corrosive vapors, fungus, or vermin.

NEMA Standards

NEMA Standards Publication 250, *Enclosures for Electrical Equipment (1000 Volts Maximum)*, does test for environmental conditions such as corrosion, rust, icing, oil, and coolants. For this reason, and because the tests and evaluations for other characteristics are not identical, the IEC enclosure classification designations cannot be exactly equated with NEMA enclosure type numbers.

IEC Designations

Basically, the IEC designation consists of the letters IP followed by two numerals. The first characteristic numeral indicates the degree of protection provided by the enclosure with respect to persons and solid foreign objects entering the enclosure. The second characteristic numeral indicates the degree of protection provided by the enclosure with respect to the harmful ingress of water.

Continued on next page

D.3 Enclosure Ratings, Continued

IEC Designations,
continued

Table D-6 provides an approximate conversion from NEMA enclosure type numbers to IEC enclosure classification designations. The NEMA types meet or exceed the test requirements for the associated IEC classifications; **for this reason the Table cannot be used to convert from IEC classifications to NEMA types.**

Table D-6 NEMA Enclosure Type Numbers and Comparable IEC Enclosure Classification

NEMA Enclosure Type Number	IEC Enclosure Classification Designation
1	IP 10
2	IP 11
3	IP 54
3R	IP 14
3S	IP 54
4 and 4X	IP 56
5	IP 52
6 and 6P	IP 67
12 and 12K	IP 52
13	IP 54

NOTE: This comparison is based on tests specified in IEC Publication 529

Process Sealing

Process Sealing for Classes I, II, and III, Divisions 1 and 2 and Class I, Zone 0, 1, and 2, Explosionproof Electrical Systems

ST 3000, Smart Pressure Transmitters

The ST 3000, Series 100, 100e, 600, and 900, Smart Pressure Transmitters are CSA certified as “Dual Seal” devices in accordance with ANSI/ISA–12.27.01–2003, Requirements for Process Sealing between Electrical Systems and Flammable or Combustible Process Fluids.

Accordingly, the ST 3000, Series 100, 100e, 600, and 900, Smart Pressure Transmitters comply with the sealing requirements of NEC Chapter 5. Special Occupancies, Article 500 — Hazardous (Classified) Locations, Classes I, II, and III, Divisions 1 and 2, Article 501 — Class I Locations, Article 501-15, Sealing and Drainage, (f) Drainage, (3) Canned Pumps, Process or Service Connections, Etc., Article 505 — Class I, Zone 0, 1, and 2 Locations, Article 505-16, Sealing and Drainage, (E) Drainage, (3) Canned Pumps, Process, or Service Connections, and So Forth., and the Canadian Electrical Code rules 18-

092, 18-108, 18-158, J18-108 and J18-158.

Annunciation of a primary seal failure per ANSI/ISA-12.27.01 is electronic and is displayed in various forms based on the type of communication used for the particular transmitter. Failure of the primary seal is considered a Critical Failure. Based on testing annunciation of primary seal failure will occur in 7 hours or less. The transmitter's 4-20 mA output will be driven to the selected failsafe direction – upscale or downscale.

The transmitter's digital output (DE, HART, Fieldbus) will display any of the following responses which could indicate a primary seal failure as well as other meter body faults.

METER BODY FAULT, MB OVERLOAD, SUSPECT INPUT, SENSOR FAILURE, DEVICE FAILURE.

Index

A

Analog and DE Modes, 56
Analog meter connections, 48
Analog Mode, 2

B

Barrier Diaphragms
 Cleaning and Inspecting, 171
Battery Pack
 Installing and Charging, 22
Bracket
 Mounting Transmitter, 27

C

Calibration
 Calibrating Analog Output Signal, 185
 Calibrating Range with SFC, 189
 Equipment Required, 184
 Resetting, 192
 Typical Equipment Connections, 191
Communications
 Starting, 52
Configuration Database, 61
Configuration Decisions
 Summary, 67
Configuration Parameters, 64

D

Damping, 64
Damping Time
 Adjusting, 77
 Keystroke Summary, 78
DE Mode, 3
DE protocol format, 2
Diagnostic Messages, 196
 Communication Errors, 200
 Critical Failures, 200
 Interpreting, 203
 Interrupt Messages, 201
 Invalid Key Entry, 201
 Non-Critical Failures, 199
Diaphragm Seals, 240
Display and Keyboard Test
 Running, 207

Dropout
 Square Root, 76

E

Electric Heating, 242
EMC Directive, 18
Enclosure ratings, 264
Engineering Units
 Selecting, 79
Engineering Units High and Low, 66
Environmental Conditions, 19

F

Failsafe Direction
 Changing, 156
Flange Adapter
 Installing, 42
Flange Connections
 Description, 41
Flange mounted transmitter, 35
 Mounting, 35
Flow Measurement (DP)
 Starting Up, 129
Flush Mounted Transmitter
 Mounting, 34
Freeze Protection, 237

H

Hazardous locations reference
 IEC Classifications, 259
 North American Classifications, 253
Hold Memory
 SFC, 62

L

Lightning Protection, 46
Linear Output
 Selecting, 74
Liquid Level Measurement (DP with Remote Seals)
 Starting Up, 148
Liquid Level Measurement (DP)
 Starting Up Pressurized Tank, 137
 Starting Up Vented Tank, 134
Local Smart Meter
 Set Up Summary (Using Meter Pushbuttons), 121

Local Smart Meter

- Keystroke Summary (Using SFC), 103
- Meter/Transmitter Interaction, 168
- Options, 13
- Output Conformity, 105
- Pushbuttons**, 104
- Reference Specifications, 24
- Set Up Using Meter Pushbuttons, 104
- Set Up Using SFC, 97
- Setting display of LRV (using meter pushbuttons), 110

Local Smart Meter Display

- Description, 164
- Error Codes, 167
- Typical Indications, 165

Local Zero and Span

- Adjusting (Procedure), 85

Loop wiring, 48

LRV (Lower Range Value), 64

LRV and URV

- Keying in Values, 81
- Keystroke Summary (Applied Pressures), 84
- Keystroke Summary (Keying in Values), 82
- Setting to Applied Pressures, 83

M

Maintenance

- Routine, 170

Memories

- Non-volatile, 62
- SFC and ST 3000, 62

Message Format

- (DE Only) Selecting \i, 95
- DE Mode Only, 65
- Keystroke Summary, 96

Meter Body

- Replacing, 178

Meter Engineering Units, 66

Mode and Software

- Checking, 55

Mode of Operation

- Changing, 58
- Keystroke Summary, 59

Model Number

- Format, 4

Mounting Area

- Considerations, 19

Mounting Location

- Suggested, 39

Mounting Precautions

- Model STD110, 32
- Models STA122 and STA922, 30

N

Non-volatile Memory

- Copying data into non-volatile memory, 63
- ST 3000, 62

Number Symbol “#”

- Clearing, 197

O

Operation Data

- Accessing, 153

Output Conformity, 64

- Keystroke Summary, 75
- Selecting, 74
- Smart Meter setup, 98

Output Mode

- Running Analog Output Check, 126

Output Signal Indication

- DE Mode Only, 65

Output Signal Mode

- (DE Only) Selecting, 92
- Keystroke Summary, 94
- Ranges, 92

P

Parameters

- Configuration, 64

Piping, 38

Potential Noise Sources, 19

Power Supply Voltage

- Operating Range, 43

Pressure Measurement (AP)

- Starting Up, 146

Pressure Measurement (DP)

- Starting Up, 132

Pressure or Liquid Level Measurement (GP)

- Starting Up, 141, 145

Pressure Ratings, 21

Process Connections

- Summary, 40

Process Sealing, 47, 264

PWA

- Replacing, 175

R

Remote Diaphragm Seal Transmitter

- Mounting, 36

Replacement parts, 209

S

Save and Restore Database, *160*
 Procedure, *161*
Scratch Pad Area
 Writing Data, *158*
Sealing Liquid, *237*
SFC
 Connecting to Transmitter, *51*
 Disconnecting, *123*
 Display Characteristics, *71*
 Model Designations, *9*
 Purpose, *8*
SM 3000 Smart Meter connections, *48*
Smart Meter. *See* Local Smart Meter
Smartline Configuration Toolkit, *1*
Solution Support Center, *xiii*
Square Root Output, *75*
 Dropout, *76*
 Selecting, *74*
ST 3000 Smart Transmitter, *2*
Startup Procedure
 Reference, *125*
Start-Up Tasks
 Reference, *16*
Status Check
 Running, *202*
Steam Heating, *244*
Superheated Steam, *249*

T

Tag Number, *64*
 Entering (Procedure), *72*

 Keystroke Summary, *73*
Temperature Limits
 Operating, *20*
Transmitter mounting
 Models STA122, STA922, *30*
Transmitter options
 Options, *233*
Transmitter Types, *5*
Tthree-Valve Manifold
 Piping, *38*
Turndown Ratio, *77*

U

Unit of Measurement, *64*
URV (Upper Range Value), *64*

V

Vibration Sources, *19*

W

Wiring Connections, *45*
Write Protect Jumper
 Location and Selections, *56*

Z

Zero and Span Adjust
 Options, *13*
Zero corrects, *32*
Zero shift, *30*

Honeywell

Honeywell Process Solutions

512 Virginia Drive

Fort Washington, PA 19034

Free Manuals Download Website

<http://myh66.com>

<http://usermanuals.us>

<http://www.somanuals.com>

<http://www.4manuals.cc>

<http://www.manual-lib.com>

<http://www.404manual.com>

<http://www.luxmanual.com>

<http://aubethermostatmanual.com>

Golf course search by state

<http://golfingnear.com>

Email search by domain

<http://emailbydomain.com>

Auto manuals search

<http://auto.somanuals.com>

TV manuals search

<http://tv.somanuals.com>