

S8610U Universal Intermittent Pilot Gas Ignition Control

SUPER TRADELINE®

INSTALLATION INSTRUCTIONS

APPLICATION

The SUPER TRADELINE® S8610U Universal Intermittent Pilot Gas Ignition Control Module is designed to provide easy field replacement of a wide range of intermittent pilot ignition modules manufactured by Honeywell, Robertshaw, Johnson Controls, and others. The S8610U control provides ignition sequence, flame monitoring, and safety shutoff for intermittent pilot central furnaces, residential boilers, and other heating appliances. The S8610U replaces existing flame rectification type, intermittent pilot ignition modules with the following characteristics:

- Single rod (local sense) or two rod (remote sense) flame sensing
- Non-100 percent shutoff, 100 percent shutoff/lockout, or 100 percent shutoff/continuous retry
- Natural or LP gas
- Shutoff/lockout times of 15 seconds or longer
- Prepurge configurable to 30 seconds or no prepurge
- Pilot burners with flow rates of 1,500 Btuh or less
- With or without integral damper connector

Table 1 describes the key features of the S8610U control.

⚠ WARNING

Check Table 2 on page 2 before replacing an existing intermittent pilot control with the S8610U. If the existing control is not listed, do not use the S8610U to replace it unless you are certain the specifications match those of the existing control.

A complete list of the specific Honeywell and other modules that the SUPER TRADELINE® S8610U is designed to replace is provided in Table 2 on page 2.

The SUPER TRADELINE® S8610U package contains complete, easy-to-use instructions, plus the accessories required to adapt the existing spark cable (Rajah, stud, nail, or other) to the spark terminal on the control module. It also help assure proper marking of the wires attached to the existing control and a label with LED code information that can be affixed in the appliance.

IMPORTANT

The S8610U control module is **not** designed to replace controls with:

- Flame sensing other than by flame rectification (White Rodgers Cycle-Pilot®, or Robertshaw thermal sensing)
- Standing pilot appliances
- Direct main burner ignition

The S8610U provides:

- Natural or LP gas
- Pilot burner ignition using an internally generated high voltage spark
- Flame rectification circuit to monitor flame presence
- Monitoring of 24 Vac, pilot, and main gas valve
- LED indicator for flame presence/strength and system status/errors
- Vent Damper connection
- Connections for flame reading via standard microammeter.

The S8610U is designed for a wide variety of natural or liquid propane fueled applications.

Table 1. S8610U Universal Intermittent Pilot Gas Ignition Control.

Igniter-Sensor Type	Valve Current Rating @ 24 Vac	Prepurge Timing	Trial for Pilot Ignition	Ignition Sequence Type	Ignition Sequence (After prepurge, if prepurge is selected)	Integral Damper Connector
Separate (two rod; remote flame sensing) or Combination (one rod; local flame sensing)	1.0 A Pilot and 2.0 A Main	None or 30 seconds (field selectable)	15 or 90 seconds (field selectable)	Retry	Spark and pilot gas ON until lightoff or trial for ignition ends. <ul style="list-style-type: none"> • If established flame is lost, trial for ignition restarts immediately. • If pilot fails to light, pilot gas and spark Off (100% shutoff). After 5 minute delay, a new trial for ignition is initiated. This sequence continues until lightoff or "Call for Heat" is removed. 	Included for use as needed. <ul style="list-style-type: none"> • If initially installed and powered up with damper attached, unit must always have a vent damper connected.



Automatic Ignition Systems
ANSI Z21.20



S8610U UNIVERSAL INTERMITTENT PILOT GAS IGNITION CONTROL

For module replacement, the following table indicates the proper Dip Switch settings for Prepurge timing (SW1) and Trial For Ignition timing (SW2). See "Settings and Adjustments" on page 15 for Dip Switch information.

Table 2. S8610U Replaces These Modules

Vendor / Model	SW1	SW2
Honeywell		
S86A1001 S86A1019 S86A1027 S86A1035 S86B1009 S86B1017 S86B1025 S86C1007 S86C1015	OFF	OFF
S86C1023	OFF	ON
S86C1031 S86C1049 S86C1056 S86D1005	OFF	OFF
S86D1013	OFF	ON
S86D1021 S86E1002 S86E1010 S86E1028 S86E1036 S86E1044 S86E1051 S86E1069 S86E1077 S86E1101 S86E1119 S86E1127 S86F1000 S86F1018 S86F1026 S86F1042 S86F1059 S86F1067 S86F1075 S86F1083 S86F1091 S86G1008 S86G1016	OFF	OFF
S86G1024	OFF	ON
S86G1032 S86G1057 S86G1073 S86H1006	OFF	OFF
S86H1014	OFF	ON
S86H1022 S86H1048 S86H1055	OFF	OFF
S86H1063	OFF	ON
S86H1089 S86H1097 S86H1105	OFF	OFF
S86H1113	OFF	ON
S86H1121	OFF	OFF
S86H1139	OFF	ON
S86H1147 S90A1005 S90B1003 S90B1011	OFF	OFF
S860C1000 S860D1009	ON	OFF
S860D1017	ON	ON
S860A1001 S8600B1009	OFF	OFF
S8600B1025 S8600B3005	OFF	ON
S8600B3013 S8600C1015 S8600C3003 S8600F1000 S8600F1034 S8600F1042 S8600H1006	OFF	OFF
S8600H1014	OFF	ON

Table 2. S8610U Replaces These Modules (Continued)

Vendor / Model	SW1	SW2
S8600H1022 S8600H1048 S8600H1055	OFF	OFF
S8600H1063	OFF	ON
S8600H1071 S8600H1089 S8600H1097 S8600H1105 S8600H3002	OFF	OFF
S8600H3010	OFF	ON
S8600M1005 S8600M1013 S8600M1021 S8600M2003 S8600M3001 S8600M4009 S8610A1009 S8610B1007 S8610B1015	OFF	OFF
S8610B1023 S8610B3003	OFF	ON
S8610C1005 S8610C1013 S8610C3001 S8610F1008 S8610F1016 S8610F1024 S8610F1032	OFF	OFF
S8610H1004	OFF	ON
S8610H1012	OFF	OFF
S8610H1020	OFF	ON
S8610H1038 S8610H1046 S8610H1053	OFF	OFF
S8610H1061	OFF	ON
S8610H1079 S8610H1095 S8610H3000	OFF	OFF
S8610H3018	OFF	ON
S8610H3026 S8610M1003	OFF	OFF
S8610M1011	OFF	ON
S8610M1029 S8610M3009	OFF	OFF
S8610M3017	OFF	ON
S8610U1003 S8610U1011	OFF	OFF
S8620C1003 S8620C1011	OFF	ON
S8620H1002	OFF	OFF
S8620H1010	OFF	ON
S8620H1028	OFF	OFF
S8660D1002	ON	OFF
S8660D1010	ON	ON
S8660J1008 S8660J1016 S8660J1024 S8660K1006 S8660K1014 S8660K1022 S8670D1000 S8670D1018	ON	OFF
S8670D1026 S8670D3006	ON	ON
S8670D3014 S8670E1007 S8670E3003	ON	OFF
S8670J3002	ON	ON

Table 2. S8610U Replaces These Modules (Continued)

Vendor / Model	SW1	SW2
S8670J3010 S8670K3000	ON	OFF
S8680J1004	ON	ON
Johnson Controls		
CSA35A-617R CSA35A-618R CSA42A-600R CSA42A-601R CSA42A-602R CSA42A-603R CSA42A-604R CSA43A-600R CSA44A-600R CSA45A-601R CSA45A-602R CSA46A-600R CSA48A-600R CSA49A-600R CSA49A-605R CSA51A-601R CSA52A-600R	OFF	OFF
G60AAA-1 G60AAG-1 G60AAG-2 G60AAG-3 G60AAG-4 G60AAG-5 G60AAG-6 G60AAG-7 G60CAA-1 G60CAA-3 G60CAG-1 G60CAG-2 G60CAG-3 G60CAG-4 G60CAG-5 G60CAG-6 G60CAG-7 G60CAG-8 G60CAG-9 G60CBA-1 G60CBA-2 G60CBA-3 G60CBG-1 G60CBG-2 G60CBG-3 G60CBG-4 G60CBG-5 G60CBG-6 G60CBG-7 G60CBG-8 G60CBG-9 G60CBG-10 G60CBG-11 G60CBG-12 G60CBG-13 G60CBG-14 G60CBG-15 G60CBG-16 G60CBG-17 G60CA-1 G60CCG-1 G60CPG-1 G60DBG-1 G60DCG-1 G60DCG-2 G60DCG-3 G60DCG-4 G60PAG-1 G60PAG-2 G60PAG-3 G60PAG-4 G60PAG-5 G60PAG-6 G60PAJ-1 G60PAK-1 G60PAK-2 G60PFH-1 G60PFH-2 G60PFL-1 G60PFQ-1 G60PVL-1 G60QAG-1 G60QAG-2 G60QAG-3	OFF	OFF

Table 2. S8610U Replaces These Modules (Continued)

Vendor / Model	SW1	SW2
G60QAG-4 G60QAK-1 G60QBG-1 G60QBG-2 G60QBG-3 G60QBG-4 G60QBG-5 G60QBG-6 G60QBG-7 G60QBG-8 G60QBG-9 G60QBH-1 G60QBK-1 G60QBK-2 G60QBK-3 G60QBL-1 G60QBL-2 G60QCG-1 G60QCJ-1 G60QCL-1 G60QDG-1 G60QFL-1 G60QGH-1 G60QHL-1 G60QHL-2 G60QJL-1 G60QLG-1 G60QLK-1 G60QPL-1 G60QRH-1 G60QRH-2 G60QRH-3 G60QRL-1 G60QRL-2 G60QRL-3 G60QSL-1 G60QTH-1 G60QTL-1 G60RAG-1 G60RAK-1 G60RBG-1 G60RBG-2 G60RBG-3 G60RBK-1 G60RBK-2 G60RCG-1 G60RCG-2 G60RCJ-1 G60RDG-1 G60RDK-1 G60RGL-1 G60RHL-1 G60RHP-1 G60RPL-1 G60RSL-1 G60TTL-1 G60ZAG-1 G60ZAG-2	OFF	OFF
G65BBG-1 G65BBG-2 G65BBG-3 G65BBG-4 G65BBG-5 G65BBG-6 G65BBG-7 G65BBG-8 G65BBM-1 G65BBM-2 G65BBM-3 G65BBM-4 G65BCG-1 G65BCM-1 G65BFG-1 G65BFM G65BK-1 G65BK-2 G65BK-3 G65BKM-1 G65BKM-2 G65BKM-3 G65BLG-1 G65BLG-2 G65DBG G65DBM-1 G65DBM-2 G65DBM-3 G65DCM-1 G65DFG G65DFM-1 G65DKG G65DKM G65DKM-1 G65DLM-1 G65FBG G65FFG G65FKG	OFF	OFF

Table 2. S8610U Replaces These Modules (Continued)

Vendor / Model	SW1	SW2
G66AG-1 G66AG-2 G66BG-1 G66MG-1 G66MG-2 G66NG-1	OFF	OFF
G67AG-3 G67AG-4 G67AG-7 G67AG-8 G67AG-9 G67AG-10 G67AG-11 G67BG-2 G67BG-3 G67BG-4 G67BG-5 G67MG-1 G67MG-2 G67MG-3 G67MG-4 G67NG-2 G67NG-4	OFF	OFF
G600AX-1 G600AX-2 G600AX-3 G600AY-1 G600LX-1 G600LX-2 G600LY-1 G600MX-1 G600NX-1 G600RX-1	OFF	OFF
G670AW-1 G670AW-2 G670GA-1	OFF	OFF
G770LGA-1 G770LGA-2 G770LGC-1 G770LGC-2 G770LGC-3 G770LGC-4 G770LHA-1 G770LHA-2 G770LHC-1 G770MGA-1 G770MGA-2 G770MGA-3 G770MGC-1 G770MGC-2 G770MGC-3 G770MGC-4 G770MGC-5 G770MGC-6 G770MHA-1 G770MHA-2 G770MHC-1 G770NGA-1 G770NGC-4 G770NGC-5 G770NGC-6 G770NGC-7 G770NHA-1 G770NHC-1 G770RGA-1 G770RHA-1 G770RHA-2	OFF	OFF
G775RGA-1 G775RHA-1 G775RHA-2	OFF	OFF
G779	OFF	OFF
Y79ABC-1 Y79ABC-2 Y79ABC-3 Y79ABC-4 Y79ABC-5 Y79ABC-6 Y79ABC-7 Y79ABD-1 Y79ABCD-2 Y79BBA-1 Y79BBA-2	OFF	OFF

Table 2. S8610U Replaces These Modules (Continued)

Vendor / Model	SW1	SW2
RobertShaw		
780-001 780-002	OFF	OFF
780-003	ON	OFF
780-845 780-715 780-735 780-736 780-737	OFF	OFF
SP715 SP715A SP735 SP735D SP735L	OFF	OFF
USI715U	OFF	OFF
White-Rodgers		
50D49-350 50D49-360	OFF	OFF
50D49-361	ON	OFF
50D49-401	OFF	OFF
Camstat		
IPI-24-00	OFF	OFF
Fenwal		
05-203025-005 05-203026-005	OFF	OFF
HSC		
1003-3 1003-300	OFF	OFF

SPECIFICATIONS

Control Voltage:

Line 24 V (18-30 Vac) 50/60 Hz

Anticipator Setting:

0.1 A plus valve load @ 24 Vac

Trial for Ignition:

See Table 1 on page 1

Prepurge: See Table 1 on page 1

Flame Failure Response Time:

2 seconds maximum

LED:

The green Status LED provides system status, error codes, and flame strength when in run mode.

Typical Gas Control: Honeywell models VR8204 and VR8304

Operating Temperature:

Minimum ambient temperature rating is -40°F (-40°C)
Maximum ambient rating when used with 2.0 A main valve is 165°F (74°C)

Relative Humidity:

0% to 95% non condensing

PLANNING THE INSTALLATION

WARNING

Fire or Explosion Hazard.
Can cause severe injury, death or property damage.

1. Plan the installation as outlined below.
2. Plan for frequent maintenance as described in the Maintenance section.

Intermittent pilot systems are used on a wide variety of central heating equipment and on heating appliances such as commercial cookers, agricultural equipment, industrial heating equipment and pool heaters. Some of these applications may make heavy demands on the controls, either because of frequent cycling, or because of moisture, corrosive chemicals, dust or excessive heat in the environment. In these situations, special steps may be required to prevent nuisance shutdowns and premature control module failure. These applications require special Honeywell review; contact your Honeywell Sales Representative for assistance.

Review the following conditions that can apply to your specific installation and take the precautionary steps suggested.

Frequent Cycling

These controls are designed for use on appliances that typically cycle three to four times an hour only during the heating season. In year-round applications with greater cycling rates, the control module can wear out more quickly; perform a monthly checkout.

Water or Steam Cleaning

If the control module gets wet, replace it. If the appliance is likely to be cleaned with water or steam, protect (cover) the controls and wiring from water or steam flow. Mount the controls high enough above the bottom of the cabinet so they do not get wet during normal cleaning procedures. Use a NEMA 4 enclosure for the ignition control module.

High Humidity or Dripping Water

Dripping water can cause the control module to fail. Never install an appliance where water can drip on the controls.

In addition, high ambient humidity can cause the gas control to corrode and fail.

If the appliance is in a humid atmosphere, make sure air circulation around the controls is adequate to prevent condensation. Also, regularly check out the system. A NEMA 4 enclosure is recommended for the ignition control module.

Corrosive Chemicals

Corrosive chemicals can attack the ignition control module and gas control, eventually causing a failure. If chemicals are used for routine cleaning, make sure they do not reach the controls. Where chemicals are

suspended in air, as in some industrial or agricultural applications, use a NEMA 4 enclosure for the ignition control module.

Dust or Grease Accumulation

Heavy accumulations of dust or grease can cause controls to malfunction. Where dust or grease can be a problem, provide covers for the ignition control module and the gas control to limit contamination. A NEMA 4 enclosure is recommended for the ignition control module.

Heat

Excessively high temperatures can damage controls. Make sure the maximum ambient temperature at the control module does not exceed the rating of the control module. If the appliance operates at very high temperatures, use insulation, shielding, and air circulation, as necessary, to protect the controls. Proper insulation or shielding should be provided by the appliance manufacturer; verify proper air circulation is maintained when the appliance is installed.

INSTALLATION

When Installing This Product...

1. Read these instructions carefully. Failure to follow them could damage the product or cause a hazardous condition.
2. Check the ratings given in these instructions to make sure the S8610U module is suitable for your application.
3. Installer must be a trained, experienced service technician.
4. After installation is complete, check out operation as provided in these instructions.

WARNING

Fire or Explosion Hazard.
Can cause severe injury, death or property damage.

1. The ignition control module can malfunction if it gets wet, leading to accumulation of explosive gas.
 - Never install where water can flood, drip or condense on the ignition control module.
 - Never try to use an ignition control module that has been wet; replace it.
2. Liquefied petroleum (LP) gas is heavier than air and will not naturally vent upward.
 - Do not operate electric switches, lights, or appliances until you are sure the appliance area is free of gas.

WARNING

Electrical Shock Hazard.
Can cause severe injury, death or property damage.

Disconnect power supply before beginning wiring or making wiring connections to prevent electrical shock or equipment damage.

CAUTION

1. If a new gas control is to be installed, turn off the gas supply before starting installation. Conduct a Gas Leak Test according to the gas control manufacturer instructions after the gas control is installed.
2. Wiring errors can cause improper appliance operation and dangerous conditions such as bypassing safety features.

CAUTION

Equipment Damage Hazard.
Water can cause equipment damage or malfunction.

If ignition control module must be mounted where there is the potential for exposure to water or moisture, provide a suitable waterproof enclosure.

Maintenance Requirements in Severe Environments

Regular preventive maintenance is important in any application, but especially so in commercial cooking, agricultural, and industrial applications because:

- In many such applications, particularly commercial cooking, the equipment operates 100,000-200,000 cycles per year. Such heavy cycling can wear out the gas control in one to two years. A normal forced air furnace, for which the controls were originally intended, typically operates less than 20,000 cycles per year.
- Exposure to water, dirt, chemicals, and heat can damage the ignition control module or the gas control and shut down the control system. A NEMA 4 enclosure can reduce exposure to environmental contaminants.

The maintenance program should include regular checkout of the system as outlined under "Checkout" on page 15.

WARNING

Fire or Explosion Hazard.
Can cause severe injury, death or property damage.

Do not attempt to take the ignition control module apart or to clean it. Improper reassembly and cleaning may cause unreliable operation.

Maintenance frequency must be determined individually for each application. Some considerations are:

- Cycling frequency – Appliances that may cycle more than 20,000 times annually should be checked monthly.
- Intermittent use – Appliances that are used seasonally should be checked before shutdown and again before the next use.
- Consequence of unexpected shutdown – Where the cost of an unexpected shutdown would be high, the system should be checked more often.
- Dusty, wet, or corrosive environment – Since these environments can cause the controls to deteriorate more rapidly, the system should be checked more often.

Any ignition control module should be replaced if it does not perform properly on checkout or troubleshooting. In addition, replace any ignition control module if it is wet or looks like it has ever been wet. Protective enclosures as outlined under "Planning the Installation" are recommended regardless of checkout frequency.

Perform Pre-Installation Safety Check

The pre-installation checks described below must be done before the replacement ignition control module is installed. If a condition that could result in unsafe operation is detected, the appliance should be shut off and the owner advised of the unsafe condition. Correct any potentially unsafe condition before proceeding with the installation.

The following safety checklist should be followed in making the safety inspection:

1. Conduct a Gas Leakage Test of the appliance piping and control system downstream of the shutoff valve in the supply line to the appliance.
2. Visually inspect the venting system for proper size and horizontal pitch and determine there is no blockage or restrictions, leakage or corrosion or other deficiencies that could cause an unsafe condition.
3. Shut off all gas to the appliance and shut off any other fuel-burning appliance within the same room. Use the shutoff valve in the supply line to each appliance.
4. Inspect burners and crossovers for blockage and corrosion.
5. Applicable only to warm air heating appliances. Inspect heat exchangers for cracks, openings or excessive corrosion.
6. Applicable only to boilers. Inspect for evidence of water or combustion product leaks.
7. Insofar as is practical, close all building doors and windows and all doors between the space in which the appliance is located and other spaces of the building. Turn on clothes dryers. Turn on any exhaust fans, such as range hoods and bathroom exhausts, so they will operate at maximum speed. Do not operate a summer exhaust fan. Close fireplace dampers.
If, after completing steps 7 through 12 in this safety checklist, it is believed sufficient combustion air is not available, refer to section 1.3.4 of the National Fuel Gas Code (Z223.1) for guidance.
8. Place in operation the appliance being inspected. Follow the lighting instructions. Adjust thermostat so appliance will operate continuously.
 - a. Determine that the pilot is burning properly and that main burner ignition is satisfactory by interrupting and reestablishing the electrical supply to the appliance in any convenient manner.
 - b. Determine manifold pressure in order to match input after the new control is installed.
 - c. Visually determine that main burner gas is burning properly; i.e., no floating, lifting or flashback. Adjust the primary air shutter(s) as required.
 - d. If appliance is equipped with high and low flame control or flame modulation, check for proper main burner operation at low flame.
9. Test for spillage at the draft hood relief opening after five minutes of main burner operation. Use a draft gauge, the flame of a match or candle, or smoke from a cigarette, cigar or pipe.

10. Return doors, windows, exhaust fans, fireplace dampers and all other fuel-burning appliances to their previous conditions of use.
11. Applicable only to warm air heating appliances. Check both limit controller and fan controller for proper operation. Limit controller operation can be checked by temporarily disconnecting the electrical supply to the blower motor and determining that the limit control acts to shut off the main burner gas.
12. Applicable only to boilers:
 - a. Determine that the circulating water pumps are in operating condition.
 - b. Test low water cutoffs, automatic feed controls, pressure and temperature limit controls and relief valves in accordance with the manufacturer's recommendations and instructions to determine they are in operating condition.

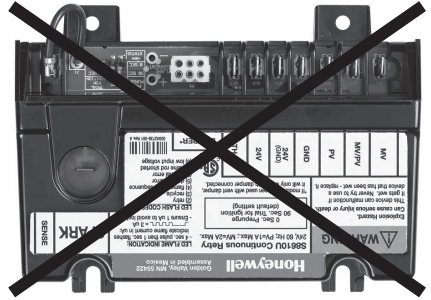

M29889

Remove Old Ignition Control Module

Disconnect power supply before doing any work on the unit. Disconnect and tag the wires from the old module. Remove the old module from its mounting location.

Mount New Ignition Control Module

The recommended mounting for the S8610U ignition control module is the same location as the old control module. Otherwise, select a location close enough to the burner to allow a short (3 ft. [0.9 m] maximum), direct cable route to the pilot burner. Ambient temperature at the control module must be within the range listed in the "Specifications" on page 3.

Mount the ignition control module with the terminals down to protect them from dripping water and dust. The control module can also be mounted with the terminals on either side. Do not mount with the terminals pointing up. Fig. 1 on page 6 illustrates the incorrect mounting position. When it is necessary to drill new mounting holes, use the S8610U as a template to mark the mounting hole pattern. Drill new holes, as required. Fasten securely with four — No. 6-32 machine screws, or No. 8 sheet metal screws, or 8-18 x 5/8 Pan Head tapping screws.

Location

The mounting location must provide:

- Good, clear access to the field wiring terminals.
- Operating ambient temperatures between -40°F (-40°C) and 165°F (74°C).
- Relative humidity below 95% non condensing.
- Protection from water, steam or corrosive chemicals that are used to clean the appliance.
- Protection from dripping water, such as from an overfilled humidifier or from condensation.
- Protection from dust or grease accumulation.

IMPORTANT

Do not mount with terminals facing up.

Fig. 1. Incorrect Mounting.

Wire the System



CAUTION

Equipment Damage Hazard.

Disconnect power supply before beginning wiring or making wiring connections to prevent electrical shock or equipment damage.

All wiring must comply with local codes and ordinances. Refer to Fig. 2 and Table 9 on page 11 for typical connections.

IMPORTANT

1. As shown in the wiring diagrams, a common ground is required on:

The pilot burner mounting bracket, **and** the GND (BURNER) terminal on the ignition control module. Failure to use the GND (BURNER) terminal may result in intermittent loss of spark and/or loss of flame current sensitivity.
2. Make sure the transformer has adequate VA.

The ignition control module requires at least 0.1 A at 24 Vac. Add the current draws of all other devices in the control circuit, including the pilot and main valves in the gas control, and multiply by 24 to determine the total VA requirement of these components. Add this total to 2.4 VA (for the ignition control module). The result is the minimum transformer VA rating. Use a Class II transformer if replacement is required.

Connect Vent Damper (Optional)

If the ignition control module is to be used with a damper connected to the module's integral damper connector in an atmospheric appliance, perform the following to connect it to the module:

IMPORTANT

*After the initial power-up, the ignition control module senses the presence of the vent damper connection. If the vent damper is connected for 10 ignition cycles, the ignition control module permanently configures itself to operate **only** with the damper connected.*

Once an ignition control module completes 10 ignition cycles with a vent damper connected, the module will not function without a vent damper being connected.

- Using the wiring harness on the appliance, insert the matching 6-pin plug into the connector (labeled P1; see Fig. 2 on page 11) on the S8610U ignition control module and connect the other end to the vent damper.

NOTE: The connector (P1) accepts a Molex 03-06-2061 plug.

Connect Ignition Cable

Use existing ignition cable if it is in good condition. If the existing ignition cable does not have a 1/4 in. quick connect on the module end, either use the Rajah adapter or strip the wire and replace with the 1/4 in. insulated quick connect supplied. If the cable must be replaced, order a Honeywell ignition cable (Table 3) or refer to Table 4. It might be necessary to replace the connector at the pilot burner end to match the pilot burner spark termination.

NOTE: When using an S8610U to replace an S86, use the enclosed adapter to convert the S86 Ignition Cable to an S8610U Ignition Cable. Then, install the adapter and cable to the S8610U Ignition Module.

Table 3. Honeywell Pre-assembled Ignition Cables (UL Style 3257).

CABLE PART NUMBER	LENGTH	MODULE END	PILOT BURNER
394800-30	30 inches	1/4 inch quick connect, insulated	Rajah connector receptacle, 90 degree rubber boot
394801-30	30 inches	1/4 inch quick connect, insulated	Rajah connector receptacle, straight rubber boot

Table 4. Recommended Ignition Cable for Field Assembly.

CABLE TYPE	VOLTAGERATING (rms)	TEMPERATURE RATING
UL Style 3217	10,000	302°F (150°C)
UL Style 3257	10,000	484°F (250°C)

Cable must be no longer than 36 in. (0.9 m). Solid conductor cable recommended. To construct a cable, fit one end of ignition cable with 1/4 in. diameter Rajah connector receptacle and the other with a 1/4 in. female quick connect. Protect both ends with insulated boots.

NOTE: The cable must not run in continuous contact with a metal surface or spark voltage may be greatly reduced. Use ceramic or plastic standoff insulators as required. Resistive spark cable reduces spark voltage and may impact appliance performance.

To install:

- Connect one end of the cable to the male quick connect SPARK terminal on the ignition module.
- Connect the other end of the cable to the igniter or igniter-sensor stud on the pilot burner/igniter-sensor.

Connect Ignition Control Module



CAUTION

Equipment Damage Hazard.

Check the wiring diagram provided on the appliance and compare with Table 5 through Table 8 beginning on page 8. Carefully follow any special instructions affecting the general wiring procedures outlined in this section.

- Connect the wires to the module as shown in the wiring tables (Table 5 through Table 8). Make sure that adequate system ground is provided as indicated in the wiring tables. (Refer to Fig. 2 and Table 9 on page 11 for wiring connections on the S8610U module.)
- Verify the thermostat anticipator setting as explained in the Important notes in the wiring tables.

NOTE: Refer to Fig. 2 and Table 9 on page 11 for the location of each connection on the S8610U module.

The wiring diagrams in Fig. 3 through Fig. 5 beginning on page 12 describe typical hookups with the S8610U module and should be used for reference only.

- Fig. 3 shows a basic circuit used only for heating systems with atmospheric burners and damper control. (Shown with local and remote flame sensing.)
- Fig. 4 shows a basic circuit used only for heating systems with atmospheric burners without damper control. (Shown with local and remote flame sensing.)
- Fig. 5 shows a circuit for power assisted combustion applications.

The following four tables describe the wiring connections necessary for conversion:

Table 5. Conversion from Honeywell Intermittent Pilot Modules.

Terminal Function	Replacement Control	Old Control					Procedural Notes
	S8610U	S86A,C	S86B,D	S86E,F,G,H	S90A,B S8600A,B,C S8610A,B,C S8610U1003 S8620C, S8660D,J S8670D,J S8680D,J	S8600F,H,M S8610F,H,M S8660E,K S8670E,K	
Main Valve Operator	MV	MV	MV	MV	MV	MV	—
Main Valve and Pilot Common	MV/PV	MV/PV	MV/PV	MV/PV	MV/PV	MV/PV	—
Pilot Valve Operator	PV	PV	PV	PV	PV	PV	—
Burner Ground Connection	GND (BURNER)	GND	GND	GND (BURNER)	GND (BURNER)	GND (BURNER)	—
Transformer Secondary (un-switched leg)	24V GND	25V (2)	25V	25V (2) ^a	24V GND	24V GND	—
Transformer Secondary (switched leg)	24V *	25V (2)	25V	25V (2) ^{a *}	24V *	24V *	<p>* IMPORTANT</p> <p>If the old module had a vent damper connector but a vent damper was not installed, or if it did not have a vent damper connector, then connect the 25V (2) or 24V wire from the old module to the TH-W terminal on the S8610U. Do not use the 24V terminal on the S8610U.</p> <p>If the old module had a vent damper, connect it to the P1 connector on the module, and wire the terminals as indicated in the table.</p>
	TH-W	TH-R ^b	TH-R ^b	TH-R ^b	TH-W (This terminal is not included on S90.)	TH-W	
		TH-W ^c	TH-W	TH-W ^c			
Flame Sensor	SENSE ^d	e	e	e	SENSE ^d	e	—
Igniter / Sensor	SPARK	IGN COIL ^f	IGN COIL ^f	IGN COIL ^f	SPARK	SPARK	—

^a Terminals may be marked 25V on some models and 24V on later models. These are functionally equivalent.

^b If 25V (2) and TH-R have wires connected, disconnect and splice together with solderless connector.

^c If TH-R and TH-W are jumpered together, connect 25V (2) lead from S86 to TH-W on S8610U.

^d On dual igniter and sensor models, remove jumper wire quick connect from S8610U Remote Sense terminal, then cut jumper wire at circuit board and discard.

^e Leave black jumper connected.

^f Use Rajah to quick connector adapter (supplied) or cut Rajah connector off ignition cable at module end and attach insulated quick connect for connection to S8610U.

Table 6. Conversion from Johnson Controls CSA — (All), G60, G65, G66, G67, G600, G670 and G770.

Terminal Function	Replacement Control	Old Control				Procedural Notes
	S8610U	CSA45A-60R ^a , G60, G65, G66, G67, G600, or G670 Installation with Lockout Modules as follows:			G770	
		None (Y79)	Y79A module ^b	Y79A module ^c		
Main Valve Operator	MV	3	3	Y79B MV	MV (3)	—
Main Valve and Pilot Common	MV/PV	GR	GR	GR	GROUND (5)	—
Pilot Valve Operator	PV	1	1	Y79B PV	PV (1)	—
Burner Ground Connection	GND (BURNER)	GR	GR	GR	GROUND	—
Transformer Secondary (unswitched leg)	24V GND	GR	GR	GR	GROUND	—
Transformer Secondary (switched leg)	TH-W *	2 ^d	Y79 THS	2	TH-S (2)	—
	24V **	No Connection **	No Connection **	No Connection **	No Connection **	
Flame Sensor	SENSE *	4 ^e	4 ^e	4 ^e	SENSE (4) ^e	—
Igniter / Sensor	SPARK	IGN COIL	IGN COIL	IGN COIL	IGN COIL	It might be necessary to cut off the Rajah connector and/or attach an insulated, 1/4 inch quick connect.

^a CSA code numbers (for example, CSA45A-600R) are equivalent to G600 and use the same wiring information tables.

^b Discard wires between Y79A and module as follows: Red to 3, Black to 2, White to GR. Discard wire between transformer and 6.

^c Discard wires between Y79B and module as follows: White to 3, Black to 1, Brown to GR. Discard wire between transformer and 6.

^d Discard wire between transformer and terminal 5 (G60) or 6 (G600); otherwise, use existing harness for wiring.

^e **Important:** Remove black jumper quick connect from Remote Sense terminal of S8610U. Cut jumper wire at circuit board and discard.

*** IF INSTALLATION DOES NOT INCLUDE VENT DAMPER WITH PLUG CONNECTION TO MODULE:**

1. Connect the "Call for Heat" thermostat wire to the TH-W terminal.

**** IF INSTALLATION INCLUDES VENT DAMPER WITH PLUG CONNECTION TO MODULE:**

1. Connect the vent damper's Molex connector to the vent damper connector (P1) on the module.
2. Connect the thermostat W wire to TH-W.
3. Run wire from switched leg of transformer secondary to both thermostat R and S8610U Module 24V terminals.

Table 7. Conversion from Robertshaw SP715 and SP735C (includes 780-XXX and USI715U).

Terminal Function	Replacement Control	Old Control ^a			Procedural Notes
	S8610U	7000D Valve ^b	7100D Valve	7100K Valve	
Main Valve Operator	MV	MV (to Valve TH)	MV (to Valve M)	MV (to Valve TR)	—
Main Valve and Pilot Common	MV/PV	MV/PV (to Valve TR)	MV/PV (to Valve C)	MV/PV (to Valve C and TH)	—
Pilot Valve Operator	PV	PV (to Valve Pilot*)	PV (to Valve P)	PV (to Valve Pick and Hold)	* This is the terminal, which is not jumpered to TR.
Burner Ground Connection	GND (BURNER)	GND	GND	GND	—
Transformer Secondary (unswitched leg)	24V GND	TR	TR	TR	—
	24V	No connection	No connection	No connection	
Transformer Secondary (switched leg)		E3 ^c	E3 ^c	E3 ^c	When supplied, E3 provides connection to Lockout Timer
	TH-W	TH	TH	TH	If LO-15 is part of the installation, use the wire disconnected from E1, which is tagged <i>Thermostat</i> .
Flame Sensor	SENSE ^d	e	d	d	—
Igniter / Sensor	SPARK	IGN	IGN	IGN	—

^a 780-715 and USI 715U are equivalent to SP715; 780-735 and 780-737 are equivalent to SP735.

^b On 7000D series valve, retain (or install) white jumper between valve TR and pilot solenoid.

^c If LO-15 Lockout timer is not installed, E3 connector provided on SP715 is not used.

^d **Important:** If the USI 715U with combination igniter-sensor is not used, remove black jumper quick connect from Remote Sense terminal of S8610U. Cut jumper wire at circuit board and discard.

^e Labeled OPT. SENSOR on USI 715U. No external connection if combination igniter-sensor is used.

NOTE: Use existing wiring harness to make connections to S8610U per Table 7.

IMPORTANT

If installation includes LO-15 Lockout Timer, discard wires to E3 and TH. Disconnect and retain wire to LO-15 terminal E1. Tag wire, *Thermostat*. Discard LO-15.

Table 8. Conversion from Camstat, Fenwal, or HSC.

Terminal Function	Replacement Control	Old Control			Procedural Notes
	S8610U	CAMSTAT IPI-24-00 ^a	FENWAL 05-20X ^b	HSC 1003-3 and 1003-300 ^a	
Main Valve Operator	MV	MV	MAIN VALVE	MV	—
Main Valve and Pilot Common	MV/PV	GND	GROUND	GND/COM	Fenwal only: run separate lead to S8610U valve common terminal, MV/PV.
Pilot Valve Operator	PV	PV	PILOT VALVE	PV	—
Burner Ground Connection	GND (BURNER)	GND	—	—	To assure a good ground, run separate wire from the pilot burner to the S8610U GND (BURNER) connector.
Transformer Secondary (unswitched leg)	24V GND	T2	GROUND	GND/COM	—
	24V	No connection	No connection	No connection	
Transformer Secondary (switched leg)	TH-W	T1	POWER	24 VAC	—
Flame Sensor	SENSE	S ^c	—	SENSOR ^c	—
Igniter / Sensor	SPARK	IGN	H.V.	IGN COIL	Strip module end of ignition cable as necessary and attach an insulated, 1/4 in. quick connect for the connection to the S8610U.

^a Use existing wiring harness to make connections to S8610U.

^b Tag all wires at the module connector with terminal designations. Cut wires at connector, attach quick connects, and connect to S8610U per Table 8.

° **Important:** Remove black jumper quick connect from Remote Sense terminal of S8610U. Cut jumper wire at circuit board and discard.

Make Flame Sense Connection

For an ignition module used in remote flame sensing (separate igniter and sensor rods) applications, the sense jumper wire is not used. See Fig. 2 and Table 9 on page 11 and perform the following:

- Clip the sense jumper wire as close as possible to the base of the ignition control module and discard the clipped end.
- Attach the flame sensor wire from the Pilot burner/ igniter to the REMOTE SENSE connector.

For an ignition module used in local flame sensing (single rod) applications, see Fig. 2 and Table 9 on page 11 and perform the following:

- Attach the sense jumper wire to the REMOTE SENSE connector.

Connect Gas Control

Use No. 18 gauge solid or stranded wire. Use 1/4 in. female quick connects for control connections. Connect to gas control terminals as shown in wiring diagrams, using terminals appropriate to the gas control.

Ground the Control System

The igniter, flame sensor, and ignition control module must share a common ground with the pilot burner. Use thermoplastic insulated wire with a minimum rating of 221°F (105°C) for the ground wire; asbestos insulation is not acceptable. If necessary, use a shield to protect the wire from radiant heat generated by the burner. Connect the ground wire as follows:

1. Fit one end of the ground wire with a female 1/4 in. quick-connect terminal and connect it to the male quick-connect BRN GND terminal on the ignition control module.
2. Strip the other end of the wire and fasten it under the pilot burner bracket mounting screw. If necessary, use a shield to protect the ground wire from radiant heat.
3. The pilot burner serves as the common grounding area. If there is not good metal-to-metal contact between the pilot burner and ground, run a lead from the pilot burner to ground.

NOTE: Earth ground is not required.

Wiring Connections

Use Fig. 2 and Table 9 to make the remaining wiring connections. Fig. 3–Fig. 5 beginning on page 12 illustrate typical wiring connections in heating systems with atmospheric burners and with power-assisted combustion.

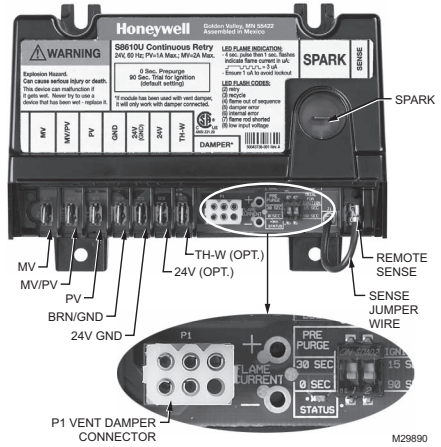
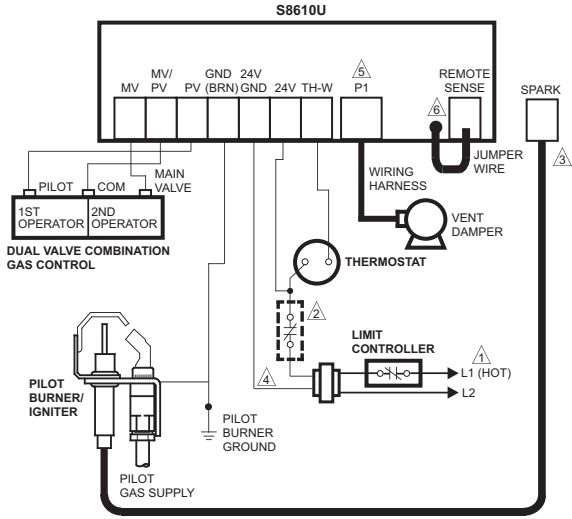

Fig. 2. Typical wiring connections.

Table 9. Typical Wiring Connections.

Connector Label	Size or Type	Description
MV	1/4 inch	Main Valve connection
MV/PV	1/4 inch	Common terminal for gas valves
PV	1/4 inch	Pilot Valve connection
BRN GND	1/4 inch	Burner Ground
24V GND	1/4 inch	Return path to transformer
24V	1/4 inch	Optional—24 Vac power connection for Vent Damper
TH-W	1/4 inch	Connector for "Call for Heat" signal from thermostat
P1	6-pin keyed plug	Connector for Vent Damper connection (used to control a connected damper in atmospheric appliances)
METER (µA)	Ammeter probes	Connection for ammeter probes for measuring flame current in µAmp DC.
SENSE JUMPER WIRE	Wire with 3/16 inch quick connect	Connects to the REMOTE SENSE connector for installations with a single spark rod (local flame sensing) NOTE: For installations with remote flame sensing (separate flame and sensor rods), this jumper wire is clipped as close to the circuit board as possible and the wire is discarded.
REMOTE SENSE	3/16 inch	Flame Sensor connector For single rod installations, connect the SENSE JUMPER WIRE to this terminal connector. For dual rod installations, connect the flame sense wire from the burner/igniter to this terminal connector.
SPARK	1/4 inch	High voltage sparking electrode



- ⚠️ 1. POWER SUPPLY. PROVIDE DISCONNECT MEANS AND OVERLOAD PROTECTION AS REQUIRED.
- ⚠️ 2. ALTERNATE LIMIT CONTROLLER LOCATION.
- ⚠️ 3. MAXIMUM CABLE LENGTH 3 FT. [0.9 M].
- ⚠️ 4. CONTROLS IN 24V CIRCUIT MUST NOT BE IN GROUND LEG TO TRANSFORMER.
- ⚠️ 5. ONCE 10 IGNITION CYCLES ARE COMPLETED WITH VENT DAMPER CONNECTED, MODULE WILL OPERATE ONLY WITH DAMPER CONNECTED.
- ⚠️ 6. FOR SINGLE ROD APPLICATIONS: CONNECT JUMPER WIRE TO THE REMOTE SENSE CONNECTOR.

FOR TWO ROD APPLICATIONS: REMOVE JUMPER WIRE BY CUTTING IT AS CLOSE AS POSSIBLE TO THE BASE OF THE MODULE, DISCARD CLIPPED WIRE, AND FIRMLY ATTACH THE SENSOR WIRE FROM THE IGNITER/SENSOR ASSEMBLY TO THE REMOTE SENSE CONNECTOR.

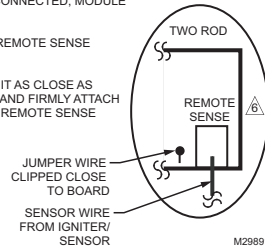

M29891

Fig. 3. S8610U connections in a heating system with an atmospheric burner and vent damper.

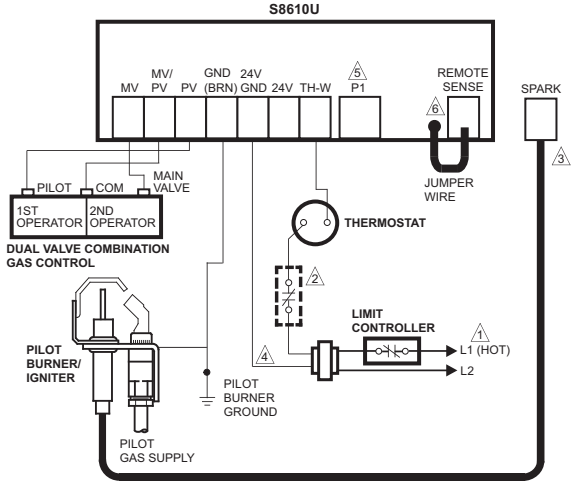

- ⚠️ 1 POWER SUPPLY. PROVIDE DISCONNECT MEANS AND OVERLOAD PROTECTION AS REQUIRED.
- ⚠️ 2 ALTERNATE LIMIT CONTROLLER LOCATION.
- ⚠️ 3 MAXIMUM CABLE LENGTH 3 FT. [0.9 M].
- ⚠️ 4 CONTROLS IN 24V CIRCUIT MUST NOT BE IN GROUND LEG TO TRANSFORMER.
- ⚠️ 5 LEAVE VENT DAMPER PLUG (P1) UNCONNECTED.
- ⚠️ 6 FOR SINGLE ROD APPLICATIONS: CONNECT JUMPER WIRE TO THE REMOTE SENSE CONNECTOR.

FOR TWO ROD APPLICATIONS: REMOVE JUMPER WIRE BY CUTTING IT AS CLOSE AS POSSIBLE TO THE BASE OF THE MODULE, DISCARD CLIPPED WIRE, AND FIRMLY ATTACH THE SENSOR WIRE FROM THE IGNITER/SENSOR ASSEMBLY TO THE REMOTE SENSE CONNECTOR.

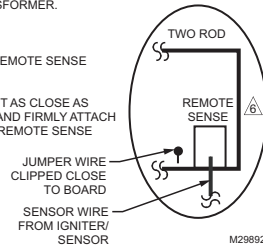

Fig. 4. S8610U connections in a heating system with an atmospheric burner and no vent damper.

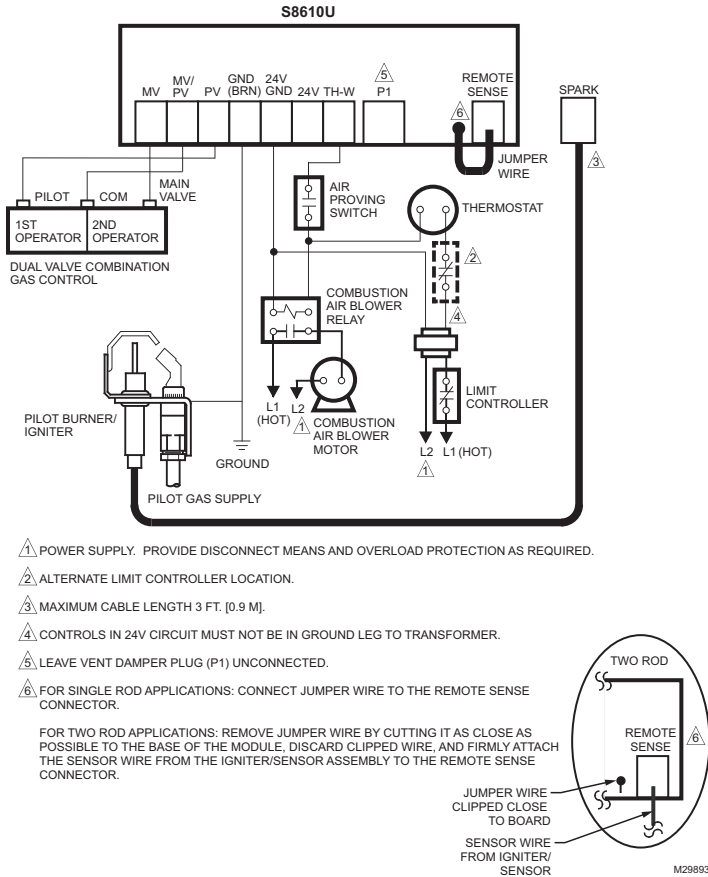

Fig. 5. S8610U connections in a heating system with power-assisted combustion.

SETTINGS AND ADJUSTMENTS

DIP Switch (S1) Settings

When replacing an existing ignition control with the S8610U, refer to Table 2 on page 2 for the correct DIP switch settings.

NOTE: Refer to Table 10 for lockout control of DIP switch timing settings.

IMPORTANT

Do not power the ignition control prior to setting the DIP switches.

The following timing parameters may be set with this 2-position DIP switch.

Prepurge

To select Prepurge, set **SW1** according to Table 10.

Trial for Ignition (TFI)

To select the Trial for Ignition timing, set **SW2** according to Table 10.

Table 10. DIP Switch (S1) Settings.

Prepurge	Trial For Ignition	SW1	SW2
None	90 seconds	OFF	OFF
30 seconds	90 seconds	ON	OFF
None	15 seconds	OFF	ON
30 seconds	15 seconds	ON	ON

NOTE: The default factory settings (all OFF) are in **Bold** in Table 10.

IMPORTANT

Once the module starts the 20th "Call for Heat", the control operating sequence is permanently locked and cannot be reset by resetting the Dip Switch.

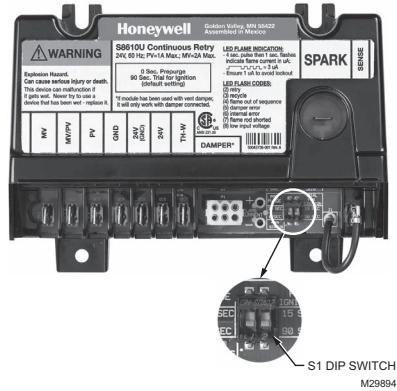

Fig. 6. DIP Switch (S1) Location.

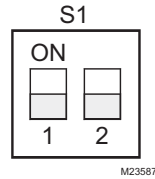

Fig. 7. DIP Switch (S1) - shown with factory default settings (OFF) for SW1 and SW2.

CHECKOUT

Check out the gas control system:

- At initial installation of the appliance.
- As part of regular maintenance procedures. Maintenance intervals are determined by the application. For additional information, See "Planning the Installation" on page 4.
- As the first step in troubleshooting.
- Any time work is done on the system.

⚠ WARNING

Fire or Explosion Hazard.
Failure to heed these warnings may cause fire or explosion with property damage, injury, or loss of life.

1. If you smell gas or suspect a gas leak, turn off gas at manual service valve and evacuate the building. Do not try to light any appliance, do not touch any electrical switch or telephone in the building until you are sure no spilled gas remains.
2. Gas leak test must be done as described in the steps below on initial installation and any time work is done involving the gas piping.

Step 1: Perform Visual Inspection.

1. With power off, make sure all wiring connections are clean and tight.
2. Turn on power to appliance and ignition control module.
3. Open manual shutoff valves in the gas line to the appliance.
4. Perform a gas leak test ahead of gas control if piping has been disturbed.

GAS LEAK TEST (DOWNSTREAM OF GAS CONTROL)

Paint the gas control gasket edges and all pipe connections upstream of the gas control with a rich soap and water solution. Bubbles indicate gas leaks. Tighten the joints and screws or replace component to stop gas leak. Recheck with soap and water solution.

Step 2: Verify Ignition Control System Ground.

The igniter, flame sensor, and ignition control module must share a common ground with the pilot burner. Use thermoplastic insulated wire with a minimum rating of 221°F (105°C) for the ground wire; asbestos insulation is not acceptable. If the temperature at the wire could exceed 221°F (105°C), use a shield to protect the wire from radiant heat generated by the burner. Connect the ground wire as follows:

1. Fit one end of the ground wire with a female 1/4 in. quick-connect terminal and connect it to the male quick-connect GND (BURNER) terminal on the ignition control module.
2. Strip the other end of the wire and fasten it under the igniter bracket mounting screw. If necessary, use a shield to protect the ground wire from radiant heat.
3. The burner serves as the common grounding area. If there is not good metal-to-metal contact between the burner and ground, run a lead from the burner to ground.

NOTE: Earth ground is not required.

Step 3: Review Normal Operating Sequence and Ignition Control Module Specifications.

- See “Operation” section on this page and “Specifications” on page 3.

Step 4: Reset the Ignition Control Module.

1. Turn the thermostat to its lowest setting.
2. Wait one minute.

As you perform the remaining steps, watch for points where operation deviates from normal. To correct problems, refer to the “Troubleshooting Guide” on page 23.

Step 5: Check Safety Shutoff Operation.

1. Turn gas supply off.
2. Set thermostat or controller above room temperature to “Call for Heat.”

3. Watch for spark at pilot burner. Time spark from start to shutoff. Spark should shut off after 15 or 90 seconds (selectable with Dip Switch SW1). See device label and “Settings and Adjustments” on page 15.
4. Wait 5 minutes. Ignition sequence should start again followed by shutoff.
5. Open manual gas cock and make sure no gas is flowing to pilot or main burner.
6. Set thermostat below room temperature and wait one minute before continuing.

Step 6: Check Normal Operation.

1. Turn on the gas supply.
2. Set thermostat or controller above room temperature to “Call for Heat.”
3. Make sure pilot lights smoothly when gas reaches the pilot burner.
4. Make sure main burner lights smoothly without flashback.
5. Make sure burner operates smoothly without floating, lifting, or flame rollout to the furnace vestibule or heat buildup in the vestibule.
6. Perform a gas leak test in the appliance.

GAS LEAK TEST (UPSTREAM OF GAS CONTROL)

Paint the gas control gasket edges and all pipe connections downstream of the gas control, including the pilot tubing connections, with a rich soap and water solution. Bubbles indicate gas leaks. Tighten the joints and screws or replace component to stop gas leak. Recheck with soap and water solution.

7. Turn the thermostat or controller below the room temperature. Make sure the main burner and pilot flames go out.

OPERATION

Fig. 8 on page 18 summarizes the normal operating sequence for installations with and without vent dampers. The ignition control module’s operation can be conveniently divided into two phases.

- Trial for pilot ignition
- Main burner operation

Trial for Pilot Ignition

On a “Call for Heat,” the ignition control module energizes the spark source and the pilot valve relay simultaneously. The pilot valve opens, allowing gas to flow to the pilot burner for the ignition trial time. The spark lights the pilot flame when pilot gas is present. A flame rectification circuit confirms the presence of the pilot flame, shuts off the spark source, and energizes the main valve relay.

The ignition control module uses a two-level pilot flame proving sequence. When a sufficient flame current is sensed, the spark is turned OFF. However, the pilot flame must generate a higher level of flame current to energize the main valve. This approach assures a stable pilot flame to support reliable burner lightoff. If the pilot flame is weak or unstable, the spark may turn back ON. However, the trial for pilot ignition will not exceed the stated ignition trial time.

Main Burner Operation

When the main valve opens, gas flows to the main burner where it is lit by the pilot flame. There is a short flame stabilization period as the main valve opens to allow the pilot flame to stabilize as the main gas lights. The system is now in the run mode with the presence of the pilot flame continuously monitored by the flame rectification circuit. If the pilot flame goes out, the ignition control module senses loss of pilot flame and shuts off both the pilot valve relay and the main valve relay. Flow of gas to pilot and main burners stops as the valves close (100% shutoff).

Failed Trial for Pilot Ignition

The S8610U control module provides multiple trials for ignition (TFI). If the pilot is not lit or sensed before the end of the trial for ignition time, the ignition control shuts off the spark and pilot gas (100% shutoff). There is a five minute delay before another TFI is initiated. The pattern of TFI followed by a five minute delay continues until the pilot lights and is proved or the "Call for Heat" ends. The five minute delay time can be bypassed by cycling the system thermostat or removing and restoring system power.

The following operating sequence includes vent damper operation (if connected) and Prepurge (if configured).

OPERATING SEQUENCE

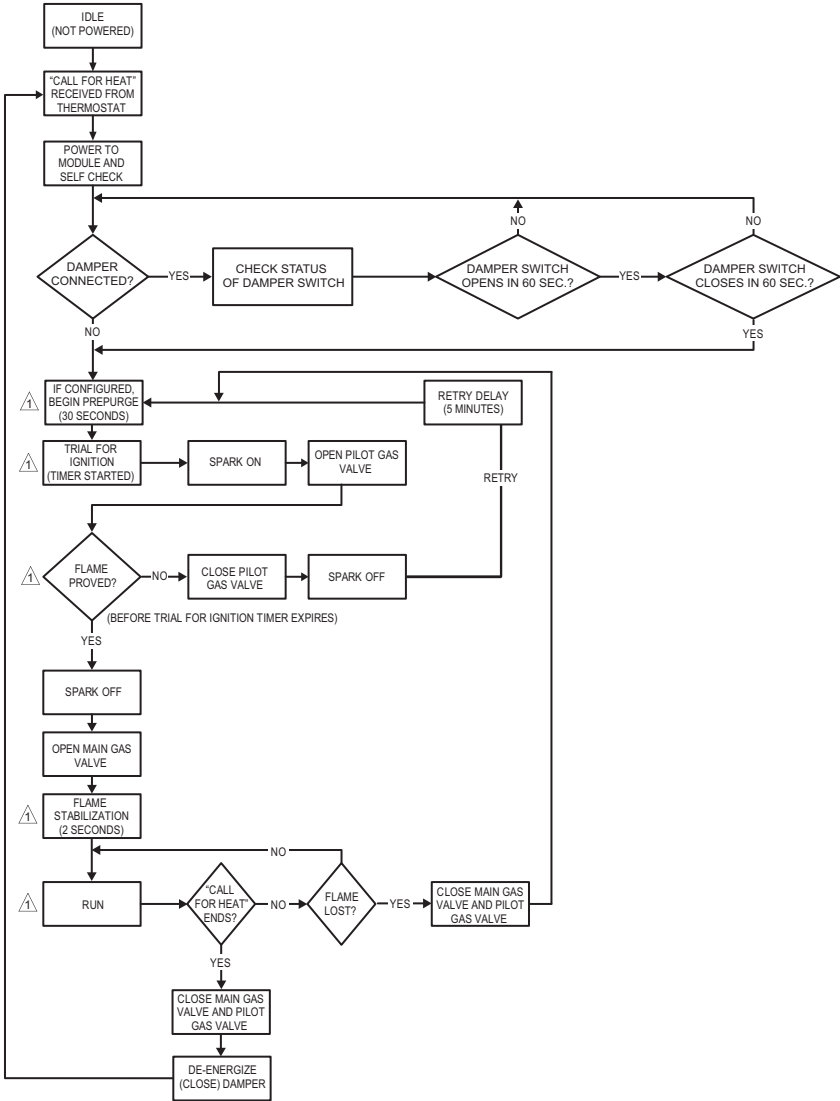

⚠ IF DAMPER CONNECTED AND DAMPER SWITCH IS OPEN, IGNITION CONTROL CLOSES PILOT AND MAIN GAS VALVES (IF OPEN), TURNS SPARK OFF (IF ON), AND GOES TO CHECK STATUS OF DAMPER SWITCH.

M29895

Fig. 8. Normal Operating Sequence.

TROUBLESHOOTING

WARNING

Fire, Explosion, or Electrical Shock Hazard.
Can cause severe injury, death or property damage.

Do not attempt to modify the physical or electrical characteristics of this device in any way. Replace it if troubleshooting indicates a malfunction.

IMPORTANT

1. The following service procedures are provided as a general guide. Follow appliance manufacturer's service instructions if available.
2. Meter readings between the gas control and ignition control module must be taken within the trial for ignition period. Once the ignition control module shuts off, it must be reset by setting the thermostat down for at least 30 seconds before continuing.
3. If any component does not function properly, make sure it is correctly installed and wired before replacing it.
4. The ignition control module cannot be repaired. If it malfunctions, it must be replaced.
5. Only trained, experienced service technicians should service intermittent pilot systems.
6. After troubleshooting, check out the system again to be sure it is operating normally.

The general troubleshooting sequence is as follows:

1. Refer to "LED Status and Troubleshooting" on page 20 for LED status codes.
2. Perform the "Checkout" on page 15 as the first step in troubleshooting.
3. Check the troubleshooting guide (Fig. 12 on page 23) to pinpoint the cause of the problem.
4. If troubleshooting indicates an ignition problem, see Ignition System Checks below to isolate and correct the problem.
5. Following troubleshooting, perform the "Checkout" on page 15 again to be sure system is operating normally.

Ignition System Checks

Step 1: Check Ignition Cable.

Make sure:

1. Ignition cable is not damaged, cracked, burned, or dirty. Replace if necessary.
2. Ignition cable does not run in contact with any metal surfaces.
3. Ignition cable is no more than 36 in. (0.9 m) long.
4. Connections to the ignition control module and to the igniter or igniter-sensor are clean and tight.
5. Ignition cable provides good electrical continuity.

STEP 2: Check Ignition System Grounding.

Nuisance shutdowns are often caused by a poor or erratic ground. A common ground, is required for the ignition control module and the pilot burner bracket.

1. Check for good metal to metal contact between the pilot burner bracket and the main burner.
2. Check the ground circuit from the GND (BURNER) terminal on the ignition control module to the pilot burner. Make sure connections are clean and tight. If the wire is damaged or deteriorated, replace it with 14- to 18-gauge, moisture-resistant, thermo-plastic insulated wire with 221°F (105°C) minimum rating.
 - a. Check the ceramic flame rod insulator for cracks or evidence of exposure to extreme heat, which can permit leakage to ground. Replace pilot burner/igniter-sensor and provide shield, if necessary.
 - b. If the flame rod or bracket is bent out of position, restore to correct position.

STEP 3: Check Spark Ignition Circuit.

You will need a short jumper wire made from ignition cable or other heavily insulated wire.

1. Close the manual gas valve.
2. Disconnect the ignition cable at the SPARK terminal on the ignition control.

WARNING

Electrical Shock Hazard.
Can cause severe injury, death or property damage.

When performing the following steps, do not touch the stripped end of jumper or SPARK terminal. The ignition circuit generates over 10,000 volts and electrical shock can result.





3. Energize the ignition control module and immediately touch one end of the jumper firmly to the GND terminal on the ignition control module. Move the free end of the jumper slowly toward the SPARK terminal until a spark is established.
4. Pull the jumper slowly away from the terminal and note the length of the gap when sparking stops. Check Table 11 below.

Table 11. Arc Troubleshooting.

Arc Length	Action
No arc or arc less than 1/8 in. (3 mm)	Check external fuse, if provided. Verify power at the ignition control module's control input terminal. Replace control if fuse and power are okay.
Arc 1/8 in. (3 mm) or longer	Voltage output is okay.

STEP 4: Check Pilot and Main Burner Lightoff.

1. Set the thermostat to "Call for Heat."
2. Watch the pilot burner during the ignition sequence. See if one of the following occurs:
 - a. Ignition spark continues after the pilot is lit.
 - b. The pilot lights and the spark stops, but main burner does not light.
 - c. The pilot lights, the spark stops and main burner lights, but the pilot and main gas shut down while the "Call for Heat" is still present.
3. If so, ensure adequate flame current as follows.
 - a. Turn off appliance power at circuit breaker or fuse box.
 - b. Clean the flame rod with emery cloth.
 - c. Make sure electrical connections are clean and tight. Replace damaged wire with moisture-resistant No. 18 wire rated for continuous duty up to 221°F (105°C).
 - d. Check for cracked ceramic insulator, which can cause short to ground, and replace igniter-sensor if necessary.
 - e. Check for cracked, damaged, burned, or dirty spark ignition cable and replace if necessary. Be sure ignition cable is not touching any flat metal surface.
 - f. At the gas control, disconnect main valve wire from the TH-W or MV terminal.
 - g. Turn on power and set thermostat to "Call for Heat." The pilot should light but the main burner will remain off because the main valve actuator is disconnected.
 - h. Check the pilot flame. Make sure it is blue, steady and envelops 3/8 to 1/2 in. (10 to 13 mm) of the flame rod. See Fig. 9 for possible flame problems and their causes.
 - i. If necessary, adjust pilot flame by turning the pilot adjustment screw on the gas control clockwise to decrease or counterclockwise to increase pilot flame. Following adjustment, always replace pilot adjustment cover screw and tighten firmly to assure proper gas control operation.
 - j. Set thermostat below room temperature to end "Call for Heat."
4. Recheck ignition sequence as follows.
 - a. Reconnect main valve wire.
 - b. Set thermostat to "Call for Heat."
 - c. Watch ignition sequence at burner.
 - d. If spark still doesn't stop after pilot lights, replace ignition control module.
 - e. If main burner doesn't light or if main burner lights but system locks out, check the ignition control module's ground wire and the gas control as described in "Troubleshooting" on page 19 and refer to the Troubleshooting Guide (Fig. 12 on page 23).

APPEARANCE	CAUSE
<p>SMALL BLUE FLAME</p> 	<p>CHECK FOR LACK OF GAS FROM:</p> <ul style="list-style-type: none"> • CLOGGED ORIFICE FILTER • CLOGGED PILOT FILTER • LOW GAS SUPPLY PRESSURE • PILOT ADJUSTMENT AT MINIMUM
<p>LAZY YELLOW FLAME</p> 	<p>CHECK FOR LACK OF AIR FROM:</p> <ul style="list-style-type: none"> • DIRTY ORIFICE • DIRTY LINT SCREEN, IF USED • DIRTY PRIMARY AIR OPENING, IF THERE IS ONE • PILOT ADJUSTMENT AT MINIMUM
<p>WAVING BLUE FLAME</p> 	<p>CHECK FOR:</p> <ul style="list-style-type: none"> • EXCESSIVE DRAFT AT PILOT LOCATION • RECIRCULATING PRODUCTS OF COMBUSTION
<p>NOISY LIFTING BLOWING FLAME</p> 	<p>CHECK FOR:</p> <ul style="list-style-type: none"> • HIGH GAS PRESSURE
<p>HARD SHARP FLAME</p> 	<p>THIS FLAME IS CHARACTERISTIC OF MANUFACTURED GAS</p> <p>CHECK FOR:</p> <ul style="list-style-type: none"> • HIGH GAS PRESSURE • ORIFICE TOO SMALL

M2233B

Fig. 9. Examples of unsatisfactory pilot flames.

LED Status and Troubleshooting

The ignition control module has one LED used for flame sensing and system status:

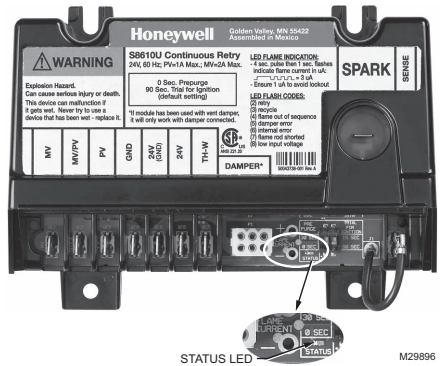

Fig. 10. Location of LED.

Table 12. Green LED Status Codes.

Green LED Flash Code ^a	Indicates	Next System Action	Recommended Service Action
OFF	No "Call for Heat"	Not applicable	None
Flash Fast	Power up - internal check	Not applicable	None
Heartbeat	Normal startup - ignition sequence started (including prepurge)	Not applicable	None
4 Seconds ON then "x" flashes	Device in run mode. "x" = flame current to the nearest μ A.	Not applicable	None
2	5 minute Retry Delay – Pilot flame not detected during trial for ignition	Initiate new trial for ignition after retry delay completed.	If system fails to light on next trial for ignition check gas supply, pilot burner, spark and flame sense wiring, flame rod contaminated or out of position, burner ground connection.
3	Recycle – Flame failed during run	Initiate new trial for ignition. Flash code will remain through the ignition trial until flame is proved.	If system fails to light on next trial for ignition, check gas supply, pilot burner, flame sense wiring, contamination of flame rod, burner ground connection.
4	Flame sensed out of sequence	If situation self corrects within 10 seconds, control module returns to normal sequence. If flame out of sequence remains longer than 10 seconds, control will resume normal operation 1 hour after error is corrected.	Check for pilot flame. Replace gas valve if pilot flame present. If no pilot flame, cycle "Call for Heat." If error repeats, replace control.
5	Damper Error: – Damper required but not present – Damper failed to open within 60 seconds – Damper failed to close within 60 seconds	If damper error corrects, ignition control resumes normal operation.	Check damper connection, damper wiring, and 24V connection on control. Replace damper if necessary.
6	Control Internal Error	Control module remains in wait mode. When the fault corrects, control module resumes normal operation.	Cycle "Call for Heat." If error repeats, replace control.
7	Flame rod shorted to ground	Control module remains in wait mode. When the fault corrects, control module resumes normal operation.	Check flame sense lead wire for damage or shorting. Check that flame rod is in proper position. Check flame rod ceramic for cracks, damage or tracking.
8	Low secondary voltage supply	Control module remains in wait mode. When the fault corrects, control module resumes normal operation.	Check transformer and AC line for proper input voltage to the control. Check with full system load on the transformer.

^a Flash Code Descriptions:

- Flash Fast: rapid blinking.
- Heartbeat: Constant ½-second bright, ½-second dim cycles.
- 4-second solid on pulse followed by "x" 1-second flashes indicates flame current to the nearest μ A. This is only available in run mode.
- A single flash code number signifies that the LED flashes X times at 2 Hz, remains off for two seconds, and then repeats the sequence.

Flame Current Measurement

Flame current of the device can be measured using a standard micro-ammeter by simply inserting the meter probes into the holes labeled FLAME CURRENT, as shown in Fig. 11.

- Flame current must be measured with pilot valve lit but no main gas flowing.
- Disconnect MV leadwire from the control before measuring flame current.
- Set meter to DC μ Amp scale.
- Ensure meter leads are positioned correctly [+/-].

NOTE: Trying to measure the pilot flame current in series with the wiring will not be accurate.

Recommended Minimum Pilot Only Flame Current:

- Must read steady 1 μ Amp DC minimum.
- Flame current should be 2 μ Amp or greater for reliable appliance operation.

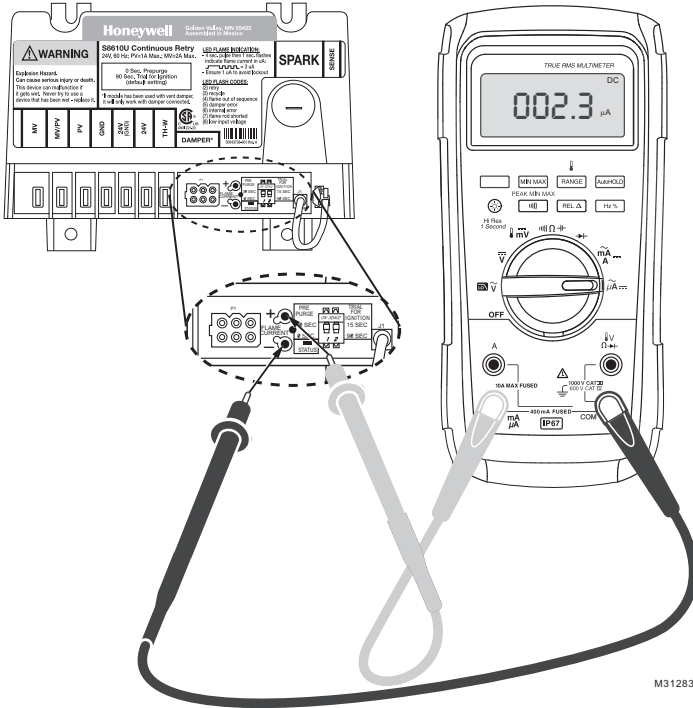
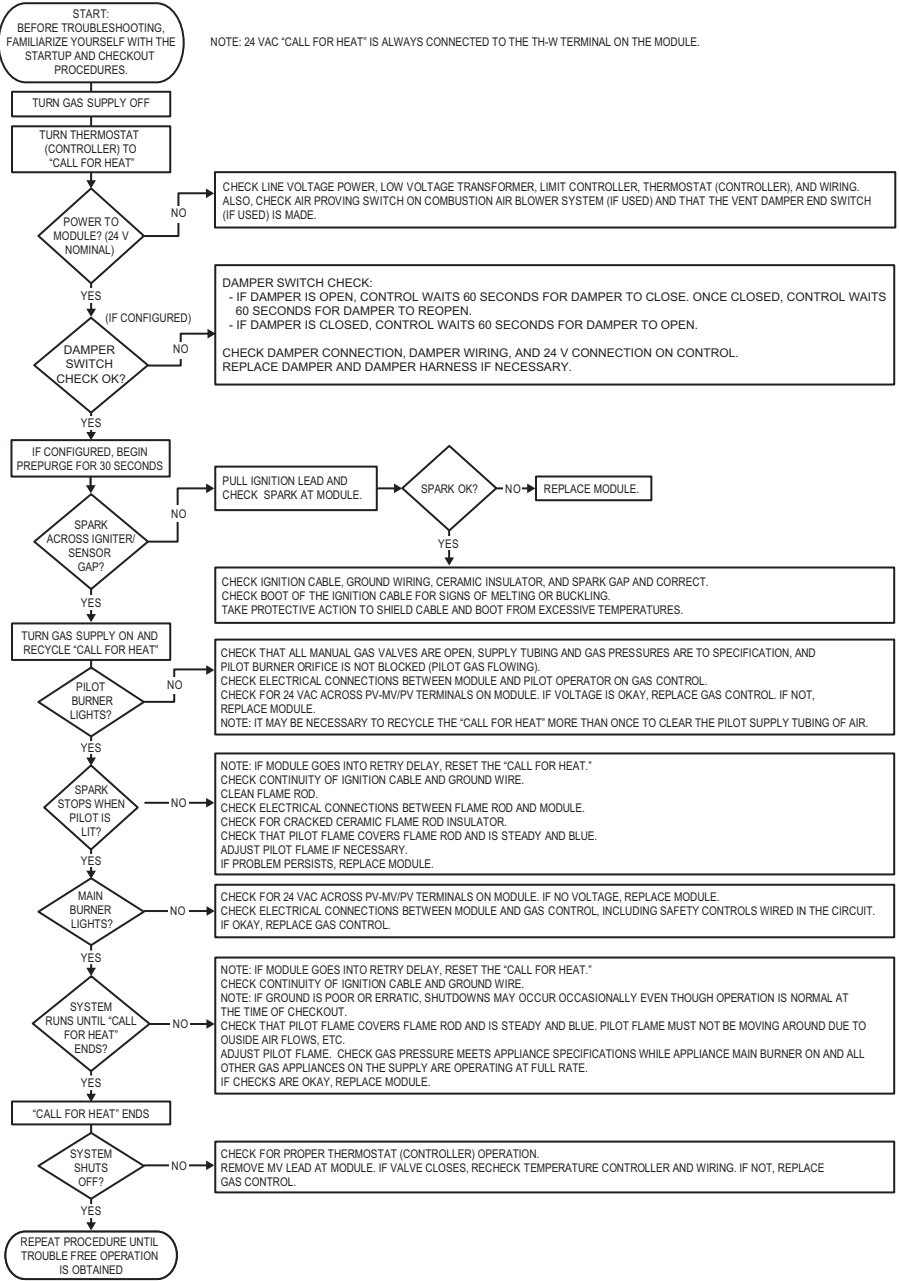

Fig. 11. Measuring flame current with micro-ammeter.

Troubleshooting Guide

Refer to the following guide for troubleshooting the S8610U control module.



M29922

Fig. 12. Troubleshooting Guide.

Automation and Control Solutions

Honeywell International Inc.
1985 Douglas Drive North
Golden Valley, MN 55422

Honeywell Limited-Honeywell Limitée
35 Dynamic Drive
Toronto, Ontario M1V 4Z9
customer.honeywell.com

® U.S. Registered Trademark
© 2010 Honeywell International Inc.
69-1955—01 M.S. Rev. 02-10
Printed in U.S.A.

Honeywell

Free Manuals Download Website

<http://myh66.com>

<http://usermanuals.us>

<http://www.somanuals.com>

<http://www.4manuals.cc>

<http://www.manual-lib.com>

<http://www.404manual.com>

<http://www.luxmanual.com>

<http://aubethermostatmanual.com>

Golf course search by state

<http://golfingnear.com>

Email search by domain

<http://emailbydomain.com>

Auto manuals search

<http://auto.somanuals.com>

TV manuals search

<http://tv.somanuals.com>