

T8411R Electronic Heat Pump Thermostat

INSTALLATION INSTRUCTIONS

APPLICATION

The T8411R Heat Pump Thermostat provides 24V control of a two-stage heating and one-stage cooling heat pump system with manual changeover from heat to cool. First stage heating and cooling cycle rates are fixed at 3 cph. Second stage heating cycle rate is selectable at 3, 6, or 9 cph. Temperature indication can be set for °F or °C.

The T8411R Heat Pump Thermostat is powered directly from the system transformer. Setpoints are held permanently in memory and retained during power outages.

The T8411R includes a thermostat, wallplate (for wiring and mounting thermostat) and owner's guide. A 7 3/8 in. (188 mm) x 5 3/4 in. (146 mm) Decorator Cover Plate (for covering wall marks) is available separately. Order Honeywell part no. 209650A (Premier White®).



RECYCLING NOTICE

If this control is replacing a control that contains mercury in a sealed tube, do *not* place your old control in the trash.

Contact your local waste management authority for instructions regarding recycling and the proper disposal of an old control containing mercury in a sealed tube.

INSTALLATION

When Installing this Product...

1. Read these instructions carefully. Failure to follow them could damage the product or cause a hazardous condition.
2. Check the ratings given in the instructions and on the product to make sure the product is suitable for your application.
3. Installer must be a trained, experienced service technician.
4. After installation is complete, check out product operation as provided in these instructions.



CAUTION

Disconnect power supply before beginning wiring to prevent electrical shock or equipment damage.

Location

Install the thermostat about 5 ft (1.5 m) above the floor in an area with good air circulation at average temperature. See Fig. 1. Do not install the thermostat where it can be affected by:

- drafts or dead spots behind doors and in corners.
- hot or cold air from ducts.
- radiant heat from the sun or appliances.
- concealed pipes and chimneys.
- unheated (uncooled) areas such as an outside wall behind the thermostat.

This thermostat is a precision instrument and was carefully adjusted at the factory. *Handle it carefully.*

Mounting Wallplate

IMPORTANT

Level for appearance only. The thermostat functions normally even when not level.

Mount wallplate, T8411R and the screws provided (see Fig. 2) as follows:

1. Position the wallplate at the desired location on the wall.
2. Use a pencil to mark the mounting holes.
3. Remove the wallplate from the wall and drill two 3/16 in. holes in the wall (if drywall) and two 7/32 in. holes for firmer material such as plaster or wood. Gently tap the anchors (provided) into the holes until flush with the wall.
4. Position the wallplate over the holes.
5. Pull the thermostat wire through the entrance hole on the wallplate.



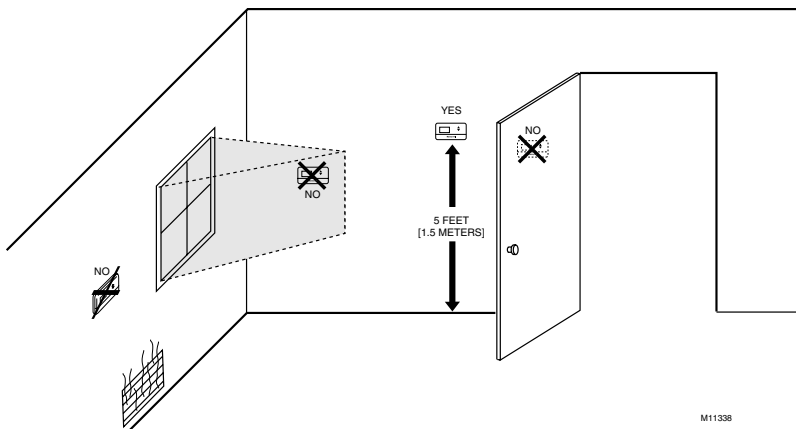

Fig. 1. Typical location of thermostat.

M11338

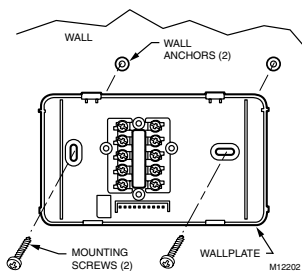

Fig. 2. Mounting wallplate to wall.

Wiring

IMPORTANT

Use 18-gauge thermostat cable for proper wiring.

All wiring must comply with local electrical codes and ordinances.



CAUTION

Disconnect the power supply to prevent electrical shock or equipment damage.

The shape of the terminals permits insertion of straight or wraparound wiring connections; either method is acceptable. See Fig. 3.

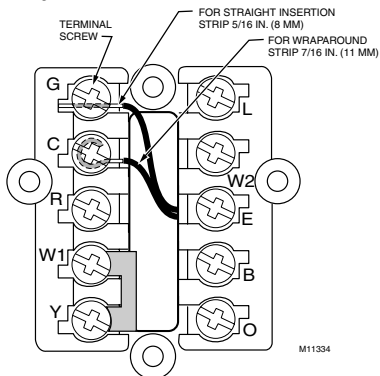

M11334

Fig. 3. Wiring connections.

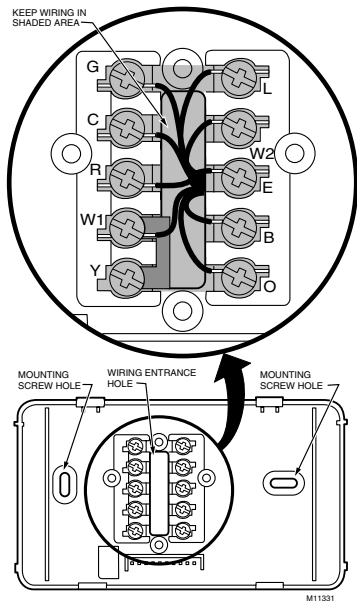

Fig. 4. Restrict wiring to shaded area.

NOTE: Restrict all wiring to the shaded area between the terminals. See Fig. 4.

Refer to Fig. 5 for typical wiring hookup. A letter code is located near each terminal for identification.

1. Loosen the terminal screws on the wallplate and connect the system wires. See Fig. 5.
2. Securely tighten each terminal screw.
3. Push the excess wire back into the hole.
4. Plug the hole with nonflammable insulation to prevent drafts from affecting the thermostat.

Mounting Thermostat To Wallplate

1. Engage the tabs at the top of the thermostat and wallplate.
2. Swing down the thermostat and press the lower edge of the thermostat onto the wallplate to latch. See Fig. 6.

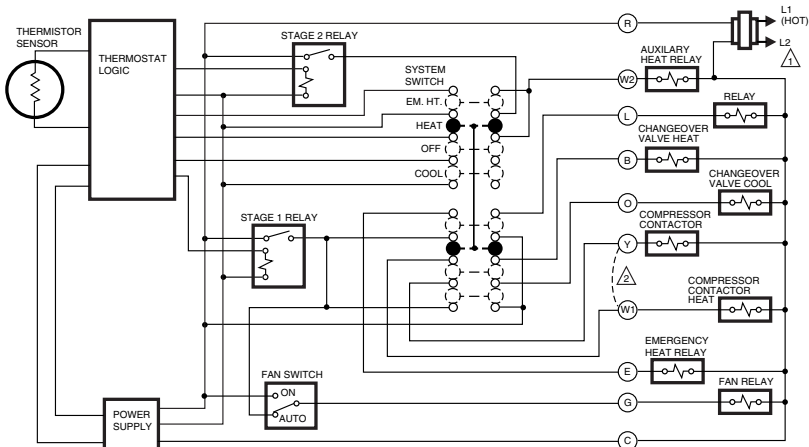

⚠ POWER SUPPLY. PROVIDE DISCONNECT MEANS AND OVERLOAD PROTECTION AS REQUIRED.

⚠ REMOVE JUMPER, WHEN SUPPLIED, FOR SYSTEMS WITH SEPERATE HEATING COMPRESSOR CONTACTOR (W1 SEPARATE FROM Y).

Fig. 5. T8411R two-stage heat and one-stage cool wiring diagram with manual changeover.

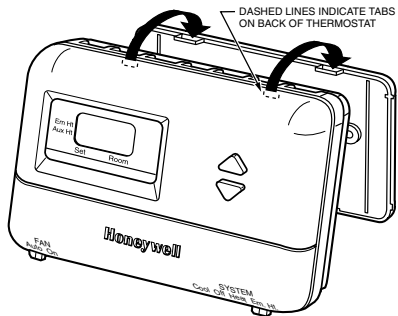

A ENGAGE TABS AT TOP OF THERMOSTAT WITH SLOTS ON MOUNTING PLATE.

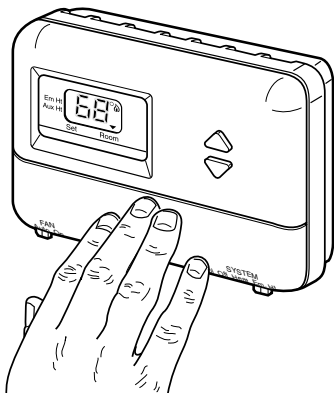

B PRESS LOWER EDGE OF CASE TO LATCH. M11332

Fig. 6. Mounting thermostat to wallplate.

OPERATION

Setting FAN and SYSTEM Switches

Fan and system settings are controlled manually by using the switches located at the bottom of the thermostat case. See Fig. 7.

FAN Switch

Fan switch settings are as follows:

On: The fan runs continuously. Use for improved air circulation.

Auto: Normal setting for most homes. The fan starts and stops with the equipment.

Slide the switch in the bottom left corner of the thermostat to select the desired fan setting.

SYSTEM Switch

System switch settings control thermostat operation as follows:

Cool: Thermostat controls the cooling system.

Off: Both heating and cooling are off.

Heat: Thermostat controls the heating system.

Em Ht: Thermostat cycles Auxiliary Heat (W2) and Emergency Heat Relay (E) as needed to maintain setpoint. Terminal L is energized continuously. (Fault heat relay is on continuously.) Cooling system is off. Compressor is de-energized.

Slide the switch in the bottom right corner of the thermostat to select the desired system setting.

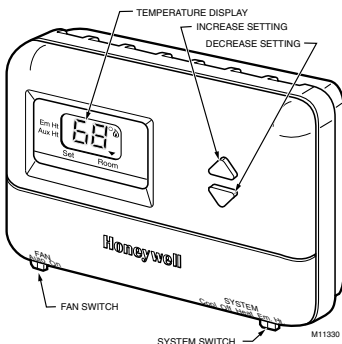

Fig. 7. Temperature display and system switches. M11330

Em Ht and Aux Ht Indications

The ■ indicator points to either Emergency Heat (Em Ht) or Auxiliary Heat (Aux Ht) when these modes are active.

Em Ht: The ■ indicator points to Em Ht when the SYSTEM switch is set at Em Ht.

Aux Ht: The ■ indicator points to Aux Ht when auxiliary backup heat is needed to help handle the heating load.

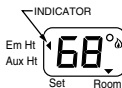

M10287

Set Temperature Setpoint

NOTE: Temperature setpoint range is 40°F to 99°F (4°C to 39°C).

The temperature setpoint and the room temperature are shown separately on the digital display. The ▼ indicator points to **Set** when the temperature setpoint is displayed and to **Room** when the room temperature is displayed.

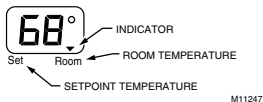

To set temperature setpoint:

1. Select heat or cool by sliding the SYSTEM switch in the lower right corner of the thermostat to the desired mode. See Fig. 7.
2. To display the setpoint temperature on the digital display, press either the ▲ or ▼ key once. The temperature setpoint is displayed for approximately five seconds as the indicator points to **Set** and flashes.



3. To increase the setpoint temperature, press the ▲ key. Press once to change the setpoint one degree; press and hold to change the setpoint several degrees.



4. To decrease the setpoint temperature, press the ▼ key.



Setting °F/°C Indication and Heat Cycle Rate

NOTES: To save changes to the °F/°C indication and the heat cycle rate, all seven steps must be completed.

In installer setup mode steps 2. through 5., each press of the ▲ key momentarily displays 01 and each press of the ▼ key momentarily displays 02. When the keys are released, these two-digit codes are no longer displayed.

To set the °F/°C indication and heat cycle rate:

1. If the room temperature is displayed in °F, set the temperature setpoint to 52°F. If the room temperature is displayed in °C, set the temperature setpoint to 11°C.

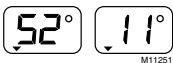

2. Press the ▲ ▼ keys simultaneously for more than two seconds to light all segments on the display and to enter installer setup mode. When the keys are released, a two-digit software code is displayed (code displayed may vary).



Optional System Checkout



CAUTION

When the heat or cool outputs are turned on, the five-minute off-timer safety feature is bypassed.

When in steps 2. and 3. only, the ▼ key can be used to turn heat or cool outputs on. Change the system switch setting to test heat or cool outputs. No action takes place if the system switch is in the Off position.

The following examples of system settings show a two digit software code on the display. The code shown is only an example; codes may vary.

System setting at Heat:

To turn heat on, press the ▼ key.



To turn auxiliary heat on, press the ▼ key.



To turn auxiliary heat off, press the ▼ key a third time.



To turn heat off, press the ▼ key a fourth time.



System setting at Cool:

To turn cool on, press the ▼ key.



To turn cool off, press the ▼ key.



3. Press the ▲ key. Factory information is displayed. Information displayed varies by model. This information is only for factory use.

- Press the ▲ key again to display °C or °F.



- Press the ▼ key to change the °C or °F indication.



NOTE: Stage one heat and cool cycle rates are fixed at 3 cph. Only stage two heat cycle rates are selectable.

- Press the ▲ key to display the heat cycle rate of 3, 6, or 9. If the desired cycle is displayed, press the ▲ key to exit the installer setup mode. To change the heat cycle rate, press the ▼ key to scroll between 3, 6, and 9. Stop scrolling when the desired rate is displayed.



- Press the ▲ key to save all changes, exit installer setup mode and return to normal control.

NOTE: After exiting installer setup mode, change the setpoint to the desired room temperature.

CHECKOUT

Heating

CAUTION

To avoid possible compressor damage, allow the compressor to remain off for five minutes before restarting.

- Slide the SYSTEM switch to Heat and the FAN switch to Auto.
- Press and hold the ▲ key to raise the temperature setting several degrees above the room temperature. After approximately five minutes, the heating equipment should start.
- Press the ▼ key to lower the temperature setting below the room temperature. Heating equipment should stop.

Cooling

CAUTION

Do not operate cooling if outdoor temperature is below 50°F (10°C). Refer to equipment manufacturer instructions.

To avoid possible compressor damage, allow the compressor to remain off for five minutes before restarting.

- Slide the SYSTEM switch to Cool and the FAN switch to Auto.
- Press the ▼ key to lower the temperature setting several degrees below the room temperature. After approximately five minutes, the cooling equipment and fan should start.
- Press the ▲ key to raise the temperature setting above the room temperature. Cooling system should shut down.

Fan

- Slide the SYSTEM switch to Off and the FAN switch to On. The fan should run continuously.
- Slide the FAN switch to Auto. The system turns the fan on or off with the equipment.

Make certain all equipment responds properly to the thermostat.

Honeywell

Helping You Control Your World®

Home and Building Control

Honeywell Inc.
Honeywell Plaza
P.O. Box 524
Minneapolis, MN 55408-0524

Home and Building Control

Honeywell Limited-Honeywell Limitée
155 Gordon Baker Road
North York, Ontario
M2H 3N7

Free Manuals Download Website

<http://myh66.com>

<http://usermanuals.us>

<http://www.somanuals.com>

<http://www.4manuals.cc>

<http://www.manual-lib.com>

<http://www.404manual.com>

<http://www.luxmanual.com>

<http://aubethermostatmanual.com>

Golf course search by state

<http://golfingnear.com>

Email search by domain

<http://emailbydomain.com>

Auto manuals search

<http://auto.somanuals.com>

TV manuals search

<http://tv.somanuals.com>