

TrueDRY™ DR90

PROFESSIONAL INSTALLATION GUIDE

INCLUDED IN THIS BOX

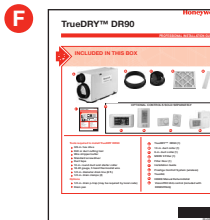

OPTIONAL CONTROLS SOLD SEPARATELY



Tools required to install TrueDRY DR90

- ▶ 3/8-in. hex drive
- ▶ Drill or duct cutting tool
- ▶ Wire stripper/cutter
- ▶ Standard screwdriver
- ▶ Duct tape
- ▶ 10-in. round duct and starter collar
- ▶ 18-22 gauge, 5 band thermostat wire
- ▶ 1/2-in. diameter drain line (8 ft.)
- ▶ 1/2-in. drain clamps (2)

Options

- ▶ 1/2-in. drain p-trap (may be required by local code)
- ▶ Drain pan

- A** TrueDRY™ DR90 (1)
- B** 10-in. duct collar (1)
- C** 6-in. duct collar (1)
- D** MERV II Filter (1)
- E** Filter Door (1)
- F** Installation Guide
- G₁** Prestige Comfort System (wireless)
- G₂** TrueIAQ
- G₃** H8908 Manual Dehumidistat
- G₄** VisionPRO IAQ control (included with DR90VPIAQ)



Installation Checklist

Included in This Box

- A TrueDRY™ DR90 (1)
- B 10-in. duct collar (2)
- C 6-in. duct collar (1)
- D MERV II Filter (1)
- E Filter Door (1)
- F Installation Guide

Control Options (Sold separately)

- G1 Prestige Comfort System
- G2 True IAQ
- G3 H8908 Manual Dehumidistat
- G4 VisionPro IAQ Control
(included with DR90VPIAQ)

Tools Required (Not Supplied)

- 3/8-in. hex drive
- Drill or duct cutting tool
- Wire stripper/cutter
- Standard screwdriver
- Duct tape
- 10-in. round duct and starter collar
- 18-22 gauge, 5 band thermostat wire
- 1/2-in. diameter drain line (8 ft.)
- 1/2-in. drain clamps (2)

Options

- 1/2-in. drain p-trap (may be required by local code)
- Drain pan



Warning: Installation must be performed by a qualified service technician and must comply with local codes.

Remove power to the device before installing or servicing the device.

Failure to connect the device according to these instructions may result in damage to the device or the controls.

INSTALLATION INSTRUCTIONS

BEGIN ON PAGE 1

ABOUT YOUR NEW DEHUMIDIFIER

| | |
|----------------------------------|---|
| Benefits | 2 |
| Maintaining Ideal Humidity | 2 |
| Control Options | 3 |
| Specifications..... | 4 |

INSTALLATION

| | |
|--------------------------------------|----|
| Install to Fit Your Application..... | 5 |
| Plumbing..... | 6 |
| Terminal Description..... | 7 |
| Wiring | 7 |
| Checkout..... | 10 |

MAINTENANCE

| | |
|--|----|
| Cleaning | 10 |
| Technical Description..... | 11 |
| Troubleshooting | 11 |
| Refrigerant Charging | 12 |
| Compressor/Capacitor Replacement | 12 |
| Parts List..... | 13 |
| 5-Year Limited Warranty..... | 14 |

- The TrueDRY™ DR90 is designed to be installed indoors in a space that is protected from rain and flooding.
- Install the unit with space to access the front panel for maintenance and service.
- Avoid directing the discharge air at people, or over the water in pool areas.
- If used near a pool or spa, be certain there is no chance the unit could fall into the water or be splashed, and that it is plugged into a ground fault interrupt (GFI) outlet.
- To ensure quiet operation, do not place the device directly on the structural supports of the home.
- A drain pan must be placed under the unit if installed above a living area or above an area where water leakage could cause damage.



NEED HELP? For assistance with this product please visit <http://yourhome.honeywell.com> or call Honeywell Customer Care toll-free at 1-800-468-1502.

Read and save these instructions.

About the TrueDRY™ DR90 Dehumidifier

The Honeywell TrueDRY DR90 ensures the home is maintained at proper humidity levels through its high performance and efficiency.

Benefits

- Removes up to 90 pints of water per day from the indoor air.
- Built-in fresh air supply
- Energy Star Rated

Maintaining Ideal Humidity

Dew points and relative humidity (RH) affect the way your body senses heat. Higher humidity levels cause the air to feel much hotter than the actual temperature. When maintained properly, your cooling equipment may not run as much because dehumidified air feels cooler.

Ideal humidity is defined by industry experts* as being between 40-60% on an average annual basis.



WHAT THE AIR FEELS LIKE

HOW HOT THE HEAT-HUMIDITY COMBINATION MAKES IT FEEL.
EXAMPLE: AIR AT 90°F WITH 50% RH FEELS LIKE 96°F TO THE HUMAN BODY!

| | | RELATIVE HUMIDITY (PERCENTAGE) | | | | | | | | | | | | | | | | | | | | | | |
|---|-----|--------------------------------|----|----|----|----|-----|-----|-----|-----|-----|-----|-----|-----|-----|-----|-----|-----|-----|-----|-----|-----|----|---|
| | | 0 | 5 | 10 | 15 | 20 | 25 | 30 | 35 | 40 | 45 | 50 | 55 | 60 | 65 | 70 | 75 | 80 | 85 | 90 | 95 | 100 | | |
| AIR TEMPERATURE (DEGREES FAHRENHEIT) | 100 | 91 | 93 | 95 | 97 | 99 | 101 | 104 | 107 | 110 | 115 | 120 | 126 | 132 | 138 | 144 | | | | | | | | <div style="display: flex; flex-direction: column; align-items: center;"> <div style="width: 15px; height: 15px; background-color: red; margin-bottom: 5px;"></div> EXTREME DANGER <div style="width: 15px; height: 15px; background-color: orange; margin-bottom: 5px;"></div> DANGER <div style="width: 15px; height: 15px; background-color: lightorange; margin-bottom: 5px;"></div> EXTREME CAUTION <div style="width: 15px; height: 15px; background-color: peachpuff; margin-bottom: 5px;"></div> CAUTION </div> |
| | 95 | 87 | 88 | 90 | 91 | 93 | 94 | 96 | 98 | 101 | 104 | 107 | 110 | 114 | 118 | 124 | 130 | 136 | | | | | | |
| | 90 | 83 | 84 | 85 | 86 | 87 | 88 | 90 | 91 | 93 | 95 | 96 | 98 | 100 | 102 | 106 | 109 | 113 | 117 | 122 | | | | |
| | 85 | 78 | 79 | 80 | 81 | 82 | 83 | 84 | 85 | 86 | 87 | 88 | 89 | 90 | 91 | 93 | 95 | 97 | 99 | 102 | 105 | 108 | | |
| | 80 | 73 | 74 | 75 | 76 | 77 | 77 | 78 | 79 | 79 | 80 | 81 | 81 | 82 | 83 | 85 | 86 | 86 | 87 | 88 | 89 | 91 | | |
| | 75 | 69 | 69 | 70 | 71 | 72 | 72 | 73 | 73 | 74 | 74 | 75 | 75 | 76 | 76 | 77 | 77 | 78 | 78 | 79 | 79 | 80 | | |
| | 70 | 64 | 64 | 65 | 65 | 66 | 66 | 67 | 67 | 68 | 68 | 69 | 69 | 70 | 70 | 70 | 71 | 71 | 71 | 71 | 71 | 71 | 72 | |

SOURCE: TEMPERATURE - HUMIDITY INDEX WAS DERIVED BY R.G. STEADMAN, JOURNAL OF APPLIED METEOROLOGY, JULY 1979. M27328

When indoor humidity exceeds 60%, the home is more susceptible to mold and mildew growth. TrueDRY DR90 safeguards against excessive humidity in the home year-round.

*American Society of Heating, Refrigerating and Air Conditioning Engineers (ASHRAE).

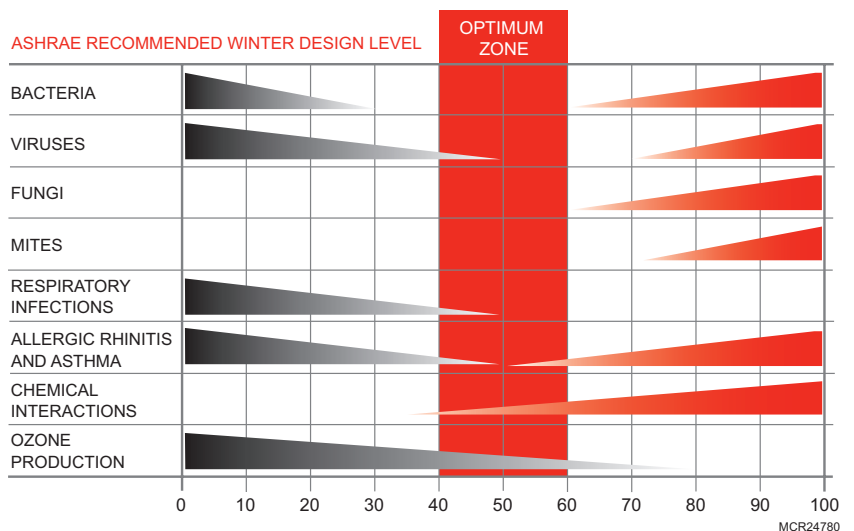

Control Options

The TrueDRY DR90 may be used with one of the following external controls:



Prestige™ Comfort System

- Controls both heating/cooling and dehumidification.
- Shows actual and desired humidity on an intuitive digital display.
- Wireless sensor for displaying outdoor temperature and humidity.
- Maintenance and service reminders.
- High definition color display.



VisionPRO IAQ Total Comfort System (YTH9421C1010)

- Controls both heating/cooling and dehumidification.
- Sensor included for displaying outdoor temperature.
- Intuitive user interface for easy 7-day temperature programming.
- Easy-to-read backlit digital display.
- Maintenance and service reminders.
- Controls other indoor air quality equipment.



TrueIAQ Digital Control (DG115EZIAQ)

- Automatic adjustments maintain ideal humidity.
- Sensor for displaying outdoor temperature and humidity.
- Shows actual and desired humidity settings.
- Advanced ventilation programming includes economizing and extreme condition shutdown.
- Maintenance and service reminders.
- Controls other indoor air quality equipment.



Manual Dehumidistat (H8908DSPST) and Automatic Ventilation Controls (W8150A1000)

- Manual humidity control with intuitive comfort settings.
- Integrated humidity chart for accurate control in changing outdoor conditions.
- Automatic W8150 ventilation control to ASHRAE standard, or for continuous operation.

Specifications

Install TrueDRY DR90 according to National Electric Codes.

| Dry-Bulb Temp | Intake Humidity | Capacity (Pints/Day) |
|---------------|-----------------|----------------------|
| 80°F | 60% RH | 90 |
| 70°F | 60% RH | 77 |
| 60°F | 60% RH | 47 |

| Home Size (square ft) | Dehumidifier Capacity Required to Maintain Desired Indoor RH* | | |
|-----------------------|---|---------------------------|---------------------------|
| | 60% RH Indoor (pints/day) | 50% RH Indoor (pints/day) | 40% RH Indoor (pints/day) |
| 2080 | 49–54 | 55–58 | 71–78 |
| 2600 | 61–68 | 65–72 | 90–97 |
| 3120 | 75–82 | 79–86 | 95–110 |

* Based on extreme climates where outdoor humidity is 70-90% RH. For less extreme climates, larger homes can be adequately served with less capacity. Actual requirements may vary.

Dimensions in inches and (mm):

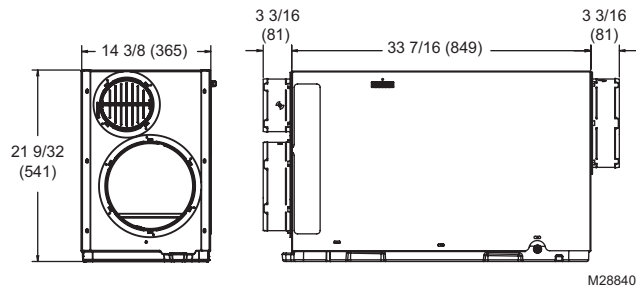

Airflow versus external static pressure (0–1 in. water pressure) with collars attached

| | |
|---------|---------|
| 0 in. | 235 CFM |
| 0.2 in. | 210 CFM |
| 0.4 in. | 195 CFM |
| 0.6 in. | 175 CFM |

Product weight: 92.2 lbs.

Shipping weight: 102 lbs.

Shipping dimensions: 21.5 in. H x 18.5 in. W x 40.2 in. L

Media Filter: MERV 11, 13.75 in. H x 13.75 in. W x .75 in. D

Drain connection: 3/4-in. threaded female NPT connection, with attached 3/4-in. male connection.

Duct connections: 10-in. round inlet and outlet. 6-in. supply inlet. ABS plastic, compatible for connection to rigid or flexible ducting with sheet metal screws and/or tape.

Cabinet: 20 gauge galvanized steel powder-coat painted.

Insulation: R value 1

Compressor: Rotary-style, 6.8 KBTU

Refrigerant: R-410A, 1.0 lbs.

Operating Temp Range (outside cabinet):

34°F to 135°F (1.1°C to 57.2°C)

Operating Humidity Range: 0-99% RH

Input ratings

- Electrical input voltage: 120 VAC, 60 Hz nominal
- Input current: 6.7 amps

Output ratings

- Power transformer to R/C terminals: 24 VAC, 0.85 A
- Energy Performance: 2.5 liters (5.3 pints) per kilowatt hour (KWH)

Standards and approval body requirements

ETL Tested per standard UL 474 ducted dehumidifier.

ENERGY STAR rated.

Install to Fit Your Application

Flex duct is recommended in connecting to the TrueDRY DR90 collars to reduce vibration noise.



Duct Sizing: Use minimum 10-in. diameter round for duct lengths up to 25 ft. Minimum 12-in. required for lengths longer than 25 ft. Duct branches from the main inlet/exhaust should be minimum 10-in. round for 2-3 branches, and 12-in. round or larger for 4 branches or more.

For the optional fresh air ventilator port, use 6-in. round, insulated duct for lengths up to 50 ft. Use 8-in. round duct for more than 50 ft. of if more than 100 CFM is required.

Isolated Areas: Effective dehumidification may require ducting to isolated or stagnant air flow areas.

Electrical requirements:

115 VAC outlet. Ground fault interrupter (GFI) recommended.

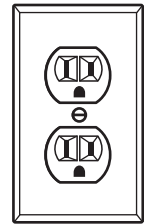

M24745

A Main Return to Main Return

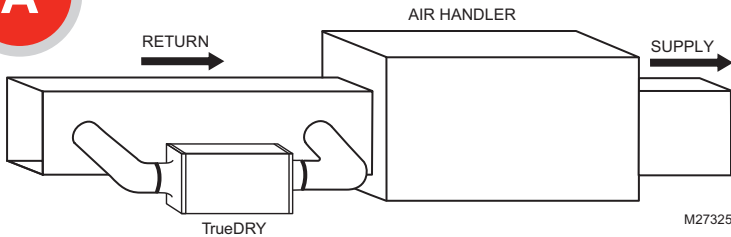

Ideal when...

- Running TrueDRY DR90 with A/C operation.
- Minimizing discharge air temperature (DAT) increase is preferred.
- Space dictates.

B Main Return to Main Supply

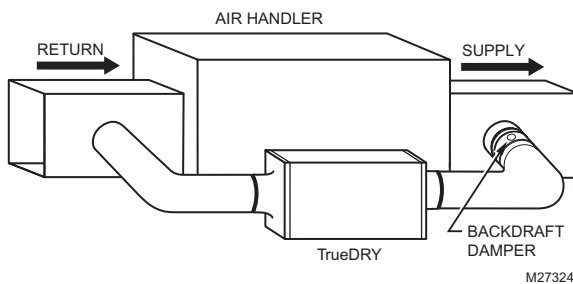

Ideal when...

- Running TrueDRY DR90 opposite A/C operation. Running with A/C operation requires damper on the exhaust port to minimize backdraft when TrueDRY DR90 is not on but A/C is.
- Space dictates.

Install to Fit Your Application (continued)

C

Dedicated Return to Main Supply

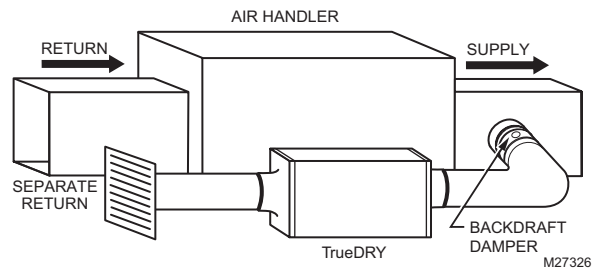

Ideal when...

- Drying a specific area of the house.
- Running with A/C operation requires backdraft damper on the exhaust port to minimize backdraft when TrueDRY DR90 is not on but A/C is.

D

Dedicated Return to Main Return

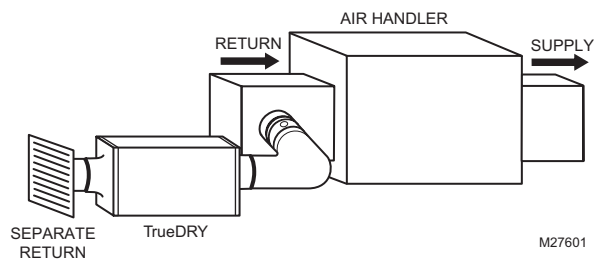

Ideal when...

- Drying a specific conditioned or unconditioned area, such as attic, basement, or crawl space.
- Running with A/C operation.
- Minimizing DAT is preferred.

Plumbing

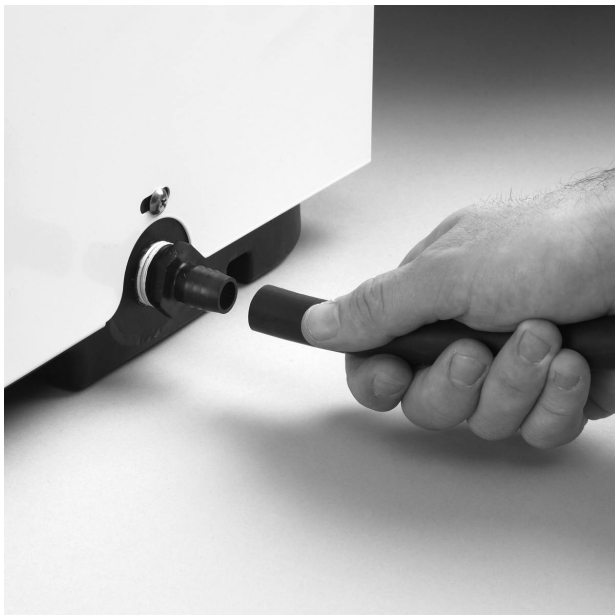

Connect 1/2-in. drain tube to male connection drain outlet. Secure drain tube to connector with hose clamp.

Run drain hose continuously downhill to an approved drain or condensate pump.

Wiring (continued)

Follow this diagram for ducted operation with an external humidity control.

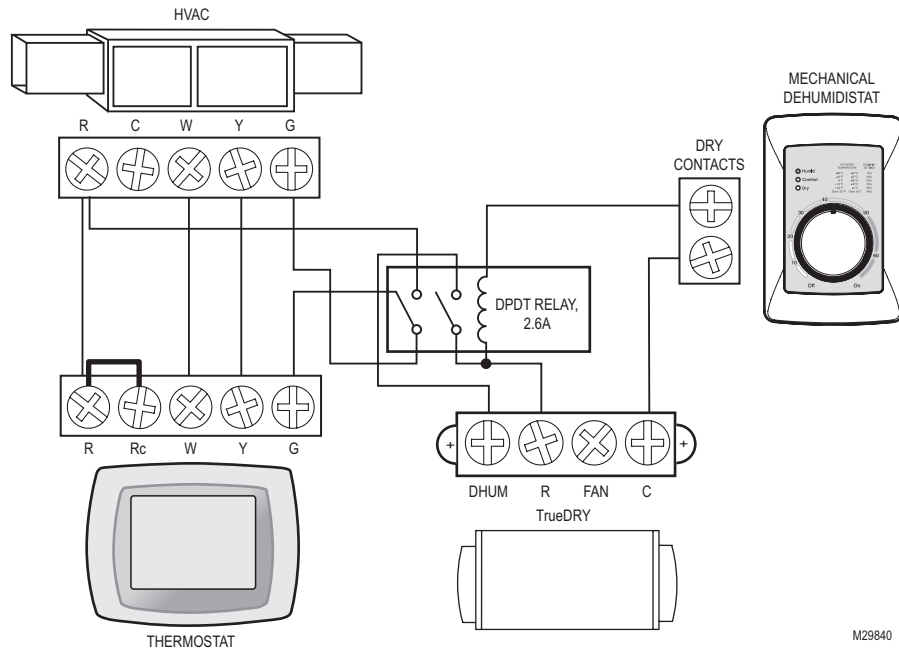

M29840

Follow this diagram for ducted operation with external humidity and ventilation control.

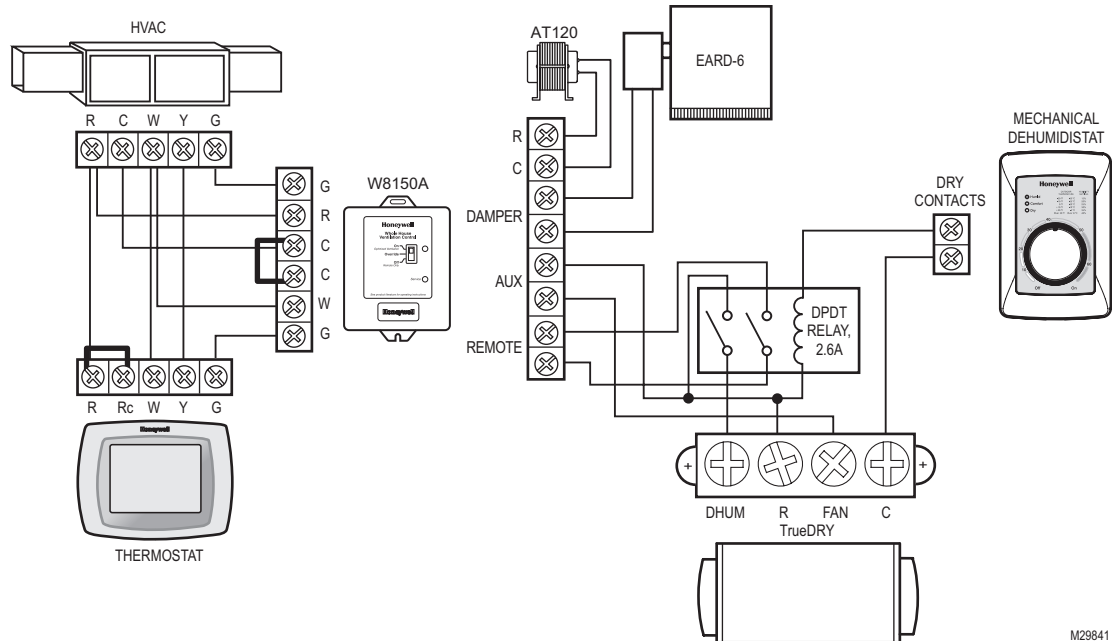

M29841

Wiring (continued)

Follow this diagram if using TrueDRY DR90 with a powered dehumidistat such as TruelAQ (DG115EZIQ).

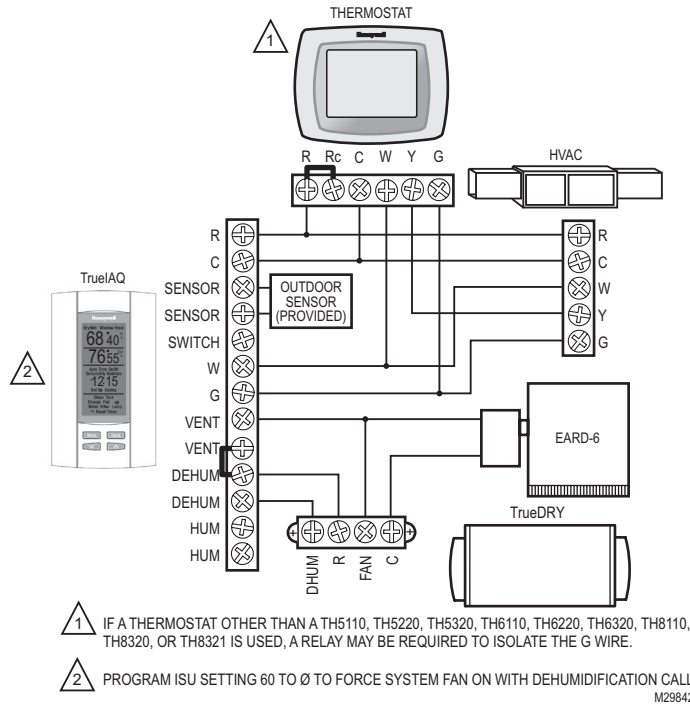

Follow this diagram if using TrueDRY DR90 with a VisionPRO IAQ.

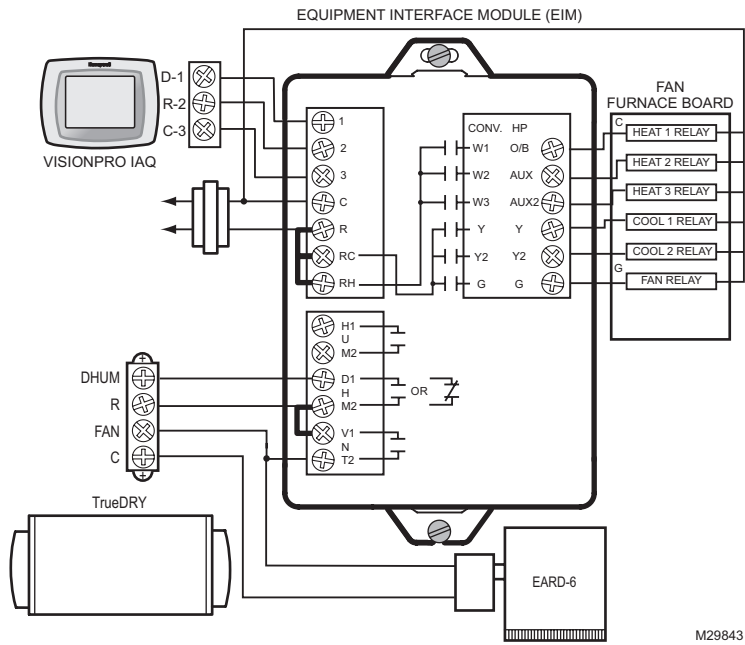

Checkout

Apply power to TrueDRY DR90. Turn the humidity control to a low RH% level to initiate a dehumidification call. Confirm that the TrueDRY DR90 compressor and fan turn on. The furnace blower will also turn on to circulate air. This will take up to two minutes. Be sure to turn the control to the desired RH% or to Off when checkout is complete.

Cleaning

On an annual basis, maintenance is required to ensure TrueDRY runs at peak efficiency.

1

Unplug TrueDRY DR90 before beginning service. Remove the magnetic filter door.



2

Remove filter (50049537-005) and replace with new filter.



3

Remove the panels on each side of the TrueDRY DR90. Using a damp cloth, wipe excess dust and debris from blower, refrigerant coils, and compressor coils. Reattach cabinet panels when finished.

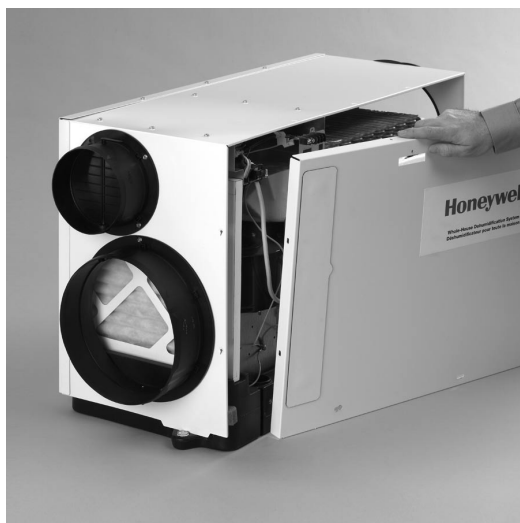

4

Check the drain connection and drain line to ensure it is clear of debris and sludge. Ensure all hose connections are secure once maintenance of the drain lines is complete.

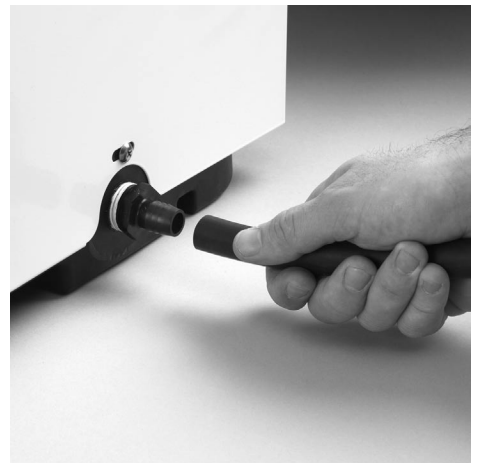

5

When service is complete, initiate a call for dehumidification and check that the compressor and fan activate. If using the VisionPRO IAQ or TrueIAQ controls, reset maintenance reminders.

Technical Description

TrueDRY DR90 uses a refrigeration system similar to an air conditioner to remove heat and moisture from incoming air and add heat to the air that is discharged. Hot, high-pressure refrigerant gas is routed from the compressor to the condenser coil. The refrigerant is cooled and condensed by giving up its heat to the air that is about to be discharged from the unit. The refrigerant liquid then passes through a filter drier and capillary tubing which causes the refrigerant pressure and temperature to drop. It next enters the evaporator coil where it absorbs heat from the incoming air and evaporates. The evaporator operates in a flooded condition, which means that all the evaporator tubes contain liquid refrigerant during normal operation. A flooded evaporator should maintain nearly constant pressure and temperature across the entire coil, from inlet to outlet.

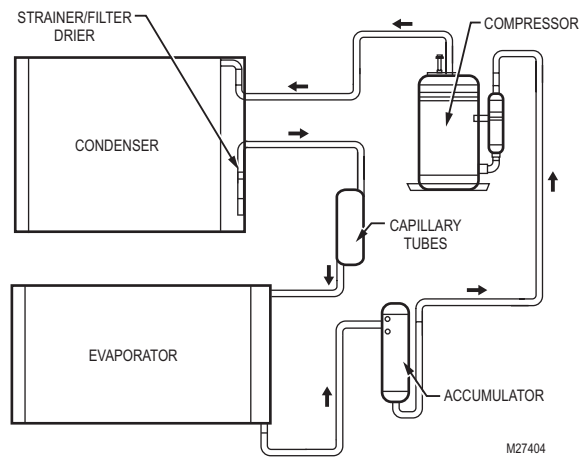

Troubleshooting

 **CAUTION:** Servicing the TrueDRY DR90 with its high pressure refrigerant system and high voltage circuitry presents a health hazard which could result in death, serious bodily injury, and/or property damage. Service should only be performed by a qualified service technician.

| Problem | Recommended Troubleshooting Steps |
|---|---|
| No dehumidification. Neither fan nor compressor run and the ventilation timer is OFF. | <ol style="list-style-type: none"> 1. Unit unplugged or no power to outlet. 2. Humidity control set too high or defective. 3. Loose connection in internal or control wiring. 4. Defective Compressor relay. 5. Defective control transformer. 6. Optional Condensate Pump Safety Switch open. |
| No dehumidification. Compressor does not run but fan runs when there is a call for dehumidification and the ventilation control is OFF. | <ol style="list-style-type: none"> 1. Defective compressor run capacitor. 2. Bad connection in compressor circuit. 3. Defective compressor overload. 4. Defective compressor. 5. Defrost thermostat open. 6. Optional Condensate Pump Safety Switch open. |
| Fan runs when there is a call for dehumidification and the ventilation control is OFF, but the compressor cycles on and off too frequently. | <ol style="list-style-type: none"> 1. Low ambient temperature and/or humidity causing unit to cycle through defrost mode. 2. Defective compressor overload. 3. Defective compressor. 4. Defrost thermostat defective. 5. Dirty air filter(s) or airflow restricted. 6. Low refrigerant charge, causing defrost control to cycle. 7. Bad connection in compressor circuit.. |

Troubleshooting (continued)

| Problem | Recommended Troubleshooting Steps |
|--|--|
| Fan does not run with ventilation activated. Compressor runs briefly but cycles on & off with humidity control turned to ON. | <ol style="list-style-type: none"> 1. Loose connection in fan circuit. 2. Obstruction prevents fan rotation. 3. Defective fan. 4. Defective fan relay. 5. Defective fan capacitor. |
| Evaporator coil frosted continuously, low de-humidifying capacity. | <ol style="list-style-type: none"> 1. Defrost thermostat loose or defective. 2. Low refrigerant charge. 3. Dirty air filter(s) or airflow restricted. |
| Unit not providing ventilation. | <ol style="list-style-type: none"> 1. Check control wire connections (check connections at fresh air damper also). 2. Defective fresh air damper. 3. Dirty air intake. Clean outside intake hood. |
| Unit removes some water, but not as much as expected. | <ol style="list-style-type: none"> 1. Air temperature and/or humidity have dropped. 2. Humidity meter and or thermometer used are out of calibration. 3. Unit has entered defrost cycle. 4. Air filter dirty. 5. Defective defrost thermostat. 6. Low refrigerant charge. 7. Air leak such as loose cover or ducting leaks. 8. Defective compressor. 9. Restrictive ducting. 10. Optional Condensate Pump Safety Switch open. |
| Unit Test to determine problem: | <ol style="list-style-type: none"> 1. Detach field control wiring connections from main unit. 2. Connect the R and FAN contacts from the main unit together; only the impeller fan should run. Disconnect the wires. 3. Connect the R and DHUM contacts from the main unit together; the compressor and impeller fan should run. 4. If these tests work, the main unit is working properly. You should check the control panel and field control wiring for problems next. 5. Remove the control panel from the mounting box and detach it from the field installed control wiring. Connect the blue, yellow, and green wires from the control panel directly to the corresponding colored pigtails on the main unit. Leave the violet, white, and red wires disconnected! 6. Turn on the humidity control. The compressor and impeller fan should run. 7. If these tests work, the problem is most likely in the field control wiring. |

Refrigerant Charging

If the refrigerant charge is lost due to service or a leak, a new charge must be accurately weighed in. If any of the old charge is left in the system, it must be recovered before weighing in the new charge. Refer to the unit nameplate for the correct charge weight and refrigerant type.

Compressor/Capacitor Replacement

This compressor is equipped with a two terminal external overload and a run capacitor, but no start capacitor or relay.

Parts List

| Figure Reference | Description | Part Number |
|------------------|-------------------------------------|---------------|
| 1 | TrueDRY with no controls | DR90A1000 |
| 2 | TrueDRY with VisionPRO IAQ Control | DR90VPIAQ |
| 3 | Prestige Comfort System | YTHX9321R5003 |
| 4 | VisionPRO IAQ Total Comfort Control | YTH9421C1010 |
| 5 | TrueIAQ Digital IAQ Control | DG115EZIAQ |
| 6 | H8908D Manual Dehumidistat | H8908DSPST |
| 7 | Automatic ventilation control | W8150A1001 |
| 8 | Motorized ventilation damper | EARD 6 |
| | Compressor run capacitor | 50049536-001 |
| | Blower assembly | 50027976-001 |
| 9 | Filter | 50049536-003 |
| 10 | 6-in. Duct collar | 50049536-004 |
| 11 | 10-in. Duct collar | 50049536-005 |
| 12 | Magnetic door | 50049536-006 |
| | Compressor relay, SPST, 24 Vac, 30A | 50035445-014 |
| | Fan relay, SPDT, 24 Vac, 15A | 50035445-011 |
| | Transformer 120/24 Vac, 40 VA | 50035445-013 |

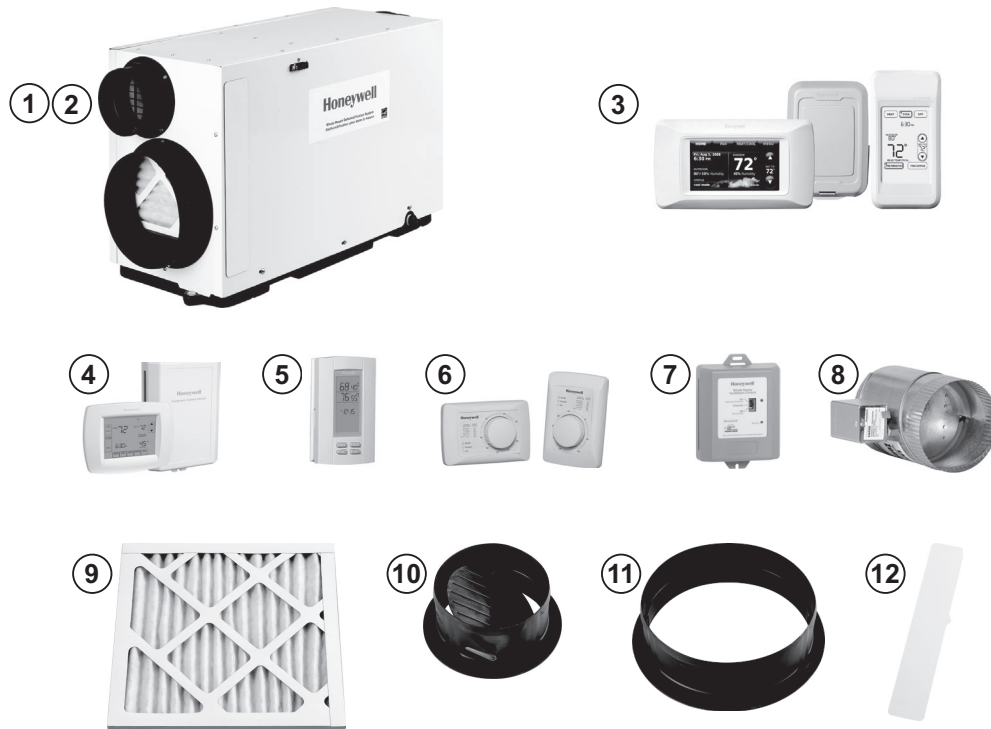

M28837

5-Year Limited Warranty

Honeywell warrants this product to be free from defects in the workmanship or materials, under normal use and service, for a period of five (5) years from the date of purchase by the consumer. If at any time during the warranty period the product is determined to be defective or malfunctions, Honeywell shall repair or replace it (at Honeywell's option).

If the product is defective,

- (i) return it, with a bill of sale or other dated proof of purchase, to the place from which you purchased it; or
- (ii) call Honeywell Customer Care at 1-800-468-1502. Customer Care will make the determination whether the product should be returned to the following address: Honeywell Return Goods, Dock 4 MN10-3860, 1885 Douglas Dr. N., Golden Valley, MN 55422, or whether a replacement product can be sent to you.

This warranty does not cover removal or reinstallation costs. This warranty shall not apply if it is shown by Honeywell that the defect or malfunction was caused by damage which occurred while the product was in the possession of a consumer.

Honeywell's sole responsibility shall be to repair or replace the product within the terms stated above. HONEYWELL SHALL NOT BE LIABLE FOR ANY LOSS OR DAMAGE OF ANY KIND, INCLUDING ANY INCIDENTAL OR CONSEQUENTIAL DAMAGES RESULTING, DIRECTLY OR INDIRECTLY, FROM ANY BREACH OF ANY WARRANTY, EXPRESS OR IMPLIED, OR ANY OTHER FAILURE OF THIS PRODUCT. Some states do not allow the exclusion or limitation of incidental or consequential damages, so this limitation may not apply to you.

THIS WARRANTY IS THE ONLY EXPRESS WARRANTY HONEYWELL MAKES ON THIS PRODUCT. THE DURATION OF ANY IMPLIED WARRANTIES, INCLUDING THE WARRANTIES OF MERCHANTABILITY AND FITNESS FOR A PARTICULAR PURPOSE, IS HEREBY LIMITED TO THE FIVE-YEAR DURATION OF THIS WARRANTY. Some states do not allow limitations on how long an implied warranty lasts, so the above limitation may not apply to you.

This warranty gives you specific legal rights, and you may have other rights which vary from state to state.

If you have any questions concerning this warranty, please write Honeywell Customer Relations, 1985 Douglas Dr, Golden Valley, MN 55422 or call 1-800-468-1502. In Canada, write Retail Products ON15-02H, Honeywell Limited/Honeywell Limitée, 35 Dynamic Drive, Toronto, Ontario M1V4Z9.

Automation and Control Solutions

Honeywell International Inc.
1985 Douglas Drive North
Golden Valley, MN 55422

Honeywell Limited-Honeywell Limitée
35 Dynamic Drive
Toronto, Ontario M1V 4Z9

<http://yourhome.honeywell.com>

© U.S. Registered Trademark.
© 2010 Honeywell International Inc.
69-2407—01 M.S. 01-10
Printed in U.S.A

The Honeywell logo is displayed in a bold, red, sans-serif font.

Free Manuals Download Website

<http://myh66.com>

<http://usermanuals.us>

<http://www.somanuals.com>

<http://www.4manuals.cc>

<http://www.manual-lib.com>

<http://www.404manual.com>

<http://www.luxmanual.com>

<http://aubethermostatmanual.com>

Golf course search by state

<http://golfingnear.com>

Email search by domain

<http://emailbydomain.com>

Auto manuals search

<http://auto.somanuals.com>

TV manuals search

<http://tv.somanuals.com>