

Honeywell

**UDC 700 Micro-Pro
Universal Digital Controller**

Product Manual

EN11-6226

Contents

1	FRONT PANEL	1-1
2	INSTALLATION - PANEL-MOUNTING	2-1
3	INSTALLATION - WIRING CONNECTIONS	3-1
4	INSTRUMENT CONFIGURATION	4-1
5	CALIBRATION MODE	5-1
APPENDICES		
A	MODBUS COMMUNICATIONS	A-1

ELECTROMAGNETIC INTERFERENCE AND SAFETY

EMI Susceptibility:	Certified to EN50082-1:1992 and EN50082-2:1995. NOTE: For line-conducted disturbances induced by RF fields (10V 80% AM 1kHz), the product is self-recoverable in the frequency band 9.4MHz to 1.5MHz.
EMI Emissions:	Certified to EN50081-1:1992 and EN50081-2:1994.
Safety Considerations:	Complies with EN61010:1993/A2:1995.

1 FRONT PANEL

1.1. INDICATORS



Green: OFF = $PV < SP$; ON = $PV = SP$; Flashing = $PV > SP$



Yellow: OFF = Normal operation; ON = Control Setup;
Flashing = Instrument Configuration



Red: Flashes when alarm(s) active.

1.2. KEYS

Scroll key

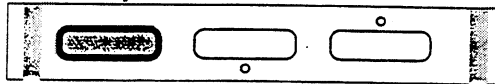

All Modes except Calibration:
If parameter value is displayed, shows parameter legend (for 1.5 seconds). If legend displayed, shows value of next parameter.

Calibration:
Starts calibration phase.

Down key

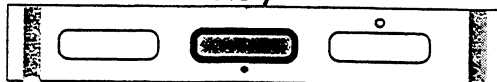

Normal Operation:
Decrements parameter value. With PV displayed, dis-engages Pre-Tune. Also confirms request for entry into *Instrument Configuration*.

Control Setup/Instrument Configuration:
Decrements parameter value.

Calibration:
Steps to previous calibration phase.

Up key

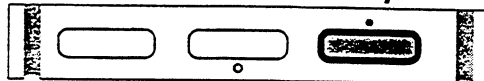

Normal Operation:
Increments parameter value. With PV displayed, requests Pre-Tune.

Control Setup/Instrument Configuration:
Increments parameter value.

Calibration:
Steps to next calibration phase.

Scroll and Down keys

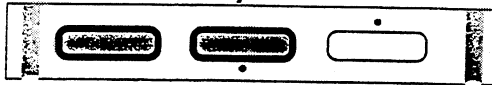

Normal Operation:
Enters *Calibration Mode*.

Scroll and Up keys

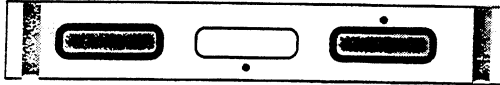

Normal Operation:
Requests entry into *Instrument Configuration*

Down and Up keys

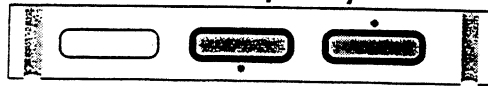

Normal Operation:
Enters *Control Setup*.

Control Setup/Instrument Configuration/Calibration:
Returns to *Normal Operation*.

2 INSTALLATION - PANEL-MOUNTING

2.1. UNPACKING THE INSTRUMENT

1. Remove the Controller from its packing. A panel gasket and a "no tools required" clamp are supplied. Retain the packing for future use (e.g. moving the Controller to a different site).

2. Examine the delivered items for damage or deficiencies. If any is found, notify the carrier immediately.

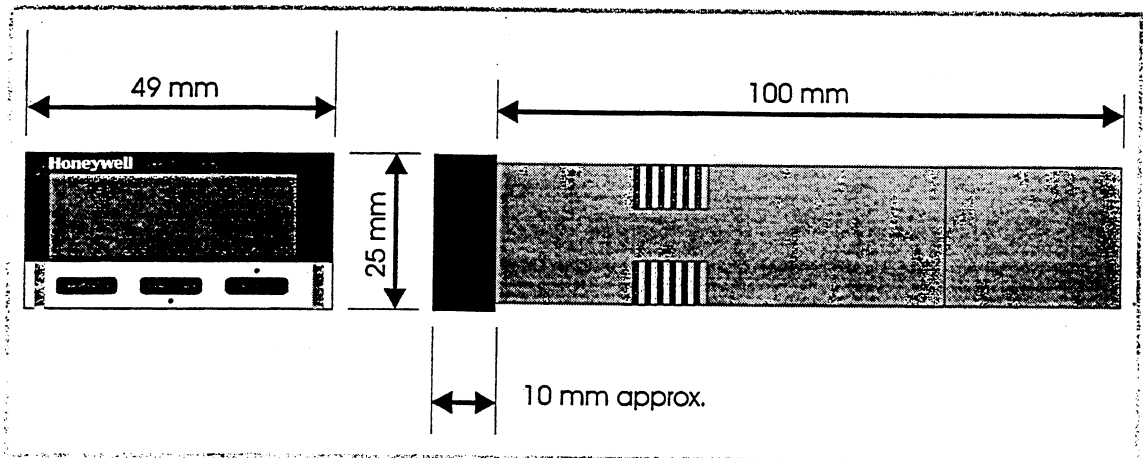

Figure 2-1 Main Dimensions

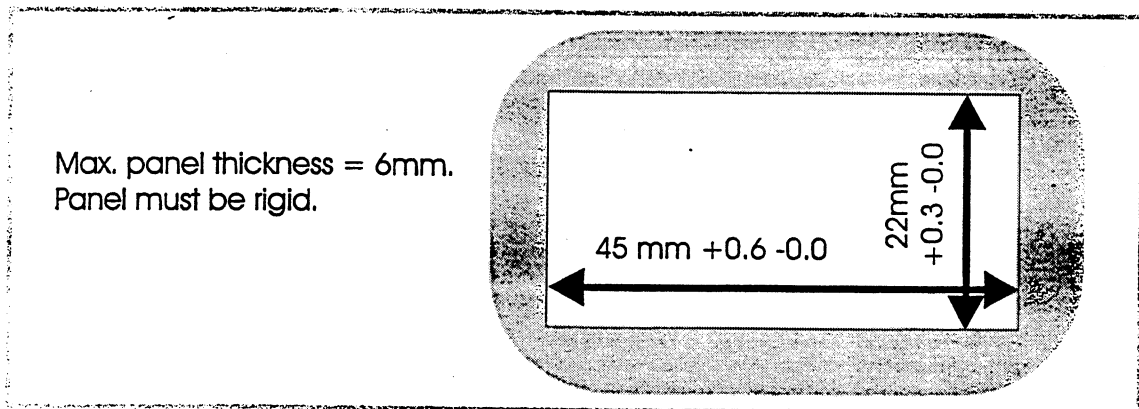
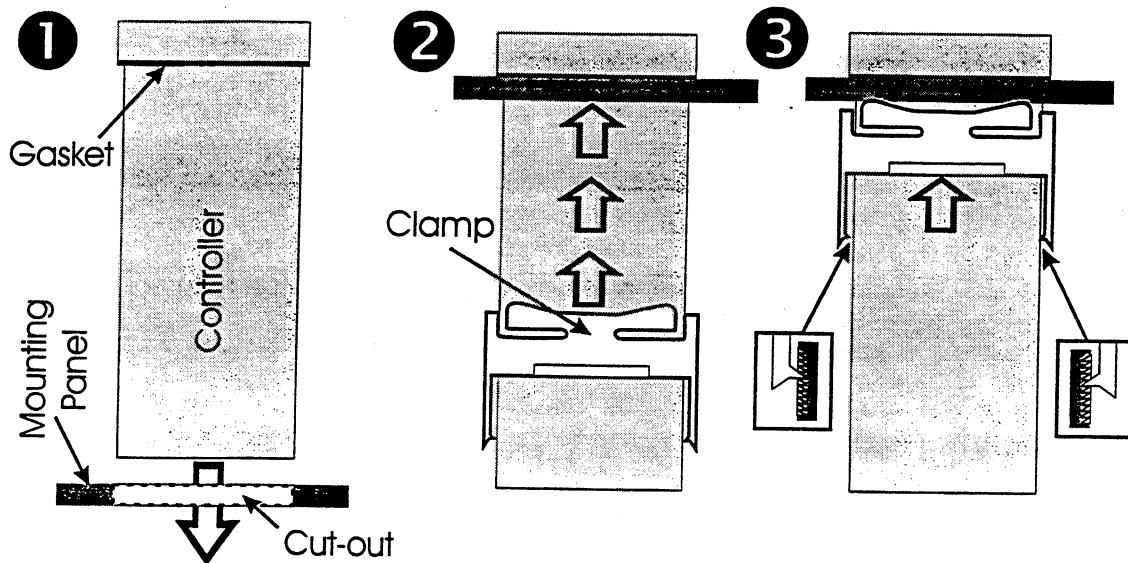

Figure 2-2 Cut-out Dimensions

2.2. INSTALLING THE CONTROLLER IN THE MOUNTING PANEL



CAUTION: Do not remove the front panel gasket from the Controller, as this may cause inadequate clamping of the Controller to the mounting panel. Ensure that this gasket is not distorted and that the Controller is positioned squarely against the mounting panel. Apply pressure to the front panel bezel only.

3 INSTALLATION - WIRING CONNECTIONS

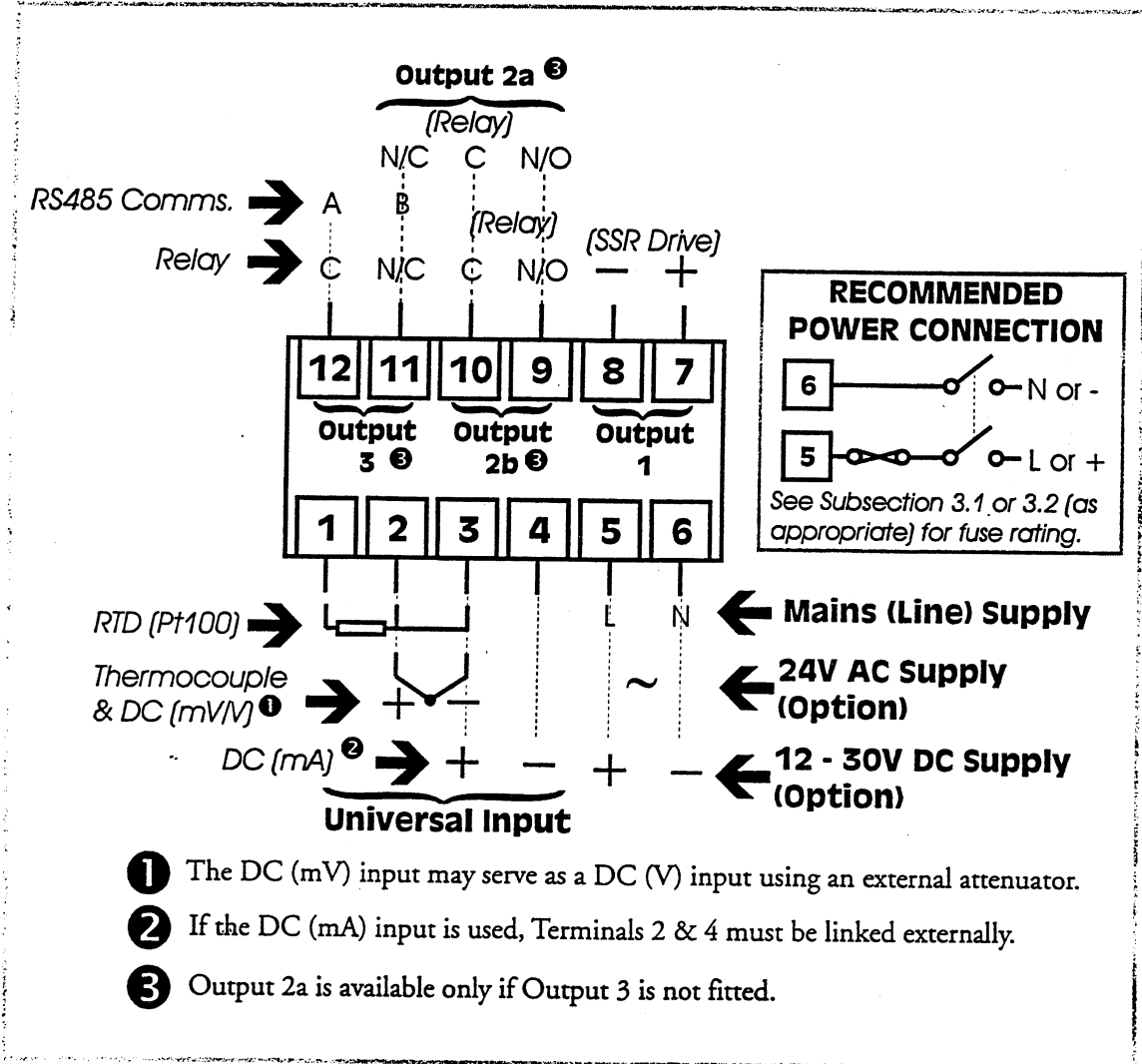

Figure 3-1 Rear Terminal Connections

Table 3-1 Output Usage

Output	Control Output	Alarm 1 Output	Alarm 2 Output	Serial Comms.
Output 1	*	*		
Output 2a	*	*		
Output 2b	*	*		
Output 3			*	*

3.1. MAINS (LINE) SUPPLY

This version will operate on a 96 - 264V AC 50/60Hz mains supply. The power consumption is approximately 4W.

CAUTION: This equipment is designed for installation in an enclosure which provides adequate protection against electric shock. Local regulations regarding electrical installation should be rigidly observed. Consideration should be given to prevention of access to the power terminations by unauthorised personnel. Power should be connected via a two-pole isolating switch (preferably situated near the Controller) and a 1A fuse, as shown in Figure 3-1.

If the contacts of the relay output(s) are used to carry mains voltage, it is recommended that the relay contacts mains supply should be switched and fused in a similar manner but should be separate from the Controller mains supply.

3.2. LOW VOLTAGE (24V AC/DC) SUPPLY

This version operates on 12 - 24V AC 50/60Hz or 12 - 30V DC supply. The power consumption is approximately 4W. Connection should be made via a two-pole isolating switch and a 315mA slow-blow (anti-surge Type T) fuse (see Figure 3-1).

3.3. THERMOCOUPLE INPUT

The correct type of thermocouple extension leadwire or compensating cable must be used for the full distance between the Controller and the thermocouple, ensuring that the correct polarity is observed throughout. Joints in the cable should be avoided, if possible.

NOTE: Do not run thermocouple cables adjacent to power-carrying conductors. If the wiring is run in a conduit, use a separate conduit for the thermocouple wiring. If the thermocouple is grounded, this must be done at one point only. If the thermocouple extension lead is shielded, the shield must be grounded at one point only.

3.4. RTD INPUTS

The compensating lead should be connected to Terminal 3. For two-wire RTD inputs, Terminals 2 and 3 should be linked. The extension leads should be of copper and the resistance of the wires connecting the resistance element should not exceed 5 ohms per lead (the leads should be of equal length).

3.5. DC INPUTS

DC (mV) inputs are connected to Terminals 2 and 3 in the polarity shown in Figure 3-1; DC (V) inputs are connected to the same terminals with the same polarity but require an external attenuator. DC (mA) inputs are connected to Terminals 3 and 4 in the polarity shown in Figure 3-1 with Terminals 2 and 4 linked externally.

3.6. RELAY OUTPUTS (OUTPUTS 2 & 3)

The contacts are rated at 2A resistive at 120/240V AC.

3.7. SSR DRIVE OUTPUT (OUTPUT 1)

This output produces a time-proportioned non-isolated DC signal (0 - 10V nominal, into 500 Ω minimum).

3.8. RS485 COMMUNICATIONS

The "A" terminal (Terminal 12) on the Controller should be connected to the "A" terminal on the master device; the "B" terminal (Terminal 11) on the Controller should be connected to the "B" terminal on the master device. This instrument uses standard RS485 devices, isolated from all other inputs and outputs. The devices present a $\frac{1}{2}$ -unit load to the RS485 line. Generally, termination will not be required but may be necessary for line lengths greater than 100 metres. Where termination is necessary, it is recommended that a 120 Ω resistance in series with a 0.1 μ F capacitor be used at each end of the line (see Figure 3-2).

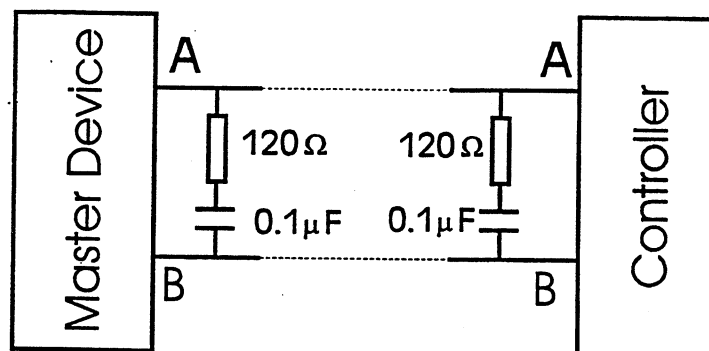
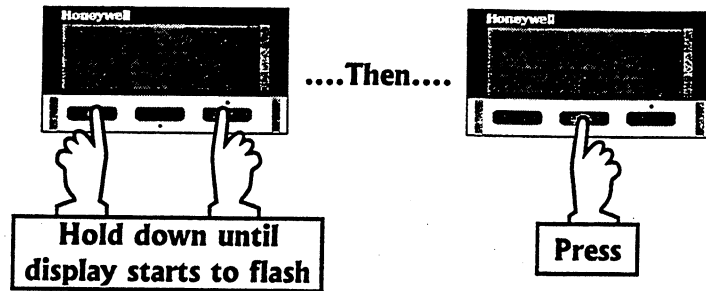

Figure 3-2 RS485 Line Termination

4 INSTRUMENT CONFIGURATION

4.1. ENTRY

To enter Instrument Configuration mode, use the key sequence shown on the right.



4.2. PARAMETER SEQUENCE

Use the Scroll key to step through the parameters, as shown on the right. Use the Up/Down keys to adjust the displayed value. The parameter sequence is shown in Figure 4-1. Adjustment ranges are shown in Table 4-1 and default values are shown in Table 4-4.

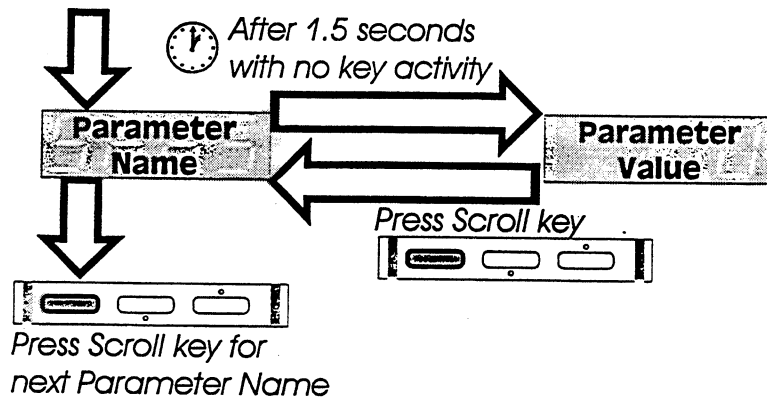

4.3. EXIT

To exit from Instrument Configuration mode, select display of a parameter name, then hold down the Up and Down keys for three seconds (see right). The instrument will then return to Normal Operation Mode via an instrument reset and self-test sequence.

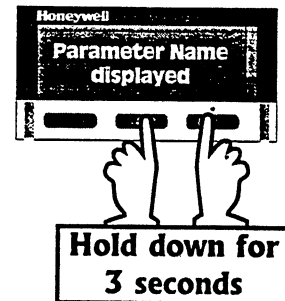

NOTE: If there is no key activity for five minutes in Instrument Configuration Mode, an automatic return is made to Normal Operation Mode (via an instrument reset and self-test sequence).

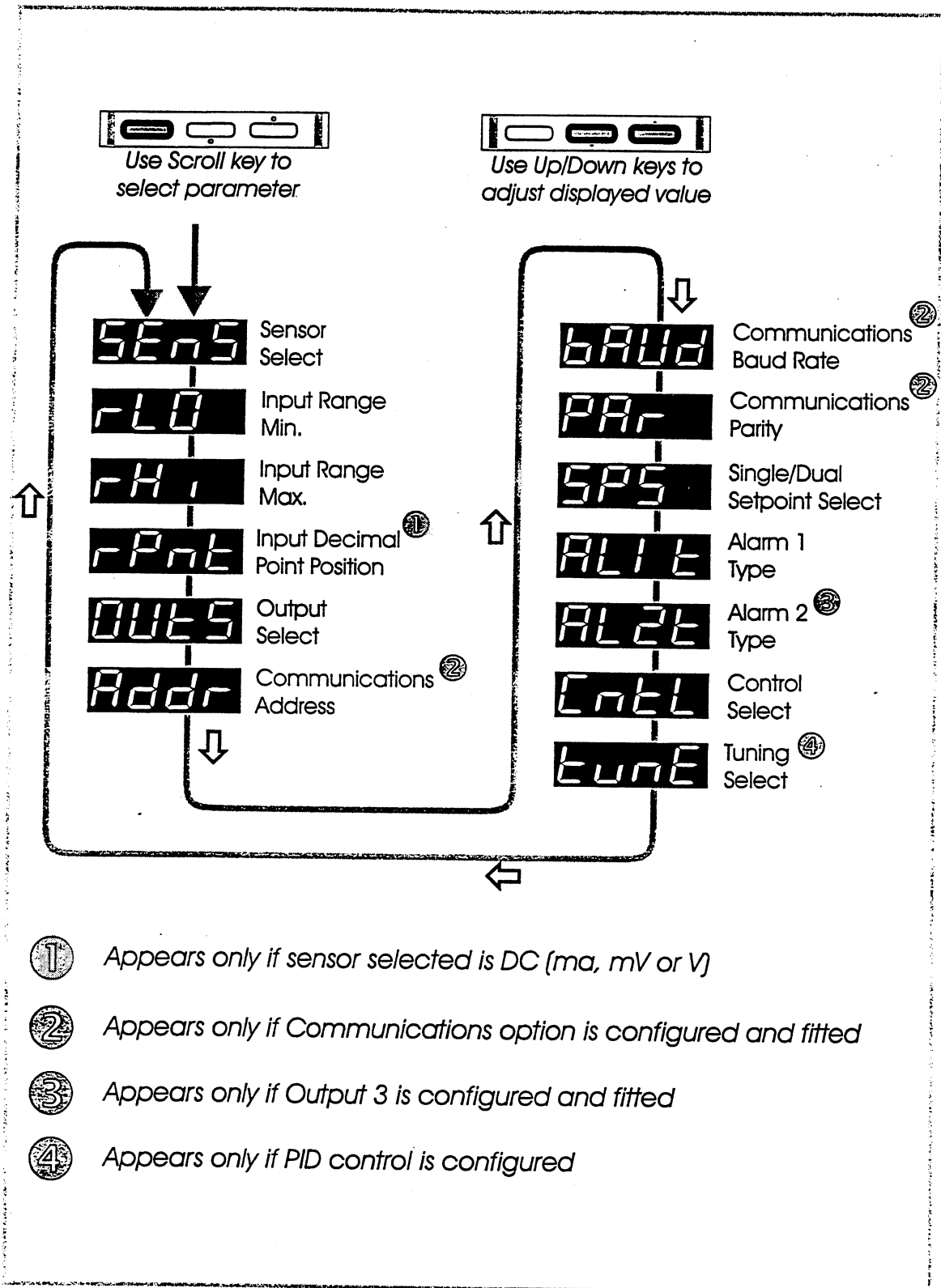

Figure 4-1 Instrument Configuration Parameter Sequence

Table 4-1 Parameter Functions and Adjustment Ranges









Parameter	Function	Adjustment Range
Sensor Select	Selects input sensor type, resolution and input units (°F or °C) by means of a code number.	See Table 4-2.
Input Range Min.	Defines minimum value of input range	Thermocouple/RTD inputs: Range Min. Value for selected sensor (see Table 4-2) to 100 LSDs less than current Input Range Max. setting. DC Inputs: -1999 to 9999 with decimal point set according to <i>Input Range Decimal Point Position</i> parameter.
Input Range Max.	Defines maximum value of input range	Thermocouple/RTD inputs: 100 LSDs greater than current Input Range Min. Setting to Range Max. For selected sensor (see Table 4-2). DC Inputs: -1999 to 9999 with decimal point set according to <i>Input Range Decimal Point Position</i> parameter.
Input Range Decimal Point Position	For DC inputs only, determines decimal point position.	0 (xxx), 1 (xxx.x), 2 (xx.xx) or 3 (x.xxx)
Output Selection	Links outputs to required functions by a 3-digit code (see Figure 4-2).	See Figure 4-2.
Comms. Address	Defines unique communications address of controller	1 to 128.
Comms. Baud Rate	Selects Baud rate for serial communications	 1200  2400  4800  9600
Comms. Parity	Defines parity for serial communications	 Odd  Even  None
Single/Dual Setpoint Select	Selects Single Setpoint or Dual Setpoint operation	 Single  Dual

Table 4-1 (Cont.) Parameter Functions and Adjustment Ranges

Parameter	Function	Adjustment Range
Alarm 1 Type	Selects type of alarm for Alarm 1.	<p>PHd Process High, direct-acting</p> <p>PLd Process Low, direct-acting</p> <p>dEd Deviation, direct-acting</p> <p>bAd Band, direct-acting</p> <p>PHr Process High, reverse-acting</p> <p>PLr Process Low, reverse-acting</p> <p>dEr Deviation, reverse-acting</p> <p>bAr Band, reverse-acting</p>
Alarm 2 Type	Selects type of alarm for Alarm 2.	As for Alarm 1 Type.
Control Select	Selects the control action and algorithm	<p>r_P Reverse-acting PID</p> <p>d_P Direct-acting PID</p> <p>r_o Reverse-acting ON/OFF</p> <p>d_o Direct-acting ON/OFF</p>
Tuning Select	Selects Manual Tuning or Hands-Off Tuning (Easy Tune)	<p>EASY Easy Tune</p> <p>MAN Manual Tuning (with Pre-Tune)</p>

Table 4-2 Sensor Selection Codes

Input Type	Code	Range Min.	Range Max.
Thermocouple			
Type J	100 (°C) 101 (°F) 110 (°C) 111 (°F)	-200°C -328°F -128.0°C -198.4°F	1200°C 2191°F 537.0°C 998.5°F
Type T	200 (°C) 201 (°F) 210 (°C) 211 (°F)	-240°C -400°F -128.0°C -198.4°F	401°C 753°F 400.6°C 753.0°F
Type K	300 (°C) 301 (°F) 310 (°C) 311 (°F)	-240°C -400°F -128.0°C -198.4°F	1371°C 2499°F 536.7°C 998.0°F
Type N	400 (°C) 401 (°F)	0°C 32°F	1399°C 2550°F
Type B	500 (°C) 501 (°F)	100°C 211°F	1824°C 3315°F
Type R	600 (°C) 601 (°F)	0°C 32°F	1759°C 3198°F
Type S	700 (°C) 701 (°F)	0°C 32°F	1770°C 3217°F
RTD (Pt100)			
	800 (°C) 801 (°F) 810 (°C) 811 (°F)	-199°C -327°F -127.9°C -198.3°F	802°C 1475°F 537.0°C 998.5°F
DC Linear			
0 - 20mA	900	-1999	9999
4 - 20mA	1000	-1999	9999
0 - 50mV	2000	-1999	9999
10 - 50mV	3000	-1999	9999

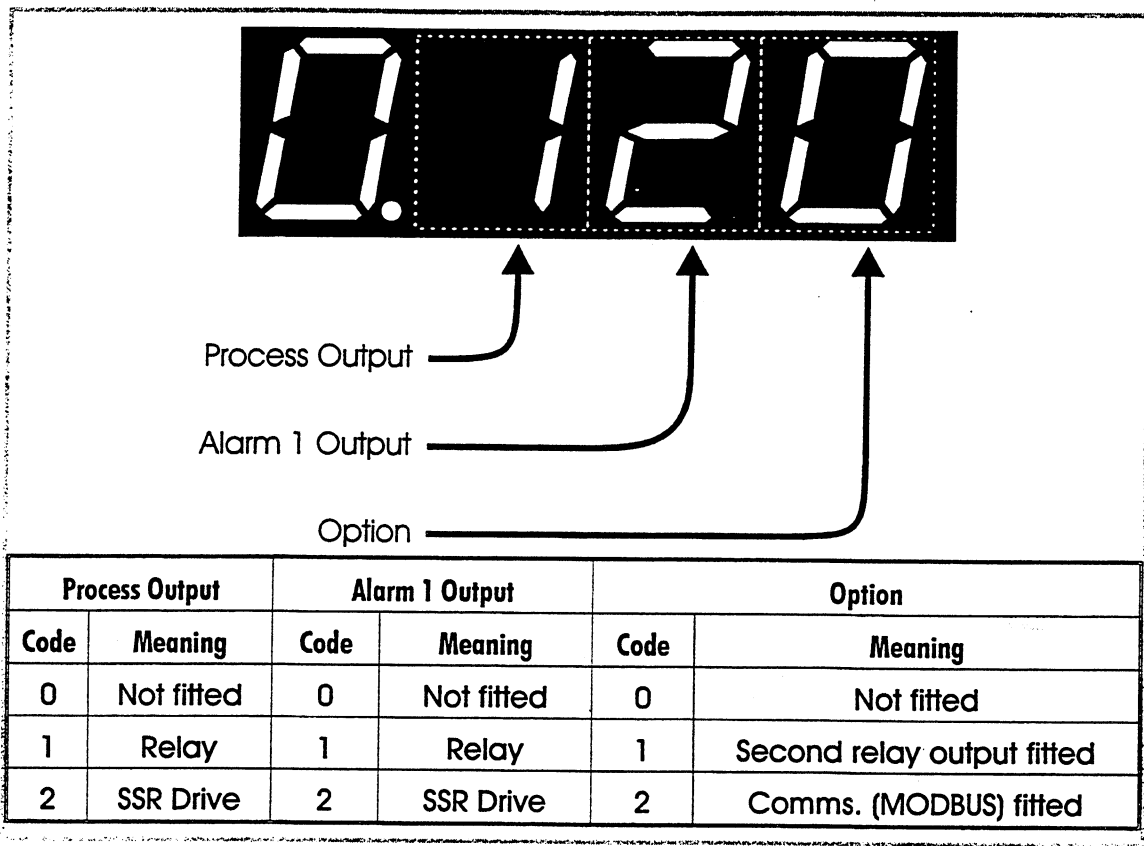

Figure 4-2 Display of Output Selection Code

Table 4-3 Parameter Default Values

Parameter	Default Value
Sensor Select	100 - Thermocouple "J" (-200°C to 1200°C)
Input Range Min.	Thermocouple/RTD - Input Range Min.; DC Linear - 0
Input Range Max.	Thermocouple/RTD - Input Range Max.; DC Linear - 1000
Decimal Point Posn.	0
Output Selection	1200 - Relay control output, SSR Drive, no option
Comms. Address	1
Comms. Baud Rate	4800
Comms. Parity	None
Single/Dual SP Select	1 - Single Setpoint operation
Alarm 1 Type	Process High Alarm
Alarm 2 Type	Process Low Alarm
Control Select	Reverse-acting PID control
Tuning Select	Easy Tune

5 CALIBRATION MODE

The Controller is shipped from the factory ready-calibrated and normally does not need further calibration. However, some users may have a legal requirement for annual calibration. The procedures set out in this Section serve that purpose.

NOTE: These procedures should be implemented only by personnel competent and authorised to do so.

Table 5-1 Calibration Mode Pre-requisites

Phase 1: DC mV Linear Input	50mV DC across Terminals 2 & 3 in the polarity shown in Figure 3-1.
Phase 2: RTD Input	200Ω across terminals 1 & 2 with compensating lead connected to Terminal 3.
Phase 3: DC mA Input	20mA source current connected to Terminals 3 & 4 in the polarity shown in Figure 3-1.
Phase 4: Thermocouple Input/CJC	0°C reference facility, Type K thermocouple leads (or equivalent) connected to Terminals 2 & 3.

5.1 ENTRY INTO CALIBRATION MODE

To enter Calibration Mode, proceed as shown on the right:

Power-up the Controller, then:

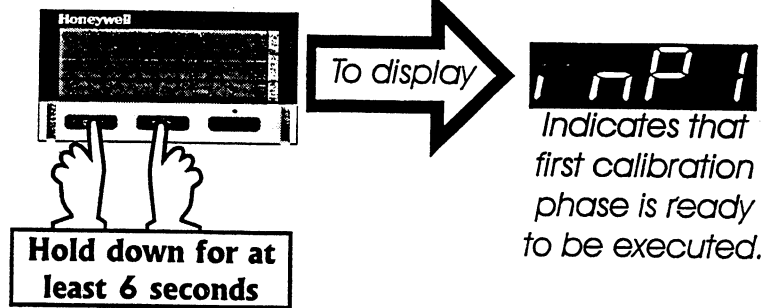

5.2 CALIBRATION PROCEDURE

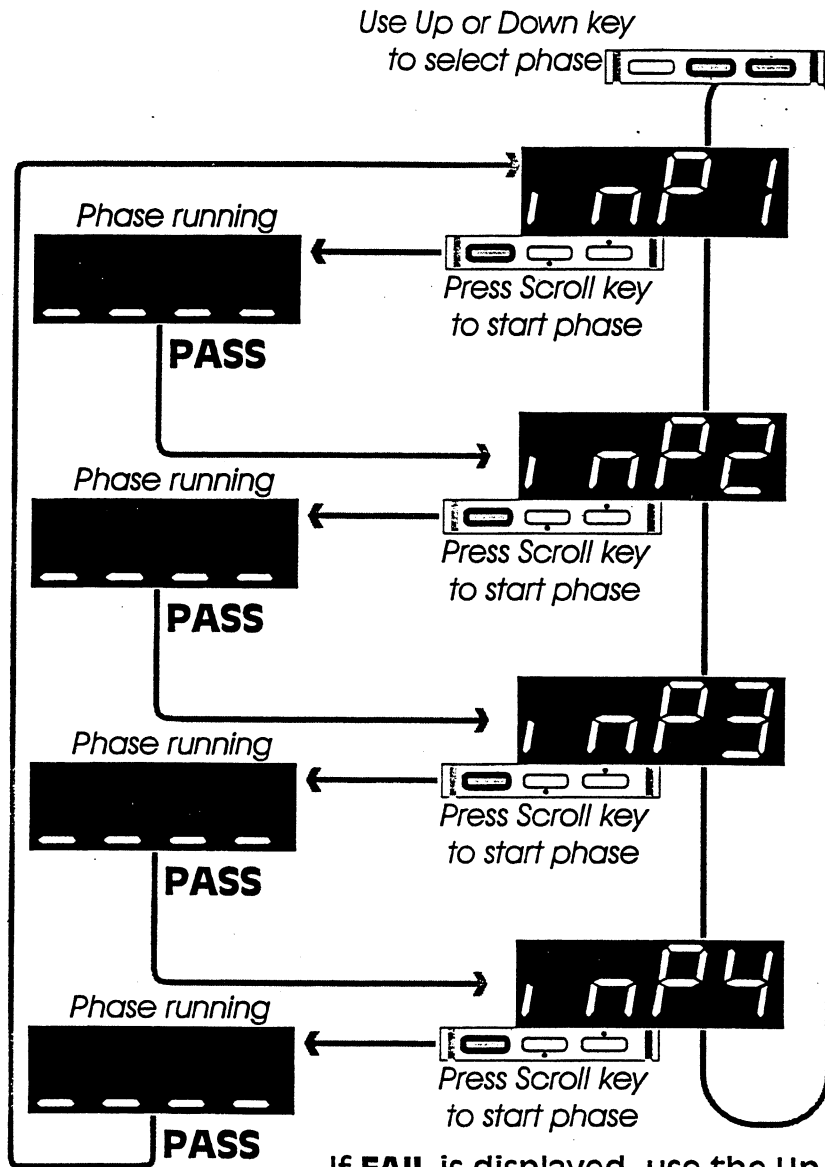

If **FAIL** is displayed, use the Up and Down keys to re-start the phase in question.

5.3 TO EXIT CALIBRATION MODE

NOTE: If there is no key activity for five minutes in Calibration Mode, an automatic return is made to Normal Operation Mode.

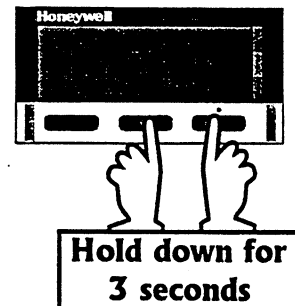

A MODBUS COMMUNICATIONS

A.1 FUNCTIONS SUPPORTED

The following MODBUS functions are supported, (JBUS names - where such an equivalence exists - in italics):

Read Coil Status (*Read n Bits*) - 01/02
Read Holding Registers (*Read n Words*) - 03/04
Force Single Coil (*Write 1 Bit*) - 05
Preset Single Register (*Write 1 Word*) - 06
Loopback Diagnostic Test - 08
Preset Multiple Registers (*Write n Words*) - 16

The instrument will identify itself in reply to a Read Holding Registers message which enquires the values of parameter numbers 121 and 122.

A.2 PARAMETER NUMBERS

Bit Parameters are summarised in Table A-1 and Word Parameters are summarised in Table A-2.

Table A-1 Bit Parameter Numbers

Parameter	Number	Notes
Reserved	1 - 3	
Pre-Tune	4	To enable Pre-Tune, write a non-zero value; to disable Pre-Tune, write zero. Enable Pre-Tune will fail if the process variable is within 5% of input span from the setpoint. This failure will not be signalled by communications.
Alarm 1 Status	5	Read Only
Alarm 2 Status	6	Read Only
Reserved	7 - 16	

Table A-2 Word Parameter Numbers

Parameter	Number	Notes
Process Variable value	1	Read Only
Current Setpoint value	2	Read Only
Output Power	3	Read Only
Deviation	4	Read Only
Proportional Band	5	
Reset	6	
Rate	7	
Bias	8	
ON/OFF Differential	9	
Output Cycle Time	10	
Input Filter Time Constant	11	
Alarm 1 value	12	
Alarm 2 value	13	
Selected Setpoint (1 or 2)	14	
Setpoint 1 value	15	
Setpoint 2 value	16	
Process Variable Offset	17	
Range Decimal Point Position	18	
Manufacturer ID	121	Read Only - 231 (representing "W1")
Equipment ID	122	Read Only - number 2300

TECHNICAL ASSISTANCE

If you encounter a problem with your unit, please review all the configuration data to verify that your selections are consistent with your application (i.e. inputs, outputs, alarms, limits etc.). If the problem persists after checking the above parameters, you can get technical assistance by calling the following:

In the U.S.A.:

1-800-423-9883

In other countries:

*See following Honeywell
Service Center addresses*

HONEYWELL SERVICE CENTERS

ARGENTINA

HONEYWELL S.A.I.C.
BELGRANO 1156
BUENOS AIRES
ARGENTINA
Tel.: 54 1 383 9290

AUSTRALIA

HONEYWELL LIMITED
5 Thomas Holt Drive
North Ryde Sydney
NSW AUSTRALIA 2113
Tel.: 61 2 353 7000

BELGIUM

HONEYWELL S.A.
Avenue de Schipol, 3
1140 BRUSSELS
BELGIUM
Tel.: 32 2 728 27 11

CANADA

HONEYWELL LIMITED
THE HONEYWELL CENTRE
529 McNicoll Avenue
M2H 2C9 NORTH YORK, ONTARIO
CANADA
Tel.: 416 502 5200

DENMARK

HONEYWELL A/S
Lyngby Hovedgade 98
2800 LYNGBY
DENMARK
Tel.: 45 45 93 56 56

FRANCE

HONEYWELL S.A.
Bâtiment "le Mercury"
Parc Technologique de St. Aubin
Route de l'Orme
91190 SAINT-AUBIN
FRANCE
Tel. from France: 01 60 19 80 00
From other countries: 33 1 60 19 80 00

HUNGARY

HONEYWELL Kft
Volgy U 30
H-1026 BUDAPEST
HUNGARY
Tel.: 36 1 116 76 59

MEXICO

HONEYWELL S.A. DE CV
AV. CONSTITUYENTES 900
COL. LOMAS ALTAS
11950 MEXICO CITY
MEXICO
Tel.: 52 5 259 1966

ASIA PACIFIC

HONEYWELL ASIA PACIFIC
Room 3213-3225
Sun Kung Kai Centre
No. 30 Harbour Road
WANCHAI
HONGKONG
Tel.: 852 829 82 98

AUSTRIA

HONEYWELL AUSTRIA G.m.b.H.
Handelskai 388
A1023 VIENNA
AUSTRIA
Tel.: 43 1 727 800

BRAZIL

HONEYWELL DO BRASIL AND CIA
Rua Jose Alves Da Chunha
Lima 172
BUTANTA
05360.050 SAO PAULO SP
BRASIL
Tel.: 55 11 819 3755

CZECH REPUBLIC

HONEYWELL spol.s r.o.
Budejovicka 1
140 00 Praha 4
Czech Republic
Tel.: 42-2-6112-2777

FINLAND

HONEYWELL OY
Ruukintie 8
FIN-02320 ESPOO 32
FINLAND
Tel.: 358 0 3480101

GERMANY

HONEYWELL AG
Kaiserleistrasse 39
Postfach 10 08 65
D-63067 OFFENBACH/MAIN
GERMANY
Tel.: 49 69 80 640

ITALY

HONEYWELL S.p.A.
Via P. Gobetti, 2/b
20063 Cernusco Sul Naviglio
ITALY
Tel.: 39 02 92146 1

NETHERLANDS

HONEYWELL BV
Laaderhoogtweg 18
NL-1101 EA AMSTERDAM ZO
THE NETHERLANDS
Tel.: 31 20 56 56 911

HONEYWELL SERVICE CENTERS

NORWAY

HONEYWELL A/S
Askerveien 61
PO Box 263
N-1371 ASKER
NORWAY
Tel.: 47 66 90 20 30

PORTUGAL

HONEYWELL PORTUGAL LDA
Edificio Suecia II
Av. do Forte nr 3 - Piso 3
CARNAXIDE
2795 LINDA A VELHA
PORTUGAL
Tel.: 351 1 4172 602

REP. OF SINGAPORE

HONEYWELL PTE LTD.
BLOCK 750E CHAI CHEE ROAD
06-01 CHAI CHEE IND. PARK
1646 SINGAPORE
REP. OF SINGAPORE
Tel.: 65 2490 100

SLOVAK REPUBLIC

HONEYWELL
Trnavska 3
831 04 BRATISLAVA
SLOVAKIA
Tel.: 42 7 526 1409

SPAIN

HONEYWELL
Josefa Valcarcel, 24
PO Box 29106
28027 MADRID
SPAIN
Tel.: 34 91 32 02 112

SWITZERLAND

HONEYWELL A.G.
Hertistrasse 2
8304 WALLISELLEN
SWITZERLAND
Tel.: 41 1 839 2525

U.S.A.

HONEYWELL INC
INDUSTRIAL AUTOMATION & CONTROL
1100 VIRGINIA DRIVE
FORT WASHINGTON, PA 19034-3260
U.S.A.
Tel.: 1-800-343-0228

POLAND

HONEYWELL Ltd.
Ul Augustowka 3
PL-02981 WARSAW
POLAND
Tel.: 48 2 642 25 70

REPUBLIC OF IRELAND

HONEYWELL
Unit 5
Long Mile Road
DUBLIN 12
Republic of Ireland
Tel.: 353 1 4565944

RUSSIA

HONEYWELL INC.
Tryokhprundny Pereulok 11.13
SU 10 3001 MOSCOW
Tel.: 7095 29 92 531

SOUTH AFRICA

HONEYWELL LTD.
34 Harry Street
Robertsham
JOHANNESBURG 2091
REPUBLIC OF SOUTH AFRICA
Tel.: 27 11 680 3440

SWEDEN

HONEYWELL A.B.
Storsatragrand 5
S-127 86 Skarholmen STOCKHOLM
SWEDEN
Tel.: 46 8 775 55 00

UNITED KINGDOM

HONEYWELL HOUSE
Arlington Business Park
BRACKNELL
Berkshire RG12 1EB
UNITED KINGDOM
Tel.: 44 344 826 000

VENEZUELA

HONEYWELL CA
APARTADO 61314
1060 CARACAS
VENEZUELA
Tel.: 58 2 239 0211

Free Manuals Download Website

<http://myh66.com>

<http://usermanuals.us>

<http://www.somanuals.com>

<http://www.4manuals.cc>

<http://www.manual-lib.com>

<http://www.404manual.com>

<http://www.luxmanual.com>

<http://aubethermostatmanual.com>

Golf course search by state

<http://golfingnear.com>

Email search by domain

<http://emailbydomain.com>

Auto manuals search

<http://auto.somanuals.com>

TV manuals search

<http://tv.somanuals.com>