

User Guide



HP Color Laser MFP 178 series
HP Color Laser MFP 179 series



www.hp.com/support/colorlaser170MFP

Copyright and License

© Copyright 2019 HP Development Company, L.P.

Reproduction, adaptation, or translation without prior written permission is prohibited, except as allowed under the copyright laws.

The information contained herein is subject to change without notice.

The only warranties for HP products and services are set forth in the express warranty statements accompanying such products and services. Nothing herein should be construed as constituting an additional warranty. HP shall not be liable for technical or editorial errors or omissions contained herein.

- Adobe®, Adobe Photoshop®, Acrobat®, and PostScript® are trademarks of Adobe Systems Incorporated.
- Apple and the Apple logo are trademarks of Apple Inc., registered in the U.S. and other countries.
- OS X is a trademark of Apple Inc., registered in the U.S. and other countries.
- AirPrint is a trademark of Apple Inc., registered in the U.S. and other countries.
- iPad is a trademark of Apple Inc., registered in the U.S. and other countries.
- iPad, iPhone, iPod touch, Mac and Mac OS are trademarks of Apple Inc., registered in the U.S. and other countries.
- Microsoft® and Windows® are U.S. registered trademarks of Microsoft Corporation.
- All other brand or product names are trademarks of their respective companies or organizations.

REV. 1.00

Table of Contents

Introduction	Key benefits	7
	Features by model	8
	Useful to know	11
	About this user's guide	12
	Safety information	13
	Machine overview	20
	Control panel overview	24
	Turning on the machine	27
Installing the software	28	
<hr/>		
Menu Overview and Basic Setup	Menu overview	30
	Machine's basic settings	35
	Media and tray	38
<hr/>		
Using a Network-Connected Machine	Wired network setup	55
	Installing driver over the network	57
	Wireless network setup	58
	Using HP Embedded Web Server	66
	HP Smart app	69
<hr/>		
Printing	Basic Print	74
	Canceling a print job	75
	Opening printing preferences	76
	Using a favorite setting	77
	Using help	78
	Printing features	79
	Using Printer Status programs	84
<hr/>		
Copying	Basic copy	87
	Changing the settings for each copy	88
	ID card copying	90
<hr/>		
Scanning	Basic scanning method	93
	Scanning from HP MFP Scan program	94

	Scanning from image editing program	95
	Scanning using the WIA driver	96
	Scanning to WSD	97
<hr/>		
Faxing	Preparing to fax	100
	Sending a fax	101
	Receiving a fax	107
	Forwarding a fax to another destination	111
	Adjusting the document settings	113
	Setting up the fax address book	115
<hr/>		
Useful Setting Menus	Before you begin reading a chapter	120
	Copy	121
	Fax	124
	System setup	128
	Network setup	133
<hr/>		
Maintenance	Ordering supplies and accessories	136
	Available supplies	137
	Available maintenance parts	139
	Storing the toner cartridge	140
	Redistributing toner	142
	Replacing the toner cartridge	143
	Replacing the imaging drum	144
	Replacing the toner collection unit	146
	Monitoring the supplies life	147
	Setting the toner low alert	148
	Cleaning the machine	149
	Tips for moving & storing your machine	153
<hr/>		
Troubleshooting	Tips for avoiding paper jams	155
	Clearing original document jams	156
	Clearing paper jams	159
	Understanding the LEDs	162
	A “Low Toner” or “Very Low Toner” message displays in Supplies information report	164

Understanding display messages	165
Paper feeding problems	172
Power and cable connecting problems	173
Solving other problems	174
Solve wireless network problems	187

Appendix

General Specifications	191
Print media specifications	192
System requirements	194

Introduction

This chapter provides information you need to know before using the machine.

• Key benefits	7
• Features by model	8
• Useful to know	11
• About this user's guide	12
• Safety information	13
• Machine overview	20
• Control panel overview	24
• Turning on the machine	27
• Installing the software	28

Key benefits

Environmentally friendly

- To save paper, you can print multiple pages on one single sheet of paper.
- To save electricity, this machine automatically conserves electricity by substantially reducing power consumption when not in use.
- We recommend using recycled paper for saving energy.

Convenience

- HP MFP Scan is an application to help users scan, compile, and save documents in multiple formats, including .epub format. These documents can be shared via social networking sites or fax (see "Scanning from HP MFP Scan program" on page 94).
- If you have Internet access, you can get help, support application, machine drivers, manuals, and order information from the HP website (www.hp.com/support/colorlaser170MFP).



Wide range of functionality and application support

- Supports various paper sizes (see "Print media specifications" on page 192).
- Print watermark: You can customize your documents with words, such as "CONFIDENTIAL"
- Print posters: The text and pictures of each page of your document are magnified and printed across the multiple sheets of paper and can then be taped together to form a poster.

Supports various wireless network setting method



Wireless networking may not be available depending on the model.

- Using the  (Wireless) button
 - You can easily connect to a wireless network using the  (Wireless) button on the machine and the access point (a wireless router).
- Using the USB cable or a network cable
 - You can connect and set various wireless network settings using a USB cable or a network cable.
- Using the Wi-Fi Direct
 - You can conveniently print from your mobile device using the Wi-Fi or Wi-Fi Direct feature.

Features by model

Some features and optional goods may not be available depending on model or country.

Operating System

Operating System	HP Color Laser MFP 178nw, 178nwg	HP Color Laser MFP 179fnw, 179fwg
Windows	•	•
Mac		
Linux	•	•

(•: Supported, Blank: Not supported)

Software

Software	HP Color Laser MFP 178nw, 178nwg	HP Color Laser MFP 179fnw, 179fwg
Printer driver	•	•
HP MFP Scan	•	•
Printer Status	•	•
HP Embedded Web Server	•	•
HP LJ Network PC Fax		•

(•: Supported, Blank: Not supported)

Variety feature

Features	HP Color Laser MFP 178nw, 178nwg	HP Color Laser MFP 179fnw, 179fwg
Hi-Speed USB 2.0	•	•
Network Interface Ethernet 10/100 Base TX wired LAN	•	•
Network Interface 802.11b/g/n wireless LAN ^a	•	•
Duplex (2-sided) printing (Manual) ^b	•	•
Automatic Document Feeder (ADF)		•
Fax		•
Scan	•	•
Copy	•	•

a. Depending on your country, wireless LAN card may not be available. For some countries, only 802.11 b/g can be applied. Contact your local HP dealer or the retailer where you bought your machine.

b. Windows only.

(•: Supported, Blank: Not supported)

Useful to know

The machine does not print.

- Open the print queue list and remove the document from the list (see "Canceling a print job" on page 75).
- Remove the driver and install it again (see "Installing the software" on page 28).
- Select your machine as your default machine in your Windows.

Where can I purchase accessories or supplies?

- Inquire at a HP distributor or your retailer.
- Visit the HP website (<https://store.hp.com/>). You can view product service information.

The status LED flashes or remains constantly on.

- Turn the product off and on again.
- Check the meanings of LED indications in this manual and troubleshoot accordingly (see "Understanding the LEDs" on page 162).

A paper jam has occurred.

- Open and close the cover (see "Front view" on page 21).
- Check the instructions on removing jammed paper in this manual and troubleshoot accordingly (see "Clearing paper jams" on page 159).

Printouts are blurry.

- The toner level might be low or uneven. Shake the toner cartridge (see "Redistributing toner" on page 142).
- Try a different print resolution setting (see "Opening printing preferences" on page 76).
- Replace the toner cartridge (see "Replacing the toner cartridge" on page 143).

Where can I download the machine's driver?

- You can get help, support application, machine drivers, manuals, and order information from the HP website (www.hp.com/support/colorlaser170MFP).

About this user's guide

This user's guide provides information for your basic understanding of the machine as well as detailed steps to explain machine usage.



- Do not discard this manual, and keep it for future reference.
- Read the safety information before using the machine.
- If you have a problem using the machine, refer to the troubleshooting chapter.
- Terms used in this user's guide are explained in the glossary chapter.
- All illustrations in this user's guide may differ from your machine depending on its options or model you purchased.
- The screenshots in this administrator's guide may differ from your machine depending on the machine's firmware/driver version.
- The procedures in this user's guide are mainly based on Windows 7.

Conventions

Some terms in this guide are used interchangeably, as below:

- Document is synonymous with original.
- Paper is synonymous with media, or print media.
- Machine refers to printer or MFP.

General icons



Icon	Text	Description
	Warning	Used to alert users to the possibility of personal injury.
	Caution	Gives users information to protect the machine from possible mechanical damage or malfunction.
	Note	Provides additional information or detailed specification of the machine function and feature.

Safety information

These warnings and precautions are included to prevent injury to you and others, and to prevent any potential damage to your machine. Be sure to read and understand all of these instructions before using the machine. After reading this section, keep it in a safe place for future reference.





Important safety symbols

Explanation of all icons and signs used in this chapter

	Warning	Hazards or unsafe practices that may result in severe personal injury or death.
	Caution	Hazards or unsafe practices that may result in minor personal injury or property damage.

Operating environment

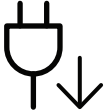
Warning

	Do not use if the power cord is damaged or if the electrical outlet is not grounded. This could result in electric shock or fire.
	Do not place anything on top of the machine (water, small metal or heavy objects, candles, lit cigarettes, etc.). This could result in electric shock or fire.
	<ul style="list-style-type: none">• If the machine gets overheated, it releases smoke, makes strange noises, or generates an odd odor, immediately turn off the power switch or unplug the machine.• The user should be able to access the power outlet in case of emergencies that might require the user to pull the plug out. This could result in electric shock or fire.
	Do not bend, or place heavy objects on the power cord. Stepping on or allowing the power cord to be crushed by a heavy object could result in electric shock or fire.



Do not remove the plug by pulling on the cord; do not handle the plug with wet hands.
This could result in electric shock or fire.

Caution

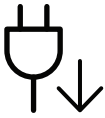

During an electrical storm or for a period of non-operation, remove the power plug from the electrical outlet.
This could result in electric shock or fire.



Be careful, the paper output area is hot.
Burns could occur.



If the machine has been dropped, or if the cabinet appears damaged, unplug the machine from all interface connections and request assistance from qualified service personnel.
Otherwise, this could result in electric shock or fire.



If the machine does not operate properly after these instructions have been followed, unplug the machine from all interface connections and request assistance from qualified service personnel.
Otherwise, this could result in electric shock or fire.



If the plug does not easily enter the electrical outlet, do not attempt to force it in.
Call an electrician to change the electrical outlet, or this could result in electric shock.









Do not allow pets to chew on the AC power, telephone or PC interface cords.
This could result in electric shock or fire and/or injury to your pet.

Operating method

Caution



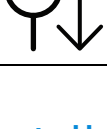

Do not forcefully pull the paper out during printing.
It can cause damage to the machine.

	Be careful not to put your hand between the machine and paper tray. You may get injured.
	Be careful when replacing paper or removing jammed paper. New paper has sharp edges and can cause painful cuts.
	When printing large quantities, the bottom part of the paper output area may get hot. Do not allow children to touch. Burns can occur.
	When removing jammed paper, do not use tweezers or sharp metal objects. It can damage the machine.
	Do not allow too many papers to stack up in the paper output tray. It can damage the machine.
	Do not block or push objects into the ventilation opening. This could result in elevated component temperatures which can cause damage or fire.
	Use of controls or adjustments or performance of procedures other than those specified herein may result in hazardous radiation exposure.
	This machine's power reception device is the power cord. To switch off the power supply, remove the power cord from the electrical outlet.







Installation / Moving



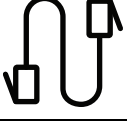

Warning

	Do not place the machine in an area with dust, humidity, or water leaks. This could result in electric shock or fire.
---	--

	<p>Place the machine in the environment where it meets the operating temperature and humidity specification.</p> <p>Do not use the machine when it is below freezing temperature or has recently been moved from a location below freezing temperature. Doing so may damage the machine. Only operate the machine when the internal temperature of the machine is within the operating temperature and humidity specifications.</p> <p>Otherwise, quality problems can occur and cause damage to the machine.</p> <p>See "General Specifications" on page 191.</p>
---	--

 **Caution**

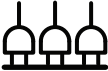



	<p>Before moving the machine, turn the power off and disconnect all cords. The information below are only suggestions based on the units weight.</p> <p>If you have a medical condition that prevents you from lifting, do not lift the machine. Ask for help, and always use the appropriate amount of people to lift the device safely.</p> <p>Then lift the machine:</p> <ul style="list-style-type: none"> • If the machine weighs under 20 kg (44.09 lbs), lift with 1 person. • If the machine weighs 20 kg (44.09 lbs) - 40 kg (88.18 lbs), lift with 2 people. • If the machine weighs more than 40 kg (88.18 lbs), lift with 4 or more people. <p>The machine could fall, causing injury or machine damage.</p>
	<p>Choose a flat surface with enough space for ventilation to place the machine. Also consider the space required to open the cover and trays.</p> <p>The place should be well-ventilated and be far from direct light, heat, and humidity.</p>
	<p>When using the machine for a long period of time or printing a large number of pages in a non-ventilated space, it could pollute the air and be harmful to your health. Place the machine in a well-ventilated space or open a window to circulate the air periodically.</p>
	<p>Do not place the machine on an unstable surface.</p> <p>The machine could fall, causing injury or machine damage.</p>
	<p>Use only No.26 AWG^a or larger, telephone line cord, if necessary.</p> <p>Otherwise, it can cause damage to the machine.</p>
	<p>Make sure you plug the power cord into a grounded electrical outlet.</p> <p>Otherwise, this could result in electric shock or fire.</p>

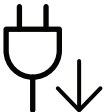

	<p>Use the power cord supplied with your machine for safe operation. If you are using a cord which is longer than 2 meters (6 feet) with a 110V machine, then the gauge should be 16 AWG or larger.</p> <p>Otherwise, it can cause damage to the machine, and could result in electric shock or fire.</p>
	<p>Do not put a cover over the machine or place it in an airtight location, such as a closet.</p> <p>If the machine is not well-ventilated, this could result in fire.</p>
	<p>Do not overload wall outlets and extension cords.</p> <p>This can diminish performance, and could result in electric shock or fire.</p>
	<p>The machine should be connected to the power level which is specified on the label.</p> <p>If you are unsure and want to check the power level you are using, contact the electrical utility company.</p>

a.AWG: American Wire Gauge

Maintenance / Checking





Caution

	<p>Unplug this product from the wall outlet before cleaning the inside of the machine. Do not clean the machine with benzene, paint thinner or alcohol; do not spray water directly into the machine.</p> <p>This could result in electric shock or fire.</p>
	<p>When you are working inside the machine replacing supplies or cleaning the inside, do not operate the machine.</p> <p>You could get injured.</p>
	<p>Keep cleaning supplies away from children.</p> <p>Children could get hurt.</p>
	<p>Do not disassemble, repair or rebuild the machine by yourself.</p> <p>It can damage the machine. Call a certified technician when the machine needs repairing.</p>
	<p>To clean and operate the machine, strictly follow the user's guide provided with the machine.</p> <p>Otherwise, you could damage the machine.</p>

	<p>Keep the power cable and the contact surface of the plug clean from dust or water. Otherwise, this could result in electric shock or fire.</p>
	<ul style="list-style-type: none"> • Do not remove any covers or guards that are fastened with screws. • Fuser units should only be repaired by a certified service technician. Repair by non-certified technicians could result in fire or electric shock. • The machine should only be repaired by a HP service technician.

Supply usage

Caution

	<p>Do not disassemble the toner cartridge. Toner dust can be dangerous if inhaled or ingested.</p>
	<p>Do not burn any of the supplies such as toner cartridge or fuser unit. This could cause an explosion or uncontrollable fire.</p>
	<p>When storing supplies such as toner cartridges, keep them away from children. Toner dust can be dangerous if inhaled or ingested.</p>
	<p>Using recycled supplies, such as toner, can cause damage to the machine. In case of damage due to the use of recycled supplies, a service fee will be charged.</p>
	<p>For supplies that contain toner dust (toner cartridge, toner collection unit, imaging unit, etc.) follow the instructions below.</p> <ul style="list-style-type: none"> • When disposing of the supplies, follow the instructions for disposal. Refer to the reseller for disposal instructions. • Do not wash the supplies. • For a toner collection unit, do not reuse it after emptying the bottle. <p>If you do not follow the instructions above, it may cause machine malfunction and environmental pollution. The warranty does not cover damages caused by a user's carelessness.</p>
	<p>When toner gets on your clothing, do not use hot water to wash it. Hot water sets toner into fabric. Use cold water.</p>







When changing the toner cartridge or removing jammed paper, be careful not to let toner dust touch your body or clothes.
Toner dust can be dangerous if inhaled or ingested.

Machine overview

Components

The actual component may differ from the illustration below. Some components may change depending on the configuration.

	Machine ^a
	Setup guide and Reference guide
	Power cord
	Misc. accessories ^b

a. This illustration may differ from your machine depending on your model. There are various types of machine.

b. Miscellaneous accessories included with your machine may vary by country of purchase and specific model.

Front view



- This illustration may differ from your machine depending on your model. There are various types of machine.
- Some features and optional goods may not be available depending on model or country (see "Features by model" on page 8).

Type A

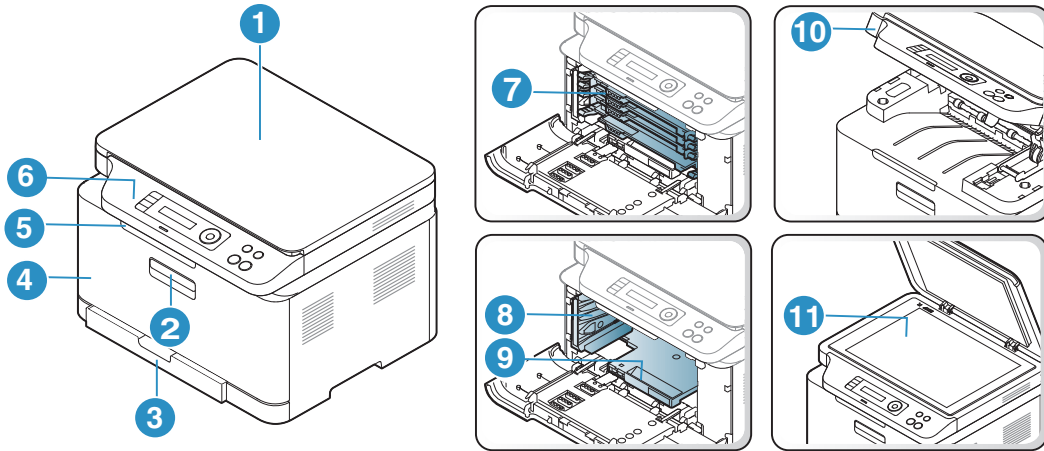

1	Scanner lid	7	Toner cartridges
2	Front handle	8	Toner Collection Unit
3	Tray	9	Imaging unit
4	Front door	10	Scan unit ^{a b}
5	Output support	11	Scanner glass
6	Control panel		

a. Close the scanner lid before opening the scan unit.

b. Be careful not to pinch your fingers.

Type B

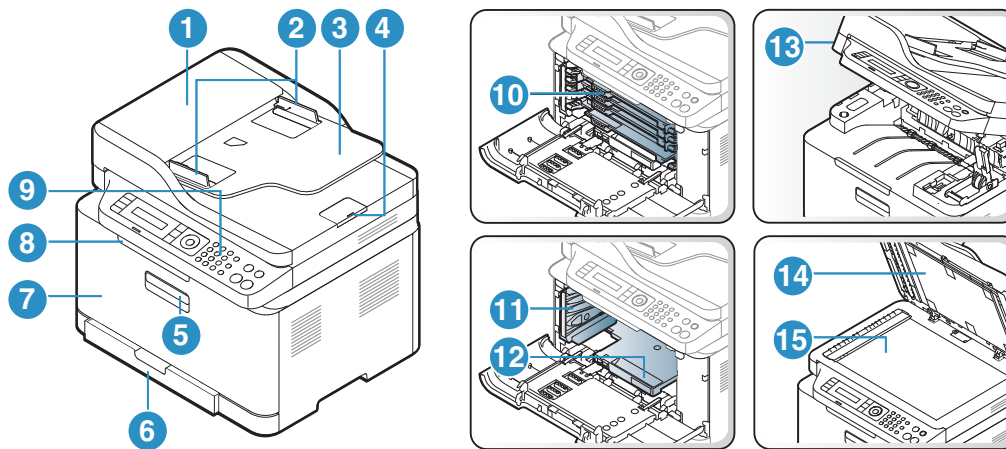

1	Document feeder cover	9	Control panel
2	Document feeder width guide	10	Toner cartridges
3	Document feeder input tray	11	Toner collection unit
4	Document feeder output support	12	Imaging unit
5	Front handle	13	Scan unit ^{a b}
6	Tray	14	Scanner lid
7	Front cover	15	Scanner glass
8	Output support		

a. Close the scanner lid before opening the scan unit.

b. Be careful not to pinch your fingers.

Rear view



- This illustration may differ from your machine depending on your model. There are various types of machine.
- Some features and optional goods may not be available depending on model or country (see "Features by model" on page 8).

Type A

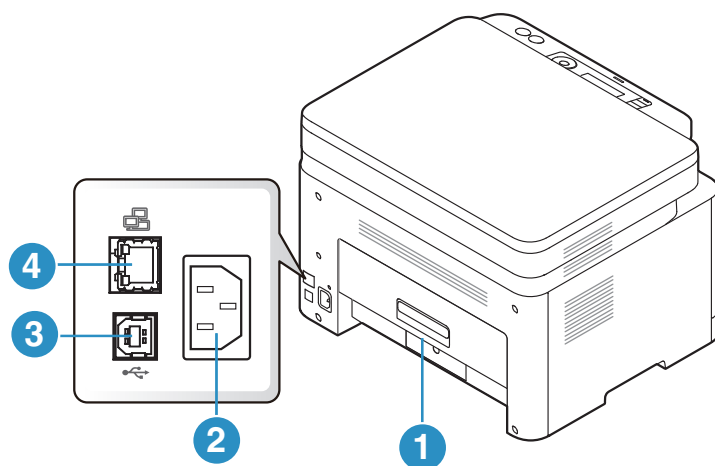

1	Rear cover	3	USB port
2	Power receptacle	4	Network port

Type B

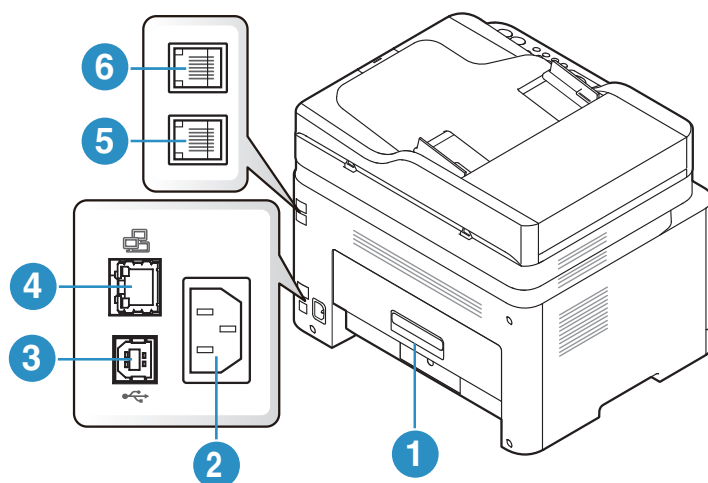

1	Rear cover	4	Network port
2	Power receptacle	5	Telephone line socket (LINE)
3	USB port	6	Extension telephone socket (EXT.)

Control panel overview



- This control panel may differ from your machine depending on its model. There are various types of control panels.
- Some features and optional goods may not be available depending on model or country (see "Features by model" on page 8).

Type A

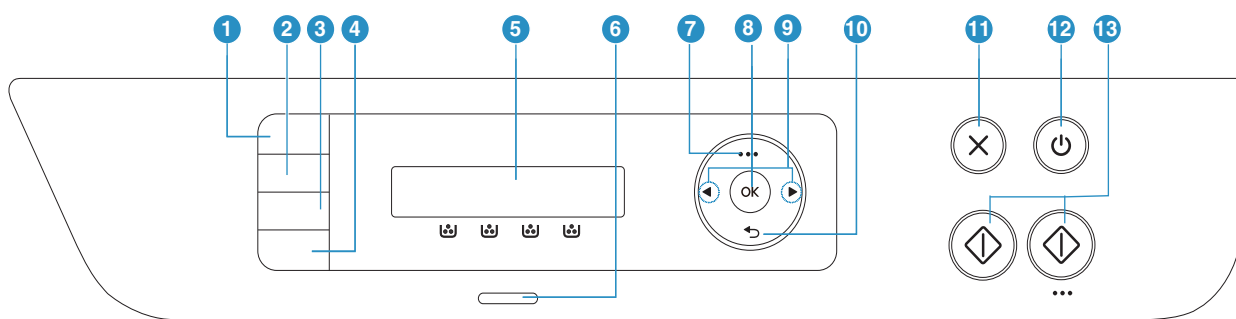







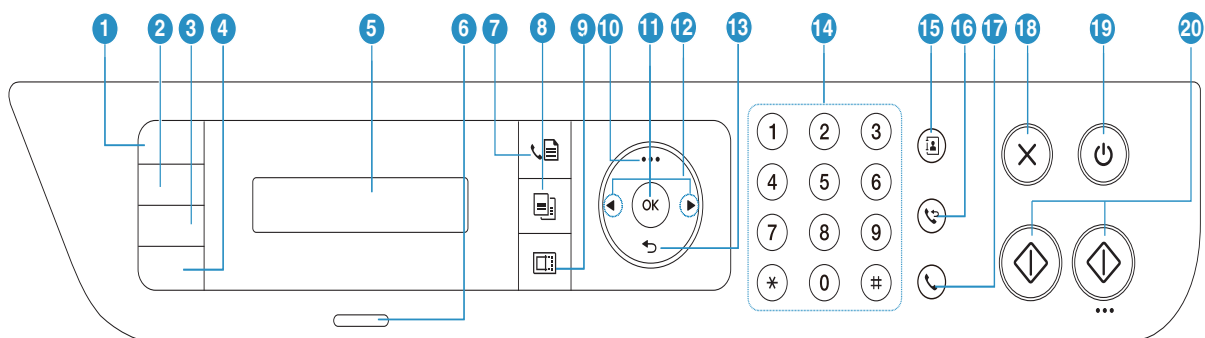



1	ID Copy		Allows you to copy both sides of an ID card like a driver's license on a single side of paper (see "ID card copying" on page 90).
2	Contrast		Adjusts the brightness level to make a copy for easier reading, when the original contains faint markings and dark images.
3	Scan		Switches between scan and copy mode.
4	Wireless		Press this button, access to the Wi-Fi menu. Or press and hold this button for about 3 seconds or more seconds, access to PBC mode (see "Wireless network setup" on page 58).
5	Display screen		Shows the current status and displays prompts during operation.
6	Status LED		Indicates the status of your machine (see "Understanding the LEDs" on page 162).
7	Menu		Opens Menu mode and scrolls through the available menus (see "Menu overview" on page 30).
8	OK		Confirms the selection on the screen. You can also manual print. Press this button to print the other side of all pages, if you have selected Double-sided Printing (Manual) in your driver.

9	Left/Right Arrows	◀ ▶	Scrolls through the options available in the selected menu and increases or decreases values.
10	Back	↶	Sends you back to the upper menu level.
11	Cancel	⊗	Stops an operation at any time.
12	Power	⏻	Turns the power on or off, or wakes up the machine from the power save mode. If you need to turn the machine off, press this button for more than three seconds.
13	Start (Mono, Color)	▶▶	Starts a job.

Type B



1	ID Copy	☰	Allows you to copy both sides of an ID card like a driver's license on a single side of paper (see "ID card copying" on page 90).
2	Contrast	◐	Adjusts the brightness level to make a copy for easier reading, when the original contains faint markings and dark images.
3	Scale	📐	You can reduce or enlarge the size of a copied image from 25% to 400% when you copy original documents from the scanner glass (see "Reduced or enlarged copy" on page 89).
4	Wireless	📶	Press this button, access to the Wi-Fi menu. Or press and hold this button for about 3 seconds or more seconds, access to PBC mode (see "Wireless network setup" on page 58).
5	Display screen		Shows the current status and displays prompts during operation.
6	Status LED	ⓘ/⚠	Indicates the status of your machine (see "Understanding the LEDs" on page 162).
7	Fax	📠	Switches to Fax mode.
8	Copy	📄	Switches to Copy mode.

9	Scan		Switches to Scan mode.
10	Menu		Opens Menu mode and scrolls through the available menus (see "Menu overview" on page 30).
11	OK		Confirms the selection on the screen.
12	Left/Right Arrows		Scrolls through the options available in the selected menu and increases or decreases values.
13	Back		Sends you back to the upper menu level.
14	Numeric keypad		Dials a number or enters alphanumeric characters (see "Keypad letters and numbers" on page 36).
15	Address Book		Allows you to store frequently used fax numbers or search for stored fax numbers (see "Setting up the fax address book" on page 115).
16	Redial/Pause		Redials the recently sent fax number or received caller ID in ready mode, or inserts a pause(-) into a fax number in edit mode (see "Redialing the fax number" on page 104).
17	On Hook Dial		When you press this button, you can hear a dial tone. Then enter a fax number. It is similar to making a call using speaker phone (see "Receiving manually in Tel mode" on page 108).
18	Cancel		Stops an operations at any time.
19	Power		Turns the power on or off, or wakes up the machine from the power save mode. If you need to turn the machine off, press this button for more than three seconds.
20	Start (Mono, Color)		Starts a job.

Turning on the machine

 Keep in mind that you should use the power cord supplied with the machine. Otherwise, it can cause damage or fire to the machine.

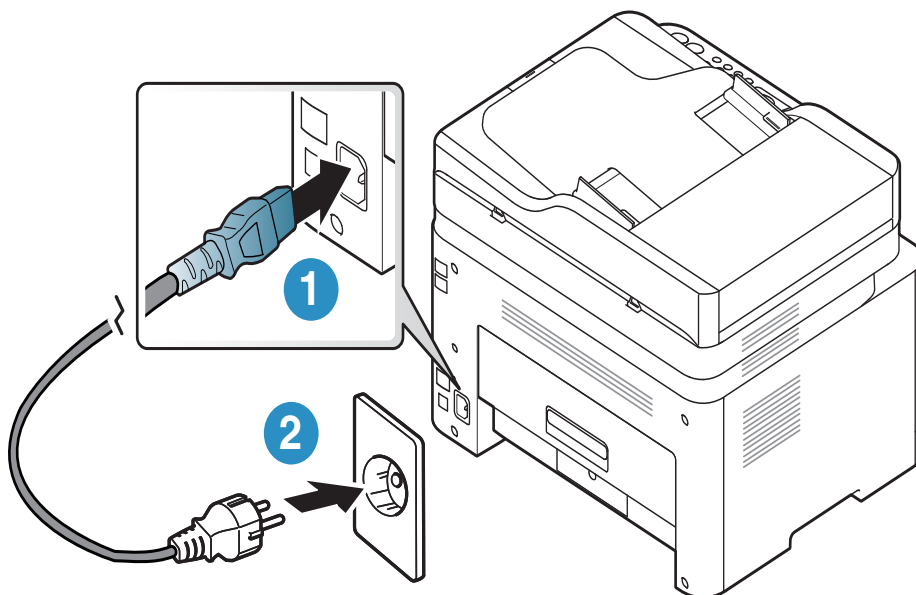

- 1 Connect the machine to the electricity supply first.
Turn the switch on if the machine has a power switch.



 Illustrations on this user's guide may differ from your machine depending on its options or models. Check your machine type (see "Front view" on page 21).

- 2 Power is turned on automatically.

Or, press  (**Power**) button on the control panel.

 If you want to turn the power off, press and hold  (**Power**) button for about 3 seconds.

Installing the software

After you have set up your machine and connected it to your computer, you must install the printer software. You need to download software packages from the HP website to install the printer software.

Before installing, check whether your computer's OS support the software (see "Operating System" on page 8).

For HP's all-inclusive help for the printer, go to www.hp.com/support > select your country and region > find your product.

Find the following support:

- Install and configure
- Learn and use
- Solve problems
- Download software and firmware updates
- Join support forums
- Find warranty and regulatory information



A locally connected machine is a machine directly attached to your computer using the cable. If your machine is attached to a network, skip the following steps below and go on to installing a network connected machine's driver (see "Installing driver over the network" on page 57).



Only use a USB cable no longer than 3 meters (118 inches).

Menu Overview and Basic Setup

This chapter provides information about the overall menu structure and the basic setup options.

- Menu overview 30
- Machine's basic settings 35
- Media and tray 38

Menu overview

The control panel provides access to various menus to set up the machine or use the machine's functions.



- Some menus may not appear on the display depending on options or models. If so, it is not applicable to your machine.
 - Some menu names may differ from your machine depending on its options or the models.
 - The menus are described in the Useful Setting Menus chapter (see "Useful Setting Menus" on page 119).
-

Accessing the menu

- 1 Select the Copy, Fax or Scan button on the control panel depending on the feature to be used.
- 2 Select ●●● (Menu) until the menu you want appears on the bottom line of the display and press **OK**.
- 3 Press the left/right arrows until the needed menu item appears and press **OK**.
- 4 If the setting item has sub menus, repeat step 3.
- 5 Press **OK** to save the selection.
- 6 Press  (**Cancel**) to return to the ready mode.

Copy Feature (see "Copy" on page 121)	Copy Setup (see "Copy" on page 121)
<p>Original Size</p> <p>Reduce/Enlarge</p> <p>Darkness</p> <ul style="list-style-type: none"> Normal Dark+1- Dark+5 Light+5- Light+1 <p>Original Type</p> <ul style="list-style-type: none"> Text Text/Photo Photo Magazine <p>Collation</p> <ul style="list-style-type: none"> On Off <p>Layout</p> <ul style="list-style-type: none"> Normal 2-Up 4-Up ID Copy <p>Adjust Bkgd.</p> <ul style="list-style-type: none"> Off Auto Enhance Lev.1 Enhance Lev.2 Erase Lev.1- Erase Lev.4 	<p>Change Default</p> <ul style="list-style-type: none"> Original Size Copies Reduce/Enlarge Darkness Original Type Collation

Fax Feature ^a (see "Fax" on page 124)		Fax Setup ^a (see "Fax" on page 124)	
Darkness	Rcv. Forward	Sending	Change Default
Light+5- Light+1	Forward to Fax	Redial Times	Darkness
Normal	Forward to PC	Redial Term	Resolution
Dark+1- Dark+5	Forward&Print	Prefix Dial	Original Size
Resolution	Secure Receive	ECM Mode	Smart Fax Diag
Standard	Off	Modem Speed	Auto Config.
Fine	On	Fax Confirm.	Start Now
Super Fine	Print	Image TCR	Initialize
Photo Fax	Cancel Job	Dial Mode ^b	Manual TX/RX
Original Size		Receiving	On
Multi Send		Receive Mode	Off
Delay Send		Ring to Answer	
Send Forward		Stamp Rcv Name	
Forward to Fax		Rcv Start Code	
		Auto Reduction	
		Discard Size	
		Junk Fax Setup	
		DRPD Mode ^b	

a.Fax model only.

b.This option may not be available depending on your country.

System Setup
(see "System setup" on page 128)

Machine Setup	Report	Maintenance
Machine ID ^a	Configuration	CLR Empty Msg ^c
Fax Number ^a	Demo Page	Supplies Life
Date & Time ^a	Network Conf.	Image Mgr.
Clock Mode ^a	Supplies Info.	Custom Color
Language	Usage Counter	TonerLow Alert
Default Mode ^a	Fax Received ^a	ImgU.Low Alert
Power Save	Fax Sent ^a	Serial Number
Auto Power Off ^b	Scheduled Jobs ^a	
Wakeup Event	Fax Confirm. ^a	
System Timeout	Junk Fax ^a	
Job Timeout	address book ^a	
Altitude Adj.		
Humidity		
Auto Continue		
Paper Substit.		
Paper Setup		
Paper Size		
Paper Type		
Margin		
Sound/Volume ^a		
Key Sound		
Alarm Sound		
Speaker		
Ringer		

a.Fax model only.

b.This option may not appear on the display depending on models. If so, it is not applicable to your machine.

c.This option only appears when small amount of toner is left in the cartridge.

Network
(see "Network setup" on page 133)

TCP/IP (IPv4) DHCP BOOTP Static	Wi-Fi Wi-Fi On/Off Wi-Fi Settings ^a WPS Wi-Fi Direct Wi-Fi Signal Wi-Fi Default
TCP/IP (IPv6) IPv6 Protocol DHCPv6 Config	Protocol Mgr. HTTP WINS SNMPv1/v2 UPnP(SSDP) mDNS SLP
Ethernet Ethernet Port Ethernet Speed	Network Conf. Clear Settings

a.Fax model only.

Machine's basic settings



You change the machine's setting set in the machine from HP Embedded Web Server. If your machine is connected to the network, you can set the machine's setting from **HP Embedded Web Server > Settings tab > Machine Settings** (see "Using HP Embedded Web Server" on page 66).

Machine's default settings

After installation is complete, you may want to set the machine's default settings.

To change the machine's default settings, follow these steps:



It may be necessary to press **OK** to navigate to lower-level menus for some models.

- 1 Select **•••(Menu)** button on the control panel.
- 2 Press **System Setup > Machine Setup**.
- 3 Select the option you want, then press **OK**.
- 4 Select the sub option you want, then press **OK**.
- 5 Press **OK** to save the selection.
- 6 Press  (**Cancel**) to return to ready mode.

Entering various characters

As you perform various tasks, you may need to enter names and numbers. For example, when you set up your machine, you enter your name or your company's name, and the fax number. When you store fax numbers or email addresses in memory, you may also enter the corresponding names.

Entering alphanumeric characters

Press the button until the correct letter appears on the display. For example, to enter the letter O, press 6, labeled with MNO. Each time you press 6, the display shows a different letter, M, N, O, m, n, o and finally 6. To find the letter that you want to enter, see "Keypad letters and numbers" on page 36.



- You can enter a space by pressing 1 twice.
- To delete the last digit or character, press the left/right or up/down arrow button.

Keypad letters and numbers



- Special character sets may differ from your machine depending on its options or the models.
- Some of the follow key values may not appear depending on the job you are doing.

Key	Assigned numbers, letters, or characters
1	@ / . ' 1
2	A B C a b c 2
3	D E F d e f 3
4	G H I g h i 4
5	J K L j k l 5
6	M N O m n o 6
7	P Q R S p q r s 7
8	T U V t u v 8
9	W X Y Z w x y z 9
0	& + - , 0
*	* % ^ _ ~ ! # \$ () [] (These symbols are available when you type for network authentication.)
#	# = ? " : { } < > ; (These symbols are available when you type for network authentication.)

Altitude adjustment

Print quality is affected by atmospheric pressure, which is determined by the height of the machine above sea level. The following information will guide you on how to set your machine for the best print quality.

Before you set the altitude value, determine the altitude where you are.

- **Normal:** 0 ~ 1,000 m (3,280 ft)
- **High 1 :** 1,000 m (3,280 ft) ~ 2,000 m (6,561 ft)
- **High 2:** 2,000 m (6,561 ft) ~ 3,000 m (9,842 ft)
- **High 3:** 3,000 m (9,842 ft) ~ 4,000 m (13,123 ft)
- **High 4:** 4,000 m (13,123 ft) ~ 5,000 m (16,404 ft)



- If your machine is connected to the network, you can set the machine's setting from **HP Embedded Web Server** > **Settings** tab > **Machine Settings** (see "Using HP Embedded Web Server" on page 66).
 - You can also set the altitude in **System Setup** option on the machine's display (see "Machine's basic settings" on page 35).
-

Media and tray

This chapter provides information on how to load print media into your machine.

Selecting print media

Always use print media that meets the guidelines for use with your machine.

Guidelines for select the print media

Print media that does not meet the guidelines outlined in this user's guide may cause the following problems:

- Poor print quality
- Increased paper jams
- Premature wear on the machine.

Properties, such as weight, composition, grain, and moisture content, are important factors that affect the machine's performance and the output quality. When you choose print materials, consider the following:

- The type, size, and weight of the print media for your machine are described in print media specifications (see "Print media specifications" on page 192).
- Desired outcome: The print media you choose should be appropriate for your project.
- Brightness: Some print media are whiter than others and produce sharper, more vibrant images.
- Surface smoothness: The smoothness of the print media affects how crisp the printing looks on the paper.



- Some print media may meet all of the guidelines in this user's guide and still not produce satisfactory results. This may be the result of the sheets characteristics, improper handling, unacceptable temperature and humidity levels, or other variables over which cannot be controlled.
- Before purchasing large quantities of print media, ensure that it meets the requirements specified in this user's guide.



- Using print media that does not meet these specifications may cause problems or require repairs. Such repairs are not covered by HP's warranty or service agreements.
- The amount of paper put into the tray may differ according to media type used (see "Print media specifications" on page 192).
- Make sure not to use the inkjet photo paper with this machine. It could cause damage to the machine.
- Using flammable print media can cause a fire.
- Use designated print media (see "Print media specifications" on page 192).



The use of flammable media or foreign materials left in the printer may lead to overheating of the unit and, in rare cases may cause a fire.

The amount of paper put into the tray may differ according to media type used (see "Print media specifications" on page 192).

Tray overview

To change the size, you need to adjust the paper guides.

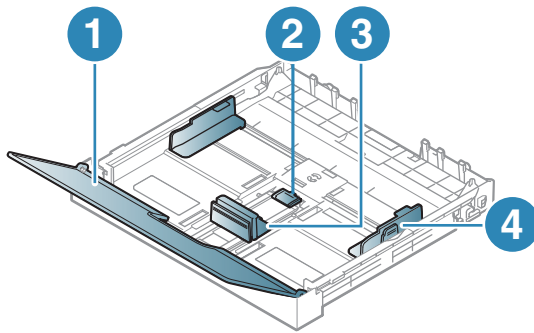

1. Paper cover
2. Guide lock
3. Paper length guide
4. Paper width guide



If you do not adjust the guide, it may cause paper registration, image skew, or jamming of the paper.

Loading paper in the tray



Illustrations on this user's guide may differ from your machine depending on its options or models. Check your machine type (see "Front view" on page 21).

- 1 Pull out the paper tray (see "Tray overview" on page 40).

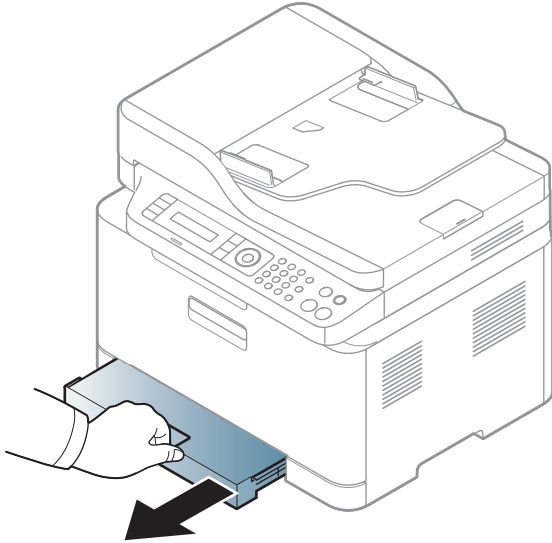

- 2 Open the paper cover.

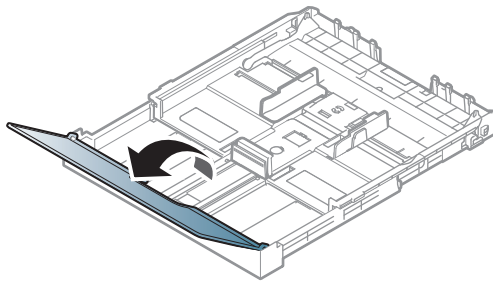

- 3 Squeeze and the paper width guide and paper length lever to locate them in the correct paper size slot marked at the bottom of the tray to adjust to the size.

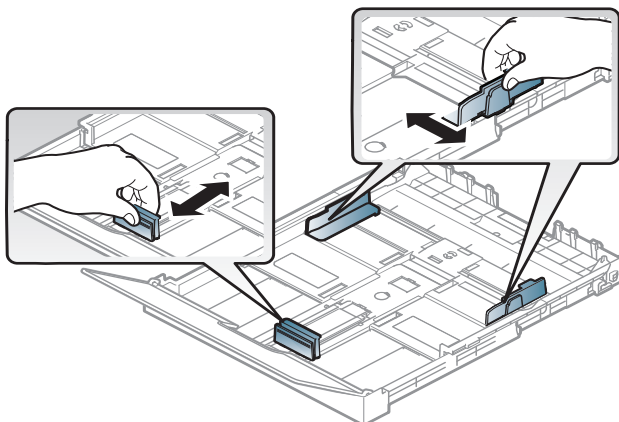

4 Flex or fan the edge of the paper stack to separate the pages before loading papers.

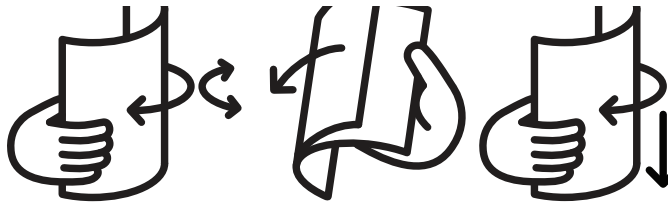

5 Place the paper with the side you want to print facing up.

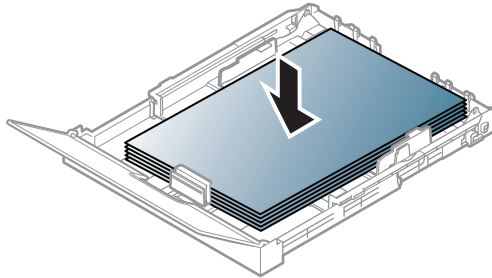

For paper smaller than A4-sized, press and unlatch the guide lock in the tray, push the tray in manually. Then adjust the paper length guide and paper width guide.

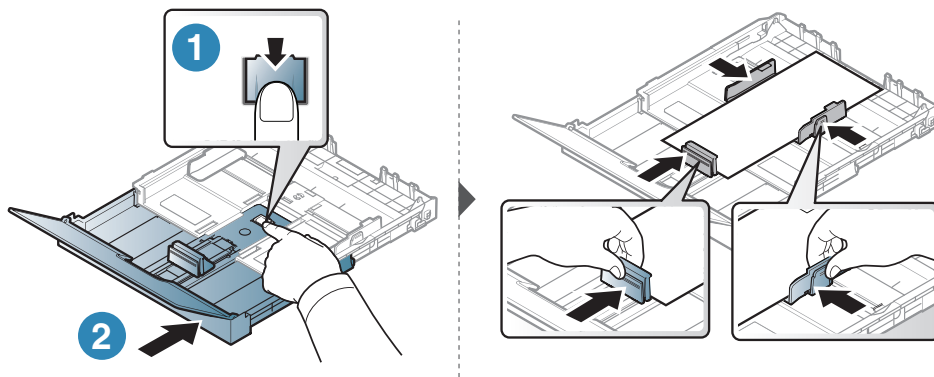

For paper longer than Legal-sized, press and unlatch the guide lock in the tray, pull the tray out manually. Then adjust the paper length guide and paper width guide.

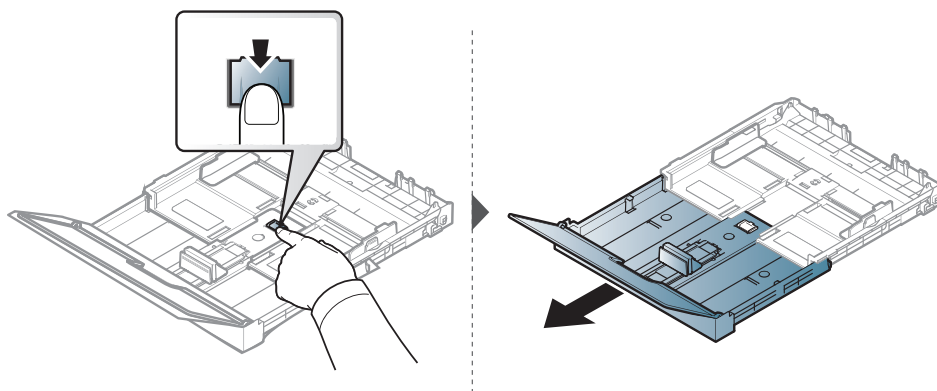



- If you do not adjust the guide, it may cause paper registration, image skew, or jamming of the paper.
- Do not push the paper width guide too far causing the media to warp.
- Do not use a paper with a leading-edge curl, it may cause a paper jam or the paper can be wrinkled.



- If you do not adjust the paper width guide, it may cause paper jams.

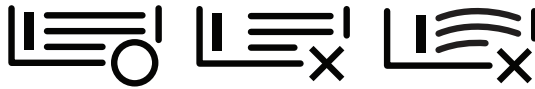

-
- 6 Squeeze the paper width guide and slide it to the edge of the paper stack without causing it to buckle.

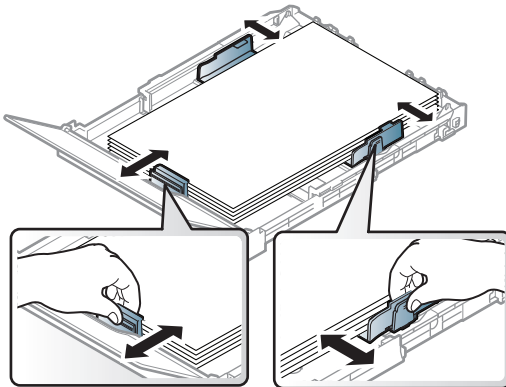

- 7 Close the paper cover.

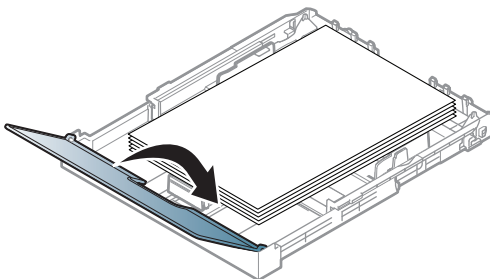

- 8 Insert the paper tray.

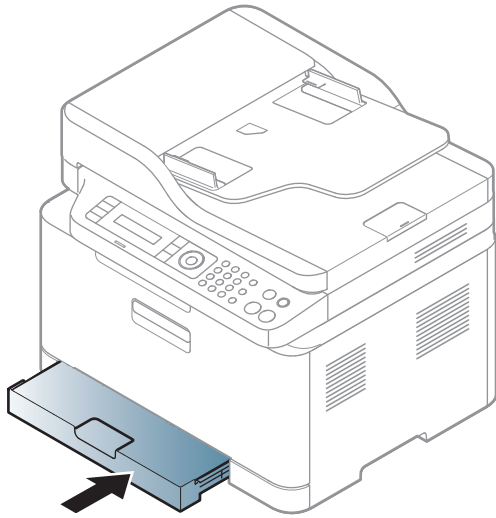

- 9 When you print a document, set the paper type and size for the tray (see "Setting the paper size and type" on page 48).

The tray is preset to Letter or A4 size, depending on your country. To change the size to A4 or Letter, you must adjust the lever and paper width guide properly.

- 1 Pull the tray out of the machine. Open the paper cover and remove paper from the tray if necessary.
- 2 If you want to change the size to Letter, hold the lever at the back of the tray, and rotate the lever clockwise. You can see the lever when you move the paper length guide to the legal-sized paper (LGL).

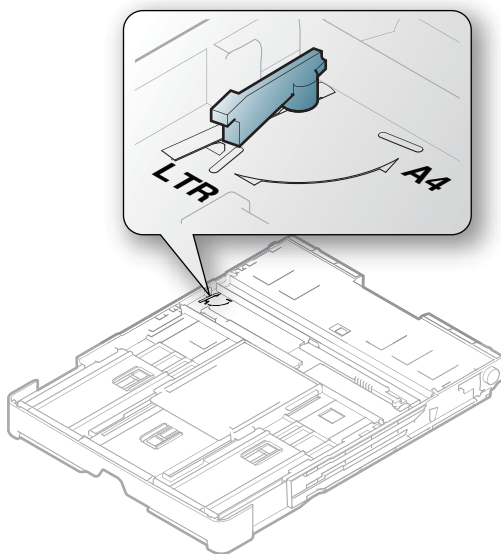

- 3 Squeeze the paper width guide and slide it to the edge of the lever.

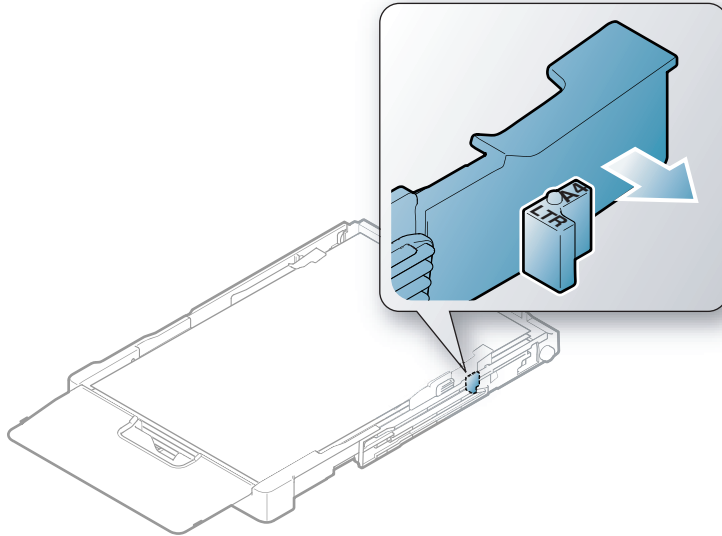

If you want to change the size to A4, first move the paper width guide to left and rotate the lever counterclockwise. If you force the lever, it could damage the tray.

Printing on special media



- When using special media, we recommend you feed one sheet at a time (see "Print media specifications" on page 192).

The table below shows the special media usable in tray.

To change the paper setting set in the machine, set the paper type from the **Printing Preferences** window > **Paper** tab > **Paper Type** (see "Opening printing preferences" on page 76).



- When using special media, we recommend you feed one sheet at a time (see "Print media specifications" on page 192).
- Illustrations on this user's guide may differ from your machine depending on its options or models. Check your machine type (see "Front view" on page 21).

To see paper weights for each sheet, refer to "Print media specifications" on page 192.

Types	Tray ^a
Plain	•
Heavy 90-120g	•
Light 60-69g	•
Bond	•
Colored	•

Types	Tray ^a
X-Hvy 121-163	●
Labels	●
Preprinted	●
Recycled	●
Glossy111-130g	●
Glossy131-175 g	●
Glossy176-220 g	●
HP Matte 120 g	●
HP Matte 150 g	●
HP Matte 200 g	●

a. The paper types available manual feeding in tray.

(●: Supported, Blank: Not supported)

Labels

To avoid damaging the machine, use only labels designed for use in laser printers.

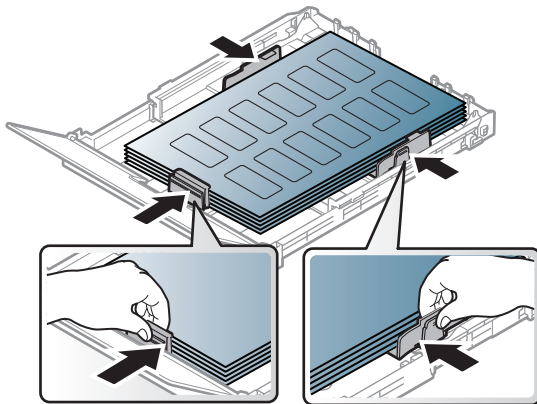

- When selecting labels, consider the following factors:
 - **Adhesives:** Should be stable at your machine's fusing temperature about 170°C (338°F).
 - **Arrangement:** Only use labels with no exposed backing between them. Labels can peel off sheets that have spaces between the labels, causing serious jams.
 - **Curl:** Must lie flat with no more than 13 mm of curl in any direction.
 - **Condition:** Do not use labels with wrinkles, bubbles, or other indications of separation.
- Make sure that there is no exposed adhesive material between labels. Exposed areas can cause labels to peel off during printing, which can cause paper jams. Exposed adhesive can also cause damage to machine components.
- Do not run a sheet of labels through the machine more than once. The adhesive backing is designed for only a single pass through the machine.
- Do not use labels that are separating from the backing sheet or are wrinkled, bubbled, or otherwise damaged.

X-Hvy 121-163/ Custom-sized paper

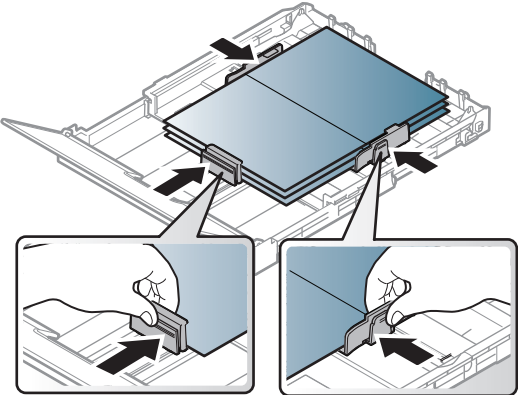

- In the software application, set the margins to at least 6.4 mm (0.25 inches) away from the edges of the material.

Preprinted paper

When loading preprinted paper, the printed side should be facing up with an uncurled edge at the front. If you experience problems with paper feeding, turn the paper around. Note that print quality is not guaranteed.

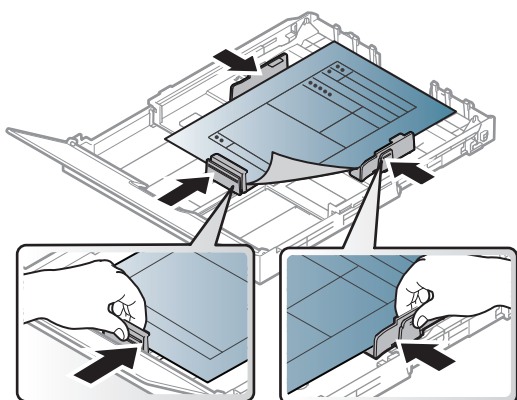

- Must be printed with heat-resistant ink that will not melt, vaporize, or release hazardous emissions when subjected to the machine's fusing temperature for 0.1 second (about 170°C (338°F)).
- Preprinted paper ink must be non-flammable and should not adversely affect machine rollers.
- Before you load preprinted paper, verify that the ink on the paper is dry. During the fusing process, wet ink can come off preprinted paper, reducing print quality.

Setting the paper size and type

After loading paper in the paper tray, set the paper size and type using the control panel buttons.

To change the paper setting set in the machine, set the paper type from the **Printing Preferences** window > **Paper** tab > **Paper Type** (see "Opening printing preferences" on page 76).



- It may be necessary to press **OK** to navigate to lower-level menus for some models.
- The paper setting in the machine and driver should match to print without a paper mismatch error.

You change the paper setting set in the machine from HP Embedded Web Server.

- If your machine is connected to the network, you can set the machine's setting from **HP Embedded Web Server** > **Settings** tab > **Machine Settings** (see "Using HP Embedded Web Server" on page 66).

- 1 Select **•••(Menu)** button on the control panel.
- 2 Press **System Setup** > **Paper Setup** > **Paper Size** or **Paper Type**.
- 3 Select the tray and the option you want.
- 4 Press **OK** to save the selection.

5 Press  (**Cancel**) to return to ready mode.



- If you want to use special-sized paper such as billing paper, select the **Paper** tab > **Size** > **Edit...** and set **Custom Paper Size Settings** in the **Printing Preferences** (see "Opening printing preferences" on page 76).
-

Using the output support



The surface of the output tray may become hot if you print a large number of pages at once. Make sure that you do not touch the surface, and do not allow children near it.

The printed pages stack on the output support, and the output support will help the printed pages to align. The printer sends output to the output tray by default.

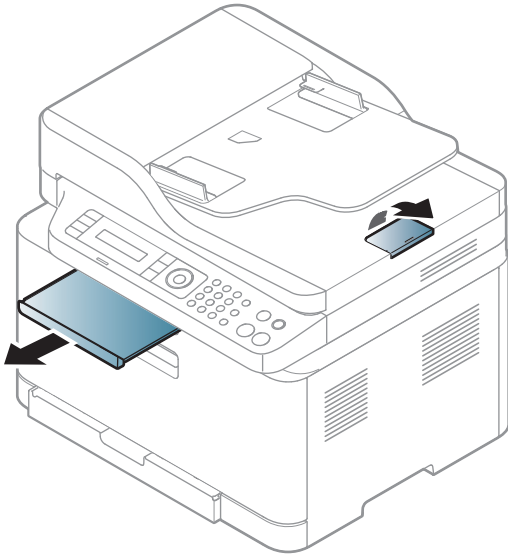

Illustrations on this user's guide may differ from your machine depending on its options or models. Check your machine type (see "Front view" on page 21).

Preparing originals

- Do not load paper smaller than 76 x 148.5 mm (3 x 5.85 inches) or larger than 216 x 356 mm (8.5 x 14 inches).
- Do not attempt to load the following s of paper, in order to prevent paper jam, low print quality and machine damage.
 - Carbon-paper or carbon-backed paper
 - Coated paper
 - Onion skin or thin paper
 - Wrinkled or creased paper
 - Curled or rolled paper
 - Torn paper
- Remove all staples and paper clips before loading.
- Make sure any glue, ink, or correction fluid on the paper is completely dry before loading.
- Do not load originals that include different sizes or weights of paper.
- Do not load booklets, pamphlets, transparencies, or documents with other unusual characteristics.

Loading originals

You can use the scanner glass or the document feeder to load an original for copying, scanning, and sending a fax.



Illustrations on this user's guide may differ from your machine depending on its options or models. Check your machine type (see "Front view" on page 21).

On the scanner glass

Using the scanner glass, you can copy or scan originals. You can get the best scan quality, especially for colored or gray-scaled images. Make sure that no originals are in the document feeder. If an original is detected in the document feeder, the machine gives it priority over the original on the scanner glass.

- 1 Lift and open the scanner lid.

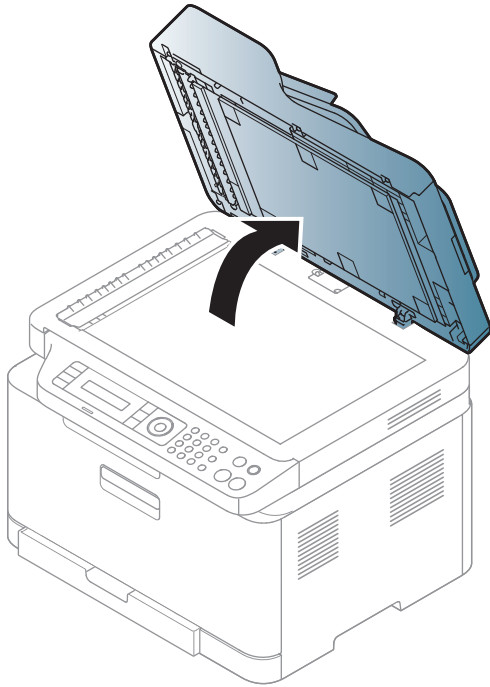

- 2 Place the original face down on the scanner glass. Align it with the registration guide at the top left corner of the glass.

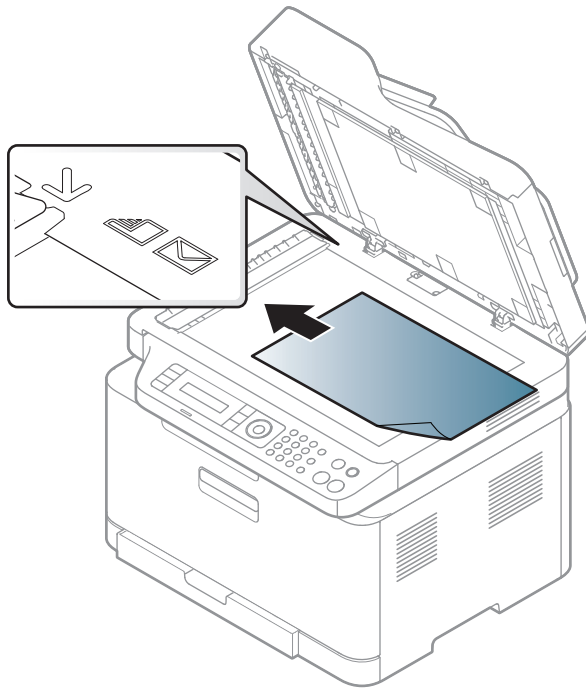

3 Close the scanner lid.



- Leaving the scanner lid open while copying may affect copy quality and toner consumption.
- Dust on the scanner glass may cause black spots on the printout. Always keep it clean (see "Cleaning the machine" on page 149).
- If you are copying a page from a book or magazine, lift the scanner lid until its hinges are caught by the stopper and then close the lid. If the book or magazine is thicker than 30 mm, start copying with the scanner lid open.



- Be careful not to break the scanner glass. You may get hurt.
- Do not put hands while closing the scanner lid. The scanner lid may fall on your hands and get hurt.
- Do not look into the light from inside of the scanner while copying or scanning. It is harmful to eyes.

In the document feeder

1 Flex or fan the edge of the paper stack to separate the pages before loading originals.

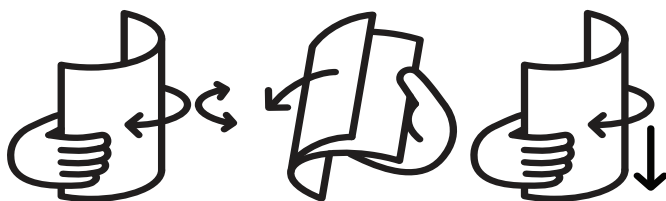

- 2 Load the original face up into the document feeder input tray. Make sure that the bottom of the original stack matches the paper size marked on the document input tray.

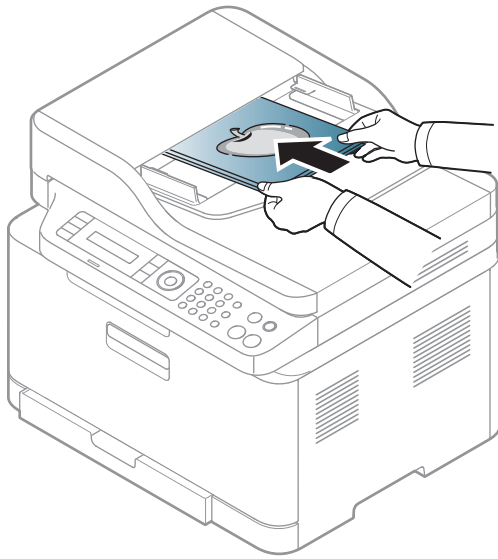

- 3 Adjust the document feeder width guides to the paper size.

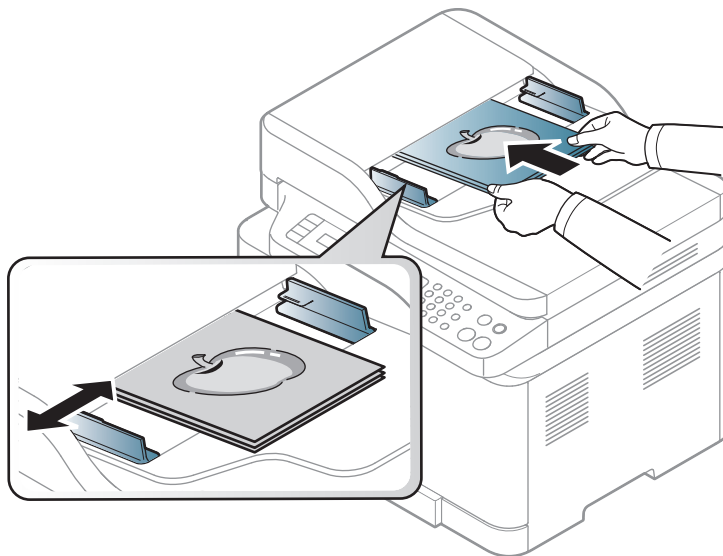

Dust on the document feeder glass may cause black lines on the printout. Always keep the glass clean (see "Cleaning the machine" on page 149).

Using a Network-Connected Machine

This chapter gives you step-by-step instructions for setting up a network connected machine and software.



Supported optional devices and features may differ according to your model (see "Features by model" on page 8).

- Wired network setup 55
- Installing driver over the network 57
- Wireless network setup 58
- Using HP Embedded Web Server 66
- HP Smart app 69

Wired network setup

Printing a network configuration report

You can print **Network Configuration Report** from the machine's control panel that will show the current machine's network settings. This will help you to set up a network.

Press the **••• (Menu)** button on the control panel and select **Network > Network Conf..**

Using this **Network Configuration Report**, you can find your machine's MAC address and IP address.

For example:

- MAC Address: 00:15:99:41:A2:78
- IP Address: 169.254.192.192

Setting IP address

First, you have to set up an IP address for network printing and managements. In most cases a new IP address will be automatically assigned by a DHCP (Dynamic Host Configuration Protocol) server located on the network.



When you install the printer driver, do not configure both IPv4 and IPv6. We recommend to configure either IPv4 or IPv6 (see "Installing driver over the network" on page 57).

IPv4 configuration



You can also set the TCP/IPv4 from **Embedded Web Server**. When the **Embedded Web Server** window opens, move the mouse cursor over the **Settings** of the top menu bar and then click **Network Settings** ("Settings tab" on page 67).

If you have a DHCPv4 server on your network, you can set one of the following options for default dynamic host configuration.

- 1 Select **••• (Menu) > Network > TCP/IP (IPv4) > DHCP** on the control panel.
- 2 Press **OK** to select the required value you want.

IPv6 configuration



You can also set the TCP/IPv6 from **HP Embedded Web Server**. When the **HP Embedded Web Server** window opens, move the mouse cursor over the **Settings** of the top menu bar and then click **Network Settings** ("Settings tab" on page 67).

IPv6 is supported properly only in Windows Server or higher.

The machine supports the following IPv6 addresses for network printing and managements.

- **Link-local Address:** Self-configured local IPv6 address (Address starts with FE80).
- **Stateless Address:** Automatically configured IPv6 address by a network router.
- **Stateful Address:** IPv6 address configured by a DHCPv6 server.
- **Manual Address:** Manually configured IPv6 address by a user.

In the IPv6 network environment, follow the next procedure to use the IPv6 address.

Activating IPv6

- 1 Press the **••• (Menu)** button on the control panel.
- 2 Press **Network > TCP/IP (IPv6) > IPv6 Protocol**
- 3 Select **On** and press **OK**.
- 4 Turn the machine off and turn it on again.

DHCPv6 address configuration

If you have a DHCPv6 server on your network, you can set one of the following options for default dynamic host configuration.

- 1 Press the **••• (Menu)** button on the control panel.
- 2 Press **Network > TCP/IP (IPv6) > DHCPv6 Config**
- 3 Press **OK** to select the required value you want.

Installing driver over the network



- Before installing, check whether your computer's OS support the software (see "Operating System" on page 8).
 - The machine that does not support the network interface, it will not be able to use this feature (see "Rear view" on page 23).
 - You need to download software packages from the HP website to install the printer software. For HP's all-inclusive help for the printer, go to www.hp.com/support/colorlaser170MFP.
-

Windows



The firewall software might be blocking network communication. Before connecting the device to the network, disable the computer's firewall.

- 1 Make sure that the machine is connected to the network and powered on. Also, your machine's IP address should have been set (see "Setting IP address" on page 55).
- 2 Download printer driver software from the HP website. (www.hp.com/support/colorlaser170MFP).
- 3 Turn on the machine.
- 4 Unzip the driver package and run the driver installer.
- 5 Follow the instructions in the installation window.

Wireless network setup



Wireless networking may not be available depending on the model (see "Features by model" on page 8).

Wireless networks require higher security, so when an access point is first set up, a network name (SSID), the type of security used, and a Network Password are created for the network. Ask your network administrator about this information before proceeding with the machine installation.

Introducing wireless set up methods

You can set wireless settings either from the machine or the computer. Choose the setting method from the below table.



- Some wireless network installation types may not be available depending on the model or country.
- It is strongly recommended that you set the password on Access Points. If you do not set the password on Access Points, they might be exposed to illegal access from unknown machines including PCs, smart phones and printers. Refer to the Access Point user' guide for password settings.

Set up method	Connecting method	Description & Reference
With Access Point	From the computer	See "Setting up via USB cable" on page 61 for Window.
		See "Access point without a USB cable" on page 62 for Window.
		See "Using a network cable" on page 62.
	From the machine's control panel	See "Using the WPS Settings" on page 59.
		See "Using the Wi-Fi Networks" on page 60.
From the HP Smart app	See "Connect using the HP Smart app" on page 70.	
Wi-Fi Direct setup		See "Setting the Wi-Fi Direct for mobile printing" on page 64.

Restoring the wireless network settings

You can revert the wireless network settings to the default values.

Press the **••• (Menu)** button > **Network** > **Wi-Fi** > **Wi-Fi Default** > **Restore...** on the control panel. The machine starts restoring default wireless network settings.

Using the WPS Settings

If your machine and access point (or wireless router) support Wi-Fi Protected Setup™ (WPS), then you can easily configure the wireless network settings through the **WPS** menu without the need for a computer.

Items to prepare:

- Check if the access point (or wireless router) supports Wi-Fi Protected Setup™ (WPS).
- Check if your machine supports Wi-Fi Protected Setup™ (WPS).

1 Press the **••• (Menu)** button > **Network** > **Wi-Fi** > **WPS** > **PBC** on the control panel.

The machine starts connecting to the wireless network.

- 2 **Within 2 minutes**, press the **WPS (PBC)** button on the access point (or wireless router).
 - a. The machine is connecting to the access point (or wireless router).
 - b. When the machine is successfully connected to the wireless network, the LED light stays on.
- 3 Continue to install the software.

Using the Wi-Fi Networks

Before starting, you will need to know the network name (SSID) of your wireless network and the network key if it is encrypted. This information was set when the access point (or wireless router) was installed. If you do not know about your wireless environment, please ask the person who set up your network.

- 1 Select the **••• (Menu) > Network > Wi-Fi > Wi-Fi Settings** button on the control panel.
Or, Press the **() (Wireless)**, access to the **Wi-Fi** menu.
- 2 Press the **OK** to select the setup method you want.
 - **Wizard > Search List (recommended)**: In this mode, the setup is automatic. The machine will display a list of available networks from which to choose. After a network is chosen then printer will prompt for the corresponding security key.
 - **Custom**: In this mode, users can give or edit manually their own SSID, or choose the security option in detail.
- 3 Follow the instructions to set up the wireless network.

Setup using Windows

Setting up via USB cable

Items to prepare

- Access point
- Network-connected computer
- You need to download software packages from the HP website to install the printer software. For HP's all-inclusive help for the printer, go to www.hp.com/support/colorlaser170MFP.
- A machine installed with a wireless network interface
- USB cable

- 1 Check whether the USB cable is connected to the machine.
- 2 Turn on your computer, access point, and machine.
- 3 Download printer driver software from the HP website (www.hp.com/support/colorlaser170MFP).
- 4 Unzip the driver package and run the driver installer.
- 5 Review and accept the installation agreements in the installation window. Then, click **Next**.
- 6 Select **Wireless** on the **Printer Connection Type** screen. Then, click **Next**.
- 7 On the **Are you setting up your printer for the first time?** screen, select **Yes, I will set up my printer's wireless network**. Then, click **Next**.
If your printer is already connected on the network, select **No, my printer is already connected to my network**.
- 8 Select **Using a USB cable** on the **Select the Wireless Setup Method** screen. Then, click **Next**.
- 9 After searching, the window shows the wireless network devices. Select the name (SSID) of the access point you want to use and click **Next**.
- 10 When the wireless network set up is completed, disconnect the USB cable between the computer and machine. Click **Next**.
- 11 Select the components to be installed.
- 12 Follow the instructions in the installation window.

Access point without a USB cable

Items to prepare

- Wi-Fi-enabled PC running Windows 7 or higher and an access point (router)
- You need to download software packages from the HP website to install the printer software. For HP's all-inclusive help for the printer, go to www.hp.com/support/colorlaser170MFP.
- A machine installed with a wireless network interface



While setting the wireless network, the machine uses PC's wireless LAN. You might not be able to connect to the Internet.

- 1 Turn on your computer, access point, and machine.
- 2 Download printer driver software from the HP website (www.hp.com/support/colorlaser170MFP).
- 3 Unzip the driver package and run the driver installer.
- 4 Review and accept the installation agreements in the installation window. Then, click **Next**.
- 5 Select **Wireless** on the **Printer Connection Type** screen. Then, click **Next**.
- 6 On the **Are you setting up your printer for the first time?** screen, select **Yes, I will set up my printer's wireless network**. Then, click **Next**.
If your printer is already connected on the network, select **No, my printer is already connected to my network**.
- 7 Select **Using a direct wireless connection** on the **Select the Wireless Setup Method** screen. Then, click **Next**.
- 8 When the wireless network set up is completed, click **Next**.
- 9 Follow the instructions in the installation window.

Using a network cable



See your network administrator, or the person that set up your wireless network, for information about your network configuration.

Your machine is a network compatible machine. To enable your machine to work with your network, you will need to perform some configuration procedures.

Items to prepare

- Access point
- Network-connected computer
- You need to download software packages from the HP website to install the printer software. For HP's all-inclusive help for the printer, go to www.hp.com/support/colorlaser170MFP.
- A machine installed with a wireless network interface
- Network cable

Printing a network configuration report

You can identify the network settings of your machine by printing a network configuration report. See "Printing a network configuration report" on page 55.

Configuring the machine's wireless network

Before starting you will need to know the network name (SSID) of your wireless network and the network key if it is encrypted. This information was set when the access point (or wireless router) was installed. If you do not know about your wireless environment, please ask the person who set up your network.

To configure wireless parameters, you can use **HP Embedded Web Server**.

Using HP Embedded Web Server

Before starting wireless parameter configuration, check the cable connection status.

- 1 Check whether or not the network cable is connected to the machine. If not, connect the machine with a standard network cable.
- 2 Start a web browser such as Internet Explorer, Safari, or Firefox and enter your machine's new IP address in the browser window.

For example,



- 3 Click **Login** on the upper right of the HP Embedded Web Server website.
- 4 If it's your first time logging into **HP Embedded Web Server** you need to log-in as an administrator. Type in the below default **ID (admin)**. We recommend you to set the default password for security reasons.
- 5 When the **HP Embedded Web Server** window opens, click **Network Settings**.

6 Click **Wi-Fi > Wizard**.

7 Select the one **Network Name (SSID)** in the list.

8 Click **Next**.

If the wireless security setting window appears, enter the registered password (network password) and click **Next**.

9 The confirmation window appears, please check your wireless setup. If the setup is right, click **Apply**.

Setting the Wi-Fi Direct for mobile printing

Wi-Fi Direct is a secure and easy-to-use peer-to-peer connection between a Wi-Fi Direct-enabled printer and mobile device.

With Wi-Fi Direct, you can connect your printer to a Wi-Fi Direct network while concurrently connecting to an access point. You can also use a wired network and a Wi-Fi Direct network simultaneously so multiple users can access and print documents both from Wi-Fi Direct and from a wired network.



- You cannot connect your mobile device to the internet through the printer's Wi-Fi Direct.
- The supported protocol list may differ from your model, Wi-Fi Direct networks do NOT support IPv6, network filtering, IPSec, WINS, and SLP services.
- The maximum number of devices that can be connected via Wi-Fi Direct is 4.

Setting up Wi-Fi Direct

You can enable Wi-Fi Direct feature by one of the following methods.

From the machine

1 Press the **••• (Menu)** button on the control panel and select **Network > Wi-Fi > Wi-Fi Direct** from the display screen.

2 Tap **On/Off > On**.

3 Enable **Wi-Fi Direct**.

From the network-connected computer

If your printer is using a network cable or a wireless access point, you can enable and configure Wi-Fi Direct from HP Embedded Web Server.

- 1 Access **HP Embedded Web Server** and select **Settings > Network Settings > Wi-Fi > Wi-Fi Direct™**.
- 2 Enable **Wi-Fi Direct™** and set other options.

Setting up the mobile device

- After setting up Wi-Fi Direct from the printer, refer to the user manual of the mobile device you are using to set its Wi-Fi Direct.
- After setting up Wi-Fi Direct, you need to download the mobile printing application (For example: HP Smart) to print from your smartphone.



- When you have found the printer you want to connect to from your mobile device, select the printer and the printer's LED will blink. Press the Wireless button on the printer and it will be connected to your mobile device. If you don't have Wireless button, press the option you want when the Wi-Fi connection confirmed window appears from the display screen and it will be connected to your mobile device.
 - If your mobile device does not support Wi-Fi Direct, you need to enter the "Network Key" of a printer instead of pushing the Wireless button.
-

Using HP Embedded Web Server



- Internet Explorer 8.0 or higher is the minimum requirement for HP Embedded Web Server.
- Before using the programs below, set the IP address first.
- HP Embedded Web Server explanation in this user's guide may differ from your machine depending on its options or models.
- Network model only (see "Variety feature" on page 10).

There are several programs available to setup the network settings easily in a network environment. For the network administrator especially, managing several machines on the network is possible.

HP Embedded Web Server

The web server embedded on your network machine allows you to do the following tasks:

- Check the supplies information and status.
- Customize machine settings.
- Configure the network parameters necessary for the machine to connect to various network environments.

Accessing HP Embedded Web Server

- 1 Access a web browser, such as Internet Explorer, from Windows.

Enter the machine IP address of your printer (<http://xxx.xxx.xxx.xxx>) in the address field and press the Enter key or click **Go**.

- 2 Your machine's embedded website opens.

Logging into HP Embedded Web Server

Before configuring options in HP Embedded Web Server, you need to log-in as an administrator. You can still use HP Embedded Web Server without logging in but you won't have access to **Settings** tab and **Security** tab.

- 1 Click **Login** on the upper right of the HP Embedded Web Server website.

- 2 If it's your first time logging into **HP Embedded Web Server** you need to log-in as an administrator. Type in the below default **ID (admin)**. We recommend you to set the default password for security reasons.

HP Embedded Web Server overview



Some tabs may not appear depending on your model.

Information tab

This tab gives you general information about your machine. You can check things, such as remaining amount of toner. You can also print reports, such as an error report.

- **Active Alerts:** Shows the alerts that have occurred in the machine and their severity.
- **Supplies:** Shows how many pages are printed and amount of toner left in the cartridge.
- **Usage Counters:** Shows the usage count by print types: simplex and duplex.
- **Current Settings:** Shows the machine's and network's information.
- **Print information:** Prints reports such as system related reports, e-mail address, and font reports.
- **Security Information:** Shows the machine's security information.

Settings tab

This tab allows you to set configurations provided by your machine and network. You need to log-in as an administrator to view this tab.

- **Machine Settings tab:** Sets options provided by your machine.
- **Network Settings tab:** Shows options for the network environment. Sets options such as TCP/IP and network protocols.

Security tab

This tab allows you to set system and network security information. You need to log-in as an administrator to view this tab.

- **System Security:** Sets the system administrator's information and also enables or disables machine features.
- **Network Security:** Sets settings for IPv4/IPv6 filtering.

Maintenance tab

This tab allows you to maintain your machine by upgrading firmware and setting contact information for sending emails. You can also connect to HP website or download drivers by selecting the **Link** menu.

- **Firmware Upgrade:** Upgrade your machine's firmware.
- **Contact Information:** Shows the contact information.
- **Link:** Shows links to useful sites where you can download or check information.

Setting the system administrator's information



Some menus may not appear in the display depending on options or models. If so, it is not applicable to your machine.

- 1 Start a web browser, such as Internet Explorer, from Windows.
Enter the machine IP address (http://xxx.xxx.xxx.xxx) in the address field and press the Enter key or click **Go**.
- 2 Your machine's embedded website opens.
- 3 From the **Security** tab, select **System Security > System Administrator**
- 4 Enter the name of the administrator, phone number, location, and email address.
- 5 Click **Apply**.

HP Smart app

HP Smart helps you to set up, scan, print, share, and manage your HP printer. You can share documents and images through email, text messages, and popular cloud and social media services (such as iCloud, Google Drive, Dropbox, and Facebook). You can also set up new HP printers, as well as monitor and order supplies.



- The HP Smart app might not be available in all languages. Some features might not be available with all printer models.
- If HP smart app does not work well on your Windows devices, update the printer firmware and try again.

-
- **To install the HP Smart app :** The HP Smart app is supported on iOS, Android, and Windows 10 devices. To install the app on your device, go to 123.hp.com and follow the on screen instructions to access your device's app store.
 - **To open the HP Smart app on a Windows 10 computer :** After installing the HP Smart app, from the device desktop, click **Start**, and then select **HP Smart** from the app list.
 - **Connect to printer :** Make sure that the printer is turned on and is connected to the same network as your device. Then HP Smart will automatically detect the printer.
 - **Get more information about the HP Smart app :** For basic instructions on how to print, scan, and troubleshoot using HP Smart.
 - See "Print using the HP Smart app" on page 71.
 - See "Scan using the HP Smart app" on page 72.
 - See "Get help from the HP Smart app" on page 72.

For more information about using HP Smart for printing, scanning, accessing printer features, and troubleshooting issues, go to:



- **iOS/Android:** www.hp.com/go/hpsmart-help
- **Windows:** www.hp.com/go/hpsmartwin-help

Connect using the HP Smart app

You can use the HP Smart app to set up the printer on your wireless network. The HP Smart app is supported on iOS, Android, and Windows devices.

- 1 Make sure your computer or mobile device is connected to your wireless network and you know the password of your wireless network.
- 2 Check if the printer is in the Auto Wireless Connect (AWC) setup mode.

If this is the first time you set up the printer, the printer is ready for setup after the printer is powered on. It keeps searching for the HP Smart app to connect within **2** hours, and then stops searching.

To put the control panel to the Auto Wireless Connect (AWC) setup mode, press and hold the  (**Wireless**) button for at least **20** seconds until the  (**Status**) and the  (**Power**) LED start blinking together.
- 3 Open the HP Smart app, and then do one of the following:
 - **Windows:** On the home screen, click or tap **Find Printer**. If the printer is not found, click or tap **Set up a new printer**. Follow the onscreen instructions to add the printer to your network.
 - **iOS/Android:** On the home screen, tap the Plus icon and then select the printer. If the printer is not in the list, tap **Add a new printer**. Follow the onscreen instructions to add the printer to your network.

Change the default printer setting the HP Smart app

You can set the printer setting from HP Smart app.

- 1 Open the HP Smart app.
- 2 Tap the Plus icon if you need to change to a different printer, or add a new printer.
- 3 Tap **Printer Settings**.
- 4 Select the option you want, and then change the setting.

Print using the HP Smart app

This section provides basic instructions for using the HP Smart app to print from your Android, iOS, or Windows 10 device.

To print from an Android or iOS device

- 1 Open the HP Smart app.
- 2 Tap the Plus icon if you need to change to a different printer, or add a new printer.
- 3 Tap a printing option.
- 4 Select the photo or document you want to print.
- 5 Tap **Print**.

To print from a Windows 10 device

- 1 Load paper in the tray (see "Loading paper in the tray" on page 41).
- 2 Open HP Smart.
- 3 On the HP Smart Home screen, make sure your printer is selected.



If you want to select a different printer, click or tap the Printer icon on the toolbar at the left side of the screen, and then select **Select a Different Printer** to view all available printers.

- 4 At the bottom of the Home screen, click or tap **Print**.
- 5 Select **Print Photo**, locate a photo you want to print, and then click or tap **Select Photos to Print**.
Select **Print Document**, locate a PDF document you want to print, and then click or tap **Print**.
- 6 Select the appropriate options.
- 7 Click or tap **Print** to begin printing.

Scan using the HP Smart app

You can use the HP Smart app to scan documents or photos using your device camera. HP Smart includes editing tools that allow you to adjust the scanned image before saving or sharing. You can print, save your scans locally or in cloud storage, and share them via email, SMS, Facebook, Instagram, etc.

To scan from an Android or iOS device

- 1 Open the HP Smart app.
- 2 Tap the Plus icon if you need to change to a different printer, or add a new printer.
- 3 Select a scan option, and then tap **Camera**. The built-in camera will open. Scan your photo or document using the camera.
- 4 When you have finished adjusting the scanned document or photo, save, share, or print it.

To scan from a Windows 10 device

To scan a document or photo using the device camera

If your device has a camera, you can use the HP Smart app to scan a printed document or photo with the device camera. You can then use HP Smart to edit, save, print or share the image.

1. Open HP Smart.
2. Select **Scan > Camera**.
3. Put a document or photo in front of the camera, it take an image. If necessary, change the scan option by pressing the **Apply**.
4. Select the file type you want
5. Click or tap the **Save** or **Share** icon.

To edit a previously scanned document or photo

HP Smart provides editing tools, such as crop or rotate, so that you can use to adjust a previously scanned document or photo on your device.

1. Open HP Smart.
2. Select **Scan > Import**.
3. Select the document or photo that you want to adjust, and then click or tap **Open**. If necessary, change the scan option by pressing the **Apply**.
4. Select the file type you want
5. Click or tap the **Save** or **Share** icon.

Get help from the HP Smart app

The HP Smart app provides alerts for printer issues (jams and other problems), links to help content, and options to contact support for additional assistance.

Printing

This chapter provides information about the overall print options. This section is mainly based on Windows 7.



You need to download software packages from the HP website to install the printer software. For HP's all-inclusive help for the printer, go to www.hp.com/support > select your country and region > find your product.

- Basic Print 74
- Canceling a print job 75
- Opening printing preferences 76
- Using a favorite setting 77
- Using help 78
- Printing features 79
- Using Printer Status programs 84

Basic Print

The following **Printing Preferences** window is for Notepad in Windows 7. Your **Printing Preferences** window may differ, depending on your operating system or the application you are using.

- 1 Open the document you want to print.
- 2 Select **Print** from the **File** menu.
- 3 Select your machine from the **Select Printer** list.
- 4 The basic print settings including the number of copies and print range are selected within the **Print** window.





To take advantage of the advanced printing features, click **Properties** or **Preferences** from the **Print** window (see "Opening printing preferences" on page 76).

- 5 To start the print job, click **OK** or **Print** in the **Print** window.





Canceling a print job

If the print job is waiting in the print queue or print spooler, cancel the job as follows:

- You can access this window by simply double-clicking the machine icon () in the Windows task bar.
- You can also cancel the current job by pressing  (**Cancel**) on the control panel.

Opening printing preferences



- The **Printing Preferences** window that appears in this user's guide may differ depending on the machine in use.
 - When you select an option in **Printing Preferences**, you may see a warning mark  or . An  mark means you can select that certain option but it is not recommended, and an  mark means you cannot select that option due to the machine's setting or environment.
-

- 1 Open the document you want to print.
 - 2 Select **Print** from the file menu. The **Print** window appears.
 - 3 Select your machine from the **Select Printer**.
 - 4 Click **Properties** or **Preferences**. Click or tap the tabs in the print driver to configure the available options.
-



- In Windows 10, 8.1, and 8, these applications will have a different layout with different features from what is described below for desktop applications. To access the print feature from a **Start** screen app, complete the following steps:
 - **Windows 10:** Select **Print**, and then select the printer.
 - **Windows 8.1 or 8:** Select **Devices**, select **Print**, and then select the printer.
 - You can check the machine's current status pressing the **Printer Status** button (see "Using Printer Status programs" on page 84).
-

Using a favorite setting

The **Favorites** option, which is visible on each preferences tab except for the **HP** tab, allows you to save the current preferences for future use.

To save a **Favorites** item, follow these steps:

- 1 Change the settings as needed on each tab.
- 2 Enter a name for the item in the **Favorites** input box.
- 3 Click **Save**.
- 4 Enter name and description, and then select the desired icon.
- 5 Click **OK**. When you save **Favorites**, all current driver settings are saved.



To use a saved setting, select it in the **Favorites** tab. The machine is now set to print according to the settings you have selected. To delete saved settings, select it in the **Favorites** tab and click **Delete**.

Using help

Click the option you want to know on the **Printing Preferences** window and press **F1** on your keyboard.

Printing features



- This feature may not be available depending on model or optional goods (see "Features by model" on page 8).
- You need to download software packages from the HP website to install the printer software. For HP's all-inclusive help for the printer, go to www.hp.com/support/colorlaser170MFP.

Understanding special printer features





You can use advanced printing features when using your machine.

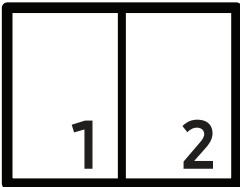
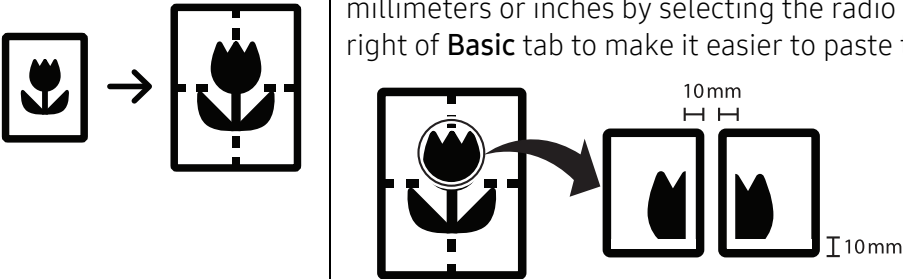

To take advantage of the printer features provided by your printer driver, click **Properties** or **Preferences** in the application's **Print** window to change the print settings. The machine name that appears in the printer properties window may differ depending on the machine in use.

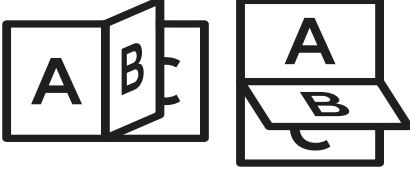
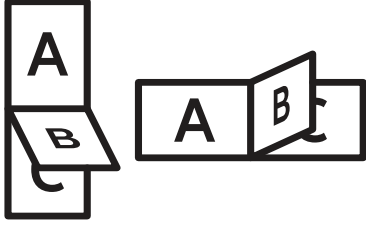
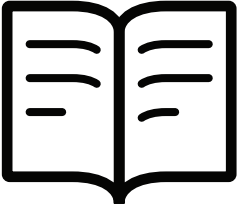

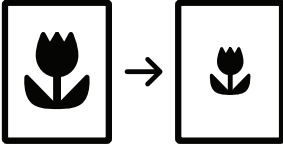

- Some menus may not appear on the display depending on options or models. If so, it is not applicable to your machine.
- Select the **Help** menu or click the  button from the window or press **F1** on your keyboard and click on any option you want to know about (see "Using help" on page 78).

Item	Description
<p>Multiple Pages per Side</p> 	<p>Selects the number of pages to print on a single sheet of paper. To print more than one page per sheet, the pages will be reduced in size and arranged in the order you specify. You can print up to 16 pages on one sheet.</p>
<p>Poster Printing</p> 	<p>Prints a single-page document onto 4 (Poster 2x2), 9 (Poster 3x3), or 16 (Poster 4x4) sheets of paper, for the purpose of pasting the sheets together to form one poster-size document.</p> <p>Select the Poster Overlap value. Specify Poster Overlap in millimeters or inches by selecting the radio button on the upper right of Basic tab to make it easier to paste the sheets together.</p>

Item	Description
<p data-bbox="277 792 564 864">Double-sided Printing (Manual)</p>	<p data-bbox="625 250 1442 322">Print on both sides of a sheet of paper (duplex). Before printing, decide how you want your document oriented.</p> <p data-bbox="632 371 687 427"></p> <ul data-bbox="716 389 1474 730" style="list-style-type: none"> <li data-bbox="716 389 1474 495">• This option is available only when you use the PCL/SPL printer driver. This option is not available when you use XPS driver. <li data-bbox="716 506 1474 651">• If your machine does not have a duplex unit, you should complete the printing job manually. The machine prints every other page of the document first. After that, a message appears on your computer. <li data-bbox="716 663 1474 730">• Skip Blank Pages feature does not work when you select the duplex option. <ul data-bbox="625 763 1382 875" style="list-style-type: none"> <li data-bbox="625 763 1007 797">• None: Disables this feature. <li data-bbox="625 801 1382 875">• Long Edge: This option is the conventional layout used in bookbinding. <div data-bbox="651 898 1062 1066">  </div> <ul data-bbox="625 1084 1390 1155" style="list-style-type: none"> <li data-bbox="625 1084 1390 1155">• Short Edge: This option is the conventional layout used in calendars. <div data-bbox="679 1178 1046 1402">  </div>
<p data-bbox="277 1536 491 1570">Booklet Printing</p> 	<p data-bbox="625 1435 1437 1547">Prints your document on both sides of a sheet of paper and arranges the pages so that the paper can be folded in half after printing to produce a booklet.</p> <p data-bbox="632 1597 687 1653"></p> <ul data-bbox="716 1615 1474 1805" style="list-style-type: none"> <li data-bbox="716 1615 1474 1720">• The Booklet Printing option is not available for all paper sizes. Select the available paper Size option under the Paper tab to see what paper sizes are available. <li data-bbox="716 1731 1474 1805">• If you select an unavailable paper size, this option can be automatically canceled. Select only available paper (paper <p data-bbox="743 1816 1086 1872">without  or  mark).</p>

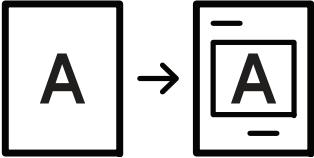
Item	Description
<p>Paper Options</p> 	<p>Changes the size of a document to appear larger or smaller on the printed page by entering in a percentage by which to enlarge or decrease the document.</p>
<p>Watermark</p> 	<p>The watermark option allows you to print text over an existing document. For example, you use it when you want to have large gray letters reading “DRAFT” or “CONFIDENTIAL” printed diagonally across the first page or all pages of a document.</p>
<p>Watermark (Creating a watermark)</p>	<ol style="list-style-type: none"> To change the print settings from your software application, access Printing Preferences (see "Opening printing preferences" on page 76). From the Advanced tab, select Edit... from the Watermark drop-down list. Enter a text message in the Watermark Message box. You can enter up to 256 characters. When the First Page Only box is checked, the watermark prints on the first page only. Select watermark options. You can select the font name, style, size, and shade from the Font Attributes section, as well as set the angle of the watermark from the Watermark Alignment and Angle section. Click Add to add a new watermark to the Current Watermarks list. When you finish editing, click OK or Print until you exit the Print window.
<p>Watermark (Editing a watermark)</p>	<ol style="list-style-type: none"> To change the print settings from your software application, access Printing Preferences (see "Opening printing preferences" on page 76). Click the Advanced tab, select Edit... from the Watermark drop-down list. Select the watermark you want to edit from the Current Watermarks list and change the watermark message and options. Click Update to save the changes. Click OK or Print until you exit the Print window.

Item	Description
<p>Watermark (Deleting a watermark)</p>	<p>a. To change the print settings from your software application, access Printing Preferences.</p> <p>b. Click the Advanced tab, select Edit... from the Watermark drop-down list.</p> <p>c. Select the watermark you want to delete from the Current Watermarks list and click Delete.</p> <p>d. Click OK or Print until you exit the Print window.</p>
<p>Overlay</p> 	<p>An overlay is text and/or images stored in the computer hard disk drive (HDD) as a special file format that can be printed on any document. Overlays are often used to take the place of letterhead paper. Rather than using preprinted letterhead, you can create an overlay containing exactly the same information that is currently on your letterhead. To print a letter with your company's letterhead, you do not need to load preprinted letterhead paper in the machine: just print the letterhead overlay on your document.</p> <p>To use a page overlay, you must create a new page overlay containing your logo or image.</p> <ul style="list-style-type: none">  • The overlay document size must be the same as the document you print with the overlay. Do not create an overlay with a watermark. • The resolution of the overlay document must be the same as that of the document you will print with the overlay.
<p>Overlay (Creating an overlay)</p>	<p>a. Create or open a document containing text or an image for use in a new page overlay. Position the items exactly as you wish them to appear when printed as an overlay.</p> <p>b. To save the document as an overlay, access Printing Preferences.</p> <p>c. Click the Advanced tab, and select Create from the Overlay drop-down list.</p> <p>d. In the Save As window, type a name up to eight characters in the File name box. Select the destination path, if necessary (The default is C:\Formover).</p> <p>e. Click Save.</p> <p>f. Click OK or Print until you exit the Print window. When a confirming message window appears, click Yes.</p> <p>g. The file is not printed. Instead, it is stored on your computer hard disk drive.</p>

Item	Description
<p>Overlay (Using a page overlay)</p>	<p>a. Create or open the document you want to print.</p> <p>b. To change the print settings from your software application, access Printing Preferences.</p> <p>c. Click the Advanced tab.</p> <p>d. Select the Print Overlay from the Overlay drop-down list.</p> <p>e. If you have stored the overlay file you want to use in an external source, you can also load the file when you access the Load window. After you select the file, click Open. The file appears in the Overlay List box and is available for printing. Select the overlay from the Overlay List box.</p> <p>f. If necessary, check Confirm Page Overlay When Printing box. If this box is checked, a message window appears each time you submit a document for printing, asking you to confirm your wish to print an overlay on your document. If this box is not checked and an overlay has been selected, the overlay automatically prints with your document.</p> <p>g. Click OK or Print until you exit the Print window. The selected overlay prints on your document.</p>
<p>Overlay (Deleting a page overlay)</p>	<p>a. In the Printing Preferences window, click the Advanced tab.</p> <p>b. Select Edit in the Text drop down list.</p> <p>c. Select the overlay you want to delete from the Overlay List box.</p> <p>d. Click Delete.</p> <p>e. When a confirming message window appears, click Yes.</p> <p>f. Click OK or Print until you exit the Print window. You can delete page overlays that you no longer use.</p>

Using Printer Status programs

The Printer Status is a program that monitors and informs you of the machine status.





- The Printer Status window and its contents shown in this user's guide may differ depending on the machine or operating system in use.
 - Check the operating system(s) that are compatible with your machine (see "General Specifications" on page 191).
 - Available for Windows OS users only (see "Software" on page 9).
-

Printer Status overview

If an error occurs while operating, you can check the error from the Printer Status. Printer Status is installed automatically when you install the machine software.

You can also launch Printer Status manually. Go to the **Printing Preferences**, click the tab except for the **HP** tab > **Printer Status** button. The **Favorites** option, which is visible on each preferences tab except for the **HP** tab.

These icons appear on the Windows task bar:

Icon	Mean	Description
	Normal	The machine is in ready mode and experiencing no errors or warnings.
	Warning	The machine is in a state where an error might occur in the future. For example, it might be in toner low status, which may lead to toner empty status.
	Error	The machine has at least one error.

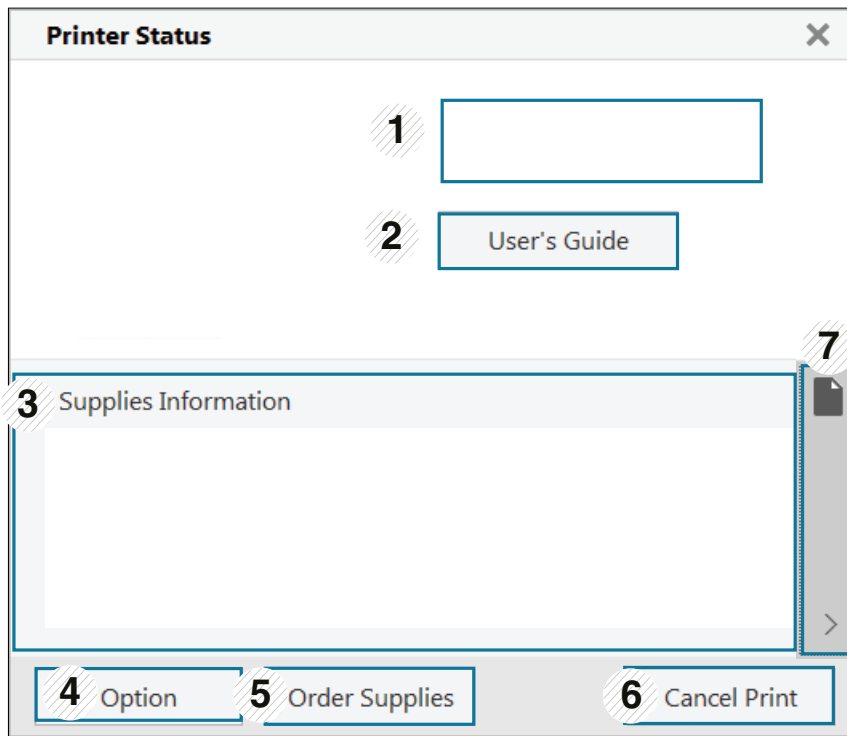

1	Device Information	You can see the device status, current printer model name, connected port name in this area.
2	User's Guide	User's Guide is disabled. You can download User's Guide in site www.hp.com/support/colorlaser170MFP .
3	Supplies Information	You can view the percentage of toner remaining in each toner cartridge. The machine and the number of toner cartridge(s) shown in the above window may differ depending on the machine in use. Some machines do not have this feature.
4	Option	You can set printing job alert related settings.
5	Order Supplies	You can order replacement toner cartridge(s) from online.
6	Cancel Print or Close	<ul style="list-style-type: none"> • Cancel Print : If print job is waiting in the print queue or printer, cancel all user's print jobs in the print queue or the printer. • Close : Depending on the status of the machine or the supported functions, the Close button may appear to close the status window.
7	Toner/Paper Information	This button areas for paper and toner info will be available based on the device.

Copying

This chapter provides information about the overall copy options.

- Basic copy **87**
- Changing the settings for each copy **88**
- ID card copying **90**

Basic copy



- Accessing menus may differ from model to model (see "Accessing the menu" on page 30 or "Control panel overview" on page 24).
 - Depending on models or options, some menus may not be supported (see "Features by model" on page 8).
-

1 Select  (copy) > **...** (Menu) > **Copy Feature** on the control panel.
Or select **...** (Menu) > **Copy Feature** on the control panel.

2 Place a single document (see "Loading originals" on page 51).

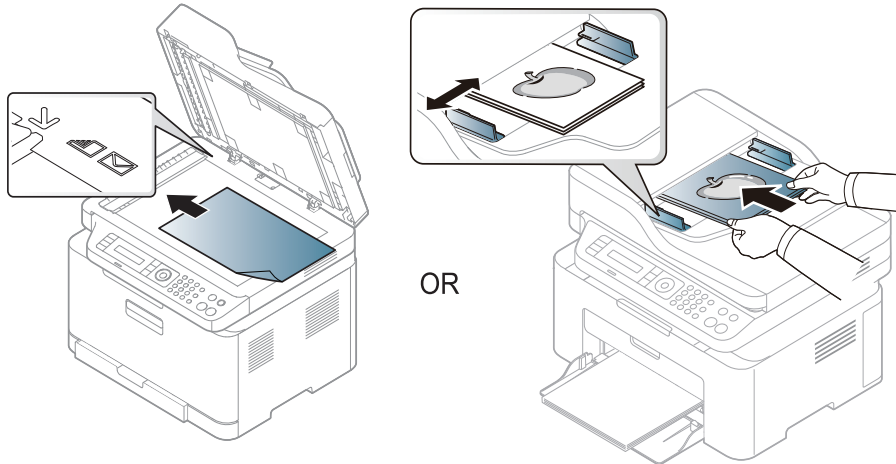

3 If you want to customize the copy settings including **Reduce/Enlarge**, **Darkness**, **Original**, and more by using the control panel buttons (see "Changing the settings for each copy" on page 88).

4 Enter the number of copies using the arrow or number keypad, if necessary.

5 Press  (**Start**).



If you need to cancel the copying job during the operation, press  (**Cancel**) and the copying will stop.

Changing the settings for each copy



Your machine provides default settings for copying so that you can quickly and easily make a copy. However, if you want to change the options for each copy, use the copy function buttons on the control panel.



- If you press  (**Cancel**) while setting the copy options, all of the options you have set for the current copy job will be canceled and returned to their default status. Or, they will automatically return to their default status after the machine completes the copy in progress.
- Accessing menus may differ from model to model (see "Accessing the menu" on page 30).
- It may be necessary to press **OK** to navigate to lower-level menus for some models.

Darkness

If you have an original containing faint marking and dark images, you can adjust the brightness to make a copy that is easier to read.

- 1 Select  (copy) > **...** (Menu) > **Copy Feature** > **Darkness** on the control panel.
Or select **Contrast** button on the control panel.
- 2 Select the option you want and press **OK**.
For example, the **Light+5** being the lightest, and the **Dark+5** being the darkest.
- 3 Press  (**Cancel**) to return to ready mode.

Original type

The original setting is used to improve the copy quality by selecting the document for the current copy job.

- 1 Select  (copy) > **...** (Menu) > **Copy Feature** > **Original Type** on the control panel.
Or select **...** (Menu) > **Copy Feature** > **Original Type** on the control panel.
- 2 Select the option you want and press **OK**.
 - **Text**: Use for originals containing mostly text.

- **Text/Photo:** Use for originals with mixed text and photographs.



If texts in the printout is blurry, select **Text** to get the clear texts.

- **Photo:** Use when the originals are photographs.
- **Magazine:** Use when the originals are magazine.

3 Press  (**Cancel**) to return to ready mode.

Reduced or enlarged copy

You can reduce or enlarge the size of a copied image from 25% to 400% when you copy original documents from the scanner glass.



- This feature may not be available depending on model or optional goods (see "Variety feature" on page 10).
- If the machine set to Eco mode, reduce and enlarge features are not available.

To select from the predefined copy sizes

1 Select  (copy) > **...** (Menu) > **Copy Feature** > **Reduce/Enlarge** on the control panel.
Or select **...** (Menu) > **Copy Feature** > **Reduce/Enlarge** on the control panel.

2 Select the option you want and press **OK**.

3 Press  (**Cancel**) to return to ready mode.

To scale the copy by directly entering the scale rate

1 Select  (copy) > **...** (Menu) > **Copy Feature** > **Reduce/Enlarge** > **Custom** on the control panel.
Or select **...** (Menu) > **Copy Feature** > **Reduce/Enlarge** on the control panel.

2 Enter the copy size you want using the numeric keypad.

3 Press **OK** to save the selection.

4 Press  (**Cancel**) to return to ready mode.



When you make a reduced copy, black lines may appear at the bottom of your copy.

ID card copying

Your machine can print 2-sided originals on one sheet.

The machine prints one side of the original on the upper half of the paper and the other side on the lower half without reducing the size of the original. This feature is helpful for copying a small-sized item such as business card.



- The original must be placed on the scanner glass to use this feature.
 - If the machine set to Eco mode, this feature is not available.
 - For better image quality, Select  (copy) > ... (Menu) > Copy Feature > Original Type > Photo on the control panel or ... (Menu) > Copy Feature > Original Type > Photo.
-

- 1 Press **ID Copy** on the control panel.
- 2 Place the front side of an original facing down on the center of first half of the scanner glass as shown. Then, close the scanner lid.

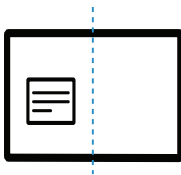

- 3 **Place Front Side and Press [Start]** appears on the display.

- 4 Press  (**Start**).

Your machine begins scanning the front side and shows **Place Back Side and Press [Start]**.

- 5 Turn the original over and place it on the center of first half of the scanner glass as shown. Then, close the scanner lid.



- 6 Press  (**Start**).



- If you do not press the  (**Start**) button, only the front side will be copied.
 - If the original is larger than the printable area, some portions may not be printed.
-

Scanning

This chapter provides information about the overall scan options.



- The maximum resolution that can be achieved depends upon various factors, including computer speed, available disk space, memory, the size of the image being scanned, and bit depth settings. Thus, depending on your system and what you are scanning, you may not be able to scan at certain resolutions, especially using enhanced dpi.
- You need to download software packages from the HP website to install the printer software. For HP's all-inclusive help for the printer, go to www.hp.com/support/colorlaser170MFP.

• Basic scanning method	93
• Scanning from HP MFP Scan program	94
• Scanning from image editing program	95
• Scanning using the WIA driver	96
• Scanning to WSD	97

Basic scanning method



This feature may not be available depending on model or optional goods (see "Variety feature" on page 10).

You can scan the originals with your machine via a USB cable or the network. The following methodologies can be used for scanning your documents:

- **HP MFP Scan:** You can use this program to scan images or documents (See "Scanning from HP MFP Scan program" on page 94).
- **Scan to WSD:** Scans the originals and saves the scanned data on a connected computer if the computer supports the WSD (Web Service for Device) feature (see "Scanning to WSD" on page 97).
- **TWAIN:** TWAIN is the one of the preset imaging applications. Scanning an image launches the selected application, enabling you to control the scanning process. This feature can be used via the local connection or the network connection (see "Scanning from image editing program" on page 95).
- **WIA:** WIA stands for Windows Images Acquisition. To use this feature, your computer must be connected directly with the machine via a USB cable (see "Scanning using the WIA driver" on page 96).
- **HP Smart app:** You can use this app to scan images or documents (See "Scan using the HP Smart app" on page 72).

Scanning from HP MFP Scan program

HP MFP Scan is an application to help users scan, compile, and save documents in multiple formats, including .epub format. These documents can be shared via fax. Whether you're a student needing to organize research from the library or a stay-at-home mom sharing scanned pictures from last year's birthday party, HP MFP Scan will provide you with the necessary tools.



Click the **Help** button from the window, and then click on any option you want to know about.

- 1 Place a single document face down on the document glass, or load the documents face up into the document feeder (see "Loading originals" on page 51).
- 2 Make sure that the machine is connected to the network and powered on. Also, your machine's IP address should have been set (see "Setting IP address" on page 55).
- 3 Download **HP MFP Scan** software from the HP website (www.hp.com/support/colorlaser170MFP).
- 4 Turn on the machine.
- 5 Unzip the **HP MFP Scan** package and run **setup.exe** and run the **HP MFP Scan**.
- 6 Click **Advanced Scan** from the home screen.
- 7 Select the type of scanning or a favorites and then make adjustments to the image.
- 8 Click **Scan** to scan a final image or **Prescan** to get another preview image.
- 9 Press **Save** to save the scanned image.

Scanning from image editing program

You can scan and import documents in the image editing software such as Adobe Photoshop, if the software is TWAIN-compliant. Follow the steps below to scan with TWAIN-compliant software:

- 1 Make sure that the machine is connected to your computer and powered on.
- 2 Place a single document face down on the document glass, or load the documents face up into the document feeder (see "Loading originals" on page 51).
- 3 Open an application, such as Adobe Photoshop.
- 4 Click **File > Import**, and select the scanner device.
- 5 Set the scan options.
- 6 Scan and save your scanned image.

Scanning using the WIA driver

Your machine supports the Windows Image Acquisition (WIA) driver for scanning images. WIA is one of the standard components provided by Microsoft Windows 7 and works with digital cameras and scanners. Unlike the TWAIN driver, the WIA driver allows you to scan and easily adjust images without using additional software:



The WIA driver works only on Windows OS (not supported Windows 2000) with a USB port.

- 1 Make sure that the machine is connected to your computer and powered on.
- 2 Place a single document face down on the document glass, or load the documents face up into the document feeder (see "Loading originals" on page 51).
- 3 Click **Start > Control Panel > Hardware and Sound > Devices and Printers**.
- 4 Right-click on device driver icon in **Printers and Faxes > Start Scan**.
- 5 **New Scan** application appears.
- 6 Choose your scanning preferences and click **Preview** to see how your preferences affect the picture.
- 7 Scan and save your scanned image.

Scanning to WSD

Scans the originals and saves the scanned data on a connected computer if the computer supports the WSD (Web Service for Device) feature. To use the WSD feature, you need to install the WSD printer driver on your computer. For Windows 7, you can install the WSD driver by **Control Panel > Devices and Printers > Add a printer**. Click **Add a network printer** from the wizard.



- The machine that does not support the network interface, it will not be able to use this feature (see "Features by model" on page 8).
- The WSD feature works only with Windows Vista® or later version that are the WSD-compliant computer.
- The following installation steps are based on Windows 7 computer.

Installing a WSD Printer Driver

- 1 Select **Start > Control Panel > Devices and Printers > Add a printer**.
- 2 Click **Add a network, wireless or Bluetooth printer** from the wizard.
- 3 In the printers list, select the one you want to use, and then click **Next**.



- The IP address for WSD printer is `http://IP address/ws/` (example: `http://111.111.111.111/ws/`).
- If no WSD printer is displayed in the list, click **The printer that I want isn't listed > Add a printer using a TCP/IP address or hostname** and select **Web Services Device** from **Device type**. Then enter the printer's IP address.

-
- 4 Follow the instructions in the installation window.

Scanning using the WSD feature

- 1 Make sure that the machine is connected to your computer and powered on.
- 2 Place a single document face down on the document glass, or load the documents face up into the document feeder (see "Loading originals" on page 51).

3 Select  (Scan) > **Scan to WSD** on the control panel.



If you see **Not Available** message, check the port connection. Or check the printer driver for WSD is correctly installed.

4 Select your computer name from **WSD PC List**.

5 Select the option you want and press **OK**.

6 Scanning begins.

Faxing

This chapter provides information about the overall menu structure and the basic setup options.



Supported optional devices and features may differ according to your model (see "Features by model" on page 8).

- Preparing to fax **100**
- Sending a fax **101**
- Receiving a fax **107**
- Forwarding a fax to another destination **111**
- Adjusting the document settings **113**
- Setting up the fax address book **115**

Preparing to fax

Before you send or receive a fax, you need to connect the supplied line cord to your telephone wall jack (see "Rear view" on page 23). The method of making a telephone connection is different from one country to another.



- You cannot use this machine as a fax via the internet phone. For more information ask your internet service provider.
- We recommend using traditional analog phone services (PSTN: Public Switched Telephone Network) when connecting telephone lines to use a fax machine. If you use other Internet services (DSL, ISDN, VoIP), you can improve the connection quality by using the Micro-filter. The Micro-filter eliminates unnecessary noise signals and improves connection quality or Internet quality. Since the DSL Micro-filter is not provided with the machine, contact your Internet service provider for use on DSL Micro-filter.

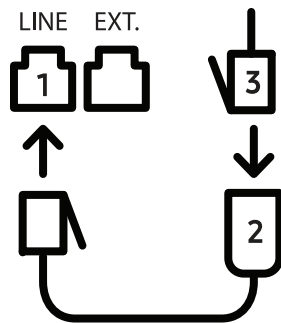



1. Line port
2. Micro filter
3. DSL modem / Telephone line
(see "Rear view" on page 23).

Sending a fax



When you place the originals, you can use either the document feeder or the scanner glass. If the originals are placed on both the document feeder and the scanner glass, the machine will read the originals on the document feeder first, which has higher priority in scanning.

- 1 Place a single document face down on the document glass, or load the documents face up into the document feeder (see "Loading originals" on page 51).
 - 2 Select  (fax) on the control panel.
 - 3 Adjust the resolution and the darkness to suit your fax needs (see "Adjusting the document settings" on page 113).
 - 4 Enter the destination fax number (see "Keypad letters and numbers" on page 36).
 - 5 Press  (**Start**) on the control panel. The machine starts to scan and send the fax to the destinations.
-



- If you want to send a fax directly from your computer, use HP LJ Network PC Fax (see "Sending a fax from your computer" on page 101).
 - When you want to cancel a fax job, press  (**Cancel**) before the machine starts transmission.
 - If you used the scanner glass, the machine shows the message asking to place another page.
-

Sending a fax from your computer



- This feature may not be available depending on model or optional goods (see "Features by model" on page 8).
-

You can send a fax from your computer without going to the machine.

Make sure that your machine and the computer are connected to the same network.

Sending a fax (Windows)

To send a fax from your computer, the **HP LJ Network PC Fax** program must be installed. This program is installed when you install the printer driver.



For more information about **HP LJ Network PC Fax**, click **Help**.

- 1 Open the document to be sent.
- 2 Select **Print** from the **File** menu.
The **Print** window will be displayed. It may look slightly different depending on your application.
- 3 Select **HP Network PC Fax** from the **Print** window.
- 4 Click **Print** or **OK**.
- 5 Enter the recipient's fax number and set the options if necessary.
- 6 Click **Send**.

Checking the sent fax list (Windows)

You can check the sent fax list from your computer.

From the **Start** menu, click **Programs** or **All Programs** > **HP** > **Fax Transmission History**. Then, the window appears with the list of faxes sent.





For more information about **Fax Transmission History**, click the **Help** (?) button.

Sending a fax manually

Perform the following to send a fax using  (**On Hook Dial**) on the control panel.



If you selected **Fax Feature** > **Send Forward** > **Forward to Fax** > **On**, you cannot send a fax using this feature (see "Forwarding a sent fax to another destination" on page 111).

- 1 Place a single document face down on the document glass, or load the documents face up into the document feeder (see "Loading originals" on page 51).
- 2 Select  (fax) on the control panel.
- 3 Adjust the resolution and the darkness to suit your fax needs (see "Adjusting the document settings" on page 113).
- 4 Press  (**On Hook Dial**) on the control panel.
- 5 Enter a fax number using the number keypad on the control panel.
- 6 Press  (**Start**) on the control panel when you hear a high-pitched fax signal from the remote fax machine.

Sending a fax to multiple destinations

You can use the multiple send feature, which allows you to send a fax to multiple locations. Originals are automatically stored in memory and sent to a remote station. After transmission, the originals are automatically erased from memory.



- You cannot send faxes to multiple destinations if you have chosen super fine.
- You cannot send a color fax using this feature.

-
- 1 Place a single document face down on the document glass, or load the documents face up into the document feeder (see "Loading originals" on page 51).
 - 2 Select  (fax) on the control panel.
 - 3 Adjust the resolution and the darkness to suit your fax needs (see "Adjusting the document settings" on page 113).
 - 4 Select **...** (**Menu**) > **Fax Feature** > **Multi Send** on the control panel.
 - 5 Enter the number of the first receiving fax machine and press **OK**.

You can press speed dial numbers or select a group dial number using the  (**Address book**) button.

6 Enter the second fax number and press **OK**.

The display asks you to enter another fax number to send the document.

7 To enter more fax numbers, press **OK** when **Yes** appears and repeat steps 5 and 6.



You can add up to 10 destinations.

8 When you have finished entering fax numbers, select **No** at the **Another No.?** prompt and press **OK**.

The machine begins sending the fax to the numbers you entered in the order in which you entered them.

Automatic redialing

When the number you have dialed is busy or there is no answer when you send a fax, the machine automatically redials the number. The redial time depends on the country's factory default setting.

When the display shows **Retry Redial?**, press  (**Start**) button to redial the number without waiting. To cancel the automatic redialing, press  (**Cancel**).

To change the time interval between redials and the number of redial attempts.

1 Press  (fax) > **...** (**Menu**) > **Fax Setup** > **Sending** on the control panel.

2 Select **Redial Times** or **Redial Term** you want.

3 Select the option you want.

Redialing the fax number

1 Press  (**Redial/Pause**) button on the control panel.

2 Select the fax number you want.

Ten recently sent fax numbers with ten received Caller IDs are shown.

3 When an original is loaded in the document feeder, the machine automatically begins to send.

If an original is placed on the scanner glass, select **Yes** to add another page. Load another original and press **OK**. When you have finished, select **No** when **Another Page?** appears.

Confirming a transmission

When the last page of your original has been sent successfully, the machine beeps and returns to ready mode.

When something goes wrong while sending your fax, an error message appears on the display. If

you receive an error message, press  (Cancel) to clear the message and try to send the fax again.



You can set your machine to print a confirmation report automatically each time sending a fax is completed. Press  (fax) > **...** (Menu) > **Fax Setup** > **Sending** > **Fax Confirm.** on the control panel.

Delaying a fax transmission

You can set your machine to send a fax at a later time when you will not be present.



You cannot send a color fax using this feature.

- 1 Place a single document face down on the document glass, or load the documents face up into the document feeder.
- 2 Press  (fax) on the control panel.
- 3 Adjust the resolution and the darkness to suit your fax needs.
- 4 Press **...** (Menu) > **Fax Feature** > **Delay Send** on the control panel.
- 5 Enter the number of the receiving fax machine and press **OK**.
- 6 The display asks you to enter another fax number to send the document.
- 7 To enter more fax numbers, press **OK** when **Yes** highlights and repeat steps 5.



You can add up to 10 destinations.

8 Enter the job name and the time.



If you set a time earlier than the current time, the fax will be sent at that time on the following day.

9 The original is scanned into memory before transmission.

The machine returns to ready mode. The display reminds you that you are in ready mode and that a delayed fax is set.



You can check the list of delayed fax jobs.

Press **...** (Menu) > **System Setup** > **Report** > **Scheduled Jobs** on the control panel.

Canceling a reserved fax job

1 Press  (fax) > **...** (Menu) > **Fax Feature** > **Cancel Job** on the control panel.

2 Select the fax job you want and press **OK**.

3 Press **OK** when **Yes** highlights.

The selected fax is deleted from memory.

4 Press  (**Cancel**) to return to ready mode.



Receiving a fax

Your machine is preset Fax mode at the factory. When you receive a fax, the machine answers the call on a specified number of rings and automatically receives the fax.

Changing the receive modes

1 Press  (fax) >  (Menu) > **Fax Setup** > **Receiving** > **Receive Mode** on the control panel.

2 Select the option you want.

- **Fax:** Answers an incoming fax call and immediately goes into the fax reception mode.
- **Tel:** Receives a fax by pressing  (**On Hook Dial**) and then  (**Start**) button.
- **Ans/Fax:** Is for when an answering machine is attached to your machine. Your machine answers an incoming call, and the caller can leave a message on the answering machine. If the fax machine senses a fax tone on the line, the machine automatically switches to Fax mode to receive the fax.



To use the **Ans/Fax** mode, attach an answering machine to the EXT socket on the back of your machine.

-
- **DRPD:** You can receive a call using the Distinctive Ring Pattern Detection (DRPD) feature. Distinctive Ring is a telephone company service which enables an user to use a single telephone line to answer several different telephone numbers. For further details, see "Receiving faxes using DRPD mode" on page 108.





This setting may not be available depending on your country.

3 Press **OK**.

4 Press  (**Cancel**) to return to ready mode.

Receiving manually in Tel mode

You can receive a fax call by pressing  (On Hook Dial) button and then pressing  (Start) when you hear a fax tone.

Receiving in Answering Machine/Fax mode

To use this mode, you must attach an answering machine to the EXT socket on the back of your machine. If the caller leaves a message, the answering machine stores the message. If your machine detects a fax tone on the line, it automatically starts to receive the fax.



- If you have set your machine to this mode and your answering machine is switched off, or no answering machine is connected to EXT socket, your machine automatically goes into Fax mode after a predefined number of rings.
- If the answering machine has a user-selectable ring counter, set the machine to answer incoming calls within 1 ring.
- If the machine is in Tel mode, disconnect or switch off the answering machine with the fax machine. Otherwise, the outgoing message from the answering machine will interrupt your phone conversation.

Receiving faxes with an extension telephone

When you are using an extension telephone connected to the EXT socket, you can receive a fax from someone you are talking to on the extension telephone, without going to the fax machine.

When you receive a call on the extension phone and hear fax tones, press the keys ***9*** on the extension phone. The machine receives the fax.

9 is the remote receive code preset at the factory. The first and the last asterisks are fixed, but you can change the middle number to whatever you want.



While you are talking over the telephone connected to the EXT socket, copy and scan features are not available.

Receiving faxes using DRPD mode

This setting may not be available depending on your country. Distinctive Ring is a telephone company service which enables an user to use a single telephone line to answer several different telephone numbers. This feature is often used by answering services who answer telephones for many different clients and need to know which number someone is calling in on to properly answer the phone.



This setting may not be available depending on your country.

- 1 Select  (fax) > **...** (Menu) > **Fax Setup** > **Receiving** > **DRPD Mode** > **Waiting Ring** on the control panel.
- 2 Call your fax number from another telephone.
- 3 When your machine begins to ring, do not answer the call. The machine requires several rings to learn the pattern.
When the machine completes learning, the display shows **Completed DRPD Setup**. If the DRPD setup fails, **Error DRPD Ring** appears.
- 4 Press **OK** when DRPD appears and start over from step 2.



- DRPD must be set up again if you re-assign your fax number, or connect the machine to another telephone line.
 - After DRPD has been set up, call your fax number again to verify that the machine answers with a fax tone. Then have a call placed to a different number assigned to that same line to be sure the call is forwarded to the extension telephone or answering machine plugged into the EXT socket.
-

Receiving in secure receiving mode



This feature may not be available depending on model or optional goods (see "Features by model" on page 8).

You may need to prevent your received faxes from being accessed by unauthorized people. Turn on secure receiving mode, then all incoming faxes go into memory. You can print the incoming faxes by entering the password.



To use the secure receiving mode, activate the menu from  (fax) > **...** (Menu) > **Fax Feature** > **Secure Receive** on the control panel.

Printing received faxes

- 1 Select  (fax) > **...** (Menu) > **Fax Feature** > **Secure Receive** > **Print** on the control panel.
- 2 Enter a four-digit password and press **OK**.
- 3 The machine prints all of the faxes stored in memory.

Receiving faxes in memory

Since your machine is a multi-tasking device, it can receive faxes while you are making copies or printing. If you receive a fax while you are copying or printing, your machine stores incoming faxes in its memory. Then, as soon as you finish copying or printing, the machine automatically prints the fax.



If fax is received and being printed, other copy and print jobs cannot be processed at the same time.

Forwarding a fax to another destination

You can set the machine to forward the received or sent fax to other destination by a fax or PC. If you are out of office but have to receive the fax, this feature may be useful.

Forwarding a sent fax to another destination



You cannot send a color fax using this feature.

- 1 Place a single document face down on the document glass, or load the documents face up into the document feeder.
- 2 Press  (fax) > **...** (Menu) > **Fax Feature** > **Send Forward** > **Forward to Fax** > **On** on the control panel.



- If you selected **On**, you cannot send a fax manually (see "Sending a fax manually" on page 102).
 - **Forward** options may not be available depending on model or optional goods (see "Variety feature" on page 10).
-

- 3 Enter the destination fax number, email address, or server address and press **OK**.
- 4 Press  (**Cancel**) to return to ready mode.
Subsequent sent faxes will be forwarded to the specified fax machine.

Forwarding a received fax

You can set the machine to forward the received or sent fax to other destination by a fax. If you are out of office but have to receive the fax, this feature may be useful.

- 1 Press  (fax) > **••• (Menu)** > **Fax Feature** > **Rcv. Forward** > **Forward to Fax** or **Forward to PC** > **On** on the control panel.
-



- **Forward** options may not be available depending on model or optional goods (see "Variety feature" on page 10).
 - To set the machine to print out a fax when fax forwarding has been completed, select **Forward&Print**.
-

- 2 Enter the destination fax number, email address, or server address and press **OK**.
- 3 Enter the starting time and ending time, then press **OK**.
- 4 Press  (**Cancel**) to return to ready mode.

Subsequent sent faxes will be forwarded to the specified fax machine.

Adjusting the document settings

Before starting a fax, change the following settings according to your original's status to get the best quality.



It may be necessary to press **OK** to navigate to lower-level menus for some models.

Resolution

The default document settings produce good results when using typical text-based originals. However, if you send originals that are of poor quality, or contain photographs, you can adjust the resolution to produce a higher quality fax.

- 1 Select  (fax) > **•••(Menu)** > **Fax Feature** > **Resolution** on the control panel.
- 2 Select the option you want and press **OK**.
 - **Standard**: Originals with normal sized characters.
 - **Fine**: Originals containing small characters or thin lines or originals printed using a dot-matrix printer.
 - **Super Fine**: Originals containing extremely fine detail. **Super Fine** mode is enabled only if the machine with which you are communicating also supports the Super Fine resolution.



- For memory transmission, **Super Fine** mode is not available. The resolution setting is automatically changed to **Fine**.
 - When your machine is set to **Super Fine** resolution and the fax machine with which you are communicating does not support **Super Fine** resolution, the machine transmits using the highest resolution mode supported by the other fax machine.
-

- **Photo Fax**: Originals containing shades of gray or photographs.



- 3 Press  (**Cancel**) to return to ready mode.

Darkness

You can select the degree of darkness of the original document.



The darkness setting is applied to the current fax job. To change the default setting (see "Fax" on page 124).



- 1 Select  (fax) >  (Menu) > **Fax Feature** > **Darkness** on the control panel.
- 2 Select a darkness level you want.
- 3 Press  (**Cancel**) to return to ready mode.



Setting up the fax address book

This feature only supports fax model. You can set up speed number with the fax numbers you use frequently via HP Embedded Web Server and then easily and quickly enter fax numbers by entering the location numbers assigned to them in address book.

 You cannot send a color fax via address book.

Registering a speed dial number



- 1 Select  (fax) >  (Address Book) > **New & Edit** > **Speed Dial** on the control panel.
- 2 Enter a speed dial number and press **OK**.

 If an entry is already stored in the number you choose, the display shows the message to allow you to change it. To start over with another speed dial number, press  (**Back**).



- 3 Enter the name you want and press **OK**.
- 4 Enter the fax number you want and press **OK**.
- 5 Press the  (**Cancel**) button to return to ready mode.

Using speed dial numbers



When you are prompted to enter a destination number while sending a fax, enter the speed dial number at which you stored the number you want.

-  • For a one-digit (0-9) speed dial number, press and hold the corresponding digit button on the number keypad for more than 2 seconds.
- For a two- or three-digit speed dial number, press the first digit button(s) and then hold down the last digit button for more than 2 seconds.
 - You can print the address book list by selecting  (fax) >  (Address Book) > **Print**.
-

Editing speed dial numbers

- 1 Select  (fax) >  (**Address Book**) > **New & Edit** > **Speed Dial** on the control panel.
- 2 Enter the speed dial number you want to edit and press **OK**.
- 3 Change the name and press **OK**.
- 4 Change the fax number and press **OK**.
- 5 Press  (**Cancel**) to return to ready mode.

Registering a group dial number



- 1 Select  (fax) >  (**Address Book**) > **New & Edit** > **Group Dial** on the control panel.
- 2 Enter a group dial number and press **OK**.



If an entry is already stored in the number you choose, the display shows the message to allow you to change it. To start over with another speed dial number, press  (**Back**).



- 3 Search by entering the first few letters of the speed dial's name to put in the group.
- 4 Select the name and number you want and press **OK**.
- 5 Select **Yes** when **Add?** appears.
- 6 Repeat step 3 to include other speed dial numbers into the group.
- 7 When you have finished, select **No** when **Another No.?** appears and press **OK**.
- 8 Press  (**Cancel**) to return to ready mode.

Editing group dial numbers

- 1 Select  (fax) >  (**Address Book**) > **New & Edit** > **Group Dial** on the control panel.
- 2 Enter the group dial number you want to edit and press **OK**.
- 3 Enter a new speed dial number to add and press **OK**, then **Add?** appears.
Enter a speed dial number stored in the group and press **OK**, **Delete?** appears.
- 4 Press **OK** to add or delete the number.
- 5 Repeat step 3 to add or delete more numbers.
- 6 Select **No** at the **Another No.?** and press **OK**.
- 7 Press  (**Cancel**) to return to ready mode.



Searching address book for an entry

There are two ways to search for a number in memory. You can either scan from A to Z sequentially, or you can search by entering the first letters of the name associated with the number.

- 1 Select ct  (fax) >  (**Address Book**) > **Search & Dial** > **Speed Dial** or **Group Dial** on the control panel.
- 2 Enter **All** or **ID** and press **OK**.
- 3 Press the name and number or the keypad button labeled with the letter you want to search.
For example, if you want to find the name "MOBILE," press the **6** button, which is labeled with "MNO."
- 4 Press  (**Cancel**) to return to ready mode.

Printing address book

You can check your  (Address Book) settings by printing a list.

- 1 Select  (fax) >  (Address Book) > **Print** on the control panel.
- 2 Press **OK**.
The machine begins printing.

Useful Setting Menus

This chapter explains how to browse the current status of your machine, and the method of setting for advanced machine setup.

- Before you begin reading a chapter 120
- Copy 121
- Fax 124
- System setup 128
- Network setup 133

Before you begin reading a chapter

This chapter explains all the features available for this series' models to help users easily understand the features.

You can check the features available for each model in the Basic Guide (see "Menu overview" on page 30).

The following are tips for using this chapter

- The control panel provides access to various menus to set up the machine or use the machine's functions. These menus can be accessed by pressing **••• (Menu)**.
- Some menus may not appear on the display depending on options or models. If so, it is not applicable to your machine.
- For models that do not have the **••• (Menu)** on the control panel, this feature is not applicable (see "Control panel overview" on page 24).
- Some menu names may differ from your machine depending on its options or the models.

Copy

Copy feature





Some menus may not appear in the display depending on options or models. If so, it is not applicable to your machine (see "Menu overview" on page 30).

To change the menu options:

In copy mode, press **••• (Menu) > Copy Feature** on the control panel.

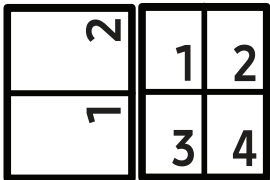

- **HP Color Laser MFP 178nw:** When the **Scan** button's LED is off, the machine is in copy mode.
- **HP Color Laser MFP 179fnw:** Press  (copy) on the control panel.

Item	Description
Original Size	Sets the image size.
Reduce/Enlarge	Reduces or enlarges the size of a copied image (see "Reduced or enlarged copy" on page 89).  If the machine is set to Eco mode, reduce and enlarge features are not available.
Darkness	Adjusts the brightness level to make a copy that is easier to read, when the original contains faint markings and dark images (see "Darkness" on page 88)
Original Type	Improves the copy quality by selecting the document type for the current copy job (see "Original type" on page 88)
Collation	Set the machine to sort the copy job. For example, if you make 2 copies of a 3 page original, one complete 3 page document will print followed by a second complete document.
Layout	Adjusts the layout format such as Normal, ID copy, 2/4-Up.
Layout > 2-Up or Layout > 4-Up	Reduces the size of the original images and prints 2 or 4 pages onto one sheet of paper. 

Item	Description
Layout > ID Copy	prints one side of the original on the upper half of the paper and the other side on the lower half without reducing the size of the original. This feature is helpful for copying a small-sized item such as business card.
Adjust Bkgd.	<p>Prints an image without its background. This copy feature removes the background color and can be helpful when copying an original containing color in the background, such as a newspaper or a catalog.</p> <ul style="list-style-type: none"> • Off: Does not use this feature. • Auto: Optimizes the background. • Enhance Lev.1~2: The higher the number is, the more vivid the background is. • Erase Lev.1~4: The higher the number is, the lighter the background is.

Copy Setup







Some menus may not appear in the display depending on options or models. If so, it is not applicable to your machine (see "Menu overview" on page 30).

To change the menu options:

In copy mode, press **••• (Menu) > Copy Setup** on the control panel.



- **HP Color Laser MFP 178nw:** When the **Scan** button's LED is off, the machine is in copy mode.
- **HP Color Laser MFP 179fnw:** Press  (copy) on the control panel.

Item	Description
Change Default	Resets the value or setting to the printer's out-of-box state.
Change Default > Original Size	Improves the copy quality by selecting the document size for the current copy job.
Change Default > Copies	You can enter the number of copies using the number keypad.
Change Default > Collation	<p>Set the machine to sort the copy job. For example, if you make 2 copies of a 3 page original, one complete 3 page document will print followed by a second complete document.</p> <ul style="list-style-type: none"> • On: Prints output in sets to match the sequence of originals.  <ul style="list-style-type: none"> • Off: Prints output sorted into stacks of individual pages. 
Change Default > Reduce/Enlarge	<p>Reduces or enlarges the size of a copied image (see "Reduced or enlarged copy" on page 89).</p> <p> If the machine is set Eco mode, reduce and enlarge features are not available.</p>
Change Default > Darkness	Adjusts the brightness level to make a copy that is easier to read, when the original contains faint markings and dark images (see "Darkness" on page 88)
Change Default > Original Type	Improves the copy quality by selecting the document type for the current copy job (see "Original type" on page 88)



Fax



Fax Feature



Some menus may not appear in the display depending on options or models. If so, it is not applicable to your machine (see "Menu overview" on page 30).

To change the menu options:

- Press  (fax) >  (Menu) > **Fax Feature** on the control panel.

Item	Description
Darkness	Adjusts the brightness level to scan an original that is easier to read, when the original contains faint markings and dark images (see "Darkness" on page 113).
Resolution	The default document settings produce good results when using typical text-based originals. However, if you send originals that are of poor quality, or contain photographs, you can adjust the resolution to produce a higher quality fax (see "Resolution" on page 113).
Original Size	Sets the image size.
Multi Send	Sends a fax to multiple destinations (see "Sending a fax to multiple destinations" on page 103).  You cannot send a color fax using this feature.
Delay Send	Sets your machine to send a fax at a later time when you will not be present (see "Delaying a fax transmission" on page 105).  You cannot send a color fax using this feature.
Send Forward	Forwards the sent fax to other destination. See "Forwarding a sent fax to another destination" on page 111.  You cannot send a color fax using this feature.
Rcv. Forward	Forwards the received fax to other destination. If you are out of office but have to receive the fax, this feature may be useful. See "Forwarding a received fax" on page 112.

Item	Description
Secure Receive	Stores the received fax in memory without printing out. To print received documents, you need to enter the password. You can prevent your received faxes from being accessed by unauthorized people (see "Receiving in secure receiving mode" on page 109).
Cancel Job	Cancels the delayed fax job which is saved in memory (see "Canceling a reserved fax job" on page 106).

Sending setup



Some menus may not appear in the display depending on options or models. If so, it is not applicable to your machine (see "Menu overview" on page 30).

To change the menu options:

- Press  (fax) >  (Menu) > **Fax Setup** > **Sending** on the control panel.

Item	Description
Redial Times	Sets the number of redial attempts. If you enter 0, the machine will not redial.
Redial Term	Sets the time interval before automatic redialling.
Prefix Dial	Sets a prefix of up to five digits. This number dials before any automatic dial number is started. It is useful for accessing a PABX exchange.
ECM Mode	Sends faxes using error correction mode (ECM) to makes sure the faxes are sent smoothly without any error. It may take more time.
Fax Confirm.	Sets the machine to print a report whether a fax transmission was successfully completed or not. If you select On-Error , the machine prints a report only when a transmission is not successful.
Modem speed	Select the maximum modem speed you want if the phone line fails to sustain a higher modem speed.
Image TCR	Prints a transmission report with a minimized image of the first page of the fax sent.
Dial Mode	Sets the dialing mode to either tone or pulse. This setting may not be available depending on your country.

Receiving setup



Some menus may not appear in the display depending on options or models. If so, it is not applicable to your machine (see "Menu overview" on page 30).

To change the menu options:

- Press  (fax) > **••• (Menu)** > **Fax Setup** > **Receiving** on the control panel.

Item	Description
Receive Mode	Selects the default fax receiving mode.
Ring To Answer	Specifies the number of times the machine rings before answering an incoming call.
Stamp Rcv Name	Automatically prints the page number, and the date and time of reception at the bottom of each page of a received fax.
Rcv Start Code	Initiates fax reception from an extension phone plugged into the EXT socket on the back of the machine. If you pick up the extension phone and hear fax tones, enter the code. It is preset to *9* at the factory.
Auto Reduction	Automatically reduces an incoming fax page to fit the size of the paper loaded in the machine.
Discard Size	Discards a specific length from the end of the received fax.
Junk Fax Setup	Blocks any unwanted faxes that you stored in the memory as junk fax numbers. This setting may not be available depending on your country.
DRPD Mode	Enables a user to use a single telephone line to answer several different telephone numbers. You can set the machine to recognize different ring patterns for each number. This setting may not be available depending on your country (see "Receiving faxes using DRPD mode" on page 108).

Another setup



Some menus may not appear in the display depending on options or models. If so, it is not applicable to your machine (see "Menu overview" on page 30).

To change the menu options:

- Press  (fax) > **••• (Menu)** > **Fax Setup** on the control panel.

Item	Description
Change Default	Resets the value or setting to the printer's out-of-box state.

Item	Description
Smart Fax Diag	The Smart Fax Diag feature optimizes the settings for your fax line.
Manual TX/RX	Setting this option to ON provides the ability to send or receive a fax while the line is busy. You can select to send or receive a fax by either picking up the extension phone receiver and pressing the Start button or by pressing the On Hook Dial button and pressing the Start button.

System setup

Machine setup



Some menus may not appear in the display depending on options or models. If so, it is not applicable to your machine (see "Menu overview" on page 30).

To change the menu options:

- Press **••• (Menu) > System Setup > Machine Setup** on the control panel.

Item	Description
Machine ID	Sets the machine ID which will be printed at the top of each fax page that you send.
Fax Number	Sets the fax number which will be printed at the top of each fax page that you send.
Date & Time	Sets the date and time.
Clock Mode	Selects the format for displaying time between 12 hr. and 24 hr.
Language	Sets the language of the text that appears on the control panel display.
Default Mode	Sets the default status.
Power Save	Sets how long the machine waits before going to power save mode. When the machine does not receive data for an extended period of time, power consumption is automatically lowered.
Wakeup Event	You can set the condition to wake up from power-save mode. <ul style="list-style-type: none">• On: The machine wake up from the power save mode on the following cases:<ul style="list-style-type: none">- Pressing any button- Opening or closing the paper tray- Inserting paper in the document feeder• Off: The machine wakes up from power save mode only when a button on the control panel is pressed.
System Timeout	Sets the time that the machine remembers previously used copy settings. After the timeout, the machine restores the default copy settings.
Job Timeout	Sets the length of time the printer waits before printing the last page of a print job that does not end with a command to print the page.
Altitude Adj.	Optimize print quality according to the machine's altitude.

Item	Description
Humidity	Optimizes print quality according to the humidity in the environment.
Auto Continue	<p>Determine whether or not the machine continues printing when it detects the paper does not match the paper settings.</p> <ul style="list-style-type: none"> • Off: If a paper mismatch occurs, the machine waits until you insert the correct paper. • After 0 Sec: Even though a paper mismatch occurs, the machine continues printing. • After 30 Sec: If a paper mismatch occurs, an error message will display. The machine waits for about 30 second, then automatically clear the message and continue printing.
Paper Substit.	Automatically substitutes the printer driver's paper size to prevent the paper mismatch between Letter and A4. For example, if you have A4 paper in the tray but you set the paper size to Letter in the printer driver, the machine prints on A4 paper and vice versa.

Paper setup



Some menus may not appear in the display depending on options or models. If so, it is not applicable to your machine (see "Menu overview" on page 30).

To change the menu options:

- Press **••• (Menu) > System Setup > Paper Setup** on the control panel.

Item	Description
Paper Size	Sets the paper size as A4, Letter, or other paper sizes, according to your requirements.
Paper Type	Chooses the type of the paper for each tray.
Margin	Sets the margins for the document.



Sound / Volume



Some menus may not appear in the display depending on options or models. If so, it is not applicable to your machine (see "Menu overview" on page 30).

To change the menu options:

- Press **••• (Menu) > System Setup > Sound/Volume** on the control panel.

Item	Description
Key Sound	Turns the key sound on or off. With this option set to on, a tone sounds each time a key is pressed.
Alarm Sound	Turns the alarm sound on or off. With this option set to on, an alarm tone sounds when an error occurs or fax communication ends.
Speaker	<p>Turns on or off the sounds from the telephone line through the speaker, such as a dial tone or a fax tone. With this option set to Comm. which means the speaker is on until the remote machine answers.</p> <p> You can adjust the volume level using On Hook Dial. You can adjust the speaker volume only when the telephone line is connected.</p> <ol style="list-style-type: none"> Press  (fax) on the control panel. Press On Hook Dial. A dial tone sounds from the speaker. Press the arrows until you hear the volume you want. Press On Hook Dial to save the change and return to ready mode.
Ringer	Adjusts the ringer volume. For the ringer volume, you can select off, low, middle, and high level.

Report



Some menus may not appear in the display depending on options or models. If so, it is not applicable to your machine (see "Menu overview" on page 30).

To change the menu options:

- Press **••• (Menu) > System Setup > Report** on the control panel.

Item	Description
Configuration	Prints a report on the machine's overall configuration.
Supplies Info.	Prints supplies' information page.
Demo Page	Prints the demo page to check whether your machine is printing properly or not.
Address Book	Prints all of the fax number currently stored in the machine's memory.

Item	Description
Fax Confirm.	Prints a transmission report including the fax number, the number of pages, the elapsed time of the job, the communication mode, and the communication results for fax job. You can set up your machine to automatically print a transmission confirmation report after each fax job.
Fax Sent	Prints information on the faxes you have recently sent.
Fax Received	Prints information on the faxes you have recently received.
Scheduled Jobs	Prints the document list currently stored for delayed faxes along with the starting time and type of each operation.
Junk Fax	Prints the fax numbers specified as junk fax numbers.
Network Conf.	Prints information on your machine's network connection and configuration.
Usage Counter	Prints a usage page. The usage page contains the total number of pages printed.

Maintenance



Some menus may not appear in the display depending on options or models. If so, it is not applicable to your machine (see "Menu overview" on page 30).

To change the menu options:

- Press **••• (Menu) > System Setup > Maintenance** on the control panel.

Item	Description
CLR Empty Msg	When toner cartridge is empty, this option appears. You can clear the empty message.
Supplies Life	Shows the supply life indicators (see "Monitoring the supplies life" on page 147.)
Image Mgr.	Allows you to adjust the color setting such as contrast level, color registration, color density, etc. <ul style="list-style-type: none"> • Custom Color: adjusts contrast, color by color. <ul style="list-style-type: none"> - Default: optimizes colors automatically. - Print Density: allows you to manually adjust the color contrast for each cartridge. It is recommended to use the Default setting for best color quality.
Serial Number	Shows the machine's serial number. When you call for service or register as a user on the HP website, you can find this.



Item	Description
TonerLow Alert	Customizes the level to alert toner low or toner empty (see "Setting the toner low alert" on page 148).
ImgU.Low Alert	Customizes the level to alert imaging unit low.



Network setup



Some menus may not appear in the display depending on options or models. If so, it is not applicable to your machine (see "Menu overview" on page 30).

-
- Press **••• (Menu) > Network** on the control panel.

Option	Description
TCP/IP (IPv4)	Selects the appropriate protocol and configure parameters to use the network environment.  There are many of parameters to be set. If you are not sure, leave as is, or consult the network administrator.
TCP/IP (IPv6)	Selects this option to use the network environment through IPv6 (see "IPv6 configuration" on page 55).
Ethernet	Configure the network transmission speed and active port.
Wi-Fi	Selects this option to use the Wi-Fi network.
Clear Settings	Reverts the network settings to the default values. (Reboot required.)
Network Conf.	This list shows information on your machine's network connection and configuration.
Protocol Mgr.	You can activate or deactivate the following protocols. <ul style="list-style-type: none">• HTTP: You can set whether to use HP Embedded Web Server or not.  Turn the power off and on after you change this option. <ul style="list-style-type: none">• WINS: You can configure the WINS server. WINS(Windows Internet Name Service) is used in the Windows operating system.  Turn the power off and on after you change this option.

Option	Description
Protocol Mgr.	<ul style="list-style-type: none"> • SNMPv1/v2: You have to enable this option to use SNMP V1/V2 protocol. Administrator's can use SNMP to monitor and manage machines on the network. • UPnP(SSDP): You have to enable this option to use UPnP(SSDP) protocol. <p> Turn the power off and on after you change this option.</p> <ul style="list-style-type: none"> • mDNS: You have to enable this option to use MDNS (Multicast Domain Name System) protocol. • SLP: You can configure SLP (Service Location Protocol) settings. This protocol allows host applications to find services in a local area network without prior configuration. <p> Turn the power off and on after you change this option.</p>

Maintenance

This chapter provides information about purchasing supplies, accessories and maintenance parts available for your machine.

- Ordering supplies and accessories 136
- Available supplies 137
- Available maintenance parts 139
- Storing the toner cartridge 140
- Redistributing toner 142
- Replacing the toner cartridge 143
- Replacing the imaging drum 144
- Replacing the toner collection unit 146
- Monitoring the supplies life 147
- Setting the toner low alert 148
- Cleaning the machine 149
- Tips for moving & storing your machine 153

Ordering supplies and accessories



Available accessories may differ from country to country. Contact your sales representatives to obtain the list of available supplies, and maintenance parts.

To order HP-authorized supplies, accessories, and maintenance parts, contact your local HP dealer or the retailer where you purchased your machine. You can also visit <https://store.hp.com/>, and then select your country/region to obtain the contact information for service.

Available supplies

When supplies reach the end of their life spans, you can order the followings of supplies for your machine:

Item	Product name	Cartridge number	Product number	Region ^a
Toner cartridge	HP 116A Original Laser Toner Cartridge	116A Black	W2060A	For use only in North America, Latin America
		116A Cyan	W2061A	
		116A Yellow	W2062A	
		116A Magenta	W2063A	
	HP 117A Original Laser Toner Cartridge	117A Black	W2070A	For use only in Europe, Russia, CIS, Mid East and Africa
		117A Cyan	W2071A	
		117A Yellow	W2072A	
		117A Magenta	W2073A	
	HP 118A Original Laser Toner Cartridge	118A Black	W2080A	For use only in China
		118A Cyan	W2081A	
		118A Yellow	W2082A	
		118A Magenta	W2083A	
HP 119A Original Laser Toner Cartridge	119A Black	W2090A	For use only in Asia Pacific excluding China	
	119A Cyan	W2091A		
	119A Yellow	W2092A		
	119A Magenta	W2093A		
Imaging Drum	HP 120A Original Laser Imaging Drum	120A	W1120A	For use in all countries excluding China
	HP 132A Original Laser Imaging Drum	132A	W1132A	For use only in China
Toner Collection Unit	HP Laser Toner Collection Unit		5KZ38A	For use in all countries excluding China
			5LX86A	For use only in China

a. When purchasing new toner cartridges or other supplies, these must be purchased in the same country as the machine you are using. Otherwise, new toner cartridges or other supplies will be incompatible with your machine due to different configurations of toner cartridges and other supplies according to the specific country conditions.



Depending on the options, percentage of image area and job mode used, the toner cartridge's lifespan may differ.



HP does not recommend using non-genuine HP toner cartridge such as refilled or remanufactured toner. HP cannot guarantee non-genuine HP toner cartridge's quality. Service or repair required as a result of using non-genuine HP toner cartridges will not be covered under the machine's warranty.

Available maintenance parts

You need to replace the maintenance parts at specific intervals to keep the machine in the best condition and avoid print quality and paper feeding problems resulting from the worn-out parts. Maintenance parts are mostly rollers, belts and pads. However, the replacement period and parts may differ depending on the model. Replacing maintenance parts can be performed only by an authorized service provider, dealer, or the retailer where you bought the machine. To purchase maintenance parts, contact the retailer where you bought the machine. The replacement period for the maintenance parts is informed by the "Printer Status" program. Or on the UI (User Interface) if your machine supports a display screen. The replacement period varies based on the operating system used, computing performance, application software, connecting method, paper type, paper size, and job complexity.

Storing the toner cartridge

Toner cartridges contain components that are sensitive to light, temperature and humidity. HP suggests users follow these recommendations to ensure optimal performance, highest quality, and longest life from your new HP toner cartridge.

Store this cartridge in the same environment in which the printer will be used. This should be in controlled temperature and humidity conditions. The toner cartridge should remain in its original and unopened package until installation – if original packaging is not available, cover the top opening of the cartridge with paper and store in a dark cabinet.

Opening the cartridge package prior to use dramatically shortens its useful shelf and operating life. Do not store on the floor. If the toner cartridge is removed from the printer, follow the instructions below to store the toner cartridge properly.

- Store the cartridge inside the protective bag from the original package.
- Store lying flat (not standing on end) with the same side facing up as if it were installed in the machine.
- Do not store consumables in any of the following conditions:
 - Temperature greater than 40°C (104°F).
 - Humidity range less than 20% or greater than 80%.
 - An environment with extreme changes in humidity or temperature.
 - Direct sunlight or room light.
 - Dusty places.
 - A car for a long period of time.
 - An environment where corrosive gases are present.
 - An environment with salty air.

Handling instructions

- Do not touch the surface of the photo conductive drum in the cartridge.
- Do not expose the cartridge to unnecessary vibrations or shock.
- Never manually rotate the drum, especially in the reverse direction; this can cause internal damage and toner spillage.

Toner cartridge usage

HP does not recommend or approve the use of non-HP brand toner cartridges in your printer including generic, store brand, refilled, or remanufactured toner cartridges.



HP's printer warranty does not cover damage to the machine caused by the use of a refilled, remanufactured, or non-HP brand toner cartridges.

Estimated cartridge life

Estimated cartridge life (the life of the toner cartridge yield) depends on the amount of toner that print jobs require. The actual print yield may vary depending on the print density of the pages you print on, operating environment, percentage of image area, printing interval, media type and/or media size. For example, if you print a lot of graphics, the consumption of the toner is higher and you may need to change the cartridge more often.

Redistributing toner

You can temporarily improve print quality by redistributing the remaining toner in the cartridge. In some cases, white streaks or light printing will still occur even after you have redistributed the toner.



Illustrations on this user's guide may differ from your machine depending on its options or models. Check your machine type (see "Front view" on page 21).



- Do not use sharp objects such as a knife or scissors to open the toner cartridge package.
- If toner gets on your clothing, wipe it off with a dry cloth and wash clothing in cold water. Hot water sets toner into fabric.
- When opening a scan unit, hold the document feeder and scan unit together.
- Printing even after the toner empty status can cause serious damage to your machine.

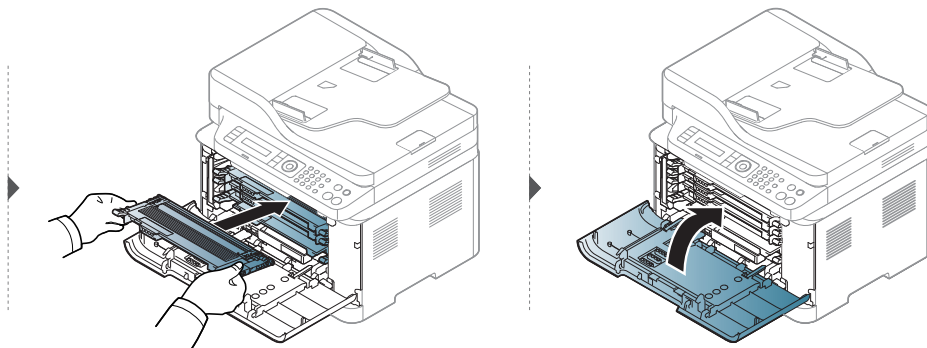
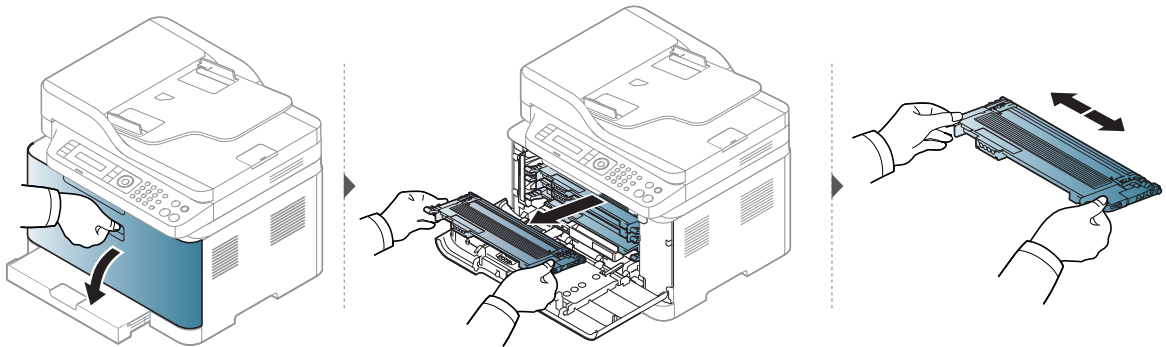

Replacing the toner cartridge

When toner cartridge needs to be replaced, check the type of the toner cartridge for your machine (see "Available supplies" on page 137).



- Shake the toner cartridge thoroughly, it will increase the initial print quality.
- Illustrations on this user's guide may differ from your machine depending on its options or models. Check your machine type (see "Front view" on page 21).



- Do not use sharp objects such as a knife or scissors to open the toner cartridge package.
- If toner gets on your clothing, wipe it off with a dry cloth and wash clothing in cold water. Hot water sets toner into fabric.
- When opening a scan unit, hold the document feeder and scan unit together.
- Printing even after the toner empty status can cause serious damage to your machine.

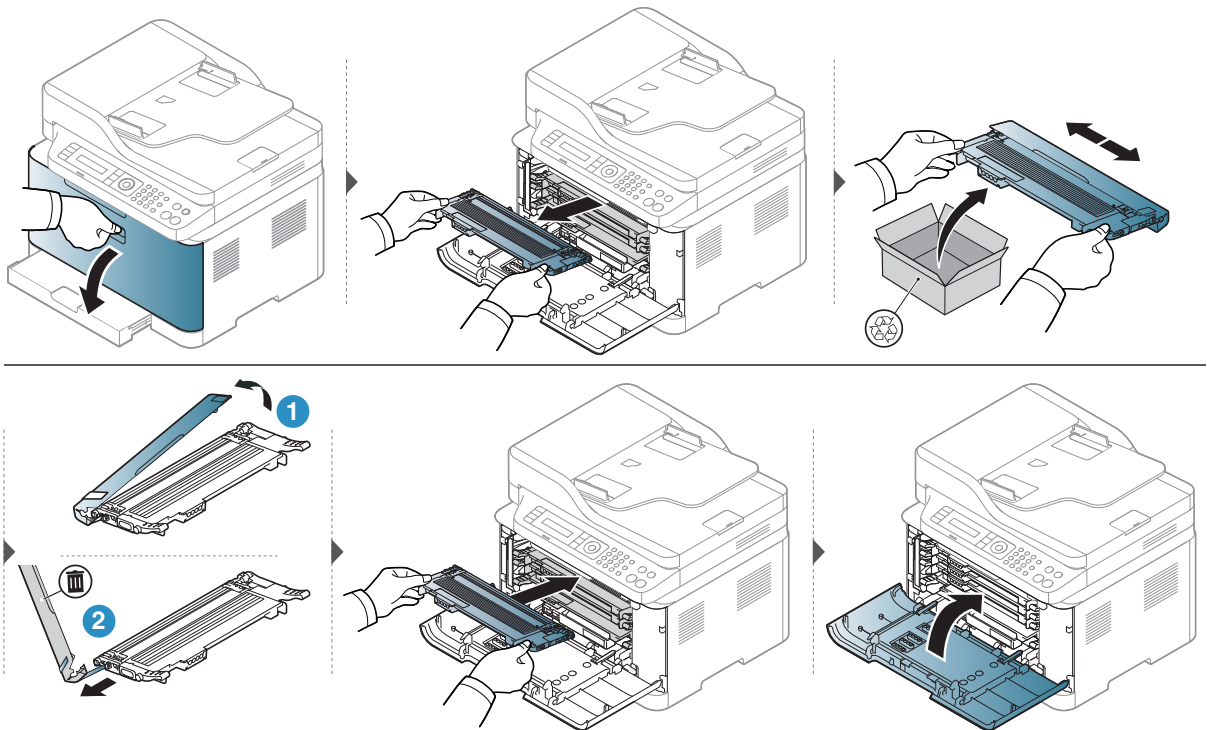

Replacing the imaging drum

When the life span of the imaging drum has expired, the Printing Status window appears on the computer, indicating the imaging drum needs to be replaced. Otherwise, your machine stops printing.



When the imaging unit has reached its end of life, the machine will stop printing. In this case, you can choose to stop or continue printing from the HP Embedded Web Server (**Settings > Machine Settings > System > Setup > Supplies Management > Imaging Unit Stop**). Turning off this option and continuing to print may damage the device's system.



The imaging drum installed in this product is covered by the product warranty. Replacement imaging drums have a one-year limited warranty from the date of installation. The imaging drum installation date displays on the supplies info report. HP's Premium Protection Warranty applies only to the print cartridges for the product.



- Don't use sharp objects such as a knife or scissors to open the imaging drum package. You could damage the surface of the imaging drum.
- Be careful not to scratch the surface of the imaging drum.
- To prevent damage, do not expose the imaging drum to light for more than a few minutes. Cover it with a piece of paper to protect it if necessary.
- Before closing the front cover, make sure all toner cartridges are installed properly.

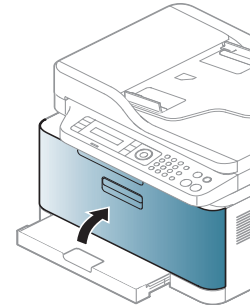
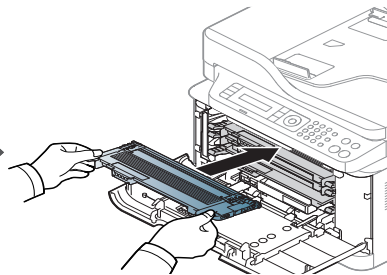
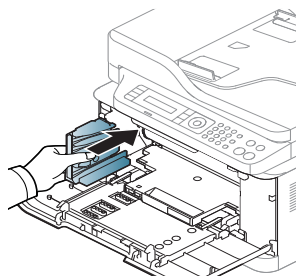
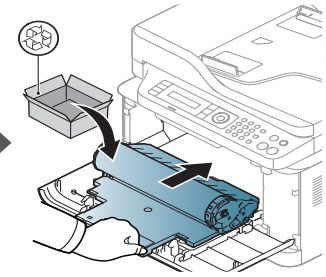
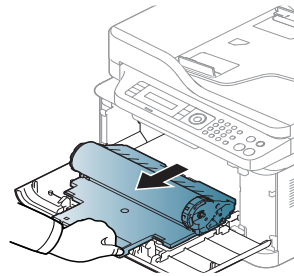
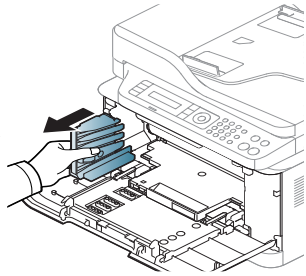
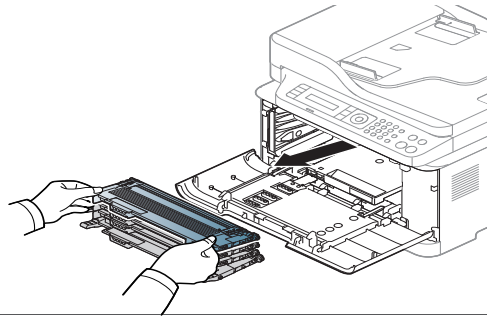
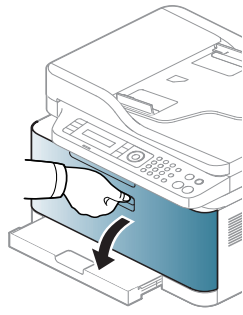

Replacing the toner collection unit

When the life span of the toner collection unit has expired, toner collection unit-related message appears on the screen display of the control panel, indicating the toner collection unit needs to be replaced. Check the toner collection unit for your machine (see "Available supplies" on page 137). For information about installing the toner collection unit, refer to the toner collection unit installation guide included on the package.



- Toner particles can be released inside the machine but it does not mean the machine is damaged. Contact a service representative when print quality problems occur.
 - When you pull out the toner collection unit out of the machine, move the container carefully not to drop it from your hands.
 - Make sure that you lay the toner collection unit on a flat surface so that the toner does not spill.
-



Do not tilt or turn over the container.

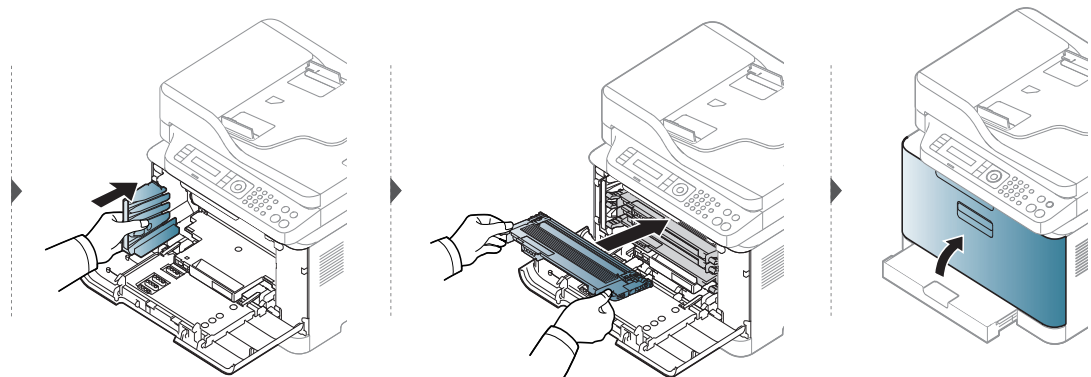
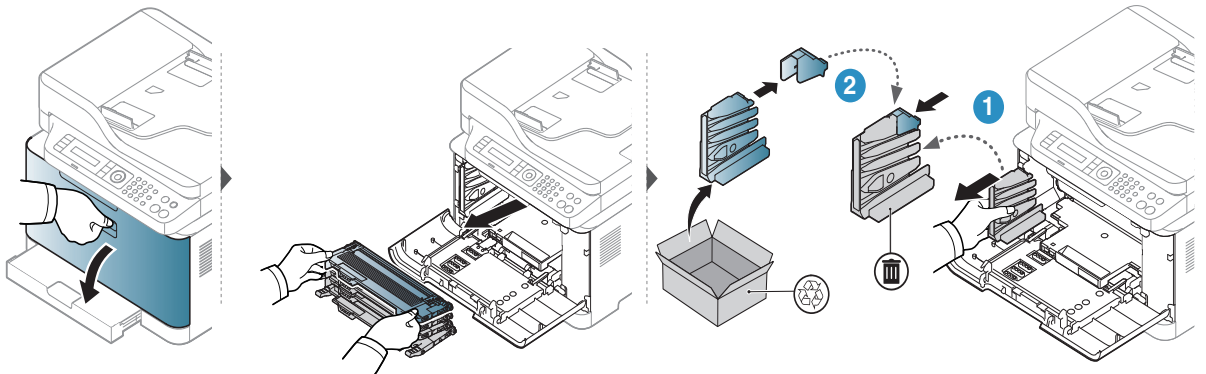

Monitoring the supplies life

If you experience frequent paper jams or printing problems, check the number of pages the machine has printed or scanned. Replace the corresponding parts, if necessary.



It may be necessary to press **OK** to navigate to lower-level menus for some models.

- 1 Select **•••(Menu)** > **System Setup** > **Maintenance** > **Supplies Life** on the control panel.
- 2 Select the option you want and press **OK**.
 - **Total**: Displays the total number of pages printed.
 - **ADF Scan**: Displays the number of pages printed by using the document feeder.
 - **Platen Scan**: Displays the number of pages scanned by using scanner glass.
 - **Supplies Info.:** Prints the supply information page.
- 3 Press  (**Cancel**) to return to ready mode.

Setting the toner low alert

If the amount of toner in the cartridge is low, a message or LED informing the user to change the toner cartridge appears. You can set the option for whether or not this message or LED appears.



- Accessing menus may differ from model to model (see "Accessing the menu" on page 30).
 - It may be necessary to press **OK** to navigate to lower-level menus for some models.
-

- 1 Select **•••(Menu) > System Setup > Maintenance > TonerLow Alert** on the control panel.
- 2 Select the option you want.
- 3 Press **OK** to save the selection.

Cleaning the machine

If printing quality problems occur or if you use your machine in a dusty environment, you need to clean your machine regularly to keep it in the best printing condition and use your machine longer.



- Cleaning the cabinet of the machine with cleaning materials containing large amounts of alcohol, solvents, or other strong substances can discolor or distort the cabinet.
- If your machine or the surrounding area is contaminated with toner, we recommend you use a cloth or tissue dampened with water to clean it. If you use a vacuum cleaner, toner blows in the air and might be harmful to you.

Cleaning the outside

Clean the machine cabinet with a soft, lint-free cloth. Dampen the cloth slightly with water, but be careful not to let any water drip onto or into the machine.

Cleaning the inside

During the printing process, paper, toner, and dust particles can accumulate inside the machine. This buildup can cause print quality problems, such as toner specks or smearing. Cleaning the inside of the machine clears and reduces these problems.



- To prevent damage to the imaging drum, do not expose it to light for more than a few minutes. Cover it with a piece of paper, if necessary.
- Do not touch the green area of the imaging drum. Use the handle on the imaging drum to avoid touching this area.
- Use a dry lint free cloth when cleaning the inside of the machine, be careful not to damage the transfer roller or any other inside parts. Do not use solvents such as benzene or thinner. Printing quality problems can occur and cause damage to the machine.



- Use a dry lint-free cloth to clean the machine.
 - Turn the machine off and unplug the power cord. Wait for the machine to cool down. If your machine has a power switch, turn the power switch off before cleaning the machine.
 - Illustrations on this user's guide may differ from your machine depending on its options or models. Check your machine type (see "Front view" on page 21).
 - When opening a scan unit, hold the document feeder and scan unit together.
-

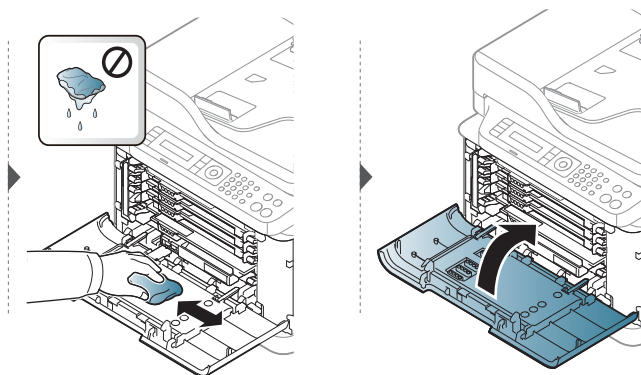
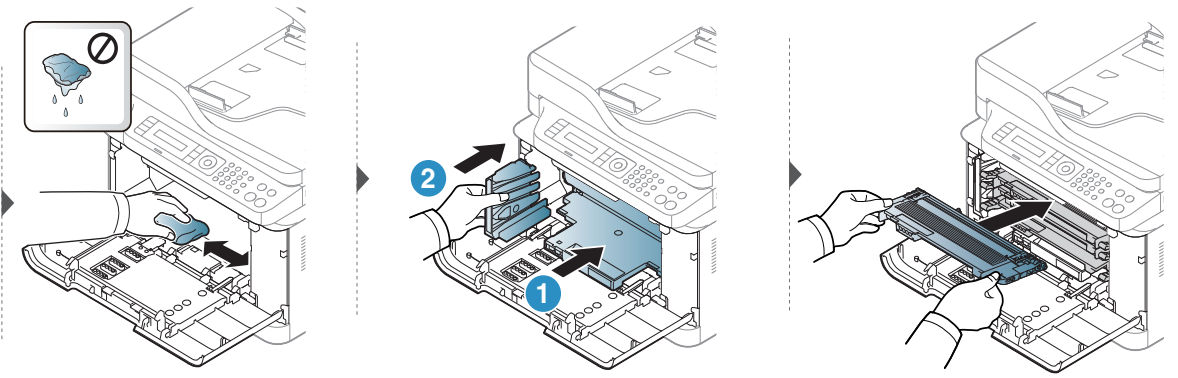
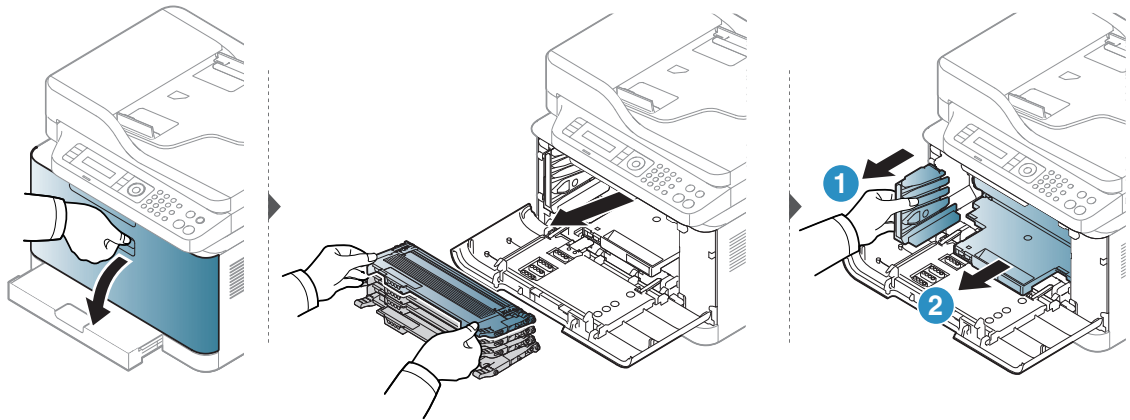

Cleaning the scan unit

Keeping the scan unit clean helps ensure the best possible copies. We suggest that you clean the scan unit at the start of each day and during the day as needed.



- Turn the machine off and unplug the power cord. Wait for the machine to cool down. If your machine has a power switch, turn the power switch off before cleaning the machine.
- Illustrations on this user's guide may differ from your machine depending on its options or models. Check your machine type (see "Front view" on page 21).

1 Slightly dampen a soft, lint-free cloth or paper towel with water.

2 Lift and open the scanner lid.

3 Wipe the surface of the scanner until it is clean and dry.

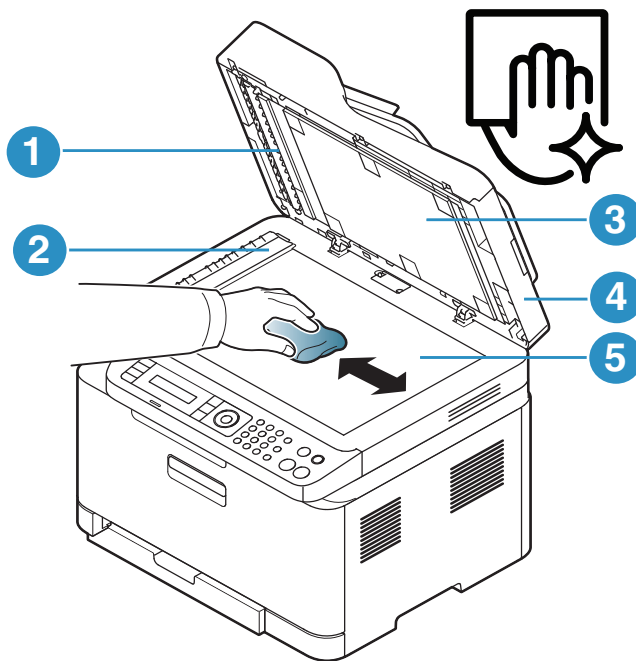

1. White bar
2. Document feeder glass
3. White sheet
4. Scanner lid
5. Scanner glass

4 Close the scanner lid.

Tips for moving & storing your machine

- When moving the machine, do not tilt or turn it upside down. Otherwise, the inside of the machine may be contaminated by toner, which can cause damage to the machine or reduce print quality.
- When moving the machine, make sure at least two people are holding the machine securely.

Troubleshooting

This chapter gives helpful information for what to do if you encounter an error.



This chapter gives helpful information for what to do if you encounter an error. If your machine has a display screen, check the message on the display screen first to solve the error.

- Tips for avoiding paper jams 155
- Clearing original document jams 156
- Clearing paper jams 159
- Understanding the LEDs 162
- A “Low Toner” or “Very Low Toner” message displays in Supplies information report 164
- Understanding display messages 165
- Paper feeding problems 172
- Power and cable connecting problems 173
- Solving other problems 174
- Solve wireless network problems 187

Tips for avoiding paper jams

By selecting the correct medias, most paper jams can be avoided. To avoid paper jams, refer to the following guidelines:

- Ensure that the adjustable guides are positioned correctly (see "Tray overview" on page 40).
- Do not remove paper from the tray while your machine is printing.
- Flex, fan, and straighten paper before loading.
- Do not use creased, damp, or highly curled paper.
- Do not mix papers in a tray.
- Use only recommended print media (see "Print media specifications" on page 192).
- Do not use a paper with a leading-edge curl or wave, it may cause a paper jam or the paper can be wrinkled. Turn the stack of paper over in the tray.

Clearing original document jams

When an original document jams in the document feeder, a warning message appears on the display.



To avoid tearing the document, remove the jammed document slowly and carefully.



To prevent document jams, use the scanner glass for thick, thin or mixed paper- originals.

Original paper jam in front of scanner



- Illustrations on this user's guide may differ from your machine depending on its options or models. Check your machine type (see "Front view" on page 21).
 - This troubleshooting may not be available depending on model or optional goods (see "Variety feature" on page 10).
-

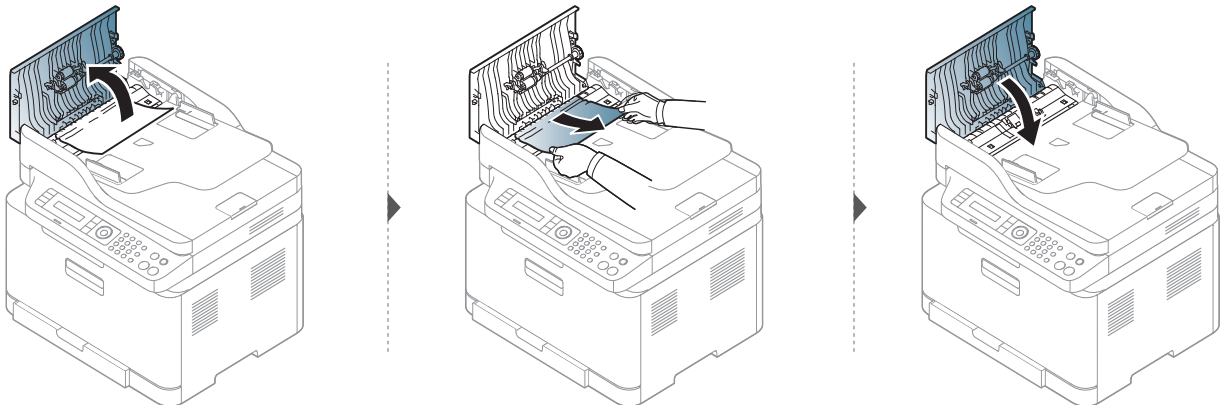

Original paper jam inside of scanner



- Illustrations on this user's guide may differ from your machine depending on its options or models. Check your machine type (see "Front view" on page 21).
- This troubleshooting may not be available depending on model or optional goods (see "Variety feature" on page 10).

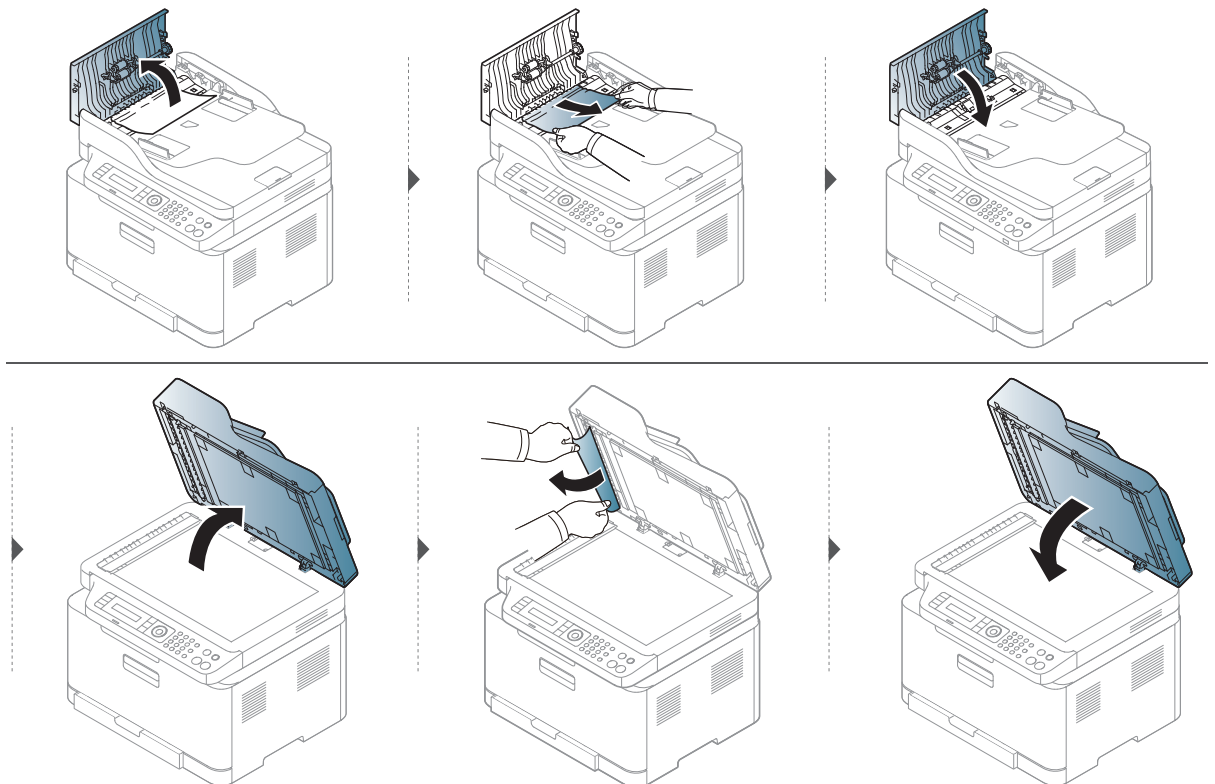

Original paper jam in exit area of scanner



- Illustrations on this user's guide may differ from your machine depending on its options or models. Check your machine type (see "Front view" on page 21).
- This troubleshooting may not be available depending on model or optional goods (see "Front view" on page 21).

- 1 Remove any remaining pages from the document feeder.
- 2 Gently remove the jammed paper from the document feeder.

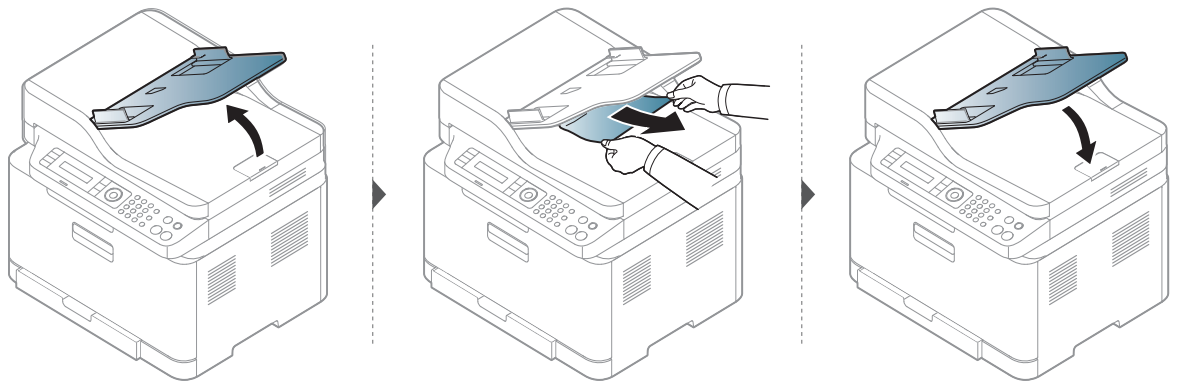

Clearing paper jams



To avoid tearing the paper, pull the jammed paper out slowly and gently.

In tray



Illustrations on this user's guide may differ from your machine depending on its options or models. Check your machine type (see "Front view" on page 21).

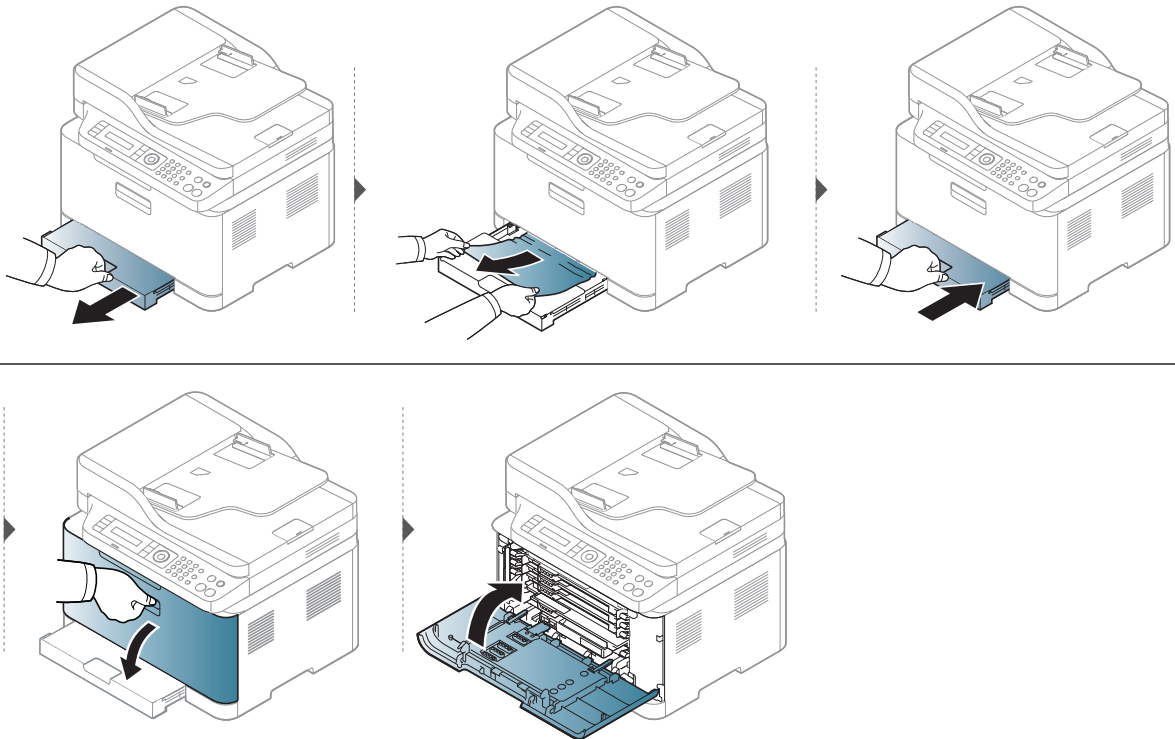

Inside the machine



- The fuser area is hot. Take care when removing paper from the machine.
- Illustrations on this user's guide may differ from your machine depending on its options or models. Check your machine type (see "Front view" on page 21).

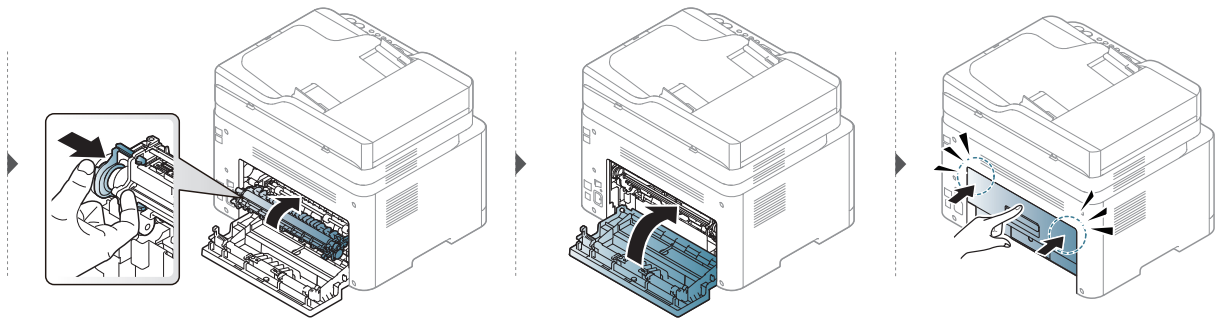
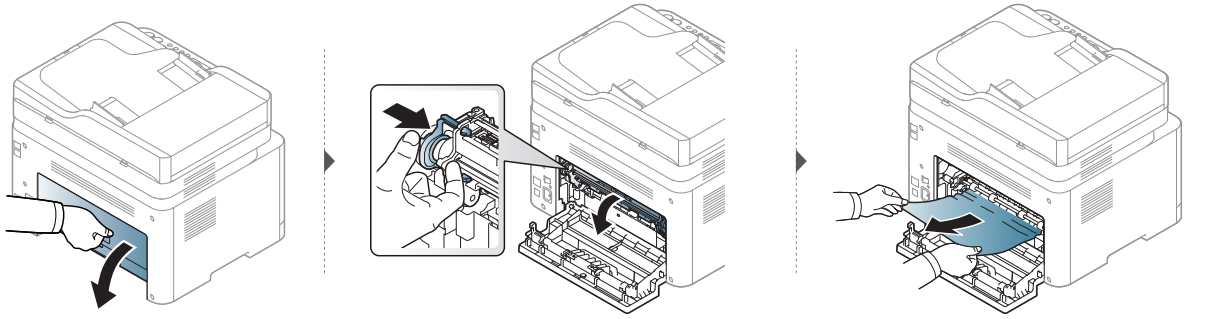

In exit area



- The fuser area is hot. Take care when removing paper from the machine.
 - Illustrations on this user's guide may differ from your machine depending on its options or models. Check your machine type (see "Front view" on page 21).
-

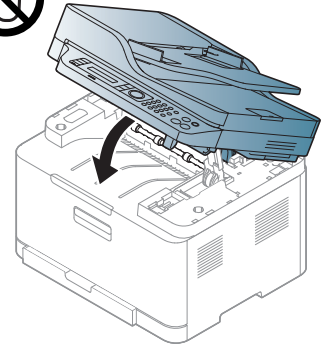
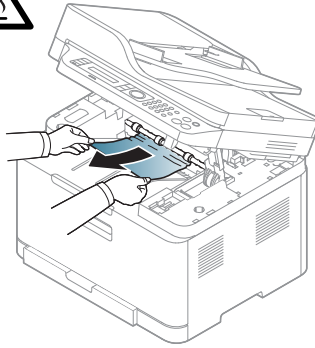
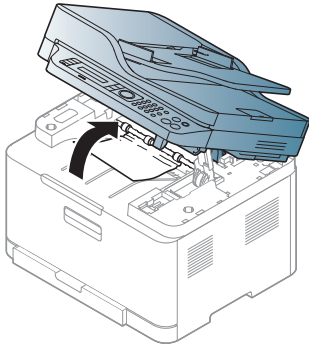

Understanding the LEDs

The color of the LED indicates the machine's current behavior.



- Some LEDs may not be available depending on model or country (see "Control panel overview" on page 24).
- To resolve the error, look at the error message and its instructions from the troubleshooting part (see "Understanding display messages" on page 165).
- If the problem persists, call a service representative.



Status LED

LED	Status	Description	
 (Status)	Off	The machine is off-line.	
	Green	On	<ul style="list-style-type: none"> • The machine is on-line and can be used.
		Blinking	When the machine is receiving or printing data, the backlight blinks.
	Orange	On	The machine has stopped due to a major error.
		Blinking	<ul style="list-style-type: none"> • A minor error has occurred and the machine is waiting for the error to be cleared. Check the display message. When the problem is cleared, the machine resumes. • Small amount of toner is left in the cartridge. The estimated cartridge life^a of toner is close. Prepare a new cartridge for replacement. You may temporarily increase the printing quality by redistributing the toner (see "Redistributing toner" on page 142).^b • The cover is opened. Close the cover. • There is no paper in the tray when receiving or printing data. Load paper in the tray. • A paper jam has occurred (see "Clearing paper jams" on page 159).

a. Estimated cartridge life means the expected or estimated toner cartridge life, which indicates the average capacity of print-outs and is designed pursuant to ISO/IEC 19798. The number of pages may be affected by operating environment, percentage of image area, printing interval, graphics, media and media size. Some amount of toner may remain in the cartridge even when orange LED is on and the printer stops printing.

b. Some LEDs may not be available depending on model or country (see "Control panel overview" on page 24).

Wireless LED/ Power LED

Status		Description	
 (Wireless LED)	Blue	Off	The machine is disconnected from a wireless network.
		On	The machine is connected to a wireless network (see "Wireless network setup" on page 58).
		Blinking	The machine is connecting to a wireless network.
 (Power)	White	On	The machine is in ready mode.
		Blinking	The machine is in power save mode.

A “Low Toner” or “Very Low Toner” message displays in Supplies information report

Low Toner: The printer indicates when a toner cartridge level is low. Actual cartridge life remaining may vary. Consider having a replacement available to install when print quality is no longer acceptable. The cartridge does not need to be replaced now.

Very Low Toner: The printer indicates when the Toner cartridge level is very low. Actual cartridge life remaining may vary. Consider having a replacement available to install when print quality is no longer acceptable. The cartridge does not need to be replaced now unless the print quality is no longer acceptable.

Once an HP toner cartridge has reached **Low Toner** at default HP Embedded Web Server (EWS) setting, HP's Premium Protection Warranty on that toner cartridge has ended.

To the machine prints supplies information report:

- 1 Select **•••(Menu) > System Setup > Report > Supplies Info.** on the control panel.
- 2 Press **OK**.
The machine begins printing.

Understanding display messages

Messages appear on the control panel display to indicate the machine's status or errors. Refer to the tables below to understand the messages' and their meaning, and correct the problem, if necessary.



- If a message is not in the table, reboot the power and try the printing job again. If the problem persists, call a service representative.
 - When you call for service, provide the service representative with the contents of display message.
 - Some messages may not appear depending on the model and options installed.
 - [error number] indicates the error number.
-

Paper Jam-related messages

Message	Meaning	Suggested solutions
Document jam. Remove jam	The loaded original document has jammed in the document feeder.	Clear the jam (see "Original paper jam in front of scanner" on page 156).
Paper Jam inside machine	Paper has jammed inside the machine.	Clear the jam (see "Inside the machine" on page 160).
Paper Jam in tray	Paper has jammed in the paper tray.	Clear the jam (see "Clearing paper jams" on page 159).
Paper Jam in exit area	Paper has jammed in the exit area.	Clear the jam (see "Original paper jam in exit area of scanner" on page 157).
Paper Empty in tray	There is no paper in tray.	Load paper in tray (see "Loading paper in the tray" on page 41).

Toner-related messages

Message	Meaning	Suggested solutions
Install Toner	A toner cartridge is not installed.	Install a toner cartridge.
Error: #C1-xx11 Cartridge Prob.	Toner Cart Failure	Toner cartridge is not installed. Install it.
Error: #C1-xx12 Cartridge Prob.	Toner Cart Failure	Call for service.
Incompatible[<i>color</i>] toner	The toner not compatible.	Install the corresponding toner cartridge with a HP-genuine cartridge. The toner cartridge is not compatible. Check the user guide.
[<i>color</i>] Cartridge Problem	The indicated color toner cartridge is not suitable for your machine.	Install the corresponding toner cartridge with a HP-genuine cartridge.
Low Toner	Small amount of toner is left in the indicated cartridge. The estimated cartridge life ^a of toner is close.	Prepare a new cartridge for a replacement. You may temporarily increase the printing quality by redistributing the toner (see "Redistributing toner" on page 142).

Message	Meaning	Suggested solutions
Very Low Toner	The indicated toner cartridge has almost reached its estimated cartridge life ^a .	<ul style="list-style-type: none"> You can choose Stop or Continue as shown on the control panel. If you select Stop, the printer stops printing and you cannot print any more without changing the cartridge. If you select Continue, the printer keeps printing but the printing quality cannot be guaranteed. Replace the toner cartridge for the best print quality when this message appears. Using a cartridge beyond this stage can result in printing quality issues (see "Replacing the toner cartridge" on page 143). <p> HP does not recommend using a non-genuine HP toner cartridge such as refilled or remanufactured. HP cannot guarantee a non-genuine HP toner cartridge's quality. Service or repair required as a result of using non-genuine HP toner cartridges will not be covered under the machine warranty.</p>
	The indicated toner cartridge has reached its estimated cartridge life. ^a The machine might stop printing.	Replace the toner cartridge (see "Replacing the toner cartridge" on page 143).

a. Estimated cartridge life means the expected or estimated toner cartridge life, which indicates the average capacity of print-outs and is designed pursuant to ISO/IEC 19798 (see "Available supplies" on page 137). The number of pages may be affected by operating environment, percentage of image area, printing interval, media, percentage of image area, and media size. Some amount of toner may remain in the cartridge even when replace new cartridge appears and the machine stops printing.

Imaging drum related messages

Message	Meaning	Suggested solutions
Prepare new Imaging unit	The life of the imaging unit will be expired soon.	Prepare a new imaging unit for a replacement. (See "Replacing the imaging drum" on page 144)
Replace with new imaging unit	The life of the imaging unit will be expired.	Replace the imaging unit with a new one. (See "Replacing the imaging drum" on page 144)

Tray-related messages

Message	Meaning	Suggested solutions
Tray Paper Mismatch	The paper size specified in the printer properties does not match the paper you are loading.	Load the correct paper in the tray.

Network-related messages

Message	Meaning	Suggested solutions
Fail connection to WPS	The machine failed to connect via WPS.	Check the WPS settings (see "Using the WPS Settings" on page 59).
Install wireless NIC	There is a problem on the network interface.	Turn the power switch off and on. If the problem persists, call for service.
Network Problem: IP Conflict	The network IP address you have set is being used by someone else.	Check the IP address and reset it if necessary (see "Printing a network configuration report" on page 55).
Not found Wireless network	The machine cannot find the wireless network.	Check the status of the wireless router or access point, including its configuration and power connections, as well as any devices that may affect wireless communication. If the problem persists, please call for service.
Not Correct Wireless setting	<ul style="list-style-type: none"> The wireless network options are configured incorrectly for the security method. The password entered in the wireless security options is incorrect. The machine does not support the security method used by the access point or wireless router. The access point or wireless router has malfunctioned. 	Reconfigure the wireless options in the machine, SWS, access point, or wireless router. The WPA2-PSK/AES security method is recommended. If the problem persists, please call for service.

Message	Meaning	Suggested solutions
Not connect Wireless AP	The machine failed to connect to the wireless AP(access point or wireless router).	Check the status of the access point, including its configuration and power connections, as well as any devices that may affect wireless communication. If the problem persists, please call for service.
Wi-Fi Direct is not ready	The machine failed to initialize the Wi-Fi Direct connection.	Reboot the machine to initialize the wireless settings. If the problem persists, please call for service.
Wi-Fi Direct is not connect	The machine failed to connect via Wi-Fi Direct.	Turn the Wi-Fi Direct feature off and then back on or reboot the machine or mobile device. If the problem persists, please call for service.

Misc. messages

Message	Meaning	Suggested solutions
Door Open Close it	The cover is not securely latched.	Close the cover until it locks into place.
Door of scanner is open	The cover of scanner is not securely latched.	Close the cover until it locks into place.
Error: [error number] Call for Service	There is a problem in the system.	Reboot the power. If the problem persists, please call for service.
Error: [error number] Door open/close	The imaging unit is installed improperly, or the cover is not securely latched.	Reinstall the imaging unit to confirm it is seated properly. Close the cover until it locks into place.
Error: [error number] Turn off then on	The machine unit cannot be controlled.	Reboot the power and try the printing job again. If the problem persists, please call for service.
ID Control Fail Check CTD Sensor	There is a problem in the CTD sensor.	Reboot the power. If the problem persists, please call for service.

Message	Meaning	Suggested solutions
Output bin Full Remove paper	The output tray is full. Or the sensor is not facing down.	Remove papers from the output tray, the machine resumes printing. Or make sure the sensor is facing down. If the problem persists, call for service.
Prepare Fuser Soon	The life of the fuser unit will be expired soon.	Prepare the fuser unit with a new one. Contact the service representatives.
Prepare new Transfer belt	The life of the transfer belt will expired soon.	Prepare the transfer belt with a new one. Contact the service representatives.
Prepare new transfer roller	The life of the transfer belt will expired soon.	Prepare the transfer belt with a new one. Contact the service representatives.
Replace new Fuser unit	The life of the fuser unit will be expired.	Replace the fuser unit with a new one. Contact the service representatives.
Replace new Transfer belt	The life of the transfer belt has expired.	Replace the transfer belt with a new one. Contact the service representatives.
Replace new transfer roller	The life of the transfer belt has expired.	Replace the transfer belt with a new one. Contact the service representatives.
Replace/Install Waste Toner Tank	The life span of the toner collection unit has expired and the printer will stop printing until a new toner collection unit is placed into the printer.	Replace a toner collection unit with a HP toner collection unit.
Scanner Locked	The scanner is locked.	Reboot the power. If the problem persists, please call for service.
Scan Unit Open or Exit JAM	The scan unit is not securely latched or paper has jammed in the scanner area.	<ul style="list-style-type: none"> • Clear the jam (see "Original paper jam in front of scanner" on page 156). • Close the cover until it locks into place.
Transfer Belt Error	The transfer belt cannot be controlled.	Reboot the power and try the printing job again. If the problem persists, please call for service.

Paper feeding problems

Condition	Suggested solutions
Paper jams during printing.	Clear the paper jam.
Paper sticks together.	<ul style="list-style-type: none">• Check the maximum paper capacity of the tray.• Make sure that you are using the correct type of paper.• Remove paper from the tray and flex or fan the paper.• Humid conditions may cause some paper to stick together.
Multiple sheets of paper do not feed.	Different types of paper may be stacked in the tray. Load paper of only one type, size, and weight.
Paper does not feed into the machine.	<ul style="list-style-type: none">• Remove any obstructions from inside the machine.• Paper has not been loaded correctly. Remove paper from the tray and reload it correctly.• There is too much paper in the tray. Remove excess paper from the tray.• The paper is too thick. Use only paper that meets the specifications required by the machine.
The paper keeps jamming.	<ul style="list-style-type: none">• There is too much paper in the tray. Remove excess paper from the tray.• An incorrect type of paper is being used. Use only paper that meets the specifications required by the machine.• There may be debris inside the machine. Open the front cover and remove any debris.

Power and cable connecting problems

Reboot the power. If the problem persists, please call for service.

Condition	Suggested solutions
The machine is not receiving power, or the connection cable between the computer and the machine is not connected properly.	<ol style="list-style-type: none"><li data-bbox="735 524 1414 560">1. Connect the machine to the electricity supply first.<li data-bbox="735 566 1473 633">2. Check the USB cable or network cable in the machine's rear.<li data-bbox="735 640 1401 707">3. Disconnect the USB cable or network cable in the machine's rear and then, reconnect it.

Solving other problems

Printing problems

Condition	Possible cause	Suggested solutions
The machine does not print.	The machine is not receiving power.	Connect the machine to the electricity supply first. If the machine has a  (Power) button on the control, press it.
	The machine is not selected as the default machine.	Select your machine as your default machine in Windows.
	Check the machine for the following: <ul style="list-style-type: none">• The cover is not closed. Close the cover.• Paper is jammed. Clear the paper jam (see "Clearing paper jams" on page 159).• No paper is loaded. Load paper (see "Loading paper in the tray" on page 41).• The toner cartridge is not installed. Install the toner cartridge (see "Replacing the toner cartridge" on page 143).• Make sure the protect cover and sheets are removed from the toner cartridge (see "Replacing the toner cartridge" on page 143). If a system error occurs, contact your service representative.	
	The connection cable between the computer and the machine is not connected properly.	Disconnect the machine cable and reconnect it (see "Rear view" on page 23).
	The connection cable between the computer and the machine is defective.	If possible, attach the cable to another computer that is working properly and print a job. You can also try using a different machine cable.
	The port setting is incorrect.	Check the Windows printer settings to make sure that the print job is sent to the correct port. If the computer has more than one port, make sure that the machine is attached to the correct one.



Condition	Possible cause	Suggested solutions
The machine does not print.	The machine may be configured incorrectly.	Check the Printing Preferences to ensure that all of the print settings are correct.
	The printer driver may be incorrectly installed.	Uninstall and reinstall the machine's driver.
	The machine is malfunctioning.	Check the display message on the control panel to see if the machine is indicating a system error. Contact a service representative.
	The document size is so big that the hard disk space of the computer is insufficient to access the print job.	Get more hard disk space and print the document again.
	The output tray is full.	Once the paper is removed from the output tray, the machine resumes printing.
The machine selects print materials from the wrong paper source.	The paper option that was selected in the Printing Preferences may be incorrect.	For many software applications, the paper source selection is found under the Paper tab within the Printing Preferences (see "Opening printing preferences" on page 76). Select the correct paper source. See the printer driver help screen (see "Using help" on page 78).
A print job is extremely slow.	The job may be very complex.	Reduce the complexity of the page or try adjusting the print quality settings.
Half the page is blank.	The page orientation setting may be incorrect.	Change the page orientation in your application (see "Opening printing preferences" on page 76). See the printer driver help screen (see "Using help" on page 78).
	The paper size and the paper size settings do not match.	Ensure that the paper size in the printer driver settings matches the paper in the tray. Or, ensure that the paper size in the printer driver settings matches the paper selection in the software application settings you use (see "Opening printing preferences" on page 76).

Condition	Possible cause	Suggested solutions
The machine prints, but the text is wrong, garbled, or incomplete.	The machine cable is loose or defective.	Disconnect the machine cable and reconnect. Try a print job that you have already printed successfully. If possible, attach the cable and the machine to another computer that you know works and try a print job. Finally, try a new machine cable.
	The wrong printer driver was selected.	Check the application's printer selection menu to ensure that your machine is selected.
	The software application is malfunctioning.	Try printing a job from another application.
	The operating system is malfunctioning.	Exit Windows and reboot the computer. Turn the machine off and back on again.
Pages print, but they are blank.	The toner cartridge is defective or out of toner.	Redistribute the toner, if necessary. If necessary, replace the toner cartridge. <ul style="list-style-type: none"> • See "Redistributing toner" on page 142. • See "Replacing the toner cartridge" on page 143.
	The file may have blank pages.	Check the file to ensure that it does not contain blank pages.
	Some parts, such as the controller or the board, may be defective.	Contact a service representative.
The machine does not print PDF files correctly. Some parts of graphics, text, or illustrations are missing.	Incompatibility between the PDF file and the Acrobat products.	Printing the PDF file as an image may enable the file to print. Turn on Print As Image from the Acrobat printing options.  It will take longer to print when you print a PDF file as an image.
The print quality of photos is not good. Images are not clear.	The resolution of the photo is very low.	Reduce the photo size. If you increase the photo size in the software application, the resolution will be reduced.
Before printing, the machine emits vapor near the output tray.	Using damp paper can cause vapor during printing.	This is not a problem. Just keep printing.

Condition	Possible cause	Suggested solutions
The machine does not print special-sized paper, such as billing paper.	Paper size and paper size setting do not match.	Set the correct paper size in the Custom in Paper tab in Printing Preferences (see "Opening printing preferences" on page 76).
The printed billing paper is curled.	The paper type setting does not match.	Change the printer option and try again. Go to Printing Preferences , click Paper tab, and set type to Heavy 90-120g (see "Opening printing preferences" on page 76).

Printing quality problems

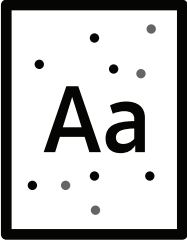
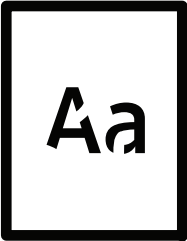
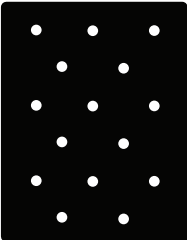
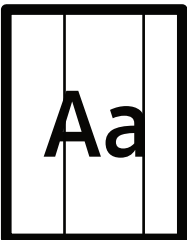

If the inside of the machine is dirty or paper has been loaded improperly, there might be a reduction in print quality. See the table below to clear the problem.

Condition	Suggested solutions
<p>Light or faded print</p> 	<ul style="list-style-type: none"> • If a vertical white streak or faded area appears on the page, the toner supply is low. Install a new toner cartridge (see "Replacing the toner cartridge" on page 143). • If a vertical white streak or faded area still appears on the page even though the machine has enough toner supply, open and close the front door 3 ~ 4 times (see "Machine overview" on page 20). • The paper may not meet paper specifications; for example, the paper may be too moist or rough. • If the entire page is light, the print resolution setting is too low or the toner save mode is on. Adjust the print resolution and turn the toner save mode off. See the help screen of the printer driver. • A combination of faded or smeared defects may indicate that the toner cartridge needs cleaning. Clean the inside of your machine (see "Cleaning the machine" on page 149). • The surface of the LSU part inside the machine may be dirty. Clean the inside of your machine (see "Cleaning the machine" on page 149). If these steps do not correct the problem, contact a service representative.
<p>The top half of the paper is printed lighter than the rest of the paper</p> 	<p>The toner might not adhere properly to this type of paper.</p> <ul style="list-style-type: none"> • Change the printer option and try again. Go to Printing Preferences, click the Paper tab, and set the paper type to Recycled (see "Opening printing preferences" on page 76).

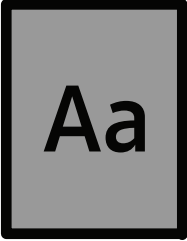
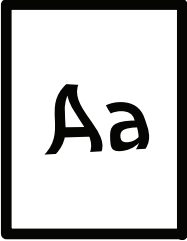
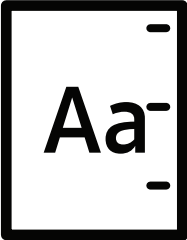
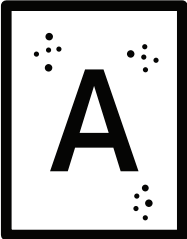
Condition	Suggested solutions
<p>Toner specks</p> 	<ul style="list-style-type: none"> • The paper may not meet specifications; for example, the paper may be too moist or rough. • The transfer roller may be dirty. Clean the inside of your machine (see "Cleaning the machine" on page 149). • The paper path may need cleaning. Contact a service representative (see "Cleaning the machine" on page 149).
<p>Dropouts</p> 	<p>If faded areas, generally rounded, occur randomly on the page:</p> <ul style="list-style-type: none"> • A single sheet of paper may be defective. Try reprinting the job. • The moisture content of the paper is uneven or the paper has moist spots on its surface. Try a different brand of paper. • The paper lot is bad. The manufacturing processes can cause some areas to reject toner. Try a different kind or brand of paper. • Change the printer option and try again. Go to Printing Preferences, click the Paper tab, and set type to Heavy 90-120g (see "Opening printing preferences" on page 76). <p>If these steps do not correct the problem, contact a service representative.</p>
<p>White Spots</p> 	<p>If white spots appear on the page:</p> <ul style="list-style-type: none"> • The paper is too rough and a lot of dirt from paper falls to the inner components within the machine, so the transfer roller may be dirty. Clean the inside of your machine (see "Cleaning the machine" on page 149). • The paper path may need cleaning. Clean the inside of your machine (see "Cleaning the machine" on page 149). <p>If these steps do not correct the problem, contact a service representative.</p>
<p>Vertical lines</p> 	<p>If black vertical streaks appear on the page:</p> <ul style="list-style-type: none"> • The surface (drum part) of the imaging unit inside the machine has probably been scratched. Remove the imaging unit and install a new one. <p>If white vertical streaks appear on the page:</p> <ul style="list-style-type: none"> • The surface of the LSU part inside the machine may be dirty. Clean the inside of your machine (see "Cleaning the machine" on page 149). If these steps do not correct the problem, contact a service representative.

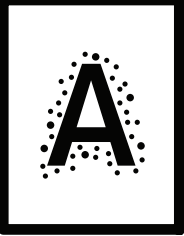
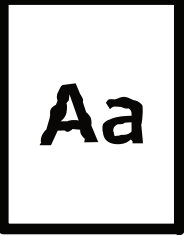
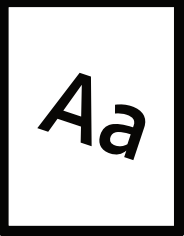
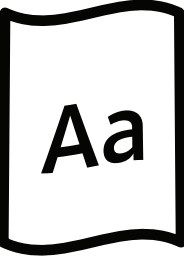
Condition	Suggested solutions
<p>Black or color background</p> 	<p>If the amount of background shading becomes unacceptable:</p> <ul style="list-style-type: none"> • Change to a lighter weight paper. • Check the environmental conditions: very dry conditions or a high level of humidity (higher than 80% RH) can increase the amount of background shading. • Remove the old imaging unit and install a new one. • Thoroughly redistribute the toner (see "Redistributing toner" on page 142).
<p>Toner smear</p> 	<ul style="list-style-type: none"> • Clean the inside of the machine (see "Cleaning the machine" on page 149). • Check the paper type and quality. • Remove the imaging unit and install a new one.
<p>Vertical repetitive defects</p> 	<p>If marks repeatedly appear on the printed side of the page at even intervals:</p> <ul style="list-style-type: none"> • The imaging unit may be damaged. If you still have the same problem, remove the imaging unit and, install a new one. • Parts of the machine may have toner on them. If the defects occur on the back of the page, the problem will likely correct itself after a few more pages. • The fusing assembly may be damaged. Contact a service representative.
<p>Background scatter</p> 	<p>Background scatter results from bits of toner randomly distributed on the printed page.</p> <ul style="list-style-type: none"> • The paper may be too damp. Try printing with a different batch of paper. Do not open packages of paper until necessary so that the paper does not absorb too much moisture. • If background scatter covers the entire surface area of a printed page, adjust the print resolution through your software application or in Printing Preferences (see "Opening printing preferences" on page 76). Ensure the correct paper type is selected. For example: If Thicker Paper is selected, but Plain Paper actually used, an overcharging can occur causing this copy quality problem. • If you are using a new toner cartridge, redistribute the toner first (see "Redistributing toner" on page 142).

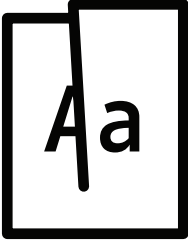
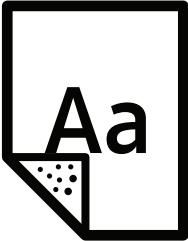
Condition	Suggested solutions
<p>Toner particles are around bold characters or pictures</p> 	<p>The toner might not adhere properly to this type of paper.</p> <ul style="list-style-type: none"> • Change the printer option and try again. Go to Printing Preferences, click the Paper tab, and set the paper type to Recycled (see "Opening printing preferences" on page 76). • Ensure the correct paper type is selected. For example: If Thicker Paper is selected, but Plain Paper actually used, an overcharging can occur causing this copy quality problem.
<p>Misformed characters</p> 	<ul style="list-style-type: none"> • If characters are improperly formed and producing hollow images, the paper stock may be too slick. Try different paper.
<p>Page skew</p> 	<ul style="list-style-type: none"> • Ensure that the paper is loaded properly. • Check the paper type and quality. • Ensure that the guides are not too tight or too loose against the paper stack.
<p>Curl or wave</p> 	<ul style="list-style-type: none"> • Ensure that the paper is loaded properly. • Check the paper type and quality. Both high temperature and humidity can cause paper curl. • Turn the stack of paper over in the tray. Also try rotating the paper 180° in the tray.

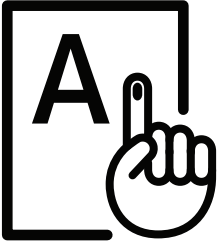
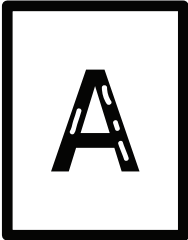
Condition	Suggested solutions
<p>Wrinkles or creases</p> 	<ul style="list-style-type: none"> • Ensure that the paper is loaded properly. • Check the paper type and quality. • Turn the stack of paper over in the tray. Also try rotating the paper 180° in the tray.
<p>Back of printouts are dirty</p> 	<ul style="list-style-type: none"> • Check for leaking toner. Clean the inside of the machine (see "Cleaning the machine" on page 149).
<p>Solid color or black pages</p> 	<ul style="list-style-type: none"> • The imaging unit may not be installed properly. Remove the imaging unit and reinsert it. • The imaging unit may be defective. Remove the imaging unit and install a new one. • The machine may require repairing. Contact a service representative.
<p>Loose toner</p> 	<ul style="list-style-type: none"> • Clean the inside of the machine (see "Cleaning the machine" on page 149). • Check the paper type and quality. • Remove the imaging unit and then, install a new one (see "Replacing the toner cartridge" on page 143). <p>If the problem persists, the machine may require repair. Contact a service representative.</p>
<p>Character voids</p> 	<p>Character voids are white areas within parts of characters that should be solid black:</p> <ul style="list-style-type: none"> • You may be printing on the wrong surface of the paper. Remove the paper and turn it around. • The paper may not meet paper specifications.

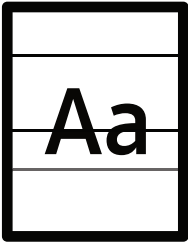
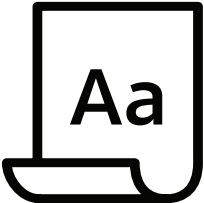
Condition	Suggested solutions
<p>Horizontal stripes</p> 	<p>If horizontally aligned black streaks or smears appear:</p> <ul style="list-style-type: none"> • The imaging unit may be installed improperly. Remove the imaging unit and reinsert it. • The imaging unit may be defective. Remove the imaging unit and install a new one. <p>If the problem persists, the machine may require repairing. Contact a service representative.</p>
<p>Curl</p> 	<p>If the printed paper is curled or paper does not feed into the machine:</p> <ul style="list-style-type: none"> • Turn the stack of paper over in the tray. Also try rotating the paper 180° in the tray. • Change the printer's paper option and try again. Go to Printing Preferences, click the Paper tab, and set type to Light 60-69g (see "Opening printing preferences" on page 76).
<ul style="list-style-type: none"> • An unknown image repetitively appears on a few sheets • Loose toner • Light print or contamination occurs 	<p>Your machine is probably being used at an altitude of 1,000 m (3,281 ft) or above.</p> <p>The high altitude may affect the print quality, such as loose toner or light imaging. Change the altitude setting for your machine (see "Altitude adjustment" on page 37).</p>

Copying problems

Condition	Suggested solutions
<p>Copies are too light or too dark.</p>	<p>Adjust the darkness in copy feature to lighten or darken the backgrounds of copies (see "Changing the settings for each copy" on page 88).</p>
<p>Smears, lines, marks, or spots appear on copies.</p>	<ul style="list-style-type: none"> • If the defects are on the original, adjust darkness in copy feature to lighten the background of your copies. • Adjust background in copy setup removes the background color (see "Adjust Bkgd." on page 122). • If there are no defects on the original, clean the scan unit (see "Cleaning the scan unit" on page 152).
<p>Copy image is skewed.</p>	<ul style="list-style-type: none"> • Ensure that the original is aligned with the registration guide. • The transfer roller may be dirty. Clean the inside of your machine (see "Cleaning the machine" on page 149).

Condition	Suggested solutions
Blank copies print out.	<p>Ensure that the original is face down on the scanner glass or face up in the document feeder.</p> <p>If these steps do not correct the problem, contact a service representative.</p>
Image rubs off the copy easily.	<ul style="list-style-type: none"> • Replace the paper in the tray with paper from a new package. • In high humidity areas, do not leave paper in the machine for extended periods of time.
Frequent copy paper jams occur.	<ul style="list-style-type: none"> • Fan the paper, then turn it over in the tray. Replace the paper in the tray with a fresh supply. Check/adjust the paper guides, if necessary. • Ensure that the paper is the proper type and weight (see "Print media specifications" on page 192). • Check for copy paper or pieces of copy paper remaining in the machine after a paper jam has been cleared.
Toner cartridge produces fewer copies than expected before running out of toner.	<ul style="list-style-type: none"> • Your originals may contain pictures, solids, or heavy lines. For example, your originals may be forms, newsletters, books, or other documents that use more toner. • The scanner lid may be left open while copies are being made. • Turn the machine off and back on.

Scanning problems

Condition	Suggested solutions
The scanner does not work.	<ul style="list-style-type: none"> • Make sure that you place the original to be scanned face down on the scanner glass, or face up in the document feeder (see "Loading originals" on page 51). • There may not be enough available memory to hold the document you want to scan. Try the Prescan function to see if that works. Try lowering the scan resolution rate. • Check that the machine printer cable is connected properly. • Make sure that the machine printer cable is not defective. Switch the printer cable with a known good cable. If necessary, replace the printer cable. • Check that the scanner is configured correctly. Check scan setting in the HP MFP Scan or the application you want to use to make certain that the scanner job is being sent to the correct port (for example, USB001).
The unit scans very slowly.	<ul style="list-style-type: none"> • Check if the machine is printing received data. If so, scan the document after the received data has been printed. • Graphics are scanned more slowly than text.

Condition	Suggested solutions
<p>Message appears on your computer screen:</p> <ul style="list-style-type: none"> • Device can't be set to the H/W mode you want. • Port is being used by another program. • Port is disabled. • Scanner is busy receiving or printing data. When the current job is completed, try again. • Invalid handle. • Scanning has failed. 	<ul style="list-style-type: none"> • There may be a copying or printing job in progress. Try your job again when that job is finished. • The selected port is currently being used. Restart your computer and try again. • The machine printer cable may be improperly connected or the power may be off. • The scanner driver is not installed or the operating environment is not set up properly. • Ensure that the machine is properly connected and the power is on, then restart your computer. • The USB cable may be improperly connected or the power may be off.

Faxing problems

Condition	Suggested solutions
<p>The machine is not working, there is no display, or the buttons are not working.</p>	<ul style="list-style-type: none"> • Unplug the power cord and plug it in again. • Ensure that there is power being supplied to the electrical outlet. • Ensure that the power is turned on.
<p>No dial tone.</p>	<ul style="list-style-type: none"> • Check that the phone line is properly connected (see "Rear view" on page 23). • Check that the phone socket on the wall is working by plugging in another phone.
<p>The numbers stored in memory do not dial correctly.</p>	<p>Make sure that the numbers are stored in memory correctly. To check that, print an address book list.</p>
<p>The original does not feed into the machine.</p>	<ul style="list-style-type: none"> • Make sure that the paper is not wrinkled and you are inserting it in correctly. Check that the original is the right size, not too thick or thin. • Make sure that the document feeder is firmly closed. • The document feeder rubber pad may need to be replaced. Contact a service representative (see "Available maintenance parts" on page 139).
<p>Faxes are not received automatically.</p>	<ul style="list-style-type: none"> • The receiving mode should be set to fax (see "Changing the receive modes" on page 107). • Make sure that there is paper in the tray (see "Print media specifications" on page 192). • Check to see if the display shows any error message. If it does, clear the problem.

Condition	Suggested solutions
The machine does not send.	<ul style="list-style-type: none"> • Make sure that the original is loaded in the document feeder or on the scanner glass. • Check the fax machine you are sending to, to see if it can receive your fax.
The incoming fax has blank spaces or is of poor-quality.	<ul style="list-style-type: none"> • The fax machine sending you the fax may be faulty. • A noisy phone line can cause line errors. • Check your machine by making a copy. • A toner cartridge has almost reached its estimated cartridge life. Replace the toner cartridge (see "Replacing the toner cartridge" on page 143).
Some of the words on an incoming fax are stretched.	The fax machine sending the fax had a temporary document jam.
There are lines on the originals you sent.	Check your scan unit for marks and clean it (see "Cleaning the scan unit" on page 152).
The machine dials a number, but the connection with the other fax machine fails.	The other fax machine may be turned off, out of paper, or cannot answer incoming calls. Speak with the other machine operator and ask them to solve the problem on their side.
Faxes do not store in memory.	There may not be enough memory space to store the fax. If the display indicating the memory status shows, delete any faxes you no longer need from the memory, and then try to store the fax again. Call for service.
Blank areas appear at the bottom of each page or on other pages, with a small strip of text at the top.	You may have chosen the wrong paper settings in the user option setting. Check the paper size and type again.

Operating system problems

Common Windows problems

Condition	Suggested solutions
"File in Use" message appears during installation.	Exit all software applications. Remove all software from the startup group, then restart Windows. Reinstall the printer driver.
"General Protection Fault", "Exception OE", "Spool 32", or "Illegal Operation" messages appear.	Close all other applications, reboot Windows and try printing again.

Condition	Suggested solutions
<p>“Fail To Print”, “A printer timeout error occurred” message appear.</p>	<p>These messages may appear during printing. Just keep waiting until the machine finishes printing. If the message appears in ready mode or after printing has completed, check the connection and/or whether an error has occurred.</p>
<p>Machine information is not displayed when you click the device in the Devices and Printers.</p>	<p>Check the Printer properties. Click the Ports tab. (Control Panel > Devices and Printers > Right-click on your printer icon and select Printer properties) If the port is set to File or LPT, uncheck them and select TCP/IP, USB, or WSD.</p>



Refer to the Microsoft Windows User’s Guide that came with your computer for further information on Windows error messages.

Solve wireless network problems

Use the troubleshooting information to help resolve issues.



To determine whether Wi-Fi Direct printing is enabled on your printer, print a configuration page from the printer control panel.

Wireless connectivity checklist

- Verify that the printer and the wireless router are turned on and have power. Also make sure that the wireless radio in the printer is turned on.
- Verify that the service set identifier (SSID) is correct. Print a configuration page to determine the SSID (see "Printing a network configuration report" on page 55).
- With secured networks, verify that the security information is correct. If the security information is incorrect, run the wireless setup again.
- If the wireless network is working correctly, try accessing other computers on the wireless network. If the network has Internet access, try connecting to the Internet over a wireless connection.
- Verify that the encryption method (AES or TKIP) is the same for the printer as it is for the wireless access point (on networks using WPA security).
- Verify that the printer is within the range of the wireless network. For most networks, the printer must be within 30 m (100 ft) of the wireless access point (wireless router).
- Verify that obstacles do not block the wireless signal. Remove any large metal objects between the access point and the printer. Make sure poles, walls, or support columns containing metal or concrete do not separate the printer and wireless access point.
- Verify that the printer is located away from electronic devices that might interfere with the wireless signal. Many devices can interfere with the wireless signal including motors, cordless phones, security system cameras, other wireless networks, and some Bluetooth devices. Verify that the print driver is installed on the computer.
- Verify that you have selected the correct printer port.
- Verify that the computer and printer connect to the same wireless network.
- For OS X, verify that the wireless router supports Bonjour.

The printer does not print after the wireless configuration completes

1. Make sure that the printer is turned on and in the ready state.
2. Turn off any third-party firewalls on your computer.
3. Make sure that the wireless network is working correctly.
4. Make sure that your computer is working correctly. If necessary, restart the computer.
5. Verify that you can open the printer HP Embedded Web Server from a computer on the network.

The printer does not print, and the computer has a third-party firewall installed

1. Update the firewall with the most recent update available from the manufacturer.
2. If programs request firewall access when you install the printer or try to print, make sure you allow the programs to run.
3. Temporarily turn off the firewall, and then install the wireless printer on the computer. Enable the firewall when you have completed the wireless installation.

The wireless connection does not work after moving the wireless router or printer

1. Make sure that the router or printer connects to the same network that your computer connects to.
2. Print a configuration page.
3. Compare the service set identifier (SSID) on the configuration page to the SSID in the printer configuration for the computer.
4. If the service set identifier (SSID) are not the same, the devices are not connecting to the same network. Reconfigure the wireless setup for the printer.

Cannot connect more computers to the wireless printer

1. Make sure that the other computers are within the wireless range and that no obstacles block the signal. For most networks, the wireless range is within 30 m (100 ft) of the wireless access point.
2. Make sure that the printer is turned on and in the ready state.
3. Make sure there are not more than 5 concurrent Wi-Fi Direct users.
4. Turn off any third-party firewalls on your computer.
5. Make sure that the wireless network is working correctly.
6. Make sure that your computer is working correctly. If necessary, restart the computer.

The wireless printer loses communication when connected to a VPN

- Typically, you cannot connect to a VPN and other networks at the same time.

The network does not appear in the wireless networks list

- Make sure the wireless router is turned on and has power.
- The network might be hidden. However, you can still connect to a hidden network.

The wireless network is not functioning

1. To verify if the network has lost communication, try connecting other devices to the network.
2. Test network communication by pinging the network.
 - a. Open a command-line prompt on your computer.
 - For Windows, click **Start**, click **Run**, type cmd, and then press **Enter**.
 - For OS X, go to **Applications**, then **Utilities**, and open **Terminal**.

- b. Type ping followed by the router IP address.
 - c. If the window displays round-trip times, the network is working.
3. Make sure that the router or printer connects to the same network that the computer connects to.
 - a. Print a configuration page (see "Printing a network configuration report" on page 55).
 - b. Compare the service set identifier (SSID) on the configuration report to the SSID in the printer configuration for the computer.
 - c. If the numbers are not the same, the devices are not connecting to the same network. Reconfigure the wireless setup for the printer.

Perform a wireless network diagnostic test

From the printer control panel, you can run a diagnostic test that provides information about the wireless network settings (see "Printing a network configuration report" on page 55).

Appendix

This chapter provides product specifications.

- General Specifications 191
- Print media specifications 192
- System requirements 194

General Specifications



The specification values listed below are subject to change without notice. See www.hp.com/support/colorlaser170MFP for possible changes in information.

Items		Description
Dimension ^a (Width x Length x Height)		<ul style="list-style-type: none"> • HP Color Laser MFP 178nw, 178nwg series: 406 x 363 x 288.7 mm (16 x 14.3 x 11.4 inches) • HP Color Laser MFP 179fnw, 179fwg series: 406 x 363 x 344.1 mm (16 x 14.3 x 13.6 inches)
Weight ^a (Machine with consumables)		<ul style="list-style-type: none"> • HP Color Laser MFP 178nw, 178nwg series: 12.94 Kg (28.53 lbs) • HP Color Laser MFP 179fnw, 179fwg series: 14.08 Kg (31.04 lbs)
Temperature	Operation	10 to 32°C (50 to 89.6°F)
	Storage (packed)	-20 to 40°C (-4 to 104°F)
Humidity	Operation	20 to 80% RH
	Storage (packed)	10 to 90% RH
Power rating ^b	110 volt models	AC 110 - 127 V
	220 volt models	AC 220 - 240 V

a. Dimensions and weight are measured without other accessories.

b. See the rating label on the machine for the correct voltage (V), frequency (hertz) and of current (A) for your machine.

Print media specifications

Type	Size	Dimensions	Print media weight/Capacity ^a
			Tray
Plain	Letter	216 x 279 mm (8.5 x 11 inches)	60 to 85 g/m ² (16 to 23 lbs bond) <ul style="list-style-type: none"> • 150 sheets of 75 g/m² (20 lbs bond) • Maximum stack height: 15.5mm (0.6 inches)
	A4	210 x 297 mm (8.27 x 11.69 inches)	
	Legal	216 x 356 mm (8.5 x 14 inches)	
	Oficio 216 x340mm	216 x 343 mm (8.5 x 13.5 inches)	
	Oficio 8.5x13	216 x 330 mm (8.5 x 13 inches)	
	B5(JIS)	182 x 257 mm (7.17 x 10.12 inches)	
	Executive	184 x 267 mm (7.25 x 10.5 inches)	
	A5	149 x 210 mm (5.85 x 8.27 inches)	
	A6	105 x 149 mm (4.13 x 5.85 inches)	
Heavy 90-120g	Refer to the Plain paper section	Refer to the Plain paper section	86 to 120 g/m ² (23 to 32lbs bond) <ul style="list-style-type: none"> • 5 sheets
Light 60-69g	Refer to the Plain paper section	Refer to the Plain paper section	60 to 70 g/m ² (16 to 19 lbs bond) <ul style="list-style-type: none"> • 150 sheets of 60 g/m² (16 lbs bond) • Maximum stack height : 15.5mm (0.6 inches)
Colored, Preprinted,	Refer to the Plain paper section	Refer to the Plain paper section	60 to 85 g/m ² (16 to 24 lbs bond) <ul style="list-style-type: none"> • 150 sheets of 75 g/m² (20 lbs bond) • Maximum stack height : 15.5mm (0.6 inches)

Type	Size	Dimensions	Print media weight/Capacity ^a
			Tray
Recycled	Refer to the Plain paper section	Refer to the Plain paper section	60 to 85 g/m ² (16 to 24 lbs bond) <ul style="list-style-type: none"> • 5 sheets of 75 g/m² (20 lbs bond) • Maximum stack height : 15.5mm (0.6 inches)
Labels ^b	Refer to the Plain paper section	Refer to the Plain paper section	120 to 150 g/m ² (32 to 40 lbs bond) <ul style="list-style-type: none"> • 5 sheets
X-Hvy 121-163	Letter, Legal, Oficio 216 x340mm, Oficio 8.5x13, A4, B5(JIS), Executive, A5, A5 LEF, 4x6	Refer to the Plain paper section	121 to 163 g/m ² (32 to 43 lbs bond) <ul style="list-style-type: none"> • 5 sheets
Bond	Refer to the Plain paper section	Refer to the Plain paper section	105 to 120 g/m ² (28 to 32 lbs bond) <ul style="list-style-type: none"> • 10 sheets
Glossy111-130 g	Letter, A4, 4x6	Refer to the Plain paper section	111 to 130 g/m ² (30 to 58 lbs bond) <ul style="list-style-type: none"> • 1 sheets
Glossy131-175 g	Letter, A4, 4x6	Refer to the Plain paper section	131 to 175 g/m ² (30 to 58 lbs bond) <ul style="list-style-type: none"> • 1 sheets
Glossy176-220 g	Letter, A4, 4x6	Refer to the Plain paper section	176 to 220 g/m ² (30 to 58 lbs bond) <ul style="list-style-type: none"> • 1 sheets
HP Matte 120 g	Letter, A4, 4x6	Refer to the Plain paper section	120 g/m ² (30 to 58 lbs bond) <ul style="list-style-type: none"> • 1 sheets
HP Matte 150 g	Letter, A4, 4x6	Refer to the Plain paper section	150 g/m ² (30 to 58 lbs bond) <ul style="list-style-type: none"> • 1 sheets
HP Matte 200 g	Letter, A4, 4x6	Refer to the Plain paper section	200 g/m ² (30 to 58 lbs bond) <ul style="list-style-type: none"> • 1 sheets
Minimum size (custom)		76 x 148.5 mm (3.0 x 5.85 inches)	60 to 120 g/m ² (16 to 32 lbs bond)
Maximum size (custom)		216x 356 mm (8.5 x 14 inches)	

a.Maximum capacity may differ depending on media weight, thickness, and environmental conditions.

b.The smoothness of the labels used in this machine is 100 to 250 (sheffield). This means the numeric level of smoothness.



If media weight is over 120 g/m² (32 lbs bond), load a paper into the tray one by one.

System requirements

Microsoft® Windows®



Printer software are occasionally updated due to release of new operating system and etc. If needed, download the latest version from the HP website (www.hp.com/support/colorlaser170MFP).

Windows 7, 32-bit and 64-bit	The HP printer-specific print driver is installed for this operating system as part of the software installation.	
Windows 8, 32-bit and 64-bit	The HP printer-specific print driver is installed for this operating system as part of the software installation.	
Windows 8.1, 32-bit and 64-bit	The HP V4 printer-specific print driver is installed for this operating system as part of the software installation.	
Windows 10, 32-bit and 64-bit	The HP V4 printer-specific print driver is installed for this operating system as part of the software installation.	
Windows Server 2008 R2, 64-bit	The HP PCLm.S printer-specific print driver is available for download from the printer-support website. Download the driver, and then use the Microsoft Add Printer tool to install it.	Microsoft retired mainstream support for Windows Server 2008 in January 2015. HP will continue to provide best effort support for the discontinued Server 2008 operating system.
Windows Server 2008 R2, SP1, 64-bit	The HP printer-specific print driver is installed for this operating system as part of the software installation.	
Windows Server 2012	The HP printer-specific print driver is installed for this operating system as part of the software installation.	
Windows Server 2012 R2	The HP printer-specific print driver is installed for this operating system as part of the software installation.	
Windows Server 2016, 64-bit	The HP printer-specific print driver is installed for this operating system as part of the software installation.	

Mac OS

Direct printing using Apple's AirPrint is supported for iOS and from Mac computers running OS X 10.7 Lion and newer. Use AirPrint to print directly to the printer from an iPad, iPhone (3GS or later), or iPod touch (third generation or later) in the mobile applications (Mail, Photos, Safari, iBooks, Select third-party applications)



- The USB-only models without wired or Wi-Fi network functionality do not support Mac OS.
 - To use AirPrint, the printer must be connected to the same network (sub-net) as the Apple device.
 - Before using AirPrint with a USB connection, verify the version number. AirPrint versions 1.3 and earlier do not support USB connections.
-

Glossary



The following glossary helps you get familiar with the product by understanding the terminologies commonly used with printing as well as mentioned in this user's guide.

802.11

802.11 is a set of standards for wireless local area network (WLAN) communication, developed by the IEEE LAN/MAN Standards Committee (IEEE 802).

802.11b/g/n

802.11b/g/n can share same hardware and use the 2.4 GHz band. 802.11b supports bandwidth up to 11 Mbps, 802.11n supports bandwidth up to 150 Mbps. 802.11b/g/n devices may occasionally suffer interference from microwave ovens, cordless telephones, and Bluetooth devices.

Access point

Access Point or Wireless Access Point (AP or WAP) is a device that connects wireless communication devices together on wireless local area networks (WLAN), and acts as a central transmitter and receiver of WLAN radio signals.

ADF

An Automatic Document Feeder (ADF) is a scanning unit that will automatically feed an original sheet of paper so that the machine can scan some amount of the paper at once.

AppleTalk

AppleTalk is a proprietary suite of protocols developed by Apple, Inc for computer networking. It was included in the original Mac (1984) and is now deprecated by Apple in favor of TCP/IP networking.

BIT Depth

A computer graphics term describing the number of bits used to represent the color of a single pixel in a bitmapped image. Higher color depth gives a broader range of distinct colors. As the number of bits increases, the number of possible colors becomes impractically large for a color map. 1-bit color is commonly called as monochrome or black and white.

BMP

A bitmapped graphics format used internally by the Microsoft Windows graphics subsystem (GDI), and used commonly as a simple graphics file format on that platform.

BOOTP

Bootstrap Protocol. A network protocol used by a network client to obtain its IP address automatically. This is usually done in the bootstrap process of computers or operating systems running on them. The BOOTP servers assign the IP address from a pool of addresses to each client. BOOTP enables 'diskless workstation' computers to obtain an IP address prior to loading any advanced operating system.

CCD

Charge Coupled Device (CCD) is a hardware which enables the scan job. CCD Locking mechanism is also used to hold the CCD module to prevent any damage when you move the machine.

Collation

Collation is a process of printing a multiple-copy job in sets. When collation is selected, the device prints an entire set before printing additional copies.

Control Panel

A control panel is a flat, typically vertical, area where control or monitoring instruments are displayed. They are typically found in front of the machine.

Coverage

It is the printing term used for a toner usage measurement on printing. For example, 5% coverage means that an A4 sided paper has about 5% image or text on it. So, if the paper or original has complicated images or lots of text on it, the coverage will be higher and at the same time, a toner usage will be as much as the coverage.

CSV

Comma Separated Values (CSV). A type of file format, CSV is used to exchange data between disparate applications. The file format, as it is used in Microsoft Excel, has become a de facto standard throughout the industry, even among non-Microsoft platforms.

DADF

A Duplex Automatic Document Feeder (DADF) is a scanning unit that will automatically feed and turn over an original sheet of paper so that the machine can scan on both sides of the paper.

Default

The value or setting that is in effect when taking a printer out of its box state, reset, or initialized.

DHCP

A Dynamic Host Configuration Protocol (DHCP) is a client-server networking protocol. A DHCP server provides configuration parameters specific to the DHCP client host requesting, generally, information required by the client host to participate on an IP network. DHCP also provides a mechanism for allocation of IP addresses to client hosts.

DIMM

Dual Inline Memory Module (DIMM), a small circuit board that holds memory. DIMM stores all the data within the machine like printing data, received fax data.

DLNA

The Digital Living Network Alliance (DLNA) is a standard that allows devices on a home network to share information with each other across the network.

DNS

The Domain Name Server (DNS) is a system that stores information associated with domain names in a distributed database on networks, such as the Internet.

Dot Matrix Printer

A dot matrix printer refers to a type of computer printer with a print head that runs back and forth on the page and prints by impact, striking an ink-soaked cloth ribbon against the paper, much like a typewriter.

DPI

Dots Per Inch (DPI) is a measurement of resolution that is used for scanning and printing. Generally, higher DPI results in a higher resolution, more visible detail in the image, and a larger file size.

DRPD

Distinctive Ring Pattern Detection. Distinctive Ring is a telephone company service which enables a user to use a single telephone line to answer several different telephone numbers.

Duplex

A mechanism that will turn over a sheet of paper so that the machine can print (or scan) on both sides of the paper. A printer equipped with a Duplex Unit can print on both sides of paper during one print cycle.

Duty Cycle

Duty cycle is the page quantity which does not affect printer performance for a month. Generally the printer has the lifespan limitation such as pages per year. The lifespan means the average capacity of print-outs, usually within the warranty period. For example, if the duty cycle is 48,000 pages per month assuming 20 working days, a printer limits 2,400 pages a day.

ECM

Error Correction Mode (ECM) is an optional transmission mode built into Class 1 fax machines or fax modems. It automatically detects and corrects errors in the fax transmission process that are sometimes caused by telephone line noise.

Emulation

Emulation is a technique of one machine obtaining the same results as another. An emulator duplicates the functions of one system with a different system, so that the second system behaves like the first system. Emulation focuses on exact reproduction of external behavior, which is in contrast to

simulation, which concerns an abstract model of the system being simulated, often considering its internal state.

Ethernet

Ethernet is a frame-based computer networking technology for local area networks (LANs). It defines wiring and signaling for the physical layer, and frame formats and protocols for the media access control (MAC)/data link layer of the OSI model. Ethernet is mostly standardized as IEEE 802.3. It has become the most widespread LAN technology in use during the 1990s to the present.

EtherTalk

A suite of protocols developed by Apple Computer for computer networking. It was included in the original Mac (1984) and is now deprecated by Apple in favor of TCP/IP networking.

FDI

Foreign Device Interface (FDI) is a card installed inside the machine to allow a third party device such as a coin operated device or a card reader. Those devices allow the pay-for-print service on your machine.

FTP

A File Transfer Protocol (FTP) is a commonly used protocol for exchanging files over any network that supports the TCP/IP protocol (such as the Internet or an intranet).

Fuser Unit

The part of a laser printer that fuses the toner onto the print media. It consists of a heat roller and a pressure roller. After toner is transferred onto the paper, the fuser unit applies heat and pressure to ensure that the toner stays on the paper permanently, which is why paper is warm when it comes out of a laser printer.

Gateway

A connection between computer networks, or between a computer network and a telephone line. It is very popular, as it is a computer or a network that allows access to another computer or network.

Grayscale

A shade of gray that represents light and dark portions of an image when color images are converted to grayscale; colors are represented by various shades of gray.

Halftone

An image type that simulates grayscale by varying the number of dots. Highly colored areas consist of a large number of dots, while lighter areas consist of a smaller number of dots.

Mass storage device (HDD)

Mass storage device (HDD), commonly referred to as a hard drive or hard disk, is a non-volatile storage device which stores digitally-encoded data on rapidly rotating platters with magnetic surfaces.

IEEE

The Institute of Electrical and Electronics Engineers (IEEE) is an international non-profit, professional organization for the advancement of technology related to electricity.

IEEE 1284

The 1284 parallel port standard was developed by the Institute of Electrical and Electronics Engineers (IEEE). The term "1284-B" refers to a specific connector type on the end of the parallel cable that attaches to the peripheral (for example, a printer).

Intranet

A private network that uses Internet Protocols, network connectivity, and possibly the public telecommunication system to securely share part of an organization's information or operations with its employees. Sometimes the term refers only to the most visible service, the internal website.

IP address

An Internet Protocol (IP) address is a unique number that devices use in order to identify and communicate with each other on a network utilizing the Internet Protocol standard.

IPM

The Images Per Minute (IPM) is a way of measuring the speed of a printer. An IPM rate indicates the number of single-sided sheets a printer can complete within one minute.

IPP

The Internet Printing Protocol (IPP) defines a standard protocol for printing as well as managing print jobs, media size, resolution, and so forth. IPP can be used locally or over the Internet to hundreds of printers, and also supports access control, authentication, and encryption, making it a much more capable and secure printing solution than older ones.

IPX/SPX

IPX/SPX stands for Internet Packet Exchange/Sequenced Packet Exchange. It is a networking protocol used by the Novell NetWare operating systems. IPX and SPX both provide connection services similar to TCP/IP, with the IPX protocol having similarities to IP, and SPX having similarities to TCP. IPX/SPX was primarily designed for local area networks (LANs), and is a very efficient protocol for this purpose (typically its performance exceeds that of TCP/IP on a LAN).

ISO

The International Organization for Standardization (ISO) is an international standard-setting body composed of representatives from national standards bodies. It produces world-wide industrial and commercial standards.

ITU-T

The International Telecommunication Union is an international organization established to standardize and regulate international radio and telecommunications. Its main tasks include standardization, allocation of the radio spectrum, and organizing interconnection arrangements between different countries to allow international phone calls. A -T out of ITU-T indicates telecommunication.

ITU-T No. 1 chart

Standardized test chart published by ITU-T for document facsimile transmissions.

JBIG

Joint Bi-level Image Experts Group (JBIG) is an image compression standard with no loss of accuracy or quality, which was designed for compression of binary images, particularly for faxes, but can also be used on other images.

JPEG

Joint Photographic Experts Group (JPEG) is a most commonly used standard method of lossy compression for photographic images. It is the format used for storing and transmitting photographs on the World Wide Web.

LDAP

The Lightweight Directory Access Protocol (LDAP) is a networking protocol for querying and modifying directory services running over TCP/IP.

LED

A Light-Emitting Diode (LED) is a semiconductor device that indicates the status of a machine.

MAC address

Media Access Control (MAC) address is a unique identifier associated with a network adapter. MAC address is a unique 48-bit identifier usually written as 12 hexadecimal characters grouped in pairs (e. g., 00-00-0c-34-11-4e). This address is usually hard-coded into a Network Interface Card (NIC) by its manufacturer, and used as an aid for routers trying to locate machines on large networks.

MFP

Multi Function Peripheral (MFP) is an office machine that includes the following functionality in one physical body, so as to have a printer, a copier, a fax, a scanner and etc.

MH

Modified Huffman (MH) is a compression method for decreasing the amount of data that needs to be transmitted between the fax machines to transfer the image recommended by ITU-T T.4. MH is a codebook-based run-length encoding scheme optimized to efficiently compress white space. As most faxes consist mostly of white space, this minimizes the transmission time of most faxes.

MMR

Modified Modified READ (MMR) is a compression method recommended by ITU-T T.6.

Modem

A device that modulates a carrier signal to encode digital information, and also demodulates such a carrier signal to decode transmitted information.

MR

Modified Read (MR) is a compression method recommended by ITU-T T.4. MR encodes the first scanned line using MH. The next line is compared to the first, the differences determined, and then the differences are encoded and transmitted.

NetWare

A network operating system developed by Novell, Inc. It initially used cooperative multitasking to run various services on a PC, and the network protocols were based on the archetypal Xerox XNS stack. Today NetWare supports TCP/IP as well as IPX/SPX.

OPC

Organic Photo Conductor (OPC) is a mechanism that makes a virtual image for print using a laser beam emitted from a laser printer, and it is usually green or rust colored and has a cylinder shape.

An imaging unit containing a drum slowly wears the drum surface by its usage in the printer, and it should be replaced appropriately since it gets worn from contact with the cartridge development brush, cleaning mechanism, and paper.

Originals

The first example of something, such as a document, photograph or text, etc, which is copied, reproduced or translated to produce others, but which is not itself copied or derived from something else.

OSI

Open Systems Interconnection (OSI) is a model developed by the International Organization for Standardization (ISO) for communications. OSI offers a standard, modular approach to network design that divides the required set of complex functions into manageable, self-contained, functional layers. The layers are, from top to bottom, Application, Presentation, Session, Transport, Network, Data Link and Physical.

PABX

A private automatic branch exchange (PABX) is an automatic telephone switching system within a private enterprise.

PCL

Printer Command Language (PCL) is a Page Description Language (PDL) developed by HP as a printer protocol and has become an industry standard. Originally developed for early inkjet printers, PCL has been released in varying levels for thermal, dot matrix printer, and laser printers.

PDF

Portable Document Format (PDF) is a proprietary file format developed by Adobe Systems for representing two dimensional documents in a device independent and resolution independent format.

PostScript

PostScript (PS) is a page description language and programming language used primarily in the electronic and desktop publishing areas. - that is run in an interpreter to generate an image.

Printer Driver

A program used to send commands and transfer data from the computer to the printer.

Print Media

The media like paper, labels, and transparencies which can be used in a printer, a scanner, a fax or, a copier.

PPM

Pages Per Minute (PPM) is a method of measurement for determining how fast a printer works, meaning the number of pages a printer can produce in one minute.

PRN file

An interface for a device driver, this allows software to interact with the device driver using standard input/output system calls, which simplifies many tasks.

Protocol

A convention or standard that controls or enables the connection, communication, and data transfer between two computing endpoints.

PS

See PostScript.

PSTN

The Public-Switched Telephone Network (PSTN) is the network of the world's public circuit-switched telephone networks which, on industrial premises, is usually routed through the switchboard.

RADIUS

Remote Authentication Dial In User Service (RADIUS) is a protocol for remote user authentication and accounting. RADIUS enables centralized management of authentication data such as usernames and passwords using an AAA (authentication, authorization, and accounting) concept to manage network access.

Resolution

The sharpness of an image, measured in Dots Per Inch (DPI). The higher the dpi, the greater the resolution.

SMB

Server Message Block (SMB) is a network protocol mainly applied to share files, printers, serial ports, and miscellaneous communications between nodes on a network. It also provides an authenticated Inter-process communication mechanism.

SMTP

Simple Mail Transfer Protocol (SMTP) is the standard for e-mail transmissions across the Internet. SMTP is a relatively simple, text-based protocol, where one or more recipients of a message are specified, and then the

message text is transferred. It is a client-server protocol, where the client transmits an email message to the server.

SSID

Service Set Identifier (SSID) is a name of a wireless local area network (WLAN). All wireless devices in a WLAN use the same SSID in order to communicate with each other. The SSIDs are case-sensitive and have a maximum length of 32 characters.

Subnet Mask

The subnet mask is used in conjunction with the network address to determine which part of the address is the network address and which part is the host address.

TCP/IP

The Transmission Control Protocol (TCP) and the Internet Protocol (IP); the set of communications protocols that implement the protocol stack on which the Internet and most commercial networks run.

TCR

Transmission Confirmation Report (TCR) provides details of each transmission such as job status, transmission result and number of pages sent. This report can be set to print after each job or only after failed transmissions.

TIFF

Tagged Image File Format (TIFF) is a variable-resolution bitmapped image format. TIFF describes image data that typically come from scanners. TIFF images make use of tags, keywords defining the characteristics of the image that is included in the file. This flexible and platform-independent format can be used for pictures that have been made by various image processing applications.

Toner Cartridge

A kind of bottle or container used in a machine like a printer which contains toner. Toner is a powder used in laser printers and photocopiers, which forms the text and images on the printed paper. Toner can be fused by a combination of heat/pressure from the fuser, causing it to bind to the fibers in the paper.

TWAIN

An industry standard for scanners and software. By using a TWAIN-compliant scanner with a TWAIN-compliant program, a scan can be initiated from within the program. It is an image capture API for Microsoft Windows and Apple Mac operating systems.

UNC Path

Uniform Naming Convention (UNC) is a standard way to access network shares in Window NT and other Microsoft products. The format of a UNC path is: \\<servername>\<sharename>\<Additional directory>

URL

Uniform Resource Locator (URL) is the global address of documents and resources on the Internet. The first part of the address indicates what protocol to use, the second part specifies the IP address or the domain name where the resource is located.

USB

Universal Serial Bus (USB) is a standard that was developed by the USB Implementers Forum, Inc., to connect computers and peripherals. Unlike the parallel port, USB is designed to concurrently connect a single computer USB port to multiple peripherals.

Watermark

A watermark is a recognizable image or pattern in paper that appears lighter when viewed by transmitted light. Watermarks were first introduced in Bologna, Italy in 1282; they have been used by papermakers to identify their product, and also on postage stamps, currency, and other government documents to discourage counterfeiting.

WEP

Wired Equivalent Privacy (WEP) is a security protocol specified in IEEE 802.11 to provide the same level of security as that of a wired LAN. WEP provides security by encrypting data over radio so that it is protected as it is transmitted from one end point to another.

WIA

Windows Imaging Architecture (WIA) is an imaging architecture that is originally introduced in Windows Me and Windows XP Service Pack 3. A scan can be initiated from within these operating systems by using a WIA-compliant scanner.

WPA

Wi-Fi Protected Access (WPA) is a class of systems to secure wireless (Wi-Fi) computer networks, which was created to improve upon the security features of WEP.

WPA-PSK

WPA-PSK (WPA Pre-Shared Key) is special mode of WPA for small business or home users. A shared key, or password, is configured in the wireless access point (WAP) and any wireless laptop or desktop devices. WPA-PSK generates a unique key for each session between a wireless client and the associated WAP for more advanced security.

WPS

The Wi-Fi Protected Setup (WPS) is a standard for establishing a wireless home network. If your wireless access point supports WPS, you can configure the wireless network connection easily without a computer.

XPS

XML Paper Specification (XPS) is a specification for a Page Description Language (PDL) and a new document format, which has benefits for portable document and electronic document, developed by Microsoft. It is an XML-based specification, based on a new print path and a vector-based device-independent document format.

Index

A

address book	
editing	116
group editing	117
group registering	116
registering	115
using	115
address book setup	115

B

buttons	
contrast	25
id copy	25
numeric keypad	26
scan	24
wps	25

C

cleaning	
inside	150
outside	149
scan unit	152
cleaning a machine	149
control panel	24
convention	12
copy	
general setup	121
copying	
basic copying	87
reducing or enlarging copies	89

D

default settings	
tray setting	48
driver installation	28

E

easy document creator	94
entering character	36
error message	165

F

favorites settings, for printing	77
fax	
automatic redialing	104
canceling a reserved fax job	106
changing the receive modes	107
delaying a fax transmission	105
forwarding a received fax to another destination	112
forwarding a sent fax to another destination	111
general setup	124
receiving faxes in memory	110
receiving in Answering Machine mode	108
receiving in DRPD mode	108
receiving in Fax mode	108
receiving in secure mode	109
receiving in Tel mode	108
receiving with ext. telephone	108
redialing the last number	104
sending a fax in the computer	101

fax sending	
multi sending	103
faxing	
adjusting darkness	113
adjusting resolution	113
preparing to fax	100
receiving in Fax mode	107
features	7
machine features	119
print media feature	192
front view	21

G

general icons	12
general settings	128
glossary	196

H

HP Embedded Web Server	66
general information	66

I

id copy	90
information	
HP Smart app	69
installation	
HP Smart app	69

J

jam	
clearing original document	156, 159
tips for avoiding paper jams	155

L

LCD display	
browsing the machine status	121, 123, 124, 130
Linux	
driver installation	28
loading	
paper in the tray1	41
special media	45
loading originals	51

M

Mac	
driver installation	28
machine information	121, 123, 124, 130
machine setup	
machine status	121, 123, 124, 130
maintenance parts	139
menu overview	30
multi-purpose tray	
using special media	45

N

network	
driver installation	
Windows	57
general setup	133
IPv6 configuration	55
wired network setup	55
wireless network setup	58

O

output support	50
overlay printing	

create	82
delete	83
print	83
P	
<hr/>	
placing a machine	
adjusting the altitude	37
preparing originals type	50
print	
HP Smart app	69
supplies information	164
print media	
guidelines	38
labels	46
output support	192
preprinted paper	48
setting the paper size	48
setting the paper type	48
special media	45
X-Hvy 121-163	47
Printer Status	84
printer status	
general information	84
printing	
printing a document	
Windows	74
special printer features	79
printing feature	79
problem	
operating system problems	185
problems	
copying problems	182
faxing problems	184
paper feeding problems	172
power problems	173
printing problems	174
printing quality problems	177
scanning problems	183

R	
<hr/>	
rear view	23
reports	
machine information	121, 124, 125, 126, 128, 130, 131
resolution	
faxing	113
S	
<hr/>	
safety	
information	13
symbols	13
Scanning	
Scanning with MFP Scan	94
scanning	
basic information	93
Scanning from image editing program	95
Scanning from network connected machine	97
Scanning using the WIA driver	96
Smart app	69
specifications	191
print media	192
status	24, 25
supplies	
available supplies	137
estimated toner cartridge life	141
monitoring the supplies life	147
ordering	137
replacing toner cartridge	143
supplies information	164
T	
<hr/>	
toner cartridge	
estimated life	141

handling instructions	140
redistributing toner	142
replacing the cartridge	143
storing	140
tray	
adjusting the width and length	40
changing the tray size	40
setting the paper size and type	48
troubleshooting	
wireless	187

U

understanding the status LED	162
using help	78

W

watermark	
create	81
delete	82
edit	81
Windows	
common Windows problems	185
driver installation	28
driver installation for network connected	57
system requirements	194
wireless	
USB cable	62
wireless network	
network cable	62

Free Manuals Download Website

<http://myh66.com>

<http://usermanuals.us>

<http://www.somanuals.com>

<http://www.4manuals.cc>

<http://www.manual-lib.com>

<http://www.404manual.com>

<http://www.luxmanual.com>

<http://aubethermostatmanual.com>

Golf course search by state

<http://golfingnear.com>

Email search by domain

<http://emailbydomain.com>

Auto manuals search

<http://auto.somanuals.com>

TV manuals search

<http://tv.somanuals.com>