

HP DeskJet 640C Series (USB) Printer User's Guide for Macintosh

English





HP Customer Care

Thank you for buying an HP DeskJet printer. Because HP wants owning your printer to be a trouble-free experience, we back your purchase with **HP Customer Care**—award-winning service and support that includes:



HP Customer Care Online

Click your way to a quick solution! **HP Customer Care Online** is a great place to start for answers to questions about your HP DeskJet printer — 24 hours a day, seven days a week.

If you have a modem connected to your computer and subscribe to an online service, or have direct access to the Internet, you can obtain a wide variety of information about your printer at the following web sites:

English:	http://www.hp.com/support/home_products
French:	http://www.hp.com/cposupport/fr/
German:	http://www.hp.com/cposupport/de
Japanese:	http://www.jpn.hp.com/CPO_TC/eschome.htm
Portuguese:	http://www.hp.com/cposupport/pt
Spanish:	http://www.hp.com/cposupport/es/

From **HP Customer Care Online** you can link to **HP Customer Care User Forums** and **HP Customer Care Email**.



HP Customer Care User Forums

Go online, anytime, and you will also find helpful user forums—a great source of ideas and suggestions for using your HP DeskJet printer. You can access the user forums directly from http://www.hp.com/support/home_products.



HP Customer Care by Phone

Call us direct and connect with a service technician who specializes in your product and who can typically answer your questions in one phone call. See page 43 in this *User's Guide* for phone numbers.

Acknowledgments

Apple, the Apple logo, AppleTalk, ColorSync, the ColorSync logo, Finder, Mac, Macintosh, Mac OS, PowerBook, Power Macintosh, and QuickDraw are trademarks of Apple Computer, Inc., registered in the U.S. and other countries.

Notice

The information contained in this document is subject to change without notice.

Hewlett-Packard Company makes no warranty of any kind with regard to this material, including, but not limited to, the implied warranties of merchantability and fitness for a particular purpose.

Hewlett-Packard shall not be liable for any errors or for incidental or consequential damages in connection with the furnishing, performance, or use of this material.

All rights reserved. Reproduction, adaptation, or translation of this manual is prohibited without prior written permission of Hewlett-Packard Company, except as allowed under the copyright laws.

No part of this document may be photocopied, reproduced, or translated to another language without the prior written consent of Hewlett-Packard Company.

Edition 1, January 2000

© Copyright Hewlett-Packard Company and Apple Computer, Inc. 2000

Portions © Copyright 1989-2000 Palomar Software, Inc. HP DeskJet 640C Series Printers include printer driver technology licensed from Palomar Software, Inc., www.palomar.com.

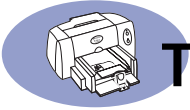

Table of Contents

Chapter 1	Using Your Printer	
	Buttons and Lights	1
	Using the Paper Trays	2
	Basic Printer Maintenance	4
Chapter 2	Using Your Printer Software	
	Choosing Your Printer	5
	Other Ways to Select a Default Printer	5
	Desktop Printing	6
	Checking Printer Status	6
	Page Setup - Controlling Page Layout	7
	Print Dialog Box	8
	Printing on Different Types of Paper and Media	14
	HP DeskJet Utility Window	25
Chapter 3	Using and Caring for Your Print Cartridges	
	Replacing Print Cartridges	27
	Storing Print Cartridges	29
	Cleaning Print Cartridges	29
	Damage Resulting from Refilling the Print Cartridges	32
Chapter 4	Getting Help When Things Go Wrong	
	Troubleshooting Tips	33
	HP Customer Care	42
Chapter 5	Supplies and Accessories	
	Printer Supplies	45
	Printer Quick Start Posters and User's Guide for Macintosh	45
	Paper and Other Media	46
	Ordering Information	47



Table of Contents

Appendix A	Setup Instructions	49
Appendix B	Specifications	52
Appendix C	Legal Information	55
Index	57

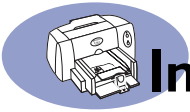

Introduction

Thank You For Buying an HP DeskJet Printer!

Here's what comes in the box. If something is missing, talk to your HP dealer or call HP Customer Care. (See "HP Customer Care by Phone" on page 43 for the appropriate telephone number.)

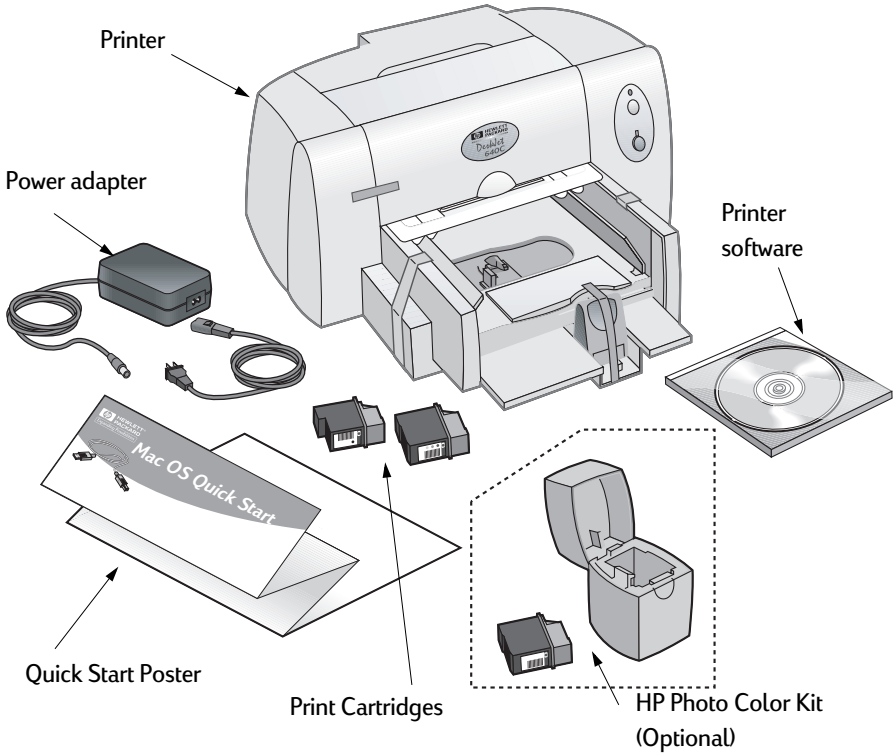

Note: You will need to buy an A-to-B type USB-to-USB printer cable to connect your HP DeskJet printer to your computer. See page 47 for ordering information.



Introduction

Special Features of Your HP DeskJet Printer

Your new HP DeskJet printer is equipped with special features:

- Stunning photo quality through HP's ColorSmart III Technology
- Excellent print quality on plain paper
- Uncompromising performance with print speeds of up to 6 pages per minute for black text and 3 pages per minute for text with color graphics with the HP DeskJet 640C Series printers
- Brilliant photo image printing
- Large capacity paper tray that holds up to 100 sheets

Finding More Information

This *User's Guide* shows you how to operate your printer. For more information:

- Use the *Quick Start Poster* for installation.
- Turn on balloon help in the **Help** menu. Move your cursor over any print setting to view an explanation.
- Visit the HP web site at http://www.hp.com/support/home_products for the latest product information, troubleshooting, and printer software updates.













1 Using Your Printer

Buttons and Lights

The two buttons on the front of your HP DeskJet printer let you turn the printer on and off, or to resume printing. The lights give you visual cues about the state of your printer.

Warning

Only use the Power Button on the front of the printer to turn the printer on and off. Using a power strip, surge protector, or a wall-mounted switch to turn the printer on and off may cause premature printer failure.

When these lights are...	You need to...
 Turned off and  turned off	Press Power to turn on the printer.
 Steadily lit and  turned off	Send a document to the printer. The printer is in the ready-to-print state.
 Steadily lit and  flashing	<ul style="list-style-type: none">• If you just installed a print cartridge, make sure the cartridge is securely snapped into the printer with the arrow aligned with the dots on the top of the print cartridge cradle.• Close the top cover of the printer if it is open.• Check the lower IN tray to make sure it contains paper and that the paper is correctly loaded in the tray.• Press Resume to clear the error condition. Then check your computer screen for any reported error message and corrective action instructions.
 Flashing and  turned off	No action required. This indicates that either the computer is sending a document to the printer or that the printer is currently busy printing.
 Flashing and  flashing	Press Power to turn off the printer. At the computer, cancel any documents awaiting printing. Press Power again to turn on the printer.
 Steadily lit and  steadily lit	See the troubleshooting instructions in Chapter 4 of this User's Guide. A problem exists with the printer.

Using the Paper Trays

Standard-Size Media

You place the paper or other media on which you will print into the lower IN tray. Slide out the paper guides to make room for the media you are loading into the tray.

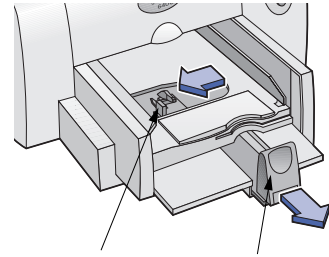

Width paper guide Length paper guide

Once you insert the media, slide the paper guides so they rest snugly against the media. Be sure to slide all media as far as it will go into the IN tray. Make sure the paper lies flat in the tray.

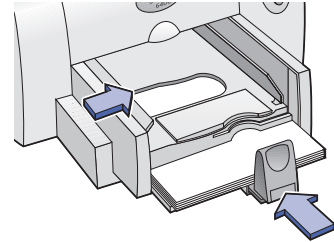

Cards, Small Envelopes, and Small Photo Paper

When printing on cards, small envelopes, or small photo paper, after sliding out the paper guides, next remove the OUT tray, then flip up the card guide.

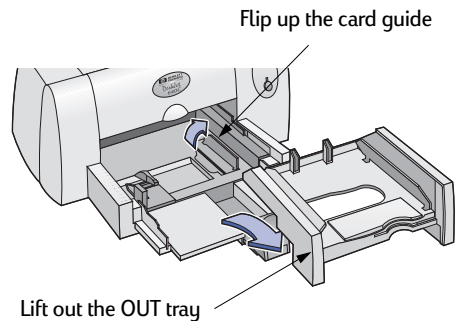

Flip up the card guide

Lift out the OUT tray

Using Your Printer

Insert the cards, small envelopes, or small photo paper into the IN tray with the right edge of the media stack aligned with the card guide. For small envelopes, make sure the flap side is on the right with the flap facing up. Slide the paper width guide to the right until it aligns with the left edge of the media stack. Press the inside of the paper length guide handle to release and lower it. Then push the paper length guide in toward the media stack until it stops.

Replace the OUT tray. If you encounter difficulty replacing the OUT tray, lift the top cover, wait a few moments for the print cartridge cradle to move to its center position, replace the OUT tray, then lower the top cover.

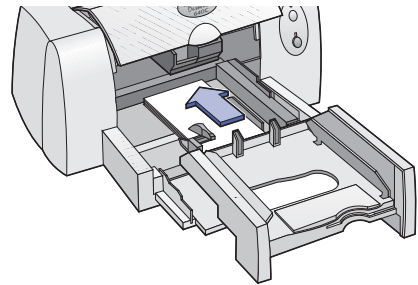
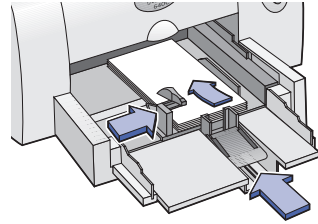
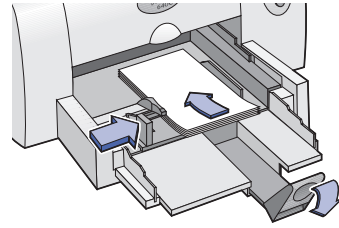

Basic Printer Maintenance

Because the printer ejects ink onto the paper in a fine mist, ink smudges will eventually appear on the printer case. To remove smudges, stains, and/or dried ink from the exterior of the printer, use a soft cloth moistened with water.

When cleaning your printer, keep these tips in mind:

- **Do not** clean the interior of the printer. Keep all fluids away from the interior.
- **Do not** use household cleaners or detergent. In the event that a household cleaner or detergent is used on the printer, wipe the printer's exterior surfaces with a soft cloth moistened with water.
- **Do not** lubricate the rod on which the print cartridge cradle moves. Noise is normal when the cradles move back and forth.

For information on cleaning print cartridges and the print cartridge cradle, see "Cleaning Print Cartridges" on page 29.

2 Using Your Printer Software

Note: Before you can use your printer, you must have installed the printer and printer software as described on the *Quick Start Poster*.

Choosing Your Printer

If you haven't already selected your **HP DeskJet** as the default printer in the **Chooser**, you should do so now. To select your printer using a USB connection:

- 1 Make sure the computer and printer are turned on, and your printer is connected to your computer with a USB cable.
- 2 From the **Apple** menu, select **Chooser**.
- 3 In the left side of the Chooser window, click the **DeskJet 640 Series (USB)** icon.
- 4 In the right side of the Chooser window, click **DeskJet 640C**.
- 5 Close the **Chooser**.

Other Ways to Select a Default Printer

Besides using the Chooser, you can also select a default printer in the following ways:

- Select the desired printer by clicking on the menu bar **printer icon** at the top of the screen, and choosing **DeskJet 640C**.
- If your control strip is on, then select the desired printer by clicking the **printer icon** in the control strip, and choosing **DeskJet 640C**.
- Drag the document you want to print to the desktop icon of the printer you want to use.
- Click the icon of the **HP DeskJet printer** you want to use, and choose **Set Default Printer** from the **Printing** menu.

The Print command will send your documents to this printer until you select a new default printer. If you switch printers, check your document before you print it to see whether the formatting or pagination changed.

Desktop Printing

Desktop printing is useful when you have a number of documents to print at once, or when you have a document that is already formatted for printing on a particular printer. There are two methods to print documents from the desktop. To perform desktop printing, either:

- Drag the icons of the documents you want to print to the desktop icon of the printer you want to use.







OR

- Select the icons of the documents you want to print, then choose **Print** from the **File** menu. When the **Print** dialog box appears, select your print options, then click the **Print** button.

Desktop printing is not supported in Mac OS version 8.5.1 or older.

Checking Printer Status

You can tell the status of a printer by looking at its desktop icon:

Icon	Description	Icon	Description
 DESKJET 640C	Idle printer (default)	 DESKJET 640C	Printing stopped on default printer
 DESKJET 640C	Idle printer (not default)	 DESKJET 640C	Error on default printer
 DESKJET 640C	Printing on default printer	 DESKJET 640C	Printer not available or connected

Page Setup - Controlling Page Layout

You choose settings such as paper size, scaling, and page orientation from the **HP DeskJet Page Setup** dialog box. To get to this dialog box:

- 1 Open the software program used to create your document.
- 2 From the **File** menu, select **Page Setup**.

Paper Size, Scaling, and Page Orientation

Make sure you correctly choose the size of paper, envelopes, or other media you have in the IN tray.

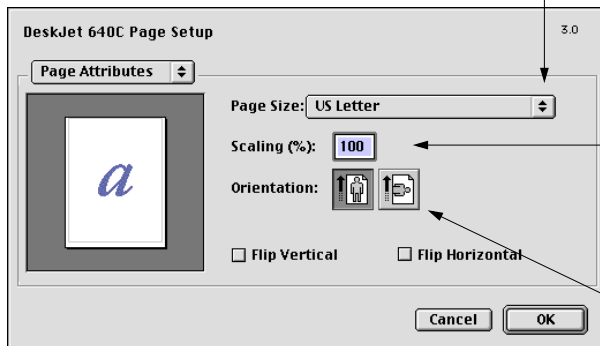

Enter a number from 20 to 400. Numbers smaller than 100 reduce the image size, and numbers greater than 100 enlarge it. Changing size may change pagination.

Click the appropriate icon to choose page orientation.

Print Dialog Box

You choose settings such as number of copies, all or specific pages to print, paper type, print quality, page layout, color, and background printing from the **HP DeskJet Print** dialog box. To get to this dialog box, select **Print** from your software program's **File** menu.

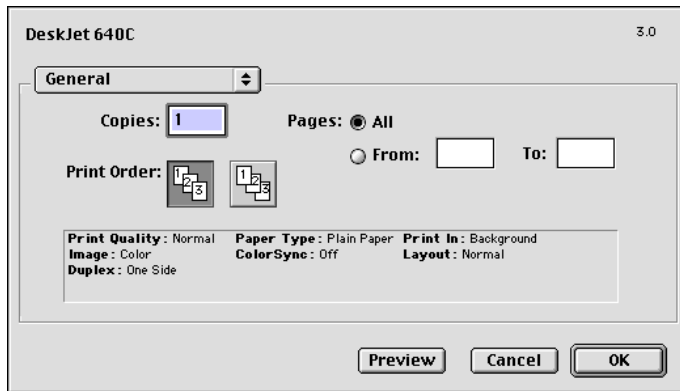

Buttons

There are three buttons at the bottom of every Print dialog box:

- **Preview** allows you to view your document before you print it so you can see how the document will print with the current settings.
- **Cancel** cancels settings you have entered and closes the Print dialog box.
- **OK** starts printing.

General

General is the default panel selected in the Print dialog box menu. This panel lets you select the number of copies you want to print, whether you want to print the entire document or select pages, and whether you want to print from the front of your document or begin printing from the end forward.

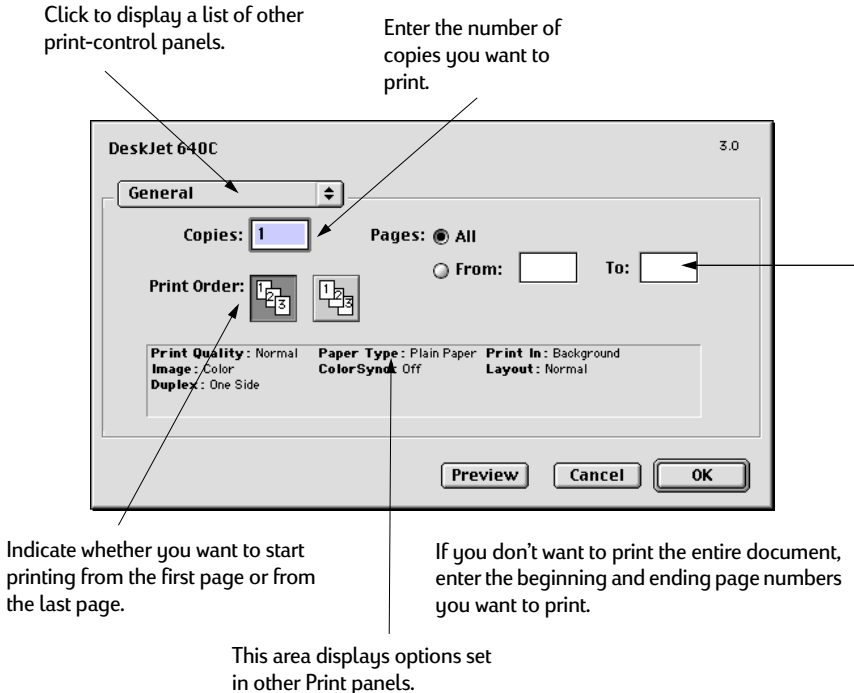

You may also choose the following options from the **General** menu:

- **Paper Type/Quality** (see “Paper Type/Quality” on page 10)
- **Layout** (see “Layout” on page 10)
- **Color** (see “Color” on page 11)
- **Background Printing** (see “Background Printing” on page 12)

Paper Type/Quality

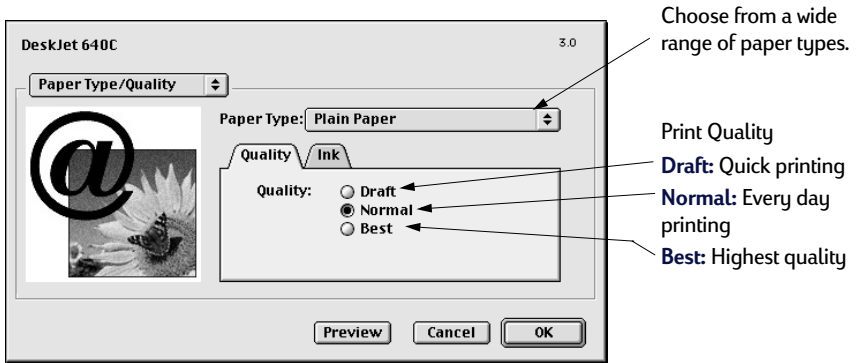

- **Ink** tab settings allow you to adjust the ink volume and dry time.

Layout

This dialog box allows you to specify the number of pages printed on each sheet of paper. You also set **Two-Sided Printing** options from this dialog box.

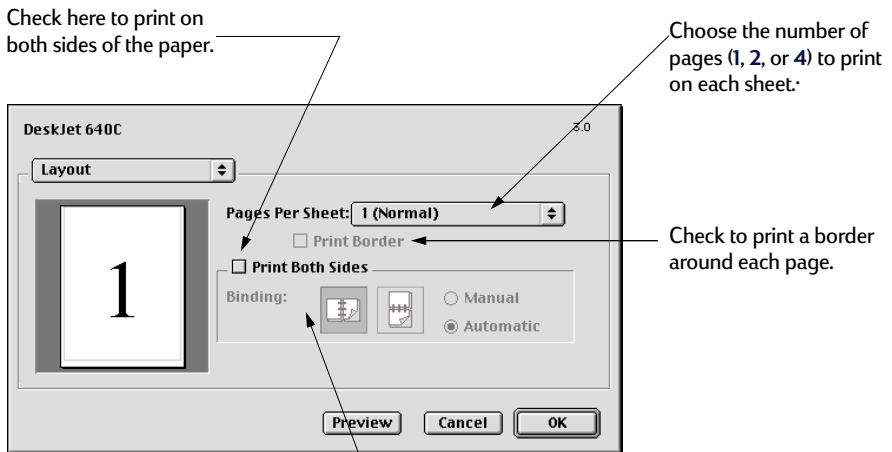

If you check **Print Both Sides**, choose appropriate **Binding** (side or top).

Color

Your HP DeskJet 640C Series Printer uses HP's Color Matching technology to intelligently analyze each element on a page—text, graphics, and photographs—and provide the best color output.

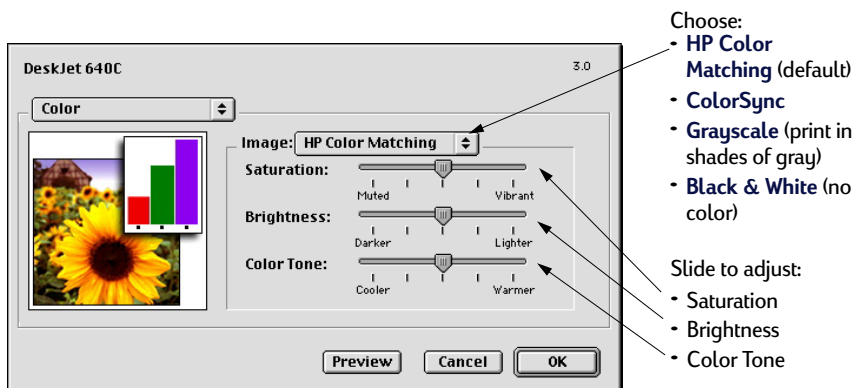

HP Color Matching is the default **Image** setting on the Color panel. While you can adjust saturation, brightness, and color tone with the sliders that appear when you choose this option, the center position of the sliders is optimized for most printing uses and types of media.

The **ColorSync** setting can be used for color matching with other components using the ColorSync matching system.

Grayscale prints in shades of gray. With this setting, you also have the option to optimize printing for fax and photocopy.

Black & White prints only in black and white (no color, no gray).

Background Printing

Choose **Background** if you want to continue working while printing takes place. If you choose **Foreground** printing, printing will be faster, but you won't be able to work on other tasks until the printing is complete.

Choose:

- **Background** to continue working while printing
- **Foreground** for faster printing

Click the button that matches the desired timing for your print job

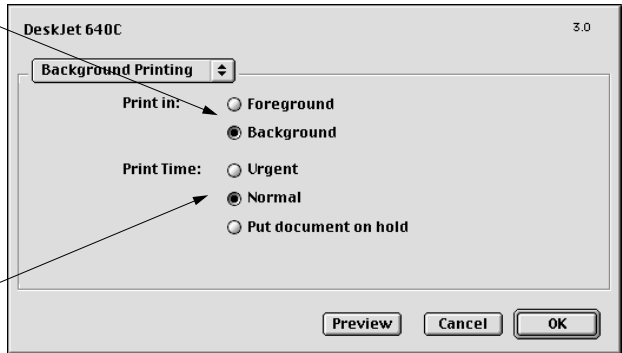

Using Your Printer Software

The following table describes additional features available when using background printing. To access these features from the desktop, double-click the **HP DeskJet 640C Series** printer icon.

Background Printing Options	Instructions
Delete a print job	<ul style="list-style-type: none"> • Select the job title or icon, then click the Trash icon. or • Drag the document's icon to the Trash on your desktop. <p>These methods delete only the print job, not the document itself.</p>
Hold/pause a print job	<ul style="list-style-type: none"> • Select the job title or icon, then click the Pause button. The print request will pause until you select its title again and click the Resume Button. or • Drag the document icon to the Waiting to Print list of documents.
Mark a print request "Urgent"	<ul style="list-style-type: none"> • Select the job title or icon, then click the small clock. • In the dialog box that appears, click Urgent. This moves the print request to the top of your print list.
Sort/change the order of print jobs	<ul style="list-style-type: none"> • From the View menu, choose the title of the column by which you want to sort or choose. • To see and change the print order, sort by Print Time. • Drag and drop the print job title to the desired place in the list.
Stop and restart printing	<ul style="list-style-type: none"> • Choose Stop Print Queue from the Printing menu. • To resume printing, choose Start Print Queue. <p>This is a good way to save print requests when using a portable computer while away from your printer.</p>
Change printers	<p>To move a print job from one printer to another printer of the same type:</p> <ul style="list-style-type: none"> • Drag the icon for the print request to the icon of the desired printer. <p>If you're not sure whether the two printers are of the same type, try moving the print request anyway; the printer software won't let you move a print request to an incompatible printer.</p>

Printing on Different Types of Paper and Media

The HP DeskJet 640C Series printer is designed to print on so many different types of print media that it practically is a small print shop. This chapter explains how to use the different printing materials available to you.

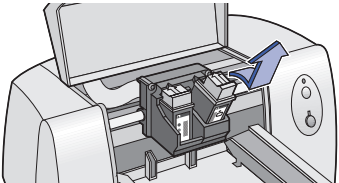
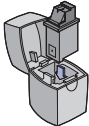
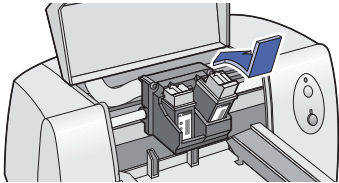
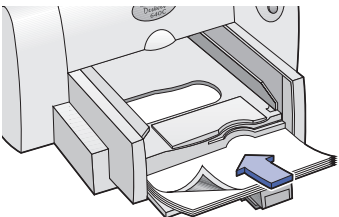

Printing Photographs

I want to print...	I should...
<p>Photo Paper</p>    	<ol style="list-style-type: none"> 1 Remove all paper from the IN tray. 2 With the printer turned on, open the top cover. The cartridge cradles move to an accessible position and the Resume light blinks. 3 Pull the top of the black print cartridge toward you until it pops loose. Lift it from its cradle. 4 Store the black print cartridge in the print cartridge storage container. 5 Place the photo cartridge into the now-empty cartridge cradle. Align the arrow on the print cartridge with the notch on the top of the cradle, and push the arrow toward the notch until the print cartridge snaps into place. You'll hear a click when the cartridge sits snugly in its cradle. 6 Close the printer's top cover. The cradles return to their home position on the right side of the printer and the Resume light stops blinking. 7 Slide out the paper guides. 8 Insert the photo paper into the IN Tray, glossy side down. 9 Slide the paper guides snugly against the sheets. 10 Choose the print settings that match the type and size of the photo paper. 11 Print the photos.

HP print settings to choose	Guidelines to remember
<p>Page Setup</p> <ul style="list-style-type: none"> - <i>Paper Size</i>: Choose appropriate paper size - <i>Orientation</i>: Choose appropriate orientation <p>Paper Type/Quality</p> <ul style="list-style-type: none"> - <i>Paper Type</i>: Choose photo paper type - <i>Print Quality</i>: Choose Best <p>Layout</p> <ul style="list-style-type: none"> - <i>Pages per Sheet</i>: 1 (Normal) - <i>Print Both Sides</i>: Unchecked 	<ul style="list-style-type: none"> • For best results, use: <ul style="list-style-type: none"> - HP Premium Photo Paper, - Glossy, or - HP Premium Photo Paper, Matte or Glossy. • The photo needs to be in electronic (digital) form, before you can print it. Take a digital picture, scan a photo, or have your local camera shop provide an electronic file of your photo. • After selecting your paper type, choose the appropriate paper size from the pull-down menu.

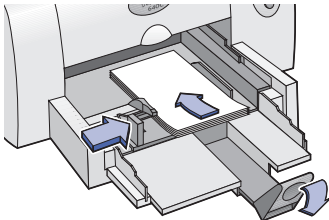
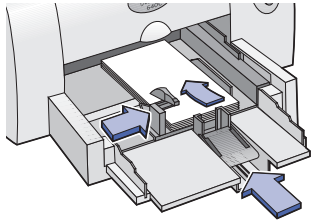

Printing Greeting Cards and Hagaki

I want to print...	I should...
 	<ol style="list-style-type: none"> 1 Remove the OUT tray as shown on page 2. 2 Slide out both of the paper guides and remove all paper from the IN tray. 3 Insert up to 30 cards into the IN tray as far as they will go. 4 Press inside the handle of the paper length guide to release and drop down the handle. 5 Slide both paper guides snugly against the edges of the cards. 6 Replace the OUT tray as shown on page 3. 7 Choose the print settings that match the type and size of the cards. 8 Print the cards.
HP print settings to choose	Guidelines to remember
<p>Page Setup</p> <ul style="list-style-type: none"> - <i>Paper Size</i>: Choose appropriate card size - <i>Orientation</i>: Choose Portrait icon <p>Paper Type/Quality</p> <ul style="list-style-type: none"> - <i>Paper Type</i>: Choose greeting card type or Plain Paper or Inkjet Paper for Hagaki - <i>Print Quality</i>: Choose Normal <p>Layout</p> <ul style="list-style-type: none"> - <i>Pages per Sheet</i>: 1 (Normal) - <i>Print Both Sides</i>: Unchecked 	<ul style="list-style-type: none"> • For best results use HP Greeting Card Paper. • For Hagaki, use Plain Paper or Inkjet Paper. • Use Plain Paper setting to print Hagaki's address side. • If you have pre-folded greeting cards, unfold the cards, then load the cards into the IN tray. • Align the card edges before inserting the cards.

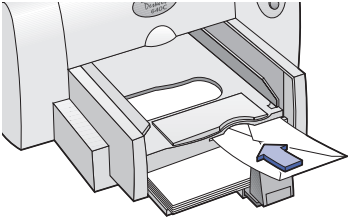

Printing Envelopes

I want to print...	I should...
<p>Single envelope</p> 	<ol style="list-style-type: none"> 1 Slide the envelope, with its flap side on the right and flap facing up, into the OUT tray's single envelope slot. Push the envelope in until it stops. 2 Choose the print settings that match the type and size of the envelope. 3 Print the envelope. <p>NOTE: When printing a single JIS #4 (90 x 205 mm) envelope, do NOT use the single envelope slot. Instead, follow instructions for printing cards as given on page 19.</p>
HP print settings to choose	Guidelines to remember
<p>Page Setup</p> <ul style="list-style-type: none"> - <i>Paper Size:</i> Choose appropriate envelope size - <i>Orientation:</i> Choose Portrait icon <p>Paper Type/Quality</p> <ul style="list-style-type: none"> - <i>Paper Type:</i> Choose Plain Paper - <i>Print Quality:</i> Choose Normal <p>Layout</p> <ul style="list-style-type: none"> - <i>Pages per Sheet:</i> 1 (Normal) - <i>Print Both Sides:</i> Unchecked 	<ul style="list-style-type: none"> • Make sure paper is loaded in the IN tray. • Avoid envelopes that have clasps or windows. • Avoid envelopes that are shiny or embossed, envelopes with thick, irregular, or curled edges, or envelopes that are wrinkled, torn, or otherwise damaged. • If your software program includes an envelope-printing feature, follow those instructions instead of the procedure here.

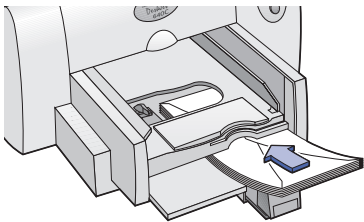
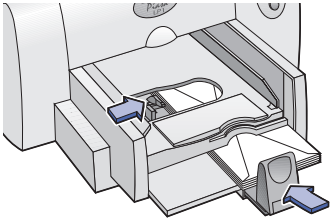
I want to print...	I should...
<p>Stack of envelopes</p>  	<ol style="list-style-type: none"> 1 Slide out both of the paper guides, and remove all paper from the IN tray. 2 Slide up to 15 envelopes, with their flap side on the right and flap facing up, into the IN tray as far as they will go. <p>NOTE: When printing on small envelopes, such as JIS #4, Invitation A2, or C6, follow instructions for printing cards as given on page 19.</p> <p>NOTE: When printing JIS #3 (120 x 235 mm) envelopes, make sure the flap is up and toward you.</p> <ol style="list-style-type: none"> 3 Slide the paper guides snugly against the edges of the envelopes. 4 Make sure the IN tray is pushed in. 5 Choose the print settings that match the type and size of the envelopes. 6 Print the envelopes.
HP print settings to choose	Guidelines to remember
<p>Page Setup</p> <ul style="list-style-type: none"> - <i>Paper Size:</i> Choose appropriate envelope size - <i>Orientation:</i> Choose Portrait icon <p>Paper Type/Quality</p> <ul style="list-style-type: none"> - <i>Paper Type:</i> Choose Plain Paper - <i>Print Quality:</i> Choose Normal <p>Layout</p> <ul style="list-style-type: none"> - <i>Pages per Sheet:</i> 1 (Normal) - <i>Print Both Sides:</i> Unchecked 	<ul style="list-style-type: none"> • Never load more than 15 envelopes at one time. • Align the envelope edges before inserting them. • Avoid envelopes that have clasps or windows. • Avoid envelopes that are shiny or embossed, envelopes with thick, irregular, or curled edges, or envelopes that are wrinkled, torn, or otherwise damaged. • If your software program includes an envelope-printing feature, follow those instructions instead of the procedure here.

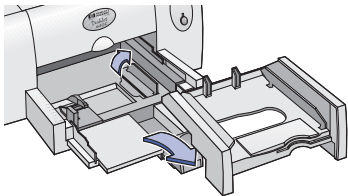
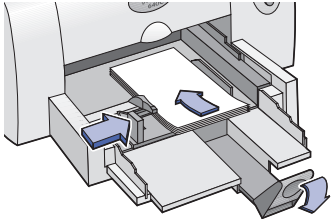
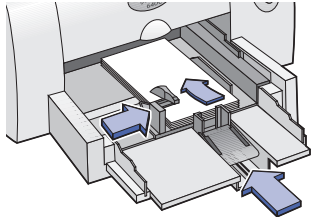
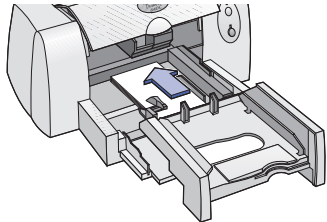

Printing Cards

I want to print...	I should...
<p data-bbox="110 343 568 404">Cards (index, business, and other small media)</p>    	<ol data-bbox="606 348 1131 499" style="list-style-type: none"> 1 Remove the OUT tray and raise the card guide. 2 Slide out both of the paper guides and remove all paper from the IN tray. 3 Insert up to 30 cards into the IN tray as far as they will go. <p data-bbox="633 534 1131 595">NOTE: When printing small envelopes, make sure the flap is up and toward you.</p> <ol data-bbox="606 635 1147 916" style="list-style-type: none"> 4 Press inside the handle of the paper length guide to release and drop down the handle. 5 Slide both paper guides snugly against the edges of the cards. 6 Replace the OUT tray. You might need to lift the top cover a little to do this. 7 Choose the print settings that match the type and size of the cards. 8 Print the cards.

HP print settings to choose	Guidelines to remember
<p>Page Setup</p> <ul style="list-style-type: none">- <i>Paper Size</i>: Choose appropriate card size- <i>Orientation</i>: Choose Portrait icon <p>Paper Type/Quality</p> <ul style="list-style-type: none">- <i>Paper Type</i>: Choose Plain Paper- <i>Print Quality</i>: Choose Normal <p>Layout</p> <ul style="list-style-type: none">- <i>Pages per Sheet</i>: 1 (Normal)- <i>Print Both Sides</i>: Unchecked	<ul style="list-style-type: none">• Align the edges of the media before inserting.

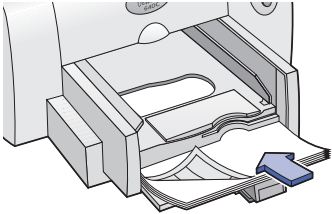

Printing Labels

I want to print...	I should...
	<ol style="list-style-type: none"> 1 Slide out both of the paper guides, and remove all paper from the IN tray. 2 Fan the edges of the label sheets to separate them, then align the label edges. Insert up to 20 label sheets (label side down). 3 Slide the paper guides snugly against the sheets. 4 Choose the print settings that match the type and size of labels. 5 Print the labels.
HP print settings to choose	Guidelines to remember
<p>Page Setup</p> <ul style="list-style-type: none"> - <i>Paper Size</i>: Choose A4 or Letter (8.5x11 in.) - <i>Orientation</i>: Choose appropriate orientation <p>Paper Type/Quality</p> <ul style="list-style-type: none"> - <i>Paper Type</i>: Choose Plain Paper - <i>Print Quality</i>: Choose Normal <p>Layout</p> <ul style="list-style-type: none"> - <i>Pages per Sheet</i>: 1 (Normal) - <i>Print Both Sides</i>: Unchecked 	<ul style="list-style-type: none"> • Use only paper labels that are designed specifically for use with inkjet printers. • Never load more than 20 sheets at one time. • Use only full sheets of labels. • Make sure the sheets are not sticky, wrinkled, or pulling away from their protective backing. • Do not use plastic or clear labels. The ink will not dry when used with plastic or clear labels.

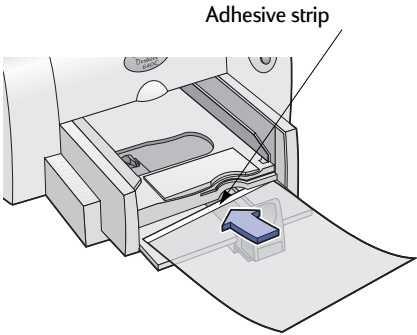

Printing Transparencies

I want to print...	I should...
 <p>Adhesive strip</p>	<ol style="list-style-type: none"> 1 Slide out both of the paper guides, and remove all paper from the IN tray. 2 Fan the edges of the transparency sheets to separate them, then align the edges. 3 Insert a stack of up to 25 transparency sheets, rough side down and the adhesive strip toward the printer. 4 Slide the paper guides snugly against the transparencies. 5 Choose the print settings that match the type and size of the transparencies. 6 Print the transparencies. 7 The printer waits for transparencies to dry before releasing them automatically. Press the Resume Button to continue printing.
HP print settings to choose	Guidelines to remember
<p>Page Setup</p> <ul style="list-style-type: none"> - <i>Paper Size</i>: Choose appropriate size - <i>Orientation</i>: Choose appropriate orientation <p>Paper Type/Quality</p> <ul style="list-style-type: none"> - <i>Paper Type</i>: Choose transparency type - <i>Print Quality</i>: Choose Normal or Best <p>Layout</p> <ul style="list-style-type: none"> - <i>Pages per Sheet</i>: 1 (Normal) - <i>Print Both Sides</i>: Unchecked 	<ul style="list-style-type: none"> - For best results, use HP Premium Inkjet Transparency Film or HP Premium Inkjet Rapid-dry Transparencies. The film coating on HP Premium Inkjet Rapid-dry Transparencies is especially developed to work with HP inks, giving you crisp images and text and the fastest drying time.

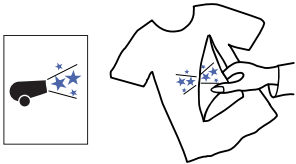

Printing Iron-on Transfers

I want to print...	I should...
	<ol style="list-style-type: none"> 1 Slide out both of the paper guides, and remove all paper from the IN tray. 2 Load the transfer paper transparent (or glossy) side down. 3 Slide the paper guides snugly against the sheets. 4 Choose the print settings that match the type and size of your iron-on transfers. 5 Print your transfers.
HP print settings to choose	Guidelines to remember
<p>Page Setup</p> <ul style="list-style-type: none"> - <i>Paper Size:</i> Choose appropriate size - <i>Orientation:</i> Choose appropriate orientation - <i>Flip Horizontal</i> <p>Paper Type/Quality</p> <ul style="list-style-type: none"> - <i>Paper Type:</i> Choose HP Premium Inkjet Paper - <i>Print Quality:</i> Choose Best <p>Layout</p> <ul style="list-style-type: none"> - <i>Pages per Sheet:</i> 1 (Normal) - <i>Print Both Sides:</i> Unchecked 	<ul style="list-style-type: none"> • If you want the text or picture on your t-shirt as you see it on the screen, flip the document by clicking Flip Horizontal. • For best results, use HP Iron-On T-Shirt Transfers.

Two-Sided Printing

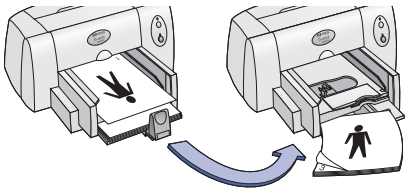
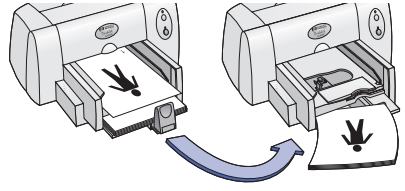
I want to print...	I should...
<p>Manual Two-Sided Printing Book Binding</p>  <p>Tablet Binding</p> 	<ol style="list-style-type: none"> 1 Remove all paper from the OUT tray. 2 Load paper into the IN tray. 3 Slide the paper guides snugly against the sheets. 4 In the Layout dialog box, click Print Both Sides, then select either the Book or Tablet icon. 5 Choose the print settings that match the type and size of your paper. 6 Begin printing. 7 Carefully follow the reloading instructions displayed on your computer screen. 8 When the paper is properly reloaded, click Continue in the message box on your computer screen.
HP print settings to choose	Guidelines to remember
<p>Page Setup</p> <ul style="list-style-type: none"> - <i>Paper Size</i>: Choose appropriate size - <i>Orientation</i>: Choose appropriate orientation <p>Paper Type/Quality</p> <ul style="list-style-type: none"> - <i>Paper Type</i>: Choose appropriate type - <i>Print Quality</i>: Choose Normal <p>Layout</p> <ul style="list-style-type: none"> - <i>Pages per Sheet</i>: 1 (Normal) - <i>Print Both Sides</i>: Check this box, then choose the Book icon (for binding on the side) or Tablet icon (for binding at the top). 	<ul style="list-style-type: none"> • The printer prints one side of the paper first. Then, a message on your computer screen tells you how to reload the paper and resume printing. The reverse side of the paper is then printed.

HP DeskJet Utility Window

The HP DeskJet Utility is located in the Utilities folder on your hard drive's main directory. The HP DeskJet Utility window has five panels, as shown below:

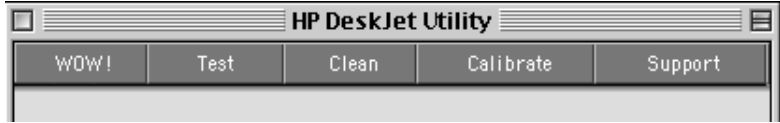

- **WOW!** demonstrates the HP DeskJet's print quality.
- **Test** allows you to print a test document.
- **Clean** allows you to automatically clean your print cartridges.
- **Calibrate** allows you to align the Color and Black print cartridges.
- **Support** allows you easy access to links to **HP Customer Care Online**.

Simply click a panel, then choose your option(s).

Note: The Ink Level tab in the HP DeskJet Utility is not available with all models of HP DeskJet 640C Series printers and configurations.

Select Panel

Use this panel when any of the functions on the Utility window prompt you to select a printer. For example, if you want to calibrate your printer by choosing the **Calibrate** panel, you will be prompted to first select your printer if it is not already selected.

To select your printer from within the **HP DeskJet Utility** window:

- 1 Click the **Select** panel on the **Utility** window.
- 2 Select **USB**.
- 3 In the **Connect To:** list, choose the desired HP DeskJet printer.

3 Using and Caring for Your Print Cartridges



Replacing Print Cartridges

Note: When buying replacement print cartridges, check the part numbers carefully. The print cartridge numbers for the 640C, 640CL, and 642C printers are:

- Black HP C6614 Series
- Tri-Color HP C51649 Series
- Photo HP C1816 Series

Note: When a print cartridge runs out of ink, leave the empty cartridge in the cradle until you can replace it. The printer does not print with only one print cartridge in the cradle.

To replace a print cartridge:

- 1 Press the Power  button to turn on the printer.
- 2 Open the top cover and raise the cradle latch. The print cartridges move to the center of the printer and the Resume  light flashes.
- 3 Lift the print cartridge out of the cradle and discard it.

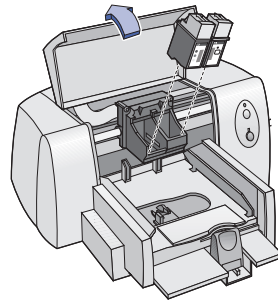

Warning

Keep print cartridges out of the reach of children.

Using and Caring for Your Print Cartridges

- 4 Remove the replacement print cartridge from its packaging and carefully remove the protective vinyl tape.

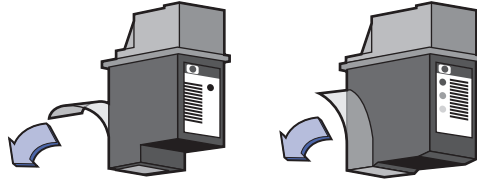



Do NOT touch the ink nozzles.

Do NOT touch or remove the copper contacts.

Warning

Do NOT touch the print cartridge ink nozzles or copper contacts. Touching these parts will result in clogs, ink failure, and bad electrical connection. Also, **do NOT** remove the copper strips; these are required electrical contacts.

- 5 Push the print cartridge firmly, straight down into the print cartridge cradle.
- 6 Close the cradle latch. When the latch is fully closed, you will hear a click.
- 7 Load plain white paper in the IN tray.
- 8 Plug in the power cord in the back of the printer.
- 9 Close the top cover.
- 10 If the Resume  light continues to flash and if the cradles do not move to the right side of the printer, remove and reinstall the print cartridges. Make sure the print cartridges are pressed down into the cradles before you snap them forward into positions. If the Resume  light continues to flash after you reinstall the new print cartridge, check the part number on the print cartridge to ensure you installed the correct one.

Storing Print Cartridges

To maintain excellent print quality from your print cartridges:

- Keep all print cartridges in their sealed packages, at room temperature (60-78° F or 15.6-26.6° C), until you are ready to use them.
- Once installed, leave the print cartridges in their cradle at all times to keep them from drying out or becoming clogged.
- If you store an unsealed print cartridge, do so in an airtight plastic container.
- **Do NOT** unplug the printer until printing is complete and the print cartridge cradles have returned to their home position on the right side of the printer. The print cartridges will dry out if not stored in their home position.

Warning

Only use the Power  button on the front of the printer to turn the printer on and off. Using a power strip, surge protector, or a wall-mounted outlet switch to turn the printer on and off may cause premature failure.

Cleaning Print Cartridges

When Do You Need to Clean?

Clean the print cartridges if your printed page is missing lines or dots, or if it contains ink streaks.

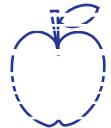

If You See Missing Lines or Dots...

Clean the print cartridges from the **HP DeskJet Utility** window by doing the following:

- 1 Double-click the **HP DeskJet Utility** icon located in the Utilities folder on your hard drive's main directory.
- 2 Click the **Clean** panel, then click the **Clean** button and follow the instructions displayed on your screen.

Note: Unnecessary cleaning wastes ink and shortens the life of the print cartridge.

If You See Ink Streaks...

Clean the print cartridges and the print cartridge cradle by following the instructions below.

- 1 Double-click the **HP DeskJet 640 Series Utility** icon in the Utilities folder on your hard drive's main directory.
- 2 Click the **Clean** panel, then click the **Clean** button. If this does not prevent streaks, follow the instructions for "Manually Cleaning the Print Cartridges" below.

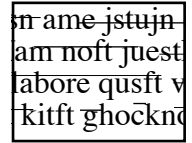
**Caution**

Be careful not to get ink on your hands or clothing.

Manually Cleaning the Print Cartridges and Print Cartridge Cradle

In order to properly clean the print cartridges and cradle, you will need distilled or bottled water and cotton swabs or a similar lint-free absorbent material that will not stick to the cartridges.

Manually Cleaning the Print Cartridges

- 1 Press the Power Button to turn the printer on, then lift the top cover.
- 2 After the print cartridges move to the center and stop, unplug the power cord from the back of the printer.

Warning

Keep new and used print cartridges out of the reach of children.

- 3 Remove the print cartridges and place them wide side down on a piece of paper.

Caution

Do NOT touch the print cartridge ink nozzles or copper contacts. Touching these parts will result in clogs, ink failure, and bad electrical connection. Also, **do NOT** remove the copper strips; these are required electrical contacts.

- 4 Dip a clean cotton swab into distilled water and squeeze any excess water from the swab.

Using and Caring for Your Print Cartridges

- 5 Clean the **face** and **edges** of the print cartridge as shown. **DO NOT** wipe the nozzle plate.

Do **NOT** clean nozzle plate

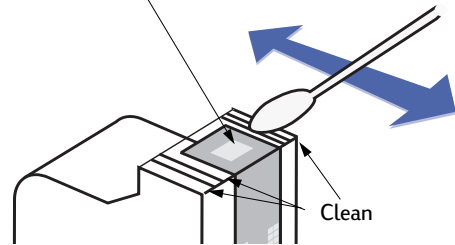

- 6 Inspect the cartridge for fibers on the face and edges. If fibers are still present, repeat the cleaning process.

- 7 Repeat the cleaning process for the other print cartridge.

Caution

Once you've removed the print cartridges, make sure that they are not outside of the print cartridge cradle longer than 30 minutes.

Manually Cleaning the Print Cartridge Cradle

- 1 Using clean, moistened swabs, wipe the underside of each wall of the cradle.
- 2 Repeat until no ink residue is seen on a clean swab.
- 3 Reinsert the print cartridges, then close the printer's top cover.
- 4 Make sure white paper is loaded into the IN tray.
- 5 Reinsert the electrical power cord into the back of the printer.
- 6 Print a test page. Double-click the **HP DeskJet 640 Series Utility** icon in the Utilities folder on your hard drive's main directory, click the **Test** panel, then click the **Test** button.

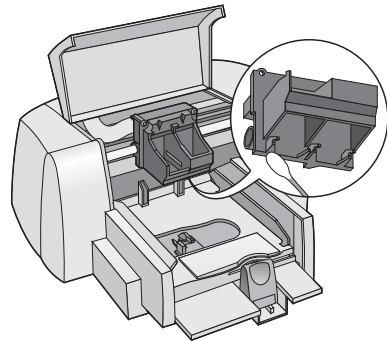

Note: If streaking still appears, repeat the procedure until the test printout is clean. You will find additional maintenance tips at http://www.hp.com/support/home_products.

Damage Resulting from Refilling the Print Cartridges

To get the best performance from your printer, Hewlett-Packard recommends using only genuine HP supplies for HP DeskJet printers, including genuine factory-filled HP print cartridges.

Damage resulting from the modification or refilling of HP print cartridges is specifically excluded from coverage by HP printer warranties.

Note: When buying replacement print cartridges, check the part numbers carefully. The print cartridge numbers for the 640C, 640CL, and 642C printers are:

- Black HP C6614 Series
- Tri-Color HP C51649 Series
- Photo HP C1816 Series

4 Getting Help When Things Go Wrong

Troubleshooting Tips

It's frustrating when things go wrong, but the following pages contain tips that can help you determine what the problem is and how to fix it.

Be sure cable connections are secure. Check if your question is similar to those listed below and then follow the instructions found in that section:



The printer software won't install, what's wrong? See pages 33–34.



Why won't it print? See pages 35–36.



What do the flashing lights mean? See page 37.



Is there a problem with your printout? See page 39.



The printer software won't install, what's wrong?

What is the problem?	Possible cause	To solve the problem...
I inserted a CD, but the computer couldn't read it.	<ul style="list-style-type: none"> • The CD wasn't properly inserted. <i>OR</i> • The CD player may be damaged. <i>OR</i> • The CD may be damaged. <i>OR</i> • The CD-ROM extensions may be turned off. 	<ol style="list-style-type: none"> 1 Reinsert the CD and try again. If this doesn't solve your problem... 2 Try inserting a CD that you know works. If that CD doesn't work, you may need to replace your CD player. 3 If other CD's work but the printer software CD doesn't, you may have a damaged CD. You can download the printer software from the HP Customer Care web site: www.hp.com/support/home_products 4 If you don't have Web access, contact HP Customer Care. See page 43, to locate the phone number nearest you. 5 Go to your Extensions Manager to ensure the Apple CD extension is turned on.









The printer software won't install, what's wrong? *continued*

What is the problem?	Possible cause	To solve the problem...
<p>The software did not install correctly.</p>	<ul style="list-style-type: none"> • There may be a conflict with your virus protection program. <i>OR</i> • There may be a conflict with another software program. <i>OR</i> • Your printer software didn't install properly. 	<ol style="list-style-type: none"> 1 Uninstall your printer software. Insert the printer software CD into your computer, select Uninstall from the Installer, then repeat the installation procedure. 2 Close any virus protection programs that are active. 3 If you have been using Apple's QuickDraw GX software, turn it off. Your HP DeskJet printer is not compatible with QuickDraw GX. 4 Exit all of your software programs. 5 Reinstall the printer software. See the "Install Printer Software" step on the <i>Quick Start Poster</i> or see page 51 in this <i>User's Guide</i>. <p>If you are still having problems with the software installation, call an HP authorized dealer or HP Customer Care. For the phone number of the HP Customer Care Center nearest you, see page 43.</p>



Why won't it print?

What is the problem?	Possible cause	To solve the problem...
 <p>No page came out of the printer.</p>	<p>Power may be off or there may be a loose connection.</p>	<ol style="list-style-type: none"> 1 Make sure the power is on. 2 Make sure that all cable connections are secure.
	<p>You may not have any paper in the IN tray.</p>	<p>Double-check that the media is placed in the IN tray correctly.</p>
	<p>The printer's top cover may be open.</p>	<p>Close the printer's top cover.</p>
	<p>A problem may exist with one of the print cartridges.</p>	<p>If the Resume light  is flashing, lift the printer's cover, verify that the print cartridges are installed properly. See page 1.</p>
	<p>The printer may be slow.</p>	<p>If the Power  light is flashing, the printer is in the process of printing. Be patient.</p>
	<p>The printer is waiting for you to press the Resume  button.</p>	<p>If the Resume  light is flashing, press the Resume  button.</p>
	<p>There may be a paper jam.</p>	<ol style="list-style-type: none"> 1 Turn off the printer, open the top cover, and remove the OUT tray. 2 Pull the paper out of either the IN tray or the OUT tray. Remove all torn pieces of paper from the printer. 3 Reload the paper in the IN tray. 4 Replace the OUT tray and close the top cover. Turn on the printer. 5 Press the Resume  button on the front of the printer. 6 If you were printing labels, make sure a label did not become unglued from the label sheet while going through the printer. 7 If the paper jam has cleared, print your document again.







Why won't it print? *continued*

What is the problem?	Possible cause	To solve the problem...
 A blank page came out of the printer.	You may be out of ink.	<ol style="list-style-type: none"> 1 Lift the printer's cover and verify that the print cartridges are installed properly. 2 If you are out of ink, replace the print cartridge. See "Replacing Print Cartridges" on page 27. 3 Print your document again.
	You may have forgotten to remove the vinyl tape from the print cartridge.	Make sure you have removed the protective piece of vinyl tape on each of the print cartridges. See "Replacing Print Cartridges" on page 27.
	You may be trying to print a fax.	<ol style="list-style-type: none"> 1 Save the fax in a graphic format, such as TIFF. 2 Place it in a word processing document and print it from there.
The printer is really slow.	Your computer may have less than the minimum system requirements.	<ol style="list-style-type: none"> 1 Check the amount of RAM and processor speed in your computer. See "System Requirements" on page 52. 2 Free up some space on your hard drive. Having less than 100 MB of free space on your computer's hard drive can mean longer processing times.
	Too many software programs may be running at the same time.	Close all unnecessary software programs.
	You may be using outdated printer software.	Check the printer driver you are using. Be sure to check the HP web site at http://www.hp.com/support/home_products for the most recent software updates.
	You may be printing a complex document containing graphics or photographs.	Be patient. Large, complex documents containing graphics or photographs print slower than text-only documents.







What do the flashing lights mean?

What is the problem?	Possible cause	To solve the problem...
The Power  light is flashing.	Your printer may be receiving data.	Be patient, your computer is processing the print job.
The Resume  light is flashing.	You may be out of paper.	<ol style="list-style-type: none"> 1 Insert paper. 2 Press the Resume  button.
	You may have a paper jam.	<ol style="list-style-type: none"> 1 Turn off the printer, open the top cover, and remove the OUT tray. 2 Pull the paper out of either the IN tray or the OUT tray. Remove all torn pieces of paper from the printer. 3 Reload the paper in the IN tray. 4 Replace the OUT tray and close the top cover. Turn on the printer. 5 Press the Resume  button on the front of the printer. 6 If you were printing labels, make sure a label did not become unglued from the label sheet while going through the printer. 7 If the paper jam has cleared, print your document again.
	You may be printing a two-sided document by hand and the first side has finished printing.	<ol style="list-style-type: none"> 1 Follow the on-screen directions for how to insert the paper. 2 Press the Resume  button.
	The top cover may be open.	Close the top cover.
	There may be a problem with one of the print cartridges.	<ol style="list-style-type: none"> 1 Lift the printer's cover and verify that the print cartridges are installed properly. 2 If you are out of ink, replace the print cartridge. See "Replacing Print Cartridges" on page 27. 3 Print your document again.



What do the flashing lights mean? *continued*

What is the problem?	Possible cause	To solve the problem...
Both lights are flashing.	The printer may need to be reset.	<ol style="list-style-type: none"> 1 Press the Power  button to turn the printer off. Then press the Power  button again to turn the printer back on. 2 If that doesn't solve the problem, press the Power  button to turn the printer off. 3 Unplug the printer. 4 Plug the printer back in. 5 Press the Power  button to turn the printer on.



Is there a problem with your printout?

What is the problem?	Possible cause	To solve the problem...
 <p>Parts of the document are missing or are in the wrong place.</p>	<p>Paper may not be loaded correctly.</p>	<ol style="list-style-type: none"> 1 Make sure the media is correctly oriented in the IN tray. 2 Make sure the paper guides fit snugly against the media.
	<p>You may have selected the wrong paper orientation.</p>	<p>Make sure you have selected the correct orientation (portrait or landscape) on the Page Setup dialog box. See “Page Setup - Controlling Page Layout” on page 7.</p>
	<p>You may have selected the wrong paper size.</p>	<p>Make sure you have selected the correct paper size in the Page Setup dialog box. See “Page Setup - Controlling Page Layout” on page 7.</p>
	<p>You may be trying to print text or graphics that are larger than your paper size.</p>	<p>Make sure text and graphics are scaled correctly in your document. See “Paper Size, Scaling, and Page Orientation” on page 7.</p>
	<p>You may have selected the wrong margins.</p>	<p>Make sure the margins are within the printable area. See “Minimum Printing Margins” on page 54.</p>
	<p>You may have accidentally left Poster Printing selected.</p>	<p>Uncheck Poster Printing in the Layout panel. See “Layout” on page 10.</p>

Is there a problem with your printout? *continued*

What is the problem?	Possible cause	To solve the problem...
 Print quality is poor.	You may not be using the most appropriate media for the desired output.	<ul style="list-style-type: none"> - Make sure that you are using media intended for HP DeskJet printers. - Print quality is dramatically improved if you print on paper specifically designed for a certain output (photographs, for example), rather than using plain paper.
	You may be printing on the wrong side of the media.	Make sure that the media is loaded print side down.
	You may not have selected the correct paper type in the printer software.	Make sure that you have selected the correct paper type on the Paper Type/Quality dialog box. See “Paper Type/Quality” on page 10.
	You may be printing in Draft mode.	If printing appears faded or dull, click Normal or Best instead of Draft on the Paper Type/Quality dialog box. See “Paper Type/Quality” on page 10.
	If you have smearing, you may be using too much ink.	<ol style="list-style-type: none"> 1 Click Normal or Draft instead of Best on the Paper Type/Quality dialog box. See “Paper Type/Quality” on page 10. 2 Reduce the amount of ink. From the HP DeskJet Print dialog box, select the Ink Controls panel. Use the sliders to adjust ink volume. 3 Increase the dry time. From the HP DeskJet Print dialog box, select the Ink Controls panel. Use the sliders to adjust dry time.
	You may be running out of ink.	<ol style="list-style-type: none"> 1 If you are out of ink, replace the print cartridge. See “Replacing Print Cartridges” on page 27. 2 Print your document again.
	You may need to clean the print cartridges.	See “Cleaning Print Cartridges” on page 29.



Is there a problem with your printout? *continued*

What is the problem?	Possible cause	To solve the problem...
 <p>Print quality is poor. (continued)</p>	<p>You may have forgotten to remove the vinyl tape from the print cartridge.</p>	<p>Make sure that you have removed the protective piece of vinyl tape on each of the print cartridges. See “Replacing Print Cartridges” on page 27.</p>
	<p>You may have the incorrect “Image” setting in the Color panel of the Print dialog box.</p>	<p>Click the Revert to Defaults button in the Color panel of the Print dialog box. See “Color” on page 11.</p>
	<p>Your print cartridges may be out of alignment.</p>	<p>If the color and black ink aren’t lining up on the printed page, go to the HP DeskJet Utility located in the Utilities folder in your hard drive’s main directory. Click the Calibrate panel, then click the Align button. See “HP DeskJet Utility Window” on page 25.</p>
<p>Binding margin appears in the wrong place when trying to do Two-Sided Printing.</p>	<p>You may have selected the wrong paper orientation.</p>	<p>- Make sure you have selected the correct Binding option in the Layout panel of the Print dialog box. See “Layout” on page 10.</p>

HP Customer Care



HP DeskJet printers set the standard for quality and reliability, so you have made an excellent choice. Should you

need help, however, HP Customer Care's award-winning service and support is nearby to provide expert advice on using your HP printer or to answer specific questions about a problem you are having. Whether online or by phone, you'll find the support you need—and you'll find it fast.

HP Customer Care Online

Click your way to a quick solution! **HP Customer Care Online** is a great place to go for answers to questions about your HP products. You'll get instant access to everything from helpful printing tips to the latest product and software updates—24 hours a day, seven days a week, all at no charge to you.

If you have a modem connected to your computer and subscribe to an online service or have direct access to the Internet, you can obtain a wide variety of information about your printer at the following web sites:

English:

http://www.hp.com/support/home_products

French:

<http://www.hp.com/cposupport/fr/>

German:

<http://www.hp.com/cposupport/de>

Japanese:

http://www.jpn.hp.com/CPO_TC/eschome.htm

Portuguese:

<http://www.hp.com/cposupport/pt>

Spanish:

<http://www.hp.com/cposupport/es/>

From HP Customer Care Online you can link to **HP Customer Care User Forums** and **HP Customer Care Email**.

HP Customer Care User Forums

They're friendly. They're informative. Check out our online user forums. Simply review existing messages left by other HP users to find the answers you're looking for. You can also post your questions, then check back later for ideas and suggestions from knowledgeable users and system operators.

HP Customer Care by Email

Connect with HP via email and receive a personal reply from an HP Customer Care service technician. Responses are normally provided within 24 hours of receipt (excluding holidays). A great option for those non-urgent questions.

Printer Software

Printer software (also referred to as a printer driver) allows your printer to talk with your computer. HP provides several options for getting printer software updates:

- Download the printer software by accessing the **HP Customer Care Online** web site. See "HP Customer Care Online" on this page for the addresses of the HP web sites.
- If you are in the U. S. and need a software update, you can download the printer software from: http://www.hp.com/support/home_products. If you do not have access to the web site, call (661) 257-5565. Software updates are available for the cost of the CDs plus shipping.
- If you are outside the U.S. and cannot download the driver from **HP Customer Care Online** (on this page), call the **HP Customer Care Center** (page 43) nearest you.



HP Customer Care Repair

If your HP printer is ever in need of repair, simply call the **HP Customer Care Center**. A trained service technician will diagnose the problem and coordinate the repair process for you. This service is free during your printer's standard warranty. Beyond the warranty period, repairs are charged on a time and materials basis.



HP Customer Care by Phone

Within the period specified below from the time of your purchase, telephone support is provided to you free of charge. However, if you are calling long distance, long-distance charges may apply.

Free Phone Support Period

In This Region:	Your Free Phone Support Period is:
North America & Canada	None, fee based
Asia Pacific	90 days
Europe	90 days
Latin America	1 year

Before placing a call for help, please make sure that:

- 1 You have checked your *Quick Start Poster* and this *User's Guide* for installation and troubleshooting tips.
- 2 You have checked **HP Customer Care Online** (see page 42) for product help.
- 3 If you cannot solve your problem using the above, then call HP Customer Care while you're in front of your computer and printer. Before you call, be sure you have the following information:

- Your printer's serial number (the label is on the printer's bottom).

- Your printer's model number (the label is on the front of the printer).

- The model of the computer.

- The version of the printer and software program (if applicable).

Then we can help you with your questions immediately!

See the list below for your country's **HP Customer Care Center** phone number:

Africa/Middle East	41 22/780 41 11
Argentina	(541) 778-8380
Australia	+61 3 8877 8000
Austria	43 (0) 660 6386
Belgium (Dutch)	32 (0)2 62688 06
Belgium (French)	32 (0)2 62688 07
Brazil	011 829-6612
Canada	(905) 206-4663
Chile	800 36 0999
China	8610-65645959
Czech Republic	42 (2) 471 7321
Denmark	45 (0) 39 294099
Finland	358 (9) 2034 7288
France	33 (0) 143623434
Germany	49 (0) 180 532 6222
Greece	30 1 689 64 11
Hong Kong	(800) 96 7729
Hungary	36 (1) 252 4505
India	91 11 682 60 35
Indonesia	6221 350 3408
Ireland	353 (0) 1662 5525
Israel	972-9-9524848
Italy	39 (0) 2 264 10350
Japan, Osaka	81 6 6838 1155
Japan, Tokyo	81 3 3335-8333
Korea	02 3270 0700
Malaysia	03 2952566
Mexico D.F.	258 9922
Mexico, Guadalajara	01 800 472 6684
Middle East/Africa	41 22/780 41 11
Netherlands	31 (0) 20 606 8751
New Zealand	(09) 356-6640
Norway	47 (0) 22 116299
Philippines	65 272 5300
Poland	(+48) 22 519 06 00
Portugal	351 (0) 1 318 00 65
Russia	7095 923 50 01
Singapore	65 272 5300
Spain	34 (9) 02321 123
Sweden	46 (0) 8 6192170
Switzerland	41 (0) 84 8801111
Taiwan	886 2-2717-0055
Thailand	(66-2) 661 4011
Turkey	90 1 224 59 25
United Kingdom	44 (0) 171 512 5202
U.S.	(208) 344-4131
Venezuela	800 47 888
Venezuela, Caracas	207 8488

After the Free Phone Support Period

You can still get help from HP for a fee. Prices are subject to change without notice. (**HP Customer Care Online** help (see page 42) on the internet is still available for free!)

- For quick questions in the United States only, call (900) 555-1500. The charges are \$2.50 per minute and begin when you connect with a support technician.
- For calls from Canada, or for calls in the U.S. that you anticipate might be longer than ten minutes in length, call (800) 999-1148. The fee is US \$25 per call, charged to your Visa or MasterCard.
- If, during your phone call, it is determined that your printer requires repair and you are within your printer's Limited Warranty period (see page 56, Printer), you will not be charged for the phone support service. However, for countries where the above toll-free phone numbers are not available, the regular long-distance charges may apply.

Extended Warranty Options

If you would like to extend your printer coverage beyond the one year factory warranty, you have the following options:

- Consult your reseller to get extended coverage.
- If your reseller does not offer service contracts, please call HP directly and ask about our HP Service Agreements. In the U.S., call (800) 446-0522; in Canada, call (800) 268-1221. For HP Service Agreements outside the U.S. and Canada, contact your local HP Sales Office.

5

Supplies and Accessories

Printer Supplies

For ordering information see page 47.

Part Name	Part Number
Interface Cables	
HP USB-Compliant Interface Cable (2 meter length)	C6518A
Print Cartridges	
● Black	C6614 Series
● Tri-color	51649 Series
● Photo	C1816 Series
HP Photo Color Kits	
Asian HP Photo Color Kit	C4583A
European HP Photo Color Kit	C4584A
Latin America HP Photo Color Kit	C4590A
US HP Photo color Kit	C4585A
Universal Power Adapter	
	0950-3490
Power Cords	
U.S., Canada, Brazil, Latin America, Saudi Arabia	8120-6313
Japan	8120-6316
Singapore, Malaysia, Hong Kong	8120-8669
South Africa, India	8120-6317
Argentina	8120-8367
Australia	8120-6312
China, Taiwan, Philippines	8120-8373
Korea	8120-8441
Europe, Jordan, Lebanon, North Africa, Israel, Russia, Baltic countries, Thailand, Indonesia, Caribbean, Latin America	8120-6314
U.K., Middle East	8120-6315

Printer Quick Start Posters and User's Guide for Macintosh

Most HP printer documentation is available for viewing and printing at http://www.hp.com/support/home_products.

Language	Part Number	
	Quick Start Poster	User's Guide
Dutch	C6464-90026	C6464-90036
English	C6464-90027	C6464-90029
French	C6464-90027	C6464-90030
German	C6464-90026	C6464-90033
Italian	C6464-90026	C6464-90034
Japanese	C6464-90028	C6464-90037
Portuguese	C6464-90027	C6464-90032
Spanish	C6464-90027	C6464-90031
Swedish	C6464-90026	C6464-90035

Paper and Other Media

Availability of special media varies by country.

Paper Type/Description	Part Number
HP Bright White Inkjet Paper	
A4, 200 sheets	C5977A
A4, 500 sheets	C1825A
U.S. letter, 200 sheets	C5976A
U.S. letter, 500 sheets	C1824A
HP Premium Inkjet Paper	
A4, 200 sheets	C51634Z
U.S. letter, 200 sheets	C51634Y
HP Premium Inkjet Heavyweight Paper	
A4, 100 sheets	C1853A
U.S. letter, 200 sheets	C1852A
HP Professional Brochure & Flyer Paper, Matte	
U.S. letter, 50 sheets	C6955A
HP Photo Paper, Two-Sided, Satin/Glossy	
Asian A4, 20 sheets	C6765A
European A4, 20 sheets	C1847A
U.S. letter, 20 sheets	C1846A
HP Premium Photo Paper, Glossy	
Asian A4, 15 sheets	C6043A
European A4, 15 sheets	C6040A
U.S. letter, 15 sheets	C6039A

Paper Type/Description	Part Number
HP Premium Inkjet Transparency Film	
A4, 20 sheets	C3832A
A4, 50 sheets	C3835A
U.S. letter, 20 sheets	C3828A
U.S. letter, 50 sheets	C3834A
HP Premium InkJet Rapid-dry Transparencies	
A4, 50 sheets	C6053A
U.S. letter, 50 sheets	C6051A
HP Matte Greeting Cards, White/Quarter-fold	
A4, 20 sheets, 20 envelopes	C6042A
U.S. letter, 20 sheets, 20 envelopes	C1812A
HP Glossy Greeting Cards, White/Half-fold	
A4, 10 sheets, 10 envelopes	C6045A
U.S. letter, 20 sheets, 20 envelopes	C6044A
HP Felt-textured Greeting Card Paper, Ivory/Half-fold	
U.S. letter, 20 sheets, 20 envelopes	C6828A
HP Premium Glossy Hagaki Cards	
Hagaki card, 20 cards	C6675A
HP Iron-on T-Shirt Transfers	
European A4, 10 sheets	C6050A
Asian A4, 10 sheets	C6065A
U.S. letter, 10 sheets	C6049A
HP Restickables, Large Round Inkjet Stickers	
U.S. letter, 10 sheets (90 stickers)	C6822A
HP Restickables, Large Square Inkjet Stickers	
U.S. letter, 10 sheets (90 stickers)	C6823A

Note: To find out which recycled papers are recommended for your printer, contact your local HP Sales Office and ask for the HP Inkjet Printer Family Paper Specifications Guide, HP part number 5961-0920.

Ordering Information

To order printer supplies or accessories, call your nearest HP dealer or call HP DIRECT at the following numbers for fast shipping service.

In the U.S., you can buy supplies and accessories directly from HP at www.hpshopping.com, or call the HP Shopping Village at 1-888-999-4747.

- **Argentina:** (54 1) 787-7100
Fax: (54 1) 787-7213
Hewlett-Packard Argentina,
Montañeses 2150 1428
Buenos Aires, Argentina
- **Australia/New Zealand:** (03) 895-2895
China Resources Bldg.
26 Harbour Road
Wanchai, Hong Kong
- **Austria-South-East Area:** (43-0222) 25 000, ext. 755
Fax: (43-0222) 25 000, ext. 610
Hewlett-Packard Ges.m.b.H.
Ersatzteilverkauf Lieblg. 1
A-1222 Wien
- **Belgium:** 02/778 3092 (or 3090, 3091)
Fax: 02/778 3076
Hewlett-Packard Belgium SA/NV
100 bd. de la Woluwe/Woluwedal
1200 BRUXELLES
- **Brazil:** Centro de Informações HP
Grande São Paulo: 822-5565
Demais Localidades: 0800-157751
Fax: (011) 829-7116
Centro de Informações HP
Hewlett Packard Brasil S.A.
Caixa Postal 134, Rua Clodomiro Amazonas, 258
CEP 04534-011, São Paulo - SP
- **Canada:** (800) 387-3154, (905) 206-4725
Fax: (905) 206-3485/-3739
Hewlett-Packard (Canada) Ltd.
5150 Spectrum Way
Mississauga, Ontario L4W 5G1
Toronto: (416) 671-8383
- **Chile:** (56 2) 203-3233
Fax: (56 2) 203-3234
Hewlett-Packard de Chile SA
Av. Andres Bello 2777, Oficina 1302
Los Condes, Santiago, Chile
- **Denmark:** 45 99 14 29
Fax: 42 81 58 10
Hewlett-Packard A/S
Kongevejen 25, 3460 BIRKEROD
- **Finland:** (90) 8872 2397
Fax: (90) 8872 2620
Hewlett-Packard Oy
Varaosamynti, Piispankalliontie 17
02200 ESPOO
- **France:** (1) 40 85 71 12
Fax: (1) 47 98 26 08
EuroParts
77 101 avenue du Vieux Chemin de Saint-Denis
92625 GENNEVILLIERS
- **Germany:** 07031-145444
Fax: 07031-141395
Hewlett-Packard GmbH, HP Express Support
Ersatzteil-Verkauf, Herrenberger Str. 130
71034 BÖBLINGEN
- **International Sales Branch:** (41) 22 780 4111
Fax: (41) 22 780-4770
Hewlett-Packard S. A., ISB
39, rue de Veyrot 1217 MEYRIN 1
GENEVE - SUISSE
- **Italy:** 02/9212.2336/2475
Fax: 02/92101757
Hewlett-Packard Italiana S. P. A.
Ufficio Parti di ricambio
Via G. Di Vittorio, 9
20063 Cernusco s/N (MI)
- **Japan:** (03) 3335-8333
Hewlett-Packard Japan Ltd.
29-21 Takaido-Higashi 3-chone, Suginami-ku
Tokyo 168-8585
- **Latin America Headquarters:** (305) 267-4220
Fax: (305) 267-4247
5200 Blue Lagoon Drive, Suite 950
Miami, FL 33126
- **Mexico:** (52 5) 258-4600
Fax: (54 1) 258-4362
Hewlett-Packard de México, S.A. de C.V.
Prolongación Reforma #470
Colonia Lomas de Santa Fe, C.P. 01210 México, D.F.

- **Netherlands:** 0 33 450 1808
Fax: 0 33 456 0891
Hewlett-Packard Nederland B. V.
Parts Direct Service
Basicweg 10
3821 BR AMERSFOORT
- **Norway:** 22735926
Fax: 22735611
Hewlett-Packard Norge A/S, Express Support
Drammensveien 169-171
0212 Oslo
- **Spain:** 1 6 31 14 81
Fax: 1 6 31 12 74
Hewlett-Packard Española S.A.
Departamento de Venta de Piezas
Ctra N-VI, Km. 16,500
28230 LAS ROZAS, Madrid
- **Sweden:** 8-4442239
Fax: 8-4442116
Hewlett-Packard Sverige AB
Skalholtsgatan 9, Box 19
164 93 KISTA
- **Switzerland:** 056/279 286
Fax: 056/279 280
Elbatex Datentechnik AG
Schwimmbadstrasse 45, 5430 WETTINGEN
- **United Kingdom:**
+44 1765 690061
Fax: +44 1765 690731
Express Terminals, 47 Allhallowgate
Ripon, North Yorkshire
- +44 181 568 7100
Fax: +44 181 568 7044
Parts First, Riverside Works
Isleworth, Middlesex, TW7 7BY
- +44 1734 521587
Fax: +44 1734 521712
Westcoast, 28-30 Richfield Avenue
Reading, Berkshire, RG1 8BJ
- **United States:** (800) 227-8164
- **Venezuela:** (58 2) 239-4244/4133
Fax: (58 2) 207-8014
Hewlett-Packard de Venezuela C.A.
Tercera Transversal de Los Ruices Norte
Edificio Segre, Caracas 1071, Venezuela
Apartado Postal 50933, Caracas 1050

Elsewhere in the world

- **Hewlett-Packard Company**
Intercontinental Headquarters,
3495 Deer Creek Road,
Palo Alto, CA 94304, U.S.A.

A Setup Instructions

Using a USB Connection

You can connect your HP DeskJet 640C Series directly to your computer using a USB cable if your computer supports USB (Universal Serial Bus). Before you connect your printer to your computer, make sure your configuration meets these requirements:

- Your computer must support USB.
- You will need a USB-compliant interface cable, such as HP Part Number C6518A.
- Your computer must be turned on and running Mac OS 8.1 or higher.

1 Plug in Electrical Power Cord

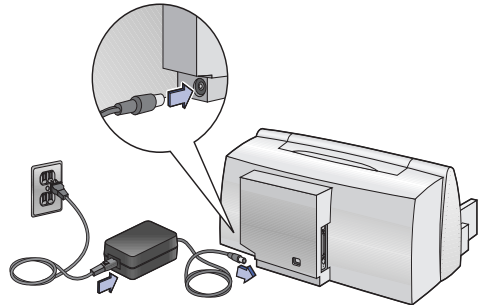

2 Load White Paper

- a** Slide the paper guides out as far as possible to make room for the paper.

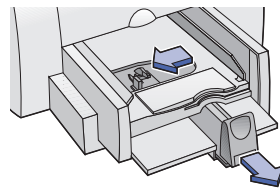

- b** Put a stack of paper into the IN tray, print side down. You can insert up to 10 mm (3/8 inch) at a time.
- c** Push the paper toward the back of the paper tray until it stops.

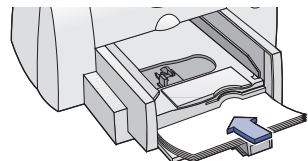

Setup Instructions

- d Slide both paper guides to fit snug against the paper's edges.

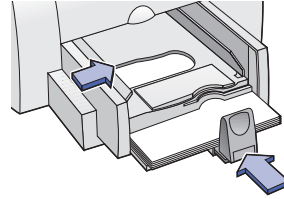

3 Insert Print Cartridge

- a Press Power  button to turn on printer.
- b Remove vinyl tape from print cartridges. **Do NOT** touch or remove copper strip on print cartridges.

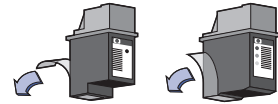

- c Open top cover.

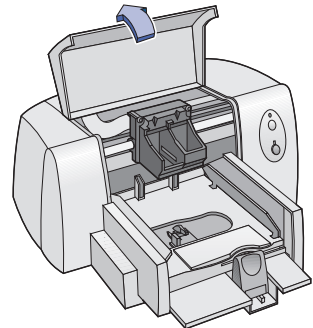

- d For each print cartridge, with the copper electrical contacts toward the rear of the printer and the print cartridge held vertically, push the print cartridge firmly down into the cradle.
- Insert the black print cartridge in the right cradle and insert the tri-color print cartridge in the left cradle. You must insert both print cartridges for the printer to operate.

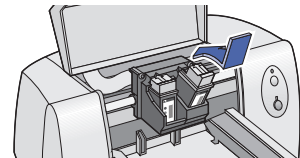

- e Close top cover.

4 Connect USB Cable

- You can connect to any USB port.
- A USB cable, such as an HP USB-Compliant Interface Cable (part number C6518A), should be purchased separately.
 - a Lift open the cable access door on the back of the printer.
 - b Plug one end of the USB cable into the USB port on the printer.
 - c Plug the other end of the USB cable into the USB port on the computer.

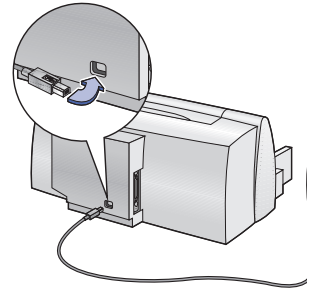

5 Install Printer Software

- a Insert the HP Printer Software CD into your CD-ROM drive.
- b Double-click the HP DeskJet Mac Installer.



HP DeskJet Installer

- c Follow the on-screen instructions to complete the installation. Your computer will restart when the installation is complete.
- d After your computer restarts, the HP DeskJet Utility (Select Printer) dialog box opens. Follow the instructions in this dialog box to select the HP DeskJet 640C Series printer.

B Specifications

DeskJet 640C model no. C6464A
DeskJet 640CL model no. C6465A
DeskJet 642C model no. C6466A

Black Text Print Speed*

Best	1 page per min.
Normal	3 pages per min.
Draft:	6 pages per min.

Black Text with Color Graphics Print Speed*

Best	0.3 page per min.
Normal	0.7 pages per min.
Draft:	2 pages per min.

Mixed Text with Color Graphics Print Speed*

Best	0.5 page per min.
Normal	1 pages per min.
Draft:	3 pages per min.

Color Print Speed (Tri-Color and Photo Cartridge)*

5 x 7 inch image 0.25 page per min.

Duty Cycle

1,000 pages per month

Black TrueType™ Text Resolution (depends on paper type)

Draft:	300 x 300 dpi
Normal:	600 x 300 dpi
Best:	600 x 600 dpi

Color Resolution (Black and Tri-Color Cartridges)

300 x 300 dpi on plain paper.
600 x 300 dpi on glossy paper, transparency film, and premium paper.

Color Resolution (Tri-Color and Photo Cartridge)

600 x 300 dpi with six inks on all paper types (in Best and Normal modes) using PhotoREt Technology.

Print Technology

Drop-on-demand thermal inkjet printing

Software Compatibility

USB Connection: Mac OS version 8.1 or later

System Requirements

USB Connection:

PowerPC Mac OS computer with a USB port
Mac OS version 8.1 or later
32 MB RAM
8 MB (minimum) available hard-disk space

Buttons/Lights

Resume Button and Light
Power Button and Light

I/O Interface

Universal Serial Bus

Dimensions

436 mm wide x 199 mm high x 405 mm deep
17.2 in. wide x 7.9 in. high x 16 in. deep

Weight

5.3 kg (11.6 lb) without power supply and print cartridges

Operating Environment

Maximum operating temperature:

41 to 104 °F, 5 to 40 °C

Humidity: 10 to 80% RH noncondensing

Recommended operating conditions for best print quality:

59 to 95 °F or 15 to 35 °C

20 to 80% RH noncondensing

Storage temperature: -40 to 140 °F, -40 to 60 °C

Power Consumption

2 watts average maximum when off

2.5 watts average maximum non-printing

23 watts average maximum when printing

* Approximate figures. Exact speed will vary depending on the system configuration, software program, and document complexity.

Specifications

Power Requirements

Input Voltage:	100 to 240 VAC (±10%)
Input Frequency:	50/60 Hz (±3 Hz)

Automatically accommodates the world-wide range of AC line voltages and frequencies. There is no on/off switch on the power adapter.

Declared noise emissions in accordance with ISO 9296:

Sound power level, LWAd (1 B=10 dB): 5.5 B in Normal mode.
 Sound pressure level, LpAm (bystander positions): 42 dB in Normal mode.

Media Weight

Paper:	60 to 135 gsm (16 to 36 lb index)
Envelopes:	75 to 90 gsm (20 to 24 lb)
Cards:	110 to 200 gsm; 0.3 mm max thickness (110 lb index max; 8.5 pt max thickness)

Media Handling

Sheets:	up to 100 sheets
Envelopes:	up to 20 envelopes
Cards:	up to 30 cards
Transparencies:	up to 25 sheets
Labels:	up to 25 sheets of paper labels Use only U.S. letter-sized or A4-sized sheets. Use only paper labels specifically designed for use with HP inkjet printers.
OUT tray capacity:	up to 50 sheets

Media Size

Custom size:	
Width:	127 to 216 mm (5.0 to 8.5 in)
Length:	148 to 356 mm (5.83 to 14 in)
U.S. Letter:	216 x 279 mm (8.5 x 11 in)
U.S. Legal:	216 x 356 mm (8.5 x 14 in)
Executive:	184 x 267 mm (7.25 x 10.5 in)
U.S. No. 10 envelope:	105 x 241 mm (4.12 x 9.5 in)
Invitation A2 envelope:	4.37 x 5.75 in
Index card:	76 x 127 mm (3 x 5 in)
Index card:	102 x 152 mm (4 x 6 in)
Index card:	127 x 203 mm (5 x 8 in)
European A4:	210 x 297 mm
European A5:	148 x 210 mm
B5-JIS:	182 x 257 mm
European DL envelope:	220 x 110 mm
European C6 envelope:	114 x 162 mm
European A6 card:	105 x 148 mm
Japanese Hagaki postcard:	100 x 148 mm

Minimum Printing Margins

The printer cannot print outside a certain area of the page, so you must make sure the contents of your document fall within the printable area—that is, within the top, bottom, left, and right margins available for the specific size of paper on which you are printing.

When you use nonstandard paper sizes and select the **Custom Paper Size** setting in the HP print settings box, the paper width must be between 127 and 215 mm (5 and 8.5 inches) and the paper length must be between 148 and 356 mm (5.83 and 14 inches).

A4-Sized Paper

Left:	3.4 mm
Right:	3.4 mm
Top:	1.0 mm
Bottom:	14.9 mm

Margins for Letter-, Legal-, and Executive-Sized Paper

Left:	0.25 in.
Right:	0.25 in.
Top:	0.04 in.
Bottom:	0.59 in.

A5-Sized Paper

Left:	3.2 mm
Right:	3.2 mm
Top:	1.0 mm
Bottom:	21.2 mm

B5-Sized Paper

Left:	4.2 mm
Right:	4.2 mm
Top:	1.0 mm
Bottom:	21.2 mm

Cards (3x5, 4x6, and 5x8)

Left:	0.125 in.
Right:	0.125 in.
Top:	0.04 in.
Bottom:	0.84 in.

Cards (A6)

Left:	3.2 mm
Right:	3.2 mm
Top:	1.0 mm
Bottom:	21.2 mm

Hagaki Postcards

Left:	4.2 mm
Right:	4.2 mm
Top:	1.0 mm
Bottom:	21.2 mm

Envelopes

Left:	0.21 mm (0.84 in.)
Right:	1 mm (0.04 in.)
Top:	3.2 mm (0.125 in.)
Bottom:	3.2 mm (0.125 in.)

C Legal Information

Regulatory Notices

Hewlett-Packard Company

This device complies with part 15 of the FCC Rules. Operation is subject to the following two conditions: (1) This device may not cause harmful interference, and (2) this device must accept any interference received, including interference that may cause undesired operation.

Pursuant to Part 15.21 of the FCC Rules, any changes or modifications to this equipment not expressly approved by Hewlett-Packard Company may cause harmful interference, and void your authority to operate this equipment. Use of a shielded data cable is required to comply with the Class B limits of Part 15 of the FCC Rules.

For further information, contact:

Hewlett-Packard Company
Manager of Corporate Product Regulations
3000 Hanover Street
Palo Alto, Ca 94304
(415) 857-1501

NOTE: This equipment has been tested and found to comply with the limits for a Class B digital device, pursuant to part 15 of the FCC rules. These limits are designed to provide reasonable protection against harmful interference in a residential installation.

This equipment generates, uses, and can radiate radio frequency energy and, if not installed and used in accordance with the instructions, can cause harmful interference to radio communications.

However, there is no guarantee that interference will not occur in a particular installation. If this equipment does cause harmful interference to radio or television reception, which can be determined by turning the equipment off and on, the user is encouraged to try to correct the interference by one or more of the following measures:

- Reorient or relocate the receiving antenna.
- Increase the separation between the equipment and the receiver.
- Connect the equipment into an outlet on a circuit different from that to which the receiver is connected.
- Consult the dealer or an experienced radio/TV technician for help.

LED Indicator Statement

The display LEDs meet the requirements of EN 60825-1.

この装置は、情報処理装置等電波障害自主規制協議会（VCCI）の基準に基づくクラスB情報技術装置です。この装置は、家庭環境で使用することを目的としていますが、この装置がラジオやテレビジョン受信機に近接して使用されると受信障害を引き起こすことがあります。
取り扱い説明書に従って正しい取り扱いをして下さい。

사용시 안내문 (A급 기기)

이 기기는 업무용으로 전자파장애감정을 받은 기기이오니, 만약 잘못 구입하셨을 때에는 구입한 곳에서 비업무용으로 교환하시기 바랍니다.

사용자 안내문 (B급 기기)

이 기기는 비업무용으로 전자파장애감정을 받은 기기로서, 주거지역에서는 물론 모든 지역에서 사용할 수 있습니다.

Limited Warranty Statement

	Duration of Limited Warranty
HP Product	
Ink cartridges	90 Days
Software in North America/Canada	90 Days
Software in Asia Pacific, Europe	1 Year
Software in Latin America	1 Year
Printer in North America/Canada	90 Days
Printer in Asia Pacific, Europe	1 Year
Printer in Latin America	1 Year

A. Extent of Limited Warranty

- Hewlett-Packard (HP) warrants to the end-user customer that the HP products specified above will be free from defects in materials and workmanship for the duration specified above, which duration begins on the date of purchase by the customer. Customer is responsible for maintaining proof of date of purchase.
- For software products, HP's limited warranty applies only to a failure to execute programming instructions. HP does not warrant that the operation of any product will be uninterrupted or error free.
- HP's limited warranty covers only those defects which arise as a result of normal use of the product, and do not apply to any:
 - Improper or inadequate maintenance or modification;
 - Software, interfacing, media, parts, or supplies not provided or supported by HP; or
 - Operation outside the product's specifications.
- For HP printer products, the use of a non-HP ink cartridge or a refilled ink cartridge does not affect either the warranty to the customer or any HP support contract with the customer. However, if printer failure or damage is attributable to the use of a non-HP or refilled ink cartridge, HP will charge its standard time and materials charges to service the printer for the particular failure or damage.
- If HP receives, during the applicable warranty period, notice of a defect in any software, media, or ink cartridge product which is covered by HP's warranty, HP shall replace the defective product. If HP receives, during the applicable warranty period, notice of a defect in any hardware product which is covered by HP's warranty, HP shall either repair or replace the defective product, at HP's option.
- If HP is unable to repair or replace, as applicable, a defective product which is covered by HP's warranty, HP shall, within a reasonable time after being notified of the defect, refund the purchase price for the product.
- HP shall have no obligation to repair, replace, or refund until the customer returns the defective product to HP.
- Any replacement product may be either new or like-new, provided that it has functionality at least equal to that of the product being replaced.
- HP's limited warranty is valid in any country where the covered HP product is distributed by HP except for the Middle-East, Africa, Argentina, Brazil, Mexico, Venezuela, and France's "Departements D'Outre-Mer"; for those excepted areas, the warranty is valid only in the country of purchase. Contracts for additional warranty services, such as on-site service, may be available from any authorized HP service facility where the product is distributed by HP or by an authorized importer.

B. Limitations of Warranty

- TO THE EXTENT ALLOWED BY LOCAL LAW, NEITHER HP NOR ITS THIRD PARTY SUPPLIERS MAKE ANY OTHER WARRANTY OR CONDITION OF ANY KIND, WHETHER EXPRESS OR IMPLIED, WITH RESPECT TO THE HP PRODUCTS, AND SPECIFICALLY DISCLAIM THE IMPLIED WARRANTIES OR CONDITIONS OF MERCHANTABILITY, SATISFACTORY QUALITY, AND FITNESS FOR A PARTICULAR PURPOSE.

C. Limitations of Liability

- To the extent allowed by local law, the remedies provided in this Warranty Statement are the customer's sole and exclusive remedies.
- TO THE EXTENT ALLOWED BY LOCAL LAW, EXCEPT FOR THE OBLIGATIONS SPECIFICALLY SET FORTH IN THIS WARRANTY STATEMENT, IN NO EVENT SHALL HP OR ITS THIRD PARTY SUPPLIERS BE LIABLE FOR DIRECT, INDIRECT, SPECIAL, INCIDENTAL, OR CONSEQUENTIAL DAMAGES, WHETHER BASED ON CONTRACT, TORT, OR ANY OTHER LEGAL THEORY AND WHETHER ADVISED OF THE POSSIBILITY OF SUCH DAMAGES.

D. Local Law

- This Warranty Statement gives the customer specific legal rights. The customer may also have other rights which vary from state to state in the United States, from province to province in Canada, and from country to country elsewhere in the world.
- To the extent that this Warranty Statement is inconsistent with local law, this Warranty Statement shall be deemed modified to be consistent with such local law. Under such local law, certain disclaimers and limitations of this Warranty Statement may not apply to the customer. For example, some states in the United States, as well as some governments outside the United States (including provinces in Canada), may:
 - Preclude the disclaimers and limitations in this Warranty Statement from limiting the statutory rights of a consumer (e.g., the United Kingdom);
 - Otherwise restrict the ability of a manufacturer to enforce such disclaimers or limitations; or
 - Grant the customer additional warranty rights, specify the duration of implied warranties which the manufacturer cannot disclaim, or not allow limitations on the duration of implied warranties.
- FOR CONSUMER TRANSACTIONS IN AUSTRALIA AND NEW ZEALAND, THE TERMS IN THIS WARRANTY STATEMENT, EXCEPT TO THE EXTENT LAWFULLY PERMITTED, DO NOT EXCLUDE, RESTRICT, OR MODIFY, AND ARE IN ADDITION TO, THE MANDATORY STATUTORY RIGHTS APPLICABLE TO THE SALE OF HP PRODUCTS TO SUCH CUSTOMERS.

HP Year 2000 Warranty

Subject to all of the terms and limitations of the HP Limited Warranty Statement stated above, HP warrants that this HP Product will be able to accurately process date data (including, but not limited to, calculating, comparing, and sequencing) from, into, and between the twentieth and twenty-first centuries, and the years 1999 and 2000, including leap year calculations, when used in accordance with the Product documentation provided by HP (including any instructions for installing patches or upgrades), provided that all other products (e.g. hardware, software, firmware) used in combination with such HP Product(s) properly exchange date data with it. The duration of the Year 2000 warranty extends through January 31, 2001.

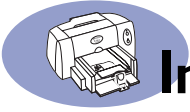

Index

A

accessories **vi**, **45**
automatic two-sided printing
layout panel **10**

B

background printing **12**, **13**
banners
choosing paper for **53**
metric sizes **53**
minimum margins **54**
best mode **10**, **52**
print speed **52**
bi-directional cable **vi**
black and white printing **11**
book binding **24**
brightness **11**
buttons
cancel **8**
OK **8**
power **1**, **27**, **29**, **50**
preview **8**
resume **1**, **22**, **35**

C

cables
ordering **45**
parallel **vi**
recommended **vi**
USB **vi**
Cancel button **8**
capacity, paper tray **vii**
card guide **2**
cards
choosing paper for **53**
metric sizes **53**
minimum margins **54**
printing **16–20**
specifications **46**
change printers **13**
change the order of print jobs **13**
cleaning
print cartridges **30**
printer **4**
color panel **11**
color tone **11**
ColorSync **11**

computer, controlling from **1**, **5**
connections
USB **5**
customer support **42**

D

default printer **5**
delete a print job **13**
desktop printing **6**
dimensions **52**
draft mode **10**, **52**
print speed **52**
drivers, *see printer software*
duty cycle **52**

E

energy usage **52**
envelopes
choosing **53**
metric sizes **53**
minimum margins **54**
printing single **17**
printing stack **18**
environment, operating **52**

F

fax printing, problems **36**
FCC statement **55**
features **vii**
foreground printing **12**

G

General panel **9**
getting help, *see help*
grayscale **11**
greeting cards
printing **16–20**

H

help
electronic **vii**
HP customer care **43**
information sources **vii**
on the printer **vii**
technical support **42**
web sites and user forums **vii**
HP color matching **11**

HP customer care **43**
HP Photo Color Kits **45**

I

I/O interface **52**
icons
printer status **6**
IN tray
capacity of **53**
index cards
printing **19–20**
ink
density **40**
ordering **45**
streaking **29**
ink cartridges
cleaning **31**
ordering **45**
installing
printer software **33**, **34**
problems **33**, **34**
software **33**
iron-on transfers
ordering **46**
printing **23**

J

jams, *see paper jams*

L

labels
choosing types to use **53**
paper jams with **35**
printing **21**
layout panel **10**
LED indicator statement **55**
lights
flashing **1**
power **1**
resume **1**, **28**

M

maintenance
print cartridges **27**
printer **4**
manual two-sided printing **24**



Index

margins
 minimums, by paper type **54**
media adjusters **2**
media size **53**
media weight, recommended **53**
media, *see paper*
metric paper sizes **53**
modes
 best **10, 52**
 draft **10, 52**
 normal **10, 52**
 printing speeds **52**

N

noise
 printer **4**
noise emissions **53**
normal mode **10, 52**
 print speed **52**

O

OK button **8**
online support, web site **vii**
operating environment **52**
ordering
 parts and accessories **47**
 supplies **45**
OUT tray **53**

P

page orientation **7**
page setup dialog box **7**
paper
 metric sizes **53**
 minimum margins, by type **54**
 specifications **53**
 supplies **46**
 weight of **53**
paper guides **2**
paper jams, clearing **35, 37**
paper size **7**
paper sizes
 and minimum margins **54**
 by paper type **53**
paper tray
 capacity **53**
paper trays
 capacity **vii**
 positions **2**
paper type/quality panel **10**
parts
 numbers **45**
 ordering **45**
 supplies **45**
pausing/holding a print job **13**
photo cartridge **45**
power
 adapter **vi**
 button **52**
 consumption **52**
 cord **vi**
 cord, ordering **45**
 light **52**
preview button **8**
print cartridges
 cleaning **29, 30, 31**
 damage from refilling **32**
 light **28**
 ordering **45**
 part numbers **45**
 problems **28, 29**
 recommended temperatures
 29
 replacement **27**
 storing **29**
 using **29**
print dialog box **8**
print margins **54**
print modes
 best **10, 52**
 draft **10, 52**
 normal **10, 52**
print problems, *see problems*
print quality **vii**
 cleaning print cartridges **29**
 improving **40**
 problems **40**
 using refilled print cartridges
 32
print speed **vii**
 best mode **52**
 draft mode **52**
 normal mode **52**
 specifications **52**
print technology **52**

printer
 accessories **vi, 45**
 cable, USB **45**
 cleaning **4**
 components **vi**
 connections **35**
 controlling **1, 5**
 dimensions **52**
 driver updates, *see software updates*
 drivers, *see printer software*
 list of parts **vi**
 maintenance **4**
 noise **4**
 online help **vii**
 package contents **vi**
 paper trays **53**
 recommended cables **vi**
 selecting default **5**
 setting up **vi**
 software **42**
 software updates **42**
 specifications **52**
 status **6**
 weight **52**
printer software
 downloading **42**
 problems installing **33**
 updates
printing
 book **24**
 business cards **19–20**
 cards **16–20**
 envelopes, single **17**
 envelopes, stack **18**
 faxes **36**
 from the desktop **6**
 greeting cards **16–20**
 index cards **19–20**
 iron-on transfers **23**
 labels **21**
 over a network **vi**
 quality **29, 40**
 stop/restart **13**
 tablet **24**
 transparencies **22**
 two-sided, book **24**



Index

printing (cont.)
two-sided, tablet **24**

printing problems **29**

printing problems, *see problems*

problems

- blank page came out of printer **36**
- CD, not reading **33**
- fax **36**
- flashing lights **37**
- help **33**
- ink streaks **29**
- installing printer software **34**
- jam **35**
- lights flashing **37**
- no page not came out **35**
- output **39, 40**
- page did not print **35**
- paper jam **35**
- parts of output in wrong place **39**
- parts of output missing **39**
- power light flashing **37**
- print cartridges **29**
- print quality **40**
- printing **35–36**
- resume light flashing **37**
- slow printer **36**
- software installation **34**
- software, not reading **33**
- too much ink **40**
- using refilled print cartridges **32**

Q

quality **vii**

- printing **29**

quick start poster

- ordering **45**

R

recycle **60**

regulatory notices **55**

resolution

- black **52**
- true type text **52**

restart printing **13**

Resume button **52**

Resume light **52**

S

saturation **11**

scaling **7**

select panel **26**

selecting a default printer **5**

setting up printer **vi**

setup

- problems **33–34**

size

- media **53**
- specifications **53**

software compatibility **52**

software, *see printer software*

sort the order of print jobs **13**

specifications **52**

speed, printing **52**

stop printing **13**

stuck paper, *see paper jams*

supplies **45**

- ordering **45**
- paper and other media **46**
- part names and numbers **45**

T

tablet binding **24**

technical support **42**

transfers, printing **23**

transparencies

- ordering **46**
- printing **22**

trays

- envelope slot **17**
- IN **2, 53**
- OUT **2, 53**

troubleshooting, *see problems*

true type text resolution **52**

two-sided printing **24**

U

updates for software **42**

urgent print requests **13**

USB connection **5**

user's guide, ordering **45**

Utility window **25, 26, 29, 30, 31**

W

warranty

- extensions **44**
- statement **56**

web site **vii**

web sites **33, 36, 45, 47**

weight

- paper **53**
- printer **52**
- recommended media **53**

Environmental Statement

Hewlett-Packard continuously improves the design processes of HP DeskJet printers to minimize the negative impact on the office environment and on the communities where printers are manufactured, shipped, and used. Hewlett-Packard has also developed processes to minimize the negative impact of the disposal of the printer at the end of printing life.

Reduction and Elimination

Paper Use: The printer's automatic/manual two-sided printing capability reduces paper usage and the resulting demands on natural resources. This printer is suited for the use of recycled papers according to DIN 19 309.

Ozone: Ozone-depleting chemicals such as CFCs have been eliminated from Hewlett-Packard manufacturing processes.

Recycling

Design for recycling has been incorporated into this printer. The number of materials has been kept to a minimum while ensuring proper functionality and reliability. Dissimilar materials have been designed to separate easily. Fasteners and other connections are easy to locate, access, and remove using common tools. High priority parts have been designed to access quickly for efficient disassembly and repair. Plastic parts have been primarily designed in no more than two colors to enhance recycling options. A few small parts are colored specifically to highlight customer access points.

Printer Packaging: The packaging materials for this printer have been selected to provide maximum protection for the least cost possible, while attempting to minimize environmental impact and facilitate recycling. The rugged design of the HP DeskJet printer assists in minimizing both packaging materials and damage rates.

Plastic parts: All major plastics and plastic parts are marked according to international standards. All plastic parts used in the printer housing and chassis are technically recyclable and all use a single polymer.

Product Longevity: To ensure the longevity of your DeskJet Printer, HP provides the following:

- **Extended Warranty - HP SupportPack** provides coverage for the HP hardware and product and all HP supplied internal components. HP SupportPack must be purchased by the customer within 30 days of purchase. Contact the nearest HP dealer about this service.
- **Spare Parts and Consumables** are available for five years after production has stopped.
- **Product Take-back -** To return this product and ink cartridges to HP at the end of its useful life, call your local HP Sales or Service Office for instructions.

Free Manuals Download Website

<http://myh66.com>

<http://usermanuals.us>

<http://www.somanuals.com>

<http://www.4manuals.cc>

<http://www.manual-lib.com>

<http://www.404manual.com>

<http://www.luxmanual.com>

<http://aubethermostatmanual.com>

Golf course search by state

<http://golfingnear.com>

Email search by domain

<http://emailbydomain.com>

Auto manuals search

<http://auto.somanuals.com>

TV manuals search

<http://tv.somanuals.com>