



# HP EliteBook 725 G4 Notebook PC

## Maintenance and Service Guide

© Copyright 2016 HP Development Company, L.P.

AMD and AMD Radeon are trademarks of Advanced Micro Devices, Inc. Bluetooth is a trademark owned by its proprietor and used by HP Inc. under license. Intel is a trademark of Intel Corporation in the U.S. and other countries. Microsoft and Windows are either registered trademarks or trademarks of Microsoft Corporation in the United States and/or other countries. Qualcomm is a trademark of Qualcomm Incorporated, registered in the United States and other countries, used with permission.

For DTS patents, see <http://patents.dts.com>. Manufactured under license from DTS Licensing Limited. DTS, the Symbol, & DTS and the Symbol together are registered trademarks, and DTS Studio Sound is a trademark of DTS, Inc. © DTS, Inc. All Rights

Reserved  .

#### Product notice

This guide describes features that are common to most models. Some features may not be available on your computer.

Not all features are available in all editions of Windows 10 or Windows 8. This computer may require upgraded and/or separately purchased hardware, drivers and/or software to take full advantage of Windows 10 or Windows 8 functionality. See <http://www.microsoft.com> for details.

The information contained herein is subject to change without notice. The only warranties for HP products and services are set forth in the express warranty statements accompanying such products and services. Nothing herein should be construed as constituting an additional warranty. HP shall not be liable for technical or editorial errors or omissions contained herein.

First Edition: December 2016

Document Part Number: 902318-001

## Important Notice about Customer Self-Repair Parts

---

 **CAUTION:** Your computer includes Customer Self-Repair parts and parts that should only be accessed by an authorized service provider. See Chapter 5, "Removal and replacement procedures for Customer Self-Repair parts," for details. Accessing parts described in Chapter 6, "Removal and replacement procedures for Authorized Service Provider only parts," can damage the computer or void your warranty.

---



## Safety warning notice

---

 **WARNING!** To reduce the possibility of heat-related injuries or of overheating the device, do not place the device directly on your lap or obstruct the device air vents. Use the device only on a hard, flat surface. Do not allow another hard surface, such as an adjoining optional printer, or a soft surface, such as pillows or rugs or clothing, to block airflow. Also, do not allow the AC adapter to contact the skin or a soft surface, such as pillows or rugs or clothing, during operation. The device and the AC adapter comply with the user-accessible surface temperature limits defined by the International Standard for Safety of Information Technology Equipment (IEC 60950-1).

---



---

# Table of contents

<b>1 Product description .....</b>	<b>1</b>
<b>2 External component identification .....</b>	<b>6</b>
Right .....	6
Left .....	8
Display .....	9
Top .....	10
TouchPad .....	10
Lights .....	11
Button, speakers, and fingerprint reader .....	12
Keys .....	13
Bottom .....	14
Front .....	15
<b>3 Illustrated parts catalog .....</b>	<b>16</b>
Service label .....	16
Computer major components .....	17
Display assembly subcomponents .....	22
Plastics Kit .....	23
Cable Kit .....	24
Mass storage devices .....	25
Miscellaneous parts .....	26
<b>4 Removal and replacement procedures preliminary requirements .....</b>	<b>28</b>
Tools required .....	28
Service considerations .....	28
Plastic parts .....	28
Cables and connectors .....	29
Drive handling .....	29
Grounding guidelines .....	30
Electrostatic discharge damage .....	30
Packaging and transporting guidelines .....	31
Workstation guidelines .....	31
Equipment guidelines .....	32

<b>5 Removal and replacement procedures for Customer Self-Repair parts .....</b>	<b>33</b>
Component replacement procedures .....	33
Bottom cover .....	33
Battery .....	36
Hard drive .....	37
Solid-state drive .....	38
Memory modules .....	40
WLAN module .....	42
WWAN module .....	44
Keyboard .....	46
<b>6 Removal and replacement procedures for Authorized Service Provider parts .....</b>	<b>49</b>
Component replacement procedures .....	49
System board .....	49
RTC battery .....	52
Heat sink/fan assembly .....	53
Fingerprint reader assembly .....	55
TouchPad button board .....	56
NFC module .....	57
Smart card reader board .....	58
Speaker assembly .....	59
Display assembly .....	59
<b>7 Computer Setup (BIOS), TPM, and HP Sure Start in Windows 10 .....</b>	<b>66</b>
Using Computer Setup .....	66
Starting Computer Setup .....	66
Navigating and selecting in Computer Setup .....	66
Restoring factory settings in Computer Setup .....	67
Updating the BIOS .....	68
Determining the BIOS version .....	68
Downloading a BIOS update .....	68
Changing the boot order using the f9 prompt .....	69
TPM BIOS settings (select products only) .....	69
Using HP Sure Start (select products only) .....	70
<b>8 HP PC Hardware Diagnostics (UEFI) .....</b>	<b>71</b>
Downloading HP PC Hardware Diagnostics (UEFI) to a USB device .....	71
<b>9 Backing up and recovering Windows 10 .....</b>	<b>73</b>
Creating recovery media and backups .....	73



Creating HP Recovery media (select products only) .....	73
Using Windows tools .....	74
Restore and recovery .....	75
Recovering using HP Recovery Manager .....	75
What you need to know before you get started .....	75
Using the HP Recovery partition (select products only) .....	76
Using HP Recovery media to recover .....	76
Changing the computer boot order .....	77
Removing the HP Recovery partition (select products only) .....	78
<b>10 Specifications .....</b>	<b>79</b>
Input power .....	79
Operating environment .....	79
<b>11 Power cord set requirements .....</b>	<b>80</b>
Requirements for all countries .....	80
Requirements for specific countries and regions .....	80
<b>12 Statement of memory volatility .....</b>	<b>82</b>
Nonvolatile memory usage .....	84
Questions and answers .....	86
Using HP Sure Start (select models only) .....	87
<b>13 Recycling .....</b>	<b>88</b>
<b>Index .....</b>	<b>89</b>



# 1 Product description

Category	Description
<b>Product Name</b>	HP EliteBook 725 G4 Notebook PC
<b>Processors</b>	<ul style="list-style-type: none"><li>• AMD™ A12 Pro-9800B 2.70-GHz (max turbo frequency 3.60-GHz) processor, DDR4-1866, 2.0-MB L2 cache, 15 W</li><li>• AMD A12 Pro-8830B 2.50-GHz (max turbo frequency 3.40-GHz) processor, DDR4-1866, 2.0-MB L2 cache, 15 W</li><li>• AMD A10 Pro-8730B 2.40-GHz (max turbo frequency 3.30-GHz) processor, DDR4-1866, 2.0-MB L2 cache, 15 W</li><li>• AMD A8 Pro-9600B 2.40-GHz (max turbo frequency 3.30-GHz) processor, DDR4-1866, 2.0-MB L2 cache, 15 W</li></ul>
<b>Chipset</b>	Integrated with processor
<b>Graphics</b>	<p><b>Internal graphics:</b></p> <p>AMD UMA graphics (with shared video memory)</p> <p>AMD Vivid Color Support</p> <p>Dual-display ports supported through docking solution</p> <p>Up to three independent displays supported with docking solution</p> <ul style="list-style-type: none"><li>• AMD Radeon™ R7 (only on computer models equipped with an AMD A12 Pro-9800B or AMD A12 Pro-8830B processor)</li><li>• AMD Radeon R5 (only on computer models equipped with an AMD A10 Pro-8730B or AMD A8 Pro-9600B processor)</li></ul>
<b>Panel</b>	<p><b>12.5 in</b> (31.75 cm), high-definition (HD), Slim eDP (1366×768), SVA AG, typical brightness: 220 cd/m2 (nits) with and without webcam</p> <p><b>12.5 in</b> (31.75 cm), full high-definition (FHD), UltraSlim eDP (1920×1080), UWVA AG, typical brightness: 300 cd/m2 (nits) with and without webcam</p> <p><b>12.5 in</b> (31.75 cm), full high-definition (FHD), UltraSlim eDP (1920×1080) UWVA AG, typical brightness: 300 cd/m2 (nits) with touch and webcam</p>
<b>Memory</b>	<p>Two SODIMM customer-accessible/upgradable memory module slots</p> <p>Supports up to 16 GB of system RAM</p> <p>DDR4 -1866 (2400-MHz, 1.2-V) dual channel support</p> <p>Supports the following configurations:</p> <ul style="list-style-type: none"><li>• 16384 MB (8192 MB×2)</li><li>• 8192 MB (8192 MB×1 or 4096 MB×2)</li><li>• 4096 MB (4096 MB×1)</li></ul>
<b>Hard drive</b>	<p><b>Hard drive:</b></p> <p>Supports <b>6.35 cm</b> (2.5 in) hard drives in <b>7.0 mm</b> (.28 in) thicknesses (all hard drives use the same bracket)</p> <p>Serial ATA</p> <ul style="list-style-type: none"><li>• 1 TB, 5400 rpm, 7.0 mm</li></ul>

Category	Description
<b>Hard drive</b> <i>(continued)</i>	<ul style="list-style-type: none"> <li>• 500 GB, 7200 rpm, 7.0 mm</li> <li>• 500 GB, 7200 rpm, 7.0 mm, self-encrypting drive (SED; FIPS-140-2; Opal 2)</li> <li>• 500 GB, 7200 rpm, 7.0 mm, SED (Opal 2)</li> <li>• 500 GB, 7.0 mm, hybrid, 8 GB cache</li> </ul> <p><b>Solid-state drive:</b></p> <ul style="list-style-type: none"> <li>• 512-GB, Turbo Drive, G2, triple-level cell (TLC)</li> <li>• 360-GB, PCIe, TLC</li> <li>• 256-GB, Turbo Drive, G2, TLC</li> <li>• 256-GB, SATA-3, SED, OPAL, TLC</li> <li>• 128-GB, M.2, SATA-3</li> </ul>
<b>Audio and video</b>	<p>Supports:</p> <ul style="list-style-type: none"> <li>• DTS Studio Sound</li> <li>• Conexant smart amplifier and ambient noise suppression</li> <li>• Dual-array microphone</li> <li>• Dual speakers</li> <li>• Webcam (720p)</li> </ul>
<b>Ethernet</b>	<p>Broadcom 5762 10/100/1000 Ethernet NIC with DASH Support</p> <p>S3/S4/S5 Wake-on-LAN</p>
<b>Wireless</b>	<p><b>WLAN:</b></p> <p>Integrated wireless local area network (WLAN) options by way of wireless module</p> <p>Two WLAN antennas built into display assembly</p> <p>Integrated wireless personal area network (PAN) supported by Bluetooth® 4.0 or Bluetooth 4.2 combo card</p> <p>Compatible with Miracast-certified devices</p> <p>Support for the following WLAN formats:</p> <ul style="list-style-type: none"> <li>• Intel Dual Band Wireless-AC 7265 802.11 AC 2×2 WiFi + Bluetooth 4.2 Combo Adapter (non-vPro)</li> <li>• Intel Dual Band Wireless-AC 3168 802.11 AC 1×1 WiFi + Bluetooth 4.2 Combo Adapter</li> <li>• Realtek RTL8723BE b/g/n 1×1 + Bluetooth 4.0 LE PCIe + USB M.2 Combo Adapter</li> </ul> <p>Supports no WLAN option</p> <p><b>NFC:</b></p> <p>Supports the Integrated NFC NXP NPC100 12C NCI 10-mm × 25-mm module</p> <p>NFC antenna</p> <p>Supports no NFC option</p> <p><b>WWAN:</b></p> <p>Integrated wireless wide area network (WWAN) options by way of wireless module</p> <p>Two WWAN antennas built into display assembly</p> <p>Supports the following WWAN formats:</p> <ul style="list-style-type: none"> <li>• HP hs3210 WW HSPA+</li> </ul>

Category	Description
<b>Wireless</b> <i>(continued)</i>	<ul style="list-style-type: none"> <li>HP It4132 LTE/HSPA+ with GPS M.2 WWAN module</li> <li>HP It4120 LTE/EVDO/HSPA+ with GPS M.2</li> </ul> Supports no WWAN option
<b>External media cards</b>	SIM card reader Memory card reader (SD, SDHC, SDXC)
<b>Ports</b>	VGA USB 3.1 charging USB 3.1 USB Type-C DisplayPort RJ-45 Docking connector Audio-out (headphone)/audio-in (microphone) combo jack AC port
<b>Keyboard/pointing devices</b>	<b>Keyboard:</b> Dura keys, backlit, spill resistant with drain Spill resistant with drain <b>TouchPad:</b> Gestures enabled by default: two-finger scrolling, two-finger pinch-zoom Taps enabled by default On/off button Glass
<b>Power requirements</b>	3-cell, 49-WHr, 4.25-AHr, Li-ion battery 65-W, HP Smart AC adapter 45-W, HP Smart AC adapter 45-W, 2-prong AC adapter
<b>Security</b>	Security lock Fingerprint reader Supports Trusted Platform Module (TPM) 1.2 or 2.0 (Infineon, soldered down) Integrated Smart Card reader (active) Preboot authentication (password, smart card)
<b>Operating system</b>	<b>Preinstalled:</b> <ul style="list-style-type: none"> <li>Windows 10 Home 64-bit (not available on computer models equipped with an FHD or higher resolution display assembly and 8-GB or more system memory)</li> <li>Windows 10 Home 64-bit Chinese Market (CPPP; not available on computer models equipped with an FHD or higher resolution display assembly and 8-GB or more system memory)</li> <li>Windows 10 Home 64-bit Chinese Market High-End (CPPP; only available on computer models equipped with an FHD or higher resolution display assembly and 8-GB or more system memory)</li> </ul>

Category	Description
<b>Operating system</b> <i>(continued)</i>	<p><b>Preinstalled:</b></p> <ul style="list-style-type: none"> <li>Windows 10 Home 64-bit High-End (only available on computer models equipped with an FHD or higher resolution display assembly and 8-GB or more system memory)</li> <li>Windows 10 Home 64-bit High-End Single Language (only available on computer models equipped with an FHD or higher resolution display assembly and 8-GB or more system memory)</li> <li>Windows 10 Home 64-bit Single Language (not available on computer models equipped with an FHD or higher resolution display assembly and 8-GB or more system memory)</li> <li>Windows 10 Professional 64-bit</li> <li>Windows 10 Professional 64-bit – StF MSNA – High-End (only available on computer models equipped with an FHD or higher resolution display assembly and 8-GB or more system memory)</li> <li>Windows 10 Professional 64-bit – StF MSNA – Standard (not available on computer models equipped with an FHD or higher resolution display assembly and 8-GB or more system memory)</li> <li>Windows 10 Professional 64-bit Downgrade Windows 7 64-bit</li> <li>Windows 10 Professional 64-bit Downgrade Windows 7 64-bit – StF MSNA – High-End (only available on computer models equipped with an FHD or higher resolution display assembly and 8-GB or more system memory)</li> <li>Windows 10 Professional 64-bit Downgrade Windows 7 64-bit – StF MSNA – Standard (not available on computer models equipped with an FHD or higher resolution display assembly and 8-GB or more system memory)</li> <li>Windows 10 Professional 64-bit Downgrade Windows 7 64-bit - Volume License</li> <li>Windows 7 Home Basic 64-bit - CPPP (only available on computer models with country loc = "PRC")</li> <li>Windows 7 Professional 64-bit (not available on computer models equipped with a TouchScreen display assembly)</li> <li>FreeDOS 2.0</li> </ul> <hr/> <p><b>Restore Media:</b></p> <p><b>DRDVD:</b> Windows 10 DRDVD (available with any Windows 10 operating system; required with any Windows 10 downgrade operating system) and Windows 7 DRDVD (available with any Windows 10 Professional downgrade)</p> <p><b>DRUSB:</b> Windows 10 DRUSB (for service only)</p> <p><b>OSDVD:</b></p> <ul style="list-style-type: none"> <li>Windows 10 Home 64-bit OSDVD (for service only)</li> <li>Windows 10 Professional 64-bit OSDVD (required with any Windows 10 operating system)</li> <li>Windows 7 Professional 64-bit OSDVD (available with any Windows 10 Professional downgrade LOC except Asian countries and regions and the People's Republic of China)</li> </ul> <p><b>OSUSB:</b> Windows 10 Professional 64-bit OSUSB (for service only)</p> <hr/> <p><b>Certified:</b> Microsoft® WHQL</p> <hr/> <p><b>Tested and documented:</b> Windows 7 Enterprise 64-bit and Windows 7 Professional 64-bit</p> <hr/> <p><b>Web-only support:</b></p> <ul style="list-style-type: none"> <li>Windows 10 Enterprise</li> <li>Windows 10 Enterprise 64-bit LTSB</li> <li>Windows 7 Enterprise 64-bit</li> </ul>

---





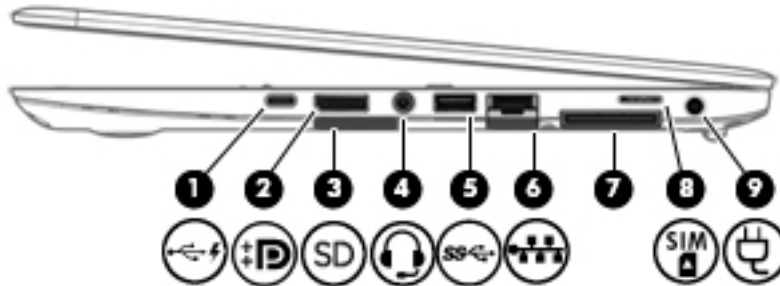

<b>Category</b>	<b>Description</b>
<b>Operating system</b> <i>(continued)</i>	<b>Web-only support:</b> <ul style="list-style-type: none"><li>• Windows 7 Professional 64-bit</li></ul>
<b>Serviceability</b>	<b>End user replaceable parts:</b> <ul style="list-style-type: none"><li>• AC adapter</li><li>• Battery</li><li>• Hard drive</li><li>• Keyboard</li><li>• Memory module</li><li>• Solid-state drive</li><li>• WLAN module</li><li>• WWAN module</li></ul>

---



## 2 External component identification

### Right







Component	Description
(1)  USB Type-C (charging) port	<p>Connects any USB device with a Type-C connector.</p> <p><b>NOTE:</b> USB Type-C ports charge products such as cell phones, laptops, tablets, and MP3 players, even when the computer is off. Also, some USB Type-C ports connect DisplayPort, VGA, HDMI and other video devices to provide video output.</p> <p><b>NOTE:</b> Adapters (purchased separately) may be required.</p>
(2)  Dual-Mode DisplayPort	Connects an optional digital display device, such as a high-performance monitor or projector.
(3)  Memory card reader	Reads optional memory cards that store, manage, share, or access information.
(4)  Audio-out (headphone)/Audio-in (microphone) combo jack	<p>Connects optional powered stereo speakers, headphones, earbuds, a headset, or a television audio cable. Also connects an optional headset microphone. This jack does not support optional microphone-only devices.</p> <p><b>WARNING!</b> To reduce the risk of personal injury, adjust the volume before putting on headphones, earbuds, or a headset. For additional safety information, refer to the <i>Regulatory, Safety, and Environmental Notices</i>.</p> <p>To access this guide:</p> <p>Select the <b>Start</b> button, select <b>All apps</b>, select <b>HP Help and Support</b>, and then select <b>HP Documentation</b>.</p> <p><b>NOTE:</b> When a device is connected to the jack, the computer speakers are disabled.</p>
(5)  USB 3.1 port	Connects an optional USB device, such as a keyboard, mouse, external drive, printer, scanner or USB hub.
(6)  RJ-45 (network) jack/status lights	<p>Connects a network cable.</p> <ul style="list-style-type: none"> <li>• Green (left): The network is connected.</li> <li>• Amber (right): Activity is occurring on the network.</li> </ul>

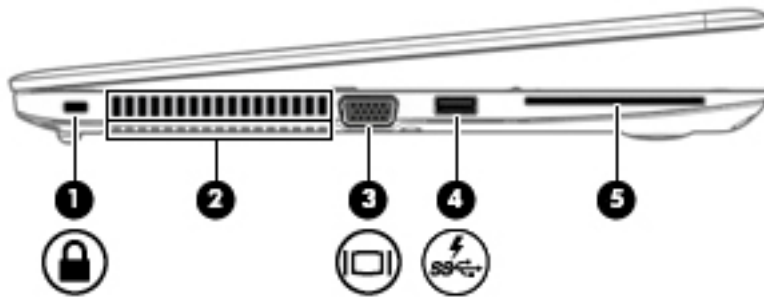

Component	Description
(7) Docking connector	Connects an optional docking device.
(8)  SIM card slot	Supports a wireless subscriber identity module (SIM) card.
(9)  Power connector	Connects an AC adapter.

## Left



Component	Description
(1)  Security cable slot	Attaches an optional security cable to the computer. <b>NOTE:</b> The security cable is designed to act as a deterrent, but it may not prevent the computer from being mishandled or stolen.
(2) Vents (2)	Enable airflow to cool internal components. <b>NOTE:</b> The computer fan starts up automatically to cool internal components and prevent overheating. It is normal for the internal fan to cycle on and off during routine operation.
(3)  External monitor port	Connects an external VGA monitor or projector.
(4)  USB 3.1 charging (powered) port	Connects an optional USB device, such as a keyboard, mouse, external drive, printer, scanner or USB hub. Standard USB ports will not charge all USB devices or will charge using a low current. Some USB devices require power and require you to use a powered port. <b>NOTE:</b> USB charging ports can also charge select models of cell phones and MP3 players, even when the computer is off.
(5) Smart card reader	Supports optional smart cards.

# Display



Component	Description
(1) WLAN antennas*	Send and receive wireless signals to communicate with wireless local area networks (WLANs).
(2) WWAN antennas*	Send and receive wireless signals to communicate with wireless wide area networks (WWANs).
(3) Internal microphones	Record sound.
(4) Webcam light	On: The webcam is in use.
(5) Webcam	Records video and captures photographs. Some models allow you to video conference and chat online using streaming video. To use the webcam: ▲ Type <code>camera</code> in the taskbar search box, and then select <b>Camera</b> .

\*The antennas are not visible from the outside of the computer. For optimal transmission, keep the areas immediately around the antennas free from obstructions.

For wireless regulatory notices, see the section of the *Regulatory, Safety, and Environmental Notices* that applies to your country or region.

To access this guide:

Select the **Start** button, select **All apps**, select **HP Help and Support**, and then select **HP Documentation**.

# Top



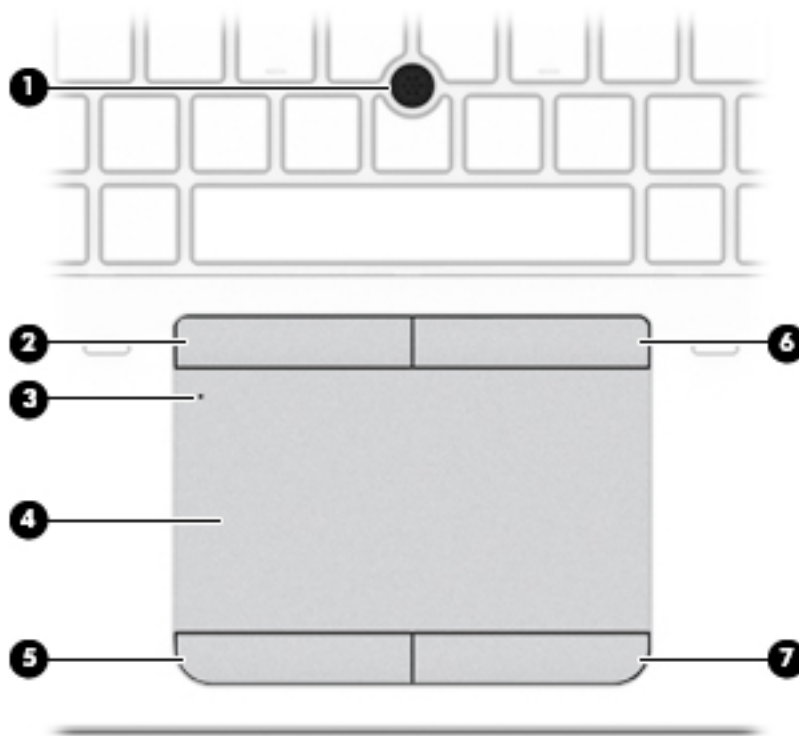

## TouchPad

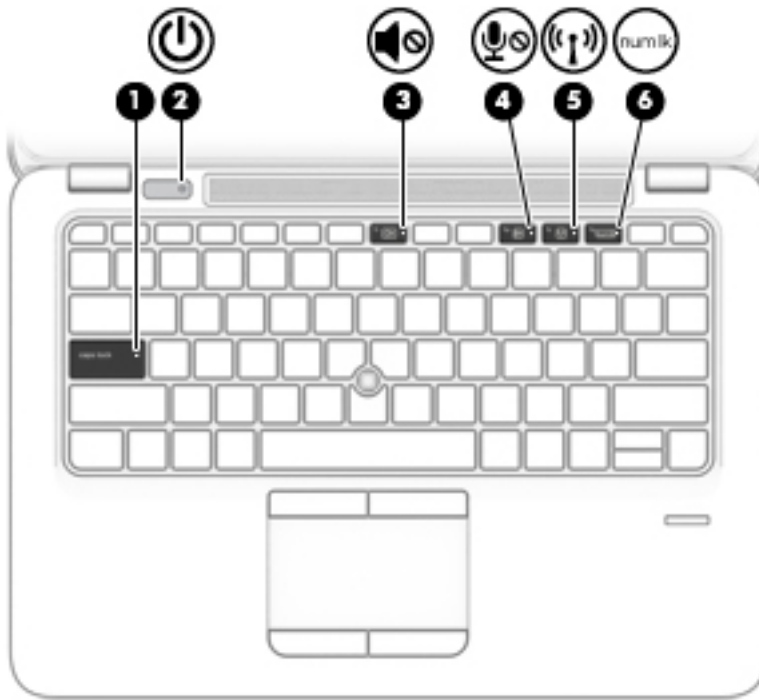

Component	Description
(1) Pointing stick (select products only)	Moves the pointer and selects or activates items on the screen.
(2) Left pointing stick button (select products only)	Functions like the left button on an external mouse.
(3) TouchPad on/off button/TouchPad light	Turns the TouchPad on and off. <ul style="list-style-type: none"><li>• On: The TouchPad is off.</li><li>• Off: The TouchPad is on.</li></ul>
(4) TouchPad zone	Reads your finger gestures to move the pointer or activate items on the screen.
(5) Left TouchPad button	Functions like the left button on an external mouse.
(6) Right pointing stick button (select products only)	Functions like the right button on an external mouse.
(7) Right TouchPad button	Functions like the right button on an external mouse.

## Lights



Component	Description
(1) Caps lock light	On: Caps lock is on, which switches the key input to all capital letters.
(2)  Power light	<ul style="list-style-type: none"> <li>On: The computer is on.</li> <li>Blinking: The computer is in the Sleep state, a power-saving state. The computer shuts off power to the display and other unneeded components.</li> <li>Off: The computer is off or in Hibernation. Hibernation is a power-saving state that uses the least amount of power.</li> </ul>
(3)  Volume mute light	<ul style="list-style-type: none"> <li>Amber: Computer sound is off.</li> <li>Off: Computer sound is on.</li> </ul>
(4)  Microphone mute light	<ul style="list-style-type: none"> <li>Amber: microphone sound is off.</li> <li>Off: microphone sound is on.</li> </ul>
(5)  Wireless light	<p>On: An integrated wireless device, such as a wireless local area network (WLAN) device and/or a Bluetooth® device, is on.</p> <p><b>NOTE:</b> On some models, the wireless light is amber when all wireless devices are off.</p>
(6) num lk Num lock light	On: Num lock is on.

## Button, speakers, and fingerprint reader

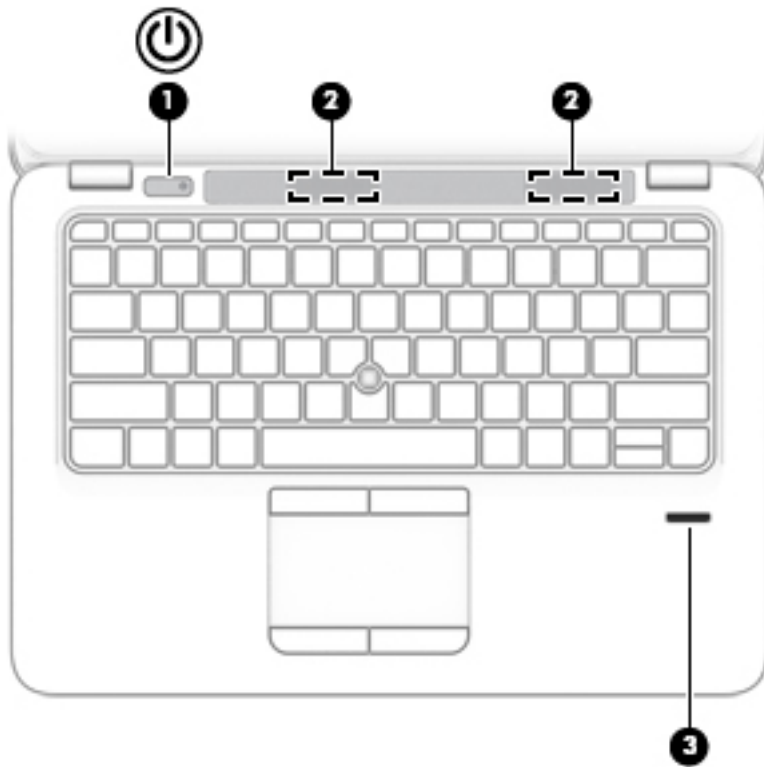

Component	Description
<p>(1)  Power button</p>	<ul style="list-style-type: none"> <li>• When the computer is off, press the button to turn on the computer.</li> <li>• When the computer is on, press the button briefly to initiate Sleep.</li> <li>• When the computer is in the Sleep state, press the button briefly to exit Sleep.</li> <li>• When the computer is in Hibernation, press the button briefly to exit Hibernation.</li> </ul> <p><b>CAUTION:</b> Pressing and holding down the power button results in the loss of unsaved information.</p> <p>If the computer has stopped responding and shutdown procedures are ineffective, press and hold the power button for at least 15 seconds to turn off the computer.</p> <p>To learn more about your power settings, see your power options.</p> <p>▲ Type <code>power</code> in the taskbar search box, and then select <b>Power and sleep settings</b>.</p> <p>– or –</p> <p>Right-click the <b>Start</b> button, and then select <b>Power Options</b>.</p>
<p>(2) Speakers</p>	<p>Produce sound.</p>
<p>(3) Fingerprint reader (select products only)</p>	<p>Allows a fingerprint logon to Windows, instead of a password logon.</p>

## Keys

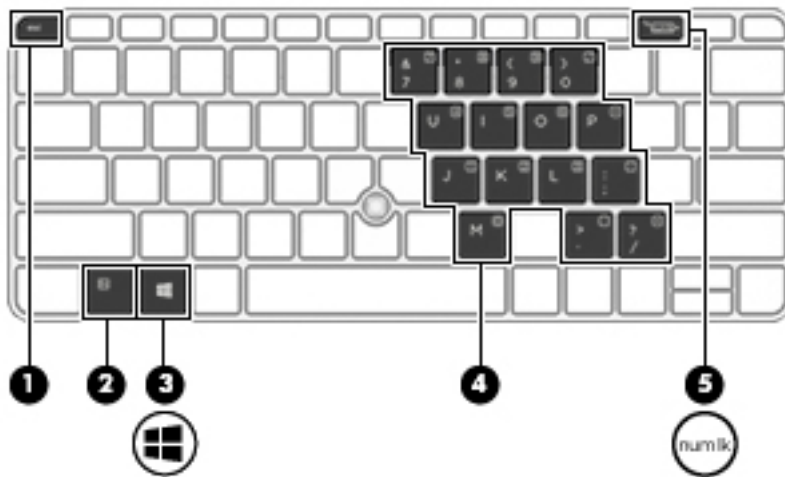

Component	Description
(1) <code>esc</code> key	Displays system information when pressed in combination with the <code>fn</code> key.
(2) <code>fn</code> key	Executes frequently used system functions when pressed in combination with a function key, the <code>num lock</code> key, or the <code>esc</code> key.
(3)  Windows key	Opens the <b>Start</b> menu. <b>NOTE:</b> Pressing the Windows key again will close the <b>Start</b> menu.
(4) Embedded numeric keypad	A numeric keypad superimposed over the keyboard alphabet keys that enables you to add, subtract, and perform other numeric tasks. When <code>num lock</code> is on, the keypad can be used like an external numeric keypad.
(5) <code>num lk</code> <code>num lock</code> key	Turns the embedded numeric keypad on and off.

## Bottom

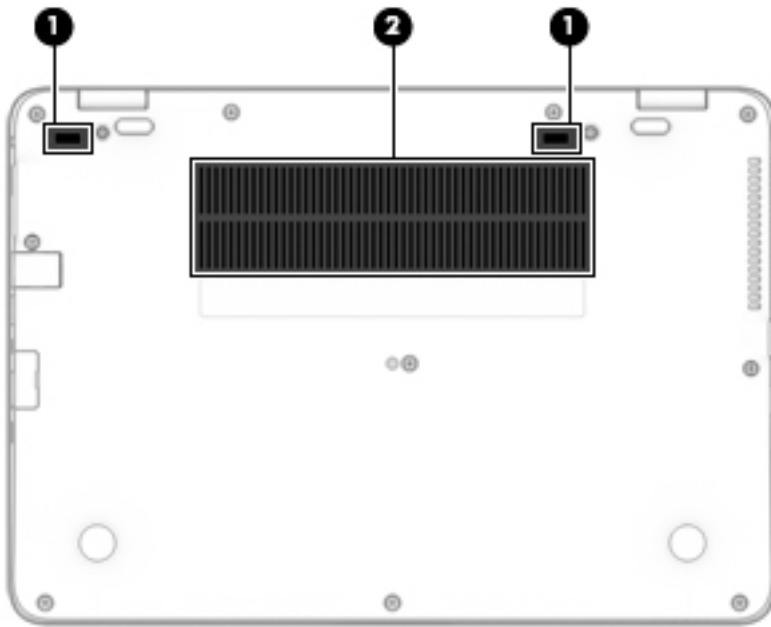





Component	Description
(1) Docking connector	Connects an optional docking device.
(2) Vents (2)	Enable airflow to cool internal components.

**NOTE:** The computer fan starts up automatically to cool internal components and prevent overheating. It is normal for the internal fan to cycle on and off during routine operation.



# Front



Component	Description
(1)  Wireless light	<p>On: An integrated wireless device, such as a wireless local area network (WLAN) device and/or a Bluetooth® device, is on.</p> <p><b>NOTE:</b> On some models, the wireless light is amber when all wireless devices are off.</p>
(2)  Power light	<ul style="list-style-type: none"> <li>On: The computer is on.</li> <li>Blinking: The computer is in the Sleep state, a power-saving state. The computer shuts off power to the display and other unneeded components.</li> <li>Off: The computer is off or in Hibernation. Hibernation is a power-saving state that uses the least amount of power.</li> </ul>
(3)  Battery light	<p>When AC power is connected:</p> <ul style="list-style-type: none"> <li>White: The battery charge is greater than 90 percent.</li> <li>Amber: The battery charge is from 0 to 90 percent.</li> <li>Off: The battery is not charging.</li> </ul> <p>When AC power is disconnected (battery not charging):</p> <ul style="list-style-type: none"> <li>Blinking amber: The battery has reached a low battery level. When the battery has reached a critical battery level, the battery light begins blinking rapidly.</li> <li>Off: The battery is not charging.</li> </ul>
(4)  Drive light	<ul style="list-style-type: none"> <li>Blinking white: The hard drive is being accessed.</li> <li>Amber: HP 3D DriveGuard has temporarily parked the hard drive.</li> </ul>

## 3 Illustrated parts catalog

### Service label

When ordering parts or requesting information, provide the computer serial number and model number provided on the service tag.

Important system information is located on the bottom of the computer. This information may be needed when travelling internationally or when contacting support:

- (1): Serial number
- (2): Product number
- (3): Model number
- (4): Warranty period

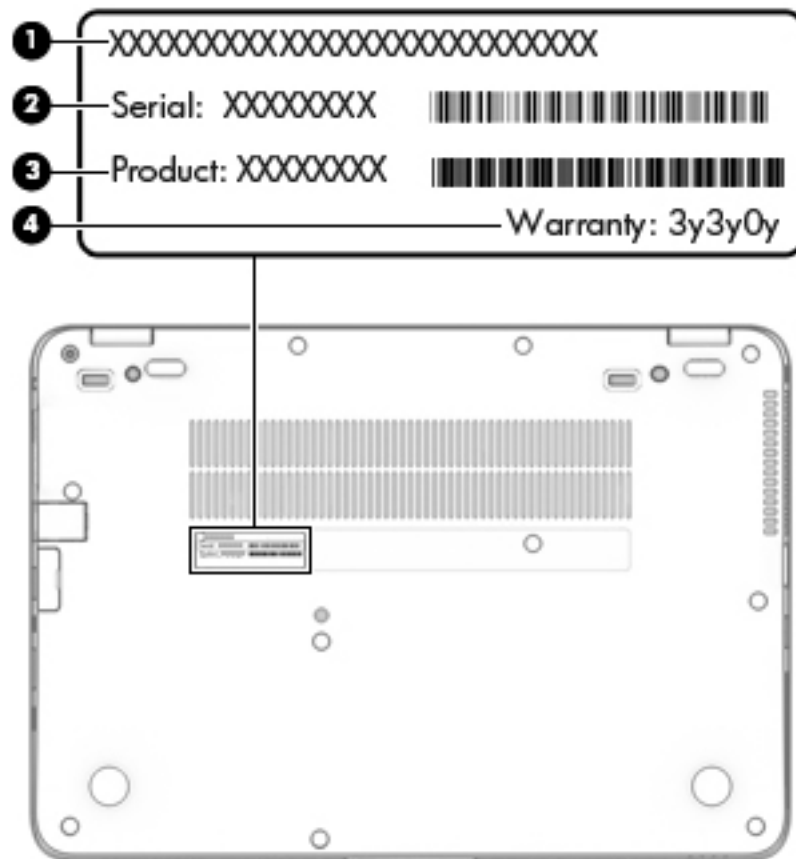

Using Windows, briefly press the **fn+esc** key combination to display the System Information screen, which provides the product name and serial number of your computer, as well as information about the memory, processor, BIOS, and keyboard.

# Computer major components

 **NOTE:** HP continually improves and changes product parts. For complete and current information on supported parts for your computer, go to <http://partsurfer.hp.com>, select your country or region, and then follow the on-screen instructions.

 **NOTE:** Details about your computer, including model, serial number, product key, and length of warranty, are on the service tag at the bottom of your computer. See [Service label on page 16](#) for details.

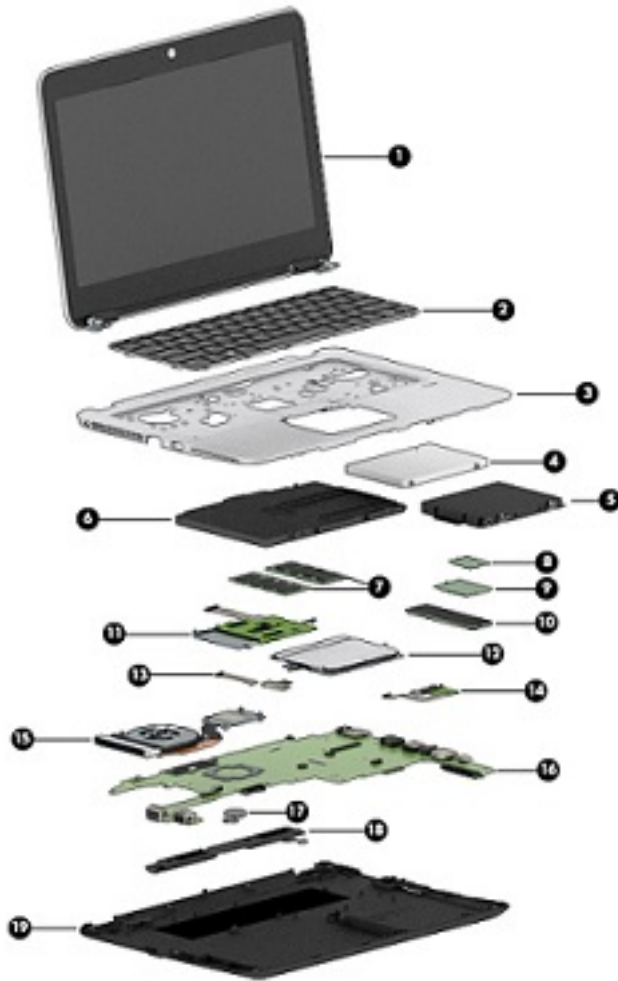

Item	Component	Spare part number
(1)	12.5-in, FHD (1920×1080), ultraslim eDP, UWVA, TouchScreen display assembly	920050-001
<b>NOTE:</b> Non-TouchScreen display assemblies are spared at the subcomponent level only. For non-TouchScreen display assembly spare part information, see <a href="#">Display assembly subcomponents on page 22</a> .		
(2)	<b>Keyboard</b> with backlight and pointing stick (includes backlight cable, keyboard cable, and pointing stick cable)	
	For use in Belgium	826630-A41
	For use in Brazil	826630-201
	For use in Bulgaria	826630-261
	For use in Canada	826630-DB1

<b>Item</b>	<b>Component</b>	<b>Spare part number</b>
	For use in the Czech Republic and Slovakia	826630-FL1
	For use in Denmark	826630-081
	For use in Denmark, Finland, and Norway	826630-DH1
	For use in France	826630-051
	For use in Germany	826630-041
	For use in Greece	826630-151
	For use in Hungary	826630-211
	For use in Iceland	826630-DD1
	For use in India	826630-D61
	For use in Israel	826630-BB1
	For use in Italy	826630-061
	For use in Japan	826630-291
	For use in Latin America	826630-161
	For use in the Netherlands	826630-B31
	For use in Northwest Africa	826630-FP1
	For use in Norway	826630-091
	For use in Portugal	826630-131
	For use in Romania	826630-271
	For use in Russia	826630-251
	For use in Saudi Arabia	826630-171
	For use in Slovenia	826630-BA1
	For use in South Korea	826630-AD1
	For use in Spain	826630-071
	For use in Sweden and Finland	826630-B71
	For use in Switzerland	826630-BG1
	For use in Taiwan	826630-AB1
	For use in Thailand	826630-281
	For use in Turkey	826630-141
	For use in Turkey F-style	826630-541
	For use in the United Kingdom	826630-031
	For use in the United States	826630-001
<b>(2)</b>	<b>Keyboard with pointing stick (includes keyboard cable and pointing stick cable)</b>	
	For use in Belgium	826631-A41
	For use in Brazil	826631-201

<b>Item</b>	<b>Component</b>	<b>Spare part number</b>
	For use in Bulgaria	826631-261
	For use in Canada	826631-DB1
	For use in the Czech Republic and Slovakia	826631-FL1
	For use in Denmark	826631-081
	For use in Denmark, Finland, and Norway	826631-DH1
	For use in France	826631-051
	For use in Germany	826631-041
	For use in Greece	826631-151
	For use in Hungary	826631-211
	For use in Iceland	826631-DD1
	For use in India	826631-D61
	For use in Israel	826631-BB1
	For use in Italy	826631-061
	For use in Japan	826631-291
	For use in Latin America	826631-161
	For use in the Netherlands	826631-B31
	For use in Northwest Africa	826631-FP1
	For use in Norway	826631-091
	For use in Portugal	826631-131
	For use in Romania	826631-271
	For use in Russia	826631-251
	For use in Saudi Arabia	826631-171
	For use in South Korea	826631-AD1
	For use in Slovenia	826631-BA1
	For use in Spain	826631-071
	For use in Sweden and Finland	826631-B71
	For use in Switzerland	826631-BG1
	For use in Taiwan	826631-AB1
	For use in Thailand	826631-281
	For use in Turkey	826631-141
	For use in Turkey F-style	826631-541
	For use in the United Kingdom	826631-031
	For use in the United States	826631-001
<b>(3)</b>	<b>Top cover</b> (includes power button actuator)	821692-001

<b>Item</b>	<b>Component</b>	<b>Spare part number</b>
<b>(4)</b>	<b>Hard Drive Hardware Kit</b> (includes hard drive connector cable, hard drive rubber bracket, and screws)	821665-001
<b>(5)</b>	<b>Hard drive</b> (does not include hard drive connector cable or hard drive rubber bracket):	
	1-TB, 5400-rpm, 7.0-mm	762990-001
	500-GB, 7200-rpm, 7.0-mm	703267-001
	500-GB, 7200-rpm, 7.0-mm, FIPS	820572-001
	500-GB, 7200-rpm, 7.0-mm, SED	820573-001
<b>(6)</b>	<b>Battery</b> (3-cell, 49-WHr, 4.25-AHr, Li-ion)	854109-850
<b>(7)</b>	<b>Memory modules</b> (2; PC4-1866, 2400-MHz, DDR4, 1.2-V):	
	8-GB	862398-850
	4-GB	862397-855
<b>(8)</b>	<b>WLAN module:</b>	
	Realtek RTL8723BE-VB 802.11b/g/n 1×1 WiFi + Bluetooth 4.0 Combo Adapter	843338-001
	Intel Dual Band Wireless-AC 3168 802.11 AC 1×1 WiFi + Bluetooth 4.2 Combo Adapter	852511-001
	Intel Dual Band Wireless-AC 7265 802.11 AC 2×2 WiFi + Bluetooth 4.2 Combo Adapter (non-vPro)	860883-001
<b>(9)</b>	<b>WWAN module:</b>	
	HP hs3210 WW HSPA+	860726-001
	HP It4132 LTE/HSPA+ with GPS M.2 WWAN module	845710-001
	HP It4120 LTE/EVDO/HSPA+ with GPS M.2	800870-001
<b>(10)</b>	<b>Solid-state drive:</b>	
	512-GB, Turbo Drive, G2, TLC	915943-001
	360-GB, PCIe, TLC	915941-001
	256-GB, Turbo Drive, G2, TLC	915939-001
	256-GB, SATA-3, SED, OPAL, TLC	915940-001
	128-GB, M.2, SATA-3	915938-001
<b>(11)</b>	<b>Smart card reader board</b> (includes cable)	914963-001
<b>(12)</b>	<b>TouchPad button board</b>	
	Equipped with NFC antenna	821667-001
	Not equipped with NFC antenna	821668-001
<b>(13)</b>	<b>NFC module</b>	821666-001
<b>(14)</b>	<b>Fingerprint reader board</b> (includes cable, bracket, and bezel)	821693-001
<b>(15)</b>	<b>Fan/heat sink assembly</b>	821691-001
<b>(16)</b>	<b>System board</b> (includes processor and replacement thermal material, see <a href="#">System board on page 49</a> )	
	Equipped with an AMD A12-9800B processor and the Windows 10 operating system	911738-601

<b>Item</b>	<b>Component</b>	<b>Spare part number</b>
	Equipped with an AMD A12-9800B processor and a non-Windows operating system	911738-001
	Equipped with an AMD A12-8830B processor and the Windows 10 operating system	911740-601
	Equipped with an AMD A12-8830B processor and a non-Windows operating system	911740-001
	Equipped with an AMD A10-8730B processor and the Windows 10 operating system	911739-601
	Equipped with an AMD A10-8730B processor and a non-Windows operating system	911739-001
	Equipped with an AMD A8-9600B processor and the Windows 10 operating system	911737-601
	Equipped with an AMD A8-9600B processor and a non-Windows operating system	911737-001
<b>(17)</b>	<b>RTC battery</b> (includes cable and double-sided adhesive)	702853-001
<b>(18)</b>	<b>Speaker assembly</b> (includes cable)	821684-001
<b>(19)</b>	<b>Bottom cover</b>	821662-001

## Display assembly subcomponents

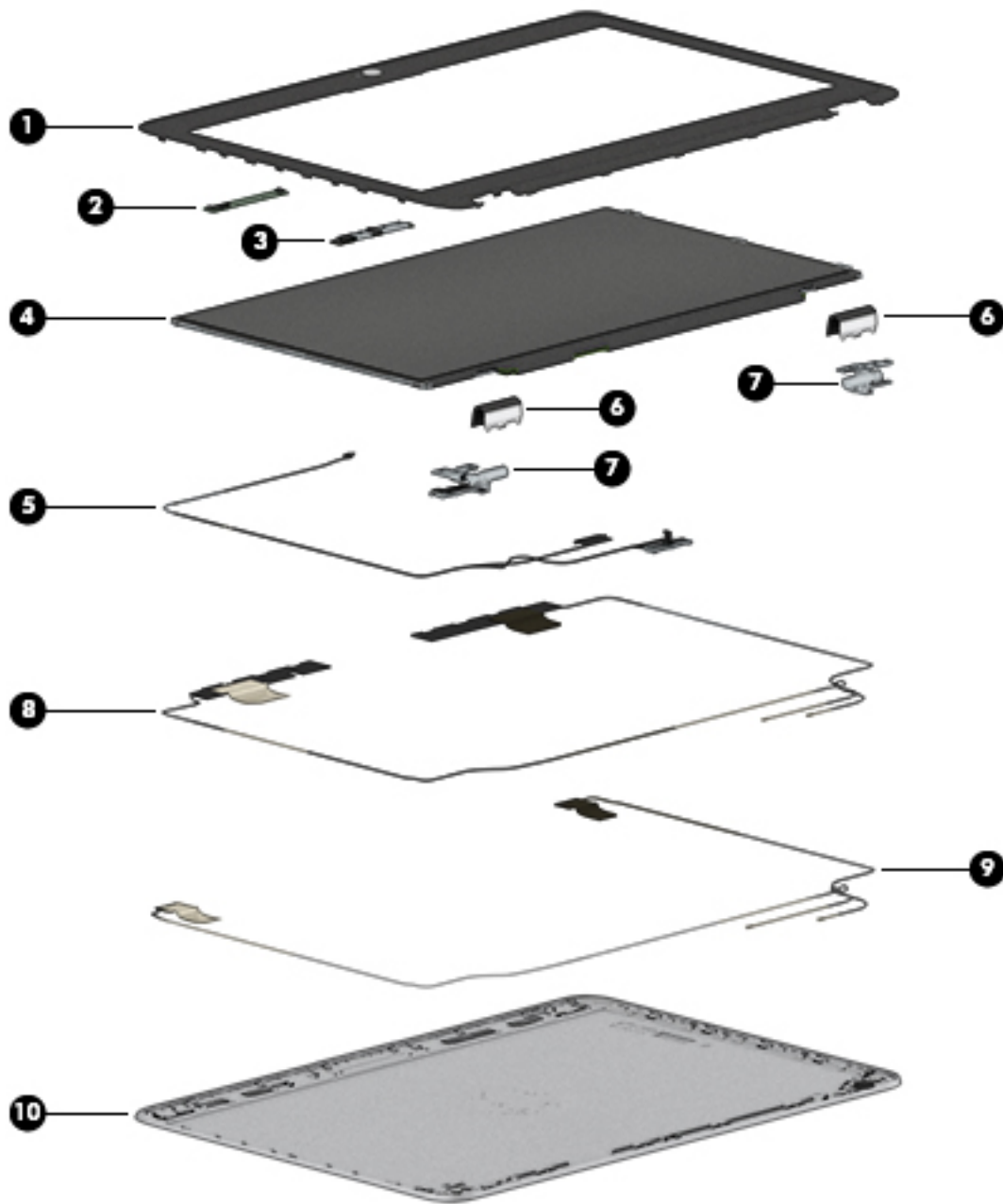

Item	Component	Spare part number
(1)	Display bezel	821658-001
(2)	Microphone module(includes cable)	920579-001
(3)	Webcam module (includes cable)	800575-020
(4)	Display panel	
	12.5-in, FHD (1920×1080), slim eDP, UWVA, AG 50%, WLED, non-TouchScreen display panel; typical brightness: 300 nits	832199-005



Item	Component	Spare part number
	12.5-in, HD (1366×768), slim eDP, SVA, AG 45%, WLED, non-TouchScreen display panel; typical brightness: 220 nits	804085-003
(5)	Display panel cable (included in the Cable Kit, spare part number 912091-001)	
(6)	Hinge covers (2; included in the Plastics Kit, spare part number 821675-001)	
(7)	Hinges (2)	821674-001
(8)	WWAN antenna (includes wireless antenna cables and transceivers; included in the display back cover spare part kit)	
(9)	WLAN antenna (includes wireless antenna cables and transceivers; included in the display back cover spare part kit)	
(10)	Back cover (includes wireless antenna cables and transceivers)	862350-001

## Plastics Kit

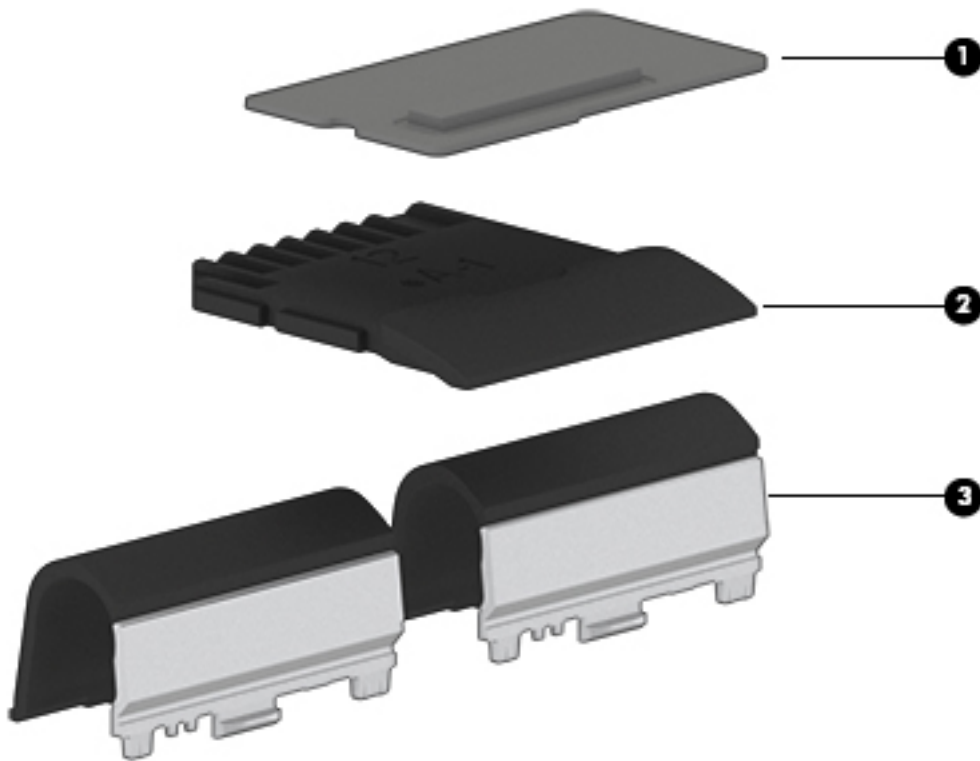

Item	Component	Spare part number
	<b>Plastics Kit</b>	821675-001
(1)	Fingerprint reader blank (includes bracket)	
(2)	SD card blank	
(3)	Hinge covers	
	Bottom cover rubber screw covers (not shown)	

## Cable Kit

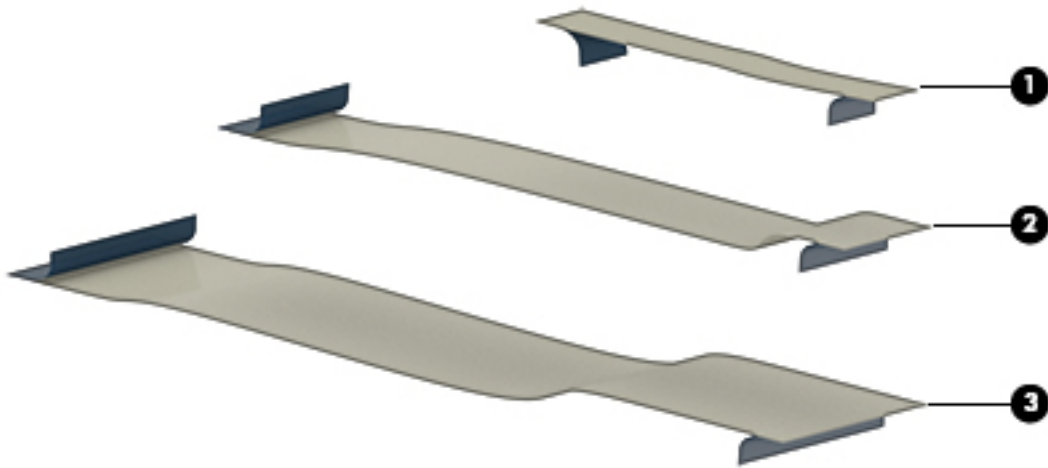

Item	Component	Spare part number
	<b>Cable Kit</b>	912091-001
(1)	NFC module cable	
(2)	Pointing stick cable	
(3)	Display panel cable	

## Mass storage devices

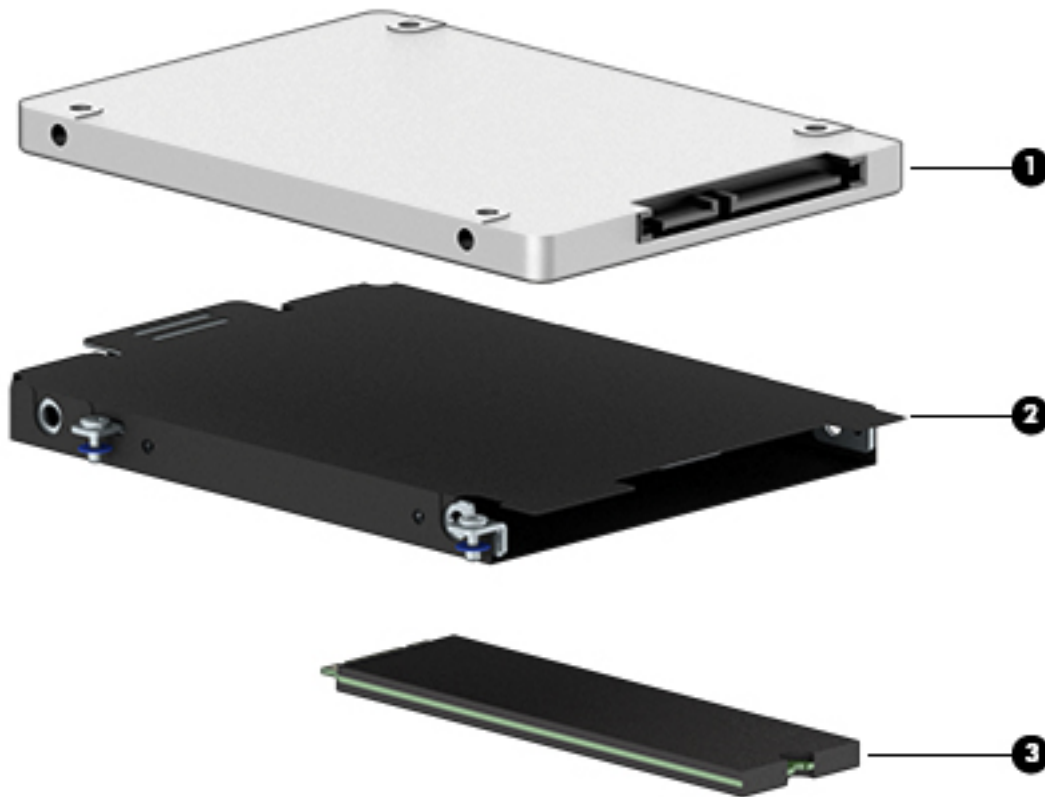

Item	Component	Spare part number
<b>(1)</b>	<b>Hard drive:</b>	
	1-TB, 5400-rpm, 7.0-mm	762990-001
	500-GB, 7200-rpm, 7.0-mm	703267-001
	500-GB, 7200-rpm, 7.0-mm, FIPS	820572-001
	500-GB, 7200-rpm, 7.0-mm, SED	820573-001
<b>(2)</b>	<b>Hard Drive Hardware Kit</b> (includes hard drive connector cable, hard drive rubber bracket, and screws)	821665-001
<b>(3)</b>	<b>Solid-state drive:</b>	
	512-GB, Turbo Drive, G2, TLC	915943-001
	360-GB, PCIe, TLC	915941-001
	256-GB, Turbo Drive, G2, TLC	915939-001
	256-GB, SATA-3, SED, OPAL, TLC	915940-001
	128-GB, M.2, SATA-3	915938-001

## Miscellaneous parts

Component	Spare part number
<b>AC adapter:</b>	
65-W HP Smart Adapter (non-PFC, EM, 4.5-mm)	714635-850
65-W HP Smart Adapter (EM, RC/V)	693710-001
65-W AC adapter (non-PFC, S-3P, 4.5-mm)	710412-001
65-W HP Smart Adapter (non-PFC)	693711-001
45-W HP Smart Adapter (non-PFC, RC, 4.5-mm, non-slim)	741727-001
45-W HP Smart Adapter (non-PFC, RC, 4.5-mm, non-slim)	741553-850
45-W HP Smart Adapter (non-PFC, 2-prong)	742436-001
<b>HP business top load case</b>	718550-001x
<b>HP comfort grip wireless mouse</b>	691922-001x
<b>HP DisplayPort-to-HDMI 1.4 adapter</b>	749288-001x
<b>HP docking station</b>	732252-001
<b>HP docking station cable lock</b>	575921-001x
<b>HP Elite USB-C docking station</b>	844550-001x
<b>HP Essential backpack</b>	679921-001x
<b>HP Essential top load case</b>	679923-001
<b>HP external DVD±RW DL SuperMulti Drive</b>	747080-001
<b>HP HDMI-to-VGA adapter</b>	701943-001
<b>HP Mobile Connect</b>	714749-001
<b>HP slim Ultrabook top load case</b>	747078-001x
<b>HP Smart AC adapter dongle (7.4 mm)</b>	734734-001x
<b>HP Ultralim keyed cable lock</b>	703372-001x
<b>HP USB travel dock</b>	844551-001x
<b>HP USB travel mouse</b>	757770-001x
<b>HP USB laser mouse</b>	674318-001x
<b>Power cord (C5 connector, 3-pin, black, 1.83-m):</b>	
For use in Argentina	401300-001
For use in Australia	213356-001
For use in Brazil	438722-001
For use in Denmark	213353-001
For use in Europe	213350-001
For use in India	404827-001
For use in Israel	398063-001

<b>Component</b>	<b>Spare part number</b>
For use in Italy	213352-001
For use in North America	213349-001
For use in the People's Republic of China	286497-001
For use in South Korea	267836-001
For use in Switzerland	213354-001
For use in Taiwan	393313-001
For use in Thailand	285096-001
For use in the United Kingdom and Singapore	213351-001
<b>Power cord</b> (C5 connector, 3-pin, black, 1.00-m):	
For use in Argentina	401300-007
For use in Australia	213356-008
For use in Brazil	438722-001
For use in Denmark	213353-008
For use in Europe	213350-009
For use in India	404827-003
For use in Israel	398063-003
For use in Italy	213352-008
For use in Japan	349756-002
For use in North America	213349-009
For use in the People's Republic of China	286497-008
For use in South Korea	267836-008
For use in Switzerland	213354-008
For use in Taiwan	393313-003
For use in Thailand	285096-006
For use in the United Kingdom and Singapore	213351-008
<b>Power cord</b> (C7 connector, 1.00-m) for use in Japan	190548-003
<b>Power cord</b> (Option-917, 3-cord, 1.83-m, ROHS)	361240-001
<b>Power cord</b> (Option-917, 3-cord, 1.00-m, ROHS)	361240-002
<b>Power cord</b> with ground lead for use in Japan	349756-001
<b>Pointing stick covers</b> (black, 20)	828884-001
<b>Screw Kit</b>	821664-001

---

# 4 Removal and replacement procedures preliminary requirements

## Tools required

You will need the following tools to complete the removal and replacement procedures:

- Flat-bladed screwdriver
- Magnetic screwdriver
- Phillips P0 and P1 screwdrivers

## Service considerations

The following sections include some of the considerations that you must keep in mind during disassembly and assembly procedures.



---

**NOTE:** As you remove each subassembly from the computer, place the subassembly (and all accompanying screws) away from the work area to prevent damage.

---

## Plastic parts



---

**CAUTION:** Using excessive force during disassembly and reassembly can damage plastic parts. Use care when handling the plastic

---

## Cables and connectors

---

**⚠ CAUTION:** When servicing the computer, be sure that cables are placed in their proper locations during the reassembly process. Improper cable placement can damage the computer.

---

Cables must be handled with extreme care to avoid damage. Apply only the tension required to unseat or seat the cables during removal and insertion. Handle cables by the connector whenever possible. In all cases, avoid bending, twisting, or tearing cables. Be sure that cables are routed in such a way that they cannot be caught or snagged by parts being removed or replaced. Handle flex cables with extreme care; these cables tear easily.

## Drive handling

---

**⚠ CAUTION:** Drives are fragile components that must be handled with care. To prevent damage to the computer, damage to a drive, or loss of information, observe these precautions:

Before removing or inserting a hard drive, shut down the computer. If you are unsure whether the computer is off or in Hibernation, turn the computer on, and then shut it down through the operating system.

Before handling a drive, be sure that you are discharged of static electricity. While handling a drive, avoid touching the connector.

Before removing a diskette drive or optical drive, be sure that a diskette or disc is not in the drive and be sure that the optical drive tray is closed.

Handle drives on surfaces covered with at least one inch of shock-proof foam.

Avoid dropping drives from any height onto any surface.

Avoid exposing an internal hard drive to products that have magnetic fields, such as monitors or speakers.

Avoid exposing an internal hard drive to products that have magnetic fields, such as monitors or speakers.

Avoid exposing a drive to temperature extremes or liquids.

If a drive must be mailed, place the drive in a bubble pack mailer or other suitable form of protective packaging and label the package "FRAGILE."

---

# Grounding guidelines

## Electrostatic discharge damage

Electronic components are sensitive to electrostatic discharge (ESD). Circuitry design and structure determine the degree of sensitivity. Networks built into many integrated circuits provide some protection, but in many cases, ESD contains enough power to alter device parameters or melt silicon junctions.

A discharge of static electricity from a finger or other conductor can destroy static-sensitive devices or microcircuitry. Even if the spark is neither felt nor heard, damage may have occurred.

An electronic device exposed to ESD may not be affected at all and can work perfectly throughout a normal cycle. Or the device may function normally for a while, then degrade in the internal layers, reducing its life expectancy.

**⚠ CAUTION:** To prevent damage to the computer when you are removing or installing internal components, observe these precautions:

Keep components in their electrostatic-safe containers until you are ready to install them.

Before touching an electronic component, discharge static electricity by using the guidelines described in this section.

Avoid touching pins, leads, and circuitry. Handle electronic components as little as possible.

If you remove a component, place it in an electrostatic-safe container.

The following table shows how humidity affects the electrostatic voltage levels generated by different activities.

**⚠ CAUTION:** A product can be degraded by as little as 700 V.

Typical electrostatic voltage levels			
Event	Relative humidity		
	10%	40%	55%
Walking across carpet	35,000 V	15,000 V	7,500 V
Walking across vinyl floor	12,000 V	5,000 V	3,000 V
Motions of bench worker	6,000 V	800 V	400 V
Removing DIPS from plastic tube	2,000 V	700 V	400 V
Removing DIPS from vinyl tray	11,500 V	4,000 V	2,000 V
Removing DIPS from Styrofoam	14,500 V	5,000 V	3,500 V
Removing bubble pack from PCB	26,500 V	20,000 V	7,000 V
Packing PCBs in foam-lined box	21,000 V	11,000 V	5,000 V



## Packaging and transporting guidelines

Follow these grounding guidelines when packaging and transporting equipment:

- To avoid hand contact, transport products in static-safe tubes, bags, or boxes.
- Protect ESD-sensitive parts and assemblies with conductive or approved containers or packaging.
- Keep ESD-sensitive parts in their containers until the parts arrive at static-free workstations.
- Place items on a grounded surface before removing items from their containers.
- Always be properly grounded when touching a component or assembly.
- Store reusable ESD-sensitive parts from assemblies in protective packaging or nonconductive foam.
- Use transporters and conveyors made of antistatic belts and roller bushings. Be sure that mechanized equipment used for moving materials is wired to ground and that proper materials are selected to avoid static charging. When grounding is not possible, use an ionizer to dissipate electric charges.

## Workstation guidelines

Follow these grounding workstation guidelines:

- Cover the workstation with approved static-shielding material.
- Use a wrist strap connected to a properly grounded work surface and use properly grounded tools and equipment.
- Use conductive field service tools, such as cutters, screwdrivers, and vacuums.
- When fixtures must directly contact dissipative surfaces, use fixtures made only of static safe materials.
- Keep the work area free of nonconductive materials, such as ordinary plastic assembly aids and Styrofoam.
- Handle ESD-sensitive components, parts, and assemblies by the case or PCM laminate. Handle these items only at static-free workstations.
- Avoid contact with pins, leads, or circuitry.
- Turn off power and input signals before inserting or removing connectors or test equipment.

## Equipment guidelines

Grounding equipment must include either a wrist strap or a foot strap at a grounded workstation.

- When seated, wear a wrist strap connected to a grounded system. Wrist straps are flexible straps with a minimum of one megohm  $\pm 10\%$  resistance in the ground cords. To provide proper ground, wear a strap snugly against the skin at all times. On grounded mats with banana-plug connectors, use alligator clips to connect a wrist strap.
- When standing, use foot straps and a grounded floor mat. Foot straps (heel, toe, or boot straps) can be used at standing workstations and are compatible with most types of shoes or boots. On conductive floors or dissipative floor mats, use foot straps on both feet with a minimum of one megohm resistance between the operator and ground. To be effective, the conductive must be worn in contact with the skin.

The following grounding equipment is recommended to prevent electrostatic damage:

- Antistatic tape
- Antistatic smocks, aprons, and sleeve protectors
- Conductive bins and other assembly or soldering aids
- Nonconductive foam
- Conductive tabletop workstations with ground cords of one megohm resistance
- Static-dissipative tables or floor mats with hard ties to the ground
- Field service kits
- Static awareness labels
- Material-handling packages
- Nonconductive plastic bags, tubes, or boxes
- Metal tote boxes
- Electrostatic voltage levels and protective materials

The following table lists the shielding protection provided by antistatic bags and floor mats.

Material	Use	Voltage protection level
Antistatic plastics	Bags	1,500 V
Carbon-loaded plastic	Floor mats	7,500 V
Metallized laminate	Floor mats	5,000 V

# 5 Removal and replacement procedures for Customer Self-Repair parts

This chapter provides removal and replacement procedures for Customer Self-Repair parts.

 **NOTE:** The Customer Self-Repair program is not available in all locations. Installing a part not supported by the Customer Self-Repair program may void your warranty. Check your warranty to determine if Customer Self-Repair is supported in your location.

## Component replacement procedures

 **NOTE:** Details about the computer, including model, serial number, product key, and length of warranty, are on the service tag on the bottom of the computer. See [Service label on page 16](#) for details.

 **NOTE:** HP continually improves and changes product parts. For complete and current information on supported parts for your computer, go to <http://partsurfer.hp.com>, select your country or region, and then follow the on-screen instructions.

There are as many as 20 screws that must be removed, replaced, and/or loosened when servicing Customer Self-Repair parts. Make special note of each screw size and location during removal and replacement.

### Bottom cover

Description	Spare part number
Bottom cover	821662-001

Before removing the bottom cover, follow these steps:

1. Turn off the computer. If you are unsure whether the computer is off or in Hibernation, turn the computer on, and then shut it down through the operating system.
2. Disconnect the power from the computer by first unscrewing the power cord from the AC outlet, and then unscrewing the AC adapter from the computer.
3. Disconnect all external devices from the computer.

Remove the bottom cover:

1. Turn the computer upside down on a flat surface.
2. Remove the 11 rubber screw covers **(1)**.

3. Remove the SD card blank (2).

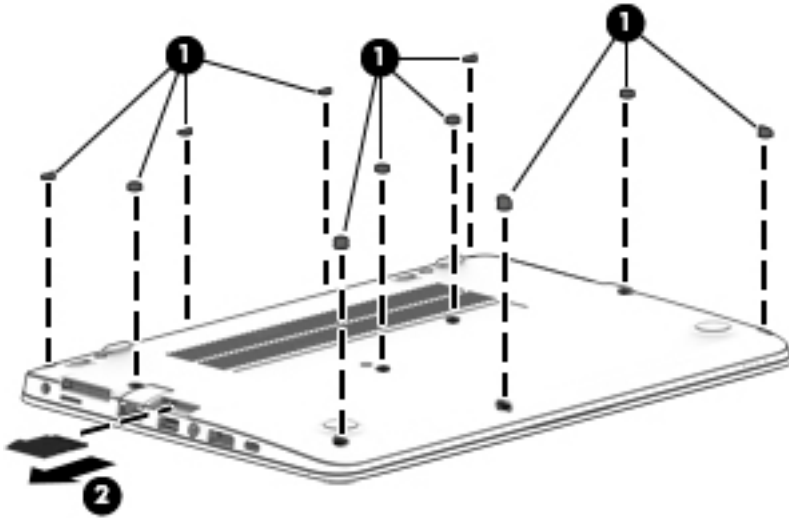

 **NOTE:** There are four different sizes of rubber screw covers, as shown in the following image.

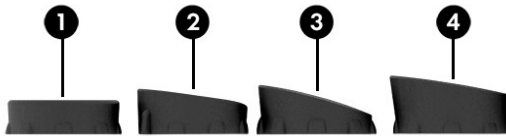

The rubber screw covers should be installed in the locations indicated in the following image. The rubber screw covers are included in the Plastics Kit, spare part number 821675-001.

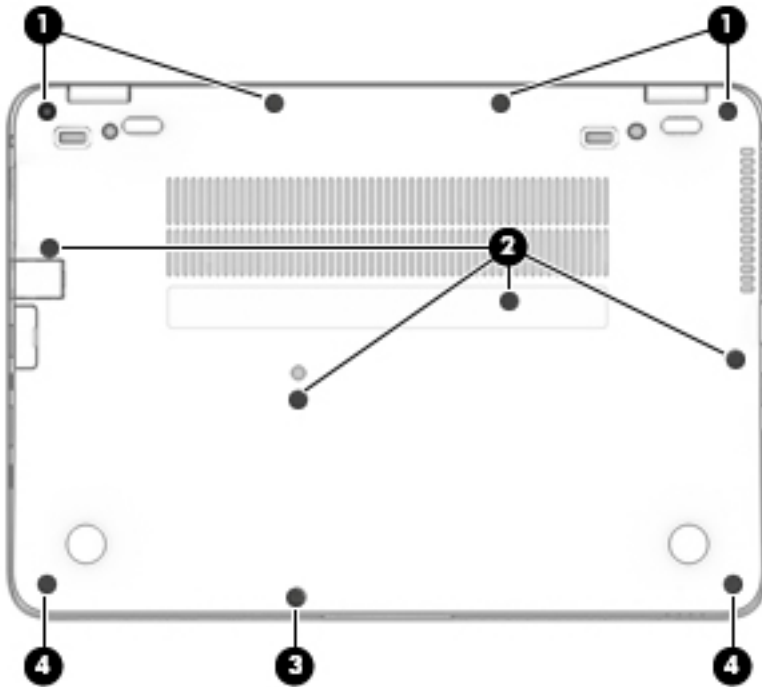

4. Remove the 11 Phillips PM2.5×5.0 screws that secure the bottom cover to the computer in the **(1)** through **(11)** sequence indicated in the following image.

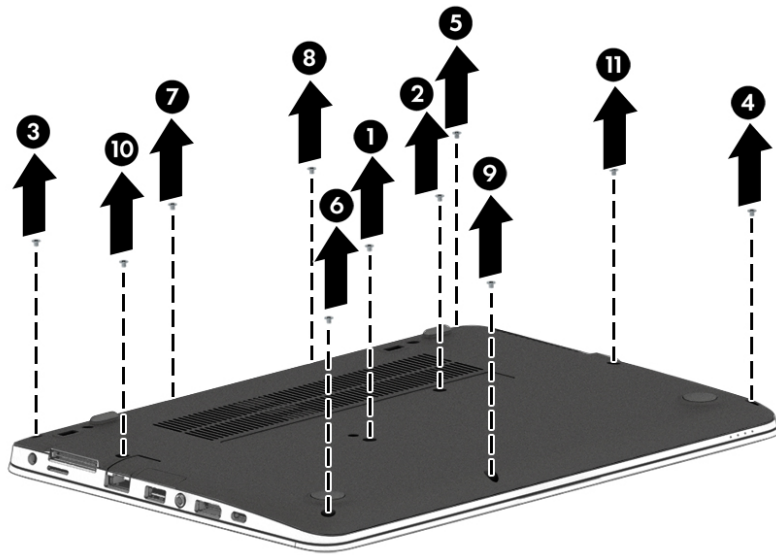

5. Remove the PM2.0×7.0 screw **(1)** in the SD card slot that secures the bottom cover to the computer.
6. Use a case utility tool to release the rear edge **(2)** of the bottom cover.
7. Remove the bottom cover **(3)**.

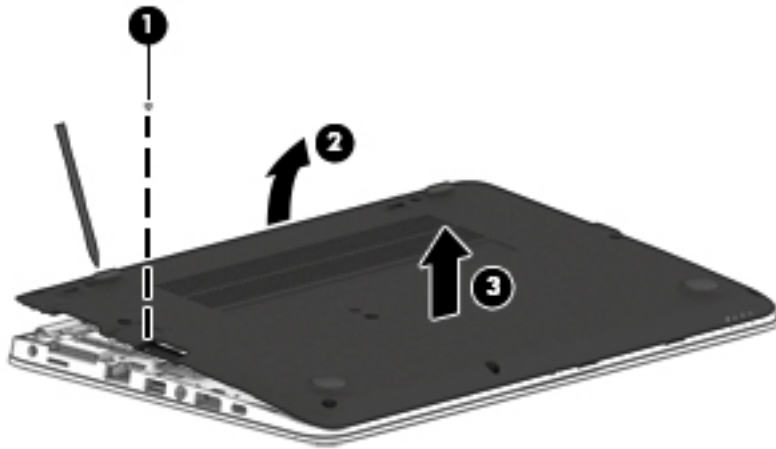

Reverse the removal procedures to install the bottom cover.

## Battery

Description	Spare part number
3-cell, 49-WHr, 4.25-AHr, Li-ion battery	854109-850

Before removing the battery, follow these steps:

1. Turn off the computer. If you are unsure whether the computer is off or in Hibernation, turn the computer on, and then shut it down through the operating system.
2. Disconnect the power from the computer by unscrewing the power cord from the computer.
3. Disconnect all external devices from the computer.
4. Remove the bottom cover (see [Bottom cover on page 33](#)).

To remove the battery:

- ⚠ WARNING!** To reduce potential safety issues, use only the user-replaceable battery provided with the computer, a replacement battery provided by HP, or a compatible battery purchased from HP.
- ⚠ CAUTION:** Removing a user-replaceable battery that is the sole power source for the computer can cause loss of information. To prevent loss of information, save your work or shut down the computer through Windows before removing the battery.

- ▲ Loosen the captive screw **(1)** and lift the tab to remove the battery from the computer **(2)**.

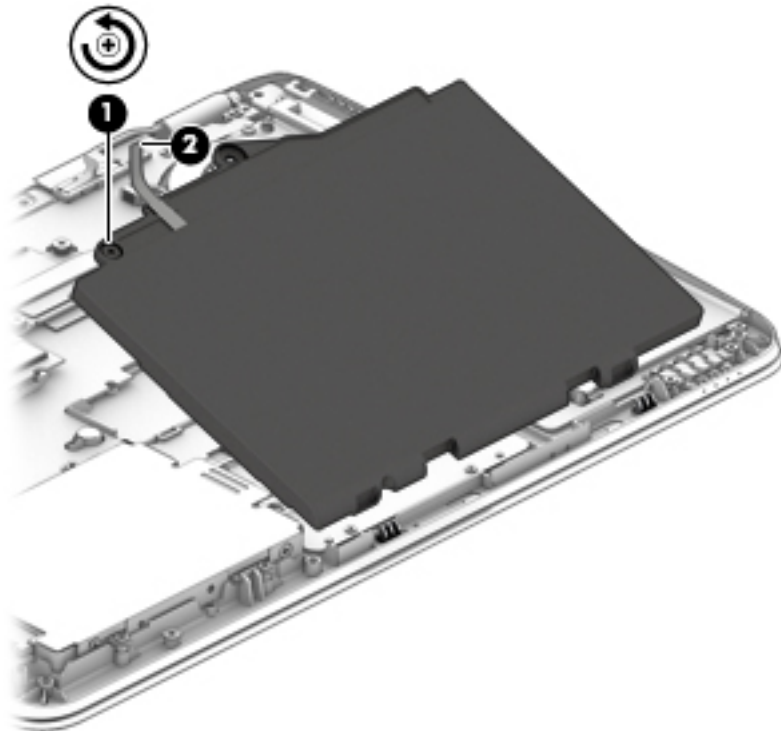

To insert the battery, reverse the removal procedures.

## Hard drive

Description	Spare part number
1-TB, 5400-rpm, 7.0-mm	762990-001
500-GB, 7200-rpm, 7.0-mm	703267-001
500-GB, 7200-rpm, 7.0-mm, FIPS	820572-001
500-GB, 7200-rpm, 7.0-mm, SED	820573-001

Before removing the hard drive, follow these steps:

1. Shut down the computer. If you are unsure whether the computer is off or in Hibernation, turn the computer on, and then shut it down through the operating system.
2. Disconnect all external devices connected to the computer.
3. Disconnect the power from the computer by first unscrewing the power cord from the AC outlet, and then unscrewing the AC adapter from the computer.
4. Remove the bottom cover (see [Bottom cover on page 33](#)).
5. Remove the battery (see [Battery on page 36](#)).

To remove the hard drive:

1. Loosen the 4 captive screws **(1)** that secure the hard drive to the computer.
2. Slide the hard drive **(2)** to the right to disconnect it from the connector.
3. Remove the hard drive **(3)**.

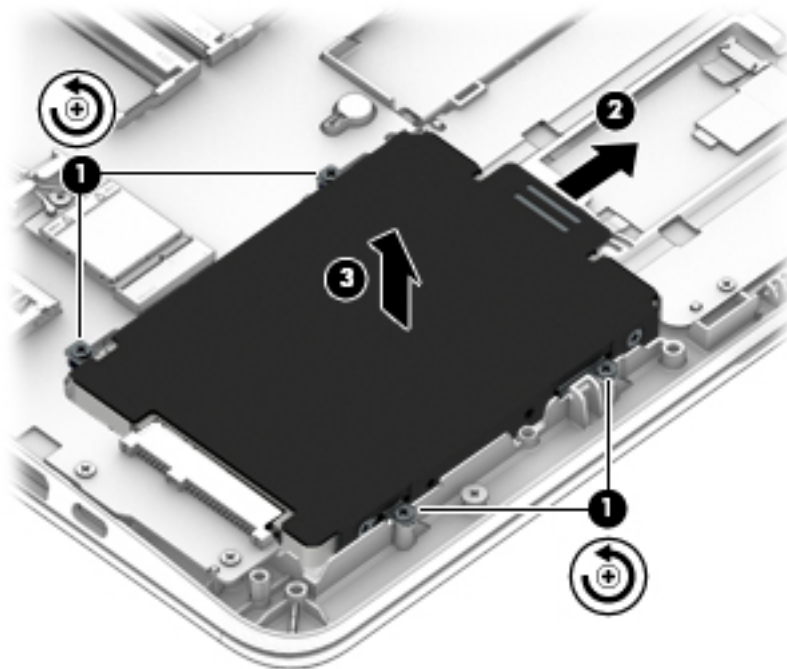

4. To remove the hard drive cover and bracket from the hard drive, lift the Mylar cover up off the drive, remove the four Phillips PM3.0×3.0 screws **(1)** that secure the bracket to the drive, and then slide the hard drive **(2)** out of the bracket.

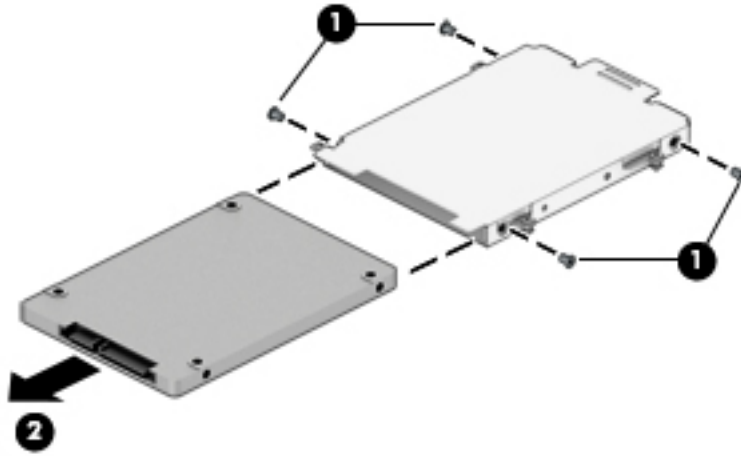

Reverse this procedure to install a hard drive.

## Solid-state drive

Description	Spare part number
512-GB, Turbo Drive, G2, TLC	915943-001
360-GB, PCIe, TLC	915941-001
256-GB, Turbo Drive, G2, TLC	915939-001
256-GB, SATA-3, SED, OPAL, TLC	915940-001
128-GB, M.2, SATA-3	915938-001

Before removing the solid-state drive, follow these steps:

1. Turn off the computer. If you are unsure whether the computer is off or in Hibernation, turn the computer on, and then shut it down through the operating system.
2. Disconnect the power from the computer by first unscrewing the power cord from the AC outlet, and then unscrewing the AC adapter from the computer.
3. Disconnect all external devices from the computer.
4. Remove the bottom cover (see [Bottom cover on page 33](#)).
5. Disconnect the battery (see [Battery on page 36](#)).

Remove the solid-state drive:

1. Remove the Phillips PM2.0×3.0 screw **(1)** that secures the drive to the system board.



2. Remove the drive (2) by pulling it away from the connector.

---

 **NOTE:** mSATA drives are designed with notches to prevent incorrect insertion.

---

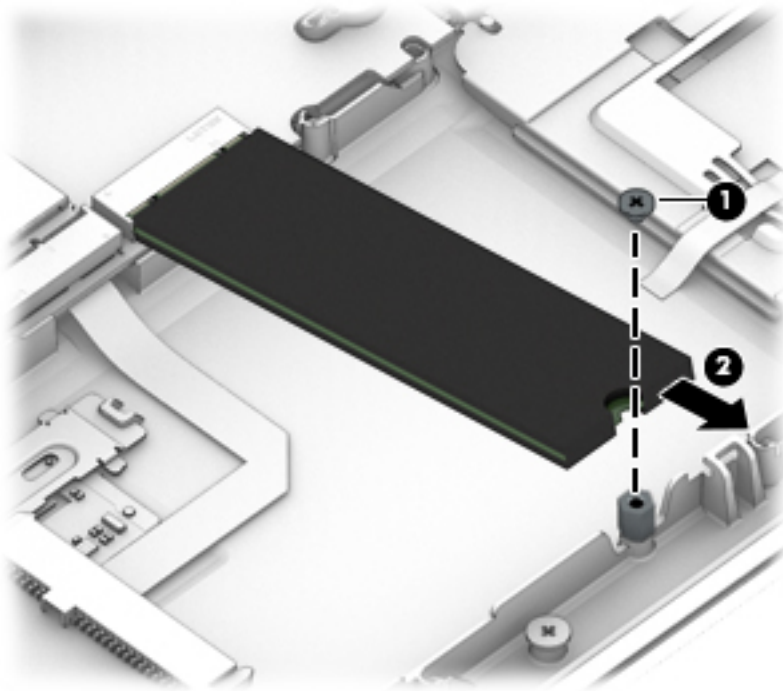

Reverse this procedure to reassemble and install the mSATA drive.

---

 **NOTE:** Only a hard drive or an solid-state drive can be installed. To install an solid-state drive, be sure that the standee is in place across from the connector and not stored beside the hard drive slot.

---

## Memory modules



**NOTE:** Primary and expansion memory is installed in a side-by-side configuration in the bottom of the computer. If only one memory module is installed, it must be installed in the socket labeled 1.

Description	Spare part number
8-GB (PC4-1866, 2400-MHz, DDR4, 1.2-V)	862398-850
4-GB (PC4-1866, 2400-MHz, DDR4, 1.2-V)	862397-855

### Update BIOS before adding memory modules

Before adding new memory, make sure you update the computer to the latest BIOS.



**CAUTION:** Failure to update the computer to the latest BIOS prior to installing new memory may result in various system problems.

To update BIOS:

1. Navigate to [www.hp.com](http://www.hp.com).
2. Click **Support & Drivers**, and then click **Drivers & Software**.
3. In the **Enter a product name/number** box, type the computer model information, and then click **Search**.
4. Click the link for the computer model.
5. Select the operating system, and then click **Next**.
6. Under **Step 2: Select a Download**, click the **BIOS** link.
7. Click the link for the most recent BIOS.
8. Click the **Download** button, and then follow the on-screen instructions.

Before removing the memory module, follow these steps:

1. Shut down the computer. If you are unsure whether the computer is off or in Hibernation, turn the computer on, and then shut it down through the operating system.
2. Disconnect all external devices connected to the computer.
3. Disconnect the power from the computer by first unscrewing the power cord from the AC outlet, and then unscrewing the AC adapter from the computer.
4. Remove the bottom cover (see [Bottom cover on page 33](#)).
5. Remove the battery (see [Battery on page 36](#)).

Remove the memory module:

1. Spread the retaining tabs **(1)** on each side of the memory module slot to release the memory module. (The edge of the module opposite the slot rises away from the computer.)

2. Remove the memory module (**2**) by pulling the module away from the slot at an angle.

 **NOTE:** Memory modules are designed with a notch to prevent incorrect insertion into the memory module slot.

 **NOTE:** The computer uses two memory sockets. The socket labeled 2 houses the expansion memory module and the socket labeled 1 houses the primary memory module. The removal procedure is the same for both memory sockets.

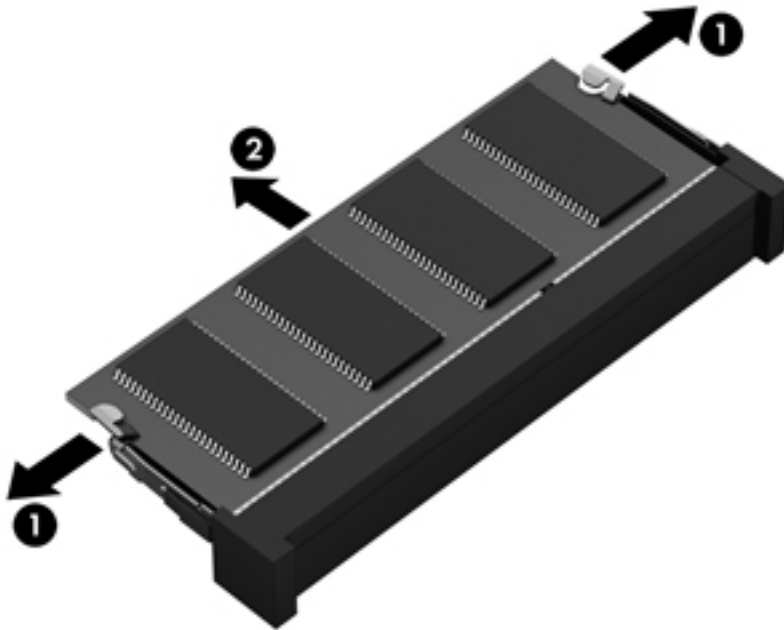

Reverse this procedure to install a memory module.

## WLAN module

Description	Spare part number
Realtek RTL8723BE-VB 802.11b/g/n 1×1 WiFi + Bluetooth 4.0 Combo Adapter	843338-001
Intel Dual Band Wireless-AC 3168 802.11 AC 1×1 WiFi + Bluetooth 4.2 Combo Adapter	852511-001
Intel Dual Band Wireless-AC 7265 802.11 AC 2×2 WiFi + Bluetooth 4.2 Combo Adapter (non-vPro)	860883-001

Before removing the WLAN module, follow these steps:

1. Shut down the computer. If you are unsure whether the computer is off or in Hibernation, turn the computer on, and then shut it down through the operating system.
2. Disconnect all external devices connected to the computer.
3. Disconnect the power from the computer by first unscrewing the power cord from the AC outlet, and then unscrewing the AC adapter from the computer.
4. Remove the bottom cover (see [Bottom cover on page 33](#)).
5. Remove the battery (see [Battery on page 36](#)).

Remove the WLAN module:

1. Disconnect the WLAN antenna cables **(1)** from the terminals on the WLAN module.





**NOTE:** The WLAN antenna cable labeled “1” connects to the WLAN module “Main” terminal labeled “1”. The WLAN antenna cable labeled “2” connects to the WLAN module “Aux” terminal labeled “2”. If the computer is equipped with an 802.11a/b/g/n WLAN module, the yellow WLAN antenna cable connects to the middle terminal on the WLAN module.

2. Remove the one Phillips PM2.5×3.0 screw **(2)** that secures the WLAN module to the computer. (The edge of the module opposite the slot rises away from the computer.)

3. Remove the WLAN module by pulling the module away from the slot at an angle (3).

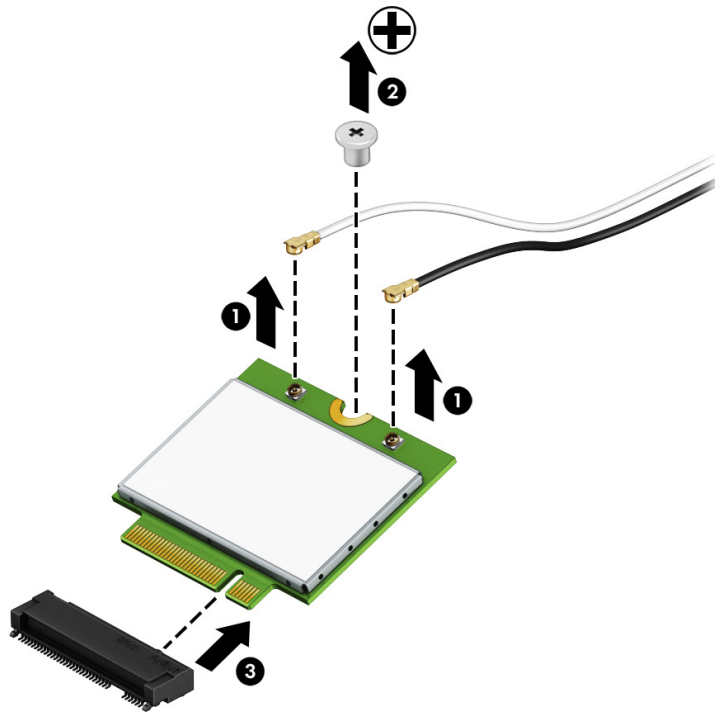
 **NOTE:** WLAN modules are designed with a notch to prevent incorrect insertion.



 **NOTE:** If the WLAN antennas are not connected to the terminals on the WLAN module, the protective sleeves must be installed on the antenna connectors, as shown in the following illustration.



Reverse this procedure to install the WLAN module.

## WWAN module

The WLAN module and WWAN module are not interchangeable.

The WWAN module is available on select models only.

Description	Spare part number
HP hs3210 WW HSPA+	860726-001
HP It4132 LTE/HSPA+ with GPS M.2 WWAN module	845710-001
HP It4120 LTE/EVDO/HSPA+ with GPS M.2	800870-001

Before removing the WWAN module, follow these steps:

1. Shut down the computer. If you are unsure whether the computer is off or in Hibernation, turn the computer on, and then shut it down through the operating system.
2. Disconnect all external devices connected to the computer.
3. Disconnect the power from the computer by first unscrewing the power cord from the AC outlet, and then unscrewing the AC adapter from the computer.
4. Remove the bottom cover (see [Bottom cover on page 33](#)).
5. Remove the battery (see [Battery on page 36](#)).

Remove the WWAN module:

1. Position the computer upside-down.
2. Disconnect the WWAN antenna cables **(1)** from the terminals on the WWAN module.





**NOTE:** The red WWAN antenna cable is connected to the WWAN module “Main” terminal. The blue WWAN antenna cable is connected to the WWAN module “Aux” terminal.

3. Remove the one Phillips PM2.5×3.0 screws **(2)** that secure the WWAN module to the computer. (The edge of the module opposite the slot rises away from the computer.)

4. Remove the WWAN module (3) by pulling the module away from the slot at an angle.

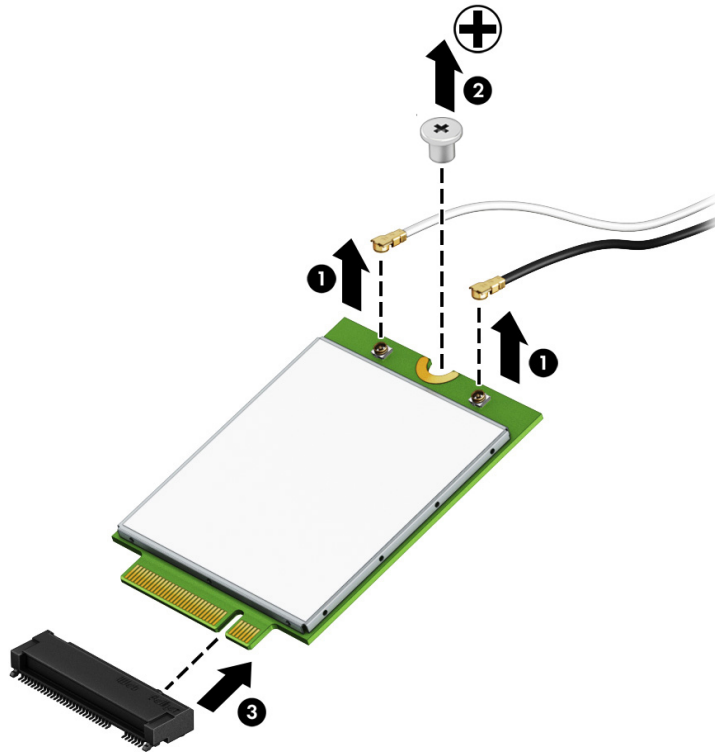
 **NOTE:** WWAN modules are designed with a notch to prevent incorrect insertion.



 **NOTE:** If the WWAN antennas are not connected to the terminals on the WWAN module, the protective sleeves must be installed on the antenna connectors, as shown in the following illustration.



Reverse this procedure to install the WWAN module.

## Keyboard

For use in country or region	Spare part number	For use in country or region	Spare part number	For use in country or region	Spare part number
Keyboard with backlight and pointing stick (includes backlight cable, keyboard cable, and pointing stick cable)				For use in Saudi Arabia	826630-171
For use in Belgium	826630-A41	For use in India	826630-D61	For use in Slovenia	826630-BA1
For use in Brazil	826630-201	For use in Israel	826630-BB1	For use in South Korea	826630-AD1
For use in Bulgaria	826630-261	For use in Italy	826630-061	For use in Spain	826630-071
For use in Canada	826630-DB1	For use in Japan	826630-291	For use in Sweden and Finland	826630-B71
For use in the Czech Republic and Slovakia	826630-FL1	For use in Latin America	826630-161	For use in Switzerland	826630-BG1
For use in Denmark	826630-081	For use in the Netherlands	826630-B31	For use in Taiwan	826630-AB1
For use in Denmark, Finland, and Norway	826630-DH1	For use in Northwest Africa	826630-FP1	For use in Thailand	826630-281
For use in France	826630-051	For use in Norway	826630-091	For use in Turkey	826630-141
For use in Germany	826630-041	For use in Portugal	826630-131	For use in Turkey F-style	826630-541
For use in Greece	826630-151	For use in Romania	826630-271	For use in the United Kingdom	826630-031
For use in Hungary	826630-211	For use in Russia	826630-251	For use in the United States	826630-001
For use in Iceland	826630-DD1				
Keyboard with backlight and pointing stick (includes backlight cable, keyboard cable, and pointing stick cable)				For use in Saudi Arabia	826631-171
For use in Belgium	826631-A41	For use in India	826631-D61	For use in Slovenia	826631-BA1
For use in Brazil	826631-201	For use in Israel	826631-BB1	For use in South Korea	826631-AD1
For use in Bulgaria	826631-261	For use in Italy	826631-061	For use in Spain	826631-071
For use in Canada	826631-DB1	For use in Japan	826631-291	For use in Sweden and Finland	826631-B71
For use in the Czech Republic and Slovakia	826631-FL1	For use in Latin America	826631-161	For use in Switzerland	826631-BG1
For use in Denmark	826631-081	For use in the Netherlands	826631-B31	For use in Taiwan	826631-AB1
For use in Denmark, Finland, and Norway	826631-DH1	For use in Northwest Africa	826631-FP1	For use in Thailand	826631-281
For use in France	826631-051	For use in Norway	826631-091	For use in Turkey	826631-141
For use in Germany	826631-041	For use in Portugal	826631-131	For use in Turkey F-style	826631-541
For use in Greece	826631-151	For use in Romania	826631-271	For use in the United Kingdom	826631-031
For use in Hungary	826631-211	For use in Russia	826631-251	For use in the United States	826631-001
For use in Iceland	826631-DD1				



Before removing the keyboard, follow these steps:

1. Shut down the computer. If you are unsure whether the computer is off or in Hibernation, turn the computer on, and then shut it down through the operating system.
2. Disconnect all external devices connected to the computer.
3. Disconnect the power from the computer by first unscrewing the power cord from the AC outlet, and then unscrewing the AC adapter from the computer.
4. Remove the bottom cover (see [Bottom cover on page 33](#)).
5. Remove the battery (see [Battery on page 36](#)).

Remove the keyboard:

1. Remove the 2 Phillips PM2.5×3.0 screws that secure the keyboard to the computer **(1)**.
2. Position the computer upright with the front toward you.
3. Open the computer as far as possible.
4. Insert a screwdriver or similar thin tool into the hole beside the heat sink/fan assembly, and then press on the back of the keyboard until it disengages from the computer **(2)**. Rotate the top of the keyboard upward, and then lift the keyboard up at an angle to disengage the tabs at the bottom of the keyboard.

 **NOTE:** Cables connect the bottom of the keyboard to the system board. Make sure not to prematurely pull the keyboard cables out of the system board connectors.

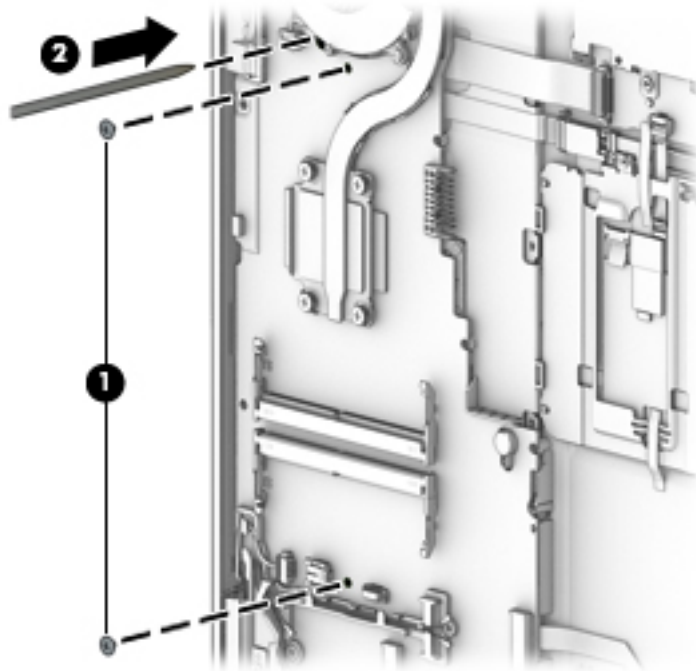

5. Slide the keyboard slightly downward toward the palm rest to disengage the top of the keyboard from the top cover **(1)**. Remove the pointing stick cable **(2)**, the keyboard backlight cable **(3)**, and the keyboard cable **(4)**.

6. Remove the keyboard (5).

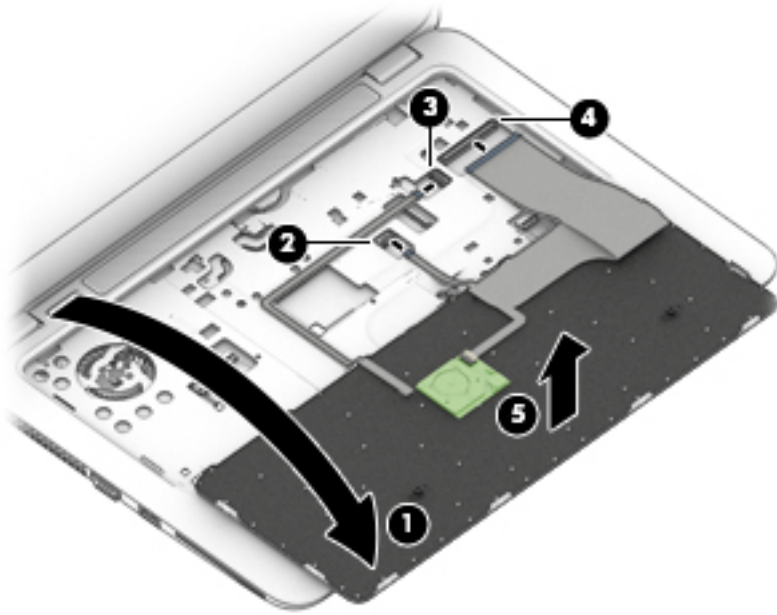

Reverse this procedure to install the keyboard.

# 6 Removal and replacement procedures for Authorized Service Provider parts

This chapter provides removal and replacement procedures for Authorized Service Provider only parts.

 **CAUTION:** Components described in this chapter should only be accessed by an authorized service provider. Accessing these parts can damage the computer or void the warranty.

**CAUTION:** This computer does not have user-replaceable parts. Only HP authorized service providers should perform the removal and replacement procedures described here. Accessing the internal part could damage the computer or void the warranty.

## Component replacement procedures

 **NOTE:** Details about your computer, including model, serial number, product key, and length of warranty, are on the service tag at the bottom of your computer. See [Service label on page 16](#) for details.

 **NOTE:** HP continually improves and changes product parts. For complete and current information on supported parts for your computer, go to <http://partsurfer.hp.com>, select your country or region, and then follow the on-screen instructions.

There are as many as 29 screws that must be removed, replaced, and/or loosened when servicing Authorized Service Provider only parts. Make special note of each screw size and location during removal and replacement.

## System board

 **NOTE:** All system board spare part kits include an AMD processor and replacement thermal material.

Description	Spare part number
Equipped with an AMD A12-9800B processor and the Windows 10 operating system	911738-601
Equipped with an AMD A12-9800B processor and a non-Windows operating system	911738-001
Equipped with an AMD A12-8830B processor and the Windows 10 operating system	911740-601
Equipped with an AMD A12-8830B processor and a non-Windows operating system	911740-001
Equipped with an AMD A10-8730B processor and the Windows 10 operating system	911739-601
Equipped with an AMD A10-8730B processor and a non-Windows operating system	911739-001
Equipped with an AMD A8-9600B processor and the Windows 10 operating system	911737-601
Equipped with an AMD A8-9600B processor and a non-Windows operating system	911737-001

Before removing the system board, follow these steps:

1. Shut down the computer. If you are unsure whether the computer is off or in Hibernation, turn the computer on, and then shut it down through the operating system.
2. Disconnect all external devices connected to the computer.
3. Disconnect the power from the computer by first unscrewing the power cord from the AC outlet, and then unscrewing the AC adapter from the computer.
4. Remove the bottom cover (see [Bottom cover on page 33](#)).
5. Remove the battery (see [Battery on page 36](#)).
6. Remove the following components:
  - a. Keyboard (see [Keyboard on page 46](#))
  - b. Hard drive (see [Hard drive on page 37](#))
  - c. solid-state drive (see [Solid-state drive on page 38](#))

When replacing the system board, be sure to remove the following components from the defective system board and install on the replacement system board:

- Memory modules (see [Memory modules on page 40](#))
- WLAN/Bluetooth module (see [WLAN module on page 42](#))
- WWAN module (see [WWAN module on page 44](#))
- RTC battery (see [RTC battery on page 52](#))
- Heat sink/ fan assembly (see [Heat sink/fan assembly on page 53](#))

Remove the system board:

1. Disconnect the following cables from the system board:
  - (1) Speaker cable
  - (2) WLAN cables
  - (3) WWAN cables
  - (4) Display cable

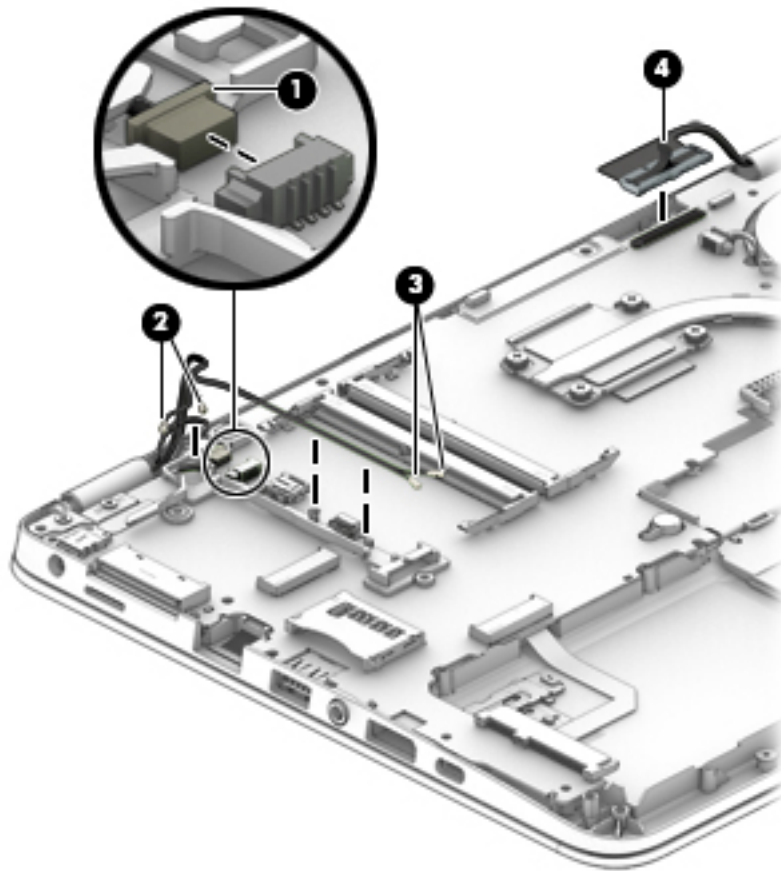

2. Remove the four Phillips PM2.5×5.0 screws **(1)** that secure the system board to the computer.
3. Lift the right side of the system board **(2)** until it rests at an angle.
4. Remove the system board **(3)** by sliding it up and to the right at an angle.

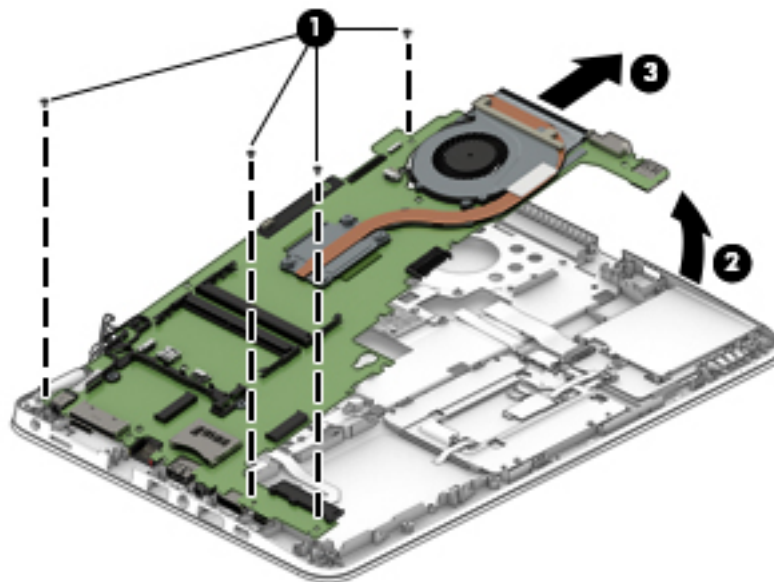

Reverse this procedure to install the system board.

## RTC battery

Description	Spare part number
RTC battery (includes cable and double-sided adhesive)	702853-001

Before removing the RTC battery, follow these steps:

1. Shut down the computer. If you are unsure whether the computer is off or in Hibernation, turn the computer on, and then shut it down through the operating system.
2. Disconnect all external devices connected to the computer.
3. Disconnect the power from the computer by first unscrewing the power cord from the AC outlet, and then unscrewing the AC adapter from the computer.
4. Remove the bottom cover (see [Bottom cover on page 33](#)).
5. Remove the battery (see [Battery on page 36](#)).
6. Remove the system board (see [System board on page 49](#)).

Remove the RTC battery:

1. Remove the RTC battery cable from the system board **(1)**.
2. Using a flat tool, pry the battery out of the socket **(2)**.

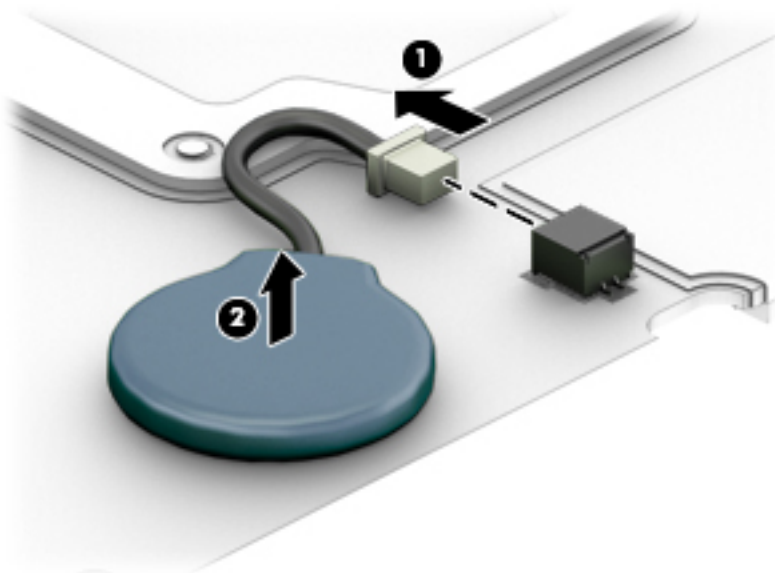

Reverse this procedure to install the RTC battery.

## Heat sink/fan assembly

 **NOTE:** The heat sink/fan assembly spare part kit includes replacement thermal material.

Description	Spare part number
Heat sink/thermal module with fans	821691-001

Before removing the heat sink/fan assembly, follow these steps:

1. Turn off the computer. If you are unsure whether the computer is off or in Hibernation, turn the computer on, and then shut it down through the operating system.
2. Disconnect the power from the computer by first unscrewing the power cord from the AC outlet, and then unscrewing the AC adapter from the computer.
3. Disconnect all external devices from the computer.
4. Bottom cover (see [Bottom cover on page 33](#)).
5. Remove the battery (see [Battery on page 36](#)).
6. Remove the system board (see [System board on page 49](#)).

Remove the heat sink/fan assembly:

- ▲ Disconnect the fan cable (1), loosen the six captive screws on the fan and heat sink following the sequence stamped on the heat sink (2), and then remove the heat sink/fan assembly from the system board (3).

 **CAUTION:** Take extreme care when removing the heat sink and fan assembly. The heatpipes between the fans are very fragile and can be easily damaged and bent during removal.

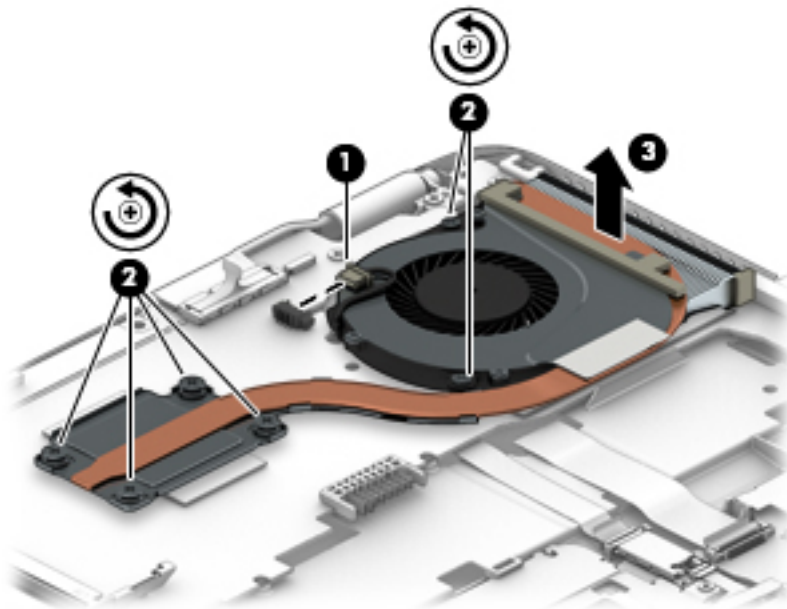

 **NOTE:** The thermal material must be thoroughly cleaned from the surfaces of the heat sink and the system board components each time the heat sink is removed. Replacement thermal material is included with the heat sink, processor, and system board spare part kits.

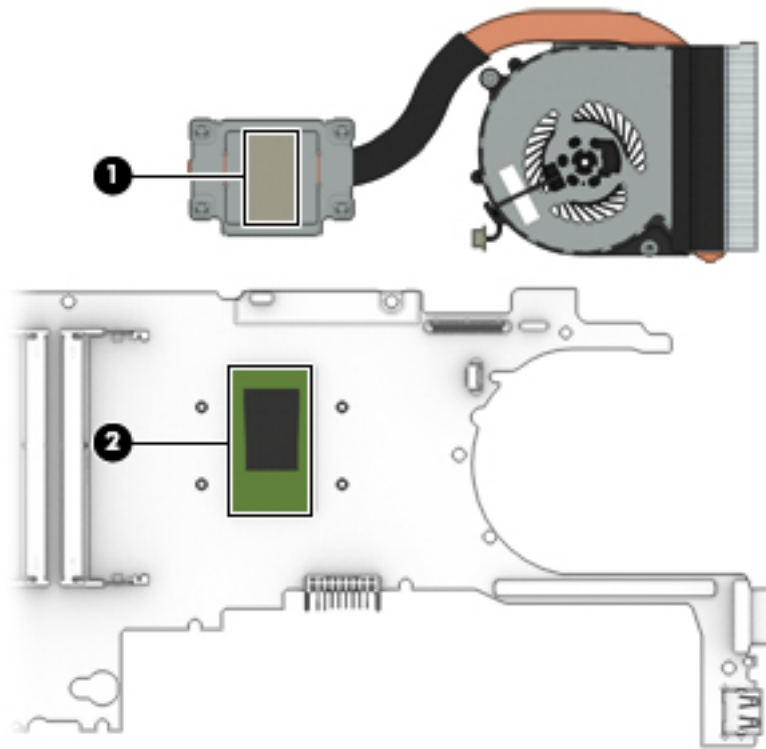

Reverse this procedure to install the heat sink/fan assembly.



## Fingerprint reader assembly

Description	Spare part number
Fingerprint reader assembly (includes cable, bracket, and bezel)	821693-001

Before removing the fingerprint reader assembly, follow these steps:

1. Shut down the computer. If you are unsure whether the computer is off or in Hibernation, turn the computer on, and then shut it down through the operating system.
2. Disconnect all external devices connected to the computer.
3. Disconnect the power from the computer by first unscrewing the power cord from the AC outlet, and then unscrewing the AC adapter from the computer.
4. Remove the bottom cover (see [Bottom cover on page 33](#)).
5. Remove the battery (see [Battery on page 36](#)).
6. Remove the system board (see [System board on page 49](#)).

Remove the fingerprint reader assembly:

1. Remove the Phillips PM2.5x3.0 screw **(1)** that secures the bracket to the top cover.
2. Slide the bracket right, and then lift it off the top cover **(2)**.
3. Disconnect the fingerprint reader board cable from the system board.
4. Remove the fingerprint reader board and cable assembly from the top cover **(3)**.

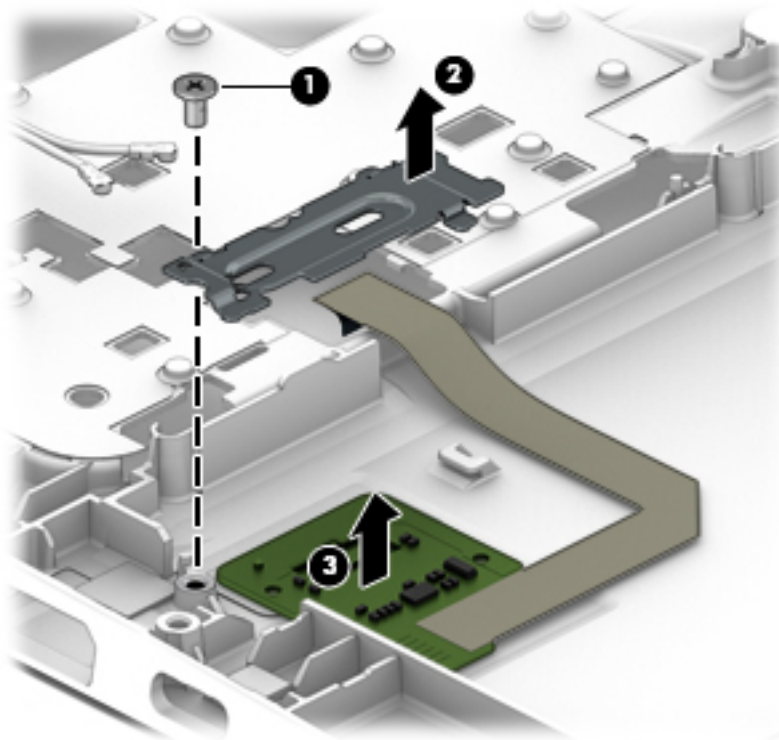

Reverse this procedure to install the fingerprint reader assembly.

## TouchPad button board

Description	Spare part number
TouchPad button board	821668-001
TouchPad button board w/NFC antenna	821667-001

Before removing the TouchPad button board, follow these steps:

1. Shut down the computer. If you are unsure whether the computer is off or in Hibernation, turn the computer on, and then shut it down through the operating system.
2. Disconnect all external devices connected to the computer.
3. Disconnect the power from the computer by first unscrewing the power cord from the AC outlet, and then unscrewing the AC adapter from the computer.
4. Remove the bottom cover (see [Bottom cover on page 33](#)).
5. Remove the battery (see [Battery on page 36](#)).
6. Remove the system board (see [System board on page 49](#)).

Remove the TouchPad button board:

1. Disconnect the cable from the TouchPad to the smart card reader board **(1)**, and then disconnect the NFC antenna from the NFC module **(2)**.
2. Lift the tape, and then remove the 3 Phillips PM2.5×3.0 screws **(3)** that secure the TouchPad button board to the top cover.
3. Lift the bottom of the TouchPad button board up, and then pull it forward to remove it from the slot **(4)**.

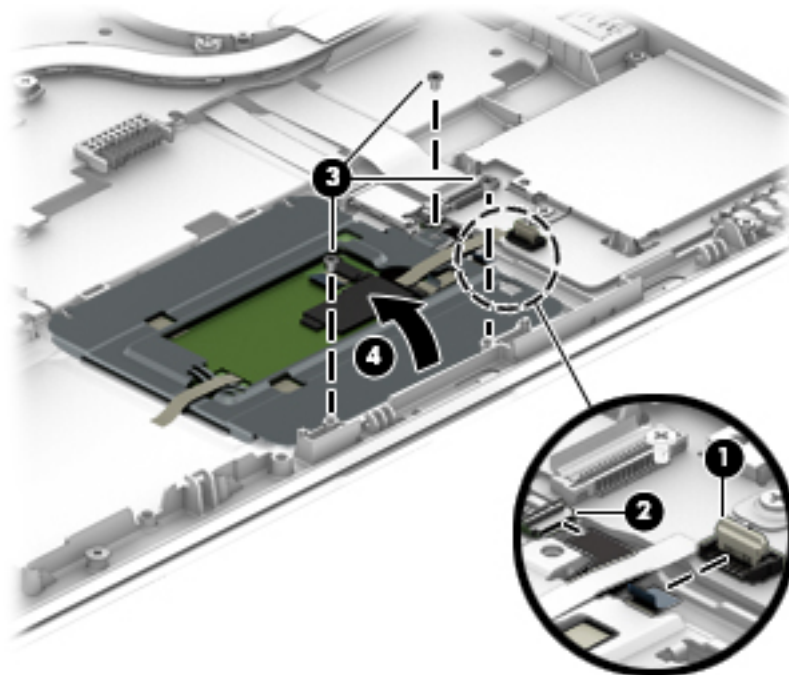

Reverse this procedure to install the TouchPad board.

## NFC module

Description	Spare part number
NFC module	821666-001

Before removing the NFC module, follow these steps:

1. Turn off the computer. If you are unsure whether the computer is off or in Hibernation, turn the computer on, and then shut it down through the operating system.
2. Disconnect the power from the computer by first unscrewing the power cord from the AC outlet, and then unscrewing the AC adapter from the computer.
3. Disconnect all external devices from the computer.
4. Remove the bottom cover (see [Bottom cover on page 33](#)).
5. Remove the battery (see [Battery on page 36](#)).
6. Remove the system board (see [System board on page 49](#)).

Remove the NFC module:

1. Disconnect the system board cable (1) and the NFC antenna from the NFC module.
2. Pry the NFC module from the smart card reader, and the lift it from the computer (2).

 **NOTE:** The NFC antenna is spared with the TouchPad.

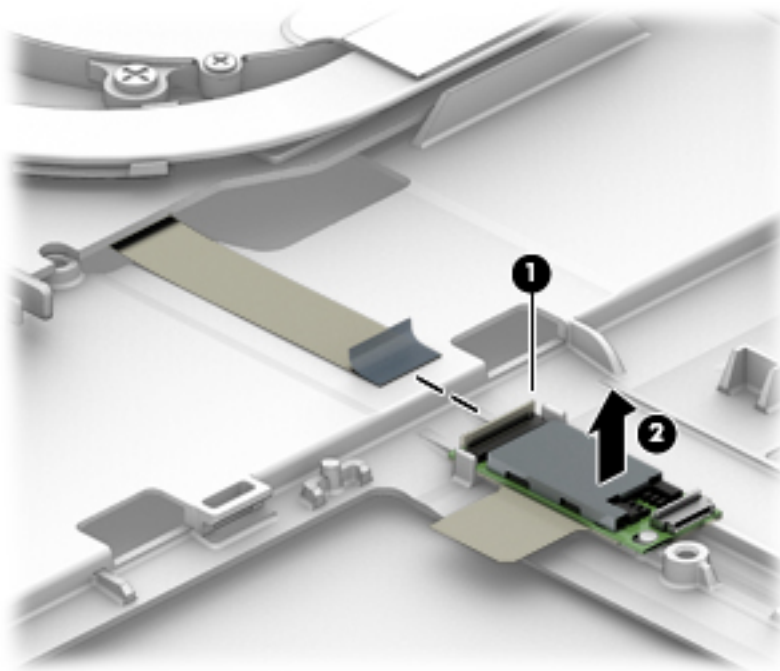

Reverse the removal procedures to install the NFC module.

## Smart card reader board

Description	Spare part number
Smart card reader board (includes cable)	914963-001

Before removing the card reader board, follow these steps:

1. Shut down the computer. If you are unsure whether the computer is off or in Hibernation, turn the computer on, and then shut it down through the operating system.
2. Disconnect all external devices connected to the computer.
3. Disconnect the power from the computer by first unscrewing the power cord from the AC outlet, and then unscrewing the AC adapter from the computer.
4. Remove the bottom cover (see [Bottom cover on page 33](#)).
5. Remove the battery (see [Battery on page 36](#)).
6. Remove the system board (see [System board on page 49](#)).

Remove the smart card reader board:



**NOTE:** Before you remove the smart card reader, make sure nothing (memory card or plastic insert) is installed.

1. Disconnect the cable from the board **(1)**.
2. Disconnect the cable from the TouchPad **(2)**.
3. Remove the 3 Phillips PM2.5x3.0 screws that secure the bracket to the top cover **(3)**, and then lift to remove it from the computer **(4)**.
4. Lift the smart card reader board left to remove it from the top cover **(5)**.

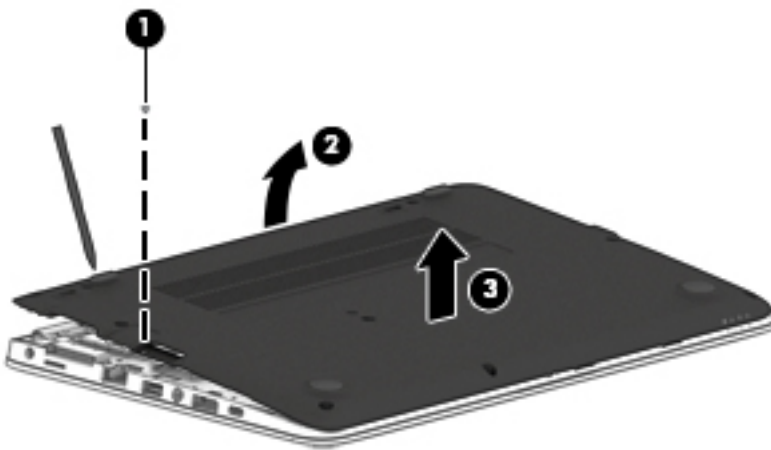

Reverse this procedure to install the card reader board.

## Speaker assembly

Description	Spare part number
Speaker assembly (includes cable)	821684-001

Before removing the speaker assembly, follow these steps:

1. Turn off the computer. If you are unsure whether the computer is off or in Hibernation, turn the computer on, and then shut it down through the operating system.
2. Disconnect the power from the computer by first unscrewing the power cord from the AC outlet, and then unscrewing the AC adapter from the computer.
3. Disconnect all external devices from the computer.
4. Remove the bottom cover (see [Bottom cover on page 33](#)).
5. Remove the battery (see [Battery on page 36](#)).
6. Remove the system board (see [System board on page 49](#)).

Remove the speaker assembly:

1. Remove the two Phillips PM2.5x3.0 screws that secure the speakers to the computer **(1)**.
2. Remove the speaker **(2)** from the computer.

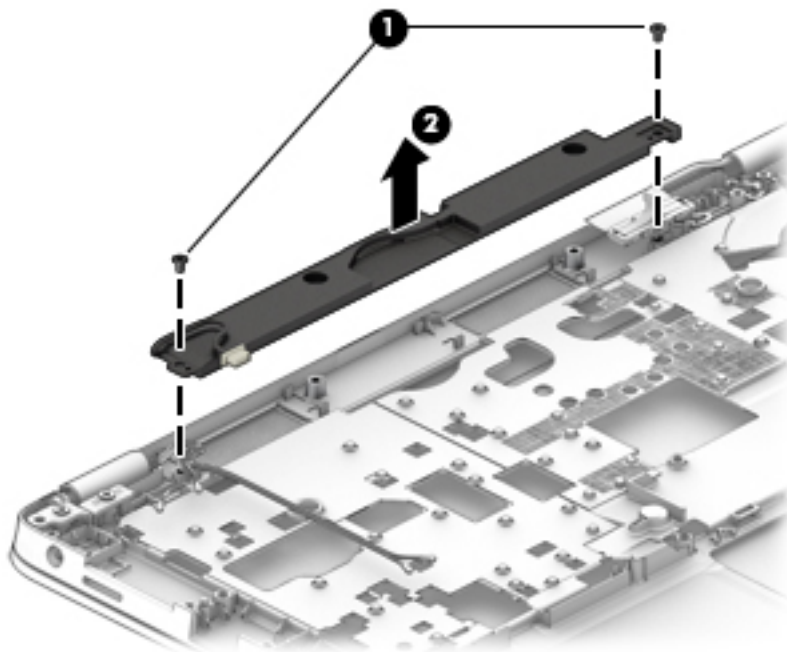

Reverse this procedure to install the speakers.

## Display assembly

Description	Spare part number
12.5-in, FHD (1920×1080), ultraslim eDP, UWVA, TouchScreen display assembly	920050-001

Before removing the display assembly, follow these steps:

1. Shut down the computer. If you are unsure whether the computer is off or in Hibernation, turn the computer on, and then shut it down through the operating system.
2. Disconnect all external devices connected to the computer.
3. Disconnect the power from the computer by first unscrewing the power cord from the AC outlet, and then unscrewing the AC adapter from the computer.
4. Remove the bottom cover (see [Bottom cover on page 33](#)).
5. Remove the battery (see [Battery on page 36](#)).

Remove the display assembly:

1. Position the computer upside down.
2. Disconnect the display cable from the system board.

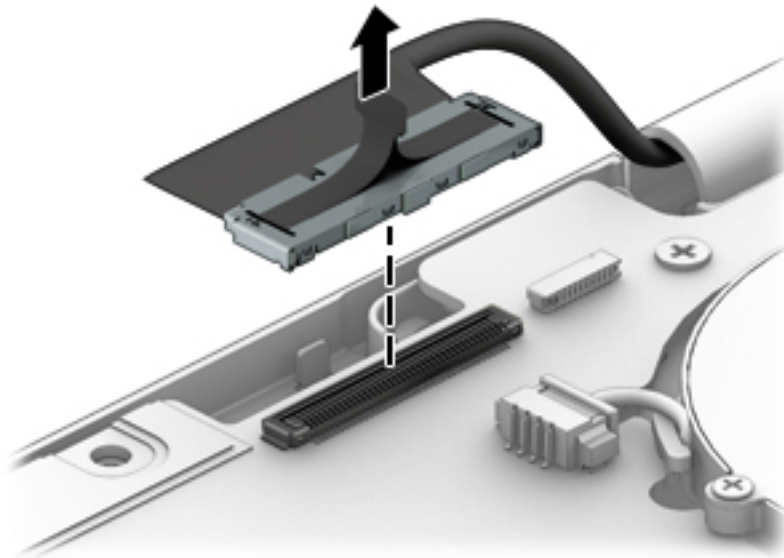

3. Release the WLAN antennas **(1)** and WWAN antennas **(2)** (if equipped) from the routing channel and clips built into the keyboard/top cover.

**⚠ CAUTION:** When installing the display assembly, be sure that the wireless antenna cables are routed and arranged properly. Failure to properly route the antennas can result in degradation of the computer's wireless performance.

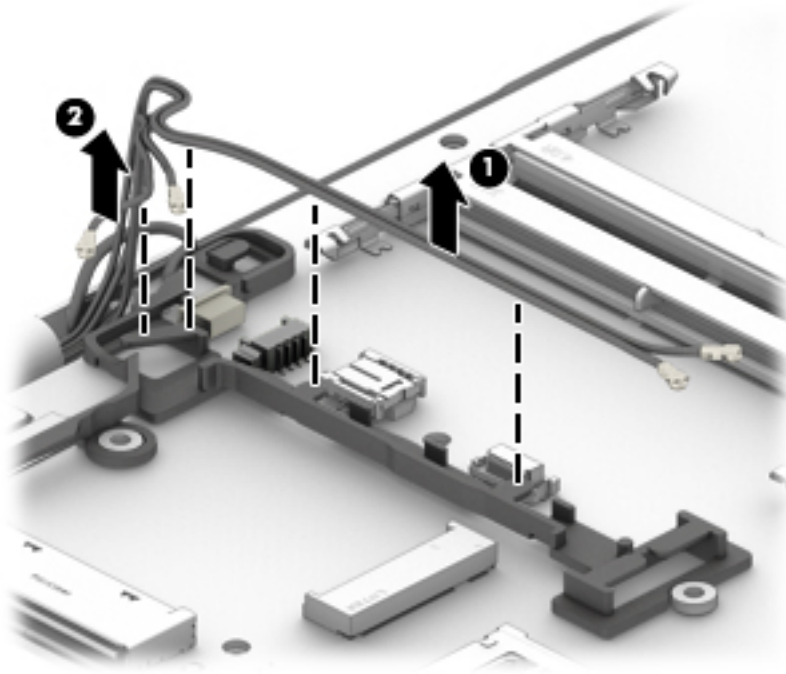

4. Remove the 4 Phillips PM2.5×5.0 screws **(1)** that secure the display assembly to the computer.
5. Swing the hinges **(2)** up and back.
6. Slide the keyboard/top cover **(3)** up and forward at an angle and separate the keyboard/top cover from the display assembly.

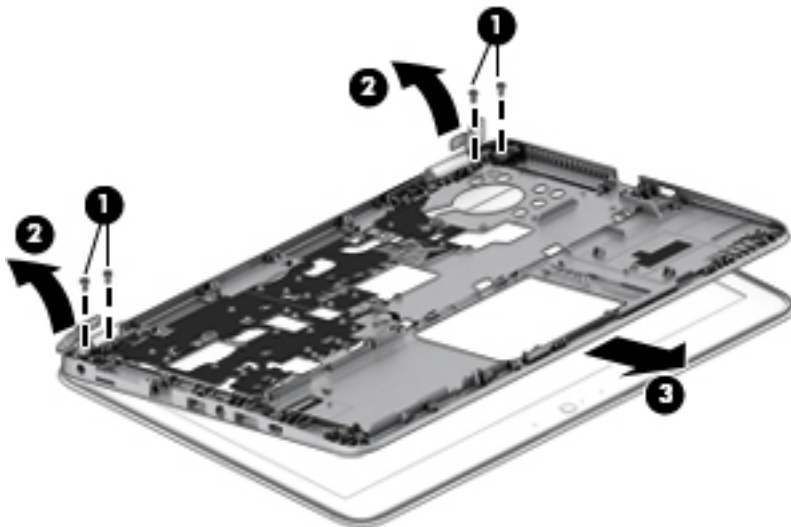

**📝 NOTE:** The following steps apply only to computer models equipped with non-TouchScreen display assemblies.

7. If it is necessary to replace the display bezel or any of the display assembly subcomponents:
  - a. Flex the inside of the top edge **(1)**, the left **(2)** and right sides, and then the bottom edge **(3)** of the bezel until it disengages from the display assembly.

---

 **NOTE:** Make sure the hinges are not bent (see hinge position in following image) when you remove the bezel.

---

- b. Remove the display bezel **(4)**.

The display bezel is available using spare part number 821658-001.

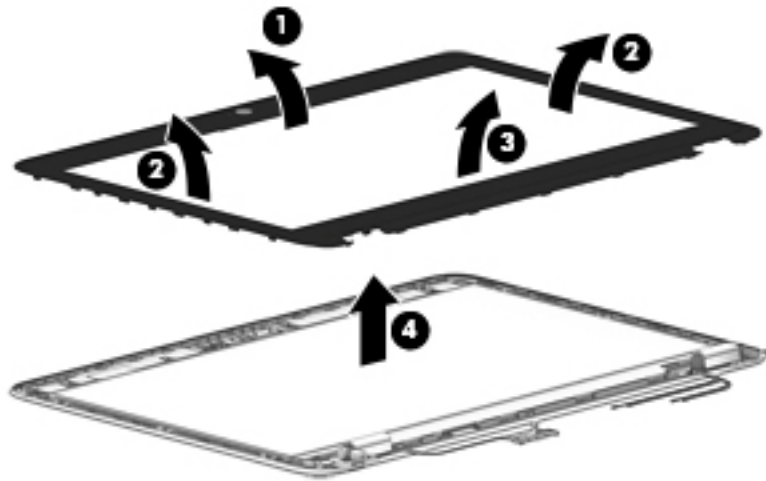

8. If it is necessary to replace the webcam module or microphone module:
  - a. Remove the display bezel.
  - b. Detach the module **(1)** from the display back cover. (The module is attached to the display back cover with double-sided adhesive.)
  - c. Disconnect the module cable **(2)** from the module.



- d. Remove the module.

The webcam module is available using spare part number 800575-020. The microphone module is available using spare part number 920579-001.

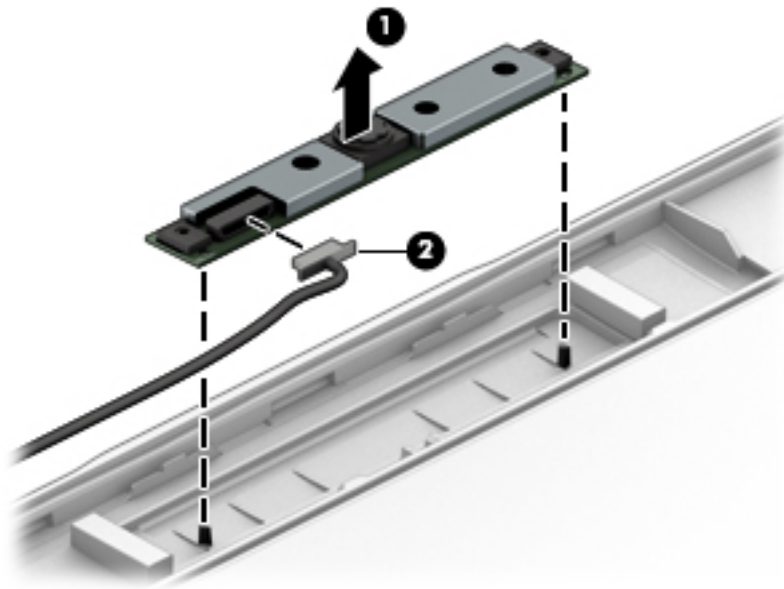

- 9. If it is necessary to replace the display panel:
  - a. Remove the display bezel.
  - b. Remove the 4 Phillips PM2.0×3.0 screws that secure the display panel to the display back cover.

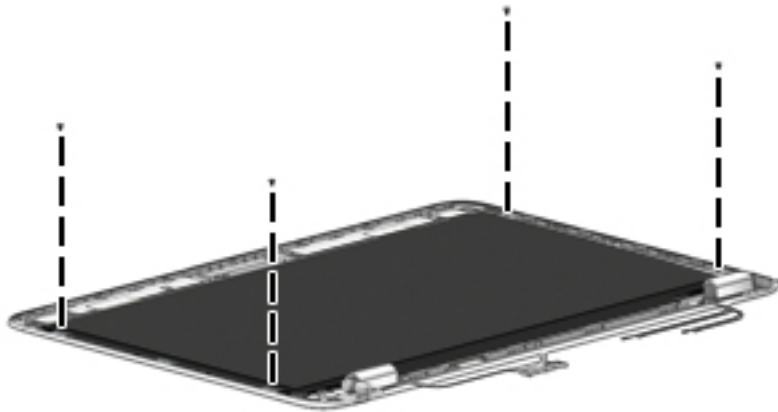

---

**⚠ CAUTION:** Before turning the display panel upside down, make sure the work surface is clear of tools, screws, and any other foreign objects. Failure to follow this caution can result in damage to the display panel.

---

- c. Lift the top edge of the display panel **(1)** and swing it up and forward until it rests upside down in front of the display back cover.

- d. Release the adhesive support strip that secures the display panel cable to the display panel, and then disconnect the display panel cable **(2)** from the display panel.

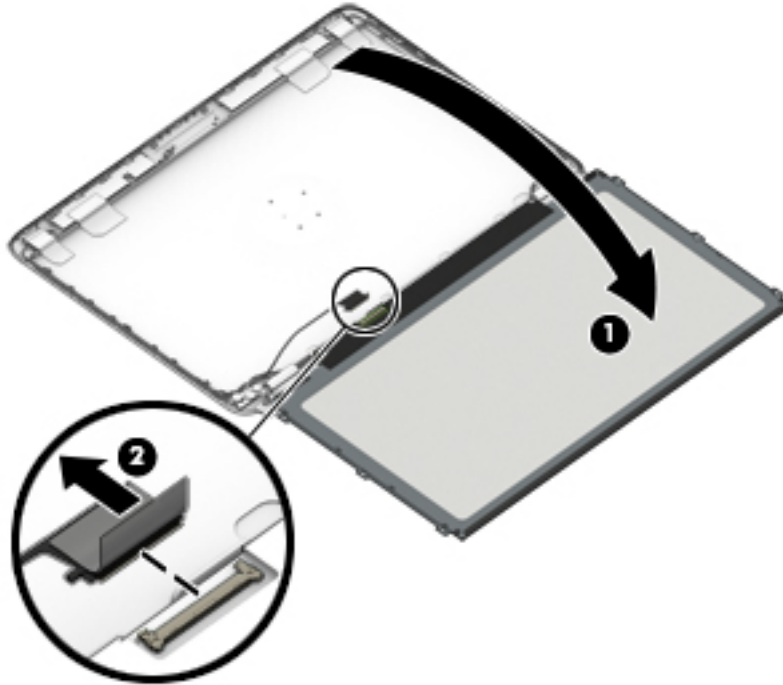

- e. Remove the display panel.

The display panel is available using spare part number 832199-005 (for FHD display panels) and spare part number 804085-003 (for HD display panels).

**10.** If it is necessary to replace the display hinges:

- a. Remove the display bezel.
- b. Remove the display panel.
- c. Remove the two Phillips PM2.0×3.0 screws **(1)** that secure the hinge covers to the display back cover.
- d. Remove the hinge covers **(2)**.

The hinge covers are included in the Plastics Kit, spare part number 821675-001.

- e. Remove the six Phillips PM2.5×2.5 broad head screws **(3)** that secure the hinges to the display back cover.

- f. Remove the display hinges (4).

The display hinges are available using spare part number 821674-001.

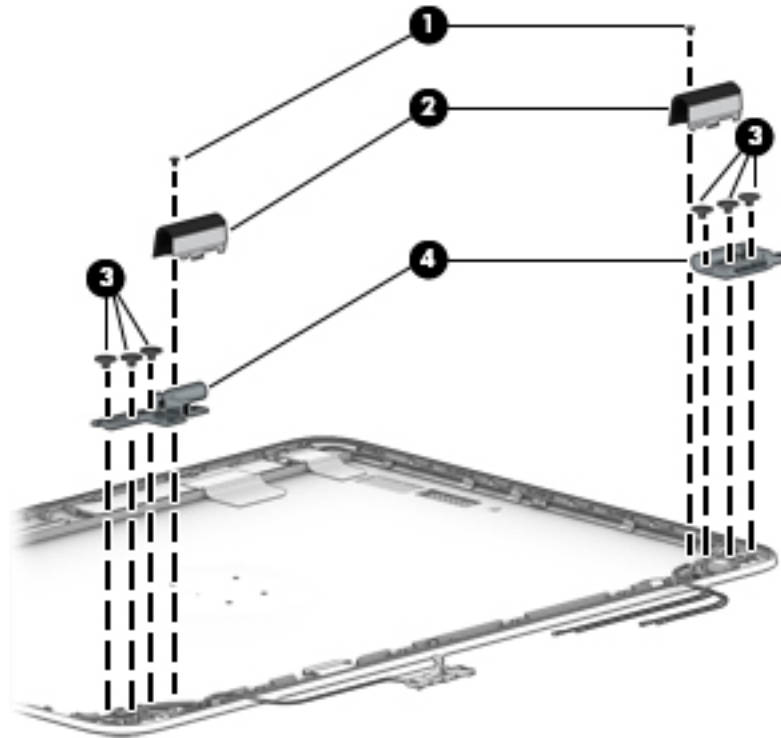

11. If it is necessary to replace the display panel cable:

- a. Remove the display bezel.
- b. Remove the display panel.
- c. Remove the display hinges.
- d. Release the display panel cable from the routing channel (1) and clips built into the top, left and bottom edges of the display back cover.
- e. Remove the display panel cable (2).

The display panel cable is included in the Cable Kit, spare part number 912091-001.

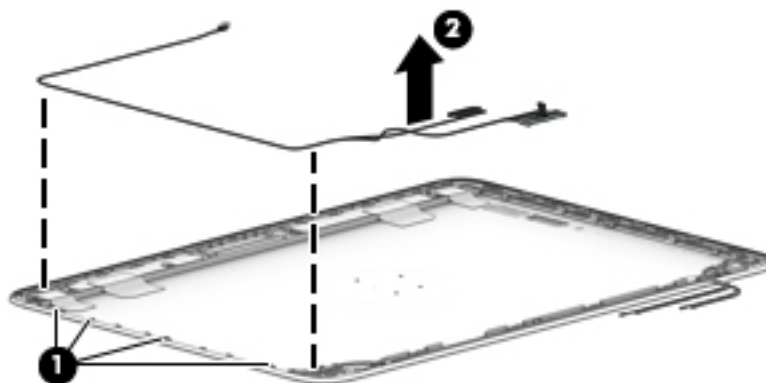

Reverse this procedure to reassemble and install the display assembly.

---

# 7 Computer Setup (BIOS), TPM, and HP Sure Start in Windows 10

## Using Computer Setup

Computer Setup, or Basic Input/Output System (BIOS), controls communication between all the input and output devices on the system (such as disk drives, display, keyboard, mouse, and printer). Computer Setup includes settings for the types of devices installed, the startup sequence of the computer, and the amount of system and extended memory.

---

 **NOTE:** Use extreme care when making changes in Computer Setup. Errors can prevent the computer from operating properly.

---

## Starting Computer Setup

---

 **NOTE:** An external keyboard or mouse connected to a USB port can be used with Computer Setup only if USB legacy support is enabled.

---

To start Computer Setup, follow these steps:

- ▲ Start Computer Setup.
  - Computers or tablets with keyboards:
    - ▲ Turn on or restart the computer, and when the HP logo appears, press **F10** to enter Computer Setup.
  - Tablets without keyboards:
    - ▲ Turn off the tablet. Press the power button in combination with the volume down button until the Startup menu is displayed, and then tap **F10** to enter Computer Setup.

## Navigating and selecting in Computer Setup

- To select a menu or a menu item, use the **tab** key and the keyboard arrow keys and then press **enter**, or use a pointing device to select the item.

---

 **NOTE:** On tablets without keyboards, you can use your finger to make selections.

---

- To scroll up and down, select the up arrow or the down arrow in the upper-right corner of the screen, or use the up arrow key or the down arrow key on the keyboard.
- To close open dialog boxes and return to the main Computer Setup screen, press **esc**, and then follow the on-screen instructions.

To exit Computer Setup menus, choose one of the following methods:

- To exit Computer Setup menus without saving your changes:  
Select the **Exit** icon in the lower-right corner of the screen, and then follow the on-screen instructions.  
– or –  
Select **Main**, select **Ignore Changes and Exit**, and then press [enter](#).
- To save your changes and exit Computer Setup menus:  
Select the **Save** icon in the lower-right corner of the screen, and then follow the on-screen instructions.  
– or –  
Select **Main**, select **Save Changes and Exit**, and then press [enter](#).

Your changes go into effect when the computer restarts.

## Restoring factory settings in Computer Setup

---

 **NOTE:** Restoring defaults will not change the hard drive mode.

---

To return all settings in Computer Setup to the values that were set at the factory, follow these steps:

1. Start Computer Setup. See [Starting Computer Setup on page 66](#).
2. Select **Main**, and then select **Apply Factory Defaults and Exit**.

---

 **NOTE:** On select products, the selections may display **Restore Defaults** instead of **Apply Factory Defaults and Exit**.

---

3. Follow the on-screen instructions.
4. To save your changes and exit, select the **Save** icon in the lower-right corner of the screen, and then follow the on-screen instructions.  
– or –  
Select **Main**, select **Save Changes and Exit**, and then press [enter](#).

Your changes go into effect when the computer restarts.

---

 **NOTE:** Your password settings and security settings are not changed when you restore the factory settings.

---

## Updating the BIOS

Updated versions of the BIOS may be available on the HP website.

Most BIOS updates on the HP website are packaged in compressed files called *SoftPaqs*.

Some download packages contain a file named *Readme.txt*, which contains information regarding installing and troubleshooting the file.

### Determining the BIOS version

To decide whether you need to update Computer Setup (BIOS), first determine the BIOS version on your computer.

BIOS version information (also known as *ROM date* and *System BIOS*) can be accessed by pressing **fn+esc** (if you are already in Windows) or by using Computer Setup.

1. Start Computer Setup. See [Starting Computer Setup on page 66](#).
2. Select **Main**, and then select **System Information**.
3. To exit Computer Setup without saving your changes, select the **Exit** icon in the lower-right corner of the screen, and then follow the on-screen instructions.

– or –

Select **Main**, select **Ignore Changes and Exit**, and then press **enter**.

To check for later BIOS versions, see [Downloading a BIOS update on page 68](#).

### Downloading a BIOS update

---

 **CAUTION:** To reduce the risk of damage to the computer or an unsuccessful installation, download and install a BIOS update only when the computer is connected to reliable external power using the AC adapter. Do not download or install a BIOS update while the computer is running on battery power, docked in an optional docking device, or connected to an optional power source. During the download and installation, follow these instructions:

Do not disconnect power on the computer by unplugging the power cord from the AC outlet.

Do not shut down the computer or initiate Sleep.

Do not insert, remove, connect, or disconnect any device, cable, or cord.

---

1. Type `support` in the taskbar search box, and then select the HP Support Assistant app.  
– or –  
Select the question mark icon in the taskbar.
2. Select **Updates**, and then select **Check for updates and messages**.
3. Follow the on-screen instructions.
4. At the download area, follow these steps:
  - a. Identify the most recent BIOS update and compare it to the BIOS version currently installed on your computer. Make a note of the date, name, or other identifier. You may need this information to locate the update later, after it has been downloaded to your hard drive.
  - b. Follow the on-screen instructions to download your selection to the hard drive.  
Make a note of the path to the location on your hard drive where the BIOS update is downloaded. You will need to access this path when you are ready to install the update.

---

 **NOTE:** If you connect your computer to a network, consult the network administrator before installing any software updates, especially system BIOS updates.

---

BIOS installation procedures vary. Follow any instructions that are revealed on the screen after the download is complete. If no instructions are revealed, follow these steps:

1. Type `file` in the taskbar search box, and then select **File Explorer**.
2. Select your hard drive designation. The hard drive designation is typically Local Disk (C:).
3. Using the hard drive path you recorded earlier, open the folder that contains the update.
4. Double-click the file that has an .exe extension (for example, *filename.exe*).  
The BIOS installation begins.
5. Complete the installation by following the on-screen instructions.

---

 **NOTE:** After a message on the screen reports a successful installation, you can delete the downloaded file from your hard drive.

---

## Changing the boot order using the f9 prompt

To dynamically choose a boot device for the current startup sequence, follow these steps:

1. Access the Boot Device Options menu:
  - Computers or tablets with keyboards:
    - ▲ Turn on or restart the computer, and when the HP logo appears, press **f9** to enter the Boot Device Options menu.
  - Tablets without keyboards:
    - ▲ Turn off the tablet. Press the power button in combination with the volume down button until the Startup menu is displayed, and then tap **F9** to enter the Boot Device Options menu.
2. Select a boot device, then press `enter`.

## TPM BIOS settings (select products only)

---

 **IMPORTANT:** Before enabling Trusted Platform Module (TPM) functionality on this system, you must ensure that your intended use of TPM complies with relevant local laws, regulations and policies, and approvals or licenses must be obtained if applicable. For any compliance issues arising from your operation/usage of TPM which violates the above mentioned requirement, you shall bear all the liabilities wholly and solely. HP will not be responsible for any related liabilities.

---

TPM provides additional security for your computer. You can modify the TPM settings in Computer Setup (BIOS).

---

 **NOTE:** If you change the TPM setting to Hidden, TPM is not visible in the operating system.

---

To access TPM settings in Computer Setup:

1. Start Computer Setup. See [Starting Computer Setup on page 66](#).
2. Select **Security**, select **TPM Embedded Security**, and then follow the on-screen instructions.

## Using HP Sure Start (select products only)

Select computer models are configured with HP Sure Start, a technology that continuously monitors the computer's BIOS for attacks or corruption. If the BIOS becomes corrupted or is attacked, HP Sure Start automatically restores the BIOS to its previously safe state, without user intervention.

HP Sure Start is configured and already enabled so that most users can use the HP Sure Start default configuration. The default configuration can be customized by advanced users.

To access the latest documentation on HP Sure Start, go to <http://www.hp.com/support>, and select your country. Select **Drivers & Downloads**, and then follow the on-screen instructions.



---

## 8 HP PC Hardware Diagnostics (UEFI)

HP PC Hardware Diagnostics is a Unified Extensible Firmware Interface (UEFI) that allows you to run diagnostic tests to determine whether the computer hardware is functioning properly. The tool runs outside the operating system so that it can isolate hardware failures from issues that are caused by the operating system or other software components.

When HP PC Hardware Diagnostics (UEFI) detects a failure that requires hardware replacement, a 24-digit Failure ID is generated. This ID can then be provided to support to help determine how to correct the problem.

---

 **NOTE:** To start diagnostics on a convertible computer, your computer must be in notebook mode and you must use the keyboard attached.

---

To start HP PC Hardware Diagnostics (UEFI), follow these steps:

1. Turn on or restart the computer, quickly press **esc**.

---

 **NOTE:** The HP PC Hardware Diagnostics (UEFI) download instructions are provided in English only, and you must use a Windows computer to download and create the HP UEFI support environment because only .exe files are offered.

---

2. Press or tap **f2**.

The BIOS searches three places for the diagnostic tools, in the following order:

- a. Connected USB drive

---

 **NOTE:** To download the HP PC Hardware Diagnostics (UEFI) tool to a USB drive, see [Downloading HP PC Hardware Diagnostics \(UEFI\) to a USB device on page 71](#).

---

- b. Hard drive
- c. BIOS

3. When the diagnostic tool opens, select the type of diagnostic test you want to run, and then follow the on-screen instructions.

---

 **NOTE:** If you need to stop a diagnostic test, press **esc**.

---

### Downloading HP PC Hardware Diagnostics (UEFI) to a USB device

---

 **NOTE:** The HP PC Hardware Diagnostics (UEFI) download instructions are provided in English only, and you must use a Windows computer to download and create the HP UEFI support environment because only .exe files are offered.

---

There are two options to download HP PC Hardware Diagnostics to a USB device.

#### Download the latest UEFI version

1. Go to <http://www.hp.com/go/techcenter/pcdiags>. The HP PC Diagnostics home page is displayed.
2. In the HP PC Hardware Diagnostics section, click the **Download** link, and then select **Run**.

### Download any version of UEFI for a specific product

1. Go to <http://www.hp.com/support>, and then select your country. The HP Support page is displayed.
2. Click **Drivers & Downloads**.
3. In the text box, enter the product name, and then click **Go**.  
– or –  
Click **Find Now** to let HP automatically detect your product.
4. Select your computer, and then select your operating system.
5. In the **Diagnostic** section, follow the on-screen instructions to select and download the UEFI version you want.

# 9 Backing up and recovering Windows 10

This chapter provides information about the following processes. The information in the chapter is standard procedure for most products.

- Creating recovery media and backups
- Restoring and recovering your system

For additional information, refer to the HP support assistant app.

▲ Type `support` in the taskbar search box, and then select the **HP Support Assistant** app.

– or –

Click the question mark icon in the taskbar.

 **IMPORTANT:** If you will be performing recovery procedures on a tablet, the tablet battery must be at least 70% charged before you start the recovery process.

**IMPORTANT:** For a tablet with a detachable keyboard, connect the keyboard to the keyboard dock before beginning any recovery process.

## Creating recovery media and backups

The following methods of creating recovery media and backups are available on select products only. Choose the available method according to your computer model.

- Use HP Recovery Manager to create HP Recovery media after you successfully set up the computer. This step creates a backup of the HP Recovery partition on the computer. The backup can be used to reinstall the original operating system in cases where the hard drive is corrupted or has been replaced. For information on creating recovery media, see [Creating HP Recovery media \(select products only\) on page 73](#). For information on the recovery options that are available using the recovery media, see [Using Windows tools on page 74](#).
- Use Windows tools to create system restore points and create backups of personal information.

For more information, see [Recovering using HP Recovery Manager on page 75](#).

 **NOTE:** If storage is 32 GB or less, Microsoft System Restore is disabled by default.

## Creating HP Recovery media (select products only)

If possible, check for the presence of the Recovery partition and the Windows partition. From the **Start** menu, select **File Explorer**, and then select **This PC**.

- If your computer does not list the Windows partition and the Recovery partition, you can obtain recovery media for your system from support. See the *Worldwide Telephone Numbers* booklet included with the computer. You can also find contact information on the HP website. Go to <http://www.hp.com/support>, select your country or region, and follow the on-screen instructions.

You can use Windows tools to create system restore points and create backups of personal information, see [Using Windows tools on page 74](#).

- If your computer does list the Recovery partition and the Windows partition, you can use HP Recovery Manager to create recovery media after you successfully set up the computer. HP Recovery media can be used to perform system recovery if the hard drive becomes corrupted. System recovery reinstalls the original operating system and software programs that were installed at the factory and then configures the settings for the programs. HP Recovery media can also be used to customize the system or restore the factory image if you replace the hard drive.
  - Only one set of recovery media can be created. Handle these recovery tools carefully, and keep them in a safe place.
  - HP Recovery Manager examines the computer and determines the required storage capacity for the media that will be required.
  - To create recovery discs, your computer must have an optical drive with DVD writer capability, and you must use only high-quality blank DVD-R, DVD+R, DVD-R DL, or DVD+R DL discs. Do not use rewritable discs such as CD±RW, DVD±RW, double-layer DVD±RW, or BD-RE (rewritable Blu-ray) discs; they are not compatible with HP Recovery Manager software. Or, instead, you can use a high-quality blank USB flash drive.
  - If your computer does not include an integrated optical drive with DVD writer capability, but you would like to create DVD recovery media, you can use an external optical drive (purchased separately) to create recovery discs. If you use an external optical drive, it must be connected directly to a USB port on the computer; the drive cannot be connected to a USB port on an external device, such as a USB hub. If you cannot create DVD media yourself, you can obtain recovery discs for your computer from HP. See the *Worldwide Telephone Numbers* booklet included with the computer. You can also find contact information on the HP website. Go to <http://www.hp.com/support>, select your country or region, and follow the on-screen instructions.
  - Be sure that the computer is connected to AC power before you begin creating the recovery media.
  - The creation process can take an hour or more. Do not interrupt the creation process.
  - If necessary, you can exit the program before you have finished creating all of the recovery DVDs. HP Recovery Manager will finish burning the current DVD. The next time you start HP Recovery Manager, you will be prompted to continue.

To create HP Recovery media:



---

**IMPORTANT:** For a tablet with a detachable keyboard, connect the keyboard to the keyboard dock before beginning these steps.

---

1. Type `recovery` in the taskbar search box, and then select **HP Recovery Manager**.
2. Select **Create recovery media**, and then follow the on-screen instructions.

If you ever need to recover the system, see [Recovering using HP Recovery Manager on page 75](#).

## Using Windows tools

You can create recovery media, system restore points, and backups of personal information using Windows tools.



---

**NOTE:** If storage is 32 GB or less, Microsoft System Restore is disabled by default.

---

For more information and steps, see the Get started app.

- ▲ Select the **Start** button, and then select the **Get started** app.

# Restore and recovery

There are several options for recovering your system. Choose the method that best matches your situation and level of expertise:

 **IMPORTANT:** Not all methods are available on all products.

- Windows offers several options for restoring from backup, refreshing the computer, and resetting the computer to its original state. For more information see the Get started app.
  - ▲ Select the **Start** button, and then select the **Get started** app.
- If you need to correct a problem with a preinstalled application or driver, use the Reinstall drivers and/or applications option (select products only) of HP Recovery Manager to reinstall the individual application or driver.
  - ▲ Type `recovery` in the taskbar search box, select **HP Recovery Manager**, select **Reinstall drivers and/or applications**, and then follow the on-screen instructions.
- If you want to recover the Windows partition to original factory content, you can choose the System Recovery option from the HP Recovery partition (select products only) or use the HP Recovery media. For more information, see [Recovering using HP Recovery Manager on page 75](#). If you have not already created recovery media, see [Creating HP Recovery media \(select products only\) on page 73](#).
- On select products, if you want to recover the computer's original factory partition and content, or if you have replaced the hard drive, you can use the Factory Reset option of HP Recovery media. For more information, see [Recovering using HP Recovery Manager on page 75](#).
- On select products, if you want to remove the recovery partition to reclaim hard drive space, HP Recovery Manager offers the Remove Recovery Partition option.

For more information, see [Removing the HP Recovery partition \(select products only\) on page 78](#).

## Recovering using HP Recovery Manager

HP Recovery Manager software allows you to recover the computer to its original factory state by using the HP Recovery media that you either created or that you obtained from HP, or by using the HP Recovery partition (select products only). If you have not already created recovery media, see [Creating HP Recovery media \(select products only\) on page 73](#).

### What you need to know before you get started

- HP Recovery Manager recovers only software that was installed at the factory. For software not provided with this computer, you must either download the software from the manufacturer's website or reinstall the software from the media provided by the manufacturer.

 **IMPORTANT:** Recovery through HP Recovery Manager should be used as a final attempt to correct computer issues.

- HP Recovery media must be used if the computer hard drive fails. If you have not already created recovery media, see [Creating HP Recovery media \(select products only\) on page 73](#).
- To use the Factory Reset option (select products only), you must use HP Recovery media. If you have not already created recovery media, see [Creating HP Recovery media \(select products only\) on page 73](#).
- If your computer does not allow the creation of HP Recovery media or if the HP Recovery media does not work, you can obtain recovery media for your system from support. See the *Worldwide Telephone Numbers* booklet included with the computer. You can also find contact information from the HP

website. Go to <http://www.hp.com/support>, select your country or region, and follow the on-screen instructions.

---

 **IMPORTANT:** HP Recovery Manager does not automatically provide backups of your personal data. Before beginning recovery, back up any personal data you want to retain.

---

Using HP Recovery media, you can choose from one of the following recovery options:

---

 **NOTE:** Only the options available for your computer display when you start the recovery process.

---

- **System Recovery**—Reinstalls the original operating system, and then configures the settings for the programs that were installed at the factory.
- **Factory Reset**—Restores the computer to its original factory state by deleting all information from the hard drive and re-creating the partitions. Then it reinstalls the operating system and the software that was installed at the factory.

The HP Recovery partition (select products only) allows System Recovery only.

## Using the HP Recovery partition (select products only)

The HP Recovery partition allows you to perform a system recovery without the need for recovery discs or a recovery USB flash drive. This type of recovery can be used only if the hard drive is still working.

To start HP Recovery Manager from the HP Recovery partition:

---

 **IMPORTANT:** For a tablet with a detachable keyboard, connect the keyboard to the keyboard dock before beginning these steps (select products only).

---

1. Type `recovery` in the taskbar search box, select **Recovery Manager**, and then select **HP Recovery Environment**.

- or -

For computers or tablets with keyboards attached, press **f11** while the computer boots, or press and hold **f11** as you press the power button.

For tablets without keyboards:

Turn on or restart the tablet, and then quickly hold down the volume down button; then select **f11**.

- or -

Turn on or restart the tablet, and then quickly hold down the Windows button; then select **f11**.

2. Select **Troubleshoot** from the boot options menu.
3. Select **Recovery Manager**, and then follow the on-screen instructions.

## Using HP Recovery media to recover

You can use HP Recovery media to recover the original system. This method can be used if your system does not have an HP Recovery partition or if the hard drive is not working properly.

1. If possible, back up all personal files.
2. Insert the HP Recovery media, and then restart the computer.

---

 **NOTE:** If the computer does not automatically restart in HP Recovery Manager, change the computer boot order. See [Changing the computer boot order on page 77](#).

---

3. Follow the on-screen instructions.

## Changing the computer boot order

If your computer does not restart in HP Recovery Manager, you can change the computer boot order, which is the order of devices listed in BIOS where the computer looks for startup information. You can change the selection to an optical drive or a USB flash drive.

To change the boot order:



---

**IMPORTANT:** For a tablet with a detachable keyboard, connect the keyboard to the keyboard dock before beginning these steps.

---

1. Insert the HP Recovery media.
2. Access BIOS:

For computers or tablets with keyboards attached:

- ▲ Turn on or restart the computer or tablet, quickly press **esc**, and then press **f9** for boot options.

For tablets without keyboards:

- ▲ Turn on or restart the tablet, and then quickly hold down the volume down button; then select **f9**.

- or -

Turn on or restart the tablet, and then quickly hold down the Windows button; then select **f9**.

3. Select the optical drive or USB flash drive from which you want to boot.
4. Follow the on-screen instructions.

## Removing the HP Recovery partition (select products only)

HP Recovery Manager software allows you to remove the HP Recovery partition to free up hard drive space.



**IMPORTANT:** After you remove the HP Recovery partition, you will not be able to perform System Recovery or create HP recovery media from the HP Recovery partition. So before you remove the Recovery partition, create HP Recovery media; see [Creating HP Recovery media \(select products only\) on page 73](#).



**NOTE:** The Remove Recovery Partition option is only available on products that support this function.

Follow these steps to remove the HP Recovery partition:

1. Type `recovery` in the taskbar search box, and then select **HP Recovery Manager**.
2. Select **Remove Recovery Partition**, and then follow the on-screen instructions.



# 10 Specifications

## Input power

The power information in this section may be helpful if you plan to travel internationally with the computer.

The computer operates on DC power, which can be supplied by an AC or a DC power source. The AC power source must be rated at 100–240 V, 50–60 Hz. Although the computer can be powered from a standalone DC power source, it should be powered only with an AC adapter or a DC power source supplied and approved by HP for use with this computer.

The computer can operate on DC power within the following specifications.

Input Power	Rating
Operating voltage and current	19.5 V dc @ 2.31 A – 45 W
	19.5 V dc @ 3.33 A – 65 W

 **NOTE:** This product is designed for IT power systems in Norway with phase-to-phase voltage not exceeding 240 V rms.

 **NOTE:** The computer operating voltage and current can be found on the system regulatory label.

## Operating environment

Factor	Metric	U.S.
<b>Temperature</b>		
Operating (writing to optical disc)	<b>5°C to 35°C</b>	41°F to 95°F
Nonoperating	<b>-20°C to 60°C</b>	-4°F to 140°F
<b>Relative humidity</b> (noncondensing)		
Operating	<b>10% to 90%</b>	10% to 90%
Nonoperating	<b>5% to 95%</b>	5% to 95%
<b>Maximum altitude</b> (unpressurized)		
Operating	<b>-15 m to 3,048 m</b>	-50 ft to 10,000 ft
Nonoperating	<b>-15 m to 12,192 m</b>	-50 ft to 40,000 ft

# 11 Power cord set requirements

The wide-range input feature of the computer permits it to operate from any line voltage from 100 to 120 volts AC, or from 220 to 240 volts AC.

The 3-conductor power cord set included with the computer meets the requirements for use in the country or region where the equipment is purchased.

Power cord sets for use in other countries and regions must meet the requirements of the country or region where the computer is used.

## Requirements for all countries

The following requirements are applicable to all countries and regions:

- The length of the power cord set must be at least **1.0 m** (3.3 ft) and no more than **2.0 m** (6.5 ft).
- All power cord sets must be approved by an acceptable accredited agency responsible for evaluation in the country or region where the power cord set will be used.
- The power cord sets must have a minimum current capacity of 10 amps and a nominal voltage rating of 125 or 250 V AC, as required by the power system of each country or region.
- The appliance coupler must meet the mechanical configuration of an EN 60 320/IEC 320 Standard Sheet C13 connector for mating with the appliance inlet on the back of the computer.

## Requirements for specific countries and regions

Country/region	Accredited agency	Applicable note number
Australia	EANSW	1
Austria	OVE	1
Belgium	CEBC	1
Canada	CSA	2
Denmark	DEMKO	1
Finland	FIMKO	1
France	UTE	1
Germany	VDE	1
Italy	IMQ	1
Japan	METI	3
The Netherlands	KEMA	1
Norway	NEMKO	1
The People's Republic of China	COC	5
South Korea	EK	4

<b>Country/region</b>	<b>Accredited agency</b>	<b>Applicable note number</b>
Sweden	SEMKO	1
Switzerland	SEV	1
Taiwan	BSMI	4
The United Kingdom	BSI	1
The United States	UL	2

- 1.** The flexible cord must be Type H05VV-F, 3-conductor, 1.0-mm<sup>2</sup> conductor size. Power cord set fittings (appliance coupler and wall plug) must bear the certification mark of the agency responsible for evaluation in the country or region where it will be used.
- 2.** The flexible cord must be Type SPT-3 or equivalent, No. 18 AWG, 3-conductor. The wall plug must be a two-pole grounding type with a NEMA 5-15P (15 A, 125 V) or NEMA 6-15P (15 A, 250 V) configuration.
- 3.** The appliance coupler, flexible cord, and wall plug must bear a “T” mark and registration number in accordance with the Japanese Dentori Law. The flexible cord must be Type VCT or VCTF, 3-conductor, 1.00-mm<sup>2</sup> conductor size. The wall plug must be a two-pole grounding type with a Japanese Industrial Standard C8303 (7 A, 125 V) configuration.
- 4.** The flexible cord must be Type RVV, 3-conductor, 0.75-mm<sup>2</sup> conductor size. Power cord set fittings (appliance coupler and wall plug) must bear the certification mark of the agency responsible for evaluation in the country or region where it will be used.
- 5.** The flexible cord must be Type VCTF, 3-conductor, 0.75-mm<sup>2</sup> conductor size. Power cord set fittings (appliance coupler and wall plug) must bear the certification mark of the agency responsible for evaluation in the country or region where it will be used.

## 12 Statement of memory volatility

The purpose of this chapter is to provide general information regarding nonvolatile memory in HP Business PCs. This chapter also provides general instructions for restoring nonvolatile memory that can contain personal data after the system has been powered off and the hard drive has been removed.

HP Business PC products that use Intel®-based or AMD®-based system boards contain volatile DDR memory. The amount of nonvolatile memory present in the system depends upon the system configuration. Intel-based and AMD-based system boards contain nonvolatile memory subcomponents as originally shipped from HP, assuming that no subsequent modifications have been made to the system and assuming that no applications, features, or functionality have been added to or installed on the system.

Following system shutdown and removal of all power sources from an HP Business PC system, personal data can remain on volatile system memory (DIMMs) for a finite period of time and will also remain in nonvolatile memory. Use the steps below to remove personal data from the PC, including the nonvolatile memory found in Intel-based and AMD-based system boards.

1. Follow steps (a) through (j) below to restore the nonvolatile memory that can contain personal data. Restoring or reprogramming nonvolatile memory that does not store personal data is neither necessary nor recommended.

- a. Turn on or restart the computer, and then press **esc** while the “Press the ESC key for Startup Menu” message is displayed at the bottom of the screen.



**NOTE:** If the system has a BIOS administrator password, enter the password at the prompt.

- b. Select **Main**, select **Restore Defaults**, and then select **Yes** to load defaults.
- c. Select the **Security** menu, select **Restore Security Level Defaults**, and then select **Yes** to restore security level defaults.
- d. If an asset or ownership tag is set, select the **Security** menu and scroll down to the **Utilities** menu. Select **System IDs**, and then select **Asset Tracking Number**. Clear the tag, and then make the selection to return to the prior menu.
- e. If a DriveLock password is set, select the **Security** menu, and scroll down to **Hard Drive Tools** under the **Utilities** menu. Select **Hard Drive Tools**, select **DriveLock**, then uncheck the checkbox for **DriveLock password on restart**. Select **OK** to proceed.
- f. If an Automatic DriveLock password is set, select the **Security** menu, scroll down to **Hard Drive Tools** under the **Utilities** menu. Select **Hard Drive Tools**, scroll down to **Automatic DriveLock**, then select the desired hard drive and disable protection. At the automatic drive lock warning screen, select **Yes** to continue. Repeat this procedure if more than one hard drive has an Automatic DriveLock password.
- g. Select the **Main** menu, and then select **Reset BIOS Security to factory default**. Click **Yes** at the warning message.
- h. Select the **Main** menu, select **Save Changes and Exit**, select **Yes** to save changes and exit, and then select **Shutdown**.

- i. Reboot the system. If the system has a Trusted Platform Module (TPM) and/or fingerprint reader, one or two prompts will appear—one to clear the TPM and the other to Reset Fingerprint Sensor; press or tap **F1** to accept or **F2** to reject.
  - j. Remove all power and system batteries for at least 24 hours.
2. Complete one of the following:
- Remove and retain the storage drive.
  - or –
  - Clear the drive contents by using a third party utility designed to erase data from an solid-state drive.
  - or –
  - Clear the contents of the drive by using the following BIOS Setup Secure Erase command option steps:

---

 **IMPORTANT:** If you clear data using Secure Erase, it cannot be recovered.

---

- a. Turn on or restart the computer, and then press **esc** while the “Press the ESC key for Startup Menu” message is displayed at the bottom of the screen.
  - b. Select the **Security** menu and scroll down to the **Utilities** menu.
  - c. Select **Hard Drive Tools**.
  - d. Under **Utilities**, select **Secure Erase**, select the hard drive storing the data you want to clear, and then follow the on-screen instructions to continue.
- or –
- Clear the contents of the drive by using the following Disk Sanitizer command steps:

---

 **IMPORTANT:** If you clear data using Disk Sanitizer, it cannot be recovered.

---

 **NOTE:** The amount of time it takes for Disk Sanitizer to run can take several hours. Plug the computer into an AC outlet before starting.

---

- a. Turn on or restart the computer, and then press **esc** while the “Press the ESC key for Startup Menu” message is displayed at the bottom of the screen.
- b. Select the **Security** menu and scroll down to the **Utilities** menu.
- c. Select **Hard Drive Tools**.
- d. Under **Utilities**, select **Disk Sanitizer**, select the hard drive storing the data you want to clear, and then follow the on-screen instructions to continue.

## Nonvolatile memory usage

Nonvolatile Memory Type	Amount (Size)	Does this memory store customer data?	Does this memory retain data when power is removed?	What is the purpose of this memory?	How is data input into this memory?	How is this memory write-protected?
HP Sure Start flash (select models only)	2 MBytes	No	Yes	Provides protected backup of critical System BIOS code, EC firmware, and critical PC configuration data for select platforms that support HP Sure Start.  For more information, see <a href="#">Using HP Sure Start (select models only) on page 87</a> .	Data cannot be written to this device via the host processor. The content is managed solely by the HP Sure Start Embedded Controller.	This memory is protected by the HP Sure Start Embedded Controller.
Real Time Clock (RTC) battery backed-up CMOS configuration memory	256 Bytes	No	Yes	Stores system date and time and noncritical data.	RTC battery backed-up CMOS is programmed using the Computer Setup (BIOS), or changing the Microsoft Windows date & time.	This memory is not write-protected.
Controller (NIC) EEPROM	64 KBytes (not customer accessible)	No	Yes	Stores NIC configuration and NIC firmware.	NIC EEPROM is programmed using a utility from the NIC vendor that can be run from DOS.	A utility is required to write data to this memory and is available from the NIC vendor. Writing data to this ROM in an inappropriate manner will render the NIC non-functional.
DIMM Serial Presence Detect (SPD) configuration data	256 Bytes per memory module, 128 Bytes programmable (not customer accessible)	No	Yes	Stores memory module information.	DIMM SPD is programmed by the memory vendor.	Data cannot be written to this memory when the module is installed in a PC. The specific write-protection method varies by memory vendor.
System BIOS	4 MBytes to 5 MBytes	Yes	Yes	Stores system BIOS code and PC configuration data.	System BIOS code is programmed at the factory. Code is updated when the system BIOS is updated. Configuration data and settings are input using the Computer Setup (BIOS) or a custom utility.	<b>NOTE:</b> Writing data to this ROM in an inappropriate manner can render the PC non-functional.  A utility is required for writing data to this memory and is available on the HP website; go to <a href="http://www.hp.com/support">http://www.hp.com/support</a> , and select your country. Select <b>Drivers &amp;</b>

Nonvolatile Memory Type	Amount (Size)	Does this memory store customer data?	Does this memory retain data when power is removed?	What is the purpose of this memory?	How is data input into this memory?	How is this memory write-protected?
Intel Management Engine Firmware (present in only specific ZBook and EliteBook models. For more information, go to <a href="http://www.hp.com/support">http://www.hp.com/support</a> , and select your country. Select <b>Drivers &amp; Downloads</b> , and then follow the on-screen instructions.)	1.5 MBytes or 5 MBytes	Yes	Yes	Stores Management Engine Code, Settings, Provisioning Data and iAMT third-party data store.	Management Engine Code is programmed at the factory. Code is updated via Intel secure firmware update utility. Unique Provisioning Data can be entered at the factory or by an administrator using the Management Engine (MEBx) setup utility. The third party data store contents can be populated by a remote management console or local applications that have been registered by an administrator to have access to the space.	<b>Downloads</b> , and then follow the on-screen instructions.  The Intel chipset is configured to enforce hardware protection to block all direct read/write access to this area. An Intel utility is required for updating the firmware. Only firmware updates digitally signed by Intel can be applied using this utility.
Bluetooth flash	2 Mbit	No	Yes	Stores Bluetooth configuration and firmware.	Bluetooth flash is programmed at the factory. Tools for writing data to this memory are not publicly available but can be obtained from the silicon vendor.	A utility is required for writing data to this memory and is made available through newer versions of the driver whenever the flash requires an upgrade.
802.11 WLAN EEPROM	4 Kbit to 8 Kbit	No	Yes	Stores configuration and calibration data.	802.11 WLAN EEPROM is programmed at the factory. Tools for writing data to this memory are not made public.	A utility is required for writing data to this memory and is typically not made available to the public unless a firmware upgrade is necessary to address a unique issue.
Web camera	64 Kbit	No	Yes	Stores webcam configuration and firmware.	Webcam memory is programmed using a utility from the device manufacturer that can be run from Windows.	A utility is required for writing data to this memory and is typically not made available to the public unless a firmware upgrade is necessary to address a unique issue.
Fingerprint reader	512 KByte flash	Yes	Yes	Stores fingerprint templates.	Fingerprint reader memory is programmed by user enrollment in HP ProtectTools Security Manager.	Only a digitally signed application can make the call to write to the flash.

## Questions and answers

### 1. How can the BIOS settings be restored (returned to factory settings)?



**IMPORTANT:** Restore defaults does not securely erase any data on your hard drive. See question and answer 6 for steps to securely erase data.

Restore defaults does not reset the Custom Secure Boot keys. See question and answer 7 for information about resetting the keys.

- a. Turn on or restart the computer, and then press **esc** while the “Press the ESC key for Startup Menu” message is displayed at the bottom of the screen.
- b. Select **Main**, and then select **Restore defaults**.
- c. Follow the on-screen instructions.
- d. Select **Main**, select **Save Changes and Exit**, and then follow the on-screen instructions.

### 2. What is a UEFI BIOS, and how is it different from a legacy BIOS?

The Unified Extensible Firmware Interface (UEFI) BIOS is an industry-standard software interface between the platform firmware and an operating system (OS). It is a replacement for the older BIOS architecture, but supports much of the legacy BIOS functionality.

Like the legacy BIOS, the UEFI BIOS provides an interface to display the system information and configuration settings and to change the configuration of your computer before an OS is loaded. BIOS provides a secure run-time environment that supports a Graphic User Interface (GUI). In this environment, you can use either a pointing device (Touchscreen, TouchPad, pointing stick, or USB mouse) or the keyboard to navigate and make menu and configuration selections. The UEFI BIOS also contains basic system diagnostics.

The UEFI BIOS provides functionality beyond that of the legacy BIOS. In addition, the UEFI BIOS works to initialize the computer’s hardware before loading and executing the OS; the run-time environment allows the loading and execution of software programs from storage devices to provide more functionality, such as advanced hardware diagnostics (with the ability to display more detailed system information) and advanced firmware management and recovery software.

HP has provided options in Computer Setup (BIOS) to allow you to run in legacy BIOS, if required by the operating system. Examples of this requirement would be if you upgrade or downgrade the OS.

### 3. Where does the UEFI BIOS reside?

The UEFI BIOS resides on a flash memory chip. A utility is required to write to the chip.

### 4. What kind of configuration data is stored on the DIMM Serial Presence Detect (SPD) memory module? How would this data be written?

The DIMM SPD memory contains information about the memory module, such as size, serial number, data width, speed/timing, voltage, and thermal information. This information is written by the module manufacturer and stored on an EEPROM. This EEPROM cannot be written to when the memory module is installed in a PC. Third-party tools do exist that can write to the EEPROM when the memory module is not installed in a PC. Various third-party tools are available to read SPD memory.

### 5. What is meant by “Restore the nonvolatile memory found in Intel-based system boards”?

This message relates to clearing the Real Time Clock (RTC) CMOS memory that contains PC configuration data.

### 6. How can the BIOS security be reset to factory defaults and data erased?



---

 **IMPORTANT:** Resetting will result in the loss of information.

These steps will not reset Custom Secure Boot Keys. See question and answer 7 for information about resetting the keys.

---

- a. Turn on or restart the computer, and then press **esc** while the “Press the ESC key for Startup Menu” message is displayed at the bottom of the screen.
- b. Select **Main**, and then select **Reset BIOS Security to Factory Default**.
- c. Follow the on-screen instructions.
- d. Select **Main**, select **Save Changes and Exit**, and then follow the on-screen instructions.

#### 7. How can the Custom Secure Boot Keys be reset?

Secure Boot is a feature to ensure that only authenticated code can start on a platform. If you enabled Secure Boot and created Custom Secure Boot Keys, simply disabling Secure Boot will not clear the keys. You must also select to clear the Custom Secure Boot Keys. Use the same Secure Boot access procedure you used to create the Custom Secure Boot Keys, but make the selection to clear or delete all Secure Boot Keys.

- a. Turn on or restart the computer, and then press **esc** while the “Press the ESC key for Startup Menu” message is displayed at the bottom of the screen.
- b. Select the **Security** menu, select **Secure Boot Configuration**, and then follow the on-screen instructions.
- c. At the **Secure Boot Configuration** window, select **Secure Boot**, select **Clear Secure Boot Keys**, and then follow the on-screen instructions to continue.

## Using HP Sure Start (select models only)

Select computer models are configured with HP Sure Start, a technology that continuously monitors your computer's BIOS for attacks or corruption. If the BIOS becomes corrupted or is attacked, HP Sure Start restores the BIOS to its previously safe state, without user intervention. Those select computer models ship with HP Sure Start configured and enabled. HP Sure Start is configured and already enabled so that most users can use the HP Sure Start default configuration. The default configuration can be customized by advanced users.

To access the latest documentation on HP Sure Start, go to <http://www.hp.com/support>, and select your country. Select **Drivers & Downloads**, and then follow the on-screen instructions.

---

# 13 Recycling

When a non-rechargeable or rechargeable battery has reached the end of its useful life, do not dispose of the battery in general household waste. Follow the local laws and regulations in your area for battery disposal.

HP encourages customers to recycle used electronic hardware, HP original print cartridges, and rechargeable batteries. For more information about recycling programs, see the HP Web site at <http://www.hp.com/recycle>.

# Index

## A

- AC adapter dongle, spare part number 26
- AC adapter, spare part numbers 26
- antenna
  - location 9
  - spare part number 23
- antennas
  - disconnecting 42, 44
- audio, product description 2
- audio-in jack 6
- audio-out jack 6

## B

- back cover
  - spare part number 23
- backpack, spare part number 26
- backups 73
- battery
  - removal 36
  - spare part number 20, 36
- battery light 15
- bezel
  - removal 62
  - spare part number 22, 62
- BIOS
  - determining version 68
  - downloading an update 68
  - updating 68
- boot order
  - changing 77
- bottom components 14
- bottom cover
  - removal 33
  - spare part number 21, 33
- button components 12
- buttons
  - pointing stick 10
  - power 12
  - TouchPad 10
  - TouchPad on/off 10

## C

- Cable Kit
    - contents 24
    - spare part number 24
  - cable lock, spare part numbers 26
  - caps lock light 11
  - case, spare part number 26
  - case, spare part numbers 26
  - chipset, product description 1
  - components
    - bottom 14
    - button 12
    - display 9
    - fingerprint reader 12
    - front 15
    - keys 13
    - left side 8
    - lights 11
    - right side 6
    - speaker 12
    - top 10
    - TouchPad 10
  - computer major components 17
  - Computer Setup
    - navigating and selecting 66
    - restoring factory settings 67
  - connectors
    - docking 7, 14
    - power 7
- ## D
- display
    - components 9
  - display assembly
    - removal 59
    - spare part numbers 59
    - subcomponents 22
  - display panel
    - product description 1
    - removal 63
    - spare part numbers 22, 64
  - display panel cable
    - removal 65
    - spare part number 23, 65
  - display panel cable, illustrated 24

- DisplayPort-to-HDMI 1.4 adapter, spare part number 26
- docking connector 7, 14
- docking station, spare part number 26
- docking station, spare part numbers 26
- drive light 15
- Dual-Mode DisplayPort 6
- DVD±RW DL SuperMulti Drive, spare part number 26

## E

- embedded numeric keypad 13
- esc key 13
- Ethernet, product description 2
- external monitor port 8

## F

- fan/heat sink assembly
  - spare part number 20
- fingerprint reader 12
- fingerprint reader assembly
  - removal 55
  - spare part number 55
- fingerprint reader blank, illustrated 23
- fingerprint reader board
  - spare part number 20
- fingerprint reader components 12
- fn key 13
- front components 15

## G

- graphics, product description 1

## H

- hard drive
  - product description 1, 2
  - removal 37
  - spare part numbers 20, 25, 37
- Hard Drive Hardware Kit
  - spare part number 20, 25
- HDMI-to-VGA adapter, spare part number 26

- headphone jack 6
- heat sink
  - removal 53
  - spare part numbers 53
- hinge
  - removal 64
  - spare part number 23, 65
- hinge cover
  - removal 64
  - spare part number 23, 64
- hinge covers, illustrated 23
- HP PC Hardware Diagnostics (UEFI)
  - using 71
- HP Recovery Manager
  - correcting boot problems 77
  - starting 76
- HP Recovery media
  - creating 73
  - recovery 76
- HP Recovery partition
  - recovery 76
  - removing 78
- HP Sure Start 87

**I**

- input power 79
- integrated webcam light 9
- internal microphones 9

**J**

- jacks
  - audio-in 6
  - audio-out 6
  - headphone 6
  - microphone 6
  - network 6
  - RJ-45 6

**K**

- key components 13
- keyboard
  - product description 3
  - removal 46
  - spare part numbers 17, 18, 46
- keys
  - embedded numeric keypad 13
  - esc 13
  - fn 13
  - num lock 13
  - numeric keypad 13
  - Windows key 13

**L**

- labels
  - serial number 16
- left-side components 8
- legacy support, USB 66
- light components 11
- lights
  - battery 15
  - caps lock 11
  - drive 15
  - microphone mute 11
  - network 6
  - num lock 11
  - power 11, 15
  - RJ-45 6
  - TouchPad 10
  - volume mute 11
  - webcam 9
  - wireless 11, 15

**M**

- memory
  - nonvolatile 82
  - volatile 82
- memory card reader 6
- memory module
  - product description 1
  - removal 40
  - spare part number 20
  - spare part numbers 40
- microphone
  - product description 2
- microphone jack 6
- microphone module
  - removal 62
  - spare part number 22, 63
- microphone mute light 11
- microphones 9
- minimized image recovery 76
- minimized image, creating 75
- model name 1
- monitor port 8
- mouse, spare part numbers 26

**N**

- network jack 6
- network lights 6
- NFC module
  - removal 57
  - spare part number 20, 57

- NFC module cable, illustrated 24
- nonvolatile memory 82
- num lock key 13
- num lock light 11
- numeric keypad 13

**O**

- operating environment 79
- operating system, product
  - description 3, 4, 5
- optical drive, spare part number 26
- original system recovery 75

**P**

- Plastics Kit
  - contents 23
  - spare part number 23
- pointing device, product
  - description 3
- pointing stick 10
- pointing stick cable, illustrated 24
- pointing stick covers, spare part number 27
- ports
  - Dual-Mode DisplayPort 6
  - external monitor 8
  - monitor 8
  - product description 3
  - USB 3.1 charging (powered) 8
  - USB Type-C (charging) 6
- power button 12
- power connector 7
- power cord
  - set requirements 80
  - spare part numbers 26, 27
- power light 11, 15
- power requirements, product
  - description 3
- processor
  - product description 1
- product description
  - audio 2
  - chipset 1
  - display panel 1
  - Ethernet 2
  - external media cards 3
  - graphics 1
  - hard drive 1, 2
  - keyboard 3
  - memory module 1

- microphone 2
- operating system 3, 4, 5
- pointing device 3
- ports 3
- power requirements 3
- processors 1
- product name 1
- security 3
- serviceability 5
- video 2
- wireless 2, 3
- product name 1
- product name and number, computer 16

**R**

- recover
  - options 75
- recovery
  - discs 74, 76
  - HP Recovery Manager 75
  - media 76
  - starting 76
  - supported discs 74
  - system 75
  - USB flash drive 76
  - using HP Recovery media 74
- recovery media
  - creating 73
  - creating using HP Recovery Manager 74
- recovery partition
  - removing 78
- regulatory information 16
- removal/replacement
  - procedures 33, 49
- removing personal data from volatile system memory 82
- right-side components 6
- RJ-45 jack 6
- RJ-45 lights 6
- RTC battery
  - removal 52
  - spare part number 21, 52

**S**

- Screw Kit, spare part number 27
- SD card blank, illustrated 23
- security cable slot 8
- security, product description 3

- serial number 16
- serial number, computer 16
- serviceability, product description 5
- setup utility
  - navigating and selecting 66
  - restoring factory settings 67
- SIM
  - spare part number 26
- SIM card slot 7
- slots
  - security cable 8
  - SIM card 7
  - smart card 8
- smart card reader board
  - removal 58
  - spare part number 20, 58
- smart card slot 8
- solid-state drive
  - removal 38
  - spare part numbers 20, 25, 38
- speaker assembly
  - removal 59
  - spare part number 21, 59
- speaker components 12
- speakers
  - location 12
- supported discs, recovery 74
- Sure Start
  - using 70
- system board
  - removal 49
  - spare part number 20
  - spare part numbers 49
- system information
  - locating 16
- system memory, removing personal data from volatile 82
- system recovery 75
- system restore point
  - creating 74
- system restore point, creating 73

**T**

- top cover
  - spare part number 19
- TouchPad
  - buttons 10
  - components 10
  - zone 10

- TouchPad button board
  - removal 56
  - spare part number 20, 56
- TouchPad light 10
- TouchPad on/off button 10
- TPM settings 69

**U**

- USB 3.1 charging (powered) port 8
- USB 3.1 port 6
- USB legacy support 66
- USB ports 6
- USB Type-C (charging) port 6

**V**

- vents 8, 14
- video, product description 2
- volume mute light 11

**W**

- warranty period 16
- webcam 9
- webcam light 9
- webcam module
  - removal 62
  - spare part number 22, 63
- webcam, location 9
- Windows
  - system restore point 73, 74
- Windows key 13
- Windows tools
  - using 74
- wireless antenna
  - location 9
  - spare part number 23
- wireless antennas
  - disconnecting 42, 44
- wireless light 11, 15
- wireless, product description 2, 3
- WLAN antenna
  - location 9
  - spare part number 23
- WLAN module
  - removal 42
  - spare part numbers 20, 42
- WWAN antenna
  - location 9
  - spare part number 23
- WWAN module
  - removal 44
  - spare part numbers 20, 44

## Free Manuals Download Website

<http://myh66.com>

<http://usermanuals.us>

<http://www.somanuals.com>

<http://www.4manuals.cc>

<http://www.manual-lib.com>

<http://www.404manual.com>

<http://www.luxmanual.com>

<http://aubethermostatmanual.com>

Golf course search by state

<http://golfingnear.com>

Email search by domain

<http://emailbydomain.com>

Auto manuals search

<http://auto.somanuals.com>

TV manuals search

<http://tv.somanuals.com>