

**hp** LaserJet 9000  
9000n • 9000dn • 9000hns



i n v e n t

**start**





HP LaserJet 9000, 9000n,  
9000dn, and 9000hns printers

**Start** \_\_\_\_\_

**Copyright © Hewlett-Packard  
Company 2001**

All Rights Reserved.  
Reproduction, adaptation, or  
translation without prior written  
permission is prohibited, except  
as allowed under the copyright  
laws.

Publication number  
C8519-90910

First Edition, May 2001

**Warranty**

The information contained in  
this document is subject to  
change without notice.

Hewlett-Packard makes no  
warranty of any kind with  
respect to this information.  
HEWLETT-PACKARD  
SPECIFICALLY DISCLAIMS  
THE IMPLIED WARRANTY OF  
MERCHANTABILITY AND  
FITNESS FOR A PARTICULAR  
PURPOSE.

Hewlett-Packard shall not be  
liable for any direct, indirect,  
incidental, consequential, or  
other damage alleged in  
connection with the furnishing or  
use of this information.

**Trademark Credits**

Microsoft, MS Windows,  
Windows and Windows NT are  
U.S. registered trademarks of  
Microsoft Corporation.

All other products mentioned  
herein may be trademarks of  
their respective companies.

# Printer Setup

## Contents

Introduction . . . . .	4
Installation checklist . . . . .	5
Prepare printer location . . . . .	6
Check package contents . . . . .	8
Locate printer parts . . . . .	9
Remove internal packaging . . . . .	10
Install accessories . . . . .	11
Install print cartridge . . . . .	12
Load Trays 2 and 3 . . . . .	14
Connect printer cables . . . . .	16
Connecting a parallel cable . . . . .	17
Connecting to Ethernet 10/100Base-TX network . . . . .	18
Connect power cord . . . . .	19
Change the control panel overlay . . . . .	20
Configure the control panel display language . . . . .	22
Print a configuration page . . . . .	23
Install printing software . . . . .	24
Installing Windows printing software . . . . .	25
Installing Macintosh printing software . . . . .	26
Verify printer setup . . . . .	27
Customer support options worldwide . . . . .	28
Warranty and regulatory information . . . . .	31
Hewlett-Packard limited warranty statement . . . . .	31
Limited Warranty for Print Cartridge Life . . . . .	33
HP Software License Terms . . . . .	34
FCC regulations . . . . .	36
Safety Information . . . . .	38
Declaration of Conformity . . . . .	40

# Introduction

Congratulations on your purchase of the HP LaserJet 9000 Series printer. This series of printers is available in four configurations.



## HP LaserJet 9000 printer

The HP LaserJet 9000 printer (product number C8519A) comes standard with 64 Megabyte (MB) RAM, wide-format printing, and two 500-sheet trays.

---

### Note

---

The HP LaserJet 9000 requires an optional enhanced input/output (EIO) card to connect to a network.



## HP LaserJet 9000n printer

The HP LaserJet 9000n printer (product number C8520A) comes standard with 64 MB RAM, wide-format printing, two 500-sheet trays, a 100-sheet multipurpose tray (optional Tray 1), and an optional HP Jetdirect print server.



## HP LaserJet 9000dn printer

The HP LaserJet 9000dn printer (product number C8521A) comes standard with 64 MB RAM, wide-format printing, two 500-sheet trays, a 100-sheet multipurpose tray (optional Tray 1), an optional HP Jetdirect print server, and an optional duplex printing accessory (for printing on both sides of paper).



## HP LaserJet 9000hns printer

The HP LaserJet 9000hns printer (product number C8522A) contains the HP LaserJet 9000dn, a 2,000-sheet input tray (optional Tray 4), and an optional 3,000-sheet stapler/stacker or an optional 3,000-sheet stacker.

# Installation checklist

This guide will help you set up and install your new printer. For proper installation, please complete each section in order:

- Unpack the printer                      steps 1-4
- Install the printer                        steps 5-12
- Install printing software                step 13
- Verify printer setup                      step 14

---

## **WARNING!**

---

The printer is heavy. HP recommends that four people move it to avoid injury to you and damage to the printer.

# Step 1 Prepare printer location

## Printer size

Prepare a location for the printer that allows for these physical and environmental requirements:

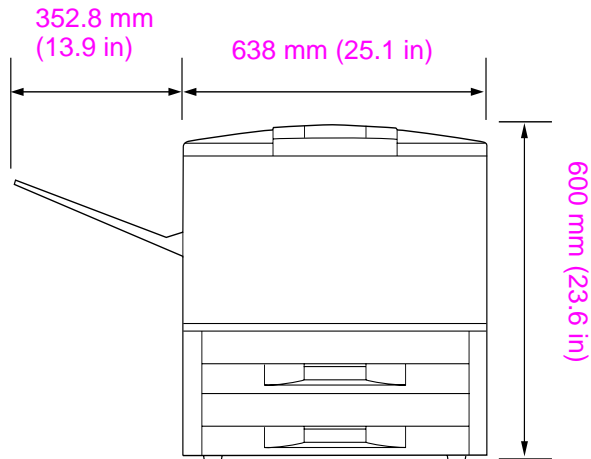
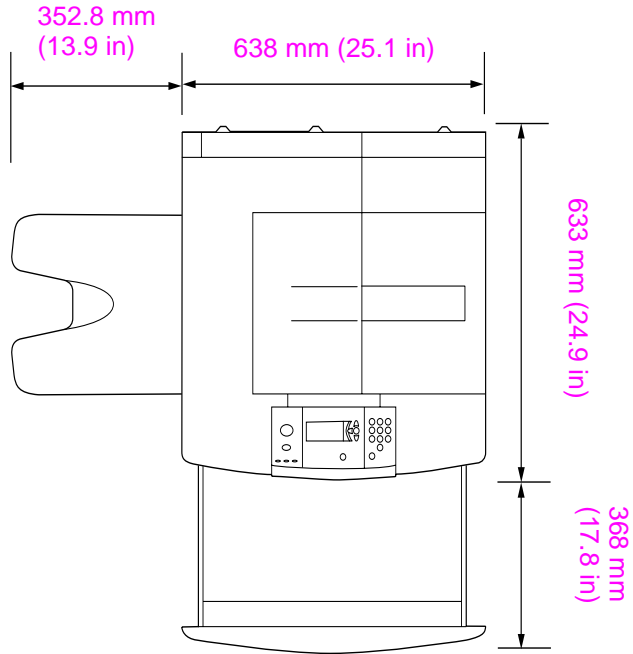

**HP LaserJet 9000 Printer Dimensions (top and side views)**



## Location requirements for the printer

---

- A level area on the floor
- Space allowance around the printer
- A well-ventilated room
- No exposure to direct sunlight or chemicals, including ammonia-based cleaning solutions
- Adequate power supply (15A, 110V or 220V circuit located near the printer)
- A stable environment—no abrupt temperature or humidity changes
- Relative humidity 20 percent to 80 percent
- Room temperature 50°F to 91° F (10° C to 32.5° C)

## Printer weight (without print cartridge)

- HP LaserJet 9000 printer: 63.5 kg (140 lb)
- HP LaserJet 9000n printer: 69.4 kg (153 lb)
- HP LaserJet 9000dn printer: 76.2 kg (168 lb)
- HP LaserJet 9000hns printer: 76.2 kg (168 lb)

# Step 2 Check package contents

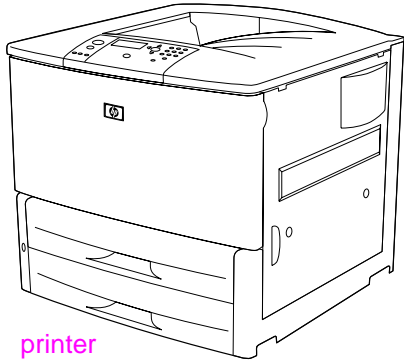

printer

power cord



face-up output bin

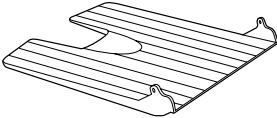

control panel overlay

printer documentation (this manual)

print cartridge

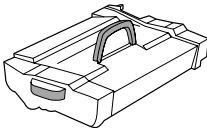

printer software CD-ROM (including user manual)

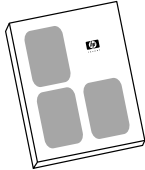

## Package contents

## Step 3 Locate printer parts

The following illustrations give the location and names of the important printer parts.

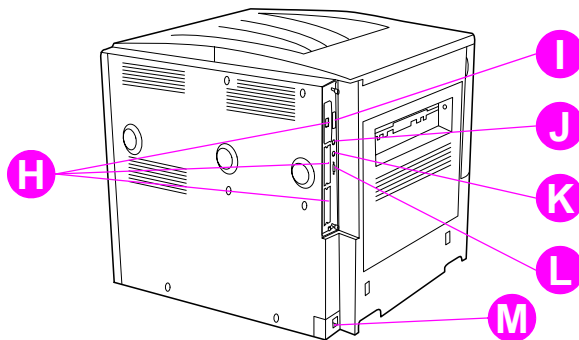
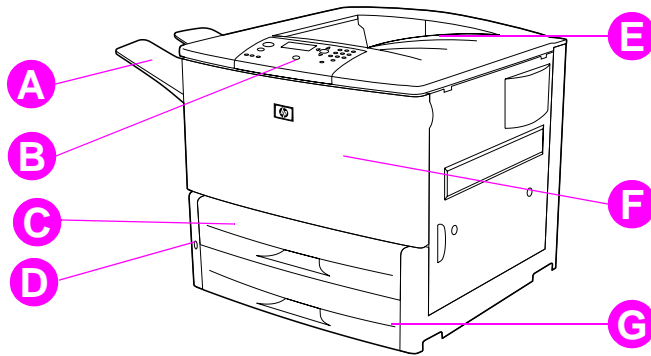

### Printer parts (front and rear views)

- |  |                                   |  |
|--|-----------------------------------|--|
| <b>A</b> Face-up bin                         | <b>F</b> Front door               | <b>J</b> Foreign interface harness (AUX) |
| <b>B</b> Control panel                       | <b>G</b> Tray 3                   | <b>K</b> HP Fast InfraRed (FIR) Connect  |
| <b>C</b> Tray 2                              | <b>H</b> EIO slots (3)            | <b>L</b> HP Jet-Link connector           |
| <b>D</b> Power switch                        | <b>I</b> Parallel cable connector | <b>M</b> Power cord connector            |
| <b>E</b> Standard output bin (Face-down bin) |                                   |  |

## Step 4 Remove internal packaging

Remove all packaging from the printer.

---

**WARNING!**

---

This printer weighs approximately 63.5 kg (140 lb). HP recommends that four people move it to avoid injury to you and damage to the printer.

### To remove internal packaging

- 1 Remove all orange packing material from the exterior of the printer and remove any cardboard or styrofoam material that is not orange.
- 2 Remove all orange packing material from the standard output bin and the protective film from the display.
- 3 Open the left-side door and remove the two packing fuser spacers. Orange tape connects fuser spacers to the outside of left door. Remove the orange tape from the fuser shipping locks to the outside of the door. Close the door after removing the fuser spacers and the tape.
- 4 Open the trays, remove any orange packing material, and close the trays.
- 5 Open the front door and remove the orange packing tape at the front transfer roller area and on the lock lever for the print cartridge. Close the door.

---

**Note**

---

Save all packing material. You may need it to repack the printer at a later date.

## Step 5 Install accessories

Install any paper-handling accessories that you purchased with the printer or separately. Use the installation instructions that are packaged with the accessories.

If you have a 3,000-sheet stapler/stacker (or stacker) and a duplexer, Tray 4, or both, install the duplexer and Tray 4 before trying to install the 3,000 sheet stapler/stacker (or stacker).

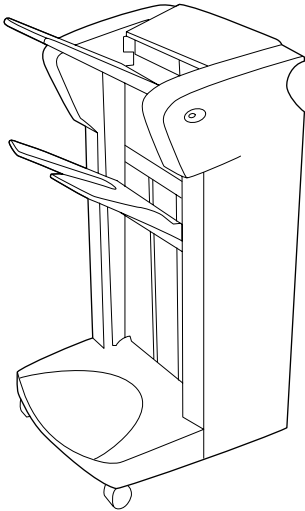

3,000-sheet stapler/stacker



HP Fast InfraRed Connect

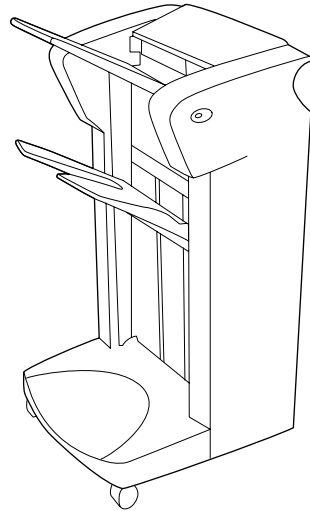

3,000-sheet stacker

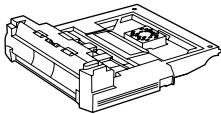

Duplex printing accessory (duplexer)

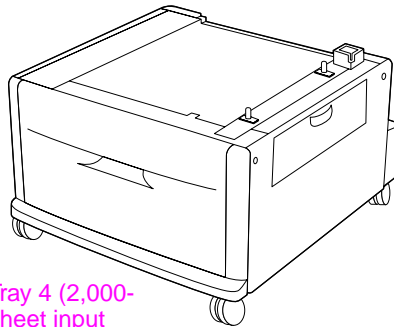

Tray 4 (2,000-sheet input tray)

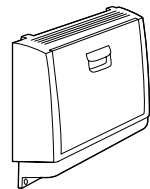

Tray 1 (multipurpose tray)

### Optional accessories

## Step 6 Install print cartridge

Use this procedure to install the print cartridge. If toner gets on your clothing, wipe it off with a dry cloth and wash the clothing in cold water. Hot water sets toner into fabric.

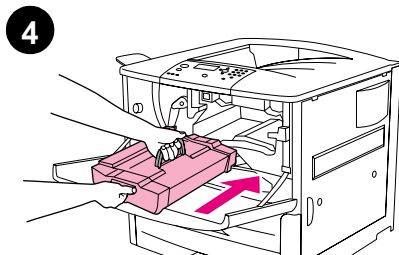
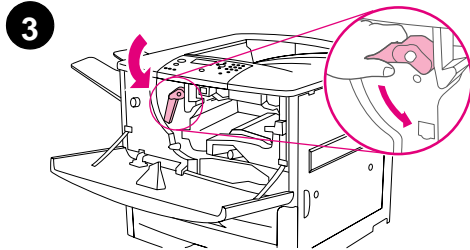
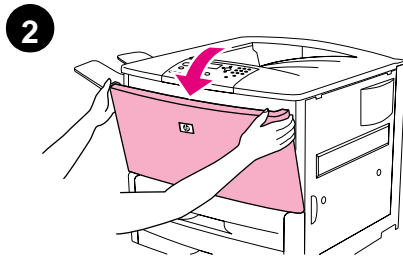
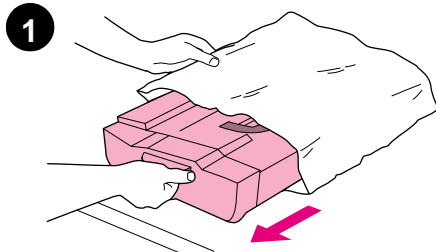

### To install the print cartridge

- 1 Before removing the print cartridge from its packaging, set the print cartridge on a sturdy surface. Gently slide the print cartridge out of the packaging.

---

#### CAUTION

To prevent damage to the print cartridge, use two hands when removing it from its packaging.

---

---

#### Note

The print cartridge does not have a pull tab.

---

- 2 Open the front door on the printer.
- 3 Rotate the lever downward to the unlock position.
- 4 Position the cartridge as shown with the arrow on the left side pointing into the printer and align it with the printer guides. Slide the cartridge into the printer as far as it will go.

**5**

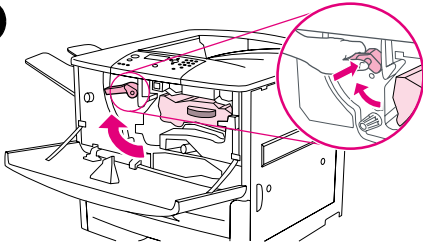

**5** Press the button on the green lever, and turn the lever clockwise to the locked position.

**6** Close the front door.

**6**

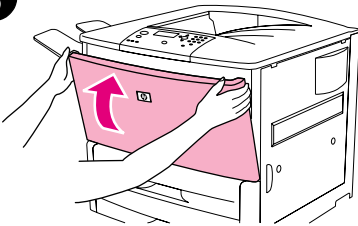

## Step 7 Load Trays 2 and 3

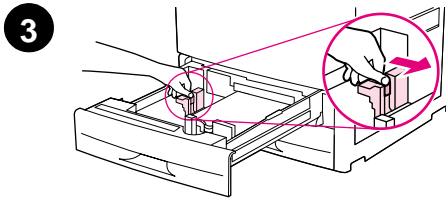
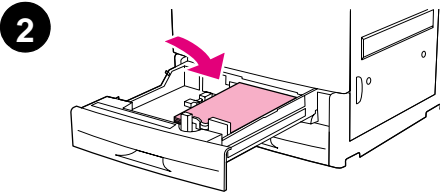
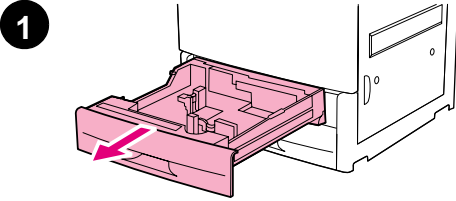

This section describes how to load A4- or letter-size paper. For instructions on loading and configuring other sizes and types of media, see the *HP LaserJet 9000 Introduce* manual (user guide) that came on the CD-ROM.

---

### CAUTION

To avoid a paper jam, never open a tray while the printer is printing from that tray.

---

### To load Tray 2 and Tray 3

- 1 Pull the tray open until it stops.
- 2 Load a stack of Letter- or A4-size paper with the top of the stack toward the rear of the tray. For single-sided printing, the side to be printed should be down. For double-sided printing, the first side to be printed should be up.
- 3 Adjust the left (Y) paper guide by pressing the tab on the guide and sliding it to the mark for A4- or letter-size paper.



4

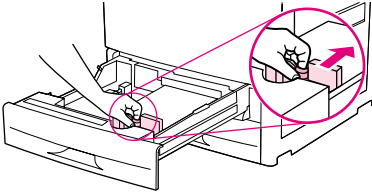

- 4 Adjust the front (X) paper guide by pressing the tab on the guide and sliding it to the mark for A4- or letter-size paper.
- 5 Close the tray until it stops.
- 6 Repeat steps 1 through 6 to load the other tray.

5

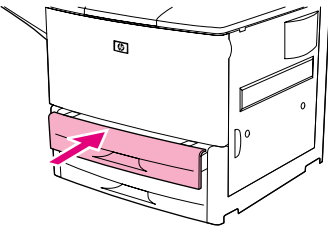

## Step 8 Connect printer cables

The printer can connect to a computer using a parallel cable, or to the network using an optional HP Jetdirect print server. Connection to a Token Ring network is available through an optional Token Ring card.

For printers equipped with an optional HP Jetdirect print server, a twisted-pair network cable connection is provided through a 10/100Base-TX (RJ-45) connector. The printer also has a connector for HP Fast InfraRed Connect, a Foreign Interface Harness, and an HP Jet-Link Connector.

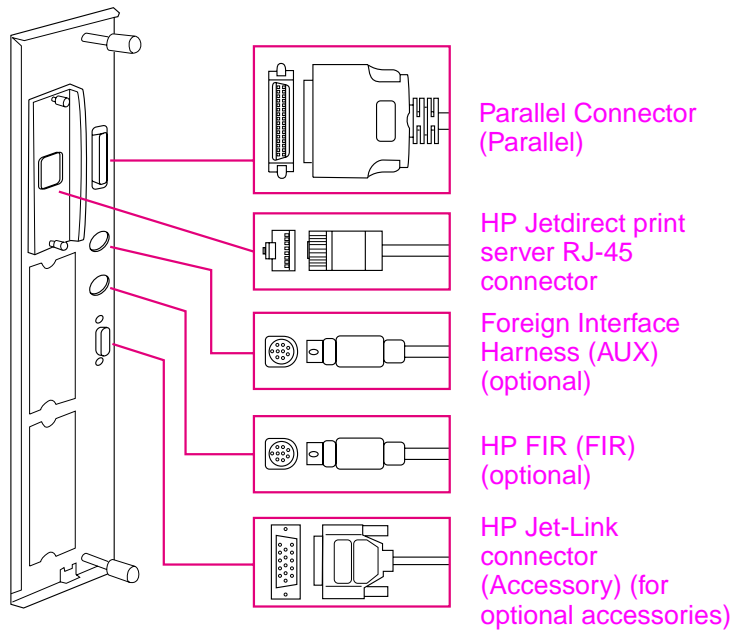

**Location of Interface Ports**

## Connecting a parallel cable

Use a parallel cable if you want to connect the printer directly to a computer.

To ensure reliability, use an IEEE-1284 bidirectional C-type parallel cable. These cables are clearly marked with "IEEE-1284." Only IEEE-1284 cables support all of the advanced printer features.

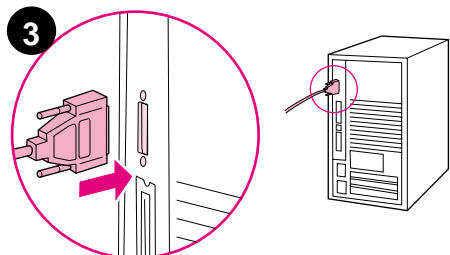
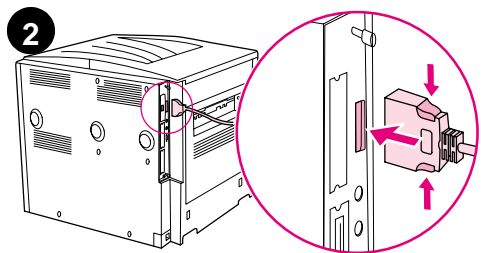
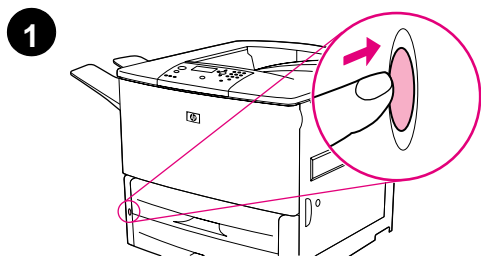

### To connect a parallel cable

- 1 Make sure the printer and the computer power are turned off.
- 2 Connect the parallel cable to the printer parallel port. Press the locking release levers while connecting the cable.

---

#### Note

If installing the cable is difficult, make sure you have the correct cable.

---

- 3 Connect the other end of the cable to the proper connector on the computer.

## Connecting to Ethernet 10/100Base-TX network

Use the RJ-45 connector if you want to connect the printer to an Ethernet 10/100Base-TX network. The HP Jetdirect print server is an optional accessory for the base model and standard on the n, dn, and hns models. HP Jetdirect print servers are available for many different network connections.

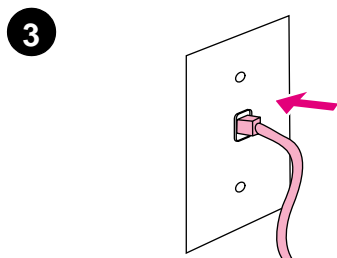
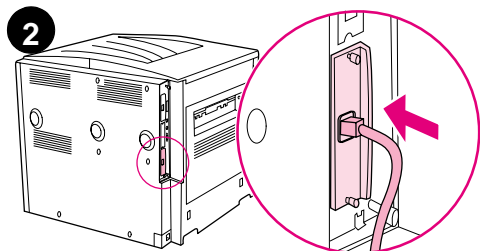
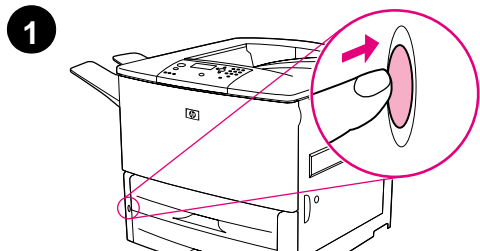

### To connect to Ethernet 10/100Base-TX network

- 1** Locate the power switch on the front of the printer. Press the power switch to turn the printer off (out position).
- 2** Connect a twisted-pair network cable to the RJ-45 connector on the HP Jetdirect print server installed in the printer.
- 3** Connect the other end of the cable to the network.

## Step 9 Connect power cord

This section describes how to connect the power cord. HP recommends connecting the power cord to a surge protector.

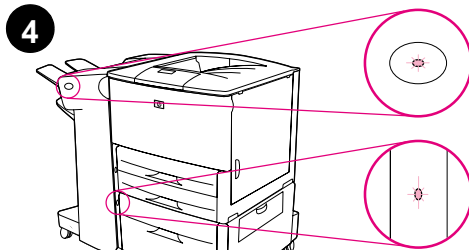
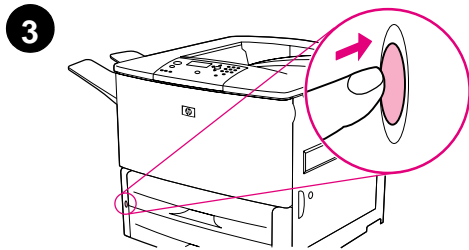
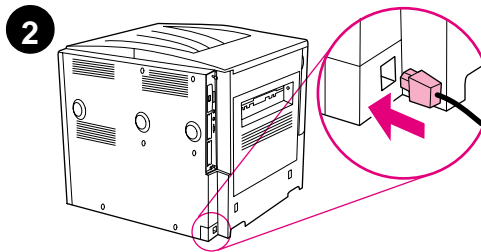
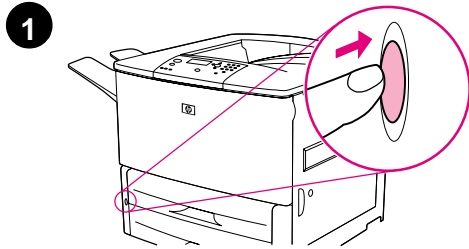

### To connect the power cord

- 1 Locate the power switch on the front of the printer. Make sure the printer is turned off (out position).

---

#### Note

If the printer is located on top of the 2,000-sheet feeder, do not connect the printer power cord to the convenience receptacle on this device. This connector is designed to connect to the paper output devices with the HP LaserJet 9000 series.

---

- 2 Connect the power cord to the printer, a grounded power strip, or an AC outlet.
- 3 Press the power switch to turn the printer on (in position). After the printer warms up, the **READY** message should appear on the control panel display.
- 4 If you have the optional 3,000-sheet stapler/stacker (or stacker), optional Tray 4, or both installed, check that the light on them is solid green. If the light is amber, flashing, or off, see the *HP LaserJet 9000 Use* manual (supplemental user guide) that can be downloaded from [www.hp.com/support/lj9000](http://www.hp.com/support/lj9000).

## Step 10 Change the control panel overlay

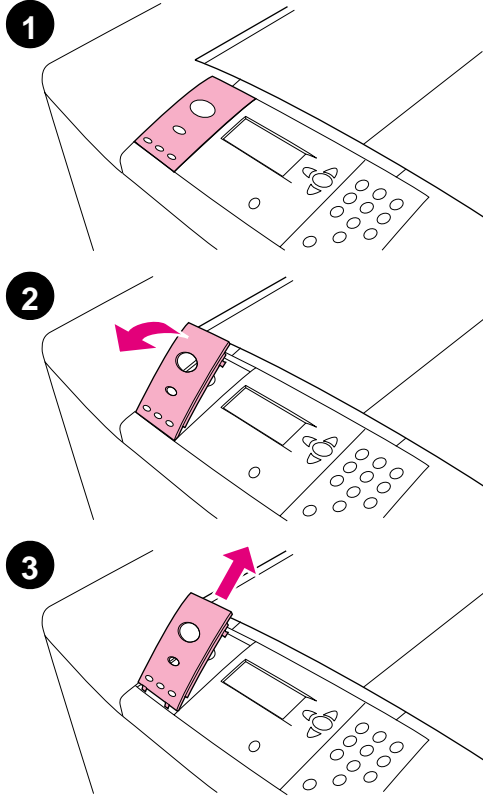

The control panel comes with an English overlay installed. If necessary, use the procedure below to change the control panel overlay to one included in the box.

### To change the overlay

- 1 Locate the power switch on the front of the printer. Press the power switch to turn the printer off (button out).
- 2 Insert your fingernail or a thin, rigid object in back of the overlay and lift up.
- 3 Gently lift the overlay up and backward to move it away from the printer.

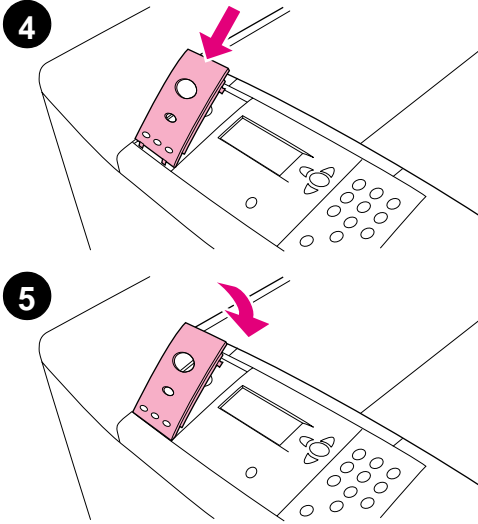

- 4** Position the new overlay over the control panel. Align the ends of the overlay with the holes on the control panel and slide the overlay in.
- 5** Snap the overlay firmly onto the control panel. Ensure that the overlay is flat against the control panel.
- 6** If you have an optional 3,000-sheet stapler/stacker (or stacker), optional Tray 4, or both, connect their power cords to a surge protector or AC outlet as well.

## Step 11 Configure the control panel display language

By default, the control panel on the printer displays messages in English. If necessary, set the printer to display messages and print configuration pages in another supported language.













---

### Note

When the power to the printer is turned on for the first time, you have the option to set the language to display messages in your own language.

---

### To configure the control panel language

- 1 Press .
- 2 Use  or  to scroll to `Configure Device` and press .
- 3 Use  or  to scroll to `System Setup` and press .
- 4 Use  or  to scroll to `Language` and press .
- 5 Use  or  to scroll to your language and press .

---

### Note

For Japanese, Turkish, Czech, Russian, Hungarian, and Polish, language selection will change the default symbol set for the specific language. For all other languages, the default symbol set is PC-8.

---



## Step 12 Print a configuration page

Print a configuration page to make sure the printer is operating correctly.

### To print a configuration page

- 1 Press **22** on the numeric keypad. The configuration page prints. If you have an HP Jetdirect printer server installed in the printer, an HP Jetdirect network configuration page also prints.
- 2 If you have optional accessories such as a duplex printing accessory or Tray 4 installed, check the configuration page to ensure that it lists them as installed.

## Step 13 Install printing software

The printer comes with printing software on a CD-ROM. The printer drivers on this CD-ROM must be installed to take full advantage of the printer features.

If you do not have access to a CD-ROM drive, you can download the printing software from the Internet at [www.hp.com/support/lj9000](http://www.hp.com/support/lj9000). Depending on the configuration of Windows-driven computers, the installation program for the printer software automatically checks the computer for Internet access and provides an option to obtain the latest software from the Internet.

---

### Note

---

Printer installation software for UNIX (HP-UX, Sun Solaris) networks is available for download at [www.hp.com/support/net\\_printing](http://www.hp.com/support/net_printing).

See the HP Customer Care pages at the front of the HP LaserJet 9000 Introduce manual (user guide) that came on the CD-ROM for more information.

## Installing Windows printing software

This section describes how to install Windows printing software. The software is supported on Windows 95, Windows 98, Windows NT 4.0, Windows 2000, and Windows Millennium (ME).

### To install the software

- 1 Close all running programs.
- 2 Insert the CD-ROM into the CD-ROM drive. Depending on the computer configuration, the installation program may automatically run. If the program does not run automatically: On the **Start** menu, click **Run**. Type `x:setup` (where X is the letter of the CD-Rom drive), and click **OK**.
- 3 Follow the instructions on the computer screen.

## Installing Macintosh printing software

This section describes how to install Macintosh printing software.

### To install Macintosh printing software

- 1 Quit all running applications.
- 2 Insert the CD-ROM into the CD-ROM drive.
- 3 Double-click the HP LaserJet Installers folder.
- 4 Double-click the Installer icon for the desired language and follow the instructions on the screen.
- 5 Open the Chooser from the Apple menu.
- 6 Click the LaserWriter 8 icon. If the icon is not there, consult your Mac OS Help for troubleshooting information or contact HP Customer Care (see the front pages of the *HP LaserJet 9000 Introduce* manual (user guide) that came on the CD-ROM.
- 7 If you are on a network with multiple zones, select the zone in the AppleTalk Zones box where the printer is located. If this is unknown, ask your network administrator.
- 8 Double-click the desired printer. An icon should appear.
- 9 Close the Chooser by clicking the Go-Away (Close) box in the upper-left corner.

## Step 14 Verify printer setup

The easiest way to verify that the installation has been completed successfully is to print a document from a program.

### To verify printer setup

- 1 Open a program of your choice. Open or create a simple document.
- 2 Make sure the correct printer name appears.
- 3 Print the document.

If the document prints, your printer setup is complete!

If the document does not print correctly, check your setup and configuration. For additional assistance, see “Customer support options worldwide” on page 28.

## Customer support options worldwide

### **Customer support and product repair assistance for the U.S. and Canada**

- In the U.S., call (1) (208) 323-2551 Monday through Friday from 6 A.M. to 10 P.M. and Saturday 9 A.M. to 4 P.M., Mountain time.
- In Canada, call (1) (905) 206-4663 or (1) (800) 387-3867 Monday through Friday from 8 A.M. to 8 P.M., Mountain time.

Support is free of charge during the warranty period. However, your standard long-distance phone charges still apply. Have your system nearby and your serial number ready when calling.

If you know your printer needs repair, call (1) (800) 243-9816 to locate your nearest HP-Authorized service provider.

## European customer support center language and in-country options available

The support centers for most countries are open Monday through Friday 8:30 A.M. to 18:00 P.M. CET.

HP provides a free telephone support service during the warranty period. By calling a telephone number listed below, you will be connected to a responsive team waiting to help you. If you require support after your warranty has expired, you can receive support for a fee through the same telephone number. The fee is charged on a per-incident basis. When calling HP, have the following information ready: product name and serial number, date of purchase, and description of the problem.

- Austria: 43 (0)810 00 6080
- Belgium
  - Dutch: 32 (0)2 626-8806
  - French: 32 (0)2 626-8806
- Czech Republic: 42 (0)2 6130 7310
- Denmark: +45 39 29 4099
- International English: +44 (0)207 512 52 02
- Finland: 358 (0)203 47 288
- France: 33 (0)1 43 62 34 34
- Germany: 49 (0)180 52 58 143
- Greece: +30 (0)1 619 64 11
- Hungary: +36 (0)1 382-1111
- Ireland: +353 (0)1 662 5525
- Italy: 39 02 264 10350
- Netherlands: 31 (0)20 606 8751
- Norway: 47 22 11 6299
- Poland: +48 22 865 98 00
- Portugal: 351 21 3176333
- Romania: +40 1 315 44 42 (or 01 3154442)
- Russian Federation
  - Moscow: +7 095 797 3520
  - St. Petersburg: +7 812 346 7997
- Spain: +34 902 321 123
- Sweden: +46 (0)8 619 2170
- Switzerland: +41 (0)848 80 11 11
- Turkey: +90 212 221 69 69
- Ukraine: +7 (380-44) 490-3520
- U.K.: +44 (0)207 512 52 02

### Africa and Middle East

- Egypt: +202 7956222
- Israel: +972 (0)9 9524848
- South Africa
  - Inside RSA: 086 000 1030
  - Outside RSA: +27-11 258 9301
- United Arab Emirates, Bahrain, Jordan, Kuwait, Lebanon, Oman, Palestine, Qatar, Saudi Arabia, Yemen: 971 4 883 8454
- International English: +44 (0)207 512 52 02

## Worldwide support centers

Hours of operation vary by country or region.

### Asia-Pacific

- Australia: (03) 8877 8000
- China: +86 (0)10 6564 5959
- Hong Kong: +85 (2) 2802 4098
- India: +91 11 682 6035
- Indonesia: +62 (21) 350-3408/
- Japan: +81 3 3335-8333/
- Republic of Korea:  
Seoul: +82 (2) 3270-0700/  
Outside Seoul: 080 999-0700/
- Malaysia: +60 (3) 295 2566
- New Zealand: +64 (9) 356 6640
- Philippines: +63 (2) 867 3551
- Singapore: +65 272 5300
- Taiwan: +886 (2) 2717 0055
- Thailand: +66 (2) 661 4000
- Vietnam: +84 (0) 8 823 4530

### Latin America

- Argentina: 0810-555-5520
- Brazil  
Greater Sao Paulo: (11) 3747-7799  
Outside Greater Sao Paulo: 0800-157751
- Chile: 800-22-5547
- Guatemala: 800-999-5305
- Mexico  
Mexico City: 52-58-9922/  
Outside Mexico City: 01-800-472-6684
- Peru: 0-800-10111
- Puerto Rico: 1-877-2320-589
- Venezuela  
Caracas: 207 8488  
Outside Caracas: 800 47 777



# Warranty and regulatory information

## Hewlett-Packard limited warranty statement

HP PRODUCT	DURATION OF WARRANTY
HP LaserJet 9000, 9000n, 9000dn, 9000hns	On site, 1 year or 600,000 pages whichever comes first

- 1 HP warrants HP hardware, accessories, and supplies against defects in materials and workmanship for the period specified above. If HP receives notice of such defects during the warranty period, HP will, at its option, either repair or replace products which prove to be defective. Replacement products may be either new or like-new.
- 2 HP warrants that HP software will not fail to execute its programming instructions, for the period specified above, due to defects in material and workmanship when properly installed and used. If HP receives notice of such defects during the warranty period, HP will replace software media which does not execute its programming instructions due to such defects.
- 3 HP does not warrant that the operation of HP products will be uninterrupted or error free. If HP is unable, within a reasonable time, to repair or replace any product to a condition as warranted, customer will be entitled to a refund of the purchase price upon prompt return of the product.
- 4 HP products may contain remanufactured parts equivalent to new in performance or may have been subject to incidental use.
- 5 The warranty period begins on the date of the delivery or on the date of installation if installed by HP. If customer schedules or delays HP installation more than 30 days after delivery, warranty begins on the 31st day from delivery.
- 6 Warranty does not apply to defects resulting from (a) improper or inadequate maintenance or calibration, (b) software, interfacing, parts or supplies not supplied by HP, (c) unauthorized modification or misuse, (d) operation outside of the published environmental specifications for the product, or (e) improper site preparation or maintenance.

- 7 TO THE EXTENT ALLOWED BY LOCAL LAW, THE ABOVE WARRANTIES ARE EXCLUSIVE AND NO OTHER WARRANTY, WHETHER WRITTEN OR ORAL, IS EXPRESSED OR IMPLIED AND HP SPECIFICALLY DISCLAIMS THE IMPLIED WARRANTIES OR CONDITIONS OF MERCHANTABILITY, SATISFACTORY QUALITY, AND FITNESS FOR A PARTICULAR PURPOSE.
- 8 HP will be liable for damage to tangible property per incident up to the greater of \$300,000 or the actual amount paid for the product that is the subject of the claim, and for damages for bodily injury or death, to the extent that all such damages are determined by a court of competent jurisdiction to have been directly caused by a defective HP product.
- 9 TO THE EXTENT ALLOWED BY LOCAL LAW, THE REMEDIES IN THIS WARRANTY STATEMENT ARE THE CUSTOMER'S SOLE AND EXCLUSIVE REMEDIES. EXCEPT AS INDICATED ABOVE, IN NO EVENT WILL HP OR ITS SUPPLIERS BE LIABLE FOR LOSS OF DATA OR FOR DIRECT, SPECIAL, INCIDENTAL, CONSEQUENTIAL (INCLUDING LOST PROFIT OR DATA), OR OTHER DAMAGE, WHETHER BASED IN CONTRACT, TORT, OR OTHERWISE.
- 10 FOR CONSUMER TRANSACTIONS IN AUSTRALIA AND NEW ZEALAND; THE WARRANTY TERMS CONTAINED IN THIS STATEMENT, EXCEPT TO THE EXTENT LAWFULLY PERMITTED, DO NOT EXCLUDE, RESTRICT OR MODIFY AND ARE IN ADDITION TO THE MANDATORY STATUTORY RIGHTS APPLICABLE TO THE SALE OF THIS PRODUCT TO YOU.

### **Service During and After the Warranty Period**

- If printer hardware fails during the warranty period, contact an HP-authorized service or support provider.
- If printer hardware fails after the warranty period, and you have an HP Maintenance Agreement or HP SupportPack, request service as specified in the agreement.
- If you do not have an HP Maintenance Agreement or HP SupportPack, contact an HP-authorized service or support provider.

## Limited Warranty for Print Cartridge Life

---

**Note**

---

The warranty below applies to the print cartridge that came with this printer.

This HP Print Cartridge is warranted to be free from defects in materials and workmanship for cartridge life (which is indicated by a printer control panel cartridge end of life message).

HP will, at HP's option, either replace products which prove to be defective or refund your purchase price.

The warranty does not cover cartridges which have been refilled, are emptied, abused, misused, or tampered with in any way.

This limited warranty gives you specific legal rights. You may have other rights which vary from state to state, province to province, and country to country.

To the extent allowed by applicable law, in no event shall Hewlett-Packard Company be liable for any incidental, consequential, special, indirect, punitive, or exemplary damages or lost profits from any breach of this warranty or otherwise.

## HP Software License Terms

**ATTENTION: USE OF THE SOFTWARE IS SUBJECT TO THE HP SOFTWARE LICENSE TERMS SET FORTH BELOW. USING THE SOFTWARE INDICATES YOUR ACCEPTANCE OF THESE LICENSE TERMS. IF YOU DO NOT ACCEPT THESE LICENSE TERMS, YOU MAY RETURN THE SOFTWARE FOR A FULL REFUND. IF THE SOFTWARE IS BUNDLED WITH ANOTHER PRODUCT, YOU MAY RETURN THE ENTIRE UNUSED PRODUCT FOR A FULL REFUND.**

The following License Terms govern your use of the accompanying Software unless you have a separate signed agreement with HP.

### **License Grant**

HP grants you a license to Use one copy of the Software. “Use” means storing, loading, installing, executing, or displaying the Software. You may not modify the Software or disable any licensing or control features of the Software. If the Software is licensed for “concurrent use”, you may not allow more than the maximum number of authorized users to Use the Software concurrently.

### **Ownership**

The Software is owned and copyrighted by HP or its third party suppliers. Your license confers no title to, or ownership in, the Software and is not a sale of any rights in the Software. HP’s third party suppliers may protect their rights in the event of any violation of these License Terms.

### **Copies and Adaptations**

You may only make copies or adaptations of the Software for archival purposes or when copying or adaptation is an essential step in the authorized Use of the Software. You must reproduce all copyright notices in the original Software on all copies or adaptations. You may not copy the Software onto any public network.

## **No Disassembly or Decryption**

You may not disassemble or decompile the Software unless HP's prior written consent is obtained. In some jurisdictions, HP's consent may not be required for limited disassembly or decompilation. Upon request, you will provide HP with reasonably detailed information regarding any disassembly or decompilation. You may not decrypt the Software unless decryption is a necessary part of the operation of the Software.

## **Transfer**

Your license will automatically terminate upon any transfer of the Software. Upon transfer, you must deliver the Software, including any copies and related documentation, to the transferee. The transferee must accept these License Terms as a condition to the transfer.

## **Termination**

HP may terminate your license upon notice for failure to comply with any of these License Terms. Upon termination, you must immediately destroy the Software, together with all copies, adaptations, and merged portions in any form.

## **Export Requirements**

You may not export or reexport the Software or any copy or adaptation in violation of any applicable laws or regulations.

## **U.S. Government Restricted Rights**

The Software and any accompanying documentation have been developed entirely at private expense. They are delivered and licensed as "commercial computer software" as defined in DFARS 252.227-7013 (Oct 1988), DFARS 252.211-7015 (May 1991), or DFARS 252.227-7014 (Jun 1995), as a "commercial item" as defined in FAR 2.101 (a), or as "Restricted computer software" as defined in FAR 52.227-19 (Jun 1987) (or any equivalent agency regulation or contract clause), whichever is applicable. You have only those rights provided for such Software and any accompanying documentation by the applicable FAR or DFARS clause or the HP standard software agreement for the product involved.

## FCC regulations

This equipment has been tested and found to comply with the limits for a Class **B** digital device, pursuant to Part 15 of the FCC rules. These limits are designed to provide reasonable protection against harmful interference in a residential installation. This equipment generates, uses, and can radiate radio frequency energy, and if not installed and used in accordance with the instructions, may cause harmful interference to radio communications. However, there is no guarantee that interference will not occur in a particular installation. If this equipment does cause harmful interference to radio or television reception, which can be determined by turning the equipment off and on, the user is encouraged to try to correct the interference by one or more of the following measures:

- Reorient or relocate the receiving antenna.
- Increase separation between equipment and receiver.
- Connect equipment to an outlet on a circuit different from that to which the receiver is located.
- Consult your dealer or an experienced radio/TV technician.

---

### Note

---

Any changes or modifications to the printer not expressly approved by HP could void the user's authority to operate this equipment.

Use of a shielded interface cable is required to comply with the FCC rules.

## Canadian DOC Regulations

Complies with Canadian EMC Class **B** requirements.

<<Conforme à la classe **B** des normes canadiennes de compatibilité électromagnétiques. << CEM>>.>>

## VCCI Statement (Japan)

VCCI class B product

この装置は、情報処理装置等電波障害自主規制協議会（VCCI）の基準に基づくクラスB情報技術装置です。この装置は、家庭環境で使用することを目的としていますが、この装置がラジオやテレビジョン受信機に近接して使用されると、受信障害を引き起こすことがあります。取り扱い説明書に従って正しい取り扱いをして下さい。

## Translation

This equipment is in the Class **B** category information technology equipment based on the rules of Voluntary Control Council For Interference by Information Technology Equipment (VCCI). Although aimed for residential area operation, radio interference may be caused when used near a radio or TV receiver. Read the instructions for correct operation.

## Korean EMI Statement

사용자 안내문 (B급 기기)

이 기기는 비업무용으로 전자파장해 검정을 받은 기기로서, 주거지역에서는 물론 모든지역에서 사용할 수 있습니다.

# Safety Information

## Laser Safety

The Center for Devices and Radiological Health (CDRH) of the U.S. Food and Drug Administration has implemented regulations for laser products manufactured since August 1, 1976. Compliance is mandatory for products marketed in the United States. This printer is certified as a "Class 1" laser product under the U.S. Department of Health and Human Services (DHHS) Radiation Performance Standard according to the Radiation Control for Health and Safety Act of 1968. Since radiation emitted inside this printer is completely confined within protective housings and external covers, the laser beam cannot escape during any phase of normal user operation.

### **WARNING!**

Using controls, making adjustments, or performing procedures other than those specified in this manual may result in exposure to hazardous radiation.

## Product Information Sheet

The Toner Product Information Sheet can be obtained by calling the U.S. HP FIRST (Fax Information Retrieval Support Technology) at (1) (800) 333-1917. International customers should see the front of this manual for appropriate phone numbers and information.

## Laser Statement for Finland

### **Luokan 1 laserlaite**

#### **Klass 1 Laser Apparat**

HP LaserJet 9000, 9000N, 900DN

laserkirjoitin on käyttäjän kannalta turvallinen luokan 1 laserlaite.

Normaalissa käytössä kirjoittimen suojakotelointi estää lasersäteen pääsyn laitteen ulkopuolelle. Laitteen turvallisuusluokka on määritetty standardin EN 60825-1 (1994) mukaisesti.

#### **Varoitus!**

Laitteen käyttäminen muulla kuin käyttöohjeessa mainitulla tavalla saattaa altistaa käyttäjän turvallisuusluokan 1 ylittävälle näkymättömälle lasersäteilylle.

#### **Varning!**

Om apparaten används på annat sätt än i bruksanvisning specificerats, kan användaren utsättas för osynlig laserstrålning, som överskrider gränsen för laserklass 1.

#### **HUOLTO**

HP LaserJet 9000, 9000N, 900DN

-kirjoittimen sisällä ei ole käyttäjän huollettavissa olevia kohteita.



Laitteen saa avata ja huoltaa ainoastaan sen huoltamiseen koulutettu henkilö. Tällaiseksi huoltotoimenpiteeksi ei katsota väriainekasetin vaihtamista, paperiradan puhdistusta tai muita käyttäjän käsikirjassa lueteltuja, käyttäjän tehtäväksi tarkoitettuja ylläpitotoimia, jotka voidaan suorittaa ilman erikoistyökaluja.

**Varo!**

Mikäli kirjoittimen suojakotelo avataan, olet alttiina näkymättömälle lasersäteilylle laitteen ollessa toiminnassa. Älä katso säteeseen.

**Varning!**

Om laserprinterns skyddshölje öppnas då apparaten är i funktion, utsätts användaren för osynlig laserstrålning. Betrakta ej strålen. Tiedot laitteessa käytettävän laserdiodin säteilyominaisuuksista:

Aallonpituus 775-795 nm

Teho 5 mW

Luokan 3B laser

# Declaration of Conformity

according to ISO/IEC Guide 22 and EN 45014

**Manufacturer's Name:** Hewlett-Packard Company

**Manufacturer's Address:** 11311 Chinden Boulevard  
Boise, Idaho 83714-1021, USA

**declares, that the product**

**Product Name:** HP LaserJet 9000 / 9000N / 9000DN Printer

**Model Numbers:** C8519A / C8520A / C8521A Printer

**Product Options:** ALL

**conforms to the following Product Specifications:**

**SAFETY:** IEC 60950:1991+A1:1992+A2:1993+A3:1995+A4:1996 /  
EN 60950:1992+A1:1993 + A2:1993 + A3:1995 + A4:1997 + A11:1997

IEC 60825-1:1993 +A1:1997/  
EN 60825-1:1994 + A11:1996 Class 1 Laser/LED Product

**EMC:** CISPR 22:1997 / EN 55022:1998 Class B<sup>13</sup>

EN 55024:1998

IEC 6100-3-2:1995/EN 61000-3-2:1995

IEC61000-3-3:1994/EN 61000-3-3:1995

FCC Title 47 CFR, Part 15 Class B<sup>23</sup> / ICES-003, Issue 3

AS / NZS 3548:1995

**Supplementary Information:**

The product herewith complies with the requirements of the EMC Directive 89/336/EEC and the Low Voltage Directive 73/23/EEC, and carries the CE-Marking accordingly.

- 1) The product was tested in a typical configuration with Hewlett-Packard Personal Computer Systems
- 2) This Device complies with Part 15 of the FCC Rules. Operation is subject to the following two Conditions:
  - (1) this device may not cause harmful interference, and
  - (2) this device must accept any interference received, including interference that may cause undesired operation
- 3) The Product exhibits Class A operation when connected to Local Area Network (LAN) cables using print server accessories

Hewlett-Packard Company  
Boise, Idaho USA  
Nov. 22, 2000

**Australia Contact:** Product Regulations Manager, Hewlett-Packard Australia Ltd., 31-41 Joseph Street, Blackburn, Victoria 3130, Australia

**European Contact:** Your Local Hewlett-Packard Sales and Service Office or Hewlett-Packard GmbH, Department HQ-TRE / Standards Europe, Herrenberger Straße 110-140, D-71034 Böblingen (FAX: +49-7031-14-3143)

**USA Contact:** Product Regulations Manager, Hewlett-Packard Company, PO Box 15, Mail Stop 160, Boise, Idaho 83707-0015 (Phone: 208-396-6000)





copyright © 2001  
Hewlett-Packard Company

[www.hp.com/support/lj9000](http://www.hp.com/support/lj9000)

english



C8519-90910

## Free Manuals Download Website

<http://myh66.com>

<http://usermanuals.us>

<http://www.somanuals.com>

<http://www.4manuals.cc>

<http://www.manual-lib.com>

<http://www.404manual.com>

<http://www.luxmanual.com>

<http://aubethermostatmanual.com>

Golf course search by state

<http://golfingnear.com>

Email search by domain

<http://emailbydomain.com>

Auto manuals search

<http://auto.somanuals.com>

TV manuals search

<http://tv.somanuals.com>