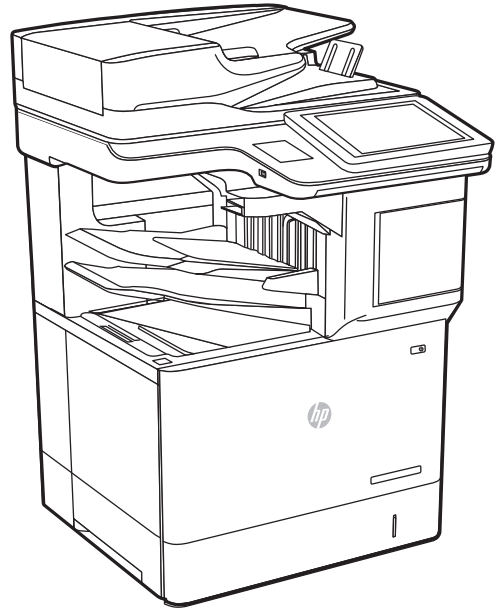




# HP LaserJet Managed MFP E62655, E62665, HP LaserJet Managed Flow MFP E62665, E62675

## User Guide



[www.hp.com/videos/LaserJet](http://www.hp.com/videos/LaserJet)  
[www.hp.com/support/ljE62655mfp](http://www.hp.com/support/ljE62655mfp)

[www.hp.com/support/ljE62665mfp](http://www.hp.com/support/ljE62665mfp)  
[www.hp.com/support/ljE62675mfp](http://www.hp.com/support/ljE62675mfp)





HP LaserJet Managed MFP E62655, E62665,  
HP LaserJet Managed Flow MFP E62665,  
E62675

User Guide

## Copyright and License

© Copyright 2019 HP Development Company, L.P.

Reproduction, adaptation, or translation without prior written permission is prohibited, except as allowed under the copyright laws.

The information contained herein is subject to change without notice.

The only warranties for HP products and services are set forth in the express warranty statements accompanying such products and services. Nothing herein should be construed as constituting an additional warranty. HP shall not be liable for technical or editorial errors or omissions contained herein.

Edition 1, 04/2019

## Trademark Credits

Adobe®, Adobe Photoshop®, Acrobat®, and PostScript® are trademarks of Adobe Systems Incorporated.

Apple and the Apple logo are trademarks of Apple Inc., registered in the U.S. and other countries.

macOS is a trademark of Apple Inc., registered in the U.S. and other countries.

AirPrint is a trademark of Apple Inc., registered in the U.S. and other countries.

Google™ is a trademark of Google Inc.

Microsoft®, Windows®, Windows® XP, and Windows Vista® are U.S. registered trademarks of Microsoft Corporation.

UNIX® is a registered trademark of The Open Group.

---

# Table of contents

<b>1 Printer overview</b> .....	<b>1</b>
Warning icons .....	1
Potential shock hazard .....	2
Printer views .....	3
Printer front view .....	3
Printer back view .....	4
Interface ports .....	5
Control-panel view .....	5
Printer specifications .....	9
Technical specifications .....	9
Supported operating systems .....	12
Printer dimensions .....	14
Power consumption, electrical specifications, and acoustic emissions .....	15
Operating environment range .....	16
Printer hardware setup and software installation .....	17
<b>2 Paper trays</b> .....	<b>19</b>
Introduction .....	20
Load paper to Tray 1 (multipurpose tray) .....	21
Tray 1 paper orientation .....	22
Use alternative letterhead mode .....	25
Load paper to Tray 2 and the 550-sheet trays .....	26
Introduction .....	26
Tray 2 and the 550-sheet trays paper orientation .....	27
Use alternative letterhead mode .....	29
Load paper to the 2,100-sheet high-capacity input tray .....	30
High-capacity input tray paper orientation .....	31
Load and print envelopes .....	34
Introduction .....	34
Print envelopes .....	34
Envelope orientation .....	35
Load and print labels .....	36

Introduction .....	36
Manually feed labels .....	36
Label orientation .....	37
Configure the 900-sheet 3-bin Stapling Mailbox (Flow model) .....	38
Configure the default staple location .....	38
Configure the operation mode .....	38
<b>3 Supplies, accessories, and parts .....</b>	<b>41</b>
Order supplies, accessories, and parts .....	42
Ordering .....	42
Replace the toner cartridge .....	43
Toner-cartridge information .....	43
Remove and replace the cartridge .....	43
Replace the staple cartridge .....	47
<b>4 Print .....</b>	<b>49</b>
Print tasks (Windows) .....	50
How to print (Windows) .....	50
Automatically print on both sides (Windows) .....	50
Manually print on both sides (Windows) .....	51
Print multiple pages per sheet (Windows) .....	51
Select the paper type (Windows) .....	52
Additional print tasks .....	53
Print tasks (macOS) .....	54
How to print (macOS) .....	54
Automatically print on both sides (macOS) .....	54
Manually print on both sides (macOS) .....	54
Print multiple pages per sheet (macOS) .....	55
Select the paper type (macOS) .....	55
Additional print tasks .....	55
Store print jobs on the printer to print later or print privately .....	57
Introduction .....	57
Create a stored job (Windows) .....	57
Create a stored job (macOS) .....	58
Print a stored job .....	59
Delete a stored job .....	59
Information sent to printer for Job Accounting purposes .....	60
Mobile printing solutions .....	61
Introduction .....	61
Wi-Fi Direct (wireless models only, with HP Jetdirect 3100w BLE/NFC/Wireless accessory installed) .....	61

HP ePrint via email .....	62
AirPrint .....	63
Android embedded printing .....	63
Print from a USB flash drive .....	64
Introduction .....	64
Enable the USB port for printing .....	64
Print USB documents .....	65
Print using high-speed USB 2.0 port (wired) .....	66
Enable the high-speed USB port for printing .....	66
<b>5 Copy .....</b>	<b>67</b>
Make a copy .....	68
Copy on both sides (duplex) .....	70
Additional options when copying .....	72
Additional copy tasks .....	74
<b>6 Scan .....</b>	<b>75</b>
Set up Scan to Email .....	76
Introduction .....	76
Before you begin .....	76
Step one: Access the HP Embedded Web Server (EWS) .....	76
Step two: Configure the Network Identification settings .....	77
Step three: Configure the Scan to Email feature .....	78
Step four: Configure the Quick Sets (optional) .....	85
Step five: Set up Scan to Email to use Office 365 Outlook (optional) .....	86
Set up Scan to Network Folder .....	89
Introduction .....	89
Before you begin .....	89
Step one: Access the HP Embedded Web Server .....	89
Step two: Set up Scan to Network Folder .....	89
Set up Scan to SharePoint® (Flow models only) .....	99
Introduction .....	99
Before you begin .....	99
Step one: Access the HP Embedded Web Server (EWS) .....	99
Step two: Enable Scan to SharePoint® and create a Scan to SharePoint Quick Set .....	99
Quick set scan settings and options for Scan to SharePoint® .....	101
Set up Scan to USB Drive .....	103
Introduction .....	103
Step one: Access the HP Embedded Web Server .....	103
Step two: Enable Scan to USB Drive .....	103
Step three: Configure the Quick Sets (optional) .....	103

Default scan settings for Scan to USB Drive setup .....	104
Default file settings for Scan to USB Drive setup .....	105
Scan to email .....	107
Introduction .....	107
Scan to email .....	107
Scan to job storage .....	110
Introduction .....	110
Scan to job storage on the printer .....	110
Print from job storage on the printer .....	112
Scan to network folder .....	113
Introduction .....	113
Scan to network folder .....	113
Scan to SharePoint .....	115
Introduction .....	115
Scan to SharePoint .....	115
Scan to USB drive .....	117
Introduction .....	117
Scan to USB drive .....	117
Additional options when scanning .....	119
HP JetAdvantage business solutions .....	122
Additional scan tasks .....	123
<b>7 Fax .....</b>	<b>125</b>
Set up fax .....	126
Introduction .....	126
Set up fax by using the printer control panel .....	126
Change fax configurations .....	127
Fax dialing settings .....	127
General fax send settings .....	128
Fax receive settings .....	128
Send a fax .....	130
Additional fax tasks .....	132
<b>8 Manage the printer .....</b>	<b>133</b>
Advanced configuration with the HP Embedded Web Server (EWS) .....	134
Introduction .....	134
How to access the HP Embedded Web Server (EWS) .....	135
HP Embedded Web Server features .....	135
Configure IP network settings .....	143
Printer sharing disclaimer .....	143
View or change network settings .....	143



Rename the printer on a network .....	143
Manually configure IPv4 TCP/IP parameters from the control panel .....	144
Manually configure IPv6 TCP/IP parameters from the control panel .....	144
Link speed and duplex settings .....	145
Printer security features .....	146
Introduction .....	146
Security statements .....	146
IP Security .....	146
Assign or change the system password using the HP Embedded Web Server .....	146
Encryption support: HP High Performance Secure Hard Disks .....	147
Lock the formatter .....	147
Energy-conservation settings .....	148
Introduction .....	148
Print with EconoMode .....	148
Set the sleep timer and configure the printer to use 1 watt or less of power .....	148
Set the sleep schedule .....	149
HP Web Jetadmin .....	150
Software and firmware updates .....	151

## 9 Solve problems ..... 153

Customer support .....	154
Control panel help system .....	155
Reset factory settings .....	156
Introduction .....	156
Method one: Reset factory settings from the printer control panel .....	156
Method two: Reset factory settings from the HP Embedded Web Server (network-connected printers only) .....	156
A “Cartridge is low” or “Cartridge is very low” message displays on the printer control panel .....	157
Printer does not pick up paper or misfeeds .....	158
Introduction .....	158
The printer does not pick up paper .....	158
The printer picks up multiple sheets of paper .....	160
The document feeder jams, skews, or picks up multiple sheets of paper .....	164
Clear paper jams .....	165
Introduction .....	165
Paper jam locations .....	166
Auto-navigation for clearing paper jams .....	167
Experiencing frequent or recurring paper jams? .....	167
Clear paper jams in the document feeder (31.13) .....	168
Clear paper jams in Tray 1 (13.A1) .....	170
Clear paper jams in Trays 2, 3, 4, 5 (13.A2, 13.A3, 13.A4, 13.A5) .....	172

Clear paper jams in the 2,100-sheet high-capacity input tray (13.A, 13.F) .....	175
Clear paper jams in the right door and fuser area (13.B9, 13.B2, 13.FF) .....	179
Clear paper jams in the output bin (13.E1) .....	182
Clear paper jams in the duplexer (13.C, 13.D, 13.B) .....	182
Clear paper jams in the envelope feeder (13.A) .....	183
Clear paper jams in the HP 900-sheet 3-bin Stapling Mailbox (13.E, 13.7) .....	185
Clear staple jams (13.8) .....	187
Resolve print-quality problems .....	190
Introduction .....	190
Troubleshoot print quality .....	190
Improve copy image quality .....	195
Check the scanner glass for dirt and smudges .....	195
Calibrate the scanner .....	196
Check the paper settings .....	197
Check the image-adjustment settings .....	197
Optimize copy quality for text or pictures .....	198
Edge-to-edge copying .....	198
Improve scan image quality .....	199
Check the scanner glass for dirt and smudges .....	199
Check the resolution settings .....	200
Check the image-adjustment settings .....	201
Optimize scan quality for text or pictures .....	201
Check the output-quality settings .....	202
Improve fax image quality .....	203
Check the scanner glass for dirt and smudges .....	203
Check the send-fax resolution settings .....	204
Check the image-adjustment settings .....	205
Optimize fax quality for text or pictures .....	205
Check the error-correction settings .....	205
Check the fit-to-page setting .....	206
Send to a different fax machine .....	206
Check the sender's fax machine .....	206
Solve fax problems .....	207
Checklist for solving fax problems .....	207
General fax problems .....	209
<b>Index .....</b>	<b>211</b>

---

# 1 Printer overview

- [Warning icons](#)
- [Potential shock hazard](#)
- [Printer views](#)
- [Printer specifications](#)
- [Printer hardware setup and software installation](#)

## For more information

The following information is correct at the time of publication.

For video assistance, see [www.hp.com/videos/LaserJet](http://www.hp.com/videos/LaserJet).

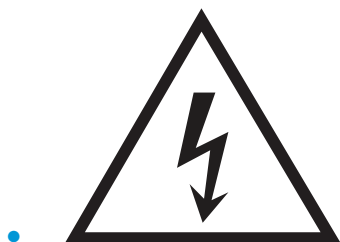
For current information, see [www.hp.com/support/ljE62655mfp](http://www.hp.com/support/ljE62655mfp), [www.hp.com/support/ljE62665mfp](http://www.hp.com/support/ljE62665mfp), or [www.hp.com/support/ljE62675mfp](http://www.hp.com/support/ljE62675mfp).

HP's all-inclusive help for the printer includes the following information:

- Install and configure
- Learn and use
- Solve problems
- Download software and firmware updates
- Join support forums
- Find warranty and regulatory information

## Warning icons

Warning icon definitions: The following warning icons may appear on HP products. Apply appropriate caution where applicable.

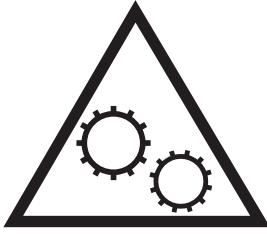


Caution: Electric shock



•

Caution: Hot surface



•

Caution: Keep body parts away from moving parts



•

Caution: Sharp edge in close proximity

## Potential shock hazard

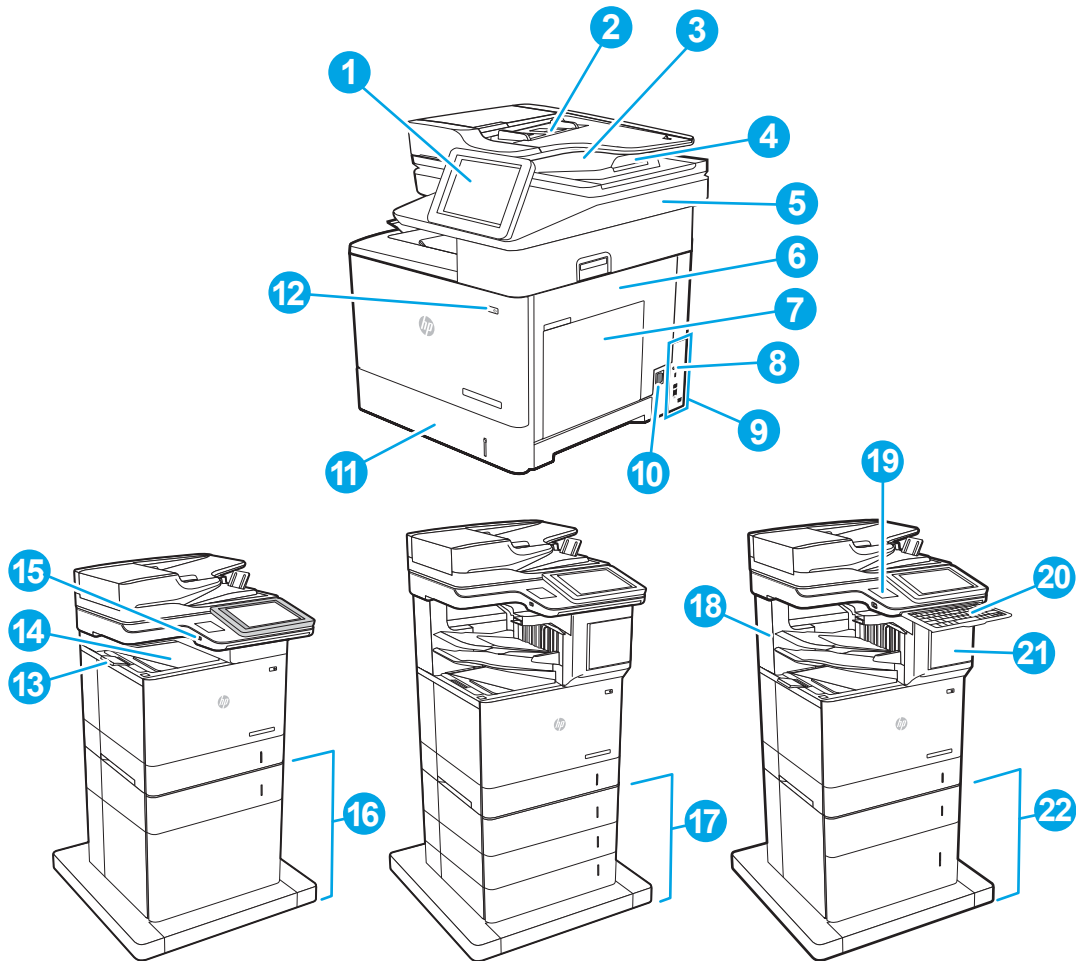
Always follow basic safety precautions when using this product to reduce risk of injury from fire or electric shock.

- Read and understand all instructions in the user guide.
- Observe all warnings and instructions marked on the product.
- Use only a grounded electrical outlet when connecting the product to a power source. If you do not know whether the outlet is grounded, check with a qualified electrician.
- Do not touch the contacts on any of the sockets on the product. Replace damaged cords immediately.
- Unplug this product from wall outlets before cleaning.
- Do not install or use this product near water or when you are wet.
- Install the product securely on a stable surface.
- Install the product in a protected location where no one can step on or trip over the power cord.

# Printer views

- [Printer front view](#)
- [Printer back view](#)
- [Interface ports](#)
- [Control-panel view](#)

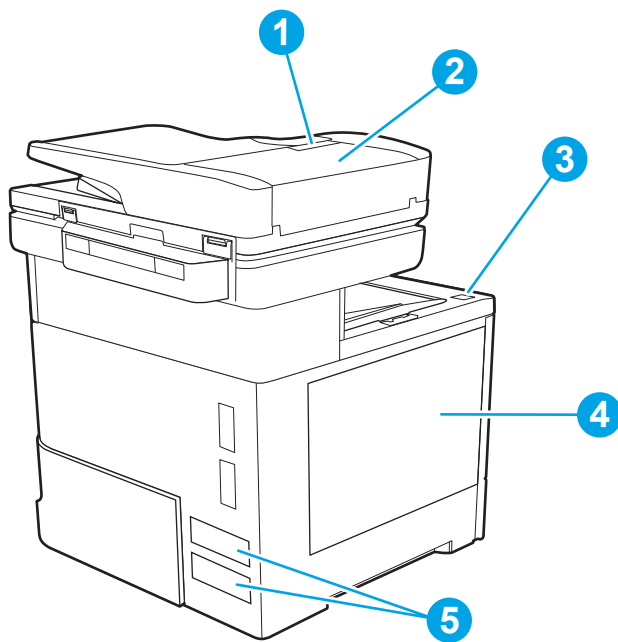
## Printer front view



1	Control panel with color touchscreen display (tilts up for easier viewing)
2	Document-feeder input tray
3	Document-feeder output bin
4	Document-feeder output extension (extend this when scanning longer—such as legal—paper)
5	Scanner assembly

6	Right door (access for clearing jams)
7	Tray 1 (multipurpose tray)
8	Formatter (contains the interface ports)
9	Slot for a cable-type security lock
10	Power connection
11	Tray 2
12	On/off button
13	Walk-up USB port
14	Output bin
15	Output bin extension
16	1 x 550-sheet paper feeder with stand (optional accessory)
17	3 x 550-sheet paper feeder with stand (optional accessory)
18	900-sheet 3-bin Stapling Mailbox (E62665hs, E62665z, E62675z models only)
19	Hardware integration pocket (for connecting accessories and third-party devices)
20	Keyboard (E62665z, E62675z models only). Pull the keyboard straight out to use it.
<b>CAUTION:</b> Close the keyboard when it is not in use.	
21	Stapler door (E62665hs, E62665z, E62675z models only)
22	1 x 550-sheet feeder plus 2,100-sheet high-capacity feeder (optional accessory)

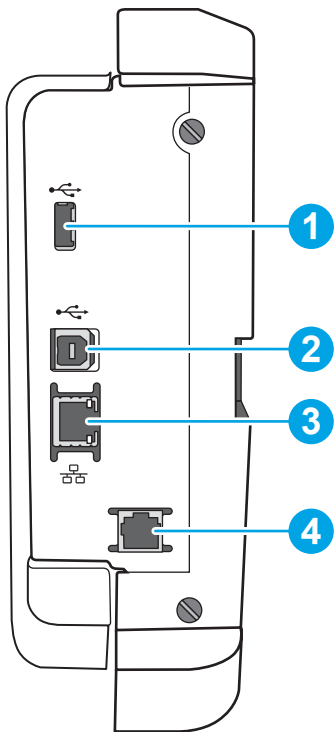
## Printer back view



1	Document feeder cover release latch
---	-------------------------------------

2	Document-feeder cover (access for clearing jams)
3	Cartridge door release button
4	Cartridge door (access to the toner cartridge)
5	Serial number and product number label

## Interface ports



1	Host USB port for connecting external USB devices (this port might be covered) <b>NOTE:</b> For easy-access USB printing, use the USB port near the control panel.
2	Hi-Speed USB 2.0 printing port
3	Local area network (LAN) Ethernet (RJ-45) network port
4	Fax port (fax models only)

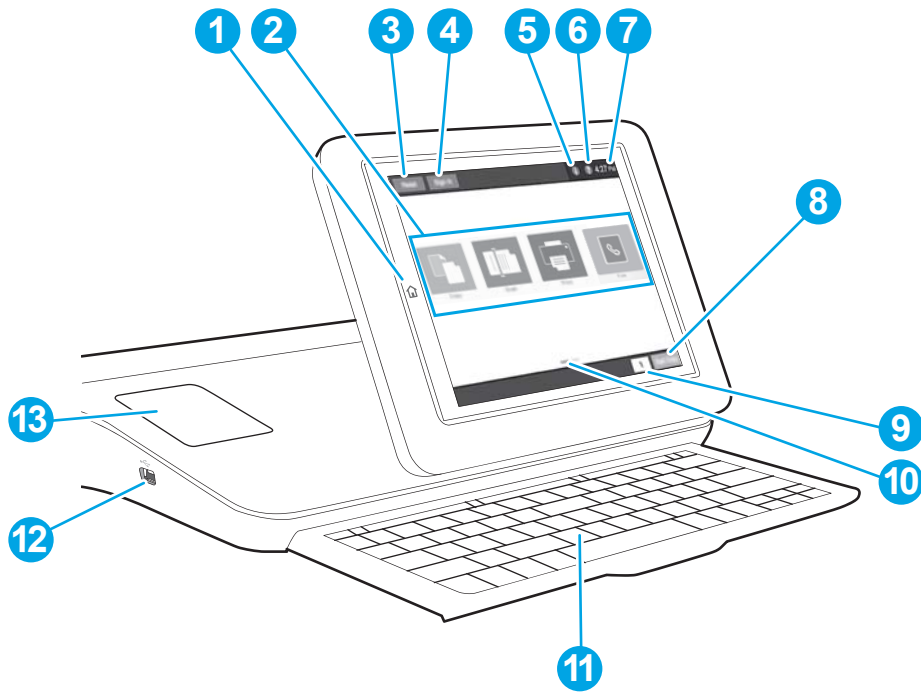
## Control-panel view

The Home screen provides access to the printer features and indicates the current status of the printer.


Return to the Home screen at any time by touching the Home button on the left side of the printer control panel, or touch the Home button in the upper-left corner of most screens.

**NOTE:** For more information about the printer-control-panel features, go to [www.hp.com/support/ljE62655mfp](http://www.hp.com/support/ljE62655mfp), [www.hp.com/support/ljE62665mfp](http://www.hp.com/support/ljE62665mfp), or [www.hp.com/support/ljE62675mfp](http://www.hp.com/support/ljE62675mfp). Select **Manuals**, and then select **General reference**.

**NOTE:** The features that appear on the Home screen can vary, depending on the printer configuration.





**Table 1-1** Printer control-panel view legend

Image callout	Printer component	Description
1	Home  button	Touch the Home button to return to the Home screen.
2	Applications area	Touch any of the icons to open the application. Swipe the screen sideways to access more applications.  <b>NOTE:</b> The available applications vary by printer. The administrator can configure which applications appear and the order in which they appear.
3	<a href="#">Reset</a> button	Touch the <a href="#">Reset</a> button to clear changes, release the printer from a paused state, reset the copy count field, display hidden errors, and restore the default settings (including the language and keyboard layout).
4	<a href="#">Sign In</a> or <a href="#">Sign Out</a> button	Touch the <a href="#">Sign In</a> button to access secured features.  Touch the <a href="#">Sign Out</a> button to sign out of the printer. The printer restores all options to the default settings.  <b>NOTE:</b> This button displays only if the administrator has configured the printer to require permission for access to features.

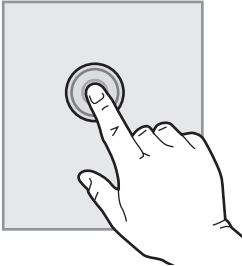
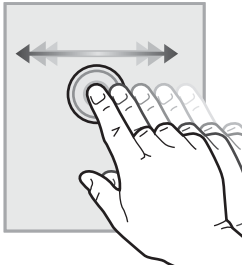
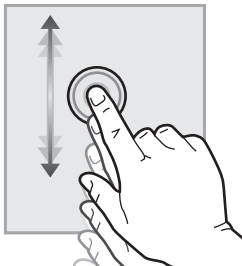


**Table 1-1** Printer control-panel view legend (continued)


Image callout	Printer component	Description
5	Information  button	<p>Touch the information button to access a screen that provides access to several types of printer information. Touch the buttons at the bottom of the screen for the following information:</p> <ul style="list-style-type: none"> <li>• <b>Display Language:</b> Change the language setting for the current user session.</li> <li>• <b>Sleep Mode:</b> Place the printer into sleep mode.</li> <li>• <b>Wi-Fi Direct:</b> View information for how to connect directly to the printer using a phone, tablet, or other device with Wi-Fi (only when an HP Jetdirect 3100w BLE/NFC/Wireless Accessory is installed).</li> <li>• <b>Wireless:</b> View or change wireless connection settings (only when an optional HP Jetdirect 2900nw Print Server wireless accessory is installed).</li> <li>• <b>Ethernet:</b> View or change Ethernet connection settings.</li> <li>• <b>HP Web Services:</b> View information to connect and print to the printer using HP Web Services (ePrint).</li> <li>• <b>Fax Number:</b> View the printer fax number (fax models only).</li> </ul>
6	Help  button	Touch the Help button to open the embedded help system.
7	Current time	Displays the current time.
8	<b>Start Copy</b> button	Touch the <b>Start Copy</b> button to start a copy job.
9	Copy count	The copy count indicates the number of copies that the printer is set to make.
10	Home-screen page indicator	Indicates the number of pages on the Home screen or in an application. The current page is highlighted. Swipe the screen sideways to scroll between pages.
11	Keyboard (Flow models only)	<p>Flow models include a physical keyboard. The keys are mapped to a language in the same way the virtual keyboard on the printer touchscreen is mapped. Whenever the keyboard layout for the virtual keyboard changes, the keys on the physical keyboard are remapped to match the new settings.</p> <p><b>NOTE:</b> In some locations, the printer comes with adhesive keyboard overlays to customize the keys for different languages.</p>
12	Easy-access USB port	<p>Insert a USB flash drive for printing or scanning without a computer or to update the printer firmware.</p> <p><b>NOTE:</b> An administrator must enable this port before use.</p>
13	Hardware integration pocket (HIP)	For connecting accessory and third-party devices.

## How to use the touchscreen control panel

Use the following actions to use the printer touchscreen control panel.

Action	Description	Example
<b>Touch</b> 	Touch an item on the screen to select that item or open that menu. Also, when scrolling through menus, briefly touch the screen to stop the scrolling.	Touch the <a href="#">Settings</a> icon to open the <a href="#">Settings</a> app.
<b>Swipe</b> 	Touch the screen and then move your finger horizontally to scroll the screen sideways.	Swipe until the <a href="#">Settings</a> app displays.
<b>Scroll</b> 	Touch the screen and then move your finger vertically to scroll the screen up and down. When scrolling through menus, briefly touch the screen to stop the scrolling.	Scroll through the <a href="#">Settings</a> app.

# Printer specifications

 **IMPORTANT:** The following specifications are correct at the time of publication, but they are subject to change. For current information, see [www.hp.com/support/ljE62655mfp](http://www.hp.com/support/ljE62655mfp), [www.hp.com/support/ljE62665mfp](http://www.hp.com/support/ljE62665mfp), or [www.hp.com/support/ljE62675mfp](http://www.hp.com/support/ljE62675mfp).

- [Technical specifications](#)
- [Supported operating systems](#)
- [Printer dimensions](#)
- [Power consumption, electrical specifications, and acoustic emissions](#)
- [Operating environment range](#)

## Technical specifications

**Table 1-2** Paper handling specifications

Paper handling features	Model E62655dn (Product # 3GY14A)	Model E62665h, E62665hs (Product # 3GY16A, 3GY15A)	Model E62665z, E62675z (Product # 3GY17A, 3GY18A)
Tray 1 (100-sheet capacity)	Included	Included	Included
Tray 2 (550-sheet capacity)	Included	Included	Included
1 x 550-sheet paper feeder	Optional	Optional	Optional
<b>NOTE:</b> These models accepts up to six optional 1 x 550-sheet feeders			
1 x 550-sheet paper feeder with stand	Optional	Optional	Optional
1 x 550-sheet feeder plus 2,100-sheet high-capacity feeder	Optional	Optional	Optional
3 x 550-sheet paper feeder with stand	Optional	Optional	Optional
Envelope feeder cassette for printing up to 75 envelopes	Optional	Optional	Optional
900-sheet 3-bin Stapling Mailbox	Not supported	Included with E62665hs	Included
Automatic duplex printing	Included	Included	Included

**Table 1-3** Connectivity specifications

Connectivity features	Model E62655dn (Product # 3GY14A)	Model E62665h, E62665hs (Product # 3GY16A, 3GY15A)	Model E62665z, E62675z (Product # 3GY17A, 3GY18A)
10/100/1000 Ethernet LAN connection with IPv4 and IPv6	Included	Included	Included
Hi-Speed USB 2.0	Included	Included	Included

**Table 1-3 Connectivity specifications (continued)**

Connectivity features	Model E62655dn (Product # 3GY14A)	Model E62665h, E62665hs (Product # 3GY16A, 3GY15A)	Model E62665z, E62675z (Product # 3GY17A, 3GY18A)
Easy-access USB port for printing without a computer and upgrading the firmware	<b>Included</b>	<b>Included</b>	<b>Included</b>
Hardware Integration Pocket for connecting accessory and third-party devices	<b>Included</b>	<b>Included</b>	<b>Included</b>
HP Internal USB Ports	Optional	Optional	Optional
HP Jetdirect 2900nw Print Server accessory for wireless connectivity	Optional	Optional	Optional
HP Jetdirect 3100w BLE/NFC/Wireless Accessory for printing from mobile devices	Optional	Optional	<b>Optional</b>

**NOTE:** Connected via the Hardware Integration Pocket or the rear host USB port. The HP Jetdirect 3100w BLE/NFC/Wireless Accessory requires the HP Internal USB ports accessory.

**Table 1-4 Print specifications**

Print features	Model E62655dn (Product # 3GY14A)	Model E62665h, E62665hs (Product # 3GY16A, 3GY15A)	Model E62665z, E62675z (Product # 3GY17A, 3GY18A)
Prints 52 pages per minute (ppm) on A4 and 55 ppm on letter-size paper	<b>Included</b>	Not Supported	Not Supported
Prints 61 ppm on A4 and 65 ppm on letter-size paper	Not Supported	<b>Included</b>	<b>Included with E62665z</b>
Prints 71 ppm on A4 and 75 ppm on letter-size paper	Not supported	Not supported	<b>Included with E62675z</b>
Easy-access USB printing (no computer required)	<b>Included</b>	<b>Included</b>	<b>Included</b>
Store jobs in the printer memory to print later or print privately	<b>Included</b>	<b>Included</b>	<b>Included</b>

**Table 1-5 Copy and Scan specifications**

Copy and Scan features	Model E62655dn (Product # 3GY14A)	Model E62665h, E62665hs (Product # 3GY16A, 3GY15A)	Model E62665z, E62675z (Product # 3GY17A, 3GY18A)
<b>NOTE:</b> Copy and scan speeds are subject to change. For the most current information, go to <a href="http://www.hp.com/support/ljE62655mfp">www.hp.com/support/ljE62655mfp</a> , <a href="http://www.hp.com/support/ljE62665mfp">www.hp.com/support/ljE62665mfp</a> , or <a href="http://www.hp.com/support/ljE62675mfp">www.hp.com/support/ljE62675mfp</a>			
Copies 52 pages per minute (ppm) on A4 and 55 ppm on letter-size paper	<b>Included</b>	Not supported	Not supported
Copies 61 ppm on A4 and 65 ppm on letter-size paper	Not supported	<b>Included</b>	<b>Included with E62665z</b>
Copies 71 ppm on A4 and 75 ppm on letter-size paper	Not supported	Not supported	<b>Included with E62675z</b>
Scans at 75 images per minute (ipm) (monochrome or color).	<b>Included</b>	<b>Included</b>	Not supported
Scans at 120 ipm (monochrome and color).	Not supported	Not supported	<b>Included</b>
Easy-access USB copying and scanning (no computer required)	<b>Included</b>	<b>Included</b>	<b>Included</b>
150-page document feeder with electronic duplex copying and scanning	<b>Included</b>	<b>Included</b>	<b>Included</b>
HP EveryPage Technologies including ultrasonic multi-feed detection	Included	Included	<b>Included</b>
Embedded optical character recognition (OCR) provides the ability to convert printed pages into text that can be edited or searched using a computer.	Included	Included	<b>Included</b>
SMART Label feature provides paper-edge detection for automatic page cropping	Included	Included	<b>Included</b>
Automatic page orientation for pages that have at least 100 characters of text.	Included	Included	<b>Included</b>
Automatic tone adjustment sets contrast, brightness, and background removal for each page.	Included	Included	<b>Included</b>

**Table 1-6 Digital Send specifications**

Digital Send features	Model E62655dn (Product # 3GY14A)	Model E62665h, E62665hs (Product # 3GY16A, 3GY15A)	Model E62665z, E62675z (Product # 3GY17A, 3GY18A)
Send documents to email, USB, and shared folders on a network	Included	Included	Included
Send documents to SharePoint®	Included	Included	Included

**Table 1-7 Memory specifications**

Memory features	Model E62655dn (Product # 3GY14A)	Model E62665h, E62665hs (Product # 3GY16A, 3GY15A)	Model E62665z, E62675z (Product # 3GY17A, 3GY18A)
1.75 GB base memory, expandable to 2.5 GB	Optional	Optional	Not supported
2.25 GB base memory, expandable to 3 GB	Not supported	Not supported	Optional

**Table 1-8 Other specifications**

Other features	Model E62655dn (Product # 3GY14A)	Model E62665h, E62665hs (Product # 3GY16A, 3GY15A)	Model E62665z, E62675z (Product # 3GY17A, 3GY18A)
Touchscreen control panel	Included	Included	Included
Retractable keyboard	Not supported	Not supported	Included
Mass storage: 320 GB HP High-Performance Secure Hard Disk	Optional	Included	Included
Security: HP Trusted Platform Module for encrypting all data that passes through the printer	Included	Included	Included
Fax	Optional	Optional	Optional

## Supported operating systems

**Linux:** For information and print drivers for Linux, go to [www.hp.com/go/linuxprinting](http://www.hp.com/go/linuxprinting).

**UNIX:** For information and print drivers for UNIX®, go to [www.hp.com/go/unixmodelscripts](http://www.hp.com/go/unixmodelscripts).

The following information applies to the printer-specific Windows HP PCL 6 print drivers, HP print drivers for macOS, and to the software installer.

**Windows:** Download HP Easy Start from [123.hp.com/LaserJet](http://123.hp.com/LaserJet) to install the HP print driver. Or, go to the printer-support website for this printer: [www.hp.com/support/ljE62655mfp](http://www.hp.com/support/ljE62655mfp), [www.hp.com/support/ljE62665mfp](http://www.hp.com/support/ljE62665mfp), or [www.hp.com/support/ljE62675mfp](http://www.hp.com/support/ljE62675mfp) to download the print driver or the software installer to install the HP print driver.


**macOS:** Mac computers are supported with this printer. Download HP Easy Start either from [123.hp.com/LaserJet](http://123.hp.com/LaserJet) or from the Printer Support page, and then use HP Easy Start to install the HP print driver.


1. Go to [123.hp.com/LaserJet](http://123.hp.com/LaserJet).
2. Follow the steps provided to download the printer software.

**Table 1-9 Supported operating systems and print drivers**

Operating system	Print driver (for Windows, or the installer on the web for macOS)
Windows 7, 32-bit and 64-bit	The "HP PCL 6" printer-specific print driver is installed for this operating system as part of the software installation.
Windows 8, 32-bit and 64-bit	The "HP PCL 6" printer-specific print driver is installed for this operating system as part of the software installation.
Windows 8.1, 32-bit and 64-bit	The "HP PCL-6" V4 printer-specific print driver is installed for this operating system as part of the software installation.
Windows 10, 32-bit and 64-bit	The "HP PCL-6" V4 printer-specific print driver is installed for this operating system as part of the software installation.
Windows Server 2008 R2, SP 1, 64-bit	The PCL 6 printer-specific print driver is available for download from the printer-support website. Download the driver, and then use the Microsoft Add Printer tool to install it.
Windows Server 2012, 64-bit	The PCL 6 printer-specific print driver is available for download from the printer-support website. Download the driver, and then use the Microsoft Add Printer tool to install it.
Windows Server 2012 R2, 64-bit	The PCL 6 printer-specific print driver is available for download from the printer-support website. Download the driver, and then use the Microsoft Add Printer tool to install it.
Windows Server 2016, 64-bit	The PCL 6 printer-specific print driver is available for download from the printer-support website. Download the driver, and then use the Microsoft Add Printer tool to install it.
macOS 10.12 Sierra, macOS 10.13 High Sierra	Download HP Easy Start from <a href="http://123.hp.com/LaserJet">123.hp.com/LaserJet</a> , and then use it to install the print driver.

 **NOTE:** Supported operating systems can change.

 **NOTE:** For a current list of supported operating systems, go to [www.hp.com/support/ljE62655mfp](http://www.hp.com/support/ljE62655mfp), [www.hp.com/support/ljE62665mfp](http://www.hp.com/support/ljE62665mfp), or [www.hp.com/support/ljE62675mfp](http://www.hp.com/support/ljE62675mfp) for HP's all-inclusive help for the printer.

 **NOTE:** For details on client and server operating systems and for HP UPD driver support for this printer, go to [www.hp.com/go/upd](http://www.hp.com/go/upd). Under **Additional information**, click the links.

**Table 1-10 Minimum system requirements**

Windows	macOS
<ul style="list-style-type: none"> <li>• Internet connection</li> <li>• Dedicated USB 1.1 or 2.0 connection or a network connection</li> <li>• 2 GB of available hard-disk space</li> <li>• 1 GB RAM (32-bit) or 2 GB RAM (64-bit)</li> </ul>	<ul style="list-style-type: none"> <li>• Internet connection</li> <li>• Dedicated USB 1.1 or 2.0 connection or a network connection</li> <li>• 1.5 GB of available hard-disk space</li> </ul>



**NOTE:** The Windows software installer installs the HP Smart Device Agent Base service. The file size is approximately 100 kb. Its only function is to check for printers connected via USB hourly. No data is collected. If a USB printer is found, it then tries to locate a JetAdvantage Management Connector (JAMc) instance on the network. If a JAMc is found, the HP Smart Device Agent Base is securely upgraded to a full Smart Device Agent from JAMc, which will then allow printed pages to be accounted for in a Managed Print Services (MPS) account. The driver-only web packs downloaded from hp.com for the printer and installed through the Add Printer wizard do not install this service.

To uninstall the service, open the **Control Panel**, select **Programs** or **Programs and Features**, and then select **Add/Remove Programs** or **Uninstall a Program** to remove the service. The file name is **HPSmartDeviceAgentBase**.

## Printer dimensions

**Table 1-11** Dimensions for E62655dn, E62665h

Dimension	Printer fully closed	Printer fully opened
Height	640 mm (25.2 in)	865 mm (34.1 in)
Depth	558 mm (22 in)	805 mm (31.7 in)
Width	512 mm (20.15 in)	1,030 mm (40.5 in)
Weight (with toner cartridge)	33.2 kg (73.2 lb)	

**Table 1-12** Dimensions for E62665hs, E62665z, E62675z

Dimension	Printer fully closed	Printer fully opened
Height	1,234 mm (48.5 in)	1,500 mm (59.1 in)
Depth	658 mm (25.9 in)	890 mm (35 in)
Width	661 mm (26 in)	1,030 mm (40.5 in)
Weight (with toner cartridge)	64.3 kg (141.8 lb)	

**Table 1-13** Dimensions for the 1 x 550-sheet paper feeder

Dimension	Accessory fully closed	Accessory fully opened
Height	148 mm (5.8 in)	148 mm (5.8 in)
Depth	558 mm (22 in)	869 mm (34.2 in)
Width	512 mm (20.15 in)	617 mm (24.3 in)
Weight	6.8 kg (15 lb)	

**Table 1-14** Dimensions for the 1 x 550-sheet feeder with printer stand

Dimension	Accessory fully closed	Accessory fully opened
Height	478 mm (18.8 in)	478 mm (18.8 in)
Depth	658 mm (25.9 in)	1,050 mm (41.3 in)



**Table 1-14** Dimensions for the 1 x 550-sheet feeder with printer stand (continued)

Dimension	Accessory fully closed	Accessory fully opened
Width	660 mm (26 in)	980 mm (38.6 in)
Weight	19.28 kg (42.5 lb)	

**Table 1-15** Dimensions for the 3 x 550-sheet paper feeder with stand

Dimension	Accessory fully closed	Accessory fully opened
Height	450 mm (17.7 in)	450 mm (17.7 in)
Depth	657 mm (25.8 in)	984 mm (37.3 in)
Width	657 mm (25.8 in)	992 mm (39 in)
Weight	22.7 kg (50 lb)	

**Table 1-16** Dimensions for the 1 x 550-sheet feeder and 2,100-sheet HCI with stand

Dimension	Accessory fully closed	Accessory fully opened
Height	478 mm (18.8 in)	478 mm (18.8 in)
Depth	658 mm (25.9 in)	975 mm (38.4 in)
Width	660 mm (26 in)	980 mm (38.6 in)
Weight	24.5 kg (54 lb)	

**Table 1-17** Dimensions for the envelope feeder cassette

Dimension	Accessory fully closed	Accessory fully opened
Height	148 mm (5.8 in)	148 mm (5.8 in)
Depth	558 mm (22 in)	869 mm (34.2 in)
Width	512 mm (20.15 in)	617 mm (24.3 in)
Weight	6.9 kg (15.3 lb)	

## Power consumption, electrical specifications, and acoustic emissions

See [www.hp.com/support/ljE62655mfp](http://www.hp.com/support/ljE62655mfp), [www.hp.com/support/ljE62665mfp](http://www.hp.com/support/ljE62665mfp), or [www.hp.com/support/ljE62675mfp](http://www.hp.com/support/ljE62675mfp) for current information.

**⚠ CAUTION:** Power requirements are based on the country/region where the printer is sold. Do not convert operating voltages. This will damage the printer and void the printer warranty.

## Operating environment range

Table 1-18 Operating environment range

Environment	Recommended	Allowed
Temperature	17° to 25°C (62.6° to 77°F)	10° to 32.5°C (50° to 90.5°F)
Relative humidity	30% to 70% relative humidity (RH)	10% to 80% RH

## Printer hardware setup and software installation

For basic setup instructions, see the Hardware Installation Guide that came with the printer. For additional instructions, go to HP support on the Web.

Go to [www.hp.com/support/ljE62655mfp](http://www.hp.com/support/ljE62655mfp), [www.hp.com/support/ljE62665mfp](http://www.hp.com/support/ljE62665mfp), or [www.hp.com/support/ljE62675mfp](http://www.hp.com/support/ljE62675mfp) for HP's all-inclusive help for the printer. Find the following support:

- Install and configure
- Learn and use
- Solve problems
- Download software and firmware updates
- Join support forums
- Find warranty and regulatory information



---

## 2 Paper trays

- [Introduction](#)
- [Load paper to Tray 1 \(multipurpose tray\)](#)
- [Load paper to Tray 2 and the 550-sheet trays](#)
- [Load paper to the 2,100-sheet high-capacity input tray](#)
- [Load and print envelopes](#)
- [Load and print labels](#)
- [Configure the 900-sheet 3-bin Stapling Mailbox \(Flow model\)](#)

### For more information

The following information is correct at the time of publication.

For video assistance, see [www.hp.com/videos/LaserJet](http://www.hp.com/videos/LaserJet).


For current information, see [www.hp.com/support/ljE62655mfp](http://www.hp.com/support/ljE62655mfp), [www.hp.com/support/ljE62665mfp](http://www.hp.com/support/ljE62665mfp), or [www.hp.com/support/ljE62675mfp](http://www.hp.com/support/ljE62675mfp).

HP's all-inclusive help for the printer includes the following information:

- Install and configure
- Learn and use
- Solve problems
- Download software and firmware updates
- Join support forums
- Find warranty and regulatory information

## Introduction

---

 **CAUTION:** Do not extend more than one paper tray at a time.

Do not use paper tray as a step.

Keep hands out of paper trays when closing.

All trays must be closed when moving the printer.

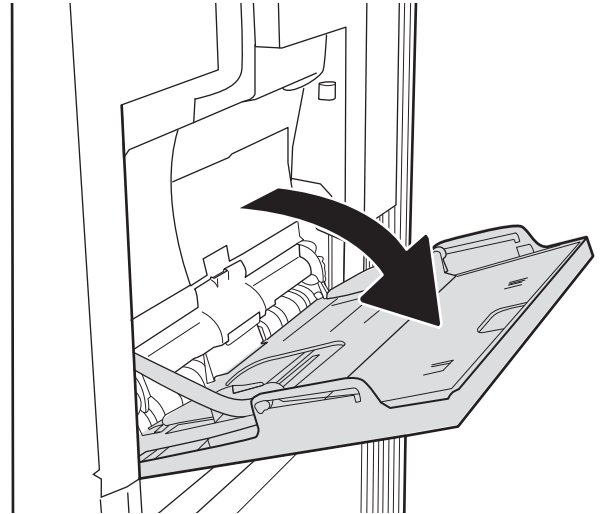
---

## Load paper to Tray 1 (multipurpose tray)

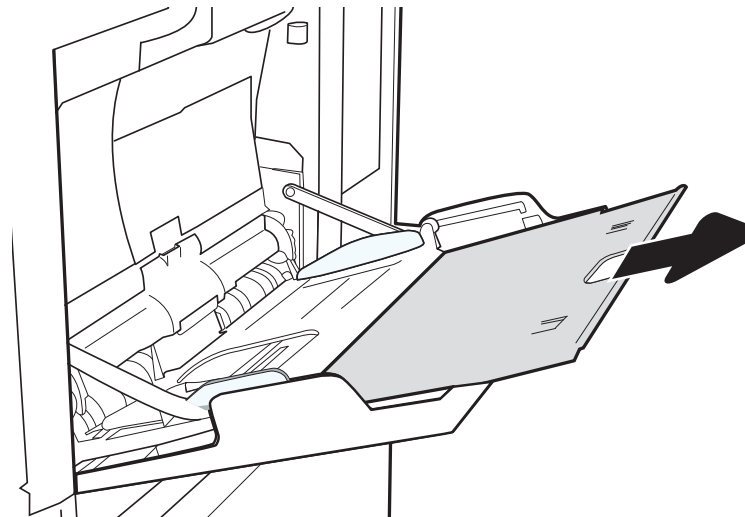
The following information describes how to load paper in Tray 1.

**⚠ CAUTION:** To avoid jams, never add or remove paper from Tray 1 during printing.

1. Open Tray 1.



2. Pull out the tray extension to support the paper.

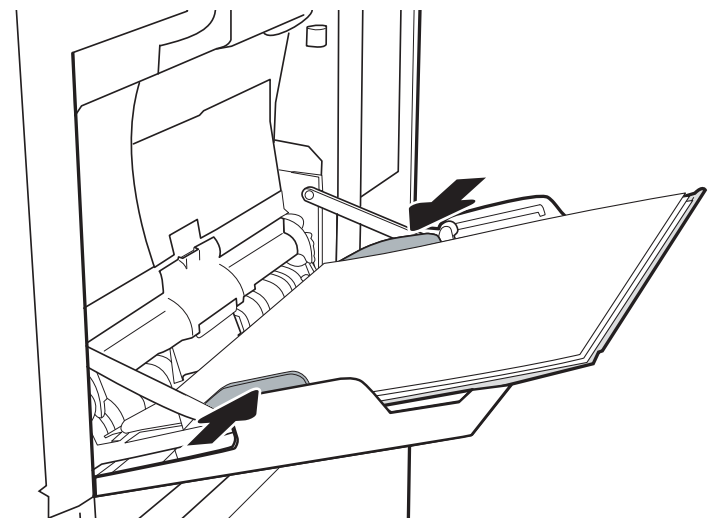
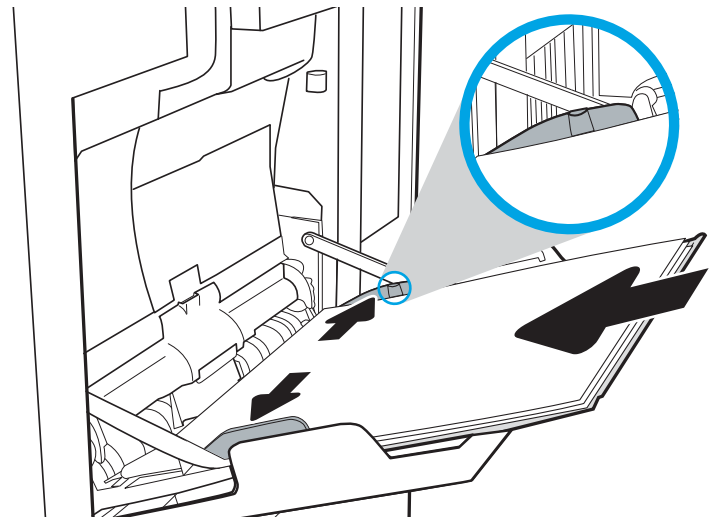


- Use the blue adjustment latch to spread the paper guides to the correct size, and then load paper in the tray. For information about how to orient the paper, see [Table 2-1 Tray 1 paper orientation on page 22](#).

Make sure that the paper fits under the fill line on the paper guides.

**NOTE:** The maximum stack height is 10 mm (0.4 in), or approximately 100 sheets of 75 g/m<sup>2</sup> (20 lb) paper.

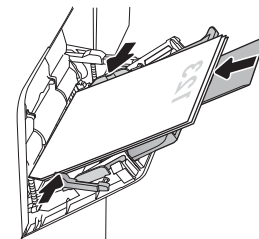
- Using the blue adjustment latch, adjust the side guides so that they touch the paper stack, but do not bend it.



## Tray 1 paper orientation

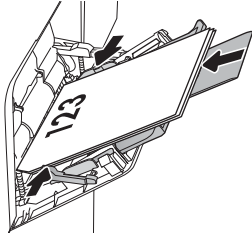
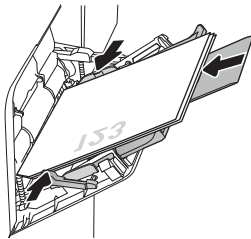
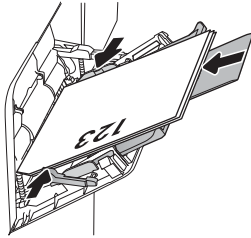
Table 2-1 Tray 1 paper orientation

Paper type	Image orientation	Duplex mode	Paper size	How to load paper
Letterhead or preprinted	Portrait	1-sided printing	Letter, Legal, Executive, Statement, Oficio (8.5 x 13), 3 x 5, 4 x 6, 5 x 7, 5 x 8, A4, A5, A6, RA4, B5 (JIS), B6 (JIS), L (90 x 130 mm), 10 x 15 cm, Oficio (216 x 340), 16K 195 x 270 mm, 16K 184 x 260 mm, 16K 197 x 273 mm, Japanese Postcard (Postcard (JIS)), Double Japan Postcard Rotated (Double Postcard (JIS))	Face-down Bottom edge leading into the printer

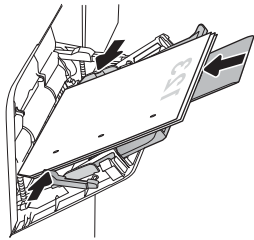
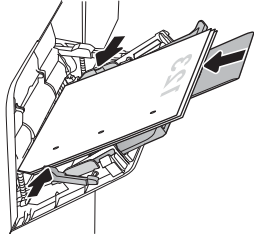




**Table 2-1** Tray 1 paper orientation (continued)

Paper type	Image orientation	Duplex mode	Paper size	How to load paper
		Automatic 2-sided printing or with Alternative Letterhead Mode enabled	Letter, Legal, Executive, Oficio (8.5 x 13), A4, A5, RA4, B5 (JIS), Oficio (216 x 340), 16K 195 x 270 mm, 16K 184 x 260 mm, 16K 197 x 273 mm	Face-up Top edge leading into the printer 
	Landscape	1-sided printing	Letter, Legal, Executive, Statement, Oficio (8.5 x 13), 3 x 5, 4 x 6, 5 x 7, 5 x 8, A4, A5, A6, RA4, B5 (JIS), B6 (JIS), L (90 x 130 mm), 10 x 15 cm, Oficio (216 x 340), 16K 195 x 270 mm, 16K 184 x 260 mm, 16K 197 x 273 mm, Japanese Postcard (Postcard (JIS)), Double Japan Postcard Rotated (Double Postcard (JIS))	Face-down Top edge toward the front of the printer 
		Automatic 2-sided printing or with Alternative Letterhead Mode enabled	Letter, Legal, Executive, Oficio (8.5 x 13), A4, A5, RA4, B5 (JIS), Oficio (216 x 340), 16K 195 x 270 mm, 16K 184 x 260 mm, 16K 197 x 273 mm	Face-up Top edge toward the front of the printer 

**Table 2-1** Tray 1 paper orientation (continued)

Paper type	Image orientation	Duplex mode	Paper size	How to load paper
Prepunched	Portrait and landscape	1-sided printing	Letter, Legal, Executive, Statement, Oficio (8.5 x 13), 3 x 5, 4 x 6, 5 x 7, 5 x 8, A4, A5, A6, RA4, B5 (JIS), B6 (JIS), L (90 x 130 mm), 10 x 15 cm, Oficio (216 x 340), 16K 195 x 270 mm, 16K 184 x 260 mm, 16K 197 x 273 mm, Japanese Postcard (Postcard (JIS)), Double Japan Postcard Rotated (Double Postcard (JIS))	Holes toward the front of the printer 
		Automatic 2-sided printing or with Alternative Letterhead Mode enabled	Letter, Legal, Executive, Oficio (8.5 x 13), A4, A5, RA4, B5 (JIS), Oficio (216 x 340), 16K 195 x 270 mm, 16K 184 x 260 mm, 16K 197 x 273 mm	Holes toward the front of the printer 

## Use alternative letterhead mode

Use the [Alternative Letterhead Mode](#) feature to load letterhead or preprinted paper into the tray the same way for all jobs, whether printing to one side of the sheet of paper or to both sides. When using this mode, load paper as for automatic duplex printing.

To use the feature, enable it by using the printer control-panel menus.


### Enable Alternative Letterhead Mode by using the printer control-panel menus

1. From the Home screen on the printer control panel, navigate to the [Settings](#) application, and then select the [Settings](#) icon.
2. Open the following menus:
  - a. [Copy/Print](#) or [Print](#)
  - b. [Manage Trays](#)
  - c. [Alternative Letterhead Mode](#)
3. Select [Enabled](#), and then touch the [Save](#) button or press the [OK](#) button.

# Load paper to Tray 2 and the 550-sheet trays

## Introduction

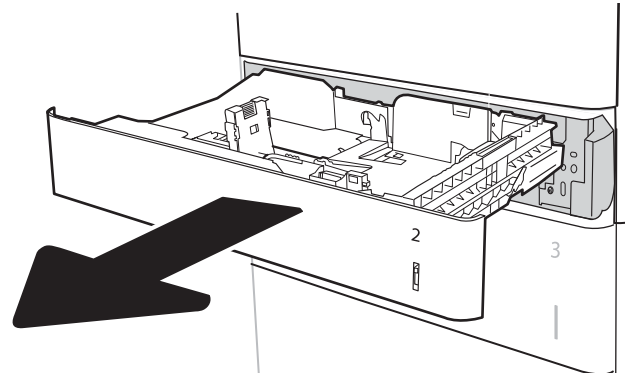
The following information describes how to load paper into Tray 2 and the optional 550-sheet trays. These trays hold up to 550 sheets of 75 g/m<sup>2</sup> (20 lb) paper.

 **NOTE:** The procedure to load paper for the 550-sheet trays is the same as for Tray 2. Only Tray 2 is shown here.

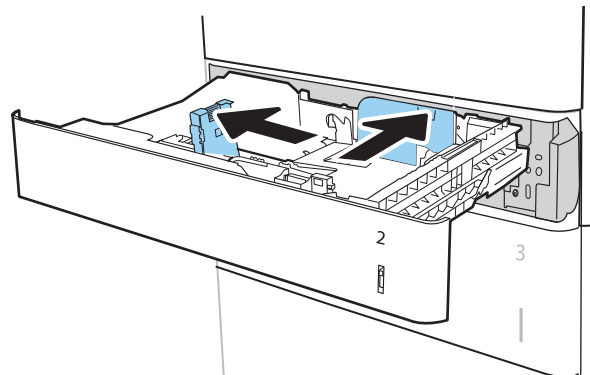
 **NOTE:** The paper guides may be locked before use and may not be adjustable.

1. Open the tray.

**NOTE:** Do not open this tray while it is in use.



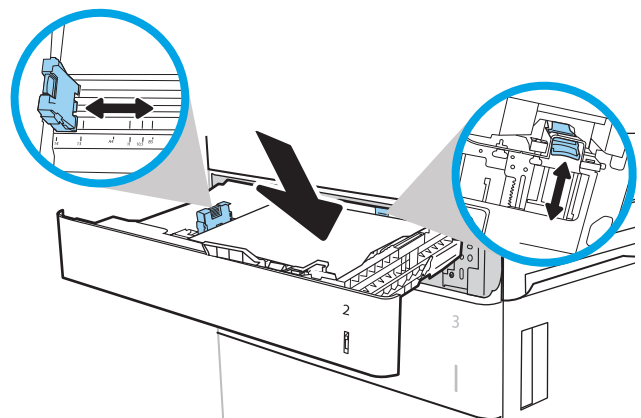
2. Adjust the paper-length and paper-width guides by squeezing the blue adjustment latches and sliding the guides to the size of the paper being used.



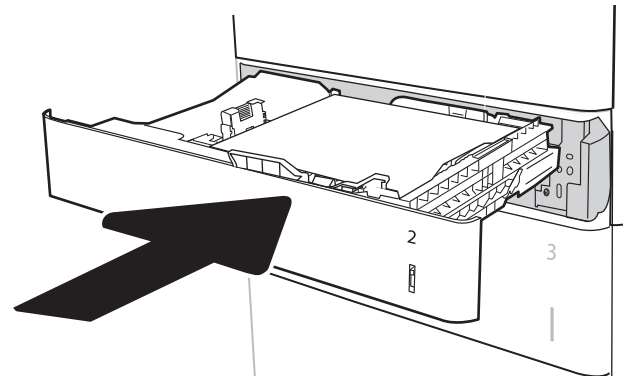
3. Load paper into the tray. Check the paper to verify the guides touch the stack, but do not bend it. For information about how to orient the paper, see [Table 2-2 Tray 2 and the 550-sheet trays paper orientation on page 27](#).

**NOTE:** To prevent jams, do not overfill the tray. Be sure that the top of the stack is below the tray full indicator.

**NOTE:** If the tray is not adjusted correctly, an error message might appear during printing or the paper might jam.

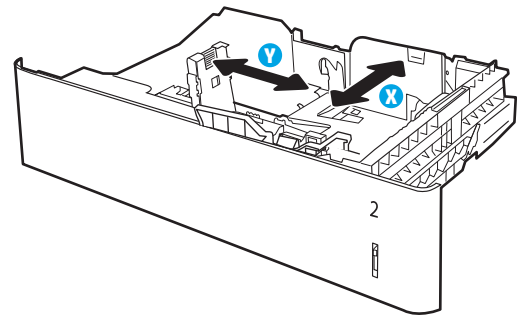


4. Close the tray.



5. The tray configuration message displays on the printer control panel.
6. Touch the **OK** button to accept the detected type and size, or touch the **Modify** button to choose a different paper size or type.

For custom-size paper, specify the X and Y dimensions for the paper when the prompt displays on the printer control panel.

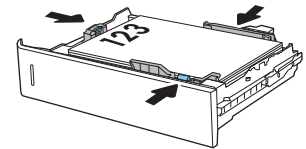


7. Select the correct type and size, and then touch the **OK** button.

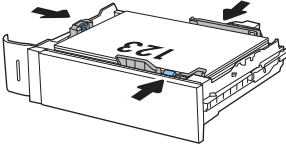
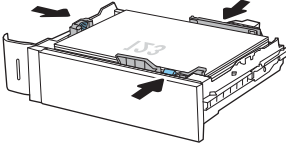
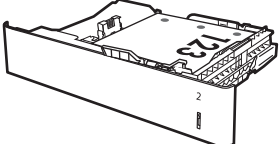
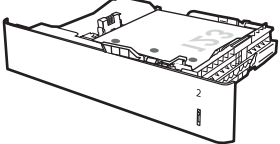
## Tray 2 and the 550-sheet trays paper orientation

**Table 2-2** Tray 2 and the 550-sheet trays paper orientation

Paper type	Image orientation	Duplex mode	Paper size	How to load paper
Letterhead or preprinted	Portrait	1-sided printing	Letter, Legal, Executive, Statement, Oficio (8.5 x 13), 4 x 6, 5 x 7, 5 x 8, A4, A5, A6, RA4, B5 (JIS), B6 (JIS), L (90 x 130 mm), 10 x 15 cm, Oficio (216 x 340), 16K 195 x 270 mm, 16K 184 x 260 mm, 16K 197 x 273 mm, Double Japan Postcard Rotated (Double Postcard (JIS))	Face-up Top edge at the left side of the tray



**Table 2-2** Tray 2 and the 550-sheet trays paper orientation (continued)

Paper type	Image orientation	Duplex mode	Paper size	How to load paper
	Landscape	1-sided printing	Letter, Legal, Executive, Statement, Oficio (8.5 x 13), 4 x 6, 5 x 7, 5 x 8, A4, A5, A6, RA4, B5 (JIS), B6 (JIS), L (90 x 130 mm), 10 x 15 cm, Oficio (216 x 340), 16K 195 x 270 mm, 16K 184 x 260 mm, 16K 197 x 273 mm, Double Japan Postcard Rotated (Double Postcard (JIS))	Face-up Top edge toward the back of the tray 
		Automatic 2-sided printing or with Alternative Letterhead Mode enabled	Letter, Legal, Executive, Oficio (8.5 x 13), A4, A5, RA4, Oficio (216 x 340), 16K 195 x 270 mm, 16K 184 x 260 mm, 16K 197 x 273 mm	Face-down Top edge toward the back of the tray 
Prepunched	Portrait or landscape	1-sided printing	Letter, Legal, Executive, Statement, Oficio (8.5 x 13), 4 x 6, 5 x 7, 5 x 8, A4, A5, A6, RA4, B5 (JIS), B6 (JIS), L (90 x 130 mm), 10 x 15 cm, Oficio (216 x 340), 16K 195 x 270 mm, 16K 184 x 260 mm, 16K 197 x 273 mm, Double Japan Postcard Rotated (Double Postcard (JIS))	Face-up Holes toward the back of the tray 
		Automatic 2-sided printing or with Alternative Letterhead Mode enabled	Letter, Legal, Executive, Oficio (8.5 x 13), A4, A5, RA4, Oficio (216 x 340), 16K 195 x 270 mm, 16K 184 x 260 mm, 16K 197 x 273 mm	Face-down Holes toward the front of the tray 

## Use alternative letterhead mode

Use the [Alternative Letterhead Mode](#) feature to load letterhead or preprinted paper into the tray the same way for all jobs, whether printing to one side of the sheet of paper or to both sides. When using this mode, load paper as for automatic duplex printing.

To use the feature, enable it by using the printer control-panel menus.

### Enable Alternative Letterhead Mode by using the printer control-panel menus

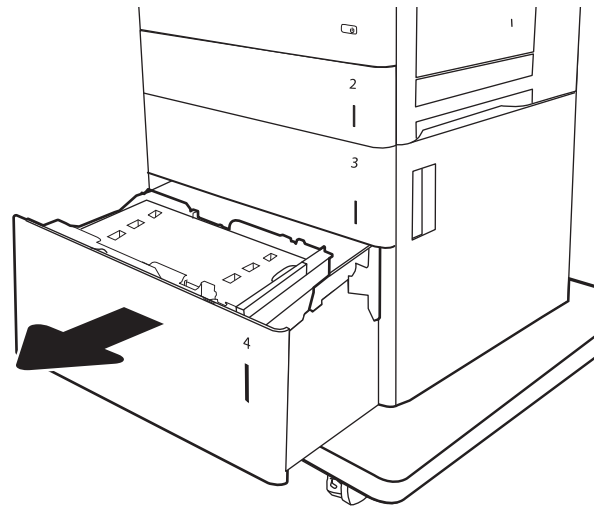
1. From the Home screen on the printer control panel, navigate to the [Settings](#) application, and then select the [Settings](#) icon.
2. Open the following menus:
  - a. [Copy/Print](#) or [Print](#)
  - b. [Manage Trays](#)
  - c. [Alternative Letterhead Mode](#)
3. Select [Enabled](#), and then touch the [Save](#) button or press the [OK](#) button.

## Load paper to the 2,100-sheet high-capacity input tray

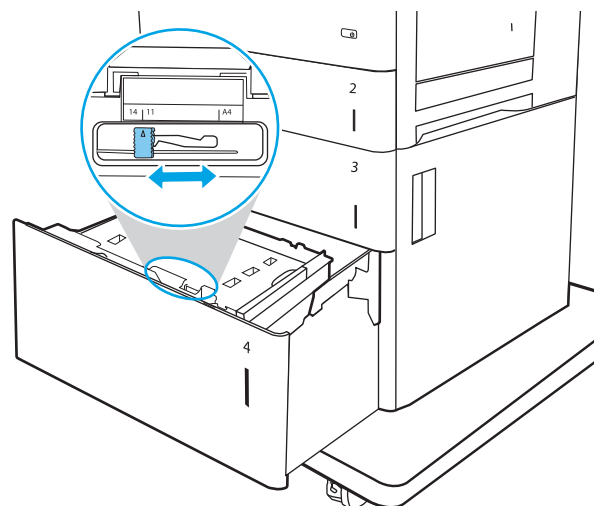
The following information describes how to load paper in the high-capacity input tray. This tray is part of the 1x550-sheet and 2,100-sheet high-capacity input feeder and holds up to 2,100 sheets of 75 g/m<sup>2</sup> (20 lb) paper.

1. Open the tray.

**NOTE:** Do not open this tray while it is in use.



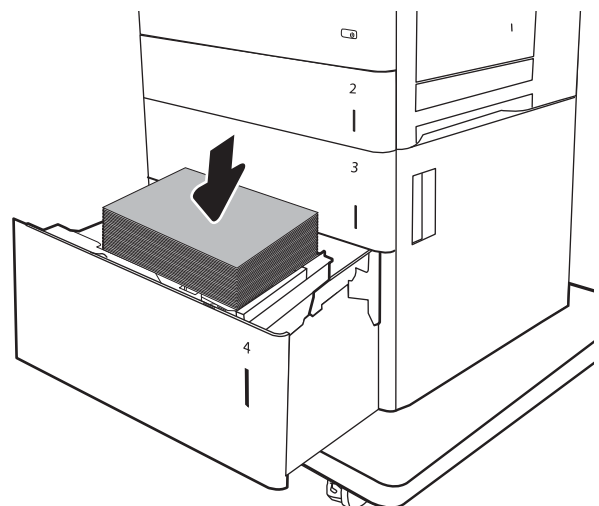
2. Adjust the paper-size lever to the correct position for the paper.



3. Load paper into the tray.

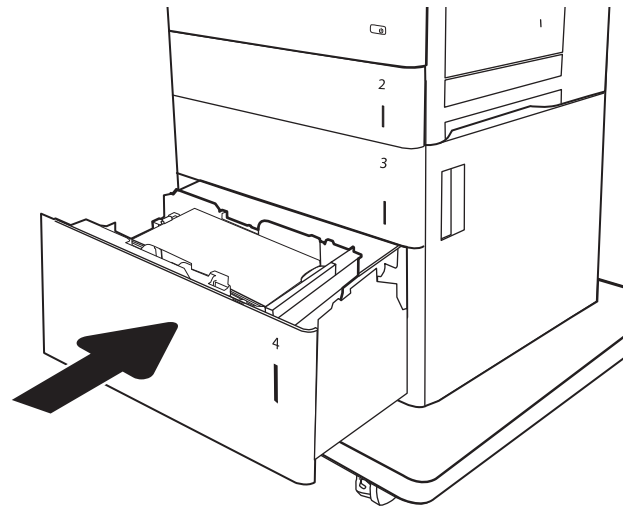
**NOTE:** To prevent jams, do not overfill the tray. Be sure that the top of the stack is below the tray full indicator.

**NOTE:** If the tray is not adjusted correctly, an error message might appear during printing or the paper might jam.





4. Close the tray.



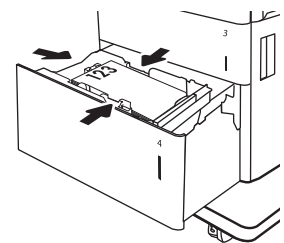
5. The tray configuration message displays on the printer control panel.
6. Touch the **OK** button to accept the detected type and size, or touch the **Modify** button to choose a different paper size or type.
7. Select the correct type and size, and then touch the **OK** button.

## High-capacity input tray paper orientation

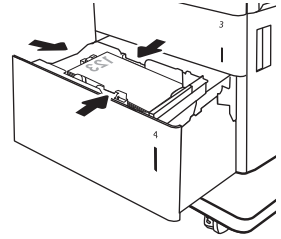
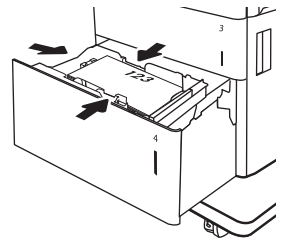
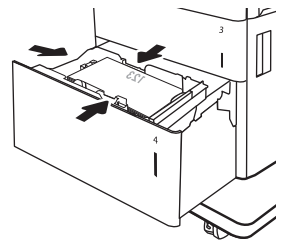
**Table 2-3** High-capacity input tray paper orientation

Paper type	Image orientation	Duplex mode	Paper size	How to load paper
Letterhead or preprinted	Portrait	1-sided printing	Letter, Legal, A4	Face-up

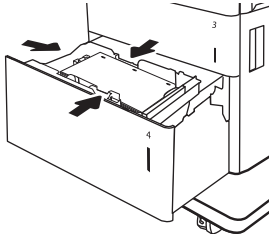
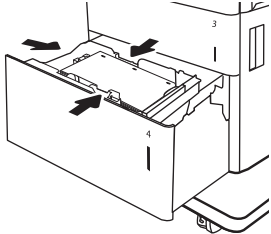
Top edge at the left side of the tray



**Table 2-3 High-capacity input tray paper orientation (continued)**

Paper type	Image orientation	Duplex mode	Paper size	How to load paper
Letterhead or preprinted	Portrait	Automatic 2-sided printing or with Alternative Letterhead Mode enabled	Letter, Legal, A4	Face-down Top edge at the left side of the tray 
Letterhead or preprinted	Landscape	1-sided printing	Letter, Legal, A4	Face-up Top edge toward the back of the tray 
Letterhead or preprinted	Landscape	Automatic 2-sided printing or with Alternative Letterhead Mode enabled	Letter, Legal, A4	Face-down Top edge toward the back of the tray 

**Table 2-3 High-capacity input tray paper orientation (continued)**

Paper type	Image orientation	Duplex mode	Paper size	How to load paper
Prepunched	Portrait or landscape	1-sided printing	Letter, Legal, A4	Holes toward the back of the tray 
Prepunched	Portrait or landscape	Automatic 2-sided printing or with Alternative Letterhead Mode enabled	Letter, Legal, A4	Holes toward the back of the tray 

# Load and print envelopes

## Introduction

The following information describes how to load and print envelopes. Use Tray 1 or the envelope feeder accessory to print on envelopes. Tray 1 holds up to 10 envelopes; the envelope feeder accessory holds 75 envelopes, depending on envelope design and environmental conditions.

To print envelopes using the manual feed option, follow these steps to select the correct settings in the print driver, and then load the envelopes into the tray after sending the print job to the printer.


## Print envelopes

### Print envelopes from Tray 1

1. From the software program, select the **Print** option.
2. Select the printer from the list of printers, and then click or tap the **Properties** or **Preferences** button to open the print driver.

---

 **NOTE:** The name of the button varies for different software programs.

 **NOTE:** To access these features from a Windows 8 or 8.1 Start screen app, select **Devices**, select **Print**, and then select the printer.


---

3. Click or tap the **Paper/Quality** tab.
4. In the **Paper size** drop-down list, select the correct size for the envelopes.
5. In the **Paper type** drop-down list, select **Envelope**.
6. In the **Paper source** drop-down list, select **Manual feed**.
7. Click the **OK** button to close the **Document Properties** dialog box.
8. In the **Print** dialog box, click the **Print** button to print the job.

### Print envelopes from the envelope feeder accessory

1. From the software program, select the **Print** option.
2. Select the printer from the list of printers, and then click or tap the **Properties** or **Preferences** button to open the print driver.

---

 **NOTE:** The name of the button varies for different software programs.

To access these features from a Windows 8 or 8.1 Start screen app, select **Devices**, select **Print**, and then select the printer.

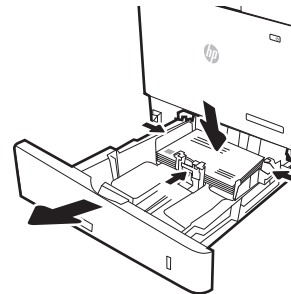
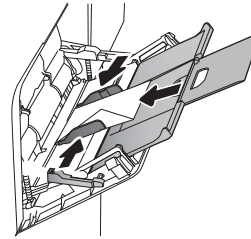
---

3. Click or tap the **Paper/Quality** tab.
4. Complete one of the following steps:

- In the **Paper size** drop-down list, select the correct size for the envelopes.
  - In the **Paper type** drop-down list, select **Envelope**.
  - In the **Paper source** drop-down list, select **Tray 3** or **Tray 4**—whichever tray corresponds to the envelope feeder.
5. Click the **OK** button to close the **Document Properties** dialog box.
  6. In the **Print** dialog box, click the **OK** button to print the job.

## Envelope orientation

Tray	Envelope size	How to load
Tray 1	Envelope #9, Envelope #10, Envelope Monarch, Envelope B5, Envelope C5, Envelope C6, Envelope DL	Face-down Top edge toward the front of the printer
Envelope feeder accessory	Envelope #9, Envelope #10, Envelope Monarch, Envelope B5, Envelope C5, Envelope C6, Envelope DL	Face-up Top edge toward the front of the printer




# Load and print labels

## Introduction

The following information describes how to load and print labels.

To print on sheets of labels, use Tray 2 or one of the optional 550-sheet trays.

---

 **NOTE:** Tray 1 does not support labels.

---

To print labels using the manual feed option, follow these steps to select the correct settings in the print driver, and then load the labels into the tray after sending the print job to the printer. When using manual feed, the printer waits to print the job until it detects that the tray has been opened and closed.

## Manually feed labels

1. From the software program, select the **Print** option.
2. Select the printer from the list of printers, and then click or tap the **Properties** or **Preferences** button to open the print driver.

---

 **NOTE:** The name of the button varies for different software programs.


---

 **NOTE:** To access these features from a Windows 8 or 8.1 Start screen app, select **Devices**, select **Print**, and then select the printer.

---

3. Click the **Paper/Quality** tab.
4. In the **Paper size** drop-down list, select the correct size for the sheets of labels.
5. In the **Paper type** drop-down list, select **Labels**.
6. In the **Paper source** drop-down list, select **Manual feed**.

---

 **NOTE:** When using manual feed, the printer prints from the lowest-numbered tray that is configured for the correct size of paper, so it is not necessary to specify a particular tray. For example, if Tray 2 is configured for labels, the printer will print from Tray 2. If Tray 3 is installed and configured for labels, but Tray 2 is not configured for labels, the printer will print from Tray 3.

---

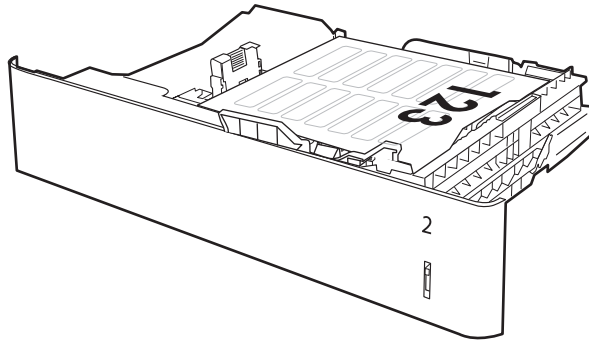
7. Click the **OK** button to close the **Document Properties** dialog box.
8. In the **Print** dialog box, click the **Print** button to print the job.

## Label orientation

---

Tray	How to load labels
Trays 2-5	Face-up Top edge at the right of the tray

---



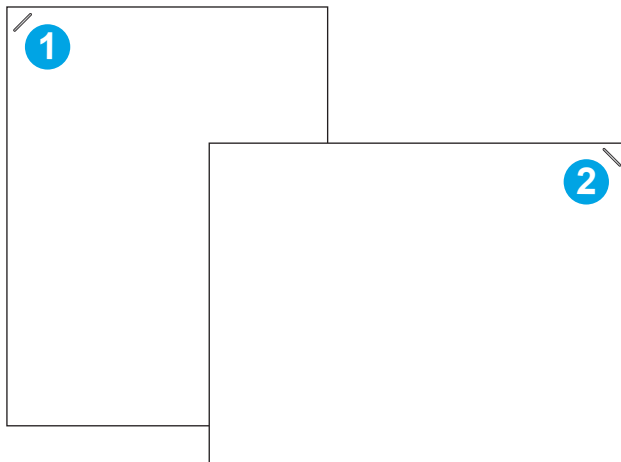
## Configure the 900-sheet 3-bin Stapling Mailbox (Flow model)

The stapling mailbox can staple documents in the upper left or upper right corners, and it can stack up to 900 sheets of paper in the three output bins. The output bins have three mode-configuration options: stacker mode, mailbox mode, or function separator mode.

- [Configure the default staple location](#)
- [Configure the operation mode](#)

### Configure the default staple location

1. From the Home screen on the printer control panel, navigate to the [Settings](#) application, and then select the [Settings](#) icon.
2. Open the following menus:
  - a. [Manage Stapler/Stacker](#)
  - b. [Staple](#)
3. Select a staple location from the list of options, and then touch the [Save](#) button. The following options are available:
  - [None](#): No staples
  - [Top left or right](#): If the document has portrait orientation, the staple is in the top left corner of the short edge of the paper. If the document has landscape orientation, the staple is in the top right corner of the long edge of the paper.
  - [Top left](#): The staple is in the top left corner of the short edge of the paper.
  - [Top right](#): The staple is in the top right corner of the long edge of the paper.



- 
- |   |  |
|---|--|
| 1 | Top left corner of the short edge of the paper |
| 2 | Top right corner of the long edge of the paper |
- 

### Configure the operation mode

Use this procedure to configure how the printer sorts jobs into the output bins.



1. From the Home screen on the printer control panel, navigate to the [Settings](#) application, and then select the [Settings](#) icon.
2. Open the following menus:
  - a. [Manage Stapler/Stacker](#)
  - b. [Operation Mode](#)
3. Select a mode from the list of options, and then select the [Save](#) button. The following options are available:
  - [Mailbox](#): The printer places jobs in different bins according to the person who sent them.
  - [Stacker](#): The printer stacks jobs in the bins from bottom to top.
  - [Function Separator](#): The printer places jobs in different bins according to printer function such as print jobs, copy jobs, or fax jobs.

To configure the HP print driver for the selected operation mode, complete the following steps:

### Windows® 7

1. Make sure the printer is turned on and connected to the computer or a network.
2. Open the Windows® Start menu, and then click **Devices and Printers**.
3. Right-click the name of the printer, and then select **Printer Properties**.
4. Click the **Device Settings** tab.
5. Select **Update Now**. Or, in the drop-down menu next to **Automatic Configuration**, select **Update Now**.

### Windows® 8.0, 8.1, and 10

1. Right-click on the bottom-left corner of the screen.
2. Select **Control Panel**. Under **Hardware and Sound**, select **View devices and printers**.
3. Right-click the name of the printer, and then select **Printer Properties**.
4. Click the **Device Settings** tab.
5. Select **Update Now**. Or, in the drop-down menu next to **Automatic Configuration**, select **Update Now**.



**NOTE:** Newer V4 drivers do not support **Update Now**. For these drivers, complete **one** of the following procedures:

- 
- Manually configure the operation mode under **Accessory Output Bin**, if listed.
  - Stop and restart the print spooler
    - a. Click the **Start** button (or open a search box).
    - b. Type `services.msc`, and then press the [Enter](#) key.
    - c. Right-click **Print Spooler** in the list of services, and select **Stop**.
    - d. Right click **Print Spooler** again, and select **Start**.
  - Shut down and restart the computer.

## macOS

1. From the Apple menu, click **System Preferences**.
2. Select **Print & Scan** (or **Printers & Scanners**).
3. Select the printer, and then select **Options & Supplies**. Select **Driver**.
4. Manually configure the **Accessory Output Mode**, if available. Or, if not available, the operation mode is configured at the time of printing.

---

## 3 Supplies, accessories, and parts

- [Order supplies, accessories, and parts](#)
- [Replace the toner cartridge](#)
- [Replace the staple cartridge](#)

### For more information

The following information is correct at the time of publication.

For video assistance, see [www.hp.com/videos/LaserJet](http://www.hp.com/videos/LaserJet).

For current information, see [www.hp.com/support/ljE62655mfp](http://www.hp.com/support/ljE62655mfp), [www.hp.com/support/ljE62665mfp](http://www.hp.com/support/ljE62665mfp), or [www.hp.com/support/ljE62675mfp](http://www.hp.com/support/ljE62675mfp).

HP's all-inclusive help for the printer includes the following information:

- Install and configure
- Learn and use
- Solve problems
- Download software and firmware updates
- Join support forums
- Find warranty and regulatory information

# Order supplies, accessories, and parts


## Ordering

Contact the HP-authorized service or support provider.


# Replace the toner cartridge

## Toner-cartridge information

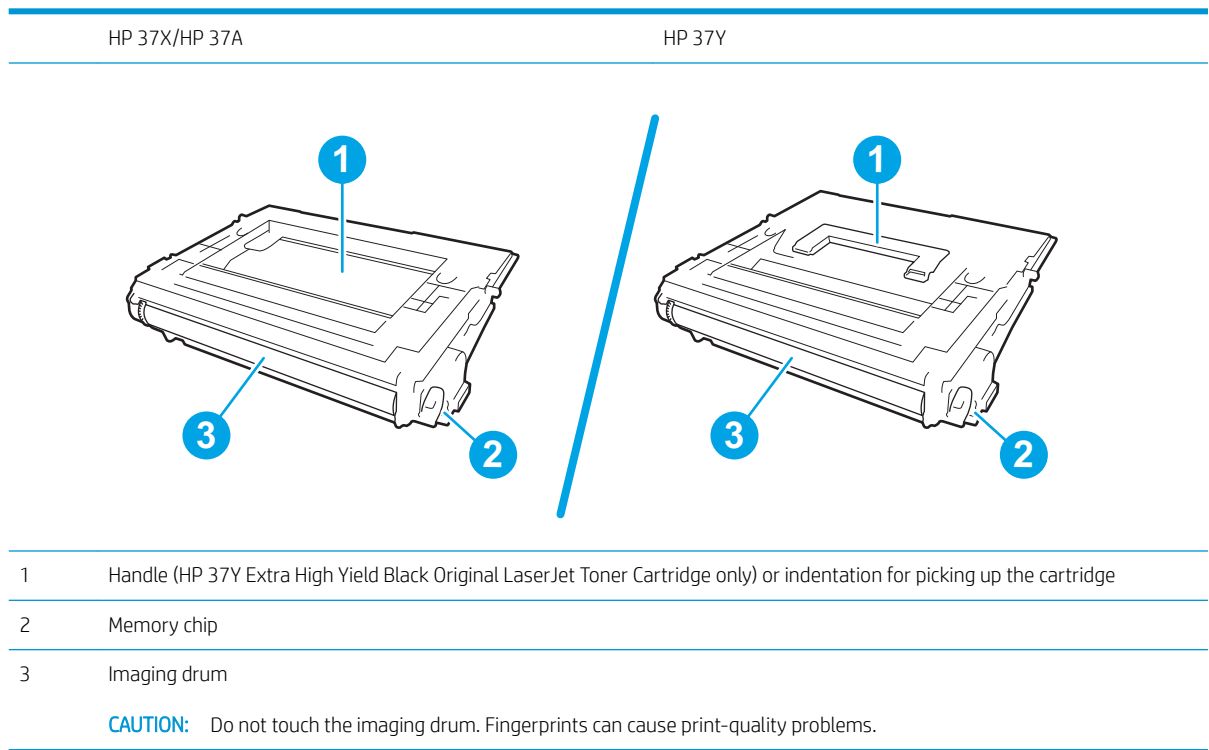
This printer indicates when the toner cartridge level is low. The actual toner cartridge life remaining can vary. The toner cartridge does not need to be replaced at this time. Consider having a replacement cartridge available to install when print quality is no longer acceptable.


 **NOTE:** High-yield toner cartridges contain more toner than standard cartridges for increased page yield. For more information, go to [www.hp.com/go/learnaboutsupplies](http://www.hp.com/go/learnaboutsupplies).


Do not remove the toner cartridge from its package until you are ready to use it.

 **CAUTION:** To prevent damage to the toner cartridge, do not expose it to light for more than a few minutes. Cover the green imaging drum if the toner cartridge must be removed from the printer for an extended period of time.

The following illustration shows the toner-cartridge components.



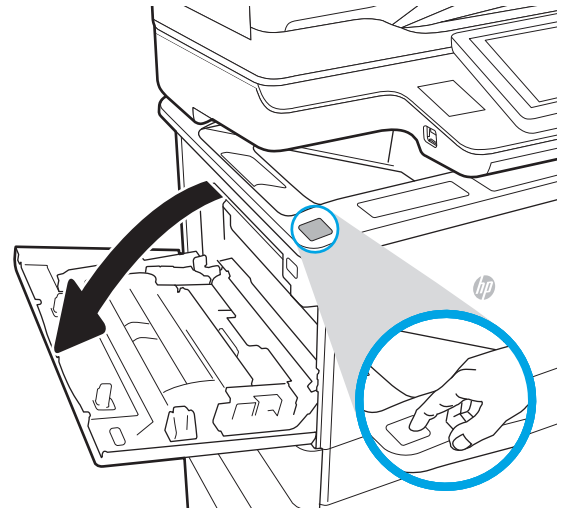
 **CAUTION:** If toner gets on clothing, wipe it off by using a dry cloth and wash the clothes in cold water. Hot water sets toner into fabric.

 **NOTE:** Information about recycling used toner cartridges is on the toner cartridge box.

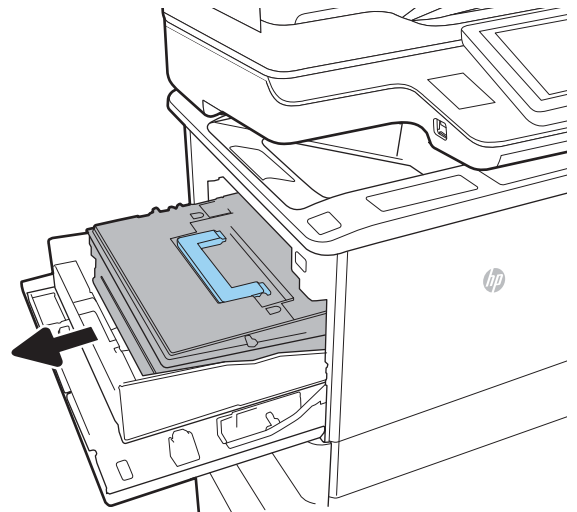
## Remove and replace the cartridge

When a cartridge reaches very low status, a message appears on the control panel, and the front door unlocks to allow access to the cartridge.

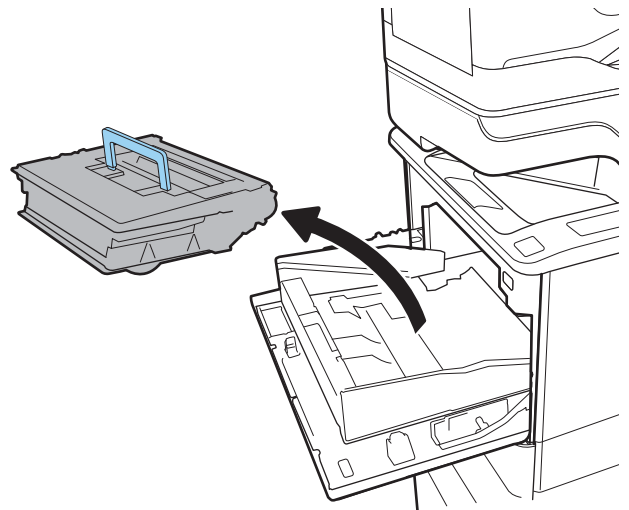
1. Press the cartridge door release button to open the door.



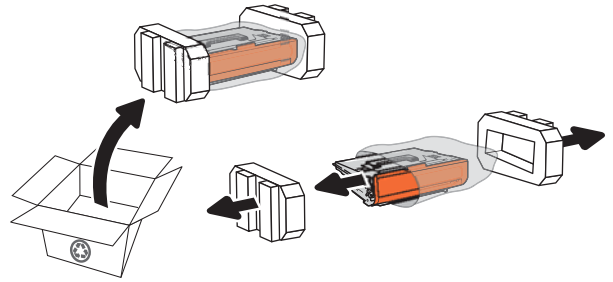
2. Pull out the cartridge drawer.



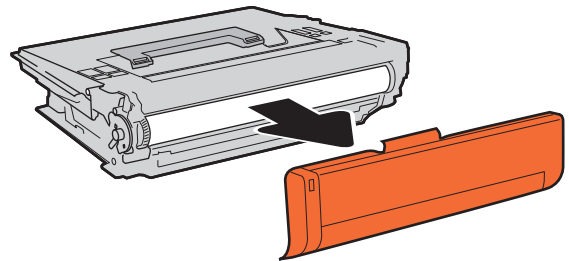
3. Grasp the handle or indentation of the used toner cartridge and pull up to remove it.



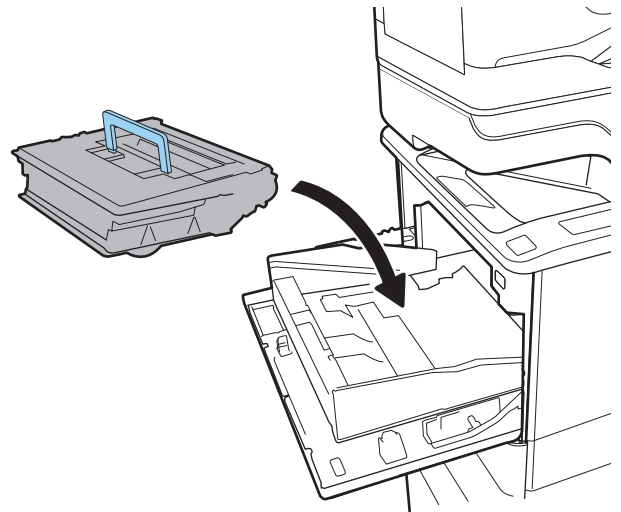
4. Remove the new toner cartridge from its protective bag.



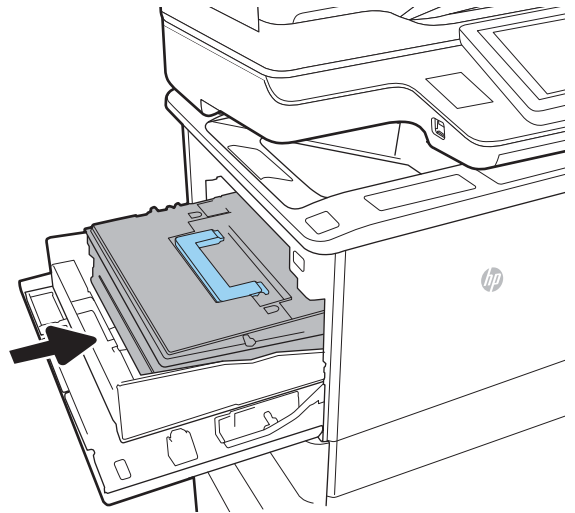
5. Remove the cartridge shipping cover.



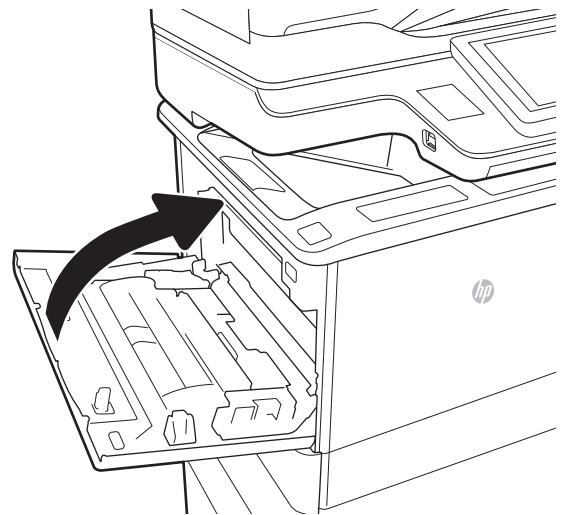
6. Place the toner cartridge in the cartridge drawer.



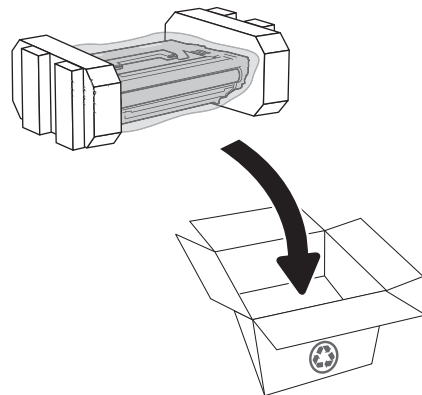
7. Close the toner cartridge drawer.



8. Close the cartridge door.



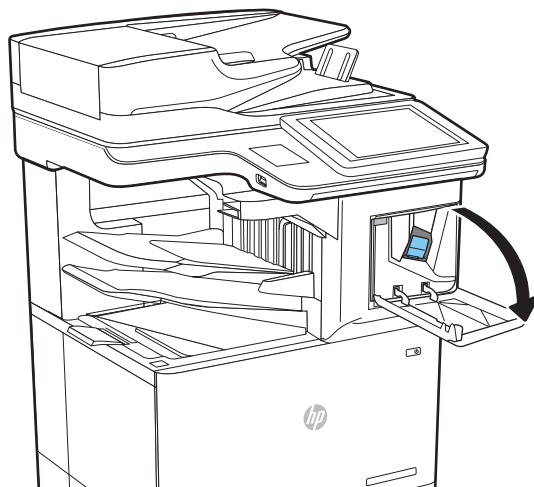
9. Pack the used toner cartridge into the box that the new cartridge came in. Adhere the prepaid shipping label to the box, and return the used cartridge to HP for recycling.



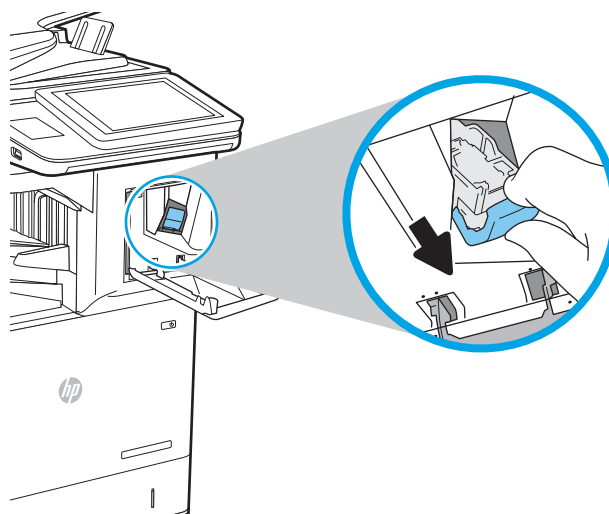


# Replace the staple cartridge

1. Open the stapler door.



2. Pull down the colored handle on the staple carriage, and then pull the staple carriage straight out.

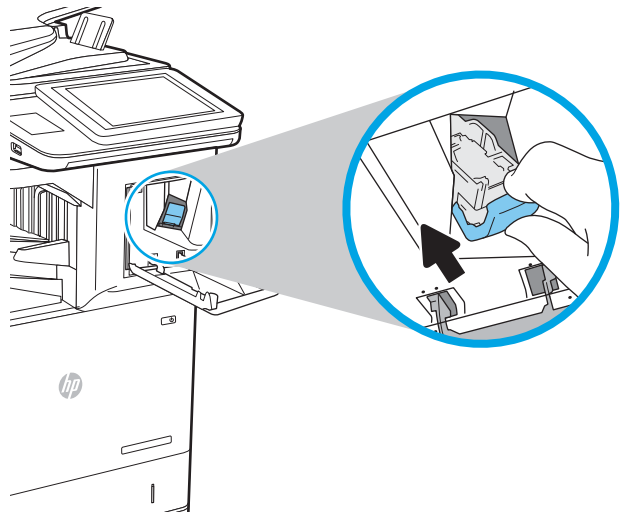


3. Lift up the empty staple cartridge to remove it from the staple carriage.

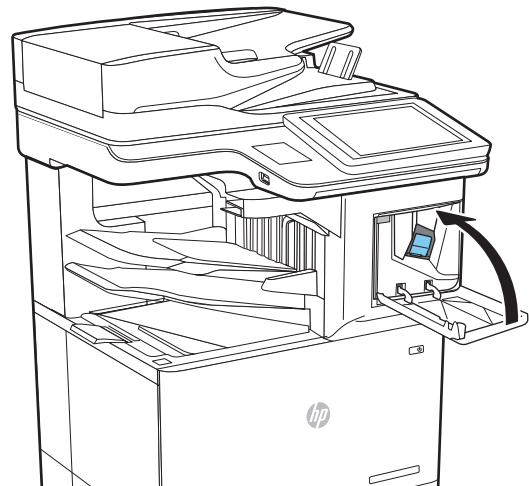
**IMPORTANT:** Do not discard the empty staple cartridge. You will use it to hold the new staple cartridge.

4. Insert the new staple cartridge into the staple carriage.

5. Reinstall the staple carriage into the stapler by pressing the colored handle inward until it snaps into place.



6. Close the stapler door.



---

# 4 Print

- [Print tasks \(Windows\)](#)
- [Print tasks \(macOS\)](#)
- [Store print jobs on the printer to print later or print privately](#)
- [Mobile printing solutions](#)
- [Print from a USB flash drive](#)
- [Print using high-speed USB 2.0 port \(wired\)](#)

## For more information

The following information is correct at the time of publication.

For video assistance, see [www.hp.com/videos/LaserJet](http://www.hp.com/videos/LaserJet).

For current information, see [www.hp.com/support/ljE62655mfp](http://www.hp.com/support/ljE62655mfp), [www.hp.com/support/ljE62665mfp](http://www.hp.com/support/ljE62665mfp), or [www.hp.com/support/ljE62675mfp](http://www.hp.com/support/ljE62675mfp).

HP's all-inclusive help for the printer includes the following information:

- Install and configure
- Learn and use
- Solve problems
- Download software and firmware updates
- Join support forums
- Find warranty and regulatory information

# Print tasks (Windows)


## How to print (Windows)

The following procedure describes the basic printing process for Windows.

1. From the software program, select the **Print** option.
2. Select the printer from the list of printers. To change settings, click the **Properties** or **Preferences** button to open the print driver.

---

 **NOTE:** The name of the button varies for different software programs.

 **NOTE:** In Windows 10, 8.1, and 8, these applications will have a different layout with different features from what is described below for desktop applications. To access the print feature from a Start screen app, complete the following steps:

- **Windows 10:** Select **Print**, and then select the printer.
- **Windows 8.1 or 8:** Select **Devices**, select **Print**, and then select the printer.

---

 **NOTE:** For more information, click the Help (?) button in the print driver.

3. Click the tabs in the print driver to configure the available options. For example, set the paper orientation on the **Finishing** tab, and set the paper source, paper type, paper size, and quality settings on the **Paper/Quality** tab.
4. Click the **OK** button to return to the **Print** dialog box. Select the number of copies to print from this screen.
5. Click the **Print** button to print the job.


## Automatically print on both sides (Windows)

Use this procedure for printers that have an automatic duplexer installed. If the printer does not have an automatic duplexer installed, or to print on paper types that the duplexer does not support, print on both sides manually.

1. From the software program, select the **Print** option.
2. Select the printer from the list of printers, and then click the **Properties** or **Preferences** button to open the print driver.

---

 **NOTE:** The name of the button varies for different software programs.

 **NOTE:** In Windows 10, 8.1, and 8, these applications will have a different layout with different features from what is described below for desktop applications. To access the print feature from a Start screen app, complete the following steps:

- **Windows 10:** Select **Print**, and then select the printer.
- **Windows 8.1 or 8:** Select **Devices**, select **Print**, and then select the printer.

- 
3. Click the **Finishing** tab.
  4. Select **Print on both sides**. Click **OK** to close the **Document Properties** dialog.
  5. In the **Print** dialog, click **Print** to print the job.


## Manually print on both sides (Windows)

Use this procedure for printers that do not have an automatic duplexer installed or to print on paper that the duplexer does not support.

1. From the software program, select the **Print** option.
2. Select the printer from the list of printers, and then click the **Properties** or **Preferences** button to open the print driver.

---

 **NOTE:** The name of the button varies for different software programs.

 **NOTE:** In Windows 10, 8.1, and 8, these applications will have a different layout with different features from what is described below for desktop applications. To access the print feature from a Start screen app, complete the following steps:

- **Windows 10:** Select **Print**, and then select the printer.
  - **Windows 8.1 or 8:** Select **Devices**, select **Print**, and then select the printer.
- 


3. Click the **Finishing** tab.
4. Select **Print on both sides (manually)**, and then click **OK** to close the **Document Properties** dialog.
5. In the **Print** dialog, click **Print** to print the first side of the job.
6. Retrieve the printed stack from the output bin, and place it in Tray 1.
7. If prompted, select the appropriate control panel button to continue.

## Print multiple pages per sheet (Windows)

1. From the software program, select the **Print** option.
2. Select the printer from the list of printers, and then click the **Properties** or **Preferences** button to open the print driver.

---

 **NOTE:** The name of the button varies for different software programs.

 **NOTE:** In Windows 10, 8.1, and 8, these applications will have a different layout with different features from what is described below for desktop applications. To access the print feature from a Start screen app, complete the following steps:

- **Windows 10:** Select **Print**, and then select the printer.
  - **Windows 8.1 or 8:** Select **Devices**, select **Print**, and then select the printer.
- 


3. Click the **Finishing** tab.
4. Select the number of pages per sheet from the **Pages per sheet** drop-down list.
5. Select the correct **Print page borders**, **Page order**, and **Orientation** options. Click **OK** to close the **Document Properties** dialog.
6. In the **Print** dialog, click **Print** to print the job.

## Select the paper type (Windows)

1. From the software program, select the **Print** option.
2. Select the printer from the list of printers, and then click the **Properties** or **Preferences** button to open the print driver.

---

 **NOTE:** The name of the button varies for different software programs.

 **NOTE:** In Windows 10, 8.1, and 8, these applications will have a different layout with different features from what is described below for desktop applications. To access the print feature from a Start screen app, complete the following steps:

- **Windows 10:** Select **Print**, and then select the printer.
  - **Windows 8.1 or 8:** Select **Devices**, select **Print**, and then select the printer.
- 

3. Click the **Paper/Quality** tab.
4. Select the paper type from the **Paper type** drop-down list.
5. Click **OK** to close the **Document Properties** dialog. In the **Print** dialog, click **Print** to print the job.  
If the tray needs to be configured, a tray configuration message displays on the printer control panel.
6. Load the tray with the specified type and size of paper, and then close the tray.
7. Select the **OK** button to accept the detected type and size, or select the **Modify** button to choose a different paper size or type.
8. Select the correct type and size, and then select the **OK** button.

## Additional print tasks

Go to [www.hp.com/support/ljE62655mfp](http://www.hp.com/support/ljE62655mfp), [www.hp.com/support/ljE62665mfp](http://www.hp.com/support/ljE62665mfp), or [www.hp.com/support/ljE62675mfp](http://www.hp.com/support/ljE62675mfp).

Instructions are available for performing specific print tasks, such as the following:

- Create and use printing shortcuts or presets
- Select the paper size, or use a custom paper size
- Select the page orientation
- Create a booklet
- Scale a document to fit a specific paper size
- Print the first or last pages of the document on different paper
- Print watermarks on a document

# Print tasks (macOS)

## How to print (macOS)

The following procedure describes the basic printing process for macOS.

1. Click the **File** menu, and then click the **Print** option.
2. Select the printer.
3. Click **Show Details** or **Copies & Pages**, and then select other menus to adjust the print settings.

---

 **NOTE:** The name of the item varies for different software programs.


---

4. Click the **Print** button.

## Automatically print on both sides (macOS)

---

 **NOTE:** This information applies to printers that include an automatic duplexer.

 **NOTE:** This feature is available if you install the HP print driver. It might not be available if you are using AirPrint.

---

1. Click the **File** menu, and then click the **Print** option.
2. Select the printer.
3. Click **Show Details** or **Copies & Pages**, and then click the **Layout** menu.

---

 **NOTE:** The name of the item varies for different software programs.

---

4. Select a binding option from the **Two-Sided** drop-down list.
5. Click the **Print** button.

## Manually print on both sides (macOS)


---

 **NOTE:** This feature is available if you install the HP print driver. It might not be available if you are using AirPrint.

---

1. Click the **File** menu, and then click the **Print** option.
2. Select the printer.
3. Click **Show Details** or **Copies & Pages**, and then click the **Manual Duplex** menu.

---

 **NOTE:** The name of the item varies for different software programs.

---

4. Click the **Manual Duplex** box, and select a binding option.
5. Click the **Print** button.
6. Go to the printer, and remove any blank paper that is in Tray 1.
7. Retrieve the printed stack from the output bin and place it with the printed side facing down in the input tray.
8. If prompted, select the appropriate control panel button to continue.



## Print multiple pages per sheet (macOS)

1. Click the **File** menu, and then click the **Print** option.
2. Select the printer.
3. Click **Show Details** or **Copies & Pages**, and then click the **Layout** menu.

---

 **NOTE:** The name of the item varies for different software programs.

---

4. From the **Pages per Sheet** drop-down list, select the number of pages that you want to print on each sheet.
5. In the **Layout Direction** area, select the order and placement of the pages on the sheet.
6. From the **Borders** menu, select the type of border to print around each page on the sheet.
7. Click the **Print** button.

## Select the paper type (macOS)

1. Click the **File** menu, and then click the **Print** option.
2. Select the printer.
3. Click **Show Details** or **Copies & Pages**, and then click the **Media & Quality** menu or the **Paper/Quality** menu.

---

 **NOTE:** The name of the item varies for different software programs.

---

4. Select from the **Media & Quality** or **Paper/Quality** options.

---

 **NOTE:** This list contains the master set of options available. Some options are not available on all printers.

---

- **Media Type:** Select the option for the type of paper for the print job.
  - **Print Quality:** Select the resolution level for the print job.
  - **Edge-To-Edge Printing:** Select this option to print close to the paper edges.
5. Click the **Print** button.

## Additional print tasks

Go to [www.hp.com/support/ljE62655mfp](http://www.hp.com/support/ljE62655mfp), [www.hp.com/support/ljE62665mfp](http://www.hp.com/support/ljE62665mfp), or [www.hp.com/support/ljE62675mfp](http://www.hp.com/support/ljE62675mfp).

Instructions are available for performing specific print tasks, such as the following:

- Create and use printing shortcuts or presets
- Select the paper size, or use a custom paper size
- Select the page orientation
- Create a booklet
- Scale a document to fit a specific paper size

- Print the first or last pages of the document on different paper
- Print watermarks on a document

# Store print jobs on the printer to print later or print privately

## Introduction

The following information provides procedures for creating and printing documents that are stored on the printer. These jobs can be printed at a later time or printed privately.

- [Create a stored job \(Windows\)](#)
- [Create a stored job \(macOS\)](#)
- [Print a stored job](#)
- [Delete a stored job](#)
- [Information sent to printer for Job Accounting purposes](#)


## Create a stored job (Windows)

Store jobs on the printer for private or delayed printing.

1. From the software program, select the **Print** option.
2. Select the printer from the list of printers, and then select **Properties** or **Preferences** (the name varies for different software programs).

---

 **NOTE:** The name of the button varies for different software programs.

 **NOTE:** In Windows 10, 8.1, and 8, these applications will have a different layout with different features from what is described below for desktop applications. To access the print feature from a Start screen app, complete the following steps:

- **Windows 10:** Select **Print**, and then select the printer.
  - **Windows 8.1 or 8:** Select **Devices**, select **Print**, and then select the printer.
- 
3. Click the **Job Storage** tab.
  4. Select a **Job Storage Mode** option.
    - **Proof and Hold:** Print and proof one copy of a job, and then print more copies.
    - **Personal Job:** The job does not print until you request it at the printer control panel. For this job-storage mode, you can select one of the **Make Job Private/Secure** options. If you assign a personal identification number (PIN) to the job, you must provide the required PIN at the control panel. If you encrypt the job, you must provide the required password at the control panel. The print job is deleted from memory after it prints and is lost if the printer loses power.
    - **Quick Copy:** Print the requested number of copies of a job and store a copy of the job in the printer memory so you can print it again later.
    - **Stored Job:** Store a job on the printer and allow other users to print the job at any time. For this job-storage mode, you can select one of the **Make Job Private/Secure** options. If you assign a personal identification number (PIN) to the job, the person who prints the job must provide the required PIN at the control panel. If you encrypt the job, the person who prints the job must provide the required password at the control panel.

5. To use a custom user name or job name, click the **Custom** button, and then enter the user name or the job name.

Select which option to use if another stored job already has that name:

- **Use Job Name + (1-99):** Append a unique number to the end of the job name.
  - **Replace Existing File:** Overwrite the existing stored job with the new one.
6. Click the **OK** button to close the **Document Properties** dialog box. In the **Print** dialog box, click the **Print** button to print the job.

## Create a stored job (macOS)

Store jobs on the printer for private or delayed printing.


1. Click the **File** menu, and then click the **Print** option.
2. In the **Printer** menu, select the printer.
3. By default, the print driver displays the **Copies & Pages** menu. Open the menus drop-down list, and then click the **Job Storage** menu.
4. In the **Mode** drop-down list, select the type of stored job.
  - **Proof and Hold:** Print and proof one copy of a job, and then print more copies.
  - **Personal Job:** The job does not print until someone requests it at the printer control panel. If the job has a personal identification number (PIN), provide the required PIN at the control panel. The print job is deleted from memory after it prints and is lost if the printer loses power.
  - **Quick Copy:** Print the requested number of copies of a job and store a copy of the job in the printer memory to print it again later.
  - **Stored Job:** Store a job on the printer and allow other users to print the job at any time. If the job has a personal identification number (PIN), the person who prints the job must provide the required PIN at the control panel.
5. To use a custom user name or job name, click the **Custom** button, and then enter the user name or the job name.

Select which option to use if another stored job already has that name.

- **Use Job Name + (1-99):** Append a unique number to the end of the job name.
  - **Replace Existing File:** Overwrite the existing stored job with the new one.
6. If you selected the **Stored Job** or **Personal Job** option in step 4, you can protect the job with a PIN. Type a 4-digit number in the **Use PIN to Print** field. When other people attempt to print this job, the printer prompts them to enter this PIN number.
  7. Click the **Print** button to process the job.

## Print a stored job

Use this procedure to print a document that is in a job storage folder on the printer.

1. From the Home screen on the printer control panel, select **Print**, and then select **Print from Job Storage**.
2. Under **Stored Jobs to Print**, select **Choose**, and then select the folder where the document is saved.
3. Select the document, and then touch **Select**.  
If the document is private, enter the four-digit PIN in the **Password** field, and then select **OK**.
4. To adjust the number of copies, select the box to the left of the **Print** button, and then select the number of copies from the keypad that opens. Select the Close  button to close the keypad.
5. Select **Print** to print the document.


## Delete a stored job

You can delete documents that have been saved to the printer when they are no longer needed. You can also adjust the maximum number of jobs for the printer to store.

- [Delete a job that is stored on the printer](#)
- [Change the job storage limit](#)

### Delete a job that is stored on the printer

Follow these steps to delete a job that is stored in the printer memory.

1. From the Home screen on the printer control panel, select **Print**, and then select **Print from Job Storage**.
2. Select **Choose**, and then select the name of the folder where the job is stored.
3. Select the name of the job.
4. Select the Trash  button to delete the job.  
If the job is private or encrypted, enter the PIN or password, and then select **OK**.
5. Select **Delete Jobs** on the confirmation prompt.

### Change the job storage limit

When a new job is stored in the printer memory, the printer overwrites any previous jobs with the same user and job name. If a job is not already stored under the same user and job name, and the printer needs additional space, the printer might delete other stored jobs starting with the oldest. Follow these steps to change the number of jobs that the printer can store:

1. From the Home screen on the printer control panel, navigate to the **Settings** application, and then select the **Settings** icon.
2. Open the following menus:
  - a. **Copy/Print** or **Print**
  - b. **Manage Stored Jobs**
  - c. **Temporary Job Storage Limit**

3. Use the keypad to enter the number of jobs that the printer stores.
4. Select **Done** to save the setting.

## Information sent to printer for Job Accounting purposes

Printing jobs sent from drivers on the client (e.g., PC) may send personally identifiable information to HP's Printing and Imaging devices. This information may include, but is not limited to, user name and client name from which the job originated that may be used for job accounting purposes, as determined by the Administrator of the printing device. This same information may also be stored with the job on the mass storage device (e.g., disk drive) of the printing device when using the job storage feature.

# Mobile printing solutions

## Introduction

HP offers multiple mobile printing solutions to enable easy printing to an HP printer from a laptop, tablet, smartphone, or other mobile device. To see the full list and to determine the best choice, go to [www.hp.com/go/MobilePrinting](http://www.hp.com/go/MobilePrinting).



**NOTE:** Update the printer firmware to ensure all mobile printing and ePrint capabilities are supported.

- [Wi-Fi Direct \(wireless models only, with HP Jetdirect 3100w BLE/NFC/Wireless accessory installed\)](#)
- [HP ePrint via email](#)
- [AirPrint](#)
- [Android embedded printing](#)

## Wi-Fi Direct (wireless models only, with HP Jetdirect 3100w BLE/NFC/Wireless accessory installed)

HP provides Wi-Fi, Wi-Fi Direct Print, Near Field Communication (NFC), and Bluetooth Low Energy (BLE) printing for printers with a supported HP Jetdirect 3100w BLE/NFC/Wireless Accessory. This accessory is available as an option for HP LaserJet printers that include a hardware-integration pocket (HIP).

Wi-Fi, Wi-Fi Direct Print, NFC, and BLE printing enable Wi-Fi capable (mobile) devices to make a wireless network connection directly to the printer without using a wireless router.

The printer does not need to be connected to the network for this mobile walk-up printing to work.

Use Wi-Fi Direct Print to print wirelessly from the following devices or services:




- iPhone, iPad, or iPod touch using Apple AirPrint or the HP Smart app
- Android mobile devices using the Android embedded print solution or the HP Smart app
- PC and Mac devices using HP ePrint via email (requires HP Web Services to be enabled and the printer to be registered with HP Connected)
- HP Roam
- Google Cloud Print

For more information on wireless printing, go to [www.hp.com/go/wirelessprinting](http://www.hp.com/go/wirelessprinting).

NFC and Wi-Fi Direct Print capabilities can be enabled or disabled from the printer control panel.

1. From the Home screen on the printer control panel, navigate to the **Settings** application, and then select the **Settings** icon.
2. Open the following menus:
  - a. **Networking**
  - b. **Wi-Fi Direct**
  - c. **Status**
3. Select **On**, and then select **OK** to enable wireless printing.



**NOTE:** In environments where more than one model of the same printer is installed, it might be helpful to provide each printer a unique Wi-Fi Direct Name for easier printer identification for Wi-Fi Direct printing. The wireless network names, e.g., Wi-Fi, Wi-Fi Direct, etc. are available on the Information screen by pressing or touching the Information  button on the printer control panel, and then selecting the Network  option or the Wireless  option.

Complete the following procedure to change the printer Wi-Fi Direct name:

1. From the Home screen on the printer control panel, navigate to the [Settings](#) application, and then select the [Settings](#) icon.
2. Open the following menus:
  - a. [Networking](#)
  - b. [Wi-Fi Direct](#)
  - c. [Wi-Fi Direct name](#)
3. Use the keypad to change the name in the [Wi-Fi Direct Name](#) text field. Select [OK](#).



## HP ePrint via email

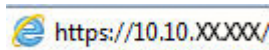
Use HP ePrint to print documents by sending them as an email attachment to the printer's email address from any email enabled device.

To use HP ePrint, the printer must meet these requirements:

- The printer must be connected to a wired or wireless network and have Internet access.
- HP Web Services must be enabled on the printer, and the printer must be registered with HP Connected.

Follow this procedure to enable HP Web Services and register with HP Connected:

1. Open the HP Embedded Web Server (EWS):
  - a. Find the printer IP address. On the printer control panel, press the  button, and then use the arrow keys to select the Ethernet  menu. Press the [OK](#) button to open the menu and display the IP address or host name.
  - b. From a computer on the same network as the printer, open a web browser. In the address line, type the IP address or host name exactly as it displays on the printer control panel. Press the [Enter](#) key on the computer keyboard. The EWS opens.



**NOTE:** If the web browser displays a message indicating that accessing the website might not be safe, select the option to continue to the website. Accessing this website will not harm the computer.

2. Click the **HP Web Services** tab.
3. Select the option to enable Web Services.



**NOTE:** Enabling Web Services might take several minutes.

4. Go to [www.hpconnected.com](http://www.hpconnected.com) to create an HP ePrint account and complete the setup process.




## AirPrint

Direct printing using Apple's AirPrint is supported for iOS and from Mac computers running macOS 10.7 Lion and newer. Use AirPrint to print directly to the printer from an iPad, iPhone (3GS or later), or iPod touch (third generation or later) in the following mobile applications:

- Mail
- Photos
- Safari
- iBooks
- Select third-party applications

To use AirPrint, the printer must be connected to the same network (sub-net) as the Apple device. For more information about using AirPrint and about which HP printers are compatible with AirPrint, go to [www.hp.com/go/MobilePrinting](http://www.hp.com/go/MobilePrinting).

---

 **NOTE:** Before using AirPrint with a USB connection, verify the version number. AirPrint versions 1.3 and earlier do not support USB connections.


---

## Android embedded printing

HP's built-in print solution for Android and Kindle enables mobile devices to automatically find and print to HP printers that are either on a network or within wireless range for Wi-Fi Direct printing.

The print solution is built into the many versions of the operating system.

---

 **NOTE:** If printing is not available on your device, go to the [Google Play > Android apps](#) and install the HP Print Service Plugin.

---

For more information on how to use Android embedded printing and which Android devices are supported, go to [www.hp.com/go/MobilePrinting](http://www.hp.com/go/MobilePrinting).

# Print from a USB flash drive

## Introduction

This printer features easy-access USB printing, for quickly printing files without sending them from a computer. The printer accepts standard USB flash drives in the USB port near the control panel. The control panel USB port supports the following types of files:

- .pdf
- .prn
- .pcl
- .ps
- .cht
- [Enable the USB port for printing](#)
- [Print USB documents](#)



## Enable the USB port for printing


The USB port is disabled by default. Before using this feature, enable the USB port. Use one of the following methods to enable the port:


### Method one: Enable the USB port from the printer control panel menus

1. From the Home screen on the printer control panel, navigate to the [Settings](#) application, and then select the [Settings](#) icon.
2. Open the following menus
  - a. [Copy/Print](#) or [Print](#)
  - b. [Enable Print From USB Drive](#)
3. Select the [Enabled](#) option.

### Method two: Enable the USB port from the HP Embedded Web Server (network-connected printers only)

1. Find the printer IP address: From the Home screen on the printer control panel, select the Information  icon, and then select the Network  icon to display the IP address or host name.
2. Open a web browser, and in the address line, type the IP address exactly as it displays on the printer control panel. Press the [Enter](#) key on the computer keyboard. The EWS opens.

 <https://10.10.XX.XXX/>

 **NOTE:** If the web browser displays a **There is a problem with this website's security certificate** message when attempting to open the EWS, click **Continue to this website (not recommended)**.

Choosing **Continue to this website (not recommended)** will not harm the computer while navigating within the EWS for the HP printer.

3. Select the **Copy/Print** tab for multi-function printer models, or the **Print** tab for single-function printer models.
4. In the left menu, select **Print from USB Drive Settings**.
5. Select **Enable Print from USB Drive**.
6. Click **Apply**.

## Print USB documents

1. Insert the USB flash drive into the easy-access USB port.



---

**NOTE:** The port might be covered. For some printers, the cover flips open. For other printers, pull the cover straight out to remove it.

---

2. From the Home screen on the printer control panel, select **Print**, and then select **Print from USB Drive**.
3. Select **Choose**, select the name of the document to print, and then select **Select**.



---

**NOTE:** The document might be in a folder. Open folders as necessary.

---

4. To adjust the number of copies, select the field for the number of copies. Use the keypad to enter the number of copies to print.
5. Select **Print** to print the document.

# Print using high-speed USB 2.0 port (wired)



## Enable the high-speed USB port for printing

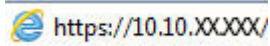
This printer features a high-speed USB 2.0 port for wired USB printing. The port is located in the interface ports area on the back of the printer and is disabled by default. Use one of the following methods to enable the port. Once the port is enabled, install the product software in order to print using this port.


### Method one: Enable the high-speed USB 2.0 port from the printer control panel menus

1. From the Home screen on the printer control panel, navigate to the [Settings](#) application, and then select the [Settings](#) icon.
2. Open the following menus
  - a. [General](#)
  - b. [Enable Device USB](#)
3. Select the [Enabled](#) option.

### Method two: Enable the high-speed USB 2.0 port from the HP Embedded Web Server (network-connected printers only)

1. Find the printer IP address: From the Home screen on the printer control panel, select the Information  icon, and then select the Network  icon to display the IP address or host name.
2. Open a web browser, and in the address line, type the IP address exactly as it displays on the printer control panel. Press the [Enter](#) key on the computer keyboard. The EWS opens.



 **NOTE:** If the web browser displays a **There is a problem with this website's security certificate** message when attempting to open the EWS, click **Continue to this website (not recommended)**.

Choosing **Continue to this website (not recommended)** will not harm the computer while navigating within the EWS for the HP printer.

3. Select the **Security** tab.
4. On the left side of the screen, select **General Security**.
5. Scroll down to the **Hardware Ports** and select the check box to enable both of the items:
  - **Enable Device USB**
  - **Enable Host USB plug and play**
6. Click **Apply**.

---

# 5 Copy

- [Make a copy](#)
- [Copy on both sides \(duplex\)](#)
- [Additional options when copying](#)
- [Additional copy tasks](#)

## For more information

The following information is correct at the time of publication.

For video assistance, see [www.hp.com/videos/LaserJet](http://www.hp.com/videos/LaserJet).

For current information, see [www.hp.com/support/ljE62655mfp](http://www.hp.com/support/ljE62655mfp), [www.hp.com/support/ljE62665mfp](http://www.hp.com/support/ljE62665mfp), or [www.hp.com/support/ljE62675mfp](http://www.hp.com/support/ljE62675mfp).


HP's all-inclusive help for the printer includes the following information:

- Install and configure
- Learn and use
- Solve problems
- Download software and firmware updates
- Join support forums
- Find warranty and regulatory information

## Make a copy



Follow these steps to make a copy from the scanner glass or the document feeder.

1. Place the document face-down on the scanner glass, or place it face-up in the document feeder and adjust the paper guides to fit the size of the document.
2. From the Home screen on the printer control panel, select **Copy**.
3. Select settings from the **Sides** menu and the **Color/Black** menu (color printers), and then select **Done**.
4. If you are using a Quick Set, select **Load** under **Quick Sets and Defaults**. Select the Quick Set from the list, and then select **Load** in the lower right corner.

 **NOTE:** **Quick Sets** are predefined copy settings for various types of output, such as **Text**, **Photograph**, and **High Quality**.

5. To adjust settings, such as **Reduce/Enlarge** and **Content Orientation**, select **Options** in the lower left corner, and then select the settings from the **Options** menus. Select **Done** if prompted.
6. Optional Preview: Touch the right pane of the screen to preview the document. You can use the **Expand** and **Collapse** buttons on the left side of the preview pane to expand and collapse the preview screen.

**Table 5-1** Preview pane controls

Expand button	Collapse button
	

Use the buttons on the right of the screen to adjust the preview options and to rearrange, rotate, insert, or remove pages.

**Table 5-2** Preview buttons













Button	Description
	Toggle between the two-page view and the thumbnail view. More options are available in the thumbnail view than in the two-page view.
	
	Zoom in or out on the selected page. <b>NOTE:</b> Select only one page at a time to use these buttons.
	

Table 5-2 Preview buttons (continued)



Button	Description
	Rotate the page 180 degrees. <b>NOTE:</b> This button is available only in the thumbnail view.
	Delete the selected pages. <b>NOTE:</b> This button is available only in the thumbnail view.
	Rearrange the pages within the document. Select one or more pages and move them to the left or right. <b>NOTE:</b> These buttons are available only in the thumbnail view.
	
	Add a page to the document. The printer prompts you to scan additional pages.
	Clear the changes made in the preview and start over.

7. To adjust the number of copies, touch the box to the left of the **Copy** button, and then select the number of copies from the keypad that opens. Select the Close  button to close the keypad.
8. When the document is ready, select **Copy** to begin copying.

## Copy on both sides (duplex)

1. Place the document face-down on the scanner glass, or place it face-up in the document feeder and adjust the paper guides to fit the size of the document.
  2. From the Home screen on the printer control panel, select [Copy](#).
  3. Select the arrow under [Sides](#) to view available options.
  4. In the [Original Sides](#) section, select the option that describes the original document:
    - Use [1-sided](#) for originals that are printed on one side of the page.
    - Use [2-sided](#) for originals that are printed on both sides of the page.
    - Enable or disable [Pages Flip Up](#) to determine on which edge of the page a 2-sided original flips.
  5. In the [Output Sides](#) section, select one of these options:
    - [Match original](#): The output will match the format of the original. For example, if the original is 1-sided, the output will be 1-sided. However, if the administrator has restricted 1-sided printing and the original is 1-sided, the output will be 2-sided book-style.
- 
-  **NOTE:** This feature is not available for all firmware versions. You might need to update the printer firmware to use this feature.
- 
- [1-sided](#): The output will be 1-sided. However, if the administrator has restricted 1-sided printing, the output will be 2-sided book-style.
  - [2-sided](#): The output will be 2-sided.
  - Enable or disable [Pages Flip Up](#) to determine on which edge of the page the 2-sided output flips.
6. Select [Done](#).
  7. Adjust any other settings as needed. Select [Done](#) for each setting if prompted.
  8. Optional Preview: Touch the right pane of the screen to preview the document. You can use the [Expand](#) and [Collapse](#) buttons on the left side of the preview pane to expand and collapse the preview screen.

**Table 5-3** Preview pane controls


Expand button	Collapse button
	

Use the buttons on the right of the screen to adjust the preview options and to rearrange, rotate, insert, or remove pages.



Table 5-4 Preview buttons

Button	Description
	Toggle between the two-page view and the thumbnail view. More options are available in the thumbnail view than in the two-page view.
	
	Zoom in or out on the selected page. <b>NOTE:</b> Select only one page at a time to use these buttons.
	
	Rotate the page 180 degrees. <b>NOTE:</b> This button is available only in the thumbnail view.
	Delete the selected pages. <b>NOTE:</b> This button is available only in the thumbnail view.
	Rearrange the pages within the document. Select one or more pages and move them to the left or right. <b>NOTE:</b> These buttons are available only in the thumbnail view.
	
	Add a page to the document. The printer prompts you to scan additional pages.
	Clear the changes made in the preview and start over.

- To adjust the number of copies, touch the box to the left of the **Copy** button, and then select the number of copies from the keypad that opens. Select the Close  button to close the keypad.
- When the document is ready, select **Copy** to begin copying.

# Additional options when copying

The following settings are available in the [Options](#) list when copying.



**NOTE:** The following list contains the master set of options available for HP Enterprise MFP printers. Some options are not available on all printers.

**Table 5-5 Copy options**

Option	Description
Number of Copies	Specify the number of copies to make.
Load and Save Settings	<p><b>Load Quick Set:</b> Load copy settings from a saved Quick Set.</p> <p><b>NOTE:</b> Use the HP Embedded Web Server to create and save Quick Sets.</p> <p><b>Save Defaults:</b> Save the current settings in the Options list as default settings for future copy jobs.</p>
Sides	Specify whether the original document is printed on one side or both sides, and whether the copies are to be printed on one side or both sides.
Color/Black	Specify whether copies are to be printed in color, black and gray, or black only.
For color printers only.	
Staple	Specify the placement of staples.
For printers with automatic finishing accessories only. This feature does not apply to printers with convenience staplers.)	
Scan Mode	<p><b>Standard Document:</b> Scan a page or stack of pages through the document feeder, or individually on the flatbed glass.</p> <p><b>Book Mode:</b> Scan an open book and output each page of the book onto different pages.</p> <p><b>2-sided ID Copy:</b> Scan each side of an identification card on the flatbed glass and output them onto one page. After scanning the first side, the printer prompts to place the second side in the correct position on the glass.</p>
Reduce/Enlarge	Scale the size of the scanned document up or down.
Original Size	Specify the paper size for the original document.
Paper Selection	Specify the paper size and type for the copies.
Booklet	Format and rearrange original scanned images into pages that print as a booklet.
Content Orientation	Specify whether the original document is printed in Portrait or Landscape orientation.
Pages per Sheet	Copy multiple sheets of paper onto a single sheet. Select one, two, or four pages per sheet.
Output Bin	Specify which output bin to use for the job when the printer output bins are configured for mailbox mode.
For printers with multiple output bins only.	<p><b>NOTE:</b> This option does not appear when the output bins are configured for stacker mode or function-separator mode.</p>

**Table 5-5 Copy options (continued)**

Option	Description
Paper Path	Select a specific paper path:
For printers that have an option to flip pages inside the paper path.	<p><b>Face-up (straightest path):</b> Pages output to the bin in the opposite order that they were placed in the document feeder.</p> <p><b>Face-down (correct order):</b> Pages are stacked in the same order as they were placed in the document feeder.</p>
Image Adjustment	<p><b>Sharpness:</b> Clarify or soften the image. For example, increasing the sharpness could make text appear crisper, but decreasing it could make photos appear smoother.</p> <p><b>Darkness:</b> Increase or decrease the amount of white and black used in colors in scanned images.</p> <p><b>Contrast:</b> Increase or decrease the difference between the lightest and the darkest color on the page.</p> <p><b>Background Cleanup:</b> Remove faint colors from the background of scanned images. For example, if the original document is printed on colored paper, use this feature to lighten the background without affecting the darkness of the image.</p> <p><b>Automatic Tone:</b> Available for Flow printers only. The printer automatically adjusts the <b>Darkness</b>, <b>Contrast</b>, and <b>Background Cleanup</b> settings to the most appropriate for the scanned document.</p>
Optimize Text/Picture	Optimize the job for the type of image being scanned: text, graphics, or photos.
Edge-to-Edge	Scan and print a copy closer to the edge of the page than is normally allowed. Printing close to the edge can result in some print-quality issues.
Erase Edges	Remove blemishes, such as dark borders or staple marks, by cleaning the edges of the scanned image.
Collate	Assemble each set of pages in the same order as the original document when making multiple copies of a document.
Automatically Straighten	Automatically straighten a scanned image.
<b>NOTE:</b> Available on Flow models only.	<p>This feature is not available for all firmware versions. You might need to update the printer firmware to use this feature.</p>
Blank Page Suppression	Exclude blank pages in the original document from scanned images. This feature is useful for scanning pages printed on both sides to eliminate blank pages in the resulting scanned document.
<b>NOTE:</b> This feature is not available for all firmware versions. You might need to update the printer firmware to use this feature.	
Multi-feed Detection	Enable or disable multi-feed detection. When enabled, scanning stops when the printer detects more than one page at a time being fed in the document feeder. When disabled, scanning continues when a multi-feed is detected, to allow scanning pages that are stuck together, originals with self-adhesive notes on them, or thick paper.

## Additional copy tasks

Go to [www.hp.com/support/ljE62655mfp](http://www.hp.com/support/ljE62655mfp), [www.hp.com/support/ljE62665mfp](http://www.hp.com/support/ljE62665mfp), or [www.hp.com/support/ljE62675mfp](http://www.hp.com/support/ljE62675mfp).

Instructions are available for performing specific copy tasks, such as the following:

- Copy or scan pages from books or other bound documents
- Copy mixed-size documents
- Copy or scan both sides of an identification card
- Copy or scan a document into a booklet format

---

# 6 Scan

- [Set up Scan to Email](#)
- [Set up Scan to Network Folder](#)
- [Set up Scan to SharePoint® \(Flow models only\)](#)
- [Set up Scan to USB Drive](#)
- [Scan to email](#)
- [Scan to job storage](#)
- [Scan to network folder](#)
- [Scan to SharePoint](#)
- [Scan to USB drive](#)
- [Additional options when scanning](#)
- [HP JetAdvantage business solutions](#)
- [Additional scan tasks](#)

## For more information

The following information is correct at the time of publication.

For video assistance, see [www.hp.com/videos/LaserJet](http://www.hp.com/videos/LaserJet).

For current information, see [www.hp.com/support/ljE62655mfp](http://www.hp.com/support/ljE62655mfp), [www.hp.com/support/ljE62665mfp](http://www.hp.com/support/ljE62665mfp), or [www.hp.com/support/ljE62675mfp](http://www.hp.com/support/ljE62675mfp).

HP's all-inclusive help for the printer includes the following information:

- Install and configure
- Learn and use
- Solve problems
- Download software and firmware updates
- Join support forums
- Find warranty and regulatory information

# Set up Scan to Email

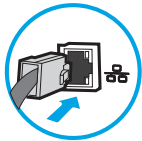
- [Introduction](#)
- [Before you begin](#)
- [Step one: Access the HP Embedded Web Server \(EWS\)](#)
- [Step two: Configure the Network Identification settings](#)
- [Step three: Configure the Scan to Email feature](#)
- [Step four: Configure the Quick Sets \(optional\)](#)
- [Step five: Set up Scan to Email to use Office 365 Outlook \(optional\)](#)

## Introduction

The printer has a feature that enables it to scan a document and send it to one or more email addresses. To use this scan feature, the printer must be connected to a network; however, the feature is not available until it has been configured. There are two methods for configuring Scan to Email, the **Scan to Email Setup Wizard** for basic and **Email Setup** for advanced. Use the following information to set up the Scan to Email feature.

## Before you begin


To set up the Scan to Email feature, the printer must have an active network connection.



Administrators need the following information before beginning the configuration process.

- Administrative access to the printer
- DNS suffix (e.g., companyname.com)
- SMTP server (e.g., smtp.mycompany.com)


---

 **NOTE:** If you do not know the SMTP server name, SMTP port number, or authentication information, contact the email/Internet service provider or system administrator for the information. SMTP server names and port names are typically found by doing an Internet search. For example, use terms like "Gmail smtp server name" or "Yahoo smtp server name" to search.

---



- SMTP server authentication requirements for outgoing email messages, including the user name and password used for authentication, if applicable.

---

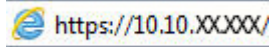
 **NOTE:** Consult your email service provider's documentation for information on digital sending limits for your email account. Some providers may temporarily lock your account if you exceed your sending limit.

---

## Step one: Access the HP Embedded Web Server (EWS)


1. From the Home screen on the printer control panel, touch the Information  icon, and then touch the Network  icon to display the IP address or host name.

2. Open a web browser, and in the address line, type the IP address or host name exactly as it displays on the printer control panel. Press the **Enter** key on the computer keyboard. The EWS opens.




 **NOTE:** If the web browser displays a message indicating that accessing the website might not be safe, select the option to continue to the website. Accessing this website will not harm the computer.

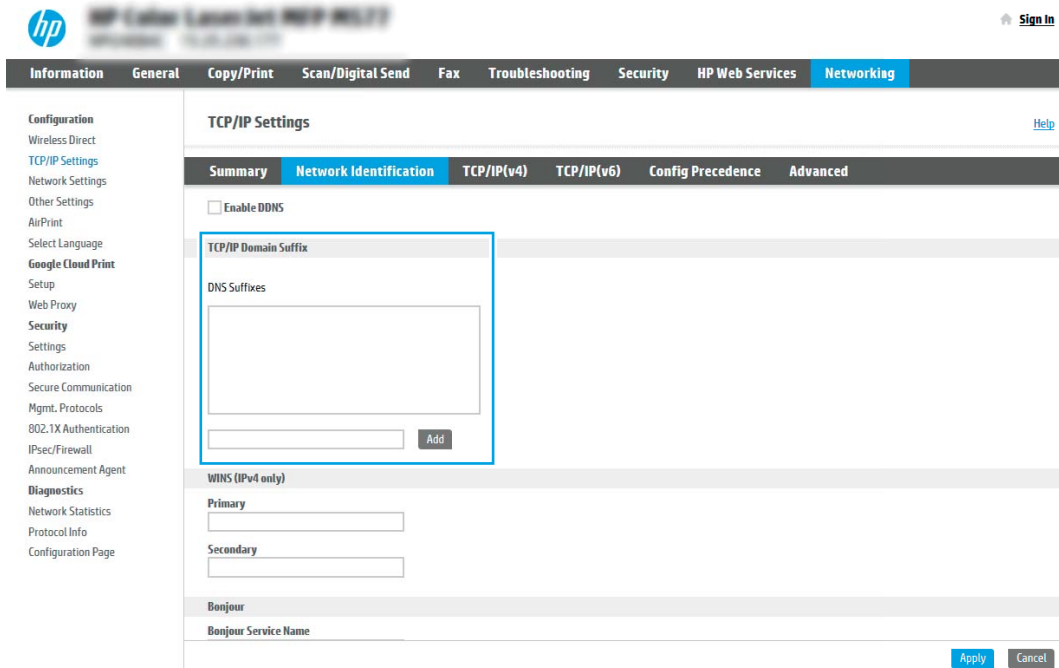
## Step two: Configure the Network Identification settings

 **NOTE:** Configuring email setup on the **Networking** tab is an advanced process and might require the assistance of a system administrator.

1. Using the EWS top navigation tabs, click **Networking**.

 **NOTE:** For configuring the network settings for use with Office 365, see "Step five: Set up Scan to Email to use Office 365 Outlook (optional)."

2. In the left navigation pane, click **TCP/IP Settings**. A username/password might be required to access the **Network Identification** tab of the EWS.
3. On the **TCP/IP Settings** dialog, click the **Network Identification** tab.
4. If DNS is required on the network, in the **TCP/IP Domain Suffix** area, verify that the DNS suffix for the email client being used is listed. DNS suffixes have this format: *companyname.com*, *gmail.com*, etc.



 **NOTE:** If the Domain Name suffix is not set up, use the IP address.

5. Click **Apply**.
6. Click **OK**.

## Step three: Configure the Scan to Email feature


The two options for configuring Scan to Email are the **Email Setup Wizard** for basic configuration and **Email Setup** for advanced configuration. Use the following options to configure the Scan to Email feature:

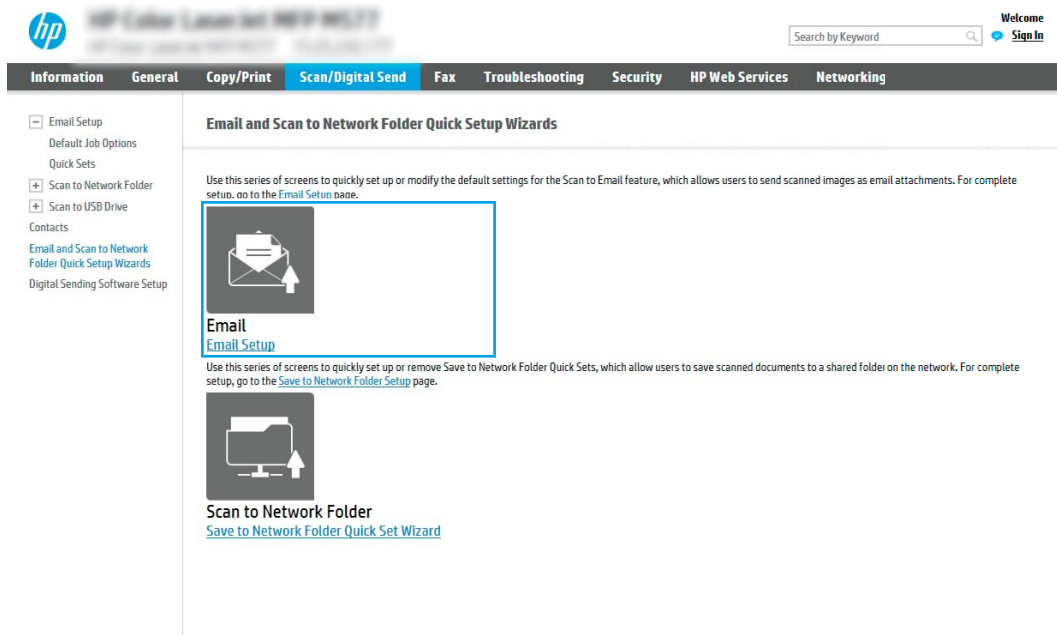
- [Method one: Basic configuration using the Email Setup Wizard](#)
- [Method two: Advanced configuration using the Email Setup](#)

### Method one: Basic configuration using the Email Setup Wizard

This option opens the **Email Setup Wizard** in the HP Embedded Web Server (EWS) for basic configuration.

1. Using the EWS top navigation tabs, click **Scan/Digital Send**.
2. In the left-navigation pane, click **Email and Scan to Network Folder Quick Setup Wizards**.
3. In the **Email and Scan to Network Folder Quick Setup Wizards** dialog, click the **Email Setup** link.

 **NOTE:** If a message displays indicating that the Scan to Email feature is disabled, click **Continue** to proceed with the configuration and enable the Scan to Email feature upon completion.



4. On the **Configure Email Servers (SMTP)** dialog, select one of the following options and complete the steps:

#### Option one: Use a server already in use by another function

- ▲ Select **Use a server already in use by another function**, and then click **Next**.



### Option two: Search network for outgoing email server



**NOTE:** This option finds outgoing SMTP servers inside your firewall only.

- a. Select **Search the network for outgoing email servers**, and then click **Next**.
- b. Select the appropriate server from the **Configure Email Server (SMTP)** list, and then click **Next**.
- c. Select the option that describes the server's authentication requirements:
  - **Server does not require authentication:** Select **Server does not require authentication**, and then click **Next**.
  - OR–
  - **Server requires authentication:** From the drop-down list, select an authentication option:
    - **Use credentials of user to connect after Sign In at the control panel:** Select **Use credentials of user to connect after Sign In at the control panel**, and then click **Next**.
    - OR–
    - **Always use these credentials:** Select **Always use these credentials**, enter the **User name** and **Password**, and then click **Next**.

### Option three: Add SMTP server

- a. Select **Add SMTP server**
- b. Enter the **Server Name** and **Port Number**, and then click **Next**.



**NOTE:** In most cases, the default port number does not need to be changed.



**NOTE:** If you are using a hosted SMTP service such as Gmail, verify the SMTP address, port number, and SSL settings from the service provider's website or other sources. Typically, for Gmail, the SMTP address is smtp.gmail.com, port number 465, and the SSL should be enabled.

Please refer to online sources to confirm these server settings are current and valid at the time of configuration.

- c. Select the appropriate server authentication option:
    - **Server does not require authentication:** Select **Server does not require authentication**, and then click **Next**.
    - OR–
    - **Server requires authentication:** Select an option from the **Server requires authentication** drop-down list:
      - **Use credentials of user to connect after Sign In at the control panel:** Select **Use credentials of user to connect after Sign In at the control panel**, and then click **Next**.
      - OR–
      - **Always use these credentials:** Select **Always use these credentials**, enter the **User name** and **Password**, and then click **Next**.
5. On the **Configure Email Settings** dialog, enter the following information about for the sender's email address, and then click **Next**.



**NOTE:** When setting up the **From**, **Subject**, and **Message** fields, if the **User editable** check box is unchecked, users will not be able to edit those fields at the printer control panel when sending an email.

Option	Description
<b>From</b> (Required)	Select one of the following options from the <b>From</b> drop-down list: <ul style="list-style-type: none"> <li>• <b>User's address (sign-in required)</b></li> <li>• <b>Default From:</b> Enter a default email address and display name in the <b>Default From Email Address</b> and <b>Default Display Name</b> fields</li> </ul> <p><b>NOTE:</b> Create an email account for the printer, and use this address for the default email address.</p> <p><b>NOTE:</b> Configure the email feature so that users must sign in before using it. This prevents users from sending an email from an address that is not their own.</p>
<b>Subject</b> (Optional)	Provide a default subject line for the email messages.
<b>Message</b> (Optional)	Create a custom message.  To use this message for all emails sent from the printer, clear the <b>User editable</b> check box for <b>Message</b> .

6. In the **Configure File Scan Settings** area, set the default scanning preferences, and then click **Next**.

Option	Description
<b>File Type</b>	Select the default file type that the for the scanned document: <ul style="list-style-type: none"> <li>• PDF</li> <li>• JPEG</li> <li>• TIFF</li> <li>• MTIFF</li> <li>• XPS</li> <li>• PDF/A</li> </ul>
<b>Color/Black</b>	Select the default color setting for the scanned document: <ul style="list-style-type: none"> <li>• Color</li> <li>• Black</li> <li>• Black/Gray</li> <li>• Automatically detect</li> </ul>

Option	Description
Quality and File Size	Select the default output quality for the scanned document: <ul style="list-style-type: none"> <li>• Low (small file)</li> <li>• Medium</li> <li>• High (large file)</li> </ul>
Resolution	Select the default scan resolution for the scanned document: <ul style="list-style-type: none"> <li>• 75 dpi</li> <li>• 150 dpi</li> <li>• 200 dpi</li> <li>• 300 dpi</li> <li>• 400 dpi</li> <li>• 600 dpi</li> </ul>

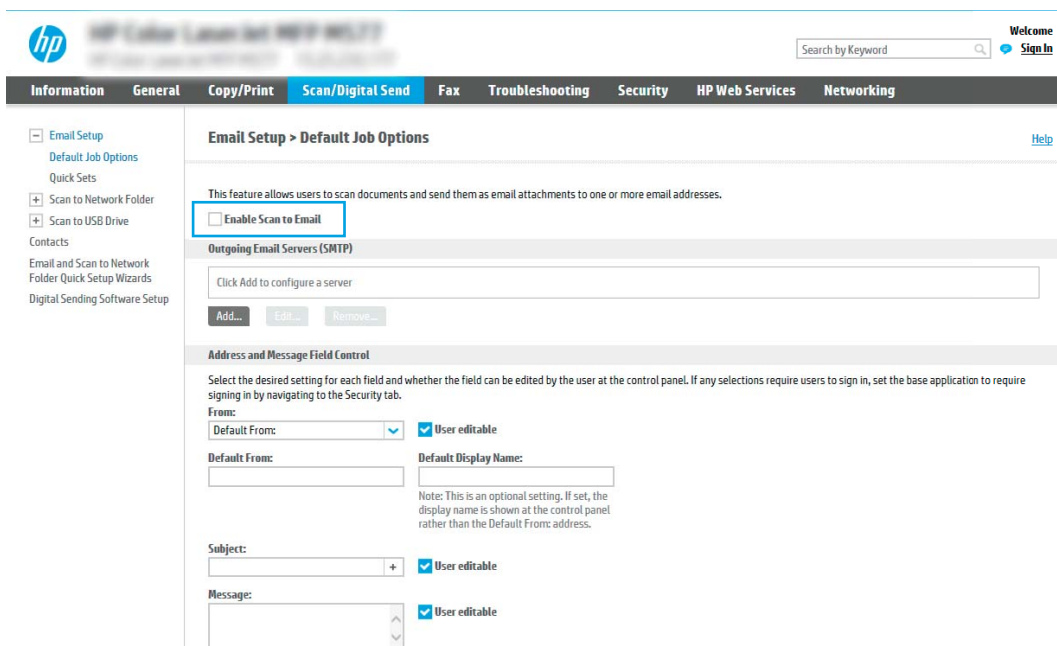
- Review the **Summary** area, and then click **Finish** to complete the setup.

## Method two: Advanced configuration using the Email Setup

- Using the EWS top navigation tabs, click **Scan/Digital Send**, and then click **Email Setup** in the left navigation pane.

 **NOTE:** By default, the Email Setup page displays the basic settings for Scan to Email setup. To access additional settings, click the **Advanced Settings** button at the bottom of the page.

- On the **Email Setup** dialog, select the **Enable Scan to Email** check box. If this check box is not selected, the feature is unavailable at the printer control panel.



The screenshot shows the HP Email Setup web interface. The top navigation bar includes tabs for Information, General, Copy/Print, Scan/Digital Send, Fax, Troubleshooting, Security, HP Web Services, and Networking. The left navigation pane shows 'Email Setup' expanded with sub-items like 'Default Job Options' and 'Quick Sets'. The main content area is titled 'Email Setup > Default Job Options'. A red box highlights the 'Enable Scan to Email' checkbox, which is currently unchecked. Below this, there is a section for 'Outgoing Email Servers (SMTP)' with a text input field and 'Add...', 'Edit...', and 'Remove...' buttons. Further down is the 'Address and Message Field Control' section, which includes settings for 'From:', 'Default From:', 'Default Display Name:', 'Subject:', and 'Message:', each with a dropdown or text input and a 'User editable' checkbox.


- In the **Outgoing Email Servers (SMTP)** area, complete the steps for one of the following options:

- Select one of the displayed servers
- Click **Add** to start the SMTP wizard.

1. In the SMTP wizard, select one of the following options:

- **Option one: I know my SMTP server address or host name:** Enter the address of an SMTP server, and then click **Next**
- **Option two:** If you do not know the address of the SMTP server, select **Search network for outgoing email server**, and then click **Next**. Select the server, and then click **Next**.


---


 **NOTE:** If an SMTP server was already created for another printer function, the **Use a server already in use by another function** option displays. Select this option, and then configure it to be used for the email function.


---

2. On the **Set the basic information necessary to connect to the server** dialog, set the options to use, and then click **Next**.

---

 **NOTE:** Some servers have problems sending or receiving emails that are larger than 5 megabytes (MB). These problems can be prevented by entering a number in **Split emails if larger than (MB)**.

 **NOTE:** In most cases, the default port number does not need to be changed. However, when using the Enable SMTP SSL Protocol option, port 587 must be used.

 **NOTE:** If you are using Google™ Gmail for email service, select the **Enable SMTP SSL Protocol** check box. Typically, for gmail, the SMTP address is smtp.gmail.com, port number 465, and the SSL should be enabled.


Please refer to online sources to confirm these server settings are current and valid at the time of configuration.

---

3. On the **Server Authentication Requirements** dialog, select the option that describes the server's authentication requirements:

- **Server does not require authentication**, and then click **Next**.
- **Server requires authentication**
  - From the drop-down box, select **Use credentials of user to connect after Sign In at the control panel**, and then click **Next**.
  - From the drop-down box, select **Always use these credentials**, enter the **Username** and **Password**, and then click **Next**.


---

 **NOTE:** If using a signed-in user's credentials, set email to require sign in by the user on the printer control panel. Deny device guest access to email by clearing the check box for email in the **Device Guest** column in the **Sign in and Permission Policies** area on the **Access Control** dialog of the **Security** tab. The icon in the check box changes from a check mark to a lock.

---

4. On the **Server Usage** dialog, choose the printer functions that will send email through this SMTP server, and then click the **Next** button.

---

 **NOTE:** If the server requires authentication, a user name and password for sending automatic alerts and reports from the printer will be required.

---


5. On the **Summary and Test** dialog, enter a valid email address in the **Send test email to:** field, and then click **Test**.
  6. Verify that all of the settings are correct, and then click **Finish** to complete the outgoing email server set up.
4. In the **Address and Message Field Control** area, enter a **From:** setting and any of the other optional settings.

**Address and Message Field Control settings:**

Feature	Description
<b>Address Field Restrictions</b> <sup>1</sup>	<p>Specify whether users must select an email address from an address book or whether users are allowed to enter in an email address manually.</p> <p><b>CAUTION:</b> If <b>Users must select from address book</b> is selected, and any of the address fields are also set as <b>User editable</b>, changes to those editable fields also change the corresponding values in the address book.</p> <p>To prevent users from changing contacts in the Address Book at the printer control panel, go to the <b>Access Control</b> page on the <b>Security</b> tab, and deny <b>Device Guest</b> access to address book modifications.</p>
<b>Allow invalid email address formats</b>	Select to allow an invalid email address format.
<b>User editable</b>	<p>To use the <b>Default From</b> address and <b>Default Display Name</b> for all emails sent from this printer (unless a user is signed in), do not select the <b>User editable</b> check box.</p> <p>When setting up the address fields, if the <b>User editable</b> check box is unchecked, users will not be able to edit those fields at the printer control panel when sending an email. For send-to-me functionality, clear the <b>User editable</b> check boxes for all of the address fields, including the <b>From:</b>, <b>To:</b>, <b>CC:</b>, and <b>BCC:</b> fields, and then set that user's send email <b>From:</b> their own email address and <b>To:</b> their own email address.</p>
<b>Default From:</b> and <b>Default Display Name:</b>	<p>Provide an email address and name to use for the <b>From:</b> address for the email message.</p> <p><b>NOTE:</b> Create an email account for the printer, and use this address for the default email address.</p> <p><b>NOTE:</b> Configure the email feature so that users must sign in before using it. This prevents users from sending an email from an address that is not their own.</p>
<b>To:</b> <sup>1</sup>	Provide a To (recipient) email address for emails.
<b>CC:</b> <sup>1</sup>	Provide a CC email address for emails.
<b>BCC:</b> <sup>1</sup>	Provide a BCC email address for emails.
<b>Subject:</b>	Provide a default subject line for the email messages.
<b>Message:</b>	Create a custom message. To use this message for all emails sent from the printer, clear or do not select the <b>User editable</b> check box for <b>Message:</b> .

<sup>1</sup> This setting is available only on the Advanced Settings page.

5. In the **Signing and Encryption** area, set the signing and encryption preferences.

 **NOTE:** These settings are available only on the Advanced Settings page.

**Signing and Encryption settings:**

Feature	Description
Signing	Select whether to sign the security certificate. Select the <b>User editable</b> check box to make this setting editable at the printer control panel.
Hashing Algorithm	Select the algorithm to use for signing the certificate.
Encryption	Select whether to encrypt the email. Select the <b>User editable</b> check box to make this setting editable at the printer control panel.
Encryption Algorithm	Select the algorithm to use for encrypting the email.
Attribute for Recipient Public Key	Enter which attribute to use to retrieve the recipient's public key certificate from LDAP.
Use the recipient public key certificate to verify the recipient	Select this setting to use the recipient's public key certificate to verify the recipient.

- In the **Notification** area, select when users will receive notifications about sent emails. The default setting is using the signed in user's email address. If the recipient email address is blank, no notification is sent.
- In the **Scan Settings** area, set the default scanning preferences.

 **NOTE:** These settings are available only on the Advanced Settings page.

#### Scan settings:

Feature	Description
Original Size	Select the page size of the original document.
Original Sides	Select whether the original document is single-sided or double-sided.
Optimize Text/Picture	Select to optimize for the output of a particular type of content.
Content Orientation	Select the way the content of the original document is placed on the page: <b>Portrait</b> or <b>Landscape</b> .
Background Cleanup	Select a value to remove faint images from the background or to remove a light background color.
Darkness	Select a value to adjust the darkness of the file.
Contrast	Select a value to adjust the contrast of the file.
Sharpness	Select a value to adjust the sharpness of the file.
Image Preview	Select whether to require or make optional a displayed preview of the job or to disable a preview.
Cropping Options	Select whether or not to allow a job to be cropped and the type of cropping option.
Erase Edges	Select this setting to specify the width of edge margins to be erased, in either inches or millimeters, for the front side and back side of a job.

- In the **File Settings** area, set the default file settings preferences.

#### File settings:

Feature	Description
File Name Prefix <sup>1</sup>	Set the default file name prefix used for files saved to a network folder.

Feature	Description
<b>File Name</b>	Default file name for the file to be saved.  Select the <b>User editable</b> check box to make this setting editable at the printer control panel.
<b>File Name Suffix<sup>1</sup></b>	Set the default file name suffix used for files saved to a network folder.  Duplicate filename suffix default [filename]_YYYYMMDDT
<b>File Name Preview<sup>1</sup></b>	Enter a file name, and then click the <b>Update Preview</b> button.
<b>File Numbering Format<sup>1</sup></b>	Select a file name format for when the job is divided into multiple files.
<b>Add numbering when job has just one file (ex. _1-1)<sup>1</sup></b>	Select this setting to add numbering to a file name when the job is only one file instead of multiple files.
<b>File Type</b>	Select the file format for the saved file.  Select the <b>User editable</b> check box to make this setting editable at the printer control panel.
<b>High Compression (smaller file)<sup>1</sup></b>	Select this setting to compress the scanned file, which reduces the file size. However, the scanning process for a High compression file might take longer than for a Normal compression file.
<b>PDF encryption<sup>1</sup></b>	If the file type is PDF, then this option encrypts the output PDF file. A password must be specified as part of the encryption. The same password must be used to open the file. The user will be prompted to enter a password prior to scanning their job if one has not been set prior to pressing start.
<b>Resolution</b>	Set the resolution for the file. Higher resolution images have more dots per inch (dpi), so they show more detail. Lower resolution images have fewer dots per inch and show less detail, but the file size is smaller.
<b>Quality and File Size</b>	Select the quality for the file. Higher-quality images require a larger file size than lower-quality images, and they take more time to send.
<b>Color/Black</b>	Specify whether copies are to be printed in color, black and gray, or black only.
<b>Suppress blank pages<sup>1</sup></b>	If the <b>Suppress blank pages</b> option is enabled, blank pages will be ignored.
<b>Create Multiple Files<sup>1</sup></b>	Select this setting to scan pages into separate files based on a predetermined maximum number of pages per file.

<sup>1</sup> This setting is available only on the Advanced Settings page.

- Review the selected options to verify that they are accurate, and then click **Apply** to complete the setup.

## Step four: Configure the Quick Sets (optional)

Quick Sets are optional short-cut jobs that can be accessed on the main Home screen or within the Quick Sets application at the printer.

- In the **Email Setup** area of the left navigation pane, click **Quick Sets**.
- Select one of the following options:
  - Select an existing Quick Set under Quick Sets Application in the table.
  - OR-
  - Click **Add** to start the Quick Set Wizard.
- If you selected **Add**, the **Quick Sets Setup** page opens. Complete the following information:

- **Quick Set Name:** Enter a title for the new Quick Set.
  - **Quick Set Description:** Enter a description of the Quick Set.
  - **Quick Set Start Option:** To set how the Quick Set starts, click either **Enter application, then user presses Start** or **Start instantly when selected from the Home Screen**.
4. Define the following settings for the Quick Set: Address and Message Field Control, Signing and Encryption, Notification, Scan Settings, File Settings.
  5. Click **Finish** to save the Quick Set.

## Step five: Set up Scan to Email to use Office 365 Outlook (optional)

### Introduction

Microsoft Office 365 Outlook is a cloud-based email system provided by Microsoft which uses Microsoft's Simple Mail Transfer Protocol (SMTP) server to send or receive emails. Complete the following to enable the printer to send an email with an Office 365 Outlook account from the control panel.



**NOTE:** You must have an email address account with Office 365 Outlook to configure the settings in the EWS.

### Configure the outgoing email server (SMTP) to send an email from an Office 365 Outlook account

1. Using the EWS top navigation tabs, click **Networking**.
2. In the left navigation pane, click **TCP/IP Settings**.
3. In the **TCP/IP Settings** area, click the **Network Identification** tab.
4. If DNS is required on the network, in the **TCP/IP Domain Suffix** area, verify that the DNS suffix for the email client being used is listed. DNS suffixes have this format: *companyname.com*, Gmail.com, etc.

The screenshot shows the HP EWS interface for TCP/IP Settings. The 'Networking' tab is selected in the top navigation. In the left-hand navigation pane, 'TCP/IP Settings' is selected. The main content area shows the 'TCP/IP Settings' page with the 'Network Identification' sub-tab active. A blue box highlights the 'TCP/IP Domain Suffix' section, which includes a 'DNS Suffixes' list and an 'Add' button. Below this are sections for 'WINS (IPv4 only)' with 'Primary' and 'Secondary' input fields, and 'Bonjour' with a 'Bonjour Service Name' input field. 'Apply' and 'Cancel' buttons are at the bottom right.




**NOTE:** If the Domain Name suffix is not set up, use the IP address.



5. Click **Apply**.
6. Click the **Scan/Digital Send** tab.
7. On the left navigation pane, click **Email Setup**.
8. On the **Email Setup** page, select the **Enable Scan to Email** check box. If this check box is not available, the feature is unavailable at the printer control panel.

The screenshot shows the HP printer control panel interface. At the top, there's a navigation bar with tabs: Information, General, Copy/Print, Scan/Digital Send (selected), Fax, Troubleshooting, Security, HP Web Services, and Networking. On the left, a navigation pane shows 'Email Setup' expanded with sub-items: Default Job Options (selected), Quick Sets, Scan to Network Folder, Scan to USB Drive, Contacts, Email and Scan to Network Folder Quick Setup Wizards, and Digital Sending Software Setup. The main content area is titled 'Email Setup > Default Job Options'. It contains a section for 'Enable Scan to Email' with a checkbox that is highlighted by a red box. Below this is the 'Outgoing Email Servers (SMTP)' section, which includes a text input field with the placeholder 'Click Add to configure a server' and buttons for 'Add...', 'Edit...', and 'Remove...'. The 'Address and Message Field Control' section allows users to select settings for 'From:', 'Subject:', and 'Message:' fields, each with a 'User editable' checkbox checked.

9. In the **Outgoing Email Servers (SMTP)** area, click **Add** to start the SMTP wizard.
10. In the **I know my SMTP server address or host name** field, type [sntp.onoffice.com](mailto:sntp.onoffice.com), and then click **Next**.
11. On the **Set the basic information necessary to connect to the server** dialog, in the **Port Number** field, type **587**.

 **NOTE:** Some servers have problems sending or receiving emails that are larger than 5 megabytes (MB). These problems can be prevented by entering a number in **Split emails if larger than (MB)**.

12. Select the **Enable SMTP SSL Protocol** check box, and then click **Next**.
13. On the **Server Authentication Requirements** dialog, complete the following information:
  - a. Select **Server requires authentication**.
  - b. From the drop-down list, select **Always use these credentials**
  - c. In the **Username** field, type the Office 365 Outlook email address.
  - d. In the **Password** field, type the Office 365 Outlook account password, and then click **Next**.
14. On the **Server Usage** dialog, choose the printer functions that will send email through this SMTP server, and then click the **Next** button.

15. On the **Summary and Test** dialog, enter a valid email address in the **Send test email to:** field, and then click **Test**.
16. Verify that all of the settings are correct, and then click **Finish** to complete the outgoing email server set up.

# Set up Scan to Network Folder

- [Introduction](#)
- [Before you begin](#)
- [Step one: Access the HP Embedded Web Server](#)
- [Step two: Set up Scan to Network Folder](#)

## Introduction

This document explains how to enable and configure the Scan to Network Folder function. The printer has a feature that enables it to scan a document and save it to a network folder. To use this scan feature, the printer must be connected to a network; however, the feature is not available until it has been configured. There are two methods for configuring Scan to Network Folder, the **Save to Network Folder Setup Wizard** for basic setup and **Save to Network Folder Setup** for advanced setup.

## Before you begin

---


 **NOTE:** To set up the Scan to Network Folder feature, the printer must have an active network connection.

---

Administrators need the following items before beginning the configuration process.



- Administrative access to the printer
- The fully-qualified domain name (FQDN) (e.g., \\servername.us.companyname.net\scans) of the destination folder OR the IP address of the server (e.g., \\16.88.20.20\scans).

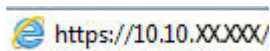
---

 **NOTE:** The use of the term "server" in this context refers to the computer where the shared folder resides.

---

## Step one: Access the HP Embedded Web Server

1. From the Home screen on the printer control panel, touch the Information  icon, and then touch the Network  icon to display the IP address or host name.
2. Open a web browser, and in the address line, type the IP address or host name exactly as it displays on the printer control panel. Press the **Enter** key on the computer keyboard. The EWS opens.



---

 **NOTE:** If the web browser displays a message indicating that accessing the website might not be safe, select the option to continue to the website. Accessing this website will not harm the computer.

---

## Step two: Set up Scan to Network Folder

### Method one: Use the Scan to Network Folder Wizard


This option opens the setup wizard that is in the HP Embedded Web Server (EWS) for the printer. The setup wizard includes the options for basic configuration.

1. Using the EWS top navigation tabs, click **Scan/Digital Send** tab.
2. In the left-navigation pane, click **Email and Scan to Network Folder Quick Setup Wizards**.
3. Click the **Save to Network Folder Quick Set Wizard** link.

4. On the **Add or Remove a Save to Network Folder Quick Set** dialog, click **Add**.

---

 **NOTE:** Quick Sets are short-cut jobs that can be accessed on the printer Home screen or within the Quick Sets application.


 **NOTE:** The Save to Network Folder feature can be minimally configured without creating a quick set. However, without the quick set, users must enter the destination folder information at the control panel for each scan job. A quick set is required to include Save to Network Folder metadata.

---

5. On the **Add Folder Quick Set** dialog, complete the following information:

- a. In the **Quick Set Title** field, type a title.

---

 **NOTE:** Name the Quick Set something that users can understand quickly (e.g., "Scan and save to a folder").

---


- b. In the **Quick Set Description** field, type a description explaining what the Quick Set will save.
- c. Click **Next**.

6. On the **Configure Destination Folder** dialog, complete the following information:

- a. In the **UNC Folder Path** field, type a folder path where the scan will go.

The folder path can either be the fully-qualified domain name (FQDN) (e.g., \servername.us.companyname.net\scans) or the IP address of the server (e.g., \\16.88.20.20\scans). Be sure that the folder path (e.g., \scans) follows the FQDN or IP address.

---


 **NOTE:** The FQDN can be more reliable than the IP address. If the server gets its IP address via DHCP, the IP address can change. However, the connection with an IP address might be faster because the printer does not need to use DNS to find the destination server.

---

- b. From the **Authentication Settings** drop-down, select one of the following options:

- Use credentials of user to connect after Sign In at the control panel
- Always use these credentials

---

 **NOTE:** If **Always use these credentials** is selected, a user name and password must be entered in the corresponding fields, and the printer's access to the folder must be verified by clicking **Verify Access**.

---

- c. In the **Windows Domain** field, type the Windows domain.

---

 **TIP:** To find the Windows domain in Windows 7, click **Start**, click **Control Panel**, and then click **System**.

To find the Windows domain in Windows 8, click **Search**, enter **System** in the search box, and then click **System**.

The domain is listed under **Computer name, domain, and workgroup settings**.

---

- d. Click **Next**.

7. On the **Configure File Scan Settings** dialog, set the default scanning preferences for the Quick Set, and then click **Next**.

8. Review the **Summary** dialog, and then click **Finish**.

## Method two: Use Scan to Network Folder Setup

This option enables advanced configuration of the Save to Network Folder feature using the HP Embedded Web Server (EWS) for the printer.

### Step one: Begin the configuration


1. Click the **Scan/Digital Send** tab.
2. On the left navigation menu, click the **Scan to Network Folder Setup** link.

### Step two: Configure the Scan to Network Folder settings

1. On the **Scan to Network Folder Setup** page, select the **Enable Scan to Network Folder** check box. If this box is not selected, the feature is unavailable at the printer control panel.
2. In the Scan to Network Folder area of the left navigation pane, click **Quick Sets**. Click **Add** to open the **Quick Sets Setup** dialog.

---

 **NOTE:** Quick Sets are short-cut jobs that can be accessed on the printer Home screen or within the Quick Sets application.

 **NOTE:** The **Scan to Network Folder** feature can be minimally configured without creating a quick set. However, without the quick set, users must enter the destination folder information at the control panel for each scan job. A quick set is required to include Scan to Network Folder metadata.

---


Complete all of the settings in the Quick Set Setup to fully configure the Scan to Network Folder feature.

### Dialog one: Set the Quick Set name, description, and options for user interaction at the control panel

Use the **Set the button location for the Quick Set and options for user interaction at the control panel** dialog to configure where the **Quick Set** button will display on the printer control panel and to configure the level of user interaction at the printer control panel.

1. In the **Quick Set Name** field, type a title.

---

 **NOTE:** Name the Quick Set something that users can understand quickly (e.g., "Scan and save to a folder").

---


2. In the **Quick Set Description** field, type a description explaining what the Quick Set will save.
3. From the **Quick Set Start Option** list, select one of the following options:

- Option one: **Enter application, then user presses Start**
- Option two: **Start instantly upon selection**

Select one of the following prompt options :

- **Prompt for original sides**
- **Prompt for additional pages**
- **Require Preview**

---

 **NOTE:** If **Start instantly upon selection** is selected, the destination folder must be entered in the next step.

---

4. Click **Next**.

## Dialog two: Folder Settings

Use the **Folder Settings** dialog to configure the types of folders the printer sends scanned documents to.

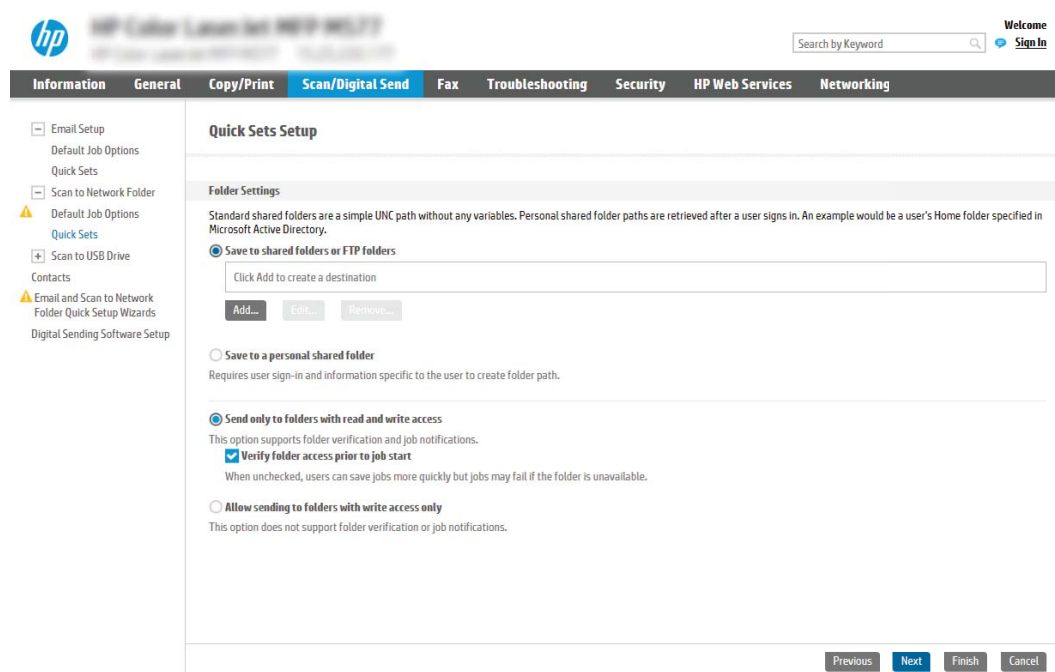
There are two types of destination folders to select from:

- Shared folders or FTP folders
- Personal shared folders

There are two types of folder permissions to select from:

- Read and write access
- Write access only

The following information describes how to configure the folder settings.



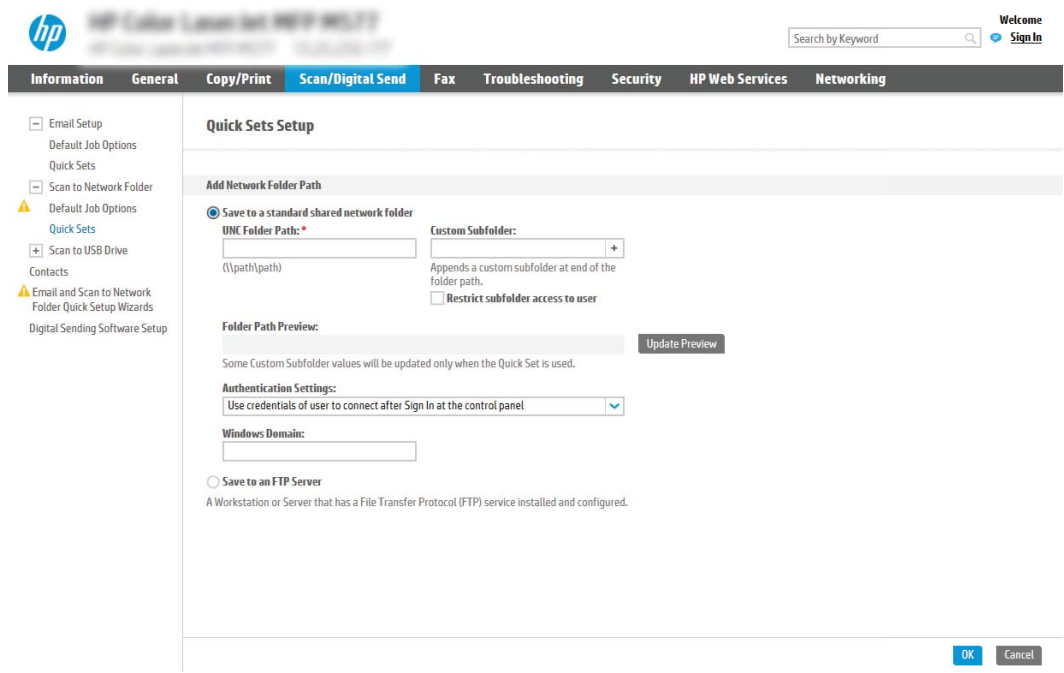
The screenshot shows the HP ePrint web interface. The top navigation bar includes tabs for Information, General, Copy/Print, Scan/Digital Send (selected), Fax, Troubleshooting, Security, HP Web Services, and Networking. A search bar and a 'Welcome Sign In' link are also visible. The left sidebar contains a tree view with options like Email Setup, Scan to Network Folder, and Scan to USB Drive. The main content area is titled 'Quick Sets Setup' and features a 'Folder Settings' section. This section explains that standard shared folders use UNC paths and personal shared folders require sign-in. Three radio button options are available: 'Save to shared folders or FTP folders' (selected), 'Save to a personal shared folder', and 'Send only to folders with read and write access'. The 'Send only to folders with read and write access' option is further divided into 'Verify folder access prior to job start' (checked) and 'Allow sending to folders with write access only'. At the bottom right, there are 'Previous', 'Next', 'Finish', and 'Cancel' buttons.


## Configure the destination folder for scanned documents

### Option 1: Shared folders or FTP folders


To save scanned documents to a standard shared folder or an FTP folder, complete the following steps:

1. If it is not already selected, select **Save to shared folders or FTP folders**.
2. Click **Add...**. The **Add Network Folder Path** dialog opens.
3. On the **Add Network Folder Path** dialog, select one of the following options:
  - Option one: **Save to a standard shared network folder**



 **NOTE:** For more information about creating shared network folders see [Set up a shared folder](#) (c04431534).


1. If it is not already selected, select **Save to a standard shared network folder**.
2. In the **UNC Folder Path** field, type a folder path.  
The folder path can either be the fully-qualified domain name (FQDN) (e.g., \servername.us.companyname.net\scans) or the IP address of the server (e.g., \16.88.20.20\scans). Be sure that the folder path (e.g., \scans) follows the FQDN or IP address.

 **NOTE:** The FQDN can be more reliable than the IP address. If the server gets its IP address via DHCP, the IP address can change. However, the connection with an IP address might be faster because the printer does not need to use DNS to find the destination server.

3. To automatically create a subfolder for scanned documents in the destination folder, select a format for the subfolder name from the **Custom Subfolder** list.  
To restrict the subfolder access to the user who creates the scan job, select **Restrict subfolder access to user**.
4. To view the complete folder path for scanned documents, click **Update Preview**.
5. From the **Authentication Settings** list, select one of the following options:
  - **Use credentials of user to connect after Sign In at the control panel**
  - **Always use these credentials**


 **NOTE:** If **Always use these credentials** is selected, a user name and password must be entered in the corresponding fields.


6. In the **Windows Domain** field, type the Windows domain.

 **NOTE:** To find the Windows domain in Windows 7, click **Start**, click **Control Panel**, and then click **System**.

To find the Windows domain in Windows 8, click **Search**, enter **System** in the search box, and then click **System**.

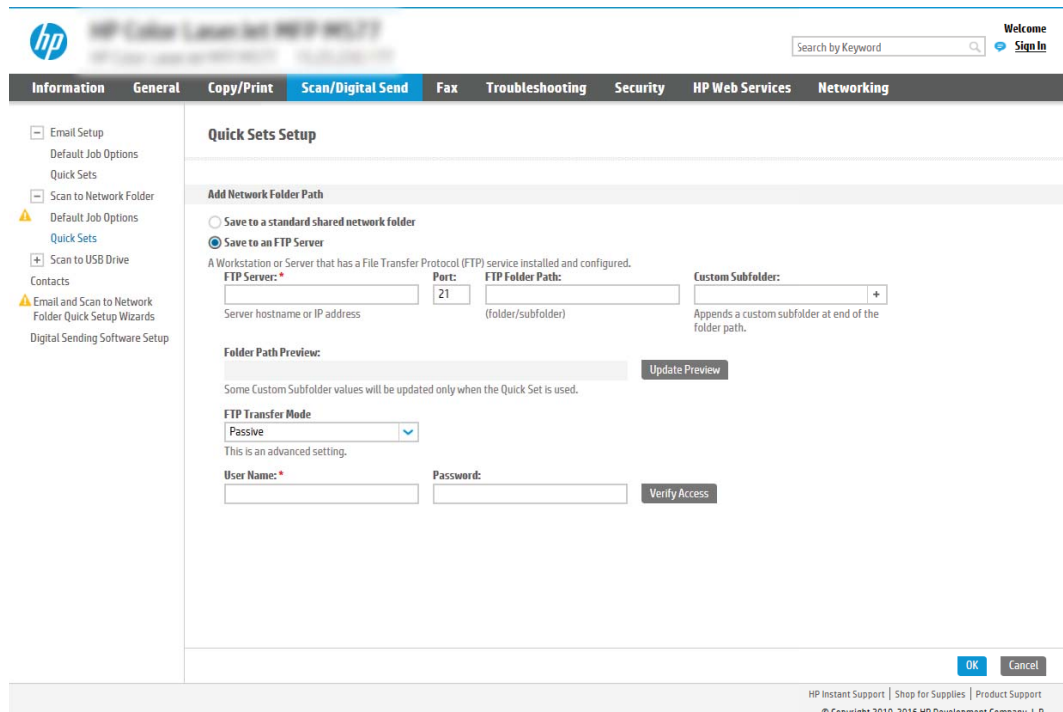
The domain is listed under **Computer name, domain, and workgroup settings**.

 **NOTE:** If a shared folder is set to be accessed by everyone, values for a workgroup name (default is “Workgroup”), a user name and password must be entered in the corresponding fields. However, if the folder is within a particular user’s folders and not Public, the user name and password of that user must be used.

 **NOTE:** An IP address might be necessary instead of a computer name. Many home routers do not handle computer names well, and there is no Domain Name Server (DNS). In this case, it is best to set up a static IP address on the shared PC to alleviate the problem of DHCP assigning a new IP address. On a typical home router, this is done by setting a static IP address that is on the same subnet, but outside the DHCP address range.

7. Click **OK**.

- Option two: **Save to an FTP Server**



The screenshot shows the HP EWS interface for configuring a Quick Set. The 'Scan/Digital Send' tab is active. In the left sidebar, 'Scan to Network Folder' is expanded, and 'Save to an FTP Server' is selected. The main content area is titled 'Quick Sets Setup' and shows the 'Add Network Folder Path' section. The 'Save to an FTP Server' radio button is selected. Below this, there are fields for 'FTP Server' (with a hint 'Server hostname or IP address'), 'Port' (set to 21), 'FTP Folder Path' (with a hint '(folder/subfolder)'), and 'Custom Subfolder' (with a hint 'Appends a custom subfolder at end of the folder path.'). There is an 'Update Preview' button. Below these fields, the 'FTP Transfer Mode' is set to 'Passive' with a dropdown arrow and a note 'This is an advanced setting.' There are also fields for 'User Name' and 'Password' with a 'Verify Access' button. At the bottom right, there are 'OK' and 'Cancel' buttons. The footer contains 'HP Instant Support | Shop for Supplies | Product Support © Copyright 2010-2016 HP Development Company, L.P.'

 **NOTE:** If an FTP site is outside the firewall, a proxy server must be specified under the network settings. These settings are located in the **EWS Networking** tab, under the **Advanced** options.

1. Select **Save to an FTP Server**.
2. In the **FTP Server** field, type the FTP server name or IP address.
3. In the **Port** field, type the port number.

 **NOTE:** In most cases, the default port number does not need to be changed.



4. To automatically create a subfolder for scanned documents in the destination folder, select a format for the subfolder name from the **Custom Subfolder** list.
5. To view the complete folder path for scanned documents, click **Update Preview**.
6. From the **FTP Transfer Mode** list, select one of the following options:
  - **Passive**
  - **Active**
7. In the **Username** field, type the user name.
8. In the **Password field**, type the password.
9. Click **Verify Access** to confirm the destination can be accessed.
10. Click **OK**.

### Option 2: Personal shared folders

To save scanned documents to a personal shared folder, complete the following steps:

---

 **NOTE:** This option is used in domain environments where the administrator configures a shared folder for each user. If the Save to a personal shared folder feature is configured, users will be required to sign in at the printer control panel using Windows credentials or LDAP authentication.

---

1. Select **Save to a personal shared folder**.
2. In the **Retrieve the device user's home folder using this attribute** field, type the user's home folder in the Microsoft Active Directory.

---

 **NOTE:** Verify that the user knows where this home folder is located on the network.

---


3. To add a user name subfolder at the end of the folder path, select **Create subfolder based on user name**.  
To restrict the subfolder access to the user who creates the scan job, select **Restrict subfolder access to user**.

## Select the destination folder permissions

### Option 1: Read and write access

To send scanned documents to a folder configured for read and write access, complete the following steps:


---

 **NOTE:** **Send only to folders with read and write access** supports folder verification and job notification.

---

1. If it is not already selected, select **Send only to folders with read and write access**.
2. To require the printer to verify folder access before starting a scan job, select **Verify folder access prior to job start**.

---

 **NOTE:** Scan jobs can complete more quickly if **Verify folder access prior to job start** is not selected; however, if the folder is unavailable, the scan job will fail.

---


3. Click **Next**.

### Option 2: Write access only

To send scanned documents to a folder configured for write access only, complete the following steps:

---

 **NOTE:** **Allow sending to folders with write access only** does not support folder verification or job notification.

 **NOTE:** If this option is selected, the printer cannot increment the scan filename. It sends the same filename for all scans.

Select a time-related filename prefix or suffix for the scan filename, so that each scan is saved as a unique file, and does not overwrite a previous file. This filename is determined by the information in the File Settings dialog in the Quick Set Wizard.

---

1. Select **Allow sending to folders with write access only**.
2. Click **Next**.

### Dialog three: Notification settings

▲ On the **Notification** dialog, complete one of the following tasks:

---

 **NOTE:** In order to send notification emails, the printer must be set up to use an SMTP server for sending email jobs. For more information about setting up the SMTP server for sending emails see [Set up Scan to Email](#) (c04017973).

---

- Option one: **Do not notify**
  1. Select **Do not notify**.
  2. To prompt the user to review their notification settings, select **Prompt user prior to job start**, and then click **Next**.
- Option two: **Notify when job completes**
  1. Select **Notify when job completes**.
  2. Select the method for delivering the notification from the **Method Used to Deliver Notification** list.

If the method of notification selected is **Email**, type the email address in the **Notification Email Address** field.
  3. To include a thumbnail of the first scanned page in the notification, select **Include Thumbnail**.
  4. To prompt the user to review their notification settings, select **Prompt user prior to job start**, and then click **Next**.
- Option three: **Notify only if job fails**
  1. Select **Notify only if job fails**.
  2. Select the method for delivering the notification from the **Method Used to Deliver Notification** list.

If the method of notification selected is **Email**, type the email address in the **Notification Email Address** field.
  3. To include a thumbnail of the first scanned page in the notification, select **Include Thumbnail**.
  4. To prompt the user to review their notification settings, select **Prompt user prior to job start**, and then click **Next**.

## Dialog four: Scan Settings

On the **Scan Settings** dialog, set the default scanning preferences for the Quick Set, and then click **Next**.

### Scan settings:

Feature	Description
Original Size	Select the page size of the original document.
Original Sides	Select whether the original document is single-sided or double-sided.
Optimize Text/Picture	Select to optimize for the output of a particular type of content.
Content Orientation	Select the way the content of the original document is placed on the page: <b>Portrait</b> or <b>Landscape</b> .
Background Cleanup	Select a value to remove faint images from the background or to remove a light background color.
Darkness	Select a value to adjust the darkness of the file.
Contrast	Select a value to adjust the contrast of the file.
Sharpness	Select a value to adjust the sharpness of the file.
Image Preview	Select whether to require or make optional a displayed preview of the job or to disable a preview.
Cropping Options	Select whether or not to allow a job to be cropped and the type of cropping option.
Erase Edges	Select this setting to specify the width of edge margins to be erased, in either inches or millimeters, for the front side and back side of a job.

## Dialog five: File Settings

On the **File Settings** dialog, set the default file settings for the Quick Set, and then click **Next**.

### File settings:

Feature	Description
File Name Prefix	Set the default file name prefix used for files saved to a network folder.
File Name	Default file name for the file to be saved. Select the <b>User editable</b> check box to make this setting editable at the printer control panel.
File Name Suffix	Set the default file name suffix used for files saved to a network folder.
File Name Preview	Enter a file name, and then click the <b>Update Preview</b> button.
File Numbering Format	Select a file name format for when the job is divided into multiple files.
Add numbering when job has just one file (ex. _1-1)	Select this setting to add numbering to a file name when the job is only one file instead of multiple files.
File Type	Select the file format for the saved file. Select the <b>User editable</b> check box to make this setting editable at the printer control panel.
High Compression (smaller file)	Select this setting to compress the scanned file, which reduces the file size. However, the scanning process for a High compression file might take longer than for a Normal compression file.
PDF encryption	If the file type is PDF, then this option encrypts the output PDF file. A password must be specified as part of the encryption. The same password must be used to open the file. The user will be prompted to enter a password prior to scanning their job if one has not been set prior to pressing start.

Feature	Description
<b>Resolution</b>	Set the resolution for the file. Higher resolution images have more dots per inch (dpi), so they show more detail. Lower resolution images have fewer dots per inch and show less detail, but the file size is smaller.
<b>Quality and File Size</b>	Select the quality for the file. Higher-quality images require a larger file size than lower-quality images, and they take more time to send.
<b>Color/Black</b>	Specify whether copies are to be printed in color, black and gray, or black only.
<b>Suppress blank pages</b>	If the <b>Suppress blank pages</b> option is enabled, blank pages will be ignored.
<b>Meta Data File Format</b>	Use the drop-down list to select the file format for meta-data information.
<b>Create Multiple Files</b>	Select this setting to scan pages into separate files based on a predetermined maximum number of pages per file.

### Dialog six: Summary

On the **Summary** dialog, review the **Summary** dialog, and then click **Finish**.

### Step three: Complete the configuration

1. In the left-navigation pane, click **Scan to Network Folder**.
2. On the **Scan to Network Folder** page, review the selected settings, and then click **Apply** to complete the setup.

# Set up Scan to SharePoint® (Flow models only)

- [Introduction](#)
- [Before you begin](#)
- [Step one: Access the HP Embedded Web Server \(EWS\)](#)
- [Step two: Enable Scan to SharePoint® and create a Scan to SharePoint Quick Set](#)
- [Quick set scan settings and options for Scan to SharePoint®](#)


## Introduction

Use Scan to SharePoint® to scan documents directly to a Microsoft® SharePoint site. This feature eliminates the need to scan the documents to a network folder, USB flash drive, or email message, and then manually upload the files to the SharePoint site.

Scan to SharePoint® supports all scanning options, including the ability to scan documents as images or use the OCR features to create text files or searchable PDFs.

The feature is disabled by default. Enable Scan to SharePoint® in the HP Embedded Web Server (EWS).

---



 **NOTE:** The Scan to SharePoint® feature is only available on workflow-equipped printers.

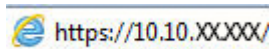
---

## Before you begin

Before this procedure can be completed, the destination folder that the scanned files will be saved to must exist on the SharePoint site, and write access must be enabled to the destination folder. Scan to SharePoint® is disabled by default.

## Step one: Access the HP Embedded Web Server (EWS)

1. From the Home screen on the printer control panel, touch the Information  icon, and then touch the Network  icon to display the IP address or host name.
2. Open a web browser, and in the address line, type the IP address or host name exactly as it displays on the printer control panel. Press the **Enter** key on the computer keyboard. The EWS opens.



---

 **NOTE:** If the web browser displays a message indicating that accessing the website might not be safe, select the option to continue to the website. Accessing this website will not harm the computer.

---

## Step two: Enable Scan to SharePoint® and create a Scan to SharePoint Quick Set

Follow these steps to enable the feature **Scan to SharePoint** feature and create a Scan to SharePoint Quick Set:

1. Using the top navigation tabs, click **Scan/Digital Send**.
2. In the left navigation pane, click **Scan to SharePoint®**.

---

 **NOTE:** Quick Sets are short-cut jobs that can be accessed on the printer Home screen or within the **Quick Sets** application.


---

3. Select the **Enable Scan to SharePoint®** check box, and then click **Add....**

4. Enter a **Quick Set Name** (for example, “Scan to SharePoint”) and a **Quick Set Description**.
5. Select a **Quick Set Start Option** to determine what occurs after selecting a Quick Set on the printer control panel, and then click the **Next** button.
6. Use the following steps to add the path to the SharePoint folder.
  - a. Click **Add** on the **SharePoint® Destination** page to open the **Add SharePoint® Path** page.
  - b. Open another browser window, navigate to the SharePoint folder to use, and then copy the folder path for the SharePoint folder from that browser window.
  - c. Paste the SharePoint folder path into the **SharePoint® Path:** field.
  - d. By default, the printer overwrites an existing file that has the same file name as the new file. Clear **Overwrite existing files** so that a new file with the same name as an existing file is given an updated time/date stamp.
  - e. Select an option from the **Authentication Settings** drop-down menu. Select whether it is necessary to sign in to the SharePoint site with credentials, or store the credentials within the Quick Set.

---

 **NOTE:** Use credentials of user to connect after **Sign In at the control panel** is selected in the **Authentication Settings** drop-down menu, the logged-in user must have permissions to write to the specified SharePoint site.

 **NOTE:** For security purposes, the printer does not display credentials entered in the Quick Set Wizard.

---

- f. Click **OK** to complete the SharePoint path setup and navigate back to the **SharePoint Destination Settings** page.
7. Select **Verify folder access prior to job start** to ensure that the SharePoint folder specified as the destination folder is accessible each time the Quick Set is used. If this option is not selected, jobs can be saved to the SharePoint folder more quickly. However, if this option is not selected *and* the SharePoint folder is inaccessible the job will fail.
8. Click **Next**.
9. Set a **Condition on Which to Notify:** on the **Notification** page. This setting configures the Quick Set to either not notify, or to send email messages or print a summary page if a job either completes successfully or fails. Select one of the following options from the **Condition on Which to Notify:** drop-down menu:
  - Select **Do not notify** for the Quick Set to not perform any notification action when a job completes successfully or fails.
  - Select **Notify when job completes** to for the Quick Set to send a notification when a job completes successfully.
  - Select **Notify only if job fails** to for the Quick Set to send a notification only when a job fails.

Selecting either **Notify when job completes** or **Notify only if job fails** requires the **Method Used to Deliver Notification:** to be set. Select from the following options:


- **Email:** Use this option to send an email when the selected notification condition occurs. This option requires a valid email address in the **Notification Email Address:** field.

---

 **NOTE:** To use the email notification feature, first configure the email feature on the printer.

---

- **Print:** Use this option to print the notification when the selected notification condition occurs.

 **NOTE:** Select **Include Thumbnail** for either notification option to include a thumbnail image of the first page of the scanned page of the job.

10. Click **Next**.
11. Select options from the **Scan Settings** page, and then click **Next**. For more information, see the table “Scan settings for Scan to SharePoint®.”
12. Select options from the **File Settings** page, and then click **Next**. For more information, see the table “File settings for Scan to SharePoint®.”
13. Review the summary of settings, and then click the **Finish** button to save the Quick Set, or click the **Previous** button to edit the settings.

## Quick set scan settings and options for Scan to SharePoint®

The following tables list the settings and options available in the Quick Set Wizard when adding, editing, or copying a Scan to SharePoint® Quick Set.

**Table 6-1** Scan settings for Scan to SharePoint®

Feature	Description
<b>Original Size</b>	Select the page size of the original document.
<b>Original Sides</b>	Select whether the original document is single-sided or double-sided.
<b>Optimize Text/Picture</b>	Select to optimize for the output of a particular type of content.
<b>Content Orientation</b>	Select the way the content of the original document is placed on the page: <b>Portrait</b> or <b>Landscape</b> .
<b>Background Cleanup</b>	Select a value to remove faint images from the background or to remove a light background color.
<b>Darkness</b>	Select a value to adjust the darkness of the file.
<b>Contrast</b>	Select a value to adjust the contrast of the file.
<b>Sharpness</b>	Select a value to adjust the sharpness of the file.
<b>Image Preview</b>	Select whether to require or make optional a displayed preview of the job or to disable a preview.
<b>Cropping Options</b>	Select whether or not to allow a job to be cropped and the type of cropping option.
<b>Erase Edges</b>	Select this setting to specify the width of edge margins to be erased, in either inches or millimeters, for the front side and back side of a job.

**Table 6-2** File settings for Scan to SharePoint

Feature	Description
<b>File Name Prefix</b>	Set the default file name prefix used for the file to be saved.
<b>File Name</b>	Default file name for the file to be saved. Select the <b>User editable</b> check box to make this setting editable at the printer control panel.
<b>File Name Suffix</b>	Set the default file name suffix used for the file to be saved. Duplicate filename suffix default [filename]_YYYYMMDDT
<b>File Name Preview</b>	Enter a file name, and then click the <b>Update Preview</b> button.

Table 6-2 File settings for Scan to SharePoint (continued)

Feature	Description
File Numbering Format	Select a file name format for when the job is divided into multiple files.
Add numbering when job has just one file (ex. _1-1)	Select this setting to add numbering to a file name when the job is only one file instead of multiple files.
File Type	Select the file format for the saved file.  Select the <b>User editable</b> check box to make this setting editable at the printer control panel.
High Compression (smaller file)	Select this setting to compress the scanned file, which reduces the file size. However, the scanning process for a High compression file might take longer than for a Normal compression file.
PDF encryption	If the file type is PDF, then this option encrypts the output PDF file. A password must be specified as part of the encryption. The same password must be used to open the file. The user will be prompted to enter a password prior to scanning their job if one has not been set prior to pressing start.
Resolution	Set the resolution for the file. Higher resolution images have more dots per inch (dpi), so they show more detail. Lower resolution images have fewer dots per inch and show less detail, but the file size is smaller.
Quality and File Size	Select the quality for the file. Higher-quality images require a larger file size than lower-quality images, and they take more time to send.
Color/Black	Specify whether copies are to be printed in color, black and gray, or black only
Suppress blank pages	If the <b>Suppress blank pages</b> option is enabled, blank pages will be ignored.
Create Multiple Files	Select this setting to scan pages into separate files based on a predetermined maximum number of pages per file.





# Set up Scan to USB Drive

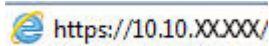
- [Introduction](#)
- [Step one: Access the HP Embedded Web Server](#)
- [Step two: Enable Scan to USB Drive](#)
- [Step three: Configure the Quick Sets \(optional\)](#)
- [Default scan settings for Scan to USB Drive setup](#)
- [Default file settings for Scan to USB Drive setup](#)

## Introduction

The printer has a feature that enables it to scan a document and save it to a USB flash drive. The feature is not available until it has been configured through the HP Embedded Web Server (EWS).

## Step one: Access the HP Embedded Web Server

1. From the Home screen on the printer control panel, touch the Information  icon, and then touch the Network  icon to display the IP address or host name.
2. Open a web browser, and in the address line, type the IP address or host name exactly as it displays on the printer control panel. Press the **Enter** key on the computer keyboard. The EWS opens.



---


 **NOTE:** If the web browser displays a message indicating that accessing the website might not be safe, select the option to continue to the website. Accessing this website will not harm the computer.

---

## Step two: Enable Scan to USB Drive

1. Select the **Security** tab.
2. Scroll to **Hardware Ports** and make sure that **Enable Host USB plug and play** is enabled.
3. Select the **Scan/Digital Send** tab.
4. Select the **Enable Scan to USB Drive** check box.
5. Click **Apply** at the bottom of the page.

---

 **NOTE:** Most devices ship with Hard disk drives (HDDs) already installed. In some cases, additional storage devices can be added via USB. Verify whether the Scan to USB Drive feature needs to be expanded to USB and Hard drive

---

## Step three: Configure the Quick Sets (optional)

---


 **NOTE:** Quick Sets are short-cut jobs that can be accessed on the printer Home screen or within the Quick Sets application.

---

1. In the **Scan to USB Drive** area of the left navigation pane, click **Quick Sets**.
2. Select one of the following options:


- Select an existing Quick Set under Quick Sets Application in the table.
  - OR-
  - Click **Add** to start the Quick Set Wizard.
3. If you selected **Add**, the **Quick Sets Setup** page opens. Complete the following information, and then click **Next**.
    - **Quick Set Name:** Enter a title for the new Quick Set.
    - **Quick Set Description:** Enter a description of the Quick Set.
    - **Quick Set Start Option:** To set how the Quick Set starts, click either **Enter application, then user presses Start** or **Start instantly when selected from the Home Screen**.
  4. Select a default location where scanned files are saved on USB storage devices inserted into the USB port on the control panel, and then click **Next**. The default location options are:
    - **Save at root directory of the USB storage device**
    - **Create or place in this folder on the USB Storage Device** — The path to the folder on the USB storage device must be specified when using this file location option. A backslash \ must be used to separate folder\subfolder names in the path.
  5. Select an option from the **Condition on Which to Notify:** drop-down list, and then click **Next**.  
 This setting determines if, or how, users are notified when a Scan To USB Drive Quick Set job completes or fails. The options for the **Condition on Which to Notify:** setting are:
    - **Do not notify**
    - **Notify when job completes**
    - **Notify only if job fails**
  6. Choose the **Scan Settings** for the Quick Set, and then click **Next**.
 

---

 **NOTE:** For more information on the available scan settings, see “Default scan settings for Scan to USB Drive setup.”

---
  7. Choose the **File Settings** for the Quick Set, and then click **Next**.
 

---

 **NOTE:** For more information on the available file settings, see “Default file settings for Scan to USB Drive setup”

---
  8. Review the summary of settings, and then click **Finish** to save the Quick Set, or click **Previous** to edit the settings.

## Default scan settings for Scan to USB Drive setup

**Table 6-3** Scan settings for Scan to USB Drive Setup:

Feature	Description
Original Size	Select the page size of the original document.

**Table 6-3** Scan settings for Scan to USB Drive Setup: (continued)

Feature	Description
Original Sides	Select whether the original document is single-sided or double-sided.
Optimize Text/Picture	Select to optimize for the output of a particular type of content.
Content Orientation	Select the way the content of the original document is placed on the page: <b>Portrait</b> or <b>Landscape</b> .
Background Cleanup	Select a value to remove faint images from the background or to remove a light background color.
Darkness	Select a value to adjust the darkness of the file.
Contrast	Select a value to adjust the contrast of the file.
Sharpness	Select a value to adjust the sharpness of the file.
Image Preview	Select whether to require or make optional a displayed preview of the job or to disable a preview.
Cropping Options	Select whether or not to allow a job to be cropped and the type of cropping option.
Erase Edges	Select this setting to specify the width of edge margins to be erased, in either inches or millimeters, for the front side and back side of a job.

## Default file settings for Scan to USB Drive setup

**Table 6-4** File settings for Scan to USB Drive Setup:

Option name	Description
File Name Prefix	Set the default file name prefix for the file to be saved.
File Name	Set the default file name for the file to be saved. Select the <b>User editable</b> check box to make this setting editable at the printer control panel.
File Name Suffix	Set the default file name suffix for the file to be saved. Duplicate filename suffix default [filename]_YYYYMMDDT
File Name Preview	Enter a file name, and then click the <b>Update Preview</b> button.
File Numbering Format	Select a file name format for when the job is divided into multiple files.
Add numbering when job has just one file (ex. _1-1)	Select this setting to add numbering to a file name when the job is only one file instead of multiple files.
File Type	Select the file format for the saved file. Select the <b>User editable</b> check box to make this setting editable at the printer control panel.
High Compression (smaller file)	Select this setting to compress the scanned file, which reduces the file size. However, the scanning process for a High compression file might take longer than for a Normal compression file.
PDF encryption	If the file type is PDF, then this option encrypts the output PDF file. A password must be specified as part of the encryption. The same password must be used to open the file. The user will be prompted to enter a password prior to scanning their job if one has not been set prior to pressing start.
Resolution	Set the resolution for the file. Higher resolution images have more dots per inch (dpi), so they show more detail. Lower resolution images have fewer dots per inch and show less detail, but the file size is smaller.


**Table 6-4** File settings for Scan to USB Drive Setup: (continued)

Option name	Description
<b>Quality and File Size</b>	Select the quality for the file. Higher-quality images require a larger file size than lower-quality images, and they take more time to send.
<b>Color/Black</b>	Specify whether the file to be saved is color, black and gray, or black only.
<b>Suppress blank pages</b>	If the <b>Suppress blank pages</b> option is enabled, blank pages will be ignored.
<b>Create Multiple Files</b>	Select this setting to scan pages into separate files based on a predetermined maximum number of pages per file.

# Scan to email


## Introduction

The printer has a feature that enables it to scan a document and send it to one or more email addresses.


 **NOTE:** Before you can scan to email, your printer administrator or IT department must use the HP Embedded Web Server to enable the feature and set it up.

## Scan to email

1. Place the document face-down on the scanner glass, or place it face-up in the document feeder and adjust the paper guides to fit the size of the document.
2. From the Home screen on the printer control panel, select **Scan**, and then select **Scan to Email**.


 **NOTE:** If prompted, type your user name and password.

3. Touch the **To** field to open a keyboard.



 **NOTE:** If you are signed in to the printer, your user name or other default information might appear in the **From** field. If so, you might not be able to change it.


4. Specify the recipients by using one of these methods:

### Enter addresses manually

- ▲ Enter the address in the **To** field. To send to multiple addresses, separate the addresses with a semicolon, or select the Enter  button on the touchscreen keyboard after typing each address.


### Enter addresses from the Contacts list

- a. Select the **Contacts**  button that is next to the **To** field to open the **Contacts** screen.
  - b. Select the appropriate contact list.
  - c. Select a name or names from the list of contacts to add the name to the recipients list, and then select **Add**.
5. Complete the **Subject**, **File Name**, and **Message** fields by touching the field and using the touchscreen keyboard to enter information. Select the **Close**  button whenever you need to close the keyboard.
  6. To load a Quick Set, select **Load**, select the Quick Set, and then select **Load** under the **Quick Sets** list.

 **NOTE:** **Quick Sets** are predefined settings for various types of output, such as **Text**, **Photograph**, and **High Quality**. You can select a Quick Set to view the description.

7. To configure settings, such as **File Type and Resolution**, **Original Sides**, and **Content Orientation**, select **Options** in the lower left corner, and then select the settings from the **Options** menus. Select **Done** if prompted.
8. **Optional Preview:** Touch the right pane of the screen to preview the document. You can use the **Expand** and **Collapse** buttons on the left side of the preview pane to expand and collapse the preview screen.

**Table 6-5** Preview pane controls

Expand button	Collapse button
	

Use the buttons on the right of the screen to adjust the preview options and to rearrange, rotate, insert, or remove pages.

**Table 6-6** Preview buttons












Button	Description
	Toggle between the two-page view and the thumbnail view. More options are available in the thumbnail view than in the two-page view.
	
	Zoom in or out on the selected page. <b>NOTE:</b> Select only one page at a time to use these buttons.
	
	Rotate the page 180 degrees. <b>NOTE:</b> This button is available only in the thumbnail view.
	Delete the selected pages. <b>NOTE:</b> This button is available only in the thumbnail view.
	Rearrange the pages within the document. Select one or more pages and move them to the left or right. <b>NOTE:</b> These buttons are available only in the thumbnail view.
	

Table 6-6 Preview buttons (continued)

Button	Description
	Add a page to the document. The printer prompts you to scan additional pages.
	Clear the changes made in the preview and start over.

9. When the document is ready, select [Send](#) to email it.

 **NOTE:** The printer might prompt you to add the email address to the contact list.

# Scan to job storage

- [Introduction](#)
- [Scan to job storage on the printer](#)
- [Print from job storage on the printer](#)

## Introduction

The printer has a feature that enables it to scan a document and save it to a job storage folder on the printer. You can retrieve the document from the printer and print it when needed.



---

**NOTE:** Before you can scan to a storage folder on the printer, your printer administrator or IT department must use the HP Embedded Web Server to enable the feature and configure the settings.

---

## Scan to job storage on the printer

Use this procedure to scan a document and save it to a job storage folder on the printer so that you can print copies at any time.

1. Place the document face-down on the scanner glass, or place it face-up in the document feeder and adjust the paper guides to fit the size of the document.
2. From the Home screen on the printer control panel, select [Scan](#), and then select [Scan to Job Storage](#).



---

**NOTE:** If prompted, enter your user name and password.

---




3. Select the default storage folder name shown under [Folder](#).



---



**NOTE:** If the printer administrator has configured the option, you can create a new folder. Follow these steps to create a new folder:

---

- a. Select the [New Folder](#)  icon.
  - b. Select the [New Folder](#) field, type the folder name, and then select [OK](#).
4. Make sure that you have selected the correct folder.
  5. Touch the [Job Name](#) text field to open a touchscreen keyboard, type the name for the file, and then select the Enter  button.
  6. To make the job private, select the PIN  button, enter a four-digit PIN in the [PIN](#) field, and then close the touchscreen keypad.
  7. To configure settings, such as [Sides](#) and [Content Orientation](#), select [Options](#) in the lower left corner, and then select the settings from the [Options](#) menus. Select [Done](#) for each setting if prompted.
  8. Optional Preview: Touch the right pane of the screen to preview the document. You can use the [Expand](#) and [Collapse](#) buttons on the left side of the preview pane to expand and collapse the preview screen.



**Table 6-7 Preview pane controls**

Expand button	Collapse button
	

Use the buttons on the right of the screen to adjust the preview options and to rearrange, rotate, insert, or remove pages.

**Table 6-8 Preview buttons**











Button	Description
	Toggle between the two-page view and the thumbnail view. More options are available in the thumbnail view than in the two-page view.
	
	Zoom in or out on the selected page. <b>NOTE:</b> Select only one page at a time to use these buttons.
	
	Rotate the page 180 degrees. <b>NOTE:</b> This button is available only in the thumbnail view.
	Delete the selected pages. <b>NOTE:</b> This button is available only in the thumbnail view.
	Rearrange the pages within the document. Select one or more pages and move them to the left or right. <b>NOTE:</b> These buttons are available only in the thumbnail view.
	


Table 6-8 Preview buttons (continued)

Button	Description
	Add a page to the document. The printer prompts you to scan additional pages.
	Clear the changes made in the preview and start over.

9. When the document is ready, select [Save](#) to save the file to the storage folder.

## Print from job storage on the printer


Use this procedure to print a scanned document that is in a job storage folder on the printer.

1. From the Home screen on the printer control panel, select [Print](#), and then select [Print from Job Storage](#).
2. Under [Stored Jobs to Print](#), select [Choose](#), select the folder in which the document is saved, select the document, and then select [Select](#).
3. If the document is private, enter the four-digit PIN in the [Password](#) field, and then select [OK](#).
4. To adjust the number of copies, touch the box to the left of the [Print](#) button, and then select the number of copies from the keypad that opens. Select the Close  button to close the keypad.
5. Select [Print](#) to print the document.

# Scan to network folder


## Introduction


The printer can scan a file and save it in a shared folder on the network.


 **NOTE:** Before you can scan to a network folder, your printer administrator or IT department must use the HP Embedded Web Server to enable the feature and configure the shared folders.


## Scan to network folder

 **NOTE:** You might be required to sign in to the printer to use this feature.



1. Place the document face-down on the scanner glass, or place it face-up in the document feeder and adjust the paper guides to fit the size of the document.
2. From the Home screen on the printer control panel, select [Scan](#), and then select [Scan to Network Folder](#).
3. Specify a folder destination. Folder options must first be configured by the printer administrator.
  - To select a folder location that the administrator already set up, select [Load](#) under [Quick Sets and Defaults](#), select the folder, and then select [Load](#).
  - To specify a new folder location, touch the [Folder Paths](#) field to open a touchscreen keyboard, type the path to the folder, and then select the Enter  button. Enter user credentials if prompted and then select [Save](#) to save the path.

 **NOTE:** Use this format for the path: `\\server\folder`, where “server” is the name of the server that hosts the shared folder, and “folder” is the name of the shared folder. If the folder is nested inside other folders, complete all necessary segments of the path to reach the folder. For example: `\server\folder\folder`

 **NOTE:** The [Folder Paths](#) field might have a pre-defined path, and it might not be editable. In this situation, the administrator has configured this folder for common access.

4. Touch the [File Name](#) text field to open a touchscreen keyboard, type the name for the file, and then select the Enter  button.
5. To configure settings, such as [File Type and Resolution](#), [Original Sides](#), and [Content Orientation](#), select [Options](#) in the lower left corner, and then select the settings from the [Options](#) menus. Select [Done](#) for each setting if prompted.
6. Optional Preview: Touch the right pane of the screen to preview the document. You can use the [Expand](#) and [Collapse](#) buttons on the left side of the preview pane to expand and collapse the preview screen.

**Table 6-9** Preview pane controls

Expand button	Collapse button
	

Use the buttons on the right of the screen to adjust the preview options and to rearrange, rotate, insert, or remove pages.

**Table 6-10** Preview buttons

Button	Description
	Toggle between the two-page view and the thumbnail view. More options are available in the thumbnail view than in the two-page view.
	
	Zoom in or out on the selected page. <b>NOTE:</b> Select only one page at a time to use these buttons.
	
	Rotate the page 180 degrees. <b>NOTE:</b> This button is available only in the thumbnail view.
	Delete the selected pages. <b>NOTE:</b> This button is available only in the thumbnail view.
	Rearrange the pages within the document. Select one or more pages and move them to the left or right. <b>NOTE:</b> These buttons are available only in the thumbnail view.
	
	Add a page to the document. The printer prompts you to scan additional pages.
	Clear the changes made in the preview and start over.


7. When the document is ready, select [Send](#) to save the file to the network folder.

# Scan to SharePoint

## Introduction

If you have a workflow-equipped printer, you can scan a document and send it to a Microsoft® SharePoint site. This feature eliminates the need to scan the documents to a network folder, USB flash drive, or email message, and then manually upload the files to the SharePoint site.


Scan to SharePoint® supports all scanning options, including the ability to scan documents as images or use the OCR features to create text files or searchable PDFs.

 **NOTE:** Before you can scan to SharePoint, your printer administrator or IT department must use the HP Embedded Web Server to enable the feature and set it up.



## Scan to SharePoint

1. Place the document face-down on the scanner glass, or place it face-up in the document feeder and adjust the paper guides to fit the size of the document.
2. From the Home screen on the printer control panel, select **Scan**, and then select **Scan to SharePoint®**.

 **NOTE:** It might be necessary to sign in to the printer to use this feature.











3. To select a Quick Set, touch **Select** under **Quick Sets**, select a Quick Set, and then select **Load**.
4. Select the **File Name:** text field to open a keyboard, type the name for the file, and then select the **Enter**  button.
5. To configure settings, such as **File Type and Resolution**, **Sides**, and **Content Orientation**, select **Options** in the lower left corner, and then select the settings from the **Options** menus. Select **Done** if prompted.
6. Optional Preview: Touch the right pane of the screen to preview the document. You can use the **Expand** and **Collapse** buttons on the left side of the preview pane to expand and collapse the preview screen.

**Table 6-11** Preview pane controls

Expand button	Collapse button
	

Use the buttons on the right of the screen to adjust the preview options and to rearrange, rotate, insert, or remove pages.

Table 6-12 Preview buttons


Button	Description
	Toggle between the two-page view and the thumbnail view. More options are available in the thumbnail view than in the two-page view.
	
	Zoom in or out on the selected page. <b>NOTE:</b> Select only one page at a time to use these buttons.
	
	Rotate the page 180 degrees. <b>NOTE:</b> This button is available only in the thumbnail view.
	Delete the selected pages. <b>NOTE:</b> This button is available only in the thumbnail view.
	Rearrange the pages within the document. Select one or more pages and move them to the left or right. <b>NOTE:</b> These buttons are available only in the thumbnail view.
	
	Add a page to the document. The printer prompts you to scan additional pages.
	Clear the changes made in the preview and start over.

7. When the document is ready, select [Send](#) to save it to the SharePoint location.

# Scan to USB drive


## Introduction

The printer can scan a file and save it to a USB flash drive.



 **NOTE:** Before you can scan to a USB drive, your printer administrator or IT department must use the HP Embedded Web Server to enable the feature and set it up.

## Scan to USB drive

 **NOTE:** You might be required to sign in to the printer to use this feature.



1. Place the document face-down on the scanner glass, or place it face-up in the document feeder and adjust the paper guides to fit the size of the document.
2. Insert the USB drive into the USB port near the printer control panel.
3. From the Home screen on the printer control panel, select [Scan](#), and then select [Scan to USB Drive](#).
4. Select the USB drive under [Destination](#), and then select the save location (either the root of the USB drive or an existing folder).
5. Touch the [File Name](#) text field to open a touchscreen keyboard, type the name for the file, and then select the Enter  button.
6. To configure settings, such as [File Type and Resolution](#), [Original Sides](#), and [Content Orientation](#) select [Options](#) in the lower left corner, and then select the settings from the [Options](#) menus. Select [Done](#) if prompted.
7. Optional Preview: Touch the right pane of the screen to preview the document. You can use the [Expand](#) and [Collapse](#) buttons on the left side of the preview pane to expand and collapse the preview screen.

**Table 6-13** Preview pane controls

<a href="#">Expand</a> button	<a href="#">Collapse</a> button
	

Use the buttons on the right of the screen to adjust the preview options and to rearrange, rotate, insert, or remove pages.

Table 6-14 Preview buttons

Button	Description
	Toggle between the two-page view and the thumbnail view. More options are available in the thumbnail view than in the two-page view.
	
	Zoom in or out on the selected page. <b>NOTE:</b> Select only one page at a time to use these buttons.
	
	Rotate the page 180 degrees. <b>NOTE:</b> This button is available only in the thumbnail view.
	Delete the selected pages. <b>NOTE:</b> This button is available only in the thumbnail view.
	Rearrange the pages within the document. Select one or more pages and move them to the left or right. <b>NOTE:</b> These buttons are available only in the thumbnail view.
	
	Add a page to the document. The printer prompts you to scan additional pages.
	Clear the changes made in the preview and start over.

8. When the document is ready, select [Save](#) to save the file to the USB drive.



## Additional options when scanning

The following settings are available in the [Options](#) list when scanning.



---

**NOTE:** The following list contains the master set of options available for HP Enterprise MFP printers. Some options are not available on all printers.

---

**Table 6-15 Scan options**

Option	Description
File Type and Resolution	<p>Save a scanned document as one of several types of files.</p> <p>The following standard file types are available:</p> <ul style="list-style-type: none"> <li>● <b>PDF:</b> This file type provides the best overall image and text quality. PDF files require Adobe® Acrobat® Reader software for viewing.</li> <li>● <b>JPEG:</b> This file type is a good choice for most graphics. Most computers have a browser that can view .JPEG files. This file type produces one file per page.</li> <li>● <b>TIFF:</b> This is a standard file type that many graphics programs support. This file type produces one file per page.</li> <li>● <b>MTIFF:</b> MTIFF stands for multi-page TIFF. This file type saves multiple scanned pages in a single file.</li> <li>● <b>XPS:</b> XPS (XML Paper Specification) creates an XAML file that preserves the original formatting of the document and supports color graphics and embedded fonts.</li> <li>● <b>PDF/A:</b> PDF/A is a type of PDF designed for long-term archival of electronic documents. All format information in the document is self-contained.</li> </ul> <p>HP Enterprise Flow MFP printers or MFP printers that are connected to a digital send software (DSS) server also support the following OCR file types:</p> <ul style="list-style-type: none"> <li>● <b>Text (OCR):</b> Text (OCR) creates a text file by using optical character recognition (OCR) to scan the original. A text file can be opened in any word processing program. The formatting of the original will not be saved using this option.</li> <li>● <b>Unicode Text (OCR):</b> Unicode Text (OCR) is an industry standard used to consistently represent and manipulate text. This file type is useful for internationalization and localization.</li> <li>● <b>RTF (OCR):</b> RTF (OCR) creates a rich text format (RTF) file by using optical character recognition (OCR) to scan the original. RTF is an alternative text format that can be opened by most word processing programs. Some of the formatting of the original will be saved using this option.</li> <li>● <b>Searchable PDF (OCR):</b> Searchable PDF (OCR) creates a searchable PDF file by using optical character recognition (OCR) to scan the original. When a document is scanned in this way, use Adobe Acrobat® Reader's search tools to search for specific words or phrases within the PDF.</li> <li>● <b>Searchable PDF/A (OCR):</b> Searchable PDF/A (OCR) is a type of PDF/A file that includes information about the document structure, which allows content to be searched.</li> <li>● <b>HTML (OCR):</b> HTML (OCR) creates a Hypertext Markup Language (HTML) file containing the contents of the original document. HTML is used to display files on Web sites.</li> <li>● <b>CSV (OCR):</b> CSV (OCR) is common text file format that contains comma-separated values. This type of file can be opened by most word processing, spreadsheet, or database programs.</li> </ul> <p>MFP printers that are connected to a DSS server also support the following OCR file types for digital send jobs:</p> <ul style="list-style-type: none"> <li>● <b>XML (OCR):</b> DESCRIPTION NEEDED.</li> <li>● <b>Searchable XPS (OCR):</b> DESCRIPTION NEEDED.</li> </ul>
Original Sides	Specify whether the original document is printed on one side or both sides.
Color/Black	Specify whether the scanned image will be in color, black and gray, or black only.
	For color printers only.

**Table 6-15 Scan options (continued)**

Option	Description
<p><b>Scan Mode</b></p> <p><b>NOTE:</b> This feature is not available for all firmware versions. You might need to update the printer firmware to use this feature.</p>	<p><b>Standard Document:</b> Scan a page or stack of pages through the document feeder, or individually on the flatbed glass.</p> <p><b>Book Mode:</b> Scan an open book and output each page of the book onto different pages.</p> <p><b>2-sided ID Copy:</b> Scan each side of an identification card on the flatbed glass and output them onto one page. After scanning the first side, the printer prompts to place the second side in the correct position on the glass.</p>
<b>Resolution</b>	Specify the resolution of scanned images. Select a higher resolution to increase the clarity of the image. However, as the resolution increases, the file size also increases.
<b>Original Size</b>	Specify the paper size for the original document.
<b>Content Orientation</b>	Specify whether the original document is printed in Portrait or Landscape orientation.
<b>Image Adjustment</b>	<p><b>Sharpness:</b> Clarify or soften the image. For example, increasing the sharpness could make text appear crisper, but decreasing it could make photos appear smoother.</p> <p><b>Darkness:</b> Increase or decrease the amount of white and black used in colors in scanned images.</p> <p><b>Contrast:</b> Increase or decrease the difference between the lightest and the darkest color on the page.</p> <p><b>Background Cleanup:</b> Remove faint colors from the background of scanned images. For example, if the original document is printed on colored paper, use this feature to lighten the background without affecting the darkness of the image.</p> <p><b>Automatic Tone:</b> Available for Flow printers only. The printer automatically adjusts the <b>Darkness</b>, <b>Contrast</b>, and <b>Background Cleanup</b> settings to the most appropriate for the scanned document.</p>
<b>Optimize Text/Picture</b>	Optimize the job for the type of image being scanned: text, graphics, or photos.
<b>Erase Edges</b>	Remove blemishes, such as dark borders or staple marks, by cleaning the edges of the scanned image.
<b>Cropping Options</b>	<p><b>Crop to original size:</b> Crop the image to match the paper size of the original document.</p> <p><b>Crop to content:</b> Crop the image to the size of the detectable content in the original document.</p>
<b>Automatically Straighten</b>	Automatically straighten a scanned image.
<b>Blank Page Suppression</b>	Exclude blank pages in the original document from scanned images. This feature is useful for scanning pages printed on both sides to eliminate blank pages in the resulting scanned document.
<b>Multi-feed Detection</b>	Enable or disable multi-feed detection. When enabled, scanning stops when the printer detects more than one page at a time being fed in the document feeder. When disabled, scanning continues when a multi-feed is detected, to allow scanning pages that are stuck together, originals with self-adhesive notes on them, or thick paper.
<b>Create Multiple Files</b>	Divide a larger scan job into several smaller output files.
<b>Notification</b>	Select whether to send notifications of the status of scan jobs. The printer can print the notification, or it can send the notification in an email.
<b>Signing and Encryption</b>	<p><b>Sign:</b> Send an email with a digital signature.</p> <p><b>NOTE:</b> This feature is supported for scan to email only.</p> <p><b>Encrypt:</b> Send an email as an encrypted file.</p>

## HP JetAdvantage business solutions

HP JetAdvantage solutions are workflow and printing solutions that are easy-to-use, and both network and cloud-based. HP JetAdvantage solutions are designed to help businesses of all types, including healthcare, financial services, manufacturing, and public sector, manage a fleet of printers and scanners.

HP JetAdvantage Solutions include:

- HP JetAdvantage Security solutions
- HP JetAdvantage Management solutions
- HP JetAdvantage Workflow solutions
- HP JetAdvantage Mobile Printing solutions

For more information about HP JetAdvantage business workflow and printing solutions, go to [www.hp.com/go/PrintSolutions](http://www.hp.com/go/PrintSolutions).

## Additional scan tasks

Go to [www.hp.com/support/ljE62655mfp](http://www.hp.com/support/ljE62655mfp), [www.hp.com/support/ljE62665mfp](http://www.hp.com/support/ljE62665mfp), or [www.hp.com/support/ljE62675mfp](http://www.hp.com/support/ljE62675mfp).

Instructions are available for performing specific scan tasks, such as the following:

- Copy or scan pages from books or other bound documents
- Copy or scan both sides of an identification card
- Copy or scan a document into a booklet format



---

# 7 Fax

- [Set up fax](#)
- [Change fax configurations](#)
- [Send a fax](#)
- [Additional fax tasks](#)

## For more information

The following information is correct at the time of publication.

For video assistance, see [www.hp.com/videos/LaserJet](http://www.hp.com/videos/LaserJet).

For current information, see [www.hp.com/support/ljE62655mfp](http://www.hp.com/support/ljE62655mfp), [www.hp.com/support/ljE62665mfp](http://www.hp.com/support/ljE62665mfp), or [www.hp.com/support/ljE62675mfp](http://www.hp.com/support/ljE62675mfp).

HP's all-inclusive help for the printer includes the following information:

- Install and configure
- Learn and use
- Solve problems
- Download software and firmware updates
- Join support forums
- Find warranty and regulatory information

# Set up fax

## Introduction

This information applies to fax and Flow models, or to other printers when an optional analog fax accessory has been installed. Before continuing, connect the printer to a phone line (for analog fax) or to an Internet or network fax service.

## Set up fax by using the printer control panel

1. From the Home screen on the printer control panel, navigate to the [Settings](#) application, and then select the [Settings](#) icon.
2. Open the following menus:
  - a. [Fax](#)
  - b. [Internal Fax Modem Setup](#)



---


**NOTE:** If the [Internal Fax Modem Setup](#) menu does not appear in the menu listing, LAN or Internet fax might be enabled. When LAN or Internet fax is enabled, the analog fax accessory is disabled and the [Internal Fax Modem Setup](#) menu does not display. Only one fax feature, either LAN fax, analog fax, or Internet fax, can be enabled at a time. To use analog fax when LAN fax is enabled, use the HP Embedded Web Server to disable LAN fax.

---

3. Select the location from the list on the right side of the screen, and then select [Next](#).
4. Touch the [Company Name](#) text field, and use the keypad to type the company name.
5. Touch the [Fax Number](#) text field, and use the keypad to type the sending fax number. Select [Next](#).
6. Verify that the date and time settings are correct. Make changes as necessary, and then select [Next](#).
7. If a dialing prefix is required for sending faxes, touch the [Dialing Prefix](#) text field, and use the keypad to enter the number.
8. Review all the information on the left pane, and then select [Finish](#) to complete the fax setup.



# Change fax configurations

 **NOTE:** The settings configured using the control panel override any settings made in the HP Embedded Web Server.

- [Fax dialing settings](#)
- [General fax send settings](#)
- [Fax receive settings](#)

## Fax dialing settings

1. From the Home screen on the printer control panel, navigate to the [Settings](#) application, and then select the [Settings](#) icon.
2. Open the following menus:
  - a. [Fax](#)
  - b. [Fax Send Settings](#)
  - c. [Fax Dialing Settings](#)

Configure any of the following settings, and then select [Done](#):

Menu item	Description
<a href="#">Redial on Error</a>	The <a href="#">Redial on Error</a> feature sets the number of times a fax number will be redialed when an error occurs during a fax transmission.
<a href="#">Redial on No Answer</a>	The <a href="#">Redial on No Answer</a> setting selects the number of times the fax accessory redials if the number dialed does not answer. The number of retries is either 0 to 1 (used in the U.S.) or 0 to 2, depending on the location setting. The interval between retries is set by the redial interval setting.
<a href="#">Redial on Busy</a>	The <a href="#">Redial on Busy</a> setting selects the number of times (0 through 9) the fax accessory redials a number when the number is busy. The interval between retries is set by the Redial Interval setting.
<a href="#">Redial Interval</a>	<p>The <a href="#">Redial Interval</a> setting selects the number of minutes between retries if the number dialed is busy or not answering, or if an error occurs.</p> <p><b>NOTE:</b> You might observe a redial message on the control panel when both the <a href="#">Redial on Busy</a> and <a href="#">Redial on No Answer</a> settings are set to off. This occurs when the fax accessory dials a number, establishes a connection, and then loses the connection. As a result of this error condition, the fax accessory performs three automatic redial attempts regardless of the redial settings. During this redial operation, a message displays on the control panel to indicate that a redial is in progress.</p>
<a href="#">Fax Send Speed</a>	<p>The <a href="#">Fax Send Speed</a> setting sets the modem bit rate (measured in bits per second) of the Analog Fax modem while sending a fax.</p> <ul style="list-style-type: none"><li>• <a href="#">Fast (v.34 – 33.6k)</a></li><li>• <a href="#">Medium (v.17 – 14.4k)</a></li><li>• <a href="#">Slow (v.29 – 9.6k)</a></li></ul>
<a href="#">Line Monitor Volume</a>	Use the <a href="#">Line Monitor Volume</a> setting to control the printer's dialing volume level when sending faxes.

Menu item	Description
Dialing Mode	The <a href="#">Dialing Mode</a> setting sets the type of dialing that is used: either tone (touch-tone phones) or pulse (rotary-dial phones).
Dialing Prefix	The <a href="#">Dialing Prefix</a> setting allows you to enter a prefix number (such as a "9" to access an outside line) when dialing. This prefix number is automatically added to all phone numbers when dialed.
Detect dial tone	The <a href="#">Detect dial tone</a> setting determines whether the fax checks for a dial tone before sending a fax.

## General fax send settings

1. From the Home screen on the printer control panel, navigate to the [Settings](#) application, and then select the [Settings](#) icon.
2. Open the following menus:
  - a. [Fax](#)
  - b. [Fax Send Settings](#)
  - c. [General Fax Send Settings](#)

Configure any of the following settings, and then select [Done](#):

Menu item	Description
<a href="#">Fax Number Confirmation</a>	When the <a href="#">Fax Number Confirmation</a> feature is enabled, the fax number must be entered twice to ensure that it was entered correctly. The feature is disabled by default.
<a href="#">PC Fax Send</a>	Use the <a href="#">PC Fax Send</a> feature to send faxes from a PC. This feature is enabled by default.
<a href="#">Error Correction Mode</a>	<p>Normally, the fax accessory monitors the signals on the telephone line while it is sending or receiving a fax. If the fax accessory detects an error during the transmission and the <a href="#">Error Correction Mode</a> setting is on, the fax accessory can request that the error portion of the fax be sent again.</p> <p>The <a href="#">Error Correction Mode</a> feature is enabled by default. You should turn it off only if you are having trouble sending or receiving a fax and if you are willing to accept the errors in the transmission and a probable quality reduction in the image. Turning off the setting might be useful when you are trying to send a fax overseas or receive one from overseas, or if you are using a satellite telephone connection.</p> <p><b>NOTE:</b> Some VoIP providers might suggest turning off the <a href="#">Error Correction Mode</a> setting. However, this is not usually necessary.</p>
<a href="#">Fax Header</a>	Use the <a href="#">Fax Header</a> feature to control whether the header is appended to the top, and content is shifted down, or if the header is overlaid on top of the previous header.

## Fax receive settings

1. From the Home screen on the printer control panel, navigate to the [Settings](#) application, and then select the [Settings](#) icon.
2. Open the following menus:

- a. [Fax](#)
- b. [Fax Receive Settings](#)
- c. [Fax Receive Setup](#)


Configure any of the following settings, and then select [Done](#):

Menu item	Description
<a href="#">Receive Mode</a>	<p>The <a href="#">Receive Mode</a> setting determines how the fax accessory receives fax jobs. Select one of the following options:</p> <ul style="list-style-type: none"> <li>• <a href="#">Automatic</a></li> <li>• <a href="#">TAM</a></li> <li>• <a href="#">Fax/Tel</a></li> <li>• <a href="#">Manual</a></li> </ul>
<a href="#">Rings to Answer</a>	<p>The <a href="#">Rings to Answer</a> setting determines the number of times the phone rings before the call is answered by the fax accessory.</p> <p><b>NOTE:</b> The default range for the available options for the <a href="#">Rings to Answer</a> setting is location-specific. The range of possible <a href="#">Rings to Answer</a> options is limited by location.</p> <p>If the fax accessory is not answering, and the <a href="#">Rings to Answer</a> setting is <b>1</b>, try increasing it to <b>2</b>.</p>
<a href="#">Ring Volume</a>	The <a href="#">Ring Volume</a> setting allows you to adjust the ringer volume.
<a href="#">Fax Receive Speed</a>	<p>Touch the <a href="#">Fax Receive Speed</a> drop down menu and select one of the following options:</p> <ul style="list-style-type: none"> <li>• <a href="#">Fast (v.34 – 33.6k)</a></li> <li>• <a href="#">Medium (v.17 – 14.4k)</a></li> <li>• <a href="#">Slow (v.29 – 9.6k)</a></li> </ul>
<a href="#">Extension Phone</a>	This setting allows you use a separate telephone in conjunction with the fax functions.
<a href="#">Allow Reprinting</a>	This setting allows you to reprint received faxes.
<a href="#">Receive to PC</a>	This setting allows you to receive faxes directly to your computer.
<a href="#">Fax Polling</a>	This setting allows you to enable or disable the fax polling function.
<a href="#">Fax/Tel Ring Time</a>	This setting determines the number of times the phone rings before the fax/tel mode initiates.


## Send a fax

1. Place the document face-down on the scanner glass, or place it face-up in the document feeder and adjust the paper guides to fit the size of the document.
2. From the Home screen on the printer control panel, select **Fax**. You might be prompted to type a user name and password.
3. Specify the recipients by using one of these methods:


### Enter recipients manually

- ▲ Touch the **Fax Recipients** text field, and then use the keypad to enter the fax number. To send to multiple fax numbers, separate the numbers with a semicolon, or select the Enter  button on the touchscreen keyboard after typing each number.

### Enter recipients from the Contacts list

- a. Select the Contacts  button that is next to the **Fax Recipients** field to open the **Contacts** screen.
  - b. Select the appropriate contact list.
  - c. Select a name or names from the list of contacts to add to the recipients list, and then select **Add**.
4. To load a Quick Set, select **Load**, select the Quick Set, and then select **Load** under the **Quick Sets** list.



---

 **NOTE:** **Quick Sets** are predefined settings for various types of output, such as **Text**, **Photograph**, and **High Quality**. You can select a Quick Set to view the description.

---








5. To configure settings, such as **Resolution**, **Sides**, and **Content Orientation**, select **Options** in the lower left corner, and then select the settings from the **Options** menus. Select **Done** if prompted.
6. Optional Preview: Touch the right pane of the screen to preview the document. You can use the **Expand** and **Collapse** buttons on the left side of the preview pane to expand and collapse the preview screen.

**Table 7-1** Preview pane controls

Expand button	Collapse button
	

Use the buttons on the right of the screen to adjust the preview options and to rearrange, rotate, insert, or remove pages.

Table 7-2 Preview buttons

Button	Description
	Toggle between the two-page view and the thumbnail view. More options are available in the thumbnail view than in the two-page view.
	
	Zoom in or out on the selected page. <b>NOTE:</b> Select only one page at a time to use these buttons.
	
	Rotate the page 180 degrees. <b>NOTE:</b> This button is available only in the thumbnail view.
	Delete the selected pages. <b>NOTE:</b> This button is available only in the thumbnail view.
	Rearrange the pages within the document. Select one or more pages and move them to the left or right. <b>NOTE:</b> These buttons are available only in the thumbnail view.
	
	Add a page to the document. The printer prompts you to scan additional pages.
	Clear the changes made in the preview and start over.

7. When the document is ready, select [Send](#) to send the fax.

## Additional fax tasks

Go to [www.hp.com/support/ljE62655mfp](http://www.hp.com/support/ljE62655mfp), [www.hp.com/support/ljE62665mfp](http://www.hp.com/support/ljE62665mfp), or [www.hp.com/support/ljE62675mfp](http://www.hp.com/support/ljE62675mfp).

Instructions are available for performing specific fax tasks, such as the following:

- Create and manage fax speed dial lists
- Configure fax billing codes
- Use a fax printing schedule
- Block incoming faxes
- Fax archiving and forwarding

---

# 8 Manage the printer

- [Advanced configuration with the HP Embedded Web Server \(EWS\)](#)
- [Configure IP network settings](#)
- [Printer security features](#)
- [Energy-conservation settings](#)
- [HP Web Jetadmin](#)
- [Software and firmware updates](#)

## For more information

The following information is correct at the time of publication.

For video assistance, see [www.hp.com/videos/LaserJet](http://www.hp.com/videos/LaserJet).

For current information, see [www.hp.com/support/ljE62655mfp](http://www.hp.com/support/ljE62655mfp), [www.hp.com/support/ljE62665mfp](http://www.hp.com/support/ljE62665mfp), or [www.hp.com/support/ljE62675mfp](http://www.hp.com/support/ljE62675mfp).

HP's all-inclusive help for the printer includes the following information:

- Install and configure
- Learn and use
- Solve problems
- Download software and firmware updates
- Join support forums
- Find warranty and regulatory information

# Advanced configuration with the HP Embedded Web Server (EWS)

- [Introduction](#)
- [How to access the HP Embedded Web Server \(EWS\)](#)
- [HP Embedded Web Server features](#)

## Introduction

Use the HP Embedded Web Server to manage printing functions from a computer instead of the printer control panel.

- View printer status information
- Determine the remaining life for all supplies and order new ones
- View and change tray configurations
- View and change the printer control-panel menu configuration
- View and print internal pages
- Receive notification of printer and supplies events
- View and change network configuration

The HP Embedded Web Server works when the printer is connected to an IP-based network. The HP Embedded Web Server does not support IPX-based printer connections. Internet access is not needed to open and use the HP Embedded Web Server.

When the printer is connected to the network, the HP Embedded Web Server is automatically available.



**NOTE:** The HP Embedded Web Server is not accessible beyond the network firewall.



To use the HP Embedded Web Server, the browser must meet the following requirements:

**Table 8-1** Browser requirements


Operating system	Browser
Windows® 7	Internet Explorer (version 8.x or greater)
	Google Chrome (version 34.x or greater)
	Firefox (version 20.x or greater)
Windows® 8 or greater	Internet Explorer (version 9.x or greater)
	Google Chrome (version 34.x or greater)
	Firefox (version 20.x or greater)
macOS	Safari (version 5.x or greater)
	Google Chrome (version 34.x or greater)
Linux	Google Chrome (version 34.x or greater)
	Firefox (version 20.x or greater)



## How to access the HP Embedded Web Server (EWS)

1. Find the printer IP address: From the Home screen on the printer control panel, select the Information  icon, and then select the Network  icon to display the IP address or host name.
2. Open a web browser, and in the address line, type the IP address or host name exactly as it displays on the printer control panel. Press the **Enter** key on the computer keyboard. The EWS opens.



 **NOTE:** If the web browser displays a message indicating that accessing the website might not be safe, select the option to continue to the website. Accessing this website will not harm the computer.

## HP Embedded Web Server features

- [Information tab](#)
- [General tab](#)
- [Copy/Print tab](#)
- [Scan/Digital Send tab](#)
- [Fax tab](#)
- [Supplies tab](#)
- [Troubleshooting tab](#)
- [Security tab](#)
- [HP Web Services tab](#)
- [Networking tab](#)
- [Other Links list](#)

## Information tab

Table 8-2 HP Embedded Web Server Information tab

Menu	Description
Device Status	Shows the printer status and shows the estimated life remaining of HP supplies. The page also shows the type and size of paper set for each tray. To change the default settings, click the <b>Change Settings</b> link.
Configuration Page	Shows the information found on the configuration page.
Supplies Status Page	Shows the status of the supplies for the printer.
Event Log Page	Shows a list of all printer events and errors. Use the <b>HP Instant Support</b> link (in the <b>Other Links</b> area on all HP Embedded Web Server pages) to connect to a set of dynamic web pages that help solve problems. These pages also show additional services available for the printer.
Usage Page	Shows a summary of the number of pages the printer has printed, grouped by size, type, and paper print path.
Device Information	Shows the printer network name, address, and model information. To customize these entries, click the <b>Device Information</b> menu on the <b>General</b> tab.

**Table 8-2** HP Embedded Web Server Information tab (continued)

Menu	Description
Control Panel Snapshot	Shows an image of the current screen on the control panel display.
Printable Reports and Pages	Lists the internal reports and pages for the printer. Select one or more items to print or view.
Open Source Licenses	Shows a summary of the licenses for open source software programs that can be used with the printer.

## General tab

**Table 8-3** HP Embedded Web Server General tab

Menu	Description
Control Panel Customization	Reorder, show, or hide features on the control-panel display.  Change the default display language and keyboard layouts.
Quick Sets	Configure jobs that are available in the <a href="#">Quick Sets</a> area of the Home screen on the printer control panel.
Alerts	Setup email alerts for various printer and supplies events.
Control Panel Settings App	Shows the Settings app options that are available on the printer control panel.
General Settings	Configure how the printer recovers from jams and other general printer settings.
AutoSend	Configure the printer to send automated emails regarding printer configuration and supplies to specific email addresses.
Edit Other Links	Add or customize a link to another website. This link displays in the footer area on all HP Embedded Web Server pages.
Ordering Information	Enter information about ordering replacement cartridges. This information displays on the supplies status page.
Device Information	Name the printer and assign an asset number to it. Enter the name of the primary contact who will receive information about the printer.
Language	Set the language in which to display the HP Embedded Web Server information.
Firmware Upgrade	Download and install printer firmware upgrade files.
Date/Time Settings	Set the date and time or synchronize with a network time server.
Energy Settings	Set or edit a wake time, sleep time, and sleep delay for the printer. Set a different schedule for each day of the week and for holidays.  Set which interactions with the printer cause it to wake from sleep mode.
Backup and Restore	Create a backup file that contains printer and user data. If necessary, use this file to restore data to the printer.
Reset Factory Settings	Restore printer settings to the factory defaults.
Solution Installer	Install third-party software packages that extend or modify the functionality of the printer.
Job Statistics Settings	Provides connection information about third-party job-statistics services.
Quota Settings	Provides connection information about third-party job-quota services.

## Copy/Print tab

Table 8-4 HP Embedded Web Server Copy/Print tab

Menu	Description
Print from USB Drive Settings	Enable or disable the <a href="#">Print from USB Drive</a> menu on the control panel.
Manage Stored Jobs	Enable or disable the ability to store jobs in the printer memory. Configure job-storage options.
Default Print Options	Configure the default options for print jobs.
Restrict Color (Color printers only)	Permit or restrict color printing and copying. Specify permissions for individual users or for jobs that are sent from specific software programs.
PCL and PostScript Settings	Adjust the PCL and PostScript settings for all print jobs, including copy jobs and received faxes.
Print Quality	Configure the print quality settings, including color adjustment, image registration, and allowed paper types.
Copy Settings	Configure the default options and Quick Sets for copy jobs.  <b>NOTE:</b> If job-specific copy setting options are not set from the control panel at the start of a job, the default settings will be used for the job.
Manage Trays	Configure settings for paper trays.

## Scan/Digital Send tab

Table 8-5 HP Embedded Web Server Scan/Digital Send tab

Menu	Description
Scan to Email Settings	Configure the default email settings for digital sending, including the following: <ul style="list-style-type: none"><li>• Settings for the outgoing mail (SMTP) server</li><li>• Settings for Email Quick Sets jobs</li><li>• Default message settings, such as the "From" address and the subject line</li><li>• Settings for digital signatures and encryption</li><li>• Settings for email notifications</li><li>• Default scan settings for email jobs</li><li>• Default file settings for email jobs</li></ul>
Scan to Network Folder Settings	Configure the network folder settings for digital sending, including the following: <ul style="list-style-type: none"><li>• Settings for Quick Sets jobs saved in a network folder</li><li>• Settings for notifications</li><li>• Default scan settings for jobs saved in a network folder</li><li>• Default file settings for jobs saved in a network folder</li></ul>

**Table 8-5 HP Embedded Web Server Scan/Digital Send tab (continued)**

Menu	Description
<b>Scan to SharePoint® Settings</b> (Flow models only)	Configure the Microsoft SharePoint® settings for digital sending, including the following: <ul style="list-style-type: none"> <li>• Settings for Quick Sets jobs saved in a document library on the SharePoint® site</li> <li>• Default settings for jobs saved in a document library on the SharePoint® site</li> </ul>
<b>Scan to USB Drive Settings</b>	Configure the USB settings for digital sending, including the following: <ul style="list-style-type: none"> <li>• Settings for Quick Sets jobs saved on a USB flash drive</li> <li>• Settings for notifications</li> <li>• Default scan settings for jobs saved on a USB flash drive</li> <li>• Default file settings for jobs saved on a USB flash drive</li> </ul>
<b>Contacts</b>	Manage contacts, including the following: <ul style="list-style-type: none"> <li>• Add email addresses into the printer one at a time.</li> <li>• Import a large list of frequently-used email addresses on to the printer all at once, rather than adding them one at a time.</li> <li>• Export contacts from the printer into a .CSV file on the computer to use as a data backup, or import the records onto another HP printer.</li> <li>• Edit email addresses that have already been saved in the printer.</li> </ul>
<b>Email and Scan to Network Folder Quick Setup Wizards</b>	Configure the printer to send scanned images as email attachments.  Configure the printer to save scanned images to network-folder Quick Sets. Quick Sets provide easy access to files saved on the network.
<b>Digital Sending Software Setup</b>	Configure settings related to using optional Digital Sending software.

## Fax tab

**Table 8-6 HP Embedded Web Server Fax tab**

Menu	Description
<b>Fax Send Setup</b>	Configure settings for sending faxes, including the following: <ul style="list-style-type: none"> <li>• Default settings for outgoing faxes</li> <li>• Settings for fax Quick Sets jobs</li> <li>• Settings for notifications</li> <li>• Default setting for sending faxes using the internal fax modem</li> <li>• Settings for using a LAN fax service</li> <li>• Settings for using an Internet fax service</li> </ul>
<b>Fax Speed Dials</b>	Manage speed dials, including the following: <ul style="list-style-type: none"> <li>• Import .CSV files containing email addresses, fax numbers, or user records, so that they can be accessed on this printer.</li> <li>• Export email, fax, or user records from the printer into a file on the computer to use as a data backup, or import the records onto another HP printer.</li> </ul>

**Table 8-6** HP Embedded Web Server Fax tab (continued)

Menu	Description
Fax Receive Setup	Configure default print options for incoming faxes, and set up a fax printing schedule.
Fax Archive and Forwarding	Enable or disable fax archiving and fax forwarding, and configure basic settings for each: <ul style="list-style-type: none"> <li>Fax archiving is a method to send a copy of all incoming and outgoing faxes to an email address, a network folder, or an FTP server.</li> <li>Fax forwarding is a method to forward incoming faxes to a different fax device.</li> </ul>
Fax Activity Log	Contains a list of the faxes that have been sent from or received by this printer.

## Supplies tab

**Table 8-7** HP Embedded Web Server Supplies tab

Menu	Description
Manage Supplies	Configure how the printer reacts when supplies reach a Very Low state.

## Troubleshooting tab

**Table 8-8** HP Embedded Web Server Troubleshooting tab

Menu	Description
General Troubleshooting	Select from a variety of reports and tests to help solve problems with the printer.
Online Help	Link to HP cloud-based online help to assist in troubleshooting printing issues.
Diagnostic Data	Export printer information to a file that can be useful for detailed problem analysis.
<b>NOTE:</b> This item is available only if an administrator password is set from the Security tab.	
Calibration/Cleaning (Color printers only)	Enable the automatic cleaning feature, create and print the cleaning page, and select an option to calibrate the printer immediately.
Reset Factory Settings	Reset printer settings to factory defaults.
Firmware Upgrade	Download and install printer firmware upgrade files.

## Security tab

Table 8-9 HP Embedded Web Server Security tab

Menu	Description
General Security	Settings for general security, including the following: <ul style="list-style-type: none"><li>• Configure an administrator password to restrict access to certain features on the printer.</li><li>• Set PJI password for processing PJI commands.</li><li>• Set file system access and firmware upgrade security.</li><li>• Enable or disable the Host USB port on the control panel or the USB connectivity port on the formatter for printing directly from a computer.</li><li>• View the status of all security settings.</li></ul>
Account Policy	Enable administrator account settings.
Access Control	Configure access to printer functions for specific individuals or groups, and select the method individuals use to sign in to the printer.
Protect Stored Data	Configure and manage the internal hard drive for the printer. This printer includes an encrypted hard drive for maximum security.  Configure settings for jobs that are stored on the printer hard drive.
Manage Remote Apps	Manage or whitelist remote apps by importing or deleting certificates that allow devices to use this product.
Certificate Management	Install and manage security certificates for access to the printer and the network.
Web Service Security	Allow resources on this printer to be accessed by web pages from different domains. If no sites are added to the list, then all sites are trusted.
Self Test	Verify that the security functions are running according to expected system parameters.

## HP Web Services tab

Use the **HP Web Services** tab to configure and enable HP Web Services for this printer. It is necessary to enable HP Web Services to use the HP ePrint feature.

Table 8-10 HP Embedded Web Server HP Web Services tab

Menu	Description
Web Services Setup	Connect this printer to HP's ePrintCenter on the web by enabling HP Web Services.
Web Proxy	Configure a proxy server if there are issues enabling HP Web Services or connecting the printer to the Internet.
HP JetAdvantage	Access solutions that extend the capabilities of the printer.
Smart Cloud Print	Enable Smart Cloud Print, which allows access to web-based apps that extend the capabilities of the printer.

## Networking tab

Use the **Networking** tab to configure and secure network settings for the printer when it is connected to an IP-based network. This tab does not display if the printer is connected to other types of networks.

**Table 8-11 HP Embedded Web Server Networking tab**

Menu	Description
<b>Configuration</b>	
Wi-Fi Direct	Configure Wi-Fi Direct settings for printers that include embedded Wi-Fi Direct Print and NFC printing or that have a wireless accessory installed.  <b>NOTE:</b> The configuration options available depend on the print server model.
TCP/IP Setting	Configure TCP/IP settings for IPv4 and IPv6 networks.  <b>NOTE:</b> The configuration options available depend on the print server model.
Network Settings	Configure IPX/SPX, AppleTalk, DLC/LLC, and SNMP settings, depending on the print server model.
Other Settings	Configure general printing protocols and services supported by the print server. The available options depend on the print server model, but can include firmware update, LPD queues, USB settings, support information, and refresh rate.
AirPrint	Enable, set up, or disable network printing from Apple supported printers.
Select Language	Change the language displayed by the HP Embedded Web Server. This page displays if the web pages support multiple languages. Optionally, select supported languages through language-preference settings in the browser.
Select Location	Select a country/region for the printer
<b>Google Cloud Print</b>	
Setup	Set up Google Cloud Print options.
Web Proxy	Configure proxy settings.
<b>Security</b>	
Settings	View and restore current security settings to factory-default values.  Configure security settings using the Security Configuration Wizard.  <b>NOTE:</b> Do not use the Security Configuration Wizard to configure security settings using network-management applications, such as HP Web Jetadmin.
Authorization	Control configuration management and use of this printer, including the following: <ul style="list-style-type: none"> <li>• Set or change the administrator password to control access to configuration parameters.</li> <li>• Request, install, and manage digital certificates on the HP Jetdirect print server.</li> <li>• Limit host access to this printer through an Access Control List (ACL) (for selected print servers on IPv4 networks only).</li> </ul>
Secure Communication	Configure security settings.

<b>Mgmt. Protocols</b>	Configure and manage security protocols for this printer, including the following: <ul style="list-style-type: none"> <li>• Set the security management level for the HP Embedded Web Server, and control traffic over HTTP and HTTPS.</li> <li>• Configure the SNMP (Simple Network Management Protocol) operation. Enable or disable the SNMP v1/v2c or SNMP v3 agents on the print server.</li> <li>• Control access through protocols that may not be secure, such as printing protocols, print services, discovery protocols, name resolution services, and configuration-management protocols.</li> </ul>
<b>802.1X Authentication</b>	Configure 802.1X authentication settings on the Jetdirect print server as required for client authentication on the network, and reset the 802.1X authentication settings to factory-default values. <p><b>CAUTION:</b> When changing the 802.1X authentication settings; the printer might lose its connection. To reconnect, it might be necessary to reset the print server to a factory-default state and reinstall the printer.</p>
<b>IPsec/Firewall</b>	View or configure a Firewall policy or an IPsec/Firewall policy (for selected HP Jetdirect models only).
<b>Announcement Agent</b>	Enable or disable the HP Device Announcement Agent, set the configuration server, and configure mutual authentication using certificates.
<b>Diagnostics</b>	
<b>Network Statistics</b>	Display network statistics that are collected and stored on the HP Jetdirect print server.
<b>Protocol Info</b>	View a list of network-configuration settings on the HP Jetdirect print server for each protocol.
<b>Configuration Page</b>	View the HP Jetdirect configuration page, which contains status and configuration information.

## Other Links list



**NOTE:** Configure which links display in the footer of the HP Embedded Web Server by using the **Edit Other Links** menu on the **General** tab. The following are the default links.

**Table 8-12** HP Embedded Web Server Other Links list

Menu	Description
<b>HP Instant Support</b>	Connect to the HP website to find solutions to printer problems.
<b>Shop for Supplies</b>	Connect to the HP SureSupply website for information on purchasing original HP supplies, such as cartridges and paper.
<b>Product Support</b>	Connect to the support site for the printer to search for help on various topics.



# Configure IP network settings



- [Printer sharing disclaimer](#)
- [View or change network settings](#)
- [Rename the printer on a network](#)
- [Manually configure IPv4 TCP/IP parameters from the control panel](#)
- [Manually configure IPv6 TCP/IP parameters from the control panel](#)
- [Link speed and duplex settings](#)

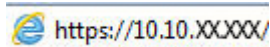
## Printer sharing disclaimer

HP does not support peer-to-peer networking, as the feature is a function of Microsoft operating systems and not of the HP printer drivers. Go to Microsoft at [www.microsoft.com](http://www.microsoft.com).

## View or change network settings

Use the HP Embedded Web Server to view or change IP configuration settings.

1. Find the printer IP address: From the Home screen on the printer control panel, select the Information  icon, and then select the Network  icon to display the IP address or host name.
2. Open a web browser, and in the address line, type the IP address or host name exactly as it displays on the printer control panel. Press the **Enter** key on the computer keyboard. The EWS opens.





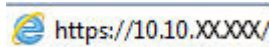
 **NOTE:** If the web browser displays a message indicating that accessing the website might not be safe, select the option to continue to the website. Accessing this website will not harm the computer.

3. Click the **Networking** tab to obtain network information. Change settings as needed.

## Rename the printer on a network

To rename the printer on a network so that it can be uniquely identified, use the HP Embedded Web Server.

1. Find the printer IP address: From the Home screen on the printer control panel, select the Information  icon, and then select the Network  icon to display the IP address or host name.
2. Open a web browser, and in the address line, type the IP address or host name exactly as it displays on the printer control panel. Press the **Enter** key on the computer keyboard. The EWS opens.



 **NOTE:** If the web browser displays a message indicating that accessing the website might not be safe, select the option to continue to the website. Accessing this website will not harm the computer.

3. Open the **General** tab.
4. On the **Device Information** page, the default printer name is in the **Device Name** field. You can change this name to uniquely identify this printer.



**NOTE:** Completing the other fields on this page is optional.

---

5. Click the **Apply** button to save the changes.

## Manually configure IPv4 TCP/IP parameters from the control panel

Use the control-panel [Settings](#) menus to manually set an IPv4 address, subnet mask, and default gateway.

1. From the Home screen on the printer control panel, navigate to the [Settings](#) application, and then select the [Settings](#) icon.
2. Open the following menus:
  - a. [Networking](#)
  - b. [Ethernet](#)
  - c. [TCP/IP](#)
  - d. [IPV 4 Settings](#)
  - e. [Config Method](#)
3. Select the [Manual](#) option, and then select [OK](#).
4. Open the [Manual Settings](#) menu.
5. Select the [IP Address](#), [Subnet Mask](#), or [Default Gateway](#) option.
6. Use the numeric keypad to enter the correct digits for the field, and then select [OK](#).  
Repeat the process for each field to be configured.

## Manually configure IPv6 TCP/IP parameters from the control panel

Use the control-panel [Settings](#) menus to manually set an IPv6 address.

1. From the Home screen on the printer control panel, navigate to the [Settings](#) application, and then select the [Settings](#) icon.
2. To enable manual configuration, open the following menus:
  - a. [Networking](#)
  - b. [Ethernet](#)
  - c. [TCP/IP](#)
  - d. [IPV6 Settings](#)
3. Select [Enable](#), select [On](#), and then select [OK](#).
4. Open the [Address](#) menu.
5. Open the [Manual Settings](#) menu, and then select [Address](#). Use the keypad to enter the address, and then select [OK](#).

## Link speed and duplex settings


---

 **NOTE:** This information applies only to Ethernet networks. It does not apply to wireless networks.

---

The link speed and communication mode of the print server must match the network hub. For most situations, leave the printer in automatic mode. Incorrect changes to the link speed and duplex settings might prevent the printer from communicating with other network devices. To make changes, use the printer control panel.

---

 **NOTE:** The printer setting must match the setting for the network device (a network hub, switch, gateway, router, or computer).

---

 **NOTE:** Making changes to these settings causes the printer to turn off and then on. Make changes only when the printer is idle.

---

1. From the Home screen on the printer control panel, navigate to the [Settings](#) application, and then select the [Settings](#) icon.
2. Open the following menus:
  - a. [Networking](#)
  - b. [Ethernet](#)
  - c. [Link Speed](#)
3. Select one of the following options:
  - [Auto](#): The print server automatically configures itself for the highest link speed and communication mode allowed on the network.
  - [10T Half](#): 10 megabytes per second (Mbps), half-duplex operation
  - [10T Full](#): 10 Mbps, full-duplex operation
  - [10T Auto](#): 10 Mbps, automatic-duplex operation
  - [100TX Half](#): 100 Mbps, half-duplex operation
  - [100TX Full](#): 100 Mbps, full-duplex operation
  - [100TX Auto](#): 100 Mbps, automatic-duplex operation
  - [1000T Full](#): 1000 Mbps, full-duplex operation
4. Select [OK](#). The printer turns off and then on.

# Printer security features

## Introduction

The printer includes several security features to restrict who has access to configuration settings, to secure data, and to prevent access to valuable hardware components.

- [Security statements](#)
- [IP Security](#)
- [Assign or change the system password using the HP Embedded Web Server](#)
- [Encryption support: HP High Performance Secure Hard Disks](#)
- [Lock the formatter](#)

## Security statements

The printer supports security standards and recommended protocols that help you keep the printer secure, protect critical information on your network, and simplify the way you monitor and maintain the printer.



## IP Security

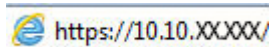
IP Security (IPsec) is a set of protocols that control IP-based network traffic to and from the printer. IPsec provides host-to-host authentication, data integrity, and encryption of network communications.

For printers that are connected to the network and have an HP Jetdirect print server, you can configure IPsec by using the **Networking** tab in the HP Embedded Web Server.

## Assign or change the system password using the HP Embedded Web Server

Assign an administrator password for access to the printer and the HP Embedded Web Server so that unauthorized users cannot change the printer settings.

1. Open the HP Embedded Web Server (EWS):
  - a. From the Home screen on the printer control panel, touch the Information  icon, and then touch the Network  icon to display the IP address or host name.
  - b. Open a web browser, and in the address line, type the IP address or host name exactly as it displays on the printer control panel. Press the **Enter** key on the computer keyboard. The EWS opens.



 **NOTE:** If the web browser displays a message indicating that accessing the website might not be safe, select the option to continue to the website. Accessing this website will not harm the computer.


2. Click the **Security** tab.
3. Open the **General Security** menu.
4. In the area labeled **Set the Local Administrator Password**, enter the name to associate with the password in the **Username** field.
5. Enter the password in the **New Password** field, and then enter it again in the **Verify Password** field.

---

 **NOTE:** To change an existing password, first enter the existing password in the **Old Password** field.

---

6. Click the **Apply** button.

 **NOTE:** Make note of the password and store it in a safe place. The administrator password cannot be recovered. If the administrator password is lost or forgotten, contact HP Support at [support.hp.com](https://support.hp.com) for the assistance required to completely reset the printer.

---

Some features on the printer control panel can be secured so that unauthorized people cannot use them. When a feature is secured, the printer prompts you to sign in before you can use it. You can also sign in without waiting for a prompt by selecting [Sign In](#) from the printer control panel.

Typically, the credentials for signing in to the printer are the same as for signing in to the network. Consult the network administrator for this printer if you have questions about which credentials to use.

1. From the Home screen on the printer control panel, select [Sign In](#).
2. Follow the prompts to enter the credentials.

---

 **NOTE:** To maintain security for the printer, select [Sign Out](#) when you have finished using the printer.

---

## Encryption support: HP High Performance Secure Hard Disks

The hard disk provides hardware-based encryption so you can securely store sensitive data without impacting printer performance. This hard disk uses the latest Advanced Encryption Standard (AES) and has versatile time-saving features and robust functionality.

Use the **Security** menu in the HP Embedded Web Server to configure the disk.

## Lock the formatter

The formatter has a slot that you can use to attach a security cable. Locking the formatter prevents someone from removing valuable components from it.

# Energy-conservation settings

## Introduction

- [Print with EconoMode](#)
- [Set the sleep timer and configure the printer to use 1 watt or less of power](#)
- [Set the sleep schedule](#)

Configure sleep settings to reduce power usage when the printer is idle.

## Print with EconoMode

This printer has an EconoMode option for printing drafts of documents. Using EconoMode can use less toner. However, using EconoMode can also reduce print quality.

HP does not recommend the full-time use of EconoMode. If EconoMode is used full-time, the toner supply might outlast the mechanical parts in the toner cartridge. If print quality begins to degrade and is no longer acceptable, consider replacing the toner cartridge.



---

**NOTE:** If this option is not available in the print driver, set it using the printer control panel.

---

### Configure EconoMode from the print driver

1. From the software program, select the **Print** option.
2. Select the printer, and then click the **Properties** or **Preferences** button.
3. Click the **Paper/Quality** tab.
4. Click the **EconoMode** check box to enable the feature, and then click **OK**.

### Configure EconoMode from the printer control panel

1. From the Home screen on the printer control panel, navigate to the [Settings](#) application, and then select the [Settings](#) icon.
2. Open the following menus:
  - a. [Copy/Print](#) or [Print](#)
  - b. [Default Print Options](#)
  - c. [Economode](#)
3. Select [On](#) or [Off](#) to enable or disable the feature.


## Set the sleep timer and configure the printer to use 1 watt or less of power

The sleep settings affect how much power the printer uses, the wake/sleep time, how quickly the printer enters sleep mode, and how quickly the printer wakes up from sleep mode.

To configure the printer to use 1 watt or less of power while in sleep mode, enter times for both the Sleep after Inactivity and Auto Off after sleep settings.

1. From the Home screen on the printer control panel, navigate to the [Settings](#) application, and then select the [Settings](#) icon.
2. Open the following menus:
  - a. [General Settings](#)
  - b. [Energy Settings](#)
  - c. [Sleep Settings](#)
3. Select [Sleep after Inactivity](#) to specify the number of minutes the printer is inactive before it enters sleep mode. Enter the appropriate time period.


---

 **NOTE:** The sleep-mode default time is 0 minutes. Zero (0) indicates that the printer will go to sleep in less than 1 minute.

---

4. Select [Auto Off after sleep](#) to put the printer into a deeper power save mode after a period of sleep. Enter the appropriate time period.

---

 **NOTE:** By default, the printer will wake from Auto Off in response to any activity other than USB or Wi-Fi. For greater energy settings, you can set it to wake only to the power button by selecting [Shut down \(wake on power button only\)](#).

---

5. Select [Done](#) to save the settings.

## Set the sleep schedule

Use the [Sleep Schedule](#) feature to configure the printer to automatically wake or go into Sleep mode at specific times on specific days of the week.

1. From the Home screen on the printer control panel, navigate to the [Settings](#) application, and then select the [Settings](#) icon.
2. Open the following menus:
  - a. [General](#)
  - b. [Energy Settings](#)
  - c. [Sleep Schedule](#)
3. Select the [New Event](#) button, and then select the type of event to schedule: [Wake Event](#) or [Sleep Event](#).
4. For a wake or sleep event, configure the time and the days of the week for the event. Select [Save](#) to save the setting.

## HP Web Jetadmin

HP Web Jetadmin is an award-winning, industry-leading tool for efficiently managing a wide variety of networked HP products, including printers, multifunction printers, and digital senders. This single solution allows you to remotely install, monitor, maintain, troubleshoot, and secure your printing and imaging environment — ultimately increasing business productivity by helping you save time, control costs, and protect your investment.

HP Web Jetadmin upgrades are periodically made available to provide support for specific product features. Go to [www.hp.com/go/webjetadmin](http://www.hp.com/go/webjetadmin) for more information.



## Software and firmware updates

HP regularly updates software and firmware to fix any issues and to add features. To take advantage of the most current updates, download the most recent driver file, firmware file, or both from the Web.

Go to [www.hp.com/support/ljE62655mfp](http://www.hp.com/support/ljE62655mfp), [www.hp.com/support/ljE62665mfp](http://www.hp.com/support/ljE62665mfp), or [www.hp.com/support/ljE62675mfp](http://www.hp.com/support/ljE62675mfp). Click **Software and Drivers**.



---

# 9 Solve problems

- [Customer support](#)
- [Control panel help system](#)
- [Reset factory settings](#)
- [A “Cartridge is low” or “Cartridge is very low” message displays on the printer control panel](#)
- [Printer does not pick up paper or misfeeds](#)
- [Clear paper jams](#)
- [Resolve print-quality problems](#)
- [Improve copy image quality](#)
- [Improve scan image quality](#)
- [Improve fax image quality](#)
- [Solve fax problems](#)

## For more information

The following information is correct at the time of publication.

For video assistance, see [www.hp.com/videos/LaserJet](http://www.hp.com/videos/LaserJet).

For current information, see [www.hp.com/support/ljE62655mfp](http://www.hp.com/support/ljE62655mfp), [www.hp.com/support/ljE62665mfp](http://www.hp.com/support/ljE62665mfp), or [www.hp.com/support/ljE62675mfp](http://www.hp.com/support/ljE62675mfp).

HP's all-inclusive help for the printer includes the following information:


- Install and configure
- Learn and use
- Solve problems
- Download software and firmware updates
- Join support forums
- Find warranty and regulatory information

# Customer support

Table 9-1 Customer support options

Support type	Contact information
Get telephone support for your country/region Have the printer name, serial number, date of purchase, and problem description ready	Country/region phone numbers are on the flyer that was in the box with the printer or at <a href="http://support.hp.com">support.hp.com</a> .
Get 24-hour Internet support, and download software utilities and drivers	<a href="http://www.hp.com/support/ljE62655mfp">www.hp.com/support/ljE62655mfp</a> , <a href="http://www.hp.com/support/ljE62665mfp">www.hp.com/support/ljE62665mfp</a> , or <a href="http://www.hp.com/support/ljE62675mfp">www.hp.com/support/ljE62675mfp</a>
Order additional HP service or maintenance agreements	<a href="http://www.hp.com/go/carepack">www.hp.com/go/carepack</a>
Register the printer	<a href="http://www.register.hp.com">www.register.hp.com</a>


## Control panel help system

The printer has a built-in Help system that explains how to use each screen. To open the Help system, select the Help  button in the upper-right corner of the screen.



For some screens, the Help opens to a global menu where you can search for specific topics. You can browse through the menu structure by touching the buttons in the menu.

Some Help screens include animations that show specific procedures, such as clearing paper jams.


If the printer alerts of an error or warning, touch the Help  button to open a message that describes the problem. The message also contains instructions to help solve the problem.

# Reset factory settings

## Introduction

Use one of the following methods to restore the printer to the original settings from the factory.

---

 **NOTE:** Restoring factory settings sets most of the printer settings to their factory defaults. However, some settings are not changed, such as language, date, time, and some network configuration settings.

---

## Method one: Reset factory settings from the printer control panel

1. From the Home screen on the printer control panel, navigate to the [Settings](#) application, and then select the [Settings](#) icon.
2. Open the following menus:
  - a. [General](#)
  - b. [Reset Factory Settings](#)
3. Select [Reset](#).

A verification message advises that completing the reset function might result in loss of data.



4. Select [Reset](#) to complete the process.

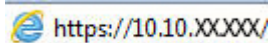
---

 **NOTE:** The printer restarts automatically after the reset operation completes.

---

## Method two: Reset factory settings from the HP Embedded Web Server (network-connected printers only)

1. Find the printer IP address: From the Home screen on the printer control panel, select the Information  icon, and then select the Network  icon to display the IP address or host name.
2. Open a web browser, and in the address line, type the IP address or host name exactly as it displays on the printer control panel. Press the [Enter](#) key on the computer keyboard. The EWS opens.



---

 **NOTE:** If the web browser displays a message indicating that accessing the website might not be safe, select the option to continue to the website. Accessing this website will not harm the computer.

---

3. Open the **General** tab.
4. On the left side of the screen, click **Reset Factory Settings**.
5. Click the **Reset** button.

---

 **NOTE:** The printer restarts automatically after the reset operation completes.

---

## A “Cartridge is low” or “Cartridge is very low” message displays on the printer control panel

### Cartridge is low

The printer indicates when a toner cartridge level is low. Actual toner cartridge life remaining may vary. Consider having a replacement available to install when print quality is no longer acceptable. The toner cartridge does not need to be replaced now, and the cartridge access door remains locked until the cartridge reaches **Very Low** status.

### Cartridge is very low

The printer indicates when a toner cartridge level is very low. In addition, the front door of the printer unlocks so that the door can be opened to replace the cartridge. Actual toner cartridge life remaining may vary. Consider having a replacement available to install when print quality is no longer acceptable. The toner cartridge does not need to be replaced now unless the print quality is no longer acceptable.

Once an HP toner cartridge has reached **Very Low**, HP's Premium Protection Warranty on that toner cartridge has ended.

# Printer does not pick up paper or misfeeds

## Introduction

The following solutions can help solve problems if the printer is not picking up paper from the tray or is picking up multiple sheets of paper at one time. Either of these situations can result in paper jams.

- [The printer does not pick up paper](#)
- [The printer picks up multiple sheets of paper](#)
- [The document feeder jams, skews, or picks up multiple sheets of paper](#)

## The printer does not pick up paper


If the printer does not pick up paper from the tray, try these solutions.

1. Open the printer and remove any jammed sheets of paper. Verify that no torn remnants of paper remain inside the printer.
2. Load the tray with the correct size of paper for the job.
3. Make sure the paper size and type are set correctly on the printer control panel.



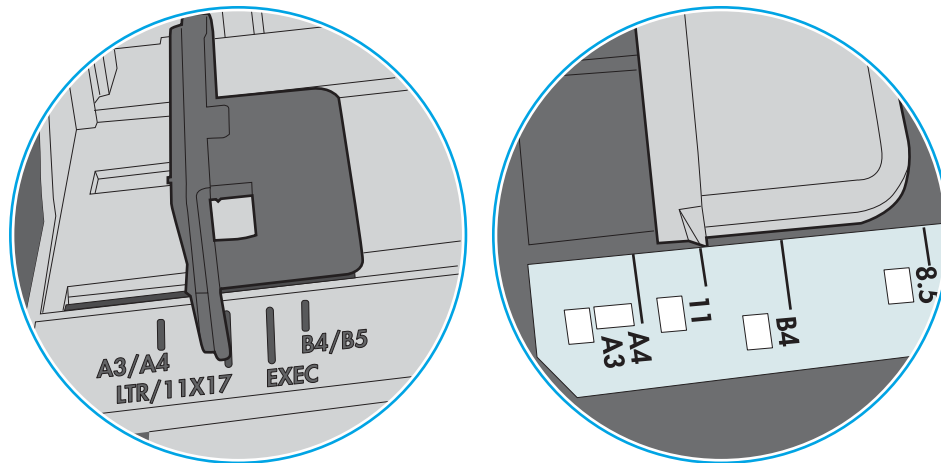
4. Make sure the paper guides in the tray are adjusted correctly for the size of paper. Adjust the guides to the appropriate indentation in the tray. The arrow on the tray guide should line up exactly with the marking on the tray.

 **NOTE:** Do not adjust the paper guides tightly against the paper stack. Adjust them to the indentations or markings in the tray.

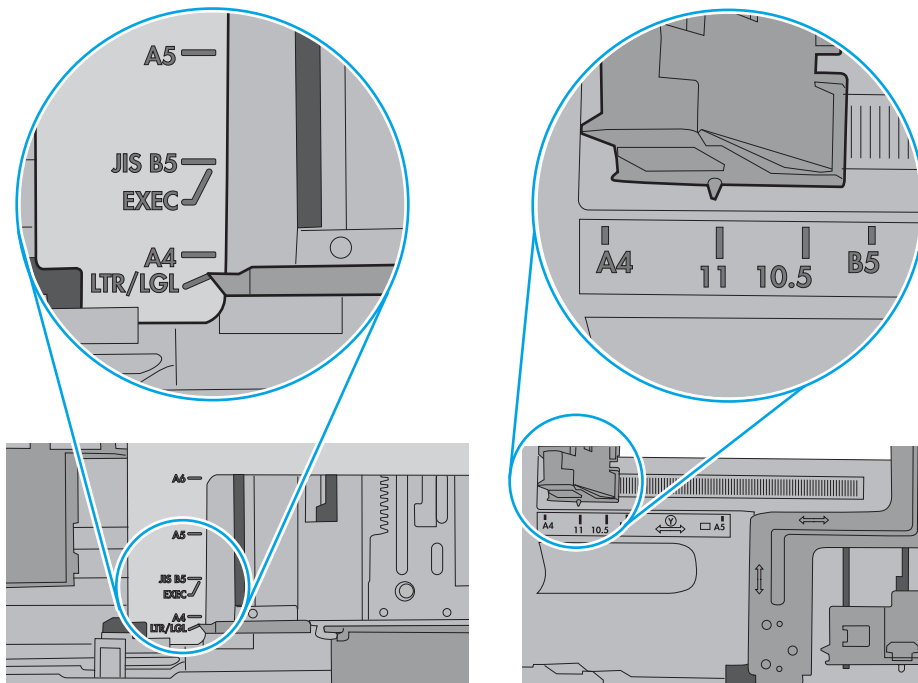
 **NOTE:** If the managed service provider has installed locking tray guides, these may not be adjustable. Contact the managed service representative for more information on locking or unlocking of paper trays.

The following images show examples of the paper-size indentations in the trays for various printers. Most HP printers have markings similar to these.

**Figure 9-1** Size markings for Tray 1 or the multipurpose tray



**Figure 9-2** Size markings for cassette trays

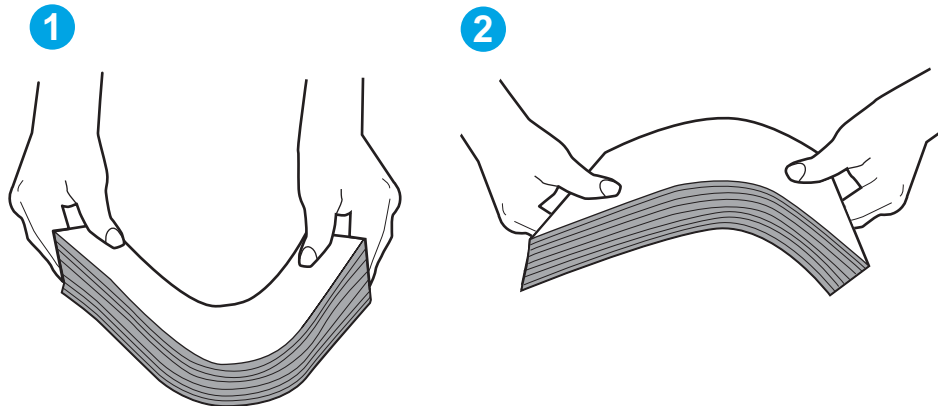


5. Verify that the humidity in the room is within specifications for this printer and that paper is being stored in unopened packages. Most reams of paper are sold in moisture-proof wrapping to keep paper dry.

In high-humidity environments, paper at the top of the stack in the tray can absorb moisture, and it might have a wavy or uneven appearance. If this happens, remove the top 5 to 10 sheets of paper from the stack.

In low-humidity environments, excess static electricity can cause sheets of paper to stick together. If this happens, remove the paper from the tray, and flex the stack by holding it at each end and bringing the ends up to form a U shape. Then, rotate the ends down to reverse the U shape. Next, hold each side of the stack of paper, and repeat this process. This process releases individual sheets without introducing static electricity. Straighten the paper stack against a table before returning it to the tray.

**Figure 9-3** Technique for flexing the paper stack



6. Check the printer control panel to see if it is displaying a prompt to feed the paper manually. Load paper, and continue.
7. The rollers above the tray might be contaminated. Clean the rollers with a lint-free cloth dampened with warm water. Use distilled water, if it is available.

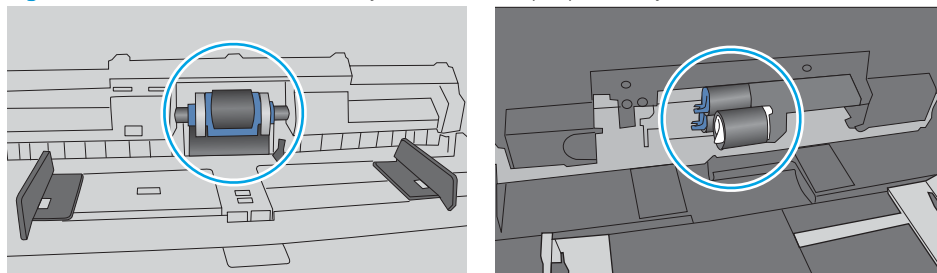
---

**CAUTION:** Do not spray water directly on to the printer. Instead, spray water on the cloth or dab the cloth in water and wring it out before cleaning the rollers.

---

The following image shows examples of the roller location for various printers.

**Figure 9-4** Roller locations for Tray 1 or the multipurpose tray




## The printer picks up multiple sheets of paper

If the printer picks up multiple sheets of paper from the tray, try these solutions.

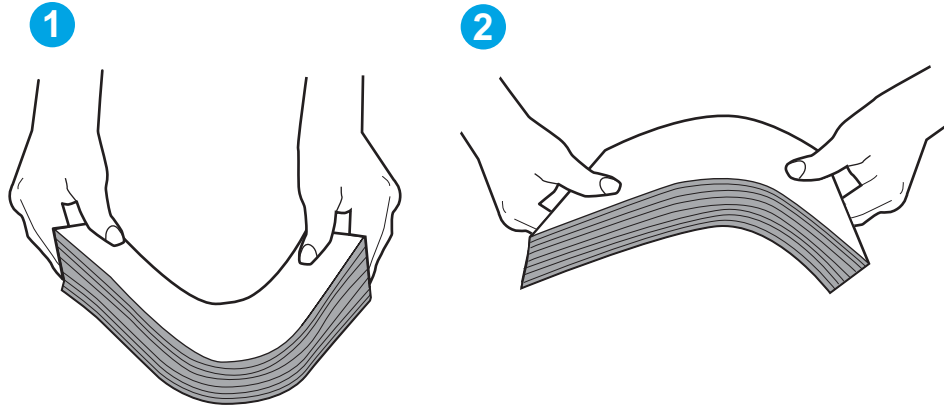
1. Remove the stack of paper from the tray and flex it, rotate it 180 degrees, and flip it over. *Do not fan the paper.* Return the stack of paper to the tray.

---

 **NOTE:** Fanning the paper introduces static electricity. Instead of fanning the paper, flex the stack by holding it at each end and bringing the ends up to form a U shape. Then, rotate the ends down to reverse the U shape. Next, hold each side of the stack of paper, and repeat this process. This process releases individual sheets without introducing static electricity. Straighten the paper stack against a table before returning it to the tray.

---

**Figure 9-5** Technique for flexing the paper stack



2. Use only paper that meets HP specifications for this printer.
3. Verify that the humidity in the room is within specifications for this printer, and that paper is being stored in unopened packages. Most reams of paper are sold in moisture-proof wrapping to keep paper dry.  

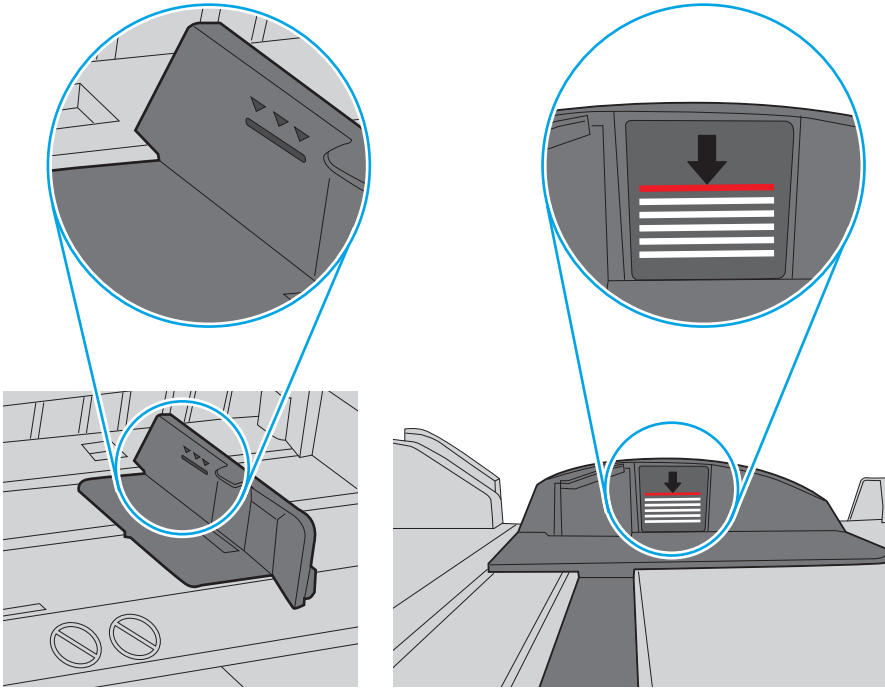
In high-humidity environments, paper at the top of the stack in the tray can absorb moisture, and it might have a wavy or uneven appearance. If this happens, remove the top 5 to 10 sheets of paper from the stack.

In low-humidity environments, excess static electricity can cause sheets of paper to stick together. If this happens, remove the paper from the tray, and flex the stack as described above.
4. Use paper that is not wrinkled, folded, or damaged. If necessary, use paper from a different package.

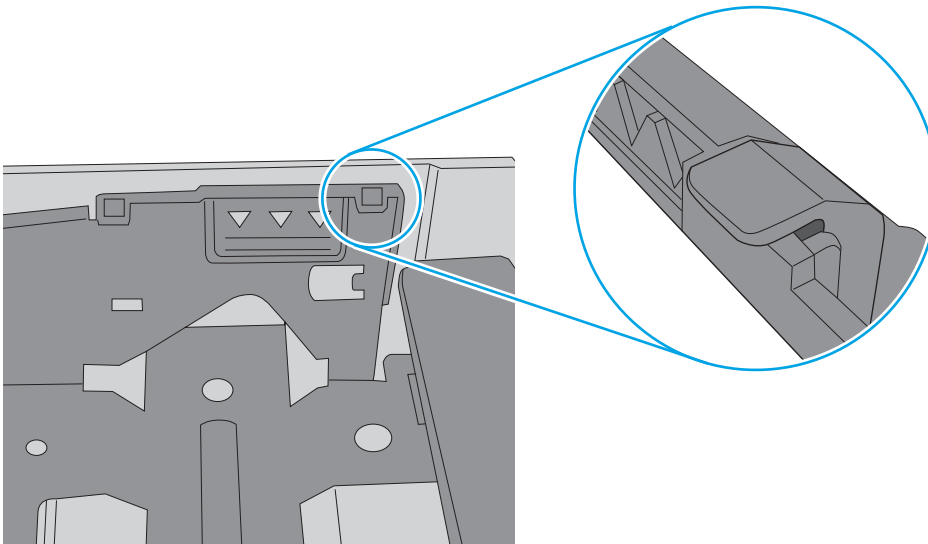
5. Make sure the tray is not overfilled by checking the stack-height markings inside the tray. If it is overfilled, remove the entire stack of paper from the tray, straighten the stack, and then return some of the paper to the tray.

The following images show examples of the stack-height markings in the trays for various printers. Most HP printers have markings similar to these. Also make sure that all sheets of paper are below the tabs near the stack-height marks. These tabs help hold the paper in the correct position as it enters the printer.

**Figure 9-6** Stack-height markings



**Figure 9-7** Tab for the paper stack

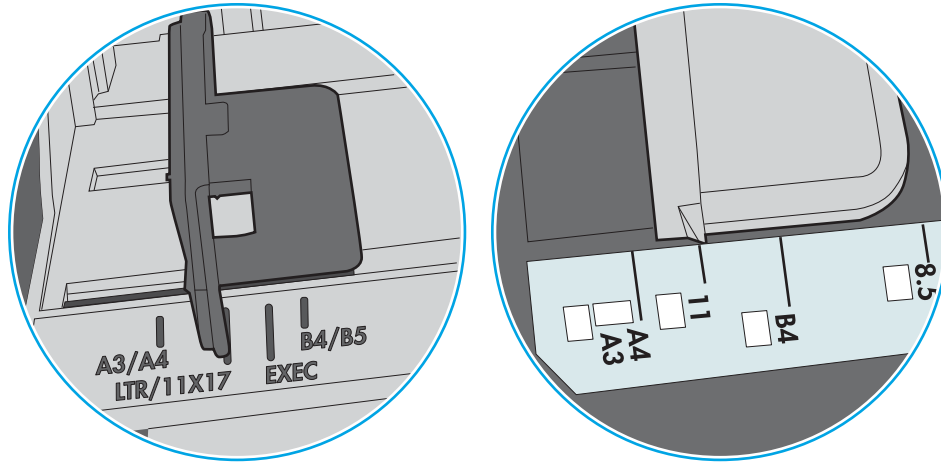


6. Make sure the paper guides in the tray are adjusted correctly for the size of paper. Adjust the guides to the appropriate indentation in the tray. The arrow on the tray guide should line up exactly with the marking on the tray.

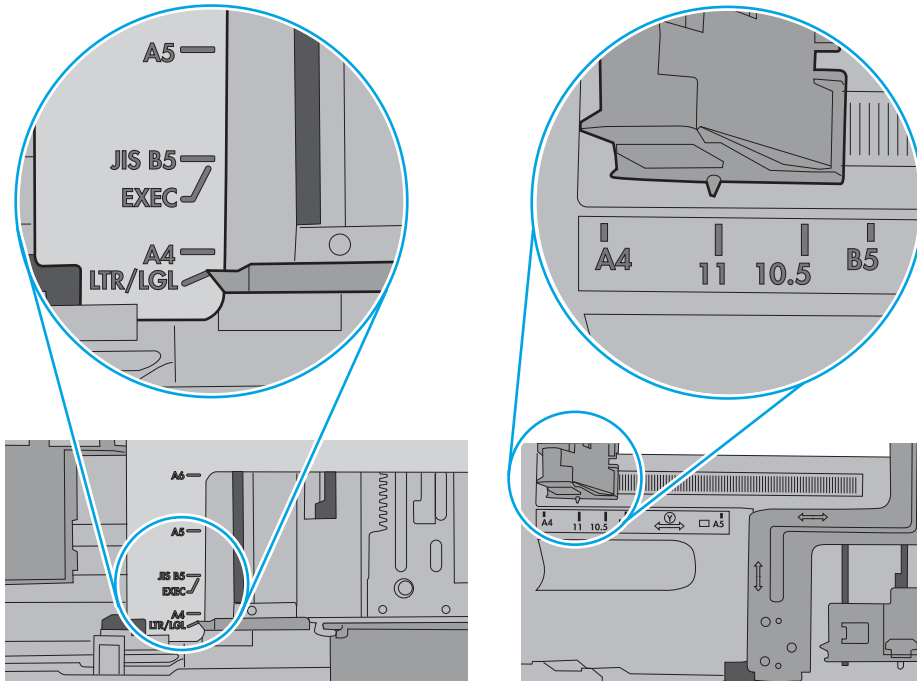
 **NOTE:** Do not adjust the paper guides tightly against the paper stack. Adjust them to the indentations or markings in the tray.

The following images show examples of the paper-size indentations in the trays for various printers. Most HP printers have markings similar to these.

**Figure 9-8** Size markings for Tray 1 or the multipurpose tray



**Figure 9-9** Size markings for cassette trays



7. Make sure the printing environment is within recommended specifications.

## The document feeder jams, skews, or picks up multiple sheets of paper



**NOTE:** This information applies to MFP printers only.

---

- The original might have something on it, such as staples or self-adhesive notes, that must be removed.
- Check that all rollers are in place and that the roller-access cover inside the document feeder is closed.
- Make sure that the top document-feeder cover is closed.
- The pages might not be placed correctly. Straighten the pages and adjust the paper guides to center the stack.
- The paper guides must be touching the sides of the paper stack to work correctly. Make sure that the paper stack is straight and the guides are against the paper stack.
- The document feeder input tray or output bin might contain more than the maximum number of pages. Make sure the paper stack fits below the guides in the input tray, and remove pages from the output bin.
- Verify that there are no pieces of paper, staples, paper clips, or other debris in the paper path.
- Clean the document-feeder rollers and the separation pad. Use compressed air or a clean, lint-free cloth moistened with warm water. If misfeeds still occur, replace the rollers.
- From the Home screen on the printer control panel, scroll to and touch the [Supplies](#) button. Check the status of the document-feeder kit, and replace it if necessary.

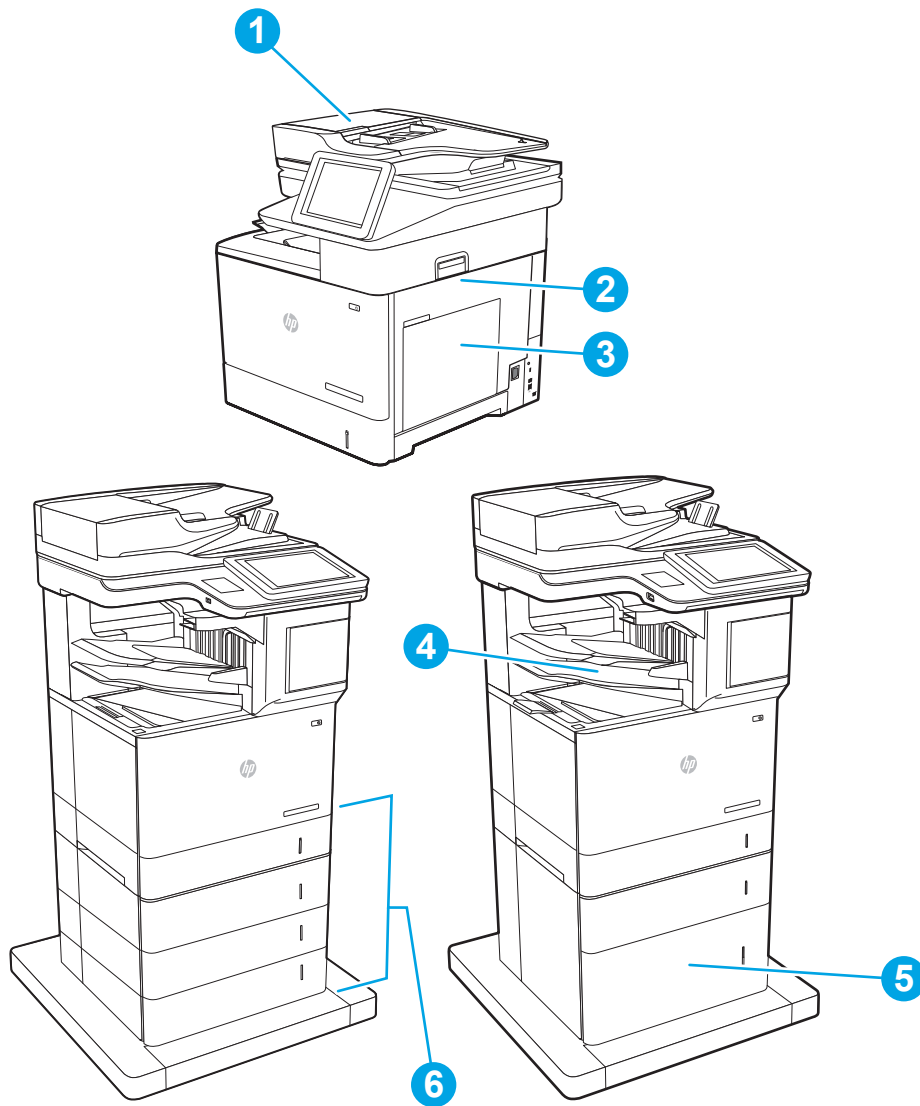
# Clear paper jams

## Introduction

The following information includes instructions for clearing paper jams from the printer.

- [Paper jam locations](#)
- [Auto-navigation for clearing paper jams](#)
- [Experiencing frequent or recurring paper jams?](#)
- [Clear paper jams in the document feeder \(31.13\)](#)
- [Clear paper jams in Tray 1 \(13.A1\)](#)
- [Clear paper jams in Trays 2, 3, 4, 5 \(13.A2, 13.A3, 13.A4, 13.A5\)](#)
- [Clear paper jams in the 2,100-sheet high-capacity input tray \(13.A, 13.F\)](#)
- [Clear paper jams in the right door and fuser area \(13.B9, 13.B2, 13.FF\)](#)
- [Clear paper jams in the output bin \(13.E1\)](#)
- [Clear paper jams in the duplexer \(13.C, 13.D, 13.B\)](#)
- [Clear paper jams in the envelope feeder \(13.A\)](#)
- [Clear paper jams in the HP 900-sheet 3-bin Stapling Mailbox \(13.E, 13.7\)](#)
- [Clear staple jams \(13.8\)](#)

## Paper jam locations



1	Document feeder
2	Duplexer and fuser
3	Tray 1
4	Output bin, HP Stapling Mailbox
5	2,100-sheet HCl feeder
6	Trays 2-5 Envelope feeder (not shown)



## Auto-navigation for clearing paper jams

The auto-navigation feature assists in clearing jams by providing step-by-step instructions on the control panel. When you complete a step, the printer displays instructions for the next step until you have completed all steps in the procedure.

## Experiencing frequent or recurring paper jams?

To reduce the number of paper jams, try these solutions.

- Use only paper that meets HP specifications for this printer.
- Use paper that is not wrinkled, folded, or damaged. If necessary, use paper from a different package.
- Use paper that has not previously been printed or copied on.
- Make sure the tray is not overfilled. If it is, remove the entire stack of paper from the tray, straighten the stack, and then return some of the paper to the tray.
- Make sure the paper guides in the tray are adjusted correctly for the size of paper. Adjust the guides so they are touching the paper stack without bending it.
- Make sure that the tray is fully inserted in the printer.
- If you are printing on heavy, embossed, or perforated paper, use the manual feed feature and feed sheets one at a time.
- Open the [Trays](#) menu on the printer control panel. Verify that the tray is configured correctly for the paper type and size.
- Make sure the printing environment is within recommended specifications.



**NOTE:** Checking the paper and loading it into the tray correctly can help reduce paper jams. For additional help, [view a video demonstration of loading paper](#).

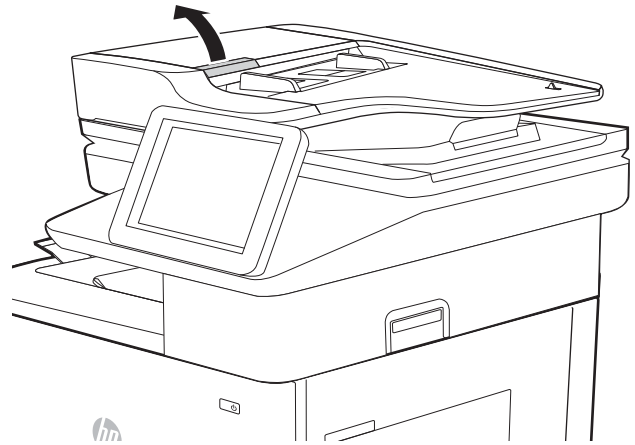
---

## Clear paper jams in the document feeder (31.13)

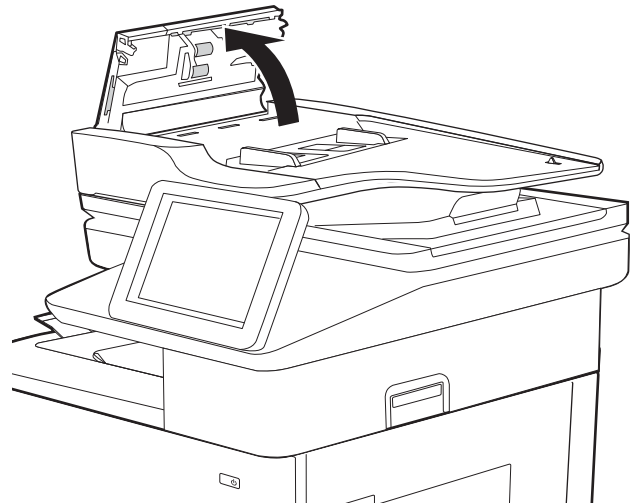
The following information describes how to clear paper jams in the document feeder. When a jam occurs, the control panel displays the following message and an animation that assists in clearing the jam.

- **31.13.XX Jam in Document Feeder**

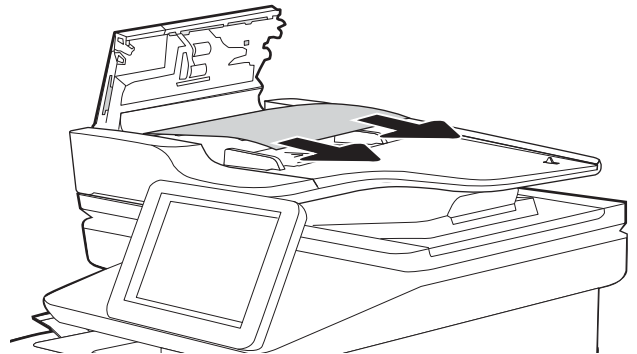
1. Lift the latch to release the document-feeder cover.



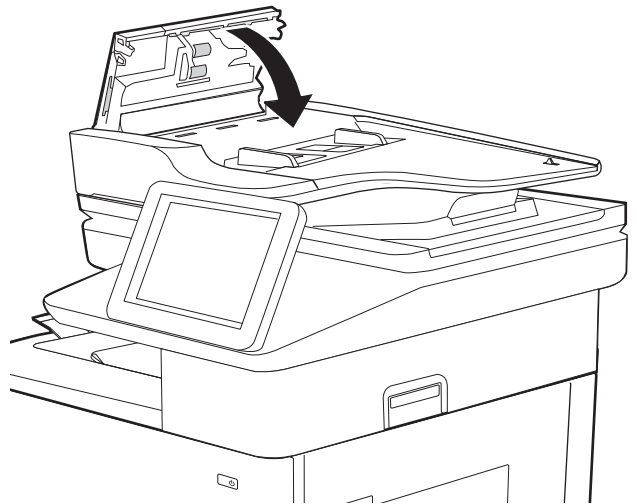
2. Open the document-feeder cover.




3. Remove any jammed paper.




4. Close the document-feeder cover.



---

 **NOTE:** To avoid jams, make sure the guides in the document-feeder input tray are adjusted tightly against the document. Remove all staples and paper clips from original documents.

 **NOTE:** Original documents that are printed on heavy, glossy paper can jam more frequently than originals that are printed on plain paper.

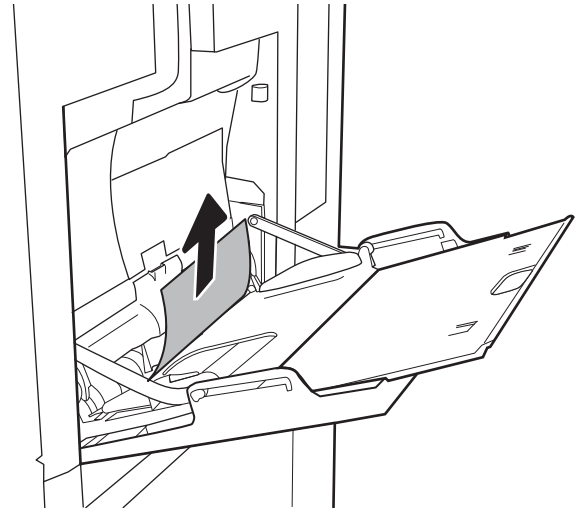
---

## Clear paper jams in Tray 1 (13.A1)

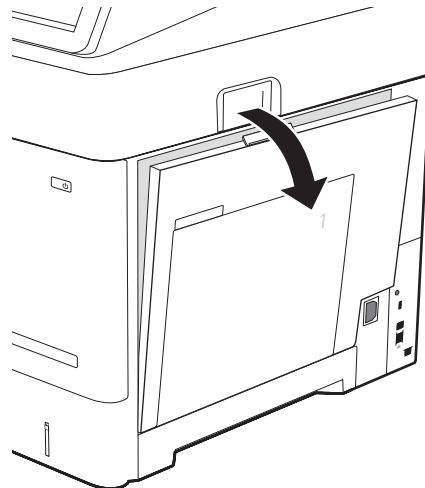
The following information describes how to clear a paper jam in Tray 1. When a jam occurs, the control panel displays the following message and an animation that assists in clearing the jam.

- 13.A1.XX Jam in Tray 1

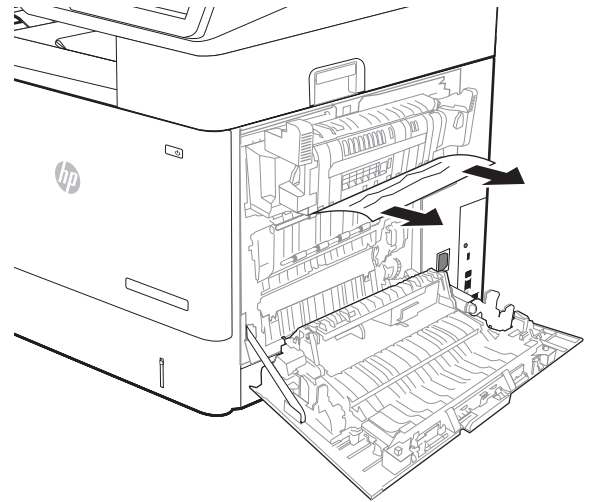
1. If jammed paper is visible in Tray 1, clear the jam by gently pulling the paper straight out.



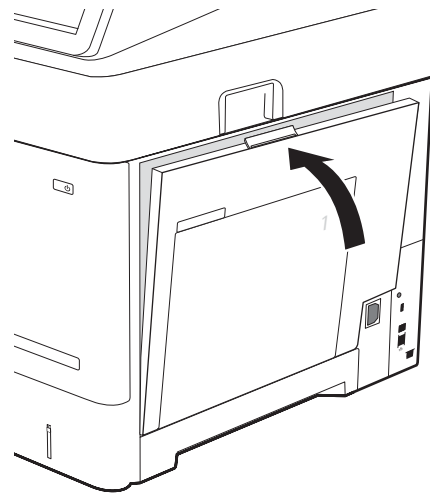
2. If you cannot remove the paper, or if no jammed paper is visible in Tray 1, close Tray 1 and open the right door.



3. Gently pull out any jammed paper.



4. Close the right door.



## Clear paper jams in Trays 2, 3, 4, 5 (13.A2, 13.A3, 13.A4, 13.A5)

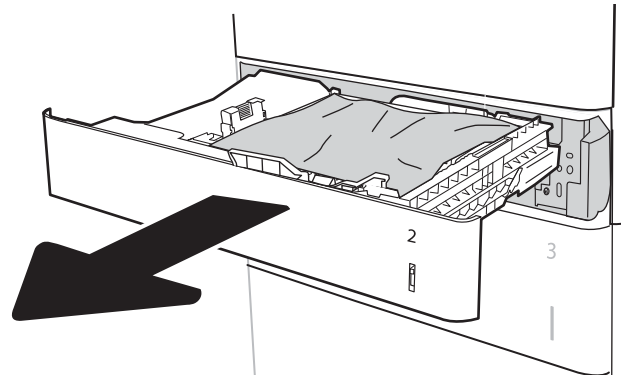
The following information describes how to clear a paper jam in Trays 2, 3, 4, or 5. When a jam occurs, the control panel displays one of the following messages and an animation that assists in clearing the jam.

- 13.A2.XX Jam in Tray 2
- 13.A3.XX Jam in Tray 3
- 13.A4.XX Jam in Tray 4
- 13.A5.XX Jam in Tray 5

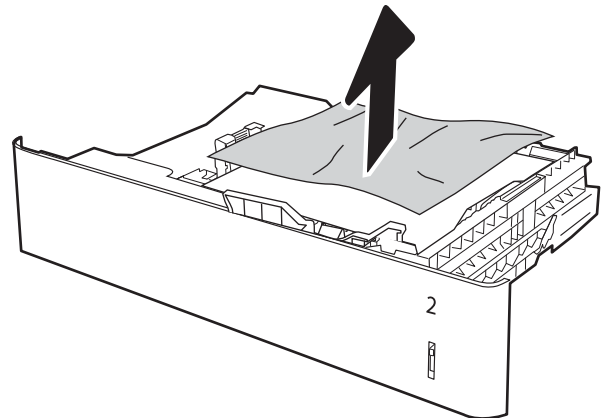


**NOTE:** The following procedure shows Tray 2. The method to clear jams in Trays 3, 4, and 5 is the same.

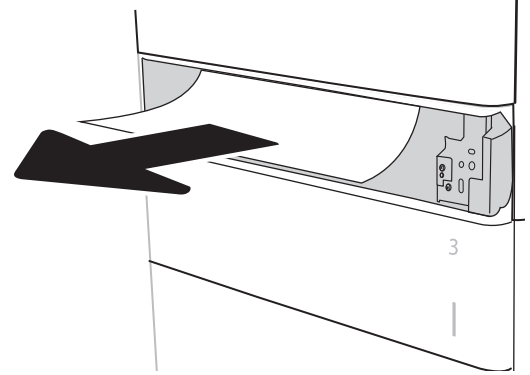
1. Pull the tray completely out of the printer by pulling and lifting it up slightly.



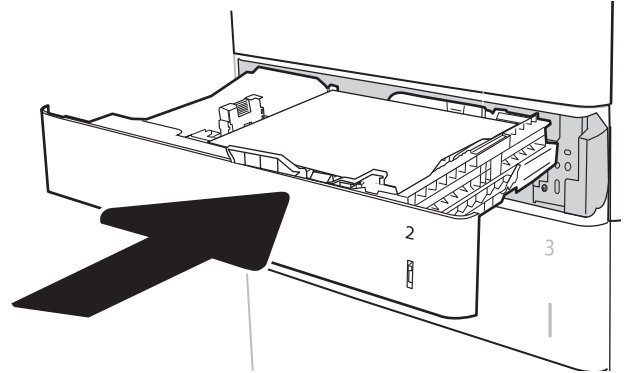
2. Remove any jammed or damaged sheets of paper from the tray.



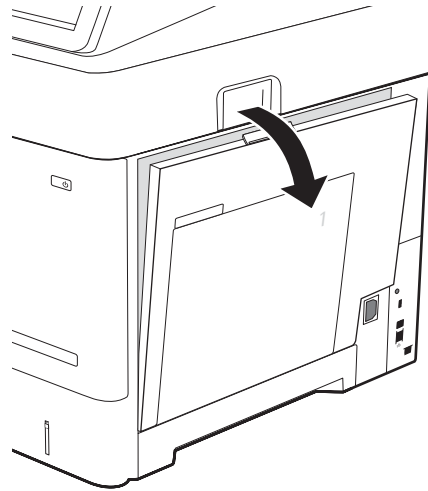
3. Remove any paper from the feed rollers inside the printer.



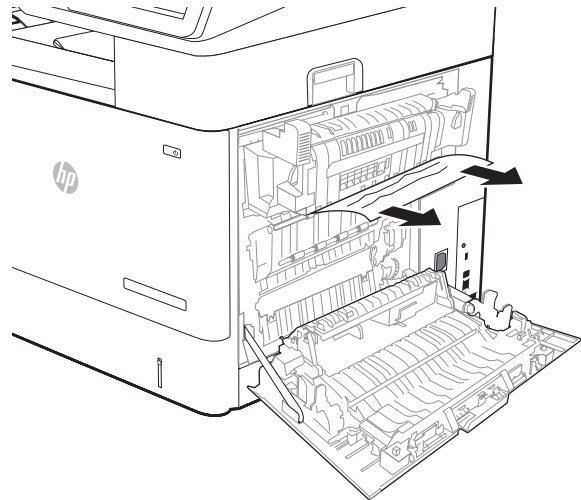
4. Reinsert and close the tray.



5. Open the right door.



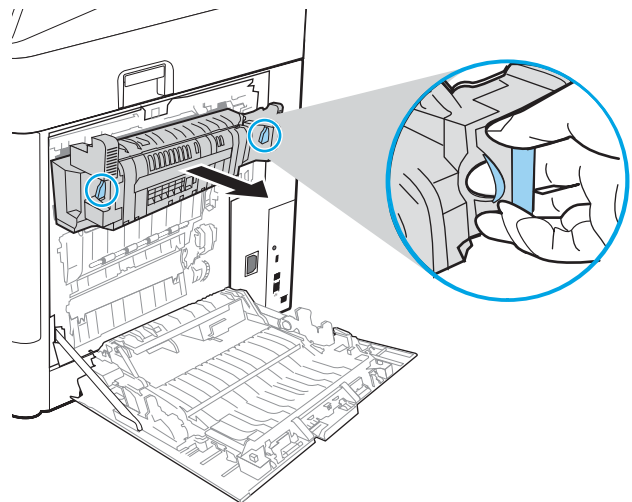
6. Remove any jammed paper.



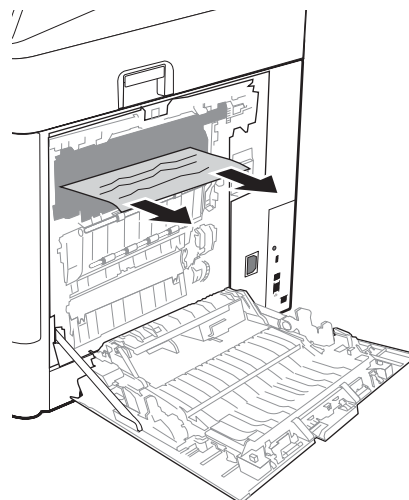
7. Remove the fuser by grabbing the two side latches and pulling the fuser straight out of the printer.



**CAUTION:** The fuser can be hot while the printer is in use. Wait for the fuser to cool before handling it.

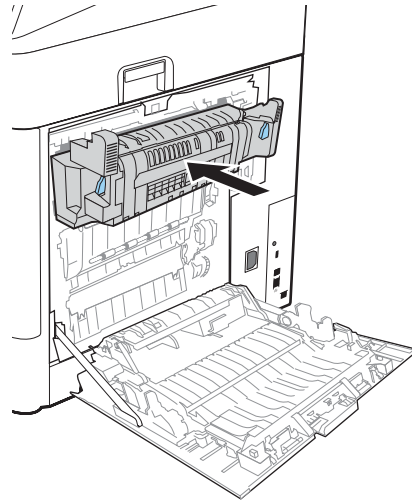


8. Remove any jammed paper from the fuser opening.

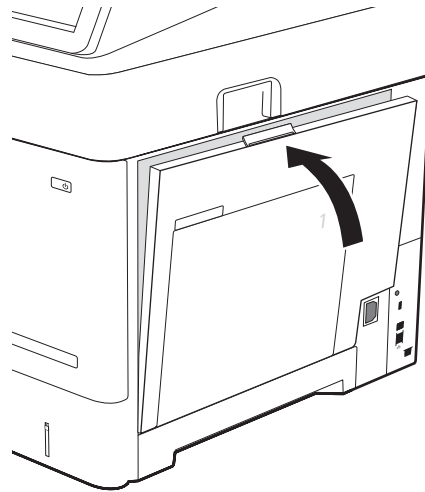




9. Reinstall the fuser.



10. Close the right door.

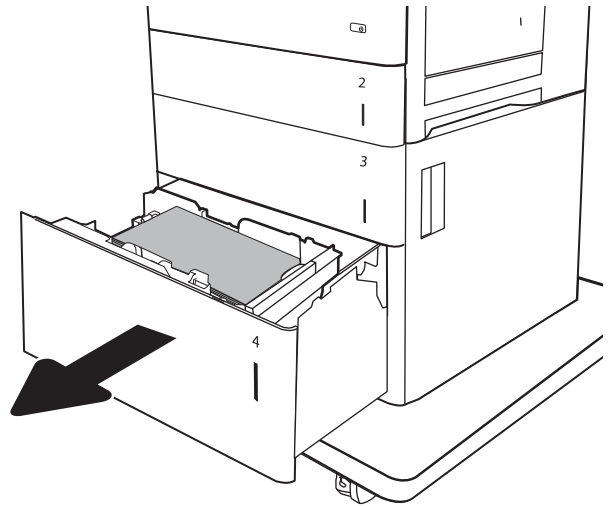


## Clear paper jams in the 2,100-sheet high-capacity input tray (13.A, 13.F)

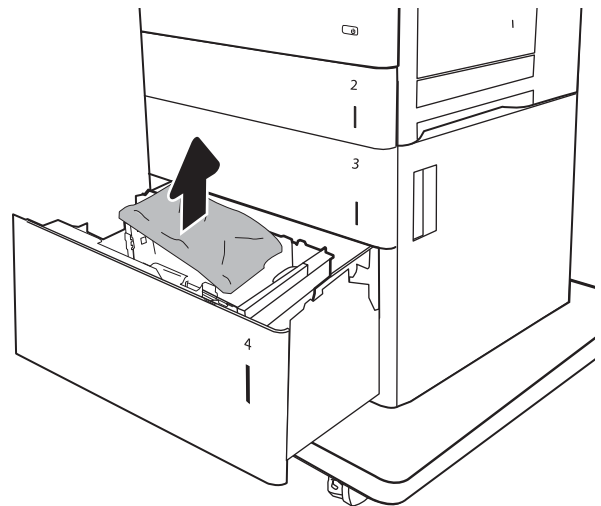
The following information describes how to clear a paper jam in the 2,100-sheet high-capacity tray. When a jam occurs, the control panel displays one of the following messages and an animation that assists in clearing the jam.

- **13.AY.XX Jam in Tray Y**, where Y equals the tray number assigned to the HCI
- **13.FF.EE Door Open Jam**

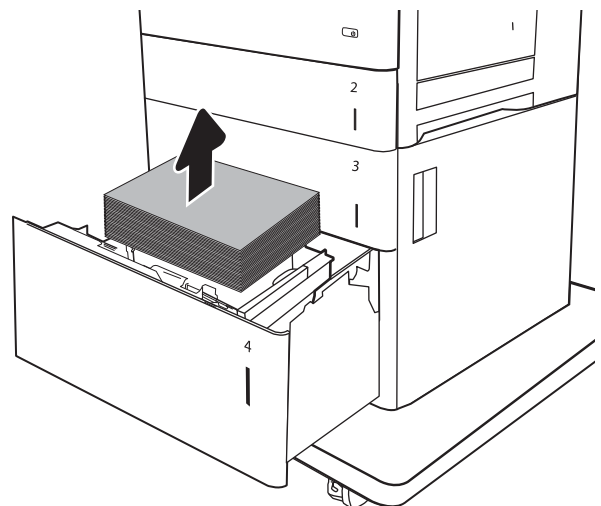
1. Open the 2,100-sheet high-capacity input tray.



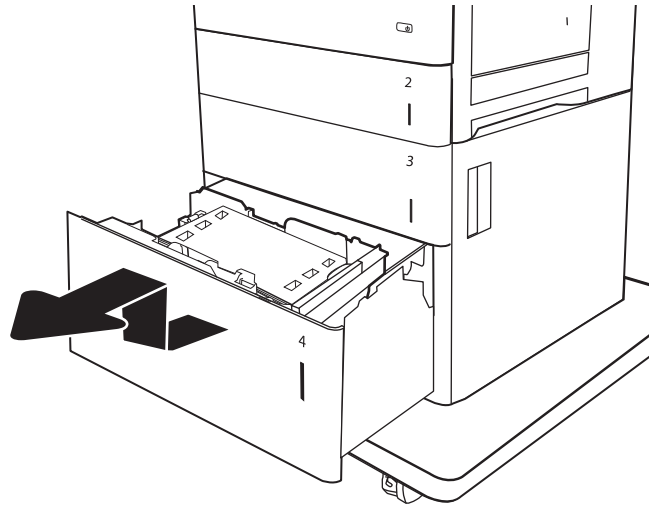
2. Remove and discard any damaged sheets.



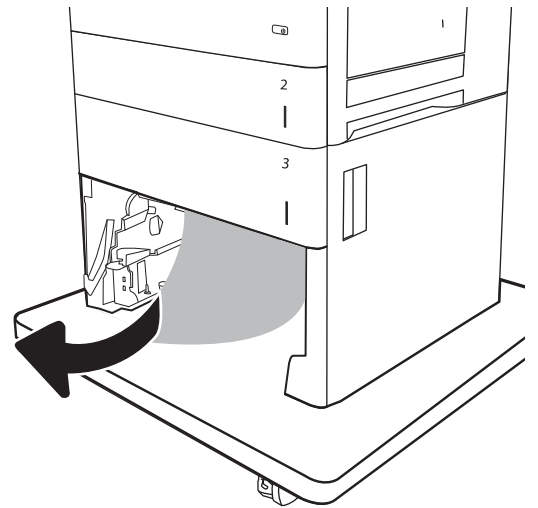
3. Remove the paper from the tray.



4. Lift the tray up and then pull it straight out to remove it.

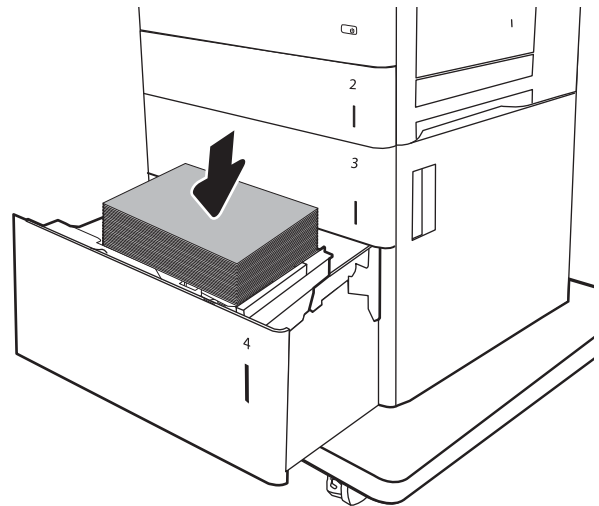


5. If jammed paper is in the feed area, pull it down to remove it.

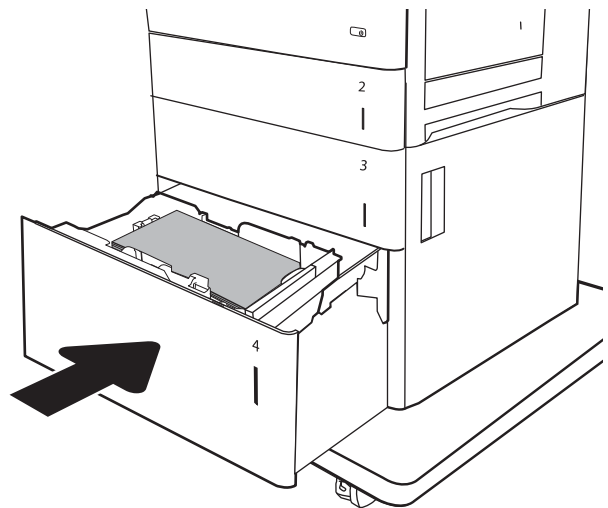


6. Reinstall the tray, and then load full reams of paper into the tray. The tray holds 2,100 sheets of paper.

**NOTE:** For best results, load full reams of paper. Avoid dividing reams into smaller sections.



7. Close the tray.



## Clear paper jams in the right door and fuser area (13.B9, 13.B2, 13.FF)

Use the following procedure to clear paper jams in the right door, duplexer, and fuser area. When a jam occurs, the control panel displays one of the following messages and an animation that assists in clearing the jam.

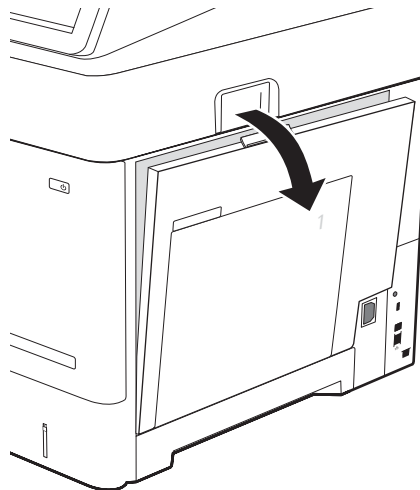
- 13.B2.XX Jam in <cover or door>
- 13.B9.XX Jam in Fuser
- 13.FF.EE Door Open Jam

---

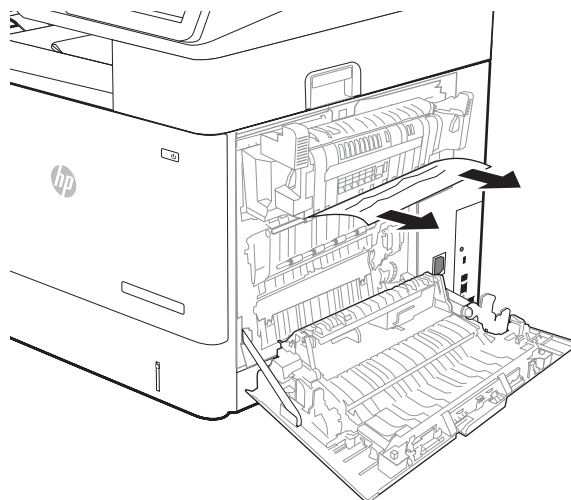
**CAUTION:** The fuser is hot while the printer is in use. Wait for the fuser to cool before clearing jams.

---

1. Open the right door.



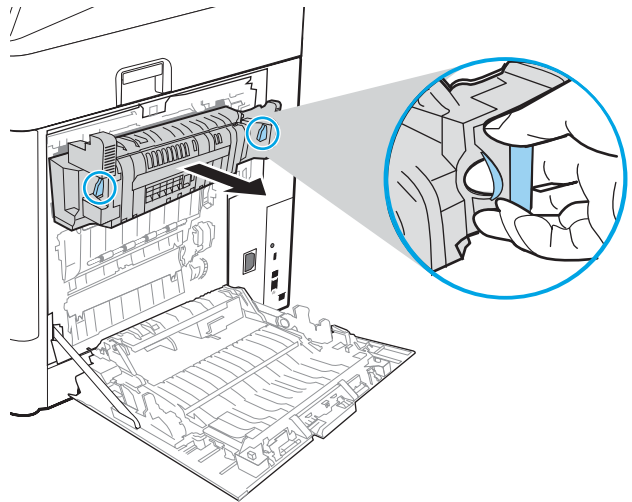
2. Remove any jammed paper.



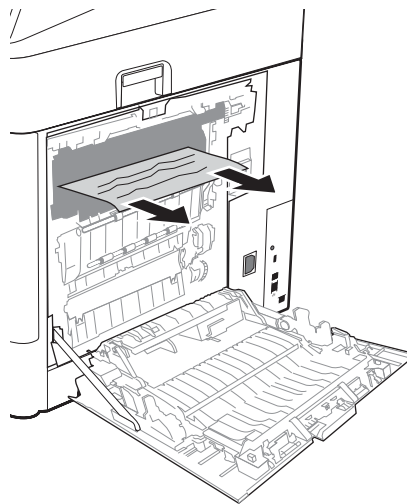
3. Remove the fuser by grabbing the two side latches and pulling the fuser straight out of the printer.



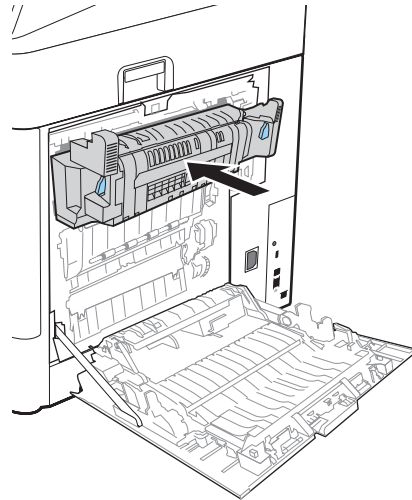
**CAUTION:** The fuser can be hot while the printer is in use. Wait for the fuser to cool before handling it.



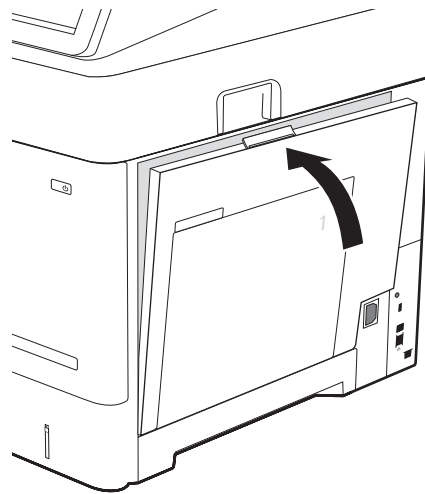
4. Remove any jammed paper from the fuser opening.



5. Reinstall the fuser.



6. Close the right door.

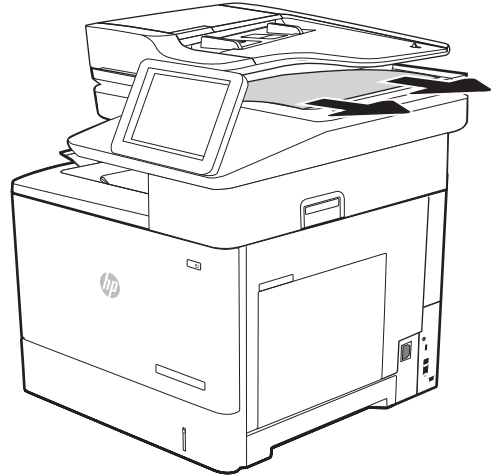


## Clear paper jams in the output bin (13.E1)

The following information describes how to clear a paper jam in the output bin. When a jam occurs, the control panel displays the following message and an animation that assists in clearing the jam.

- 13.E1.XX Jam at Standard Output Bin

1. If paper is visible in the output bin, grasp the leading edge and remove it.

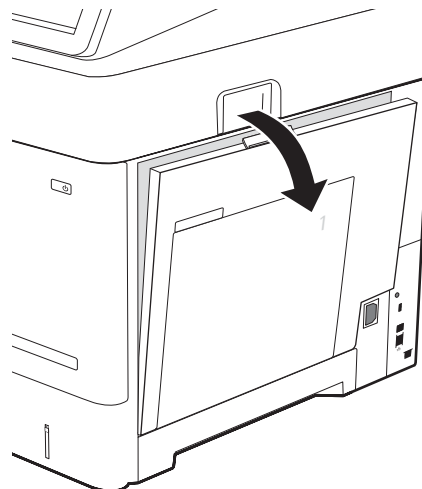


## Clear paper jams in the duplexer (13.C, 13.D, 13.B)

Use the following procedure to check for paper in all possible jam locations in the automatic duplexer. When a jam occurs, the control panel displays one of the following error messages and an animation that assists in clearing the jam.

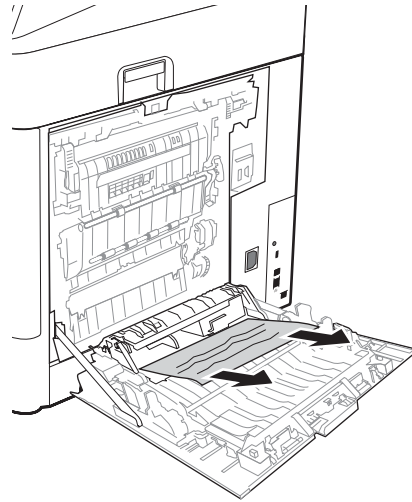
- 13.B2.XX Jam in <cover or door>
- 13.CX.XX Jam in Duplexer
- 13.DX.XX Jam in Duplexer

1. Open the right door.

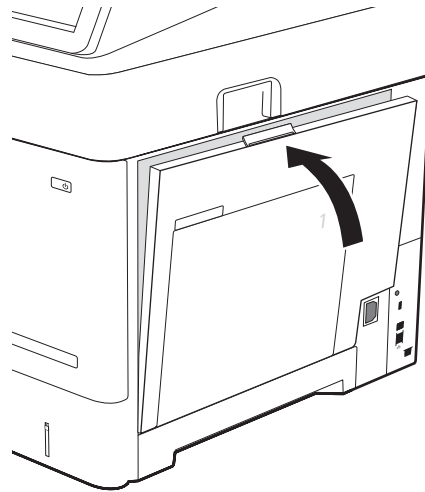




2. Remove any jammed paper.



3. Close the right door

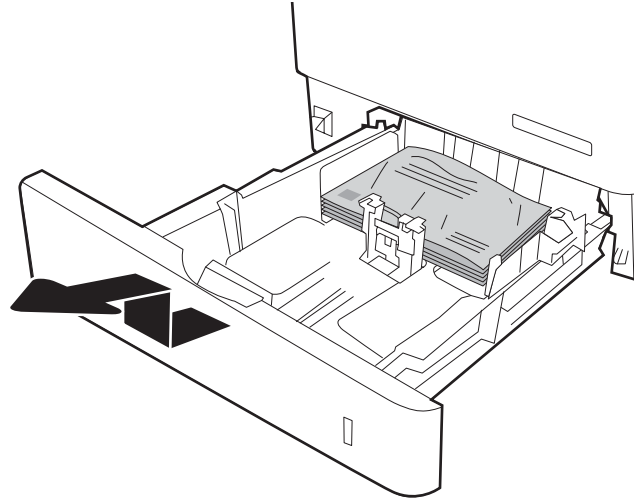


## Clear paper jams in the envelope feeder (13.A)

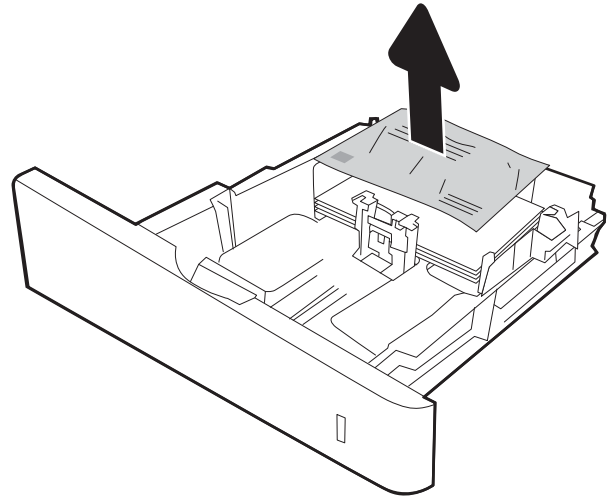
Use the following procedure to clear jams in the envelope feeder. When a jam occurs, the control panel displays one of the following messages and an animation that assists in clearing the jam.

- 13.A3.XX Jam in Tray 3
- 13.A4.XX Jam in Tray 4

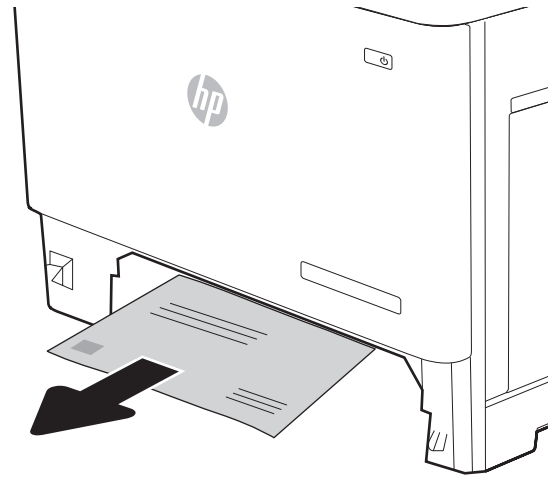
1. Pull the tray completely out of the printer by pulling and lifting it up slightly.



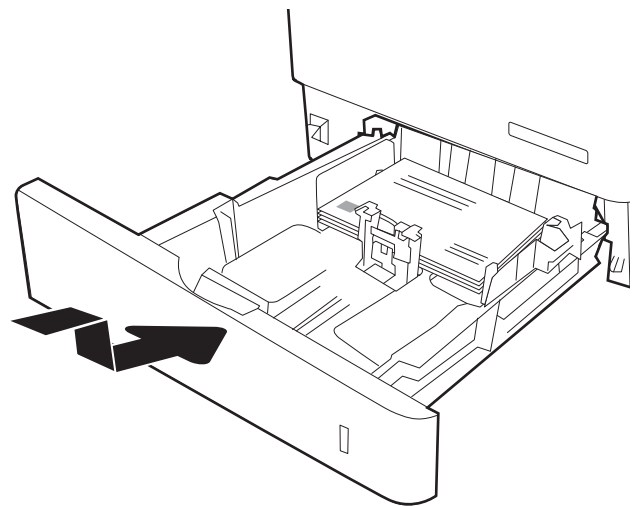
2. Remove any jammed or damaged envelopes from the tray.



3. Remove any envelopes from the feed rollers inside the printer.



4. Reinsert and close the tray.

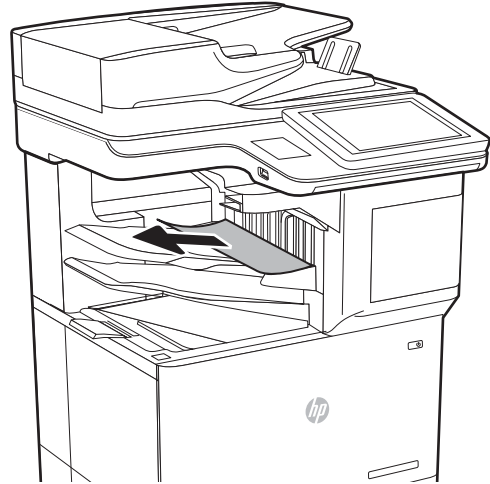


## Clear paper jams in the HP 900-sheet 3-bin Stapling Mailbox (13.E, 13.7)

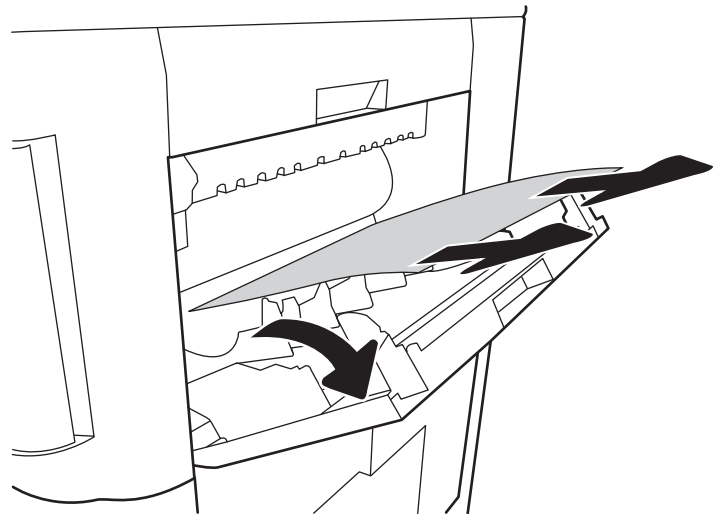
The following information describes how to clear a paper jam in the stapling mailbox. When a jam occurs, the control panel displays one of the following error messages and an animation that assists in clearing the jam.

- 13.E1.XX – Jam at Standard Output Bin
- 13.70.XX – MBM Jam

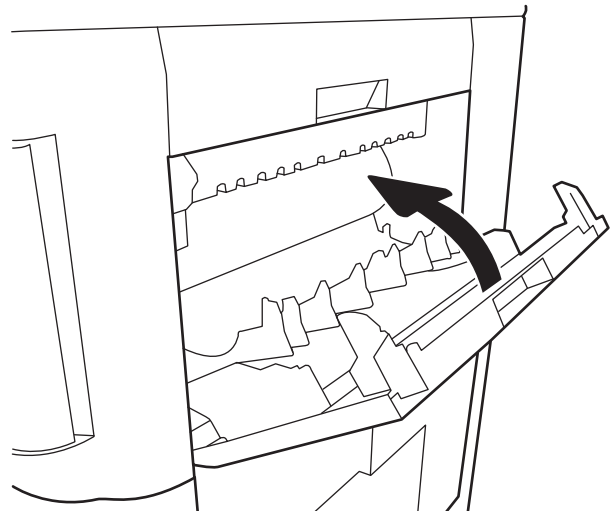
1. Remove any jammed paper from the bins.



2. Open the jam-access door on the back side of the stapling mailbox. If jammed paper is visible inside the jam-access door, pull it straight out to remove it.



3. Close the stapling mailbox jam access door.

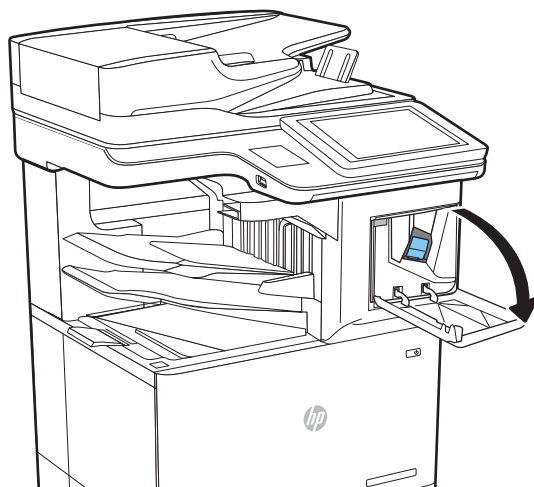


## Clear staple jams (13.8)

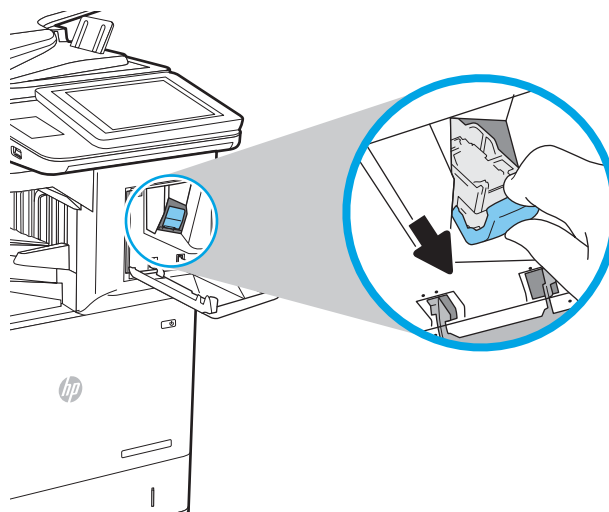
The following information describes how to clear a staple jam in the HP 900-sheet 3-bin Stapling Mailbox. When a jam occurs, the control panel displays an animation that assists in clearing the jam.

- **13.8X.XX – Stapler/Stacker Jam**

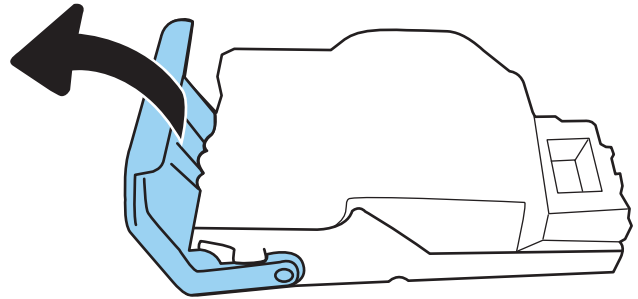
1. Open the stapler door.



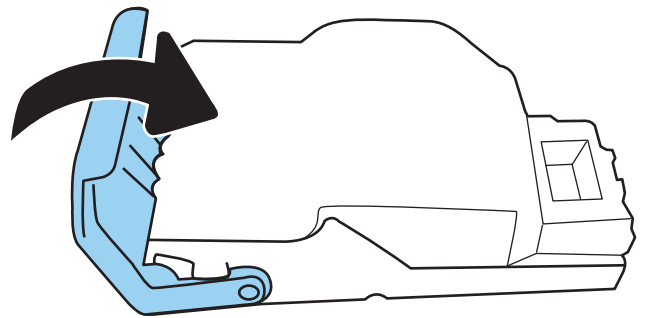
2. Pull the colored handle on the staple cartridge, and then pull the staple cartridge straight out.



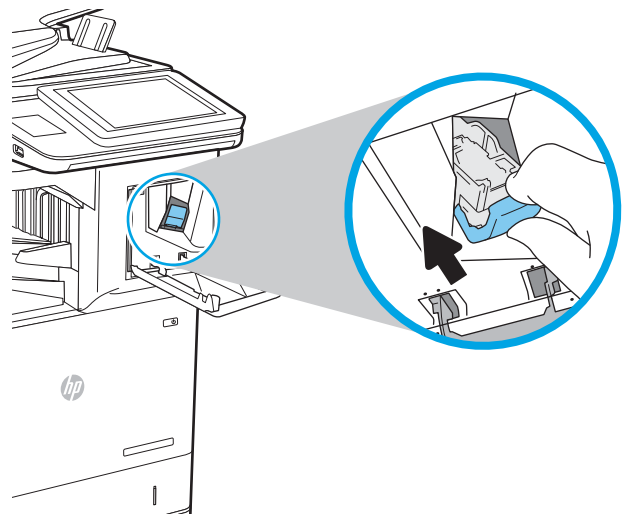
3. Lift up on the small lever at the back of the staple cartridge.



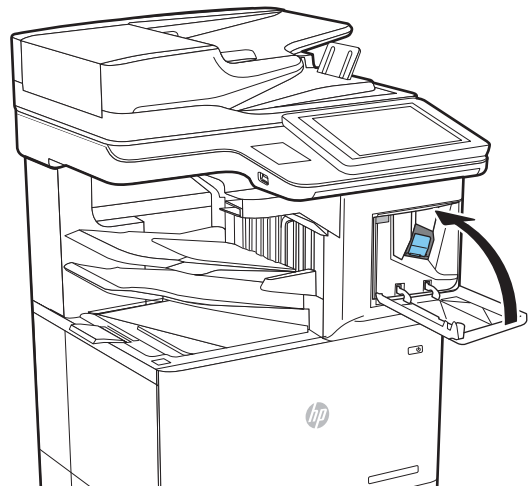
4. Remove the jammed staples.
5. Close the lever at the back of the staple cartridge. Be sure that it snaps into place.



6. Insert the staple cartridge into the stapler and push on the colored handle until it snaps into place.



7. Close the stapler door.



# Resolve print-quality problems

## Introduction

Use the information below to troubleshoot print-quality problems, including issues with image quality.

The troubleshooting steps can help resolve the following defects:

- Blank pages
- Black pages
- Curled paper
- Dark or light bands
- Dark or light streaks
- Fuzzy print
- Gray background or dark print
- Light print
- Loose toner
- Missing toner
- Scattered dots of toner
- Skewed images
- Smears
- Streaks

## Troubleshoot print quality

To resolve print-quality issues, try these steps in the order presented.

### Update the printer firmware

Try updating the printer firmware. For more information, go to [www.hp.com/support](http://www.hp.com/support) and select the option to **Get software and drivers**. Then follow the prompts to navigate to the firmware download for the printer.

### Print from a different software program

Try printing from a different software program. If the page prints correctly, the problem is with the software program from which you were printing.

### Check the paper type setting for the print job

Check the paper type setting when printing from a software program and the printed pages have smears, fuzzy or dark print, curled paper, scattered dots of toner, loose toner, or small areas of missing toner.

### Check the paper type setting on the printer



1. Open the tray.
2. Verify that the tray is loaded with the correct type of paper.
3. Close the tray.
4. Follow the control panel instructions to confirm or modify the paper type settings for the tray.

#### Check the paper type setting (Windows)

1. From the software program, select the **Print** option.
2. Select the printer, and then click the **Properties** or **Preferences** button.
3. Click the **Paper/Quality** tab.
4. From the **Paper Type** drop-down list, click the **More...** option.
5. Expand the list of **Type is:** options.
6. Expand the category of paper types that best describes your paper.
7. Select the option for the type of paper you are using, and click the **OK** button.
8. Click the **OK** button to close the **Document Properties** dialog box. In the **Print** dialog box, click the **OK** button to print the job.

#### Check the paper type setting (macOS)

1. Click the **File** menu, and then click the **Print** option.
2. In the **Printer** menu, select the printer.
3. By default, the print driver displays the **Copies & Pages** menu. Open the menus drop-down list, and then click the **Finishing** menu.
4. Select a type from the **Media Type** drop-down list.
5. Click the **Print** button.

#### Check toner-cartridge status

Follow these steps to check the estimated life remaining in the toner cartridge and if applicable, the status of other replaceable maintenance parts.

##### Step one: Print the supplies status page

1. From the Home screen on the printer control panel, navigate to the **Reports** application, and then select the **Reports** icon.
2. Select the **Configuration/Status Pages** menu.
3. Select **Supplies Status Page**, and then select **Print** to print the page.

## Step two: Check supplies status

1. Look at the supplies status report to check the percent of life remaining for the toner cartridge and, if applicable, the status of other replaceable maintenance parts.

Print quality problems can occur when using a toner cartridge that is at its estimated end of life. The supplies status page indicates when a supply level is very low. After an HP supply has reached the very low threshold, HP's premium protection warranty on that supply has ended.

The toner cartridge does not need to be replaced now unless the print quality is no longer acceptable. Consider having a replacement available to install when print quality is no longer acceptable.

If you determine that you need to replace a toner cartridge or other replaceable maintenance parts, the supplies status page lists the genuine HP part numbers.

2. Check to see if you are using a genuine HP cartridge.

A genuine HP toner cartridge has the word "HP" on it, or has the HP logo on it. For more information on identifying HP cartridges go to [www.hp.com/go/learnaboutsupplies](http://www.hp.com/go/learnaboutsupplies).

## Print a cleaning page

During the printing process paper, toner, and dust particles can accumulate inside the printer and can cause print-quality issues such as toner specks or spatter, smears, streaks, lines, or repeating marks.

Follow these steps to clean the printer's paper path.

1. From the Home screen on the printer control panel, navigate to the [Support Tools](#) application, and then select the [Support Tools](#) icon.
2. Select the following menus:
  - a. [Maintenance](#)
  - b. [Calibration/Cleaning](#)
  - c. [Cleaning Page](#)
3. Select [Print](#) to print the page.

A **Cleaning...** message displays on the printer control panel. The cleaning process takes a few minutes to complete. Do not turn the printer off until the cleaning process has finished. When it is finished, discard the printed page.

## Visually inspect the toner cartridge

---

 **NOTE:** If the access door to the cartridge area is locked, contact your managed service provider for assistance with unlocking the door.

---

Follow these steps to inspect the toner cartridge.

1. Remove the toner cartridge from the printer, and verify that the sealing tape has been removed.
2. Check the memory chip for damage.
3. Examine the surface of the green imaging drum.

---

 **CAUTION:** Do not touch the imaging drum. Fingerprints on the imaging drum can cause print-quality problems.

---

4. If you see any scratches, fingerprints, or other damage on the imaging drum, replace the toner cartridge.
5. Reinstall the toner cartridge, and print a few pages to see if the problem has resolved.

## Check paper and the printing environment

### Step one: Use paper that meets HP specifications

Some print-quality problems arise from using paper that does not meet HP specifications.

- Always use a paper type and weight that this printer supports.
- Use paper that is of good quality and free of cuts, nicks, tears, spots, loose particles, dust, wrinkles, voids, staples, and curled or bent edges.
- Use paper that has not been previously printed on.
- Use paper that does not contain metallic material, such as glitter.
- Use paper that is designed for use in laser printers. Do not use paper that is designed only for use in Inkjet printers.
- Use paper that is not too rough. Using smoother paper generally results in better print quality.

### Step two: Check the environment

The environment can directly affect print quality and is a common cause for print-quality or paper-feeding issues. Try the following solutions:

- Move the printer away from drafty locations, such as open windows or doors, or air-conditioning vents.
- Make sure the printer is not exposed to temperatures or humidity outside of printer specifications.
- Do not place the printer in a confined space, such as a cabinet.
- Place the printer on a sturdy, level surface.
- Remove anything that is blocking the vents on the printer. The printer requires good air flow on all sides, including the top.
- Protect the printer from airborne debris, dust, steam, grease, or other elements that can leave residue inside the printer.

### Step three: Set the individual tray alignment

Follow these steps when text or images are not centered or aligned correctly on the printed page when printing from specific trays.

1. From the Home screen on the printer control panel, navigate to the [Settings](#) application, and then select the [Settings](#) icon.
2. Select the following menus:
  - a. [Copy/Print](#) or [Print](#)
  - b. [Print Quality](#)
  - c. [Image Registration](#)
3. Select [Tray](#), and then select the tray to adjust.

4. Select [Print Test Page](#), and then follow the instructions on the printed pages.
5. Select [Print Test Page](#) again to verify the results, and then make further adjustments if necessary.
6. Select [Done](#) to save the new settings.

## Try a different print driver

Try a different print driver when printing from a software program and the printed pages have unexpected lines in graphics, missing text, missing graphics, incorrect formatting, or substituted fonts.

Download any of the following drivers from the HP Web site: [www.hp.com/support/ljE62655mfp](http://www.hp.com/support/ljE62655mfp), [www.hp.com/support/ljE62665mfp](http://www.hp.com/support/ljE62665mfp), or [www.hp.com/support/ljE62675mfp](http://www.hp.com/support/ljE62675mfp).

<b>HP PCL 6 V3 driver</b>	This printer-specific print driver supports Windows 7 and newer operating systems that support version 3 drivers. For a list of supported operating systems, go to <a href="http://www.hp.com/go/support">www.hp.com/go/support</a> .
<b>HP PCL-6 V4 driver</b>	This product-specific print driver supports Windows 8 and newer operating systems that support version 4 drivers. For a list of supported operating systems, go to <a href="http://www.hp.com/go/support">www.hp.com/go/support</a> .
<b>HP UPD PS driver</b>	<ul style="list-style-type: none"><li>• Recommended for printing with Adobe® software programs or with other highly graphics-intensive software programs</li><li>• Provides support for printing from postscript emulation needs, or for postscript flash font support</li></ul>
<b>HP UPD PCL 6</b>	<ul style="list-style-type: none"><li>• Recommended for printing in all Windows environments</li><li>• Provides the overall best speed, print quality, and printer feature support for most users</li><li>• Developed to align with Windows Graphic Device Interface (GDI) for best speed in Windows environments</li><li>• Might not be fully compatible with third-party and custom software programs that are based on PCL 5</li></ul>

## Improve copy image quality

If the printer is having copy quality problems, try the following solutions in the order presented to resolve the issue.

- [Check the scanner glass for dirt and smudges](#)
- [Calibrate the scanner](#)
- [Check the paper settings](#)
- [Check the image-adjustment settings](#)
- [Optimize copy quality for text or pictures](#)
- [Edge-to-edge copying](#)

Try these few simple steps first:

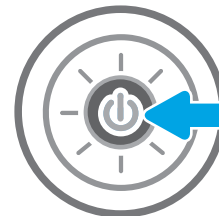
- Use the flatbed scanner rather than the document feeder.
- Use high-quality originals.
- When using the document feeder, load the original document into the feeder correctly, using the paper guides, to avoid unclear or skewed images.

If the problem still exists, try these additional solutions. If they do not fix the problem, see “Improve print quality” for further solutions.

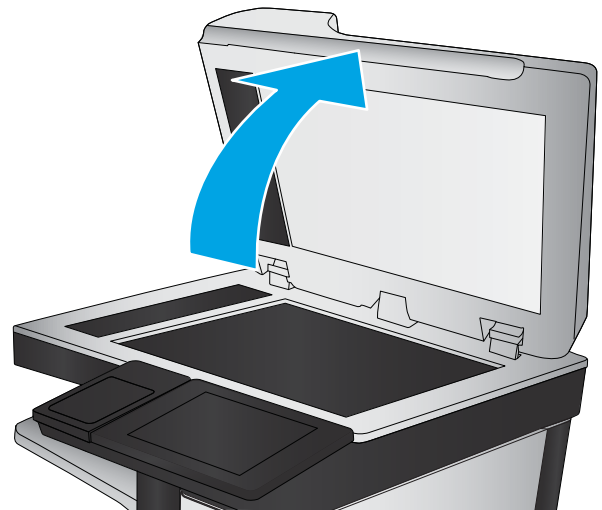
### Check the scanner glass for dirt and smudges

Over time, specks of debris might collect on the scanner glass and white plastic backing, which can affect performance. Use the following procedure to clean the scanner if the printed pages have streaks, unwanted lines, black dots, poor print quality, or unclear text.

1. Press the power button to turn the printer off, and then disconnect the power cable from the electrical outlet.



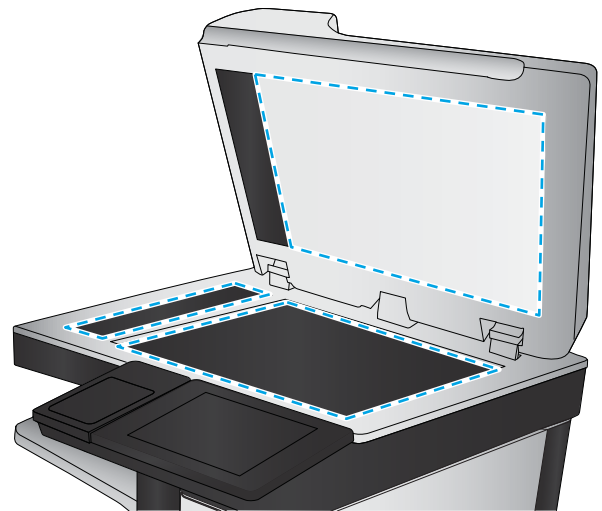
2. Open the scanner lid.



3. Clean the scanner glass and the document feeder strips with a soft cloth or sponge that has been moistened with nonabrasive glass cleaner.

**CAUTION:** Do not use abrasives, acetone, benzene, ammonia, ethyl alcohol, or carbon tetrachloride on any part of the printer; these can damage the printer. Do not place liquids directly on the glass or platen. They might seep and damage the printer.

**NOTE:** If you are having trouble with streaks on copies when you are using the document feeder, be sure to clean the small strip of glass on the left side of the scanner.




4. Dry the glass and white plastic parts with a chamois or a cellulose sponge to prevent spotting.
5. Connect the power cable to an outlet, and then press the power button to turn the printer on.

## Calibrate the scanner

If the copied image is not positioned correctly on the page, follow these steps to calibrate the scanner.

---

 **NOTE:** When using the document feeder, make sure to adjust the guides in the input tray so they are against the original document.

---

1. From the Home screen on the printer control panel, navigate to the [Support Tools](#) application, and then select the [Support Tools](#) icon.
2. Open the following menus:

- a. [Maintenance](#)
  - b. [Calibration/Cleaning](#)
  - c. [Calibrate Scanner](#)
3. Select the [Start](#) button to start the calibration process. Follow the on-screen prompts.
  4. Wait while the printer calibrates, and then try copying again.

## Check the paper settings

Follow these steps if copied pages have smears, fuzzy or dark print, curled paper, or areas where pigment has dropped out.

### Check the paper selection options

1. From the Home screen on the printer control panel, select [Copy](#).
2. Select [Options](#), and then scroll to and select [Paper Selection](#).
3. Select [Paper size](#), and then select one of the predefined options.
4. Select [Paper type](#), and then select one of the predefined options.
5. Select [Paper tray](#), and then select one of the predefined options.
6. Select [Done](#) to save the paper selection options.

## Check the image-adjustment settings

Adjust these additional settings to improve copy quality:

- [Sharpness](#): Clarify or soften the image. For example, increasing the sharpness could make text appear crisper, but decreasing it could make photos appear smoother.
  - [Darkness](#): Increase or decrease the amount of white and black used in colors in scanned images.
  - [Contrast](#): Increase or decrease the difference between the lightest and the darkest color on the page.
  - [Background Cleanup](#): Remove faint colors from the background of scanned images. For example, if the original document is printed on colored paper, use this feature to lighten the background without affecting the darkness of the image.
  - [Automatic Tone](#): Available for Flow printers only. The printer automatically adjusts the [Darkness](#), [Contrast](#), and [Background Cleanup](#) settings to the most appropriate for the scanned document.
1. From the Home screen on the printer control panel, select [Copy](#).
  2. Select [Options](#), and then scroll to and select [Image Adjustment](#).
  3. Adjust the sliders to set the levels, and select [Done](#).
  4. Select [Copy](#) to start the copy job.



**NOTE:** These settings are temporary. After you have finished the job, the printer returns to the default settings.

## Optimize copy quality for text or pictures

Optimize the copy job for the type of image being copied: text, graphics, or photos.

1. From the Home screen on the printer control panel, select [Copy](#).
2. Select [Options](#), and then select [Optimize Text/Picture](#).
3. Select one of the predefined options.
4. Select [Copy](#) to start the copy job.



---

**NOTE:** These settings are temporary. After you have finished the job, the printer returns to the default settings.

## Edge-to-edge copying

Use this feature to avoid shadows that can appear along the edges of copies when the original document is printed close to the edges.

1. From the Home screen on the printer control panel, select [Copy](#).
2. Select [Options](#), and then select [Edge-To-Edge](#).
3. Select the [Edge-To-Edge output](#) option if the original document is printed close to the paper edges.
4. Select [Copy](#) to start the copy job.



## Improve scan image quality

- [Check the scanner glass for dirt and smudges](#)
- [Check the resolution settings](#)
- [Check the image-adjustment settings](#)
- [Optimize scan quality for text or pictures](#)
- [Check the output-quality settings](#)

Try these few simple steps first:

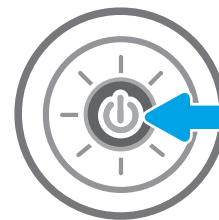
- Use the flatbed scanner rather than the document feeder.
- Use high-quality originals.
- When using the document feeder, load the original document into the feeder correctly, using the paper guides, to avoid unclear or skewed images.

If the problem still exists, try these additional solutions. If they do not fix the problem, see “Improve print quality” for further solutions.

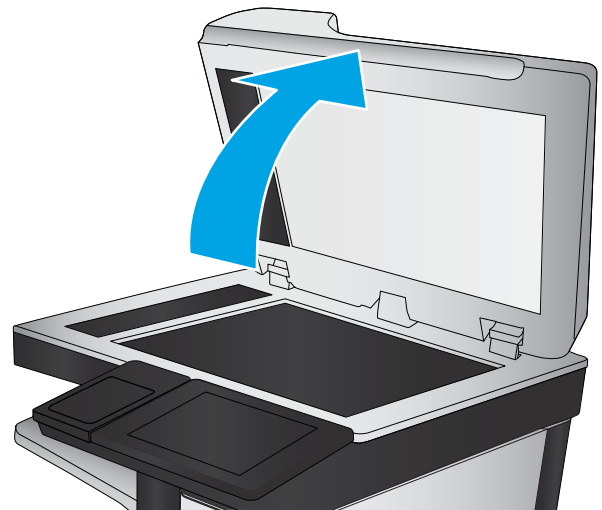
### Check the scanner glass for dirt and smudges

Over time, specks of debris might collect on the scanner glass and white plastic backing, which can affect performance. Use the following procedure to clean the scanner if the printed pages have streaks, unwanted lines, black dots, poor print quality, or unclear text.

1. Press the power button to turn the printer off, and then disconnect the power cable from the electrical outlet.



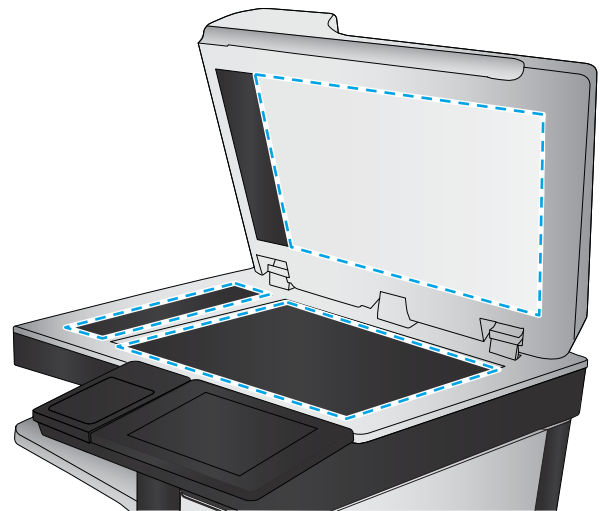
2. Open the scanner lid.



3. Clean the scanner glass and the document feeder strips with a soft cloth or sponge that has been moistened with nonabrasive glass cleaner.

**CAUTION:** Do not use abrasives, acetone, benzene, ammonia, ethyl alcohol, or carbon tetrachloride on any part of the printer; these can damage the printer. Do not place liquids directly on the glass or platen. They might seep and damage the printer.

**NOTE:** If you are having trouble with streaks on copies when you are using the document feeder, be sure to clean the small strip of glass on the left side of the scanner.



4. Dry the glass and white plastic parts with a chamois or a cellulose sponge to prevent spotting.
5. Connect the power cable to an outlet, and then press the power button to turn the printer on.

## Check the resolution settings

 **NOTE:** Setting the resolution to a high value increases the file size and the scan time.

Follow these steps to adjust the resolution setting:

1. From the Home screen on the printer control panel, select [Scan](#).
2. Select one of the following Scan features:
  - [Scan to Email](#)
  - [Scan to Network Folder](#)

- [Scan to USB Drive](#)
  - [Scan to SharePoint®](#)
3. Select [Options](#), and then select [File Type and Resolution](#).
  4. Select one of the predefined [Resolution](#) options, and then select [Done](#).
  5. Select [Send](#) or [Save](#) to start the scan.


## Check the image-adjustment settings

Adjust these additional settings to improve scan quality:

- [Sharpness](#): Clarify or soften the image. For example, increasing the sharpness could make text appear crisper, but decreasing it could make photos appear smoother.
- [Darkness](#): Increase or decrease the amount of white and black used in colors in scanned images.
- [Contrast](#): Increase or decrease the difference between the lightest and the darkest color on the page.
- [Background Cleanup](#): Remove faint colors from the background of scanned images. For example, if the original document is printed on colored paper, use this feature to lighten the background without affecting the darkness of the image.
- [Automatic Tone](#): Available for Flow printers only. The printer automatically adjusts the [Darkness](#), [Contrast](#), and [Background Cleanup](#) settings to the most appropriate for the scanned document.

1. From the Home screen on the printer control panel, select [Scan](#).
2. Select one of the following Scan features:
  - [Scan to E-mail](#)
  - [Scan to Network Folder](#)
  - [Scan to USB Drive](#)
  - [Scan to Job Storage](#)
  - [Scan to SharePoint®](#)
3. Select [Options](#), and then select [Image Adjustment](#).
4. Adjust the sliders to set the levels, and then select [Done](#).
5. Select [Send](#) or [Save](#) to start the scan.

---

 **NOTE:** These settings are temporary. After you have finished the job, the printer returns to the default settings.

## Optimize scan quality for text or pictures

Optimize the scan job for the type of image being scanned: text, graphics, or photos.

1. From the Home screen on the printer control panel, select [Scan](#).
2. Select one of the following Scan features:

- [Scan to E-mail](#)
  - [Scan to Network Folder](#)
  - [Scan to USB Drive](#)
  - [Scan to Job Storage](#)
  - [Scan to SharePoint®](#)
3. Select [Options](#), and then select [Optimize Text/Picture](#).
  4. Select one of the predefined options.
  5. Select [Send](#) or [Save](#) to start the scan.



**NOTE:** These settings are temporary. After you have finished the job, the printer returns to the default settings.

## Check the output-quality settings

This setting adjusts the level of compression when saving the file. For the highest quality, select the highest setting.

1. From the Home screen on the printer control panel, select [Scan](#).
2. Select one of the following Scan features:
  - [Scan to Email](#)
  - [Scan to Network Folder](#)
  - [Scan to USB Drive](#)
  - [Scan to SharePoint®](#)
3. Select [Options](#), and then select [File Type and Resolution](#).
4. Select one of the predefined [Quality and File Size](#) options, and then select [Done](#).
5. Select [Send](#) or [Save](#) to start the scan.

## Improve fax image quality

If the printer is having fax quality problems, try the following solutions in the order presented to resolve the issue.

- [Check the scanner glass for dirt and smudges](#)
- [Check the send-fax resolution settings](#)
- [Check the image-adjustment settings](#)
- [Optimize fax quality for text or pictures](#)
- [Check the error-correction settings](#)
- [Check the fit-to-page setting](#)
- [Send to a different fax machine](#)
- [Check the sender's fax machine](#)

Try these few simple steps first:

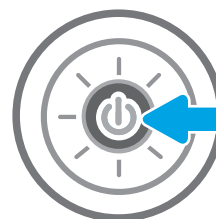
- Use the flatbed scanner rather than the document feeder.
- Use high-quality originals.
- When using the document feeder, load the original document into the feeder correctly, using the paper guides, to avoid unclear or skewed images.

If the problem still exists, try these additional solutions. If they do not fix the problem, see “Improve print quality” for further solutions.

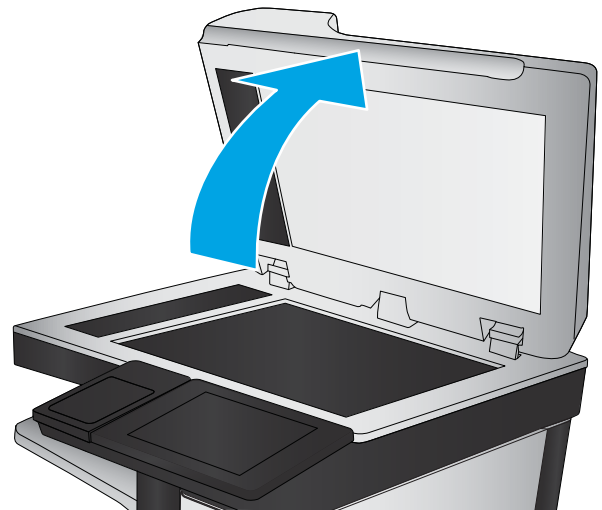
### Check the scanner glass for dirt and smudges

Over time, specks of debris might collect on the scanner glass and white plastic backing, which can affect performance. Use the following procedure to clean the scanner if the printed pages have streaks, unwanted lines, black dots, poor print quality, or unclear text.

1. Press the power button to turn the printer off, and then disconnect the power cable from the electrical outlet.



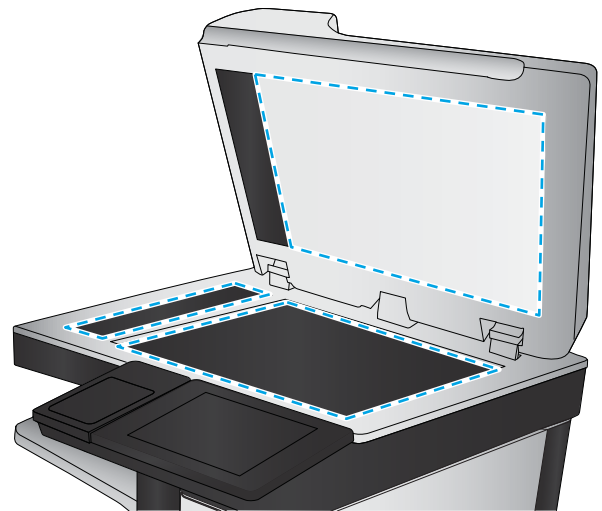
2. Open the scanner lid.



3. Clean the scanner glass and the document feeder strips with a soft cloth or sponge that has been moistened with nonabrasive glass cleaner.

**CAUTION:** Do not use abrasives, acetone, benzene, ammonia, ethyl alcohol, or carbon tetrachloride on any part of the printer; these can damage the printer. Do not place liquids directly on the glass or platen. They might seep and damage the printer.

**NOTE:** If you are having trouble with streaks on copies when you are using the document feeder, be sure to clean the small strip of glass on the left side of the scanner.



4. Dry the glass and white plastic parts with a chamois or a cellulose sponge to prevent spotting.
5. Connect the power cable to an outlet, and then press the power button to turn the printer on.

## Check the send-fax resolution settings

Follow these steps to adjust the resolution of outgoing faxes.

---

 **NOTE:** Increasing the resolution increases the fax size and send time.

---

1. From the Home screen on the printer control panel, select **Fax**.
2. Select **Options**.
3. In the Options pane, scroll to and select **Resolution**.
4. Select one of the predefined options, and then select **Send** to send the fax.

## Check the image-adjustment settings

Adjust these additional settings to improve send-fax quality:

- **Sharpness:** Clarify or soften the image. For example, increasing the sharpness could make text appear crisper, but decreasing it could make photos appear smoother.
  - **Darkness:** Increase or decrease the amount of white and black used in colors in scanned images.
  - **Contrast:** Increase or decrease the difference between the lightest and the darkest color on the page.
  - **Background Cleanup:** Remove faint colors from the background of scanned images. For example, if the original document is printed on colored paper, use this feature to lighten the background without affecting the darkness of the image.
  - **Automatic Tone:** Available for Flow printers only. The printer automatically adjusts the **Darkness**, **Contrast**, and **Background Cleanup** settings to the most appropriate for the scanned document.
1. From the Home screen on the printer control panel, select **Fax**.
  2. Select **Options**.
  3. In the Options pane, scroll to and select **Image Adjustment**.
  4. Adjust the sliders to set the levels, and then select **Done**.
  5. Select **Send** to send the fax.

---

 **NOTE:** These settings are temporary. After you have finished the job, the printer returns to the default settings.

## Optimize fax quality for text or pictures

Optimize the fax job for the type of image being scanned: text, graphics, or photos.

1. From the Home screen on the printer control panel, select **Fax**.
2. Select **Options**.
3. In the Options pane, scroll to and select **Optimize Text/Picture**.
4. Select one of the predefined options.
5. Select **Send** to send the fax.

---

 **NOTE:** These settings are temporary. After you have finished the job, the printer returns to the default settings.

## Check the error-correction settings

The **Error Correction Mode** setting might be disabled, which can reduce image quality. Follow these steps to re-enable the setting.

1. From the Home screen on the printer control panel, navigate to the **Settings** application, and then select the **Settings** icon.
2. Open the following menus:

- a. [Fax](#)
  - b. [Fax Send Settings](#)
  - c. [General Fax Send Settings](#)
3. Select the [Error Correction Mode](#) option. Select the [Done](#) button.

## Check the fit-to-page setting

If the [Fit to Page](#) setting is enabled, and the incoming fax is larger than the default page size, the printer attempts to scale the image to fit the page. If this setting is disabled, larger images split across multiple pages.

1. From the Home screen on the printer control panel, navigate to the [Settings](#) application, and then select the [Settings](#) icon.
2. Open the following menus:
  - a. [Fax](#)
  - b. [Fax Receive Settings](#)
  - c. [Default Job Options](#)
  - d. [Fit to Page](#)
3. Select the [On](#) option to enable the setting, or select the [Off](#) option to disable it.

## Send to a different fax machine

Try sending the fax to a different fax machine. If the fax quality is better, the problem is related to the initial recipient's fax machine settings or supplies status.

## Check the sender's fax machine

Ask the sender to try sending from a different fax machine. If the fax quality is better, the problem is with the sender's fax machine. If a different fax machine is unavailable, ask the sender to consider making the following changes:

- Make sure the original document is on white (not colored) paper.
- Increase the fax resolution, quality level, or contrast settings.
- If possible, send the fax from a computer software program.



## Solve fax problems

- [Checklist for solving fax problems](#)
- [General fax problems](#)

### Checklist for solving fax problems

Use the following checklist to help identify the cause of any fax-related problems you encounter:

- **Are you using the fax cable supplied with the fax accessory?** This fax accessory has been tested with the supplied fax cable to meet RJ11 and functional specifications. Do not substitute another fax cable; the analog-fax accessory requires an analog-fax cable. It also requires an analog phone connection.
- **Is the fax/phone line connector seated in the outlet on the fax accessory?** Make sure that the phone jack is correctly seated in the outlet. Insert the connector into the outlet until it "clicks."



---

**NOTE:** Verify that the phone jack is connected to the fax port rather than to the network port. The ports are similar.

---

- **Is the phone wall jack working properly?** Verify that a dial tone exists by attaching a phone to the wall jack. Can you hear a dial tone, and can you make or receive a phone call?

### What type of phone line are you using?

- **Dedicated line:** A standard analog fax/phone line assigned to receive or send faxes.



---

**NOTE:** The phone line should be for printer fax use only and not shared with other types of telephone devices. Examples include alarm systems that use the phone line for notifications to a monitoring company.

---

- **PBX system:** A business-environment phone system. Standard home phones and the fax accessory use an analog phone signal. Some PBX systems are digital and might not be compatible with the fax accessory. You might need an interfacing Analog Telephone Adapter (ATA) to connect the fax machine to digital PBX systems.
- **Roll-over lines:** A phone system feature where a new call "rolls over" to the next available line when the first incoming line is busy. Try attaching the printer to the first incoming phone line. The fax accessory answers the phone after it rings the number of times set in the rings-to-answer setting.

### Are you using a surge-protection device?

A surge-protection device can be used between the wall jack and the fax accessory to protect the fax accessory against electrical power passed through the phone lines. These devices can cause some fax communication problems by degrading the quality of the phone signal. If you are having problems sending or receiving faxes and are using one of these devices, connect the printer directly to the phone jack on the wall to determine whether the problem is with the surge-protection device.

### Are you using a phone company voice-messaging service or an answering machine?

If the rings-to-answer setting for the messaging service is lower than the rings-to-answer setting for the fax accessory, the messaging service answers the call, and the fax accessory cannot receive faxes. If the rings-to-answer setting for the fax accessory is lower than that of the messaging service, the fax accessory answers all calls.

## Does your phone line have a call-waiting feature?

If the fax telephone line has an activated call-waiting feature, a call-waiting notice can interrupt a fax call in progress, which causes a communication error. Ensure that a call-waiting feature is not active on the fax telephone line.

## Check fax accessory status

If the analog-fax accessory does not appear to be functioning, print a [Configuration Page](#) report to check the status.

1. From the Home screen on the printer control panel, navigate to the [Reports](#) application, and then select the [Reports](#) icon.
2. Open the following menus:
  - a. [Configuration/Status Pages](#)
  - b. [Configuration Page](#)
3. Touch the [Print](#) button to print the report, or touch the [View](#) button to view the report on the screen. The report consists of several pages.

 **NOTE:** The printer IP address or host name is listed on the Jetdirect Page.

On the Fax Accessory Page of the Configuration Page, under the Hardware Information heading, check the Modem Status. The following table identifies the status conditions and possible solutions.

 **NOTE:** If the Fax Accessory Page does not print, there might be a problem with the analog fax accessory. If you are using LAN fax or Internet fax, those configurations could be disabling the feature.

**Table 9-2 Fax accessory status solutions**

Status	Definition/Solution
Operational / Enabled <sup>1</sup>	The analog-fax accessory is installed and ready.
Operational / Disabled <sup>1</sup>	The fax accessory is installed, but you have not configured the required fax settings yet.  The fax accessory is installed and operational; however, the HP Digital Sending utility has either disabled the printer fax feature or has enabled LAN fax. When LAN fax is enabled, the analog-fax feature is disabled. Only one fax feature, either LAN fax or analog fax, can be enabled at a time.  <b>NOTE:</b> If LAN fax is enabled, the <a href="#">Scan to Fax</a> feature is unavailable on the printer control panel.
Non-Operational / Enabled/Disabled <sup>1</sup>	The printer has detected a firmware failure. Upgrade the firmware.
Damaged / Enabled/Disabled <sup>1</sup>	The fax accessory has failed. Reseat the fax accessory card and check for bent pins. If the status is still DAMAGED, replace the analog-fax accessory card.

<sup>1</sup> ENABLED indicates that the analog-fax accessory is enabled and turned on; DISABLED indicates that LAN fax is enabled (analog fax is turned off).

## General fax problems

The following are some common fax problems.

### The fax failed to send

JBIG is enabled, and the receiving fax machine does not have JBIG capability.

Turn off the JBIG setting.

### An Out of Memory status message displays on the printer control panel

The printer storage disk is full.

Delete some stored jobs from the disk. From the Home screen on the printer control panel, touch the [Retrieve from Device Memory](#) button. Open the list of stored jobs or stored faxes. Select a job to delete, and then touch the [Delete](#) button.

### Print quality of a photo is poor or prints as a gray box

You are using the wrong page-content setting or the wrong resolution setting.

Try setting the [Optimize Text/Picture](#) option to [Photograph](#) setting.

### You touched the Stop button to cancel a fax, but the fax was still sent

If the job is too far along in the sending process, you cannot cancel the job.

This is normal operation.

### No fax address book button displays

None of the contacts in the selected contacts list have fax information associated with them.

### Not able to locate the Fax settings in HP Web Jetadmin

Fax settings in HP Web Jetadmin are located under the device's status page drop-down menu.

Select **Digital Sending and Fax** from the drop-down menu.

### The header is appended to the top of the page when the overlay option is enabled

For all forwarded faxes, the printer appends the overlay header to the top of a page.

This is normal operation.

### A mix of names and numbers is in the recipients box

Names and numbers can both display, depending on where they are from. The fax address book lists names, and all other databases list numbers.

This is normal operation.

### A one-page fax prints as two pages

The fax header is being appended to the top of the fax, pushing text to a second page.

To print a one page fax on one page, set the overlay header to overlay mode, or adjust the fit-to-page setting.

### **A document stops in the document feeder in the middle of faxing**

A jam is in the document feeder.

Clear the jam, and send the fax again.

### **The volume for sounds coming from the fax accessory is too high or too low**

The volume setting needs to be adjusted.

Adjust the volume in the [Fax Send Settings](#) menu and the [Fax Receive Settings](#) menu.

# Index

## Symbols/Numerics

2,100-sheet high-capacity input tray  
loading 30

## A

accessories  
ordering 42  
acoustic specifications 15  
AirPrint 63  
alternative letterhead mode 25, 29  
Android devices  
printing from 63

## B

bins, output  
locating 3  
Bonjour  
identifying 135  
browser requirements  
HP embedded Web Server 134

## C

calibrate  
scanner 196  
cartridge  
replacing 43  
cartridges  
order numbers 43  
replacing staple 47  
cleaning  
glass 195, 199, 203  
paper path 192  
control panel  
help 155  
locating 3  
locating features 5  
copy  
optimize for text or pictures 198

copy settings  
HP Embedded Web Server 137  
copying  
both sides 70  
multiple copies 68  
resolution 9  
single copies 68  
customer support  
online 154

## D

default gateway, setting 144  
deleting  
stored jobs 59  
digital send settings  
HP Embedded Web Server 137  
digital sending  
folders 113  
printer memory 110  
sending documents 107  
USB 117  
dimensions, printer 9, 14  
document feeder  
capacity 9  
jams 168  
locating 3  
paper-feeding problems 164  
double-sided printing  
Mac 54  
Windows 51  
drivers, supported 12  
duplex printing  
Mac 54  
duplex printing (double-sided)  
settings (Windows) 50  
Windows 51  
duplexer  
clearing jams 182

duplexing  
manually (Mac) 54  
manually (Windows) 51

## E

easy-access USB printing 64  
edge-to-edge copying 198  
electrical specifications 15  
Embedded Web Server  
changing network settings 143  
changing printer name 143  
opening 143  
Embedded Web Server (EWS)  
assigning passwords 146  
features 134  
network connection 135  
energy use, optimizing 148  
envelope feeder  
clearing jams 183  
envelopes  
orientation 22  
envelopes, loading 34  
Ethernet (RJ-45)  
locating 5  
Explorer, versions supported  
HP Embedded Web Server 134

## F

fax  
feeding problems 209  
optimize for text or pictures 205  
required settings 126  
settings 127  
setup 126  
fax port  
locating 5  
fax settings  
HP Embedded Web Server 138  
required 126

- feeding problems 209
  - FIH (foreign interface harness)
    - locating 5
  - folders
    - sending to 113
  - foreign interface harness (FIH)
    - locating 5
  - formatter
    - locating 4
  - fuser
    - clearing jams 179
- G**
- gateway, setting default 144
  - general configuration
    - HP Embedded Web Server 136
  - glass, cleaning 195, 199, 203
- H**
- hard disks
    - encrypted 147
  - hardware integration pocket (HIP)
    - locating 3
  - Help button
    - locating 5
  - help, control panel 155
  - Hi-Speed USB 2.0 printing port
    - locating 5
  - HIP (hardware integration pocket)
    - locating 3
  - Home button
    - locating 5
  - HP Customer Care 154
  - HP Embedded Web Server
    - changing network settings 143
    - changing printer name 143
    - copy settings 137
    - digital send settings 137
    - fax settings 138
    - general configuration 136
    - HP Web Services 140
    - information pages 135
    - network settings 140
    - opening 143
    - other links list 142
    - print settings 137
    - scan settings 137
    - security settings 140
    - supplies settings 139
    - troubleshooting tools 139
  - HP Embedded Web Server (EWS)
    - features 134
    - network connection 135
  - HP ePrint 62
  - HP JetAdvantage business solutions 122
  - HP Stapling Mailbox
    - clear jams 185
    - clear staple jams 187
  - HP Web Jetadmin 150
  - HP Web Services
    - enabling 140
- I**
- image quality
    - check toner-cartridge status 191
  - information pages
    - HP Embedded Web Server 135
  - interface ports
    - locating 5
  - Internet Explorer, versions supported
    - HP Embedded Web Server 134
  - IP Security 146
  - IPsec 146
  - IPv4 address 144
  - IPv6 address 144
- J**
- jams
    - 2,100-sheet high-capacity input tray (Tray 6) 175
    - auto-navigation 167
    - causes of 167
    - document feeder 168
    - duplexer 182
    - envelope feeder 183
    - fuser 179
    - HP Stapling Mailbox 185
    - output bin 182
    - right door 179
    - staples in the HP Stapling Mailbox 187
    - Tray 1 170
    - Tray 2, 3, and 4 172
  - jams, paper
    - locations 166
  - Jetadmin, HP Web 150
  - JetAdvantage 122
  - jobs, stored
    - creating (Windows) 57
    - deleting 59
    - Mac settings 58
    - printing 59
- K**
- keyboard
    - locating 3
- L**
- label
    - orientation 36
  - labels
    - printing (Windows) 52
    - printing on 36
  - labels, loading 36
  - LAN port
    - locating 5
  - loading
    - paper in the 2,100-sheet high-capacity input tray 30
    - paper in Tray 1 21
    - paper in Tray 2 and the 550-sheet trays 26
  - local area network (LAN)
    - locating 5
  - lock
    - formatter 147
  - lower right door
    - locating 3
- M**
- Mac driver settings
    - Job Storage 58
  - Main input tray
    - loading labels 36
  - managing network 143
  - manual duplex
    - Mac 54
    - Windows 51
  - margins, small
    - copying 198
  - memory
    - included 9
  - memory chip (toner)
    - locating 43
  - mobile printing
    - Android devices 63
  - mobile printing solutions 9
  - multiple pages per sheet
    - printing (Mac) 55
    - printing (Windows) 51

## N

- Near Field Communication printing 61
- Netscape Navigator, versions supported
  - HP embedded Web Server 134
- network
  - printer name, changing 143
  - settings, changing 143
  - settings, viewing 143
- network duplex settings, changing 145
- Network Folder, scan to 113
- network link speed settings, changing 145
- network settings
  - HP Embedded Web Server 140
- networks
  - default gateway 144
  - HP Web Jetadmin 150
  - IPv4 address 144
  - IPv6 address 144
  - subnet mask 144
  - supported 9
- NFC printing 61
- number of copies, changing 68

## O

- on/off button
  - locating 3
- online help, control panel 155
- online support 154
- operating systems (OS)
  - supported 9
- operating systems, supported 12
- optimize copy images 198
- optimize fax images 205
- optimize scanned images 201
- ordering
  - supplies and accessories 42
- OS (operating system)
  - supported 9
- other links list
  - HP Embedded Web Server 142
- output bin
  - clear jams 182
- output bins
  - locating 3

## P

- pages per minute 9
- pages per sheet
  - selecting (Mac) 55
  - selecting (Windows) 51
- paper
  - jams 167
  - loading the 2,100-sheet high-capacity input tray 30
  - loading Tray 1 21
  - loading Tray 2 and the 550-sheet trays 26
  - selecting 193
  - Tray 1 orientation 22
  - Tray 2 and the 500-sheet trays orientation 31
- paper jams
  - document feeder 168
  - HP Stapling Mailbox 185
  - locations 166
  - output bin 182
  - Tray 1 170
  - Tray 2, 3, and 4 172
  - Tray 5 175
- paper pickup problems
  - solving 158, 160
- paper type
  - selecting (Windows) 52
- paper types
  - selecting (Mac) 55
- paper, ordering 42
- ports
  - locating 5
- power
  - consumption 15
- power connection
  - locating 4
- power switch
  - locating 3
- power usage
  - 1 watt or less 148
- print drivers, supported 12
- print media
  - loading in Tray 1 21
- print on both sides
  - Mac 54
  - manually, Windows 51
  - Windows 51
- print settings
  - HP Embedded Web Server 137

- printer memory
  - sending to 110
- printer memory, scan to 110
- printing
  - from USB storage accessories 64
  - stored jobs 59
- printing on both sides
  - settings (Windows) 50
- Priority input tray
  - loading labels 36
- private printing 57

## R

- replacing
  - staple cartridges 47
  - toner cartridge 43
- required settings
  - fax 126
- resolution
  - copy and scan 9
- restore factory settings 156
- right door
  - clearing jams 179
  - locating 3
- RJ-45 port
  - locating 5

## S

- Save to printer memory 110
- scan settings
  - HP Embedded Web Server 137
- Scan to Network Folder 113
  - initial setup 89
- Scan to USB Drive 117
  - enabling 103
- scanner
  - calibrate 196
  - glass cleaning 195, 199, 203
- scanning
  - optimize for text or pictures 201
  - resolution 9
- scanning to email
  - sending documents 107
- scanning to folder 113
- scanning to printer folder 110
- scanning to printer memory 110
- scanning to USB 117
- security settings
  - HP Embedded Web Server 140

- security
    - encrypted hard disk 147
  - security lock slot
    - locating 5
  - sending to email
    - sending documents 107
  - settings
    - fax 127
    - restore factory 156
  - Sign In button
    - locating 5
  - Sign Out button
    - locating 5
  - sleep mode 148
  - small margins 198
  - special paper
    - printing (Windows) 52
  - specifications
    - electrical and acoustic 15
  - speed, optimizing 148
  - stacking
    - configure the operation mode 38
  - staple cartridges
    - replacing 47
  - staple jams
    - HP Stapling Mailbox 187
  - stapler
    - setting default staple location 38
  - stapler/stacker accessory
    - configure the operation mode 38
  - stapling
    - configure the operation mode 38
    - setting default location 38
  - Start Copy button
    - locating 5
  - status, fax accessory page 208
  - storage, job
    - Mac settings 58
  - store print jobs 57
  - stored jobs
    - creating (Mac) 58
    - creating (Windows) 57
    - deleting 59
    - printing 59
  - storing jobs
    - with Windows 57
  - subnet mask 144
  - supplies
    - low threshold settings 157
    - ordering 42
    - replacing staple cartridges 47
    - replacing toner cartridge 43
    - using when low 157
  - supplies settings
    - HP Embedded Web Server 139
  - support
    - online 154
  - system requirements
    - HP Embedded Web Server 134
    - minimum 13
- T**
- TCP/IP
    - manually configuring IPv4
      - parameters 144
    - manually configuring IPv6
      - parameters 144
  - technical support
    - online 154
  - toner cartridge
    - components 43
    - low threshold settings 157
    - replacing 43
    - using when low 157
  - toner cartridges
    - order numbers 43
  - touchscreen
    - locating features 5
  - transparencies
    - printing (Windows) 52
  - Tray 1
    - jams 170
    - loading envelopes 34
    - paper orientation 22
  - Tray 2
    - jams 172
  - Tray 2 and the 500-sheet trays
    - paper orientation 31
  - Tray 2 and the 550-sheet trays
    - loading 26
  - Tray 3
    - jams 172
  - Tray 4
    - jams 172
  - Tray 6
    - paper jams 175
  - trays
    - capacity 9
    - included 9
    - locating 3
- U**
- USB
    - sending to 117
  - USB port
    - enabling 64, 66
    - locating 5
  - USB storage accessories
    - printing from 64
- W**
- Web browser requirements
    - HP Embedded Web Server 134
  - Web sites
    - customer support 154
    - HP Web Jetadmin, downloading 150
  - weight, printer 9, 14
  - Wi-Fi Direct Printing 61



## Free Manuals Download Website

<http://myh66.com>

<http://usermanuals.us>

<http://www.somanuals.com>

<http://www.4manuals.cc>

<http://www.manual-lib.com>

<http://www.404manual.com>

<http://www.luxmanual.com>

<http://aubethermostatmanual.com>

Golf course search by state

<http://golfingnear.com>

Email search by domain

<http://emailbydomain.com>

Auto manuals search

<http://auto.somanuals.com>

TV manuals search

<http://tv.somanuals.com>