



LaserJet Pro M201, M202

User Guide



**M201n
M202n**



**M201dw
M202dw**



www.hp.com/support/ljM201
www.hp.com/support/ljM202



HP LaserJet Pro M201, M202

User Guide

Copyright and License

© 2014 Copyright Hewlett-Packard Development Company, L.P.

Reproduction, adaptation, or translation without prior written permission is prohibited, except as allowed under the copyright laws.

The information contained herein is subject to change without notice.

The only warranties for HP products and services are set forth in the express warranty statements accompanying such products and services. Nothing herein should be construed as constituting an additional warranty. HP shall not be liable for technical or editorial errors or omissions contained herein.

Part number: CF456-90908

Edition 1, 10/2014

Trademark Credits

Adobe®, Adobe Photoshop®, Acrobat®, and PostScript® are trademarks of Adobe Systems Incorporated.

Apple and the Apple logo are trademarks of Apple Computer, Inc., registered in the U.S. and other countries. iPod is a trademark of Apple Computer, Inc. iPod is for legal or rightholder-authorized copying only. Don't steal music.

Microsoft®, Windows®, Windows® XP, and Windows Vista® are U.S. registered trademarks of Microsoft Corporation.

UNIX® is a registered trademark of The Open Group.

Table of contents

1 Product introduction	1
Product comparison	2
Power consumption, electrical specifications, and acoustic emissions	4
Operating-environment specifications	4
Product views	5
Product front view	5
Product back view	6
Control-panel view	7
Product hardware setup and software installation	8
2 Paper trays	9
Supported paper sizes and types	10
Supported paper sizes	10
Supported paper types	12
Load the priority input tray (Tray 1)	13
Load the main input tray (Tray 2)	15
3 Parts, supplies, and accessories	19
Order parts, accessories, and supplies	20
Ordering	20
Supplies and accessories	20
Replace the toner cartridge	21
4 Print	25
Print tasks (Windows)	26
How to print (Windows)	26
Automatically print on both sides (Windows)	28
Manually print on both sides (Windows)	29
Print multiple pages per sheet (Windows)	30
Select the paper type (Windows)	31
Additional print tasks	31

Print tasks (Mac OS X)	32
How to print (OS X)	32
Automatically print on both sides (OS X)	32
Manually print on both sides (OS X)	32
Print multiple pages per sheet (OS X)	33
Select the paper type (OS X)	33
Additional print tasks	33
Set up HP Wireless Direct Printing	34
Mobile printing	35
HP ePrint via email	35
HP ePrint software	35
AirPrint	36
5 Manage the product	37
Change the product connection type (Windows)	38
Advanced configuration with HP Embedded Web Server (EWS) and HP Device Toolbox (Windows)	39
Advanced configuration with HP Utility for Mac OS X	41
Open HP Utility	41
HP Utility features	41
Configure IP network settings	43
Printer sharing disclaimer	43
View or change network settings	43
Rename the product on a network	43
Manually configure IPv4 TCP/IP parameters from the control panel	44
HP Web Jetadmin	45
Product security features	46
Set or change the product password using the HP Embedded Web Server	46
Economy settings	47
Print with EconoMode	47
Set the Sleep Delay	47
Set the Auto Power Down delay	47
Update the firmware	49
Method one: Update the firmware using the control panel	49
Method two: Update the firmware using the Firmware Update Utility	49
6 Solve problems	51
Customer support	52
Restore the factory-set defaults	53
A “Cartridge is low” or “Cartridge is very low” message displays on the product control panel	54
Change the “Very Low” settings	54
Order supplies	54

Product does not pick up paper or misfeeds	55
The product does not pick up paper	55
The product picks up multiple sheets of paper	55
Clear jams	56
Jam locations	56
Experiencing frequent or recurring paper jams?	57
Clear jams in the toner-cartridge area	58
Clear jams in the output bin	60
Clear jams in the duplexer (dw models only)	62
Improve print quality	63
Print from a different software program	63
Check the paper-type setting for the print job	63
Check the paper type setting (Windows)	63
Check the paper type setting (OS X)	63
Check the toner-cartridge status	64
Print a cleaning page	64
Visually inspect the toner cartridge for damage	65
Check paper and the printing environment	65
Step one: Use paper that meets HP specifications	65
Step two: Check the environment	65
Check other print job settings	66
Check the EconoMode settings	66
Try a different print driver	67
Solve wired network problems	68
Poor physical connection	68
The computer is using the incorrect IP address for the product	68
The computer is unable to communicate with the product	68
The product is using incorrect link and duplex settings for the network	69
New software programs might be causing compatibility problems	69
The computer or workstation might be set up incorrectly	69
The product is disabled, or other network settings are incorrect	69
Solve wireless network problems	70
Wireless connectivity checklist	70
The product does not print after the wireless configuration completes	71
The product does not print, and the computer has a third-party firewall installed	71
The wireless connection does not work after moving the wireless router or product	71
Cannot connect more computers to the wireless product	71
The wireless product loses communication when connected to a VPN	71
The network does not appear in the wireless networks list	71
The wireless network is not functioning	72
Perform a wireless network diagnostic test	72

Reduce interference on a wireless network 72

Index **73**

1 Product introduction

- [Product comparison](#)
- [Product views](#)
- [Product hardware setup and software installation](#)

For more information:

Go to www.hp.com/support/ljM201, www.hp.com/support/ljM202.

HP's all-inclusive help for the product includes the following information:

- Install and configure
- Learn and use
- Solve problems
- Download software updates
- Join support forums
- Find warranty and regulatory information

Product comparison

Model name		M201n	M202n	M201dw	M202dw
Product number		CF455A	C6N20A	CF456A	C6N21A
Product dimensions	Height	251 mm (9.9 in)	251 mm (9.9 in)	251 mm (9.9 in)	251 mm (9.9 in)
	Depth	242 mm (9.5 in)	242 mm (9.5 in)	281 mm (11.1 in)	281 mm (11.1 in)
	Width	379 mm (14.9 in)	379 mm (14.9 in)	384 mm (15.1 in)	384 mm (15.1 in)
	Weight, with toner cartridge	5.9 kg (13 lb)	5.9 kg (13 lb)	6.6 kg (14.5 lb)	6.6 kg (14.5 lb)
Paper handling	Priority input tray (Tray 1, 10-sheet capacity)	✓	✓	✓	✓
	Main input tray (Tray 2, 250-sheet capacity)	✓	✓	✓	✓
	Standard output bin (150-sheet capacity)	✓	✓	✓	✓
	Automatic duplex printing			✓	✓
Supported operating systems	Windows XP, 32-bit, SP2 and greater	✓	✓	✓	✓
	Windows XP, 64-bit, SP2 and greater, print-driver only	✓	✓	✓	✓
	Windows Vista, 32-bit and 64-bit	✓	✓	✓	✓
	Windows 7, 32-bit and 64-bit	✓	✓	✓	✓
	Windows 8, 32-bit and 64-bit	✓	✓	✓	✓
	Windows 8.1, 32-bit and 64-bit	✓	✓	✓	✓
	Windows 2003 Server 32-bit, SP1 and higher, print driver only	✓	✓	✓	✓
	Windows 2003 Server 64-bit, SP1 and higher, print driver only	✓	✓	✓	✓
	Windows 2003 Server, Standard Edition and Enterprise Edition, print driver only	✓	✓	✓	✓

Model name	M201n	M202n	M201dw	M202dw
Product number	CF455A	C6N20A	CF456A	C6N21A
Windows 2003 R2 Server 32-bit, Standard and Enterprise editions, print driver only	✓	✓	✓	✓
Windows 2003 R2 Server 64-bit, Standard and Enterprise editions, print driver only	✓	✓	✓	✓
Windows 2008 Server ,32-bit and 64-bit, (SP1 and higher) print driver only	✓	✓	✓	✓
Windows 2008 R2 Server 64-bit, SP1, print driver only	✓	✓	✓	✓
Windows 2008 R2 Server 64-bit, Standard and Enterprise editions, print driver only	✓	✓	✓	✓
Windows 2012 Server, print driver only	✓	✓	✓	✓
Windows 2012 R2 Server 64-bit, print driver only	✓	✓	✓	✓
Windows 2012 Server 64-bit, print driver only	✓	✓	✓	✓
Mac OS X v10.7 – v10.9	✓	✓	✓	✓
Supported print drivers	✓	✓	✓	✓
HP PCL6 discrete print driver This driver is included on the in-box CD as the default print driver.				
HP UPD PCL5c print driver Available for download	✓	✓	✓	✓
HP UPD PCL6 print driver Available for download	✓	✓	✓	✓

Model name		M201n	M202n	M201dw	M202dw
Product number		CF455A	C6N20A	CF456A	C6N21A
	HP UPD PS print driver Available for download	✓	✓	✓	✓
Connectivity	Hi-Speed USB 2.0	✓	✓	✓	✓
	10/100 Ethernet LAN connection	✓	✓	✓	✓
	Wireless network connection			✓	✓
Memory	128 MB RAM	✓	✓	✓	✓
Control-panel display	2-line LCD	✓	✓	✓	✓
Print	Prints 25 pages per minute (ppm) on A4-size paper and 26 ppm on Letter-size paper	✓	✓	✓	✓

Power consumption, electrical specifications, and acoustic emissions

See www.hp.com/support/ljM201, www.hp.com/support/ljM202 for current information.

CAUTION: Power requirements are based on the country/region where the product is sold. Do not convert operating voltages. This will damage the product and void the product warranty.

Operating-environment specifications

Environment	Recommended	Allowed
Temperature	17° to 25°C (62.6° to 77°F)	15° to 30°C (59° to 86°F)
Relative humidity	30% to 70% relative humidity (RH)	10% to 80% RH
Altitude	Not applicable	0 to 3048 m (0 to 10,000 ft)

Product views

- [Product front view](#)
- [Product back view](#)
- [Control-panel view](#)

Product front view



1	Output bin
2	Control panel (tilts up for easier viewing)
3	Power on/off button
4	Main input tray (Tray 2)
5	Priority input tray (Tray 1)
6	Handle for opening the top cover (access to the toner cartridge and for clearing jams)

Product back view

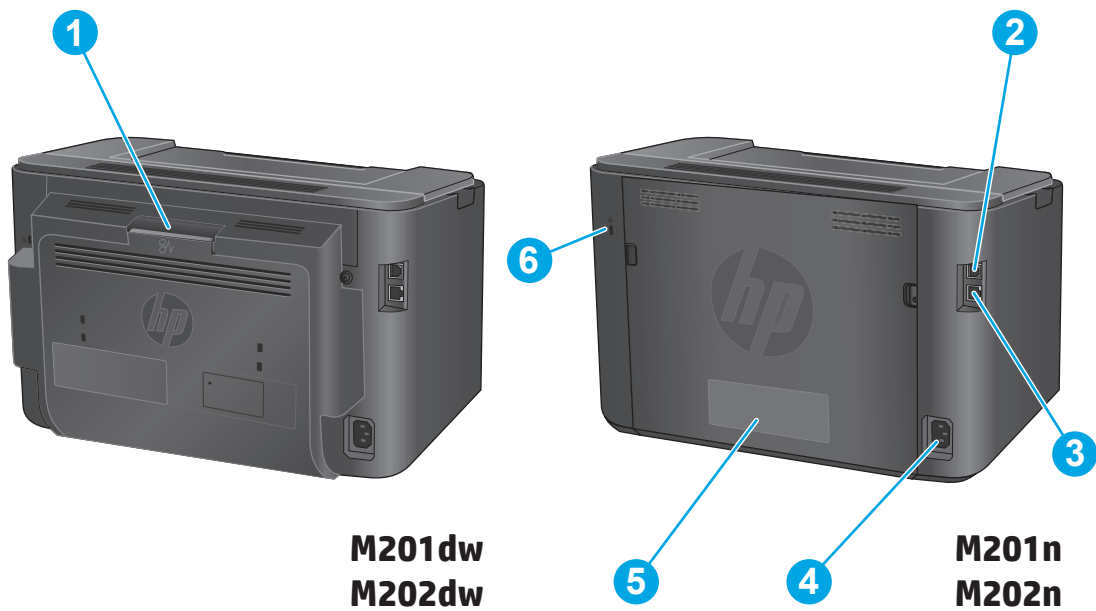

- | | |
|---|--|
| 1 | Rear door (access for clearing jams, dw models only) |
| 2 | Hi-Speed USB 2.0 |
| 3 | Ethernet port |
| 4 | Power connection |
| 5 | Product number and serial number label |
| 6 | Slot for cable-type security lock |

Control-panel view

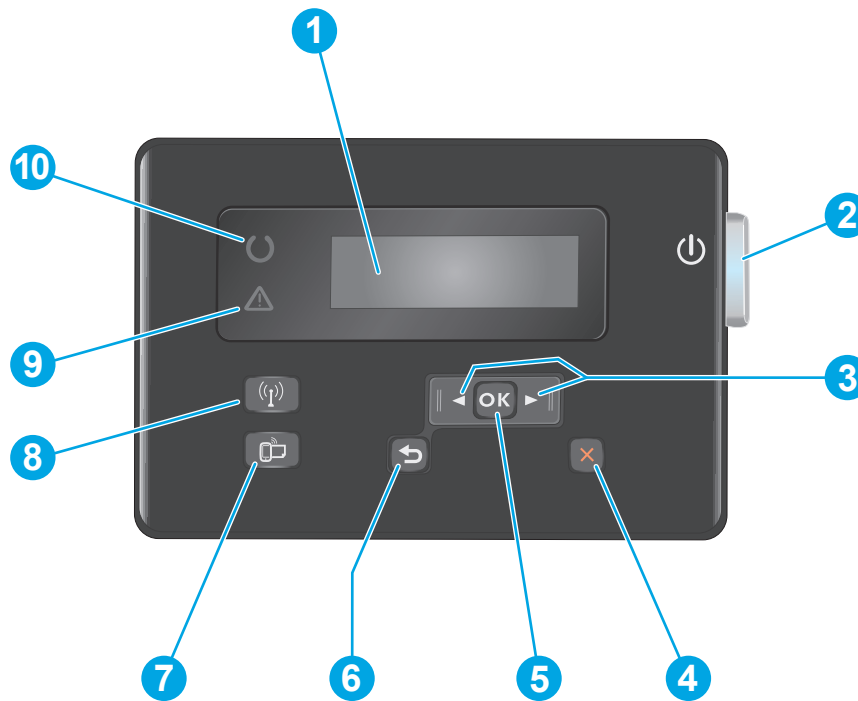

1	LCD display	Provides textual information, such as product status and configuration menus
2	Power on/off button	Turns the product on or off. The button illuminates when the product is on.
3	Left and right arrow buttons	Moves the cursor or scrolls through menu options
4	Cancel button	Clears settings, cancels the current job, or exits the current menu
5	OK button	Confirms a setting or an action to proceed
6	Back button	Returns to the previous screen
7	ePrint button	Opens the Web Services menu
8	Wireless button and light, dw models only	Provides access to the Wireless menu and wireless status information. When the product is connected to a wireless network, this button illuminates.
9	Attention light	Indicates the product has an error, a tray is empty, or other condition requiring attention
10	Ready light	Indicates the product is ready

Product hardware setup and software installation

For basic setup instructions, see the Hardware Installation Guide that came with the product. For additional instructions, go to HP support on the Web.

Go to www.hp.com/support/ljM201, www.hp.com/support/ljM202 for HP's all-inclusive help for the product. Find the following support:

- Install and configure
- Learn and use
- Solve problems
- Download software updates
- Join support forums
- Find warranty and regulatory information

2 Paper trays

- [Supported paper sizes and types](#)
- [Load the priority input tray \(Tray 1\)](#)
- [Load the main input tray \(Tray 2\)](#)

For more information:

Go to www.hp.com/support/ljM201, www.hp.com/support/ljM202.

HP's all-inclusive help for the product includes the following information:

- Install and configure
- Learn and use
- Solve problems
- Download software updates
- Join support forums
- Find warranty and regulatory information

Supported paper sizes and types

- [Supported paper sizes](#)
- [Supported paper types](#)

Supported paper sizes



NOTE: To obtain the best results, select the correct paper size and type in the print driver before printing.

Size	Dimensions	Priority input tray (Tray 1)	Main input tray (Tray 2)	Auto duplex
Letter	216 x 279 mm (8.5 x 11 in)	✓	✓	✓
Legal	216 x 356 mm (8.5 x 14 in)	✓	✓	
Executive	184 x 267 mm (7.3 x 10.5 in)	✓	✓	
Oficio 8.5 x 13	216 x 330 mm (8.5 x 13 in)	✓	✓	
4 x 6	102 x 152 mm (4 x 6 in)	✓		
5 x 8	127 x 203 mm (5 x 8 in)	✓	✓	
A4	210 x 297 mm (8.3 x 11.7 in)	✓	✓	✓
A5	148 x 210 mm (5.8 x 8.3 in)	✓	✓	
A6	105 x 148 mm (4.1 x 5.8 in)	✓		
B5 (JIS)	182 x 257 mm (7.2 x 10.1 in)	✓	✓	
B6 (JIS)	129 x 182 mm (5.1 x 7.2 in)	✓		
10 x 15cm	100 x 150 mm (3.9 x 5.9 in)	✓		
Oficio 216 x 340 mm	216 x 340 mm (8.5 x 13.4 in)	✓	✓	
16K	195 x 270 mm (7.7 x 10.6 in)	✓	✓	
16K	184 x 260 mm (7.2 x 10.3 in)	✓	✓	
16K	197 x 273 mm (7.8 x 10.8 in)	✓	✓	
Japanese Postcard	100 x 148 mm (3.9 x 5.8 in)	✓		
Postcard (JIS)				
Double Japan Postcard Rotated	200 x 148 mm (7.9 x 5.8 in)	✓	✓	
Double Postcard (JIS)				
Envelope #10	105 x 241 mm (4.1 x 9.5 in)	✓	✓	

Size	Dimensions	Priority input tray (Tray 1)	Main input tray (Tray 2)	Auto duplex
Envelope Monarch	98 x 191 mm (3.9 x 7.5 in)	✓	✓	
Envelope B5	176 x 250 mm (6.9 x 9.8 in)	✓	✓	
Envelope C5	162 x 229 mm (6.4 x 9 in)	✓	✓	
Envelope DL	110 x 220 mm (4.3 x 8.7 in)	✓	✓	
Custom	76 x 127 mm to 216 x 356 mm (3 x 5 in to 8.5 x 14 in)	✓		

Supported paper types



NOTE: To obtain the best results, select the correct paper size and type in the print driver before printing.

Type	Single-sided or manual duplex	Auto duplex
Plain	✓	✓
HP EcoSMART Lite	✓	✓
Light 60–74g	✓	✓
Intermediate 85–95g	✓	✓
Midweight 96–110g	✓	✓
Heavy 111–130g	✓	
Extra Heavy 131–175g	✓	
Transparency	✓	
Labels	✓	
Letterhead	✓	✓
Envelope	✓	
Preprinted	✓	✓
Prepunched	✓	✓
Colored	✓	✓
Bond	✓	✓
Recycled	✓	✓
Rough	✓	
Vellum	✓	

Load the priority input tray (Tray 1)

 **NOTE:** When adding new paper, make sure to remove all of the paper from the input tray and straighten the stack. Do not fan the paper. This reduces jams by preventing multiple sheets of paper from feeding through the product at one time. Use paper that is not wrinkled, folded, or damaged.

1. Load the paper face-up with the top forward in the input tray.

The orientation of the paper in the tray varies depending on the type of print job. For additional information, see [Table 2-1 Tray 1 paper orientation on page 13](#).



2. Adjust the paper guides until they are snug against the paper.



Table 2-1 Tray 1 paper orientation

Paper type	Duplex mode	How to load paper
Preprinted or letterhead	1-sided printing or manual 2-sided printing	Face-up Top edge leading into the product



A top-down view of the printer's priority input tray (Tray 1) with the lid open. The paper is already in the tray, and the number '123' is visible on the top edge, which is leading into the product.

Table 2-1 Tray 1 paper orientation (continued)

Paper type	Duplex mode	How to load paper
Punch holes	1-sided printing or manual 2-sided printing	Face-up Holes toward the left side of the product
Envelopes	1-sided printing	Face-up Top edge toward the right of the tray, postage end entering the product last

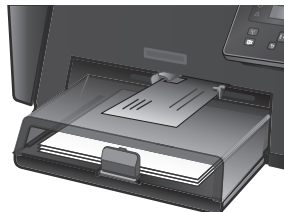

Load the main input tray (Tray 2)

 **NOTE:** When adding new paper, make sure to remove all of the paper from the input tray and straighten the stack. Do not fan the paper. This reduces jams by preventing multiple sheets of paper from feeding through the product at one time. Use paper that is not wrinkled, folded, or damaged.

1. Open the dust cover.



2. Load the paper into the tray. Make sure that the paper fits under the tabs and below the maximum-height indicators.

The orientation of the paper in the tray varies depending on the type of print job. For additional information, see [Table 2-2 Tray 2 paper orientation on page 17](#).





3. Adjust the paper guides until they are snug against the paper.



4. Close the dust cover.



Table 2-2 Tray 2 paper orientation

Paper type	Duplex mode	How to load paper
Preprinted or letterhead	1-sided printing or 2-sided printing	Face-up Top edge leading into the product 
Prepunched	1-sided printing or 2-sided printing	Face-up Holes toward the left side of the product 

3 Parts, supplies, and accessories

- [Order parts, accessories, and supplies](#)
- [Replace the toner cartridge](#)

For more information:

Go to www.hp.com/support/ljM201, www.hp.com/support/ljM202.

HP's all-inclusive help for the product includes the following information:

- Install and configure
- Learn and use
- Solve problems
- Download software updates
- Join support forums
- Find warranty and regulatory information

Order parts, accessories, and supplies

Ordering

Order supplies and paper	www.hp.com/go/suresupply
Order genuine HP parts or accessories	www.hp.com/buy/parts
Order through service or support providers	Contact an HP-authorized service or support provider.
Order using the HP Embedded Web Server (EWS)	To access, in a supported Web browser on your computer, enter the product IP address or host name in the address/URL field. The EWS contains a link to the HP SureSupply Web site, which provides options for purchasing Original HP supplies.

Supplies and accessories

Item	Description	Part number
HP 83A Toner Cartridge	Replacement toner cartridge	CF283A
HP 83X Toner Cartridge	High-capacity replacement toner cartridge	CF283X
HP 88A Toner Cartridge	Replacement toner cartridge for China and India only	CC388A
USB cable	2-meter standard USB-compatible device connector	C6518A

Replace the toner cartridge

When a toner cartridge approaches the end of useful life, the product displays a prompt to order a replacement. Printing can continue with the current cartridge until redistributing the toner no longer yields acceptable print quality.

A second message displays on the control panel when the toner cartridge reaches the “very low” state.

1. Open the top cover.



2. Remove the toner cartridge.



3. Remove the new toner cartridge from the bag. Place the used toner cartridge in the bag for recycling.

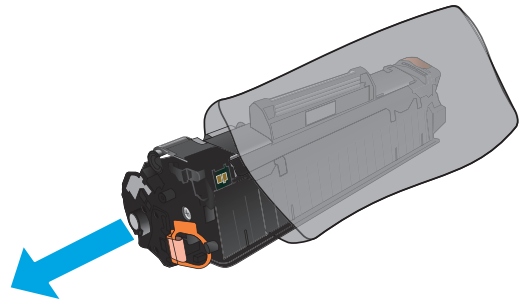

4. Grasp both sides of the toner cartridge and distribute the toner by gently rocking the cartridge.

CAUTION: Do not touch the shutter or the surface of the roller.

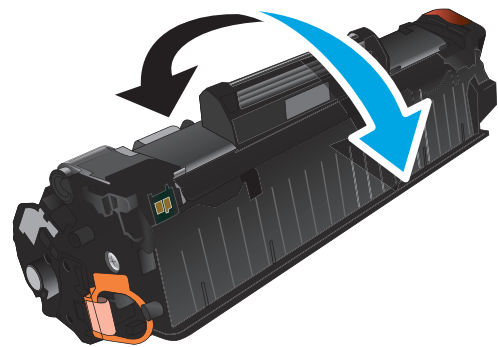

5. Bend the tab on the left side of the cartridge until the tab breaks loose. Pull the tab until all the tape is removed from the cartridge. Place the tab and tape in the toner cartridge box to return for recycling.

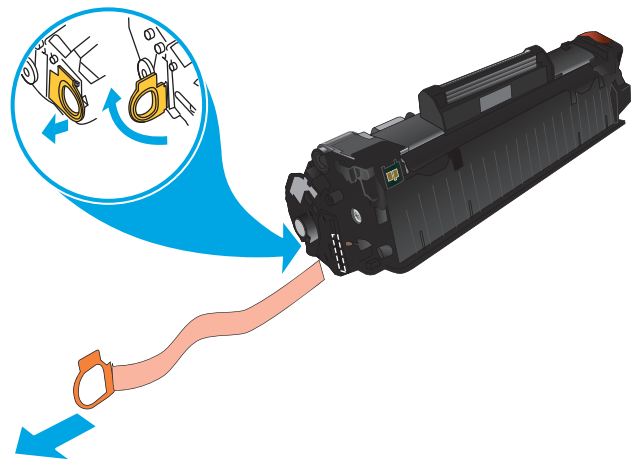

6. Align the toner cartridge with the tracks inside the product, and then insert the toner cartridge until it is firmly seated.

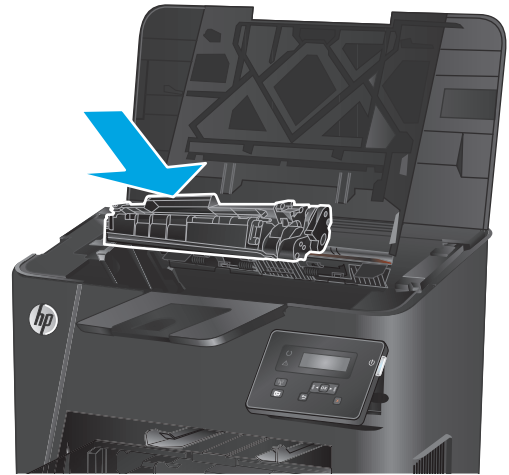

7. Close the top cover.



4 Print

- [Print tasks \(Windows\)](#)
- [Print tasks \(Mac OS X\)](#)
- [Set up HP Wireless Direct Printing](#)
- [Mobile printing](#)

For more information:

Go to www.hp.com/support/ljM201, www.hp.com/support/ljM202.

HP's all-inclusive help for the product includes the following information:

- Install and configure
- Learn and use
- Solve problems
- Download software updates
- Join support forums
- Find warranty and regulatory information

Print tasks (Windows)

- [How to print \(Windows\)](#)
- [Automatically print on both sides \(Windows\)](#)
- [Manually print on both sides \(Windows\)](#)
- [Print multiple pages per sheet \(Windows\)](#)
- [Select the paper type \(Windows\)](#)
- [Additional print tasks](#)

How to print (Windows)

The following procedure describes the basic printing process for Windows.

1. From the software program, select the **Print** option.
2. Select the product from the list of printers. To change settings, click or tap the **Properties** or **Preferences** button to open the print driver.



NOTE: The name of the button varies for different software programs.

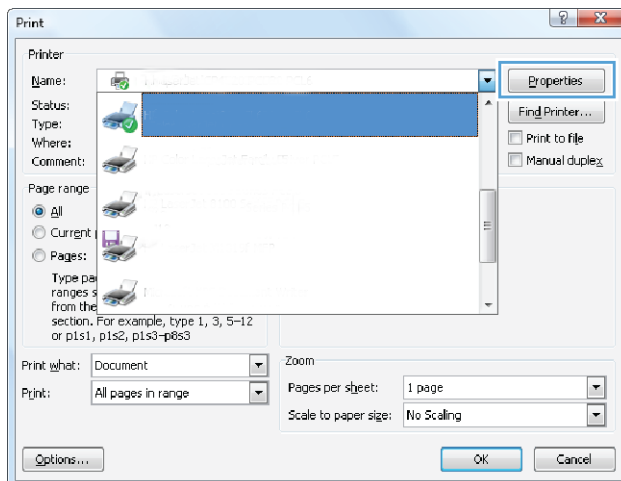

3. Click or tap the tabs in the print driver to configure the available options. For example, set the paper orientation on the **Finishing** tab, and set the paper source, paper type, paper size, and quality settings on the **Paper/Quality** tab.

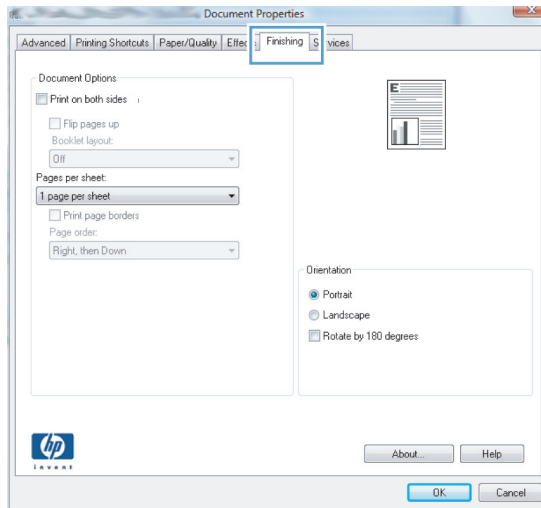

4. Click or tap the **OK** button to return to the **Print** dialog box. Select the number of copies to print from this screen.
5. Click or tap the **OK** button to print the job.

Automatically print on both sides (Windows)

Use this procedure for products that have an automatic duplexer installed. If the product does not have an automatic duplexer installed, or to print on paper types that the duplexer does not support, you can print on both sides manually.

1. From the software program, select the **Print** option.
2. Select the product from the list of printers, and then click or tap the **Properties** or **Preferences** button to open the print driver.



NOTE: The name of the button varies for different software programs.

3. Click or tap the **Finishing** tab.
4. Select the **Print on both sides** check box. Click the **OK** button to close the **Document Properties** dialog box.
5. In the **Print** dialog box, click the **OK** button to print the job.

Manually print on both sides (Windows)

Use this procedure for products that do not have an automatic duplexer installed or to print on paper that the duplexer does not support.

1. From the software program, select the **Print** option.
2. Select the product from the list of printers, and then click or tap the **Properties** or **Preferences** button to open the print driver.



NOTE: The name of the button varies for different software programs.

3. Click or tap the **Finishing** tab.
4. Select the **Print on both sides (manually)** check box. Click the **OK** button to print the first side of the job.
5. Retrieve the printed stack from the output bin, and place it in Tray 1.
6. If prompted, touch the appropriate control panel button to continue.

Print multiple pages per sheet (Windows)

1. From the software program, select the **Print** option.
2. Select the product from the list of printers, and then click or tap the **Properties** or **Preferences** button to open the print driver.



NOTE: The name of the button varies for different software programs.

3. Click or tap the **Finishing** tab.
4. Select the number of pages per sheet from the **Pages per sheet** drop-down list.
5. Select the correct **Print page borders**, **Page order**, and **Orientation** options. Click the **OK** button to close the **Document Properties** dialog box.
6. In the **Print** dialog box, click the **OK** button to print the job.

Select the paper type (Windows)

1. From the software program, select the **Print** option.
2. Select the product from the list of printers, and then click or tap the **Properties** or **Preferences** button to open the print driver.



NOTE: The name of the button varies for different software programs.

3. Click or tap the **Paper/Quality** tab.
4. From the **Paper type** drop-down list, click the **More...** option.
5. Expand the list of **Type is:** options.
6. Expand the category of paper types that best describes your paper.
7. Select the option for the type of paper you are using, and then click the **OK** button.
8. Click the **OK** button to close the **Document Properties** dialog box. In the **Print** dialog box, click the **OK** button to print the job.

Additional print tasks

Go to www.hp.com/support/ljM201, www.hp.com/support/ljM202.

Instructions are available for performing specific print tasks, such as the following:

- Create and use printing shortcuts or presets
- Select the paper size, or use a custom paper size
- Select the page orientation
- Create a booklet
- Scale a document to fit a specific paper size
- Print the first or last pages of the document on different paper
- Print watermarks on a document

Print tasks (Mac OS X)

- [How to print \(OS X\)](#)
- [Automatically print on both sides \(OS X\)](#)
- [Manually print on both sides \(OS X\)](#)
- [Print multiple pages per sheet \(OS X\)](#)
- [Select the paper type \(OS X\)](#)
- [Additional print tasks](#)

How to print (OS X)

The following procedure describes the basic printing process for OS X.

1. Click the **File** menu, and then click the **Print** option.
2. Select the product.
3. Click **Show Details**, and then select other menus to adjust the print settings.
4. Click the **Print** button.

Automatically print on both sides (OS X)

 **NOTE:** This information applies to products that include an automatic duplexer.

 **NOTE:** This feature is available if you install the HP print driver. It might not be available if you are using AirPrint.

1. Click the **File** menu, and then click the **Print** option.
2. Select the product.
3. Click **Show Details**, and then click the **Layout** menu.
4. Select a binding option from the **Two-Sided** drop-down list.
5. Click the **Print** button.

Manually print on both sides (OS X)

 **NOTE:** This feature is available if you install the HP print driver. It might not be available if you are using AirPrint.

1. Click the **File** menu, and then click the **Print** option.
2. Select the product.
3. Click **Show Details**, and then click the **Manual Duplex** menu.
4. Click the **Manual Duplex** box, and select a binding option.
5. Click the **Print** button.
6. Go to the product, and remove any blank paper that is in Tray 1.

7. Retrieve the printed stack from the output bin and place it with the printed-side facing down in the input tray.
8. If prompted, touch the appropriate control panel button to continue.

Print multiple pages per sheet (OS X)

1. Click the **File** menu, and then click the **Print** option.
2. Select the product.
3. Click **Show Details**, and then click the **Layout** menu.
4. From the **Pages per Sheet** drop-down list, select the number of pages that you want to print on each sheet.
5. In the **Layout Direction** area, select the order and placement of the pages on the sheet.
6. From the **Borders** menu, select the type of border to print around each page on the sheet.
7. Click the **Print** button.

Select the paper type (OS X)

1. Click the **File** menu, and then click the **Print** option.
2. Select the product.
3. Click **Show Details**, and then click the **Media & Quality** menu or the **Paper/Quality** menu.
4. Select a type from the **Media-type** drop-down list.
5. Click the **Print** button.

Additional print tasks

Go to www.hp.com/support/ljM201, www.hp.com/support/ljM202.

Instructions are available for performing specific print tasks, such as the following:

- Create and use printing shortcuts or presets
- Select the paper size, or use a custom paper size
- Select the page orientation
- Create a booklet
- Scale a document to fit a specific paper size
- Print the first or last pages of the document on different paper
- Print watermarks on a document

Set up HP Wireless Direct Printing



NOTE: This feature is available with wireless models only and the product might require a firmware update to use this feature.

The HP Wireless Direct Printing feature lets you print from your wireless mobile device directly to an HP Wireless Direct-enabled product without requiring connection to an established network or the Internet. Use HP Wireless Direct to print wirelessly from the following devices:

- iPhone, iPad, or iTouch using Apple AirPrint or the HP ePrint mobile app
- Mobile devices that run Android or Symbian using the HP ePrint Home & Biz application
- Any Wi-Fi capable computer with any operating system.

For more information on HP Wireless Direct, go to www.hp.com/go/wirelessprinting, and then click **HP Wireless Direct**.

To set up HP Wireless Direct from the control panel, complete the following steps:

1. At the product control panel, press the **OK** button to open the menus.
2. Use the arrow buttons to open the following menus:
 - **Network Setup**
 - **Wireless Menu**
 - **Wireless Direct**
3. Select the **On** option, and then press the **OK** button. The product saves the setting and then returns the control panel to the **Wireless Direct Settings** menu.

Mobile printing

HP offers multiple Mobile and ePrint solutions to enable wireless printing to an HP printer from a laptop, tablet, smartphone, or other mobile device. To determine the best choice, go to www.hp.com/go/LaserJetMobilePrinting (English only).

- [HP ePrint via email](#)
- [HP ePrint software](#)
- [AirPrint](#)

HP ePrint via email

Use HP ePrint to print documents by sending them as an email attachment to the product's email address from any email enabled device.

To use HP ePrint, the product must meet these requirements:

- The product must be connected to a wired network and have Internet access.
- HP Web Services must be enabled on the product, and the product must be registered with HP Connected.
 1. On the product control panel, press the **OK** button.
 2. Scroll to the **HP Web Services** menu, and press the **OK** button.
 3. Scroll to the **Print Information Sheet** option, and press the **OK** button.

The information page contains the printer code that you use to register your HP product at HP Connected.

4. Go to www.hpconnected.com to create an HP ePrint account and complete the setup process.

For more information, go to www.hp.com/support to review additional support information for your product.

HP ePrint software

The HP ePrint software makes it easy to print from a Windows or Mac desktop or laptop computer to any HP ePrint-capable product. This software makes it easy to find HP ePrint-enabled products that are registered to your HP Connected account. The target HP printer can be located in the office or at locations across the globe.

- **Windows:** After installing the software, open the **Print** option from within your application, and then select **HP ePrint** from the installed printers list. Click the **Properties** button to configure print options.
- **Mac:** After installing the software, select **File, Print**, and then select the arrow next to **PDF** (in the bottom left of the driver screen). Select **HP ePrint**.

For Windows, the HP ePrint software supports TCP/IP printing to local network printers on the network (LAN or WAN) to products that support UPD PostScript®.

Windows and Mac both support IPP printing to LAN or WAN network-connected products that support ePCL.

Windows and Mac also both support printing PDF documents to public print locations and printing using HP ePrint via email through the cloud.

Go to www.hp.com/go/eprintsoftware for drivers and information.



NOTE: The HP ePrint software is a PDF workflow utility for Mac, and is not technically a print driver.



NOTE: HP ePrint Software does not support USB printing.

AirPrint

Direct printing using Apple's AirPrint is supported for iOS 4.2 or later. Use AirPrint to print directly to the product from an iPad, iPhone (3GS or later), or iPod touch (third generation or later) in the following applications:

- Mail
- Photos
- Safari
- iBooks
- Select third-party applications

To use AirPrint, the product must be connected to the same wireless network as the Apple device. For more information about using AirPrint and about which HP products are compatible with AirPrint, go to the support Web site for this product:

www.hp.com/support/ljM201, www.hp.com/support/ljM202



NOTE: AirPrint does not support USB connections.

5 Manage the product

- [Change the product connection type \(Windows\)](#)
- [Advanced configuration with HP Embedded Web Server \(EWS\) and HP Device Toolbox \(Windows\)](#)
- [Advanced configuration with HP Utility for Mac OS X](#)
- [Configure IP network settings](#)
- [HP Web Jetadmin](#)
- [Product security features](#)
- [Economy settings](#)
- [Update the firmware](#)

For more information:

Go to www.hp.com/support/ljM201, www.hp.com/support/ljM202.

HP's all-inclusive help for the product includes the following information:

- Install and configure
- Learn and use
- Solve problems
- Download software updates
- Join support forums
- Find warranty and regulatory information

Change the product connection type (Windows)

If you are already using the product and you wish to change the way it is connected, use the **Reconfigure your HP Device** shortcut on your computer desktop to change the connection. For example, you can reconfigure the product to use a different wireless address, to connect to a wired or wireless network, or change from a network connection to a USB connection. You can change the configuration without inserting the product CD. After you select the type of connection you wish to make, the program goes directly to the portion of the product setup procedure that needs to change.

Advanced configuration with HP Embedded Web Server (EWS) and HP Device Toolbox (Windows)

Use the HP Embedded Web Server to manage printing functions from your computer instead of the product control panel.

- View product status information
- Determine the remaining life for all supplies and order new ones
- View and change tray configurations
- View and change the product control-panel menu configuration
- View and print internal pages
- Receive notification of product and supplies events
- View and change network configuration

The HP Embedded Web Server works when the product is connected to an IP-based network. The HP Embedded Web Server does not support IPX-based product connections. You do not have to have Internet access to open and use the HP Embedded Web Server.

When the product is connected to the network, the HP Embedded Web Server is automatically available.

 **NOTE:** HP Device Toolbox is available only if you performed a full installation when you installed the product. Depending on how the product is connected, some features might not be available.

 **NOTE:** The HP Embedded Web Server is not accessible beyond the network firewall.

Open the HP Embedded Web Server (EWS) from the Start menu

1. Click the **Start** button, and then click the **Programs** item.
2. Click your HP product group, and then click the **HP Device Toolbox** item.

Open the HP Embedded Web Server (EWS) from a Web browser

1. Print a configuration page, and locate the IP address.
 - a. On the control panel, press the **OK** button.
 - b. Scroll to the **Reports** menu, and then press the **OK** button.
 - c. Scroll to the **Configuration Report**, and then press the **OK** button to print the report.
2. Open a Web browser, and in the address line, type the IP address as it displays on the product control panel. Press the **Enter** key on the computer keyboard. The EWS opens.

 <https://10.10.XX.XXX/>

Tab or section	Description
<p>Home tab</p> <p>Provides product, status, and configuration information.</p>	<ul style="list-style-type: none"> • Device Status: Shows the product status and shows the approximate percent life remaining of HP supplies. • Supplies Status: Shows the approximate percent life remaining of HP supplies. Actual supply life remaining can vary. Consider having a replacement supply available to install when print quality is no longer acceptable. The supply does not need to be replaced unless the print quality is no longer acceptable. • Device Configuration: Shows the information found on the product configuration page. • Network Summary: Shows the information found on the product network configuration page. • Reports: Print the configuration and supplies status pages that the product generates. • Event Log: Shows a list of all product events and errors.
<p>System tab</p> <p>Provides the ability to configure the product from your computer.</p>	<ul style="list-style-type: none"> • Device Information: Provides basic product and company information. • Paper Setup: Change the default paper-handling settings for the product. • Print Quality: Change the default print-quality settings for the product. • EcoSMART Console: Change the default times for entering Sleep mode or Auto Power Down mode. Configure which events cause the product to wake. • Paper Types: Configure print modes that correspond to the paper types that the product accepts. • System Setup: Change the system defaults for the product. • Service: Perform the cleaning procedure on the product. • Save and Restore: Save the current settings for the product to a file on the computer. Use this file to load the same settings onto another product or to restore these settings to this product at a later time. • Administration: Set or change the product password. Enable or disable product features. <p>NOTE: The System tab can be password-protected. If this product is on a network, always consult with the administrator before changing settings on this tab.</p>
<p>Print tab</p> <p>Provides the ability to change default print settings from your computer.</p>	<ul style="list-style-type: none"> • Printing: Change the default product print settings, such as number of copies and paper orientation. These are the same options that are available on the control panel. • PCL5c: View and change the PCL5c settings. • PostScript: Turn off or on the Print PS Errors feature.
<p>Networking tab</p> <p>(Network-connected products only)</p> <p>Provides the ability to change network settings from your computer.</p>	<p>Network administrators can use this tab to control network-related settings for the product when it is connected to an IP-based network. It also allows the network administrator to set up Wireless Direct functionality. This tab does not appear if the product is directly connected to a computer.</p>
<p>HP Web Services tab</p>	<p>Use this tab to set up and use various Web tools with the product.</p>

Advanced configuration with HP Utility for Mac OS X

Use the HP Utility to check product status or to view or change product settings from your computer.

You can use the HP Utility when the product is connected with a USB cable or is connected to a TCP/IP-based network.

Open HP Utility

1. At the computer, open the **System Preferences** menu, and then click **Print & Fax, Print & Scan, or Printers & Scanners**.
2. Select the product in the list.
3. Click the **Options & Supplies** button.
4. Click the **Utility** tab.
5. Click the **Open Printer Utility** button.

HP Utility features

The HP Utility toolbar includes these items:

- **Devices:** Click this button to show or hide Mac products found by the HP Utility.
- **All Settings:** Click this button to return to the HP Utility main view.
- **HP Support:** Click this button to open a browser and go to the HP support Web site.
- **Supplies:** Click this button to open the HP SureSupply Web site.
- **Registration:** Click this button to open the HP registration Web site.
- **Recycling:** Click this button to open the HP Planet Partners Recycling Program Web site.

HP Utility consists of pages that you open by clicking in the **All Settings** list. The following table describes the tasks that you can perform with HP Utility.

Menu	Description
Information And Support	<ul style="list-style-type: none">• Supplies Status: Show the product supplies status and provides links for ordering supplies online.• Device Information: Show information about the currently selected product, including the product Service ID (if assigned), the firmware version (FW Version), the Serial Number, and the IP address.• File Upload: Transfer files from the computer to the product. You can upload the following types of files:<ul style="list-style-type: none">◦ HP LaserJet printer command language (.PRN)◦ Portable document format (.PDF)

Menu	Description
	<ul style="list-style-type: none"> ◦ Postscript (.PS) ◦ Text (.TXT) • HP Connected: Access the HP Connected Web site. • Upload Fonts: Upload fonts from your computer to the product.
Printer Settings	<ul style="list-style-type: none"> • Auto-off: Configure the product to automatically turn off after a period of inactivity. You can adjust the number of minutes after which the product turns off. • Network Settings: Configure the network settings, such as the IPv4 settings, IPv6 settings, Bonjour settings, and other settings. • Supplies Management: Configure how the product should behave when supplies are nearing the end of their estimated life. • Trays Configuration: Change paper size and type for each of the trays. • Additional Settings: Open the HP Embedded Web Server (EWS) for the product. <p>NOTE: USB connections are not supported.</p>
Information	<p>Message Center: Display error events that have occurred with the product.</p>
Fax Settings (MFP fax models only)	<ul style="list-style-type: none"> • Basic Fax Settings: Set up the fields in the fax header and configure how the product answers incoming calls. • Junk Fax Blocking: Store the fax numbers you want to block. • Fax Forwarding: Set up the product to send the incoming faxes to a different number. • Fax Logs: View the logs of all faxes. • Fax Speed Dials: Add fax numbers to the speed dial list.
Scan Settings (MFP touchscreen models only)	<ul style="list-style-type: none"> • Scan to E-mail: Open the HP Embedded Web Server (EWS) page for configuring settings for scanning to email. • Scan to Network Folder: Open the HP Embedded Web Server (EWS) page for configuring settings for scanning to a network folder. <p>NOTE: USB connections are not supported.</p>

Configure IP network settings

- [Printer sharing disclaimer](#)
- [View or change network settings](#)
- [Rename the product on a network](#)
- [Manually configure IPv4 TCP/IP parameters from the control panel](#)

Printer sharing disclaimer

HP does not support peer-to-peer networking, as the feature is a function of Microsoft operating systems and not of the HP printer drivers. Go to Microsoft at www.microsoft.com.

View or change network settings

Use the HP Embedded Web Server to view or change IP configuration settings.

1. Print a configuration page, and locate the IP address.
 - a. On the control panel, press the **OK** button.
 - b. Scroll to the **Reports** menu, and then press the **OK** button.
 - c. Scroll to the **Configuration Report** option, and then press the **OK** button to print the report.
2. Open a Web browser, and in the address line, type the IP address exactly as it displays on the product control panel. Press the **Enter** key on the computer keyboard. The EWS opens.



3. Click the **Networking** tab to obtain network information. Change settings as needed.

Rename the product on a network

If you want to rename the product on a network so that it can be uniquely identified, use the HP Embedded Web Server.

1. Print a configuration page, and locate the IP address.
 - a. On the control panel, press the **OK** button.
 - b. Scroll to the **Reports** menu, and then press the **OK** button.
 - c. Scroll to the **Configuration Report** option, and then press the **OK** button to print the report.
2. Open a Web browser, and in the address line, type the IP address as it displays on the product control panel. Press the **Enter** key on the computer keyboard. The EWS opens.

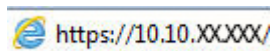

3. Open the **System** tab.

4. On the **Device Information** page, the default product name is in the **Device Status** field. You can change this name to uniquely identify this product.



NOTE: Completing the other fields on this page is optional.

5. Click the **Apply** button to save the changes.

Manually configure IPv4 TCP/IP parameters from the control panel

Use the control-panel menus to manually set an IPv4 address, subnet mask, and default gateway.

1. On the product control panel, press the **OK** button.
2. Open the following menus:
 - **Network Setup**
 - **IPV4 Config Method**
 - **Manual**
3. Use the arrow keys to enter the IP address, and press the **OK** button. Press the **OK** button again to confirm.
4. Use the arrow keys to enter the subnet mask, and press the **OK** button. Press the **OK** button again to confirm.
5. Use the arrow keys to enter the default gateway, and press the **OK** button. Press the **OK** button again to confirm.

HP Web Jetadmin

HP Web Jetadmin is an award-winning, industry-leading tool for efficiently managing a wide variety of networked HP products, including printers, multifunction products, and digital senders. This single solution allows you to remotely install, monitor, maintain, troubleshoot, and secure your printing and imaging environment — ultimately increasing business productivity by helping you save time, control costs, and protect your investment.

HP Web Jetadmin upgrades are periodically made available to provide support for specific product features. Go to www.hp.com/go/webjetadmin and click the **Self Help and Documentation** link to learn more about upgrades.

Product security features

The product supports security standards and recommended protocols that help you keep the product secure, protect critical information on your network, and simplify the way you monitor and maintain the product.

For in-depth information about HP's secure imaging and printing solutions, visit www.hp.com/go/secureprinting. The site provides links to white papers and FAQ documents about security features.

Set or change the product password using the HP Embedded Web Server

Use the HP Embedded Web Server to set a password or change an existing password for a product on a network.

1. Print a configuration page, and locate the IP address.
 - a. On the control panel, press the **OK** button.
 - b. Scroll to the **Reports** menu, and then press the **OK** button.
 - c. Scroll to the **Configuration Report**, and then press the **OK** button to print the report.
2. Open a Web browser, and in the address line, type the IP address exactly as it displays on the product control panel. Press the **Enter** key on the computer keyboard. The EWS opens.

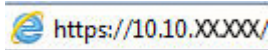

3. Click the **System** tab, and click either the **Product Security** or the **Administration** link.

 **NOTE:** If a password has previously been set, you are prompted to provide the password. Enter the password, and then click the **Apply** button.

4. Enter the new password in the **Password** box and in the **Confirm Password** box.
5. At the bottom of the window, click the **Apply** button to save the password.

 **NOTE:** For products connected with a USB cable to a Windows computer, use the HP Device Toolbox to change the product password:

1. Click the **Start** button, and then click the **Programs** item.
 2. Click your HP product group, and then click the **HP Device Toolbox** item.
 3. Click the **System** tab.
 4. Click **Administration**, and locate the area to change the password.
-

Economy settings

- [Print with EconoMode](#)
- [Set the Sleep Delay](#)
- [Set the Auto Power Down delay](#)

Print with EconoMode

This product has an EconoMode option for printing drafts of documents. Using EconoMode can use less toner. However, using EconoMode can also reduce print quality.

HP does not recommend the full-time use of EconoMode. If EconoMode is used full-time, the toner supply might outlast the mechanical parts in the toner cartridge. If print quality begins to degrade and is no longer acceptable, consider replacing the toner cartridge.



NOTE: If this option is not available in your print driver, you can set it using the HP Embedded Web Server.

1. From the software program, select the **Print** option.
2. Select the product, and then click the **Properties** or **Preferences** button.
3. Click the **Paper/Quality** tab.
4. Click the **EconoMode** check box.

Set the Sleep Delay

1. On the product control panel, press the **OK** button.
2. Open the following menus:
 - **System Setup**
 - **Energy Settings**
 - **Sleep Delay**
3. Select the time for the sleep delay, and then press the **OK** button.



NOTE: The default value is **1 Minute**.

Set the Auto Power Down delay



NOTE: This setting is not available on all products.

1. On the product control panel, touch the **OK** button.
2. Open the following menus:
 - **System Setup**
 - **Energy Settings**

- **Auto Power Down**
- **Power Down Delay**

3. Select the time for the power-down delay.



NOTE: The default value is **2 Hours**.

4. The product automatically wakes from the auto power-down mode when it receives jobs or when you touch the screen on the product control panel. You can change which events cause the product to wake. Open the following menus:

- **System Setup**
- **Energy Settings**
- **Auto Power Down**
- **Wake Events**

To turn off a wake event, select the event, select **No**, and then press the **OK** button.

Update the firmware

HP offers periodic product updates, new Web Services apps, and new features to existing Web Services apps. Follow these steps to update the product firmware for a single product. When you update the firmware, Web Service apps will update automatically.

There are two supported methods to perform a firmware update on this product. Use only one of the following methods to update the product firmware.

Method one: Update the firmware using the control panel

Use these steps to load the firmware from the control panel (for network-connected products only), and/or set the product to automatically load future firmware updates. For USB-connected products, skip to method two.

1. Make sure the product is connected to a wired (Ethernet) network with an active Internet connection.



NOTE: The product must be connected to the Internet to update the firmware via a network connection.

2. On the product control panel, press the **OK** button.
3. Open the following menus:
 - **Service**
 - **LaserJet Update**
4. Scroll to the **Check for Updates Now** option, and press the **OK** button.



NOTE: The product automatically checks for an update, and if a newer version is detected, the update process automatically starts.

5. Set the product to automatically update the firmware when updates become available.
 - a. On the product control panel, press the **OK** button.
 - b. Open the following menus:
 - **Service**
 - **LaserJet Update**
 - **Manage Updates**
 - c. Set the **Allow Updates** option to **YES**, and then set the **Automatic Check** option to **ON**. Press the **OK** button.

Method two: Update the firmware using the Firmware Update Utility

Use these steps to manually download and install the Firmware Update Utility from HP.com.



NOTE: This method is the only firmware update option available for products connected to the computer via a USB cable. It also works for products connected to a network.

1. Go to www.hp.com/go/support, click the **Drivers & Software** link, type the product name in the search field, press the **ENTER** button, and then select the product from the list of search results.
2. Select the operating system.
3. Under the **Firmware** section, locate the **Firmware Update Utility**.
4. Click **Download**, click **Run**, and then click **Run** again.
5. When the utility launches, select the product from the drop-down list, and then click **Send Firmware**.



NOTE: To print a configuration page to verify the installed firmware version before or after the update process, click **Print Config**.

6. Follow the on-screen instructions to complete the installation, and then click the **Exit** button to close the utility.

6 Solve problems

- [Customer support](#)
- [Restore the factory-set defaults](#)
- [A “Cartridge is low” or “Cartridge is very low” message displays on the product control panel](#)
- [Product does not pick up paper or misfeeds](#)
- [Clear jams](#)
- [Improve print quality](#)
- [Solve wired network problems](#)
- [Solve wireless network problems](#)

For more information:

Go to www.hp.com/support/ljM201, www.hp.com/support/ljM202.

HP's all-inclusive help for the product includes the following information:

- Install and configure
- Learn and use
- Solve problems
- Download software updates
- Join support forums
- Find warranty and regulatory information

Customer support

Get telephone support for your country/region	Country/region phone numbers are on the flyer that was in the box with your product or at www.hp.com/support/ .
Have the product name, serial number, date of purchase, and problem description ready.	
Get 24-hour Internet support	www.hp.com/support/ljM201 , www.hp.com/support/ljM202
Download software utilities, drivers, and electronic information	www.hp.com/support/ljM201 , www.hp.com/support/ljM202
Order additional HP service or maintenance agreements	www.hp.com/go/carepack
Register your product	www.register.hp.com

Restore the factory-set defaults

Restoring the factory-set defaults returns all of the product and network settings to the factory defaults. It will not reset the page count, tray size, or language. To restore the product to the factory-default settings, follow these steps.

 **CAUTION:** Restoring the factory-set defaults returns all of the settings to the factory defaults, and it also deletes any pages that are stored in the memory. The procedure then automatically restarts the product.

1. On the product control panel, press the **OK** button to open the menus.
2. Open the following menus:
 - **Service**
 - **Restore Defaults**

The product automatically restarts.

A “Cartridge is low” or “Cartridge is very low” message displays on the product control panel

Cartridge is low: The product indicates when a toner cartridge level is low. Actual toner cartridge life remaining may vary. Consider having a replacement available to install when print quality is no longer acceptable. The toner cartridge does not need to be replaced now.

Cartridge is very low: The product indicates when the toner cartridge level is very low. Actual toner cartridge life remaining may vary. Consider having a replacement available to install when print quality is no longer acceptable. The toner cartridge does not need to be replaced now unless the print quality is no longer acceptable.

Once an HP toner cartridge has reached **Very Low**, HP’s Premium Protection Warranty on that toner cartridge has ended.

Change the “Very Low” settings

Use the product control panel to change the way the product reacts when supplies reach the Very Low state. It is not necessary to re-establish these settings after installing a new toner cartridge.

1. On the product control panel, press the **OK** button.
2. Open the following menus:
 - **System Setup**
 - **Supply Settings**
 - **Black Cartridge**
 - **Very Low Setting**
3. Select one of the following options:
 - Select the **Stop** option to set the product to stop printing when the cartridge reaches the **Very Low** threshold.
 - Select the **Prompt** option to set the product to stop printing when the cartridge reaches the **Very Low** threshold. Acknowledge the prompt or replace the cartridge to resume printing.
 - Select the **Continue** option to set the product to display an alert that the cartridge is very low, and to continue printing beyond the **Very Low** setting without interaction. This can result in unsatisfactory print quality.

Order supplies

Order supplies and paper	www.hp.com/go/suresupply
Order through service or support providers	Contact an HP-authorized service or support provider.
Order using the HP Embedded Web Server (EWS)	To access, in a supported Web browser on your computer, enter the product IP address or host name in the address/URL field. The EWS contains a link to the HP SureSupply Web site, which provides options for purchasing Original HP supplies.

Product does not pick up paper or misfeeds

- [The product does not pick up paper](#)
- [The product picks up multiple sheets of paper](#)

The product does not pick up paper

If the product does not pick up paper from the tray, try these solutions.

1. Open the product and remove any jammed sheets of paper.
2. Load the tray with the correct size of paper for your job.
3. Make sure the paper size and type are set correctly on the product control panel.
4. Make sure the paper guides in the tray are adjusted correctly for the size of paper. Adjust the guides to the appropriate indentation in the tray.
5. Check the product control panel to see if the product is waiting for you to acknowledge a prompt to feed the paper manually. Load paper, and continue.
6. The rollers above the tray might be contaminated. Clean the rollers with a lint-free cloth dampened with warm water.

The product picks up multiple sheets of paper

If the product picks up multiple sheets of paper from the tray, try these solutions.

1. Remove the stack of paper from the tray and flex it, rotate it 180 degrees, and flip it over. *Do not fan the paper.* Return the stack of paper to the tray.
2. Use only paper that meets HP specifications for this product.
3. Use paper that is not wrinkled, folded, or damaged. If necessary, use paper from a different package.
4. Make sure the tray is not overfilled. If it is, remove the entire stack of paper from the tray, straighten the stack, and then return some of the paper to the tray.
5. Make sure the paper guides in the tray are adjusted correctly for the size of paper. Adjust the guides to the appropriate indentation in the tray.
6. Make sure the printing environment is within recommended specifications.

Clear jams

- [Jam locations](#)
- [Experiencing frequent or recurring paper jams?](#)
- [Clear jams in the toner-cartridge area](#)
- [Clear jams in the output bin](#)
- [Clear jams in the duplexer \(dw models only\)](#)

Jam locations

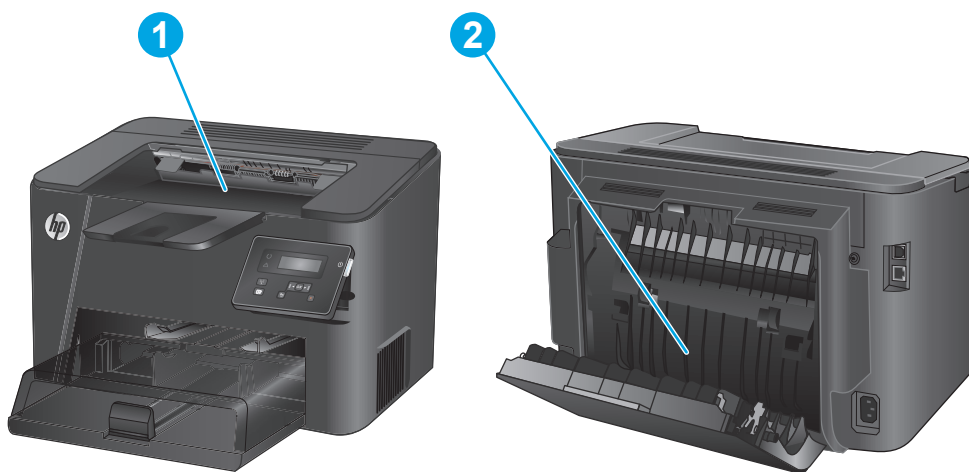

1 Toner-cartridge area and output bin

See [Clear jams in the toner-cartridge area on page 58](#) and [Clear jams in the output bin on page 60](#).

2 Duplex area (dw models only)

See [Clear jams in the duplexer \(dw models only\) on page 62](#).

Experiencing frequent or recurring paper jams?

To reduce the number of paper jams, try these solutions.

1. Use only paper that meets HP specifications for this product.
2. Use paper that is not wrinkled, folded, or damaged. If necessary, use paper from a different package.
3. Use paper that has not previously been printed or copied on.
4. Make sure the tray is not overfilled. If it is, remove the entire stack of paper from the tray, straighten the stack, and then return some of the paper to the tray.
5. Make sure the paper guides in the tray are adjusted correctly for the size of paper. Adjust the guides so they are touching the paper stack without bending it.
6. Make sure that the tray is fully inserted in the product.
7. If you are printing on heavy, embossed, or perforated paper, use the manual feed feature and feed sheets one at a time.
8. Verify that the tray is configured correctly for the paper type and size.
 - a. On the product control panel, press the **OK** button.
 - b. Open the following menus:
 - **System Setup**
 - **Paper Setup**
 - c. Verify the tray is configured for the paper type and size.
9. Make sure the printing environment is within recommended specifications.

Clear jams in the toner-cartridge area

A **Jam in cartridge area** message displays on the product control panel.

1. Open the top cover.



2. Remove the toner cartridge.

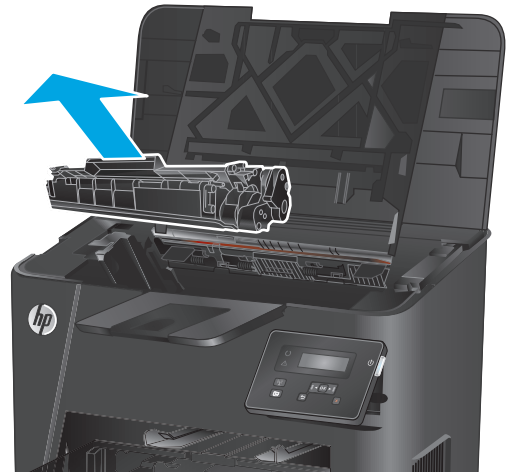

3. Remove any jammed paper from the toner-cartridge area. Use both hands to remove jammed paper to avoid tearing the paper.



4. Reinsert the toner cartridge.

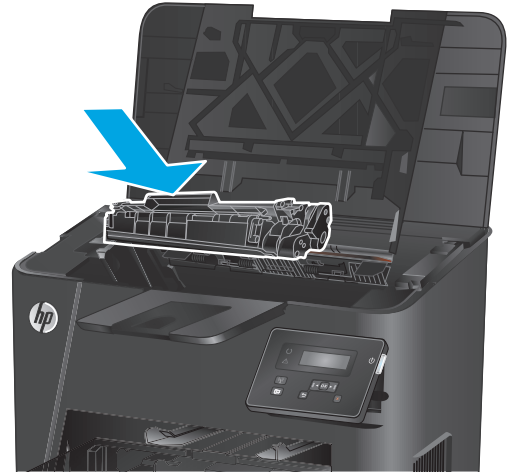

5. Close the top cover.



6. If the error message still displays on the control panel, press **OK** to clear it.

Clear jams in the output bin

A **Jam in output bin** message displays on the product control panel.

1. Open the top cover.



2. Pull out the green tab to release the jam-access cover.

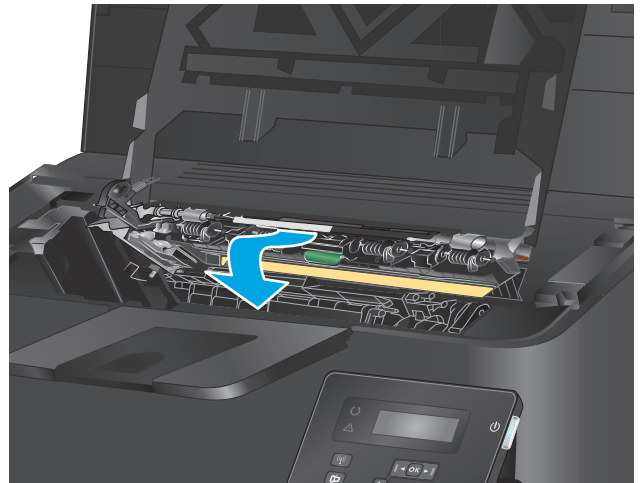

3. Remove any jammed paper.



4. Close the jam-access cover.

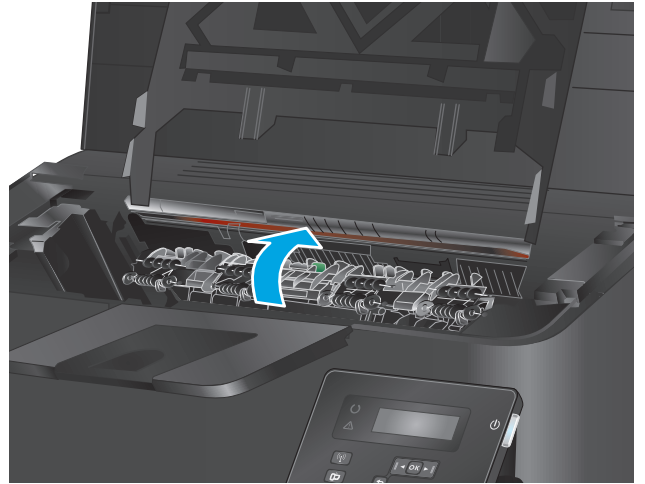

5. Close the top cover.



6. If the error message still displays on the control panel, press **OK** to clear it.

Clear jams in the duplexer (dw models only)

A **Jam in duplex area** message displays on the product control panel.

1. Open the rear door.

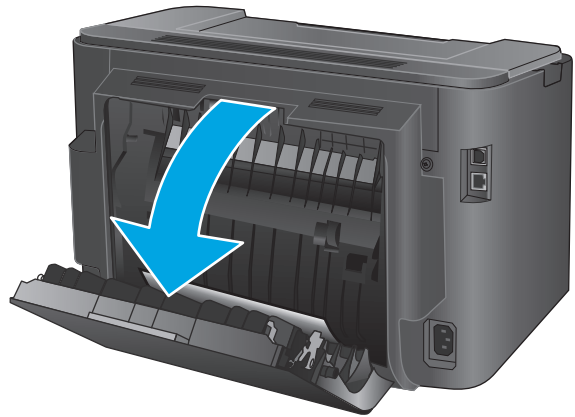

2. Remove any jammed paper from the duplex area. Use both hands to remove jammed paper to avoid tearing the paper.

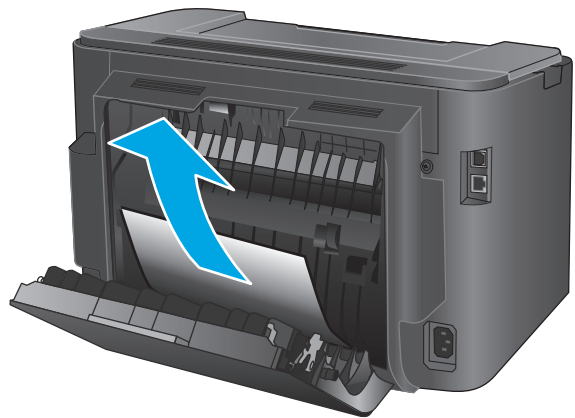

3. Close the rear door.

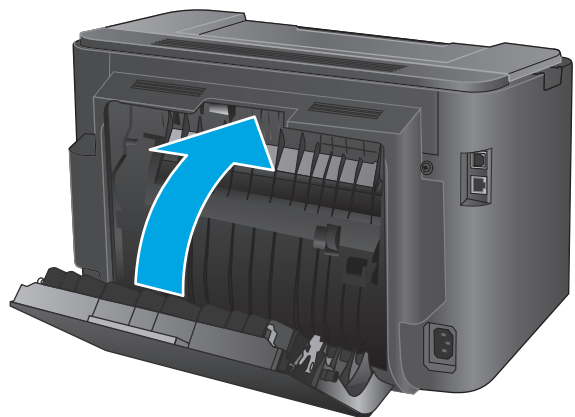

4. If the error message still displays on the control panel, press **OK** to clear it.

Improve print quality

If the product is having print-quality problems, try the following solutions in the order presented to resolve the issue.

- [Print from a different software program](#)
- [Check the paper-type setting for the print job](#)
- [Check the toner-cartridge status](#)
- [Print a cleaning page](#)
- [Visually inspect the toner cartridge for damage](#)
- [Check paper and the printing environment](#)
- [Check other print job settings](#)
- [Try a different print driver](#)

Print from a different software program

Try printing from a different software program. If the page prints correctly, the problem is with the software program from which the page was printed.

Check the paper-type setting for the print job

Check the paper type setting when printing from a software program and the printed pages have smears, fuzzy or dark print, curled paper, scattered dots of toner, loose toner, or small areas of missing toner.

Check the paper type setting (Windows)

1. From the software program, select the **Print** option.
2. Select the product, and then click the **Properties** or **Preferences** button.
3. Click the **Paper/Quality** tab.
4. From the **Paper Type** drop-down list, click the **More...** option.
5. Expand the list of **Type is:** options.
6. Expand the category of paper types that best describes your paper.
7. Select the option for the type of paper being used, and click the **OK** button.
8. Click the **OK** button to close the **Document Properties** dialog box. In the **Print** dialog box, click the **OK** button to print the job.

Check the paper type setting (OS X)

1. Click the **File** menu, and then click the **Print** option.
2. Select the product.
3. Click **Show Details**, and then click the **Media & Quality** menu or the **Paper/Quality** menu.

4. Select a type from the **Media-type** drop-down list.
5. Click the **Print** button.

Check the toner-cartridge status

Check the supplies status page for the following information:

- Estimated percentage of cartridge life remaining
- Approximate pages remaining
- Part numbers for HP toner cartridges
- Number of pages printed

Use the following procedure to print the supplies status page:

1. On the product control panel, press the **OK** button.
2. Scroll to the **Reports** menu, and press the **OK** button.
3. Scroll to the **Supplies Status** option, and then press the **OK** button to print a report of the status of all supply items.
4. Check the percent of life remaining for the toner cartridge and if applicable, the status of other replaceable maintenance parts.

Print quality problems can occur when using a toner cartridge that is at its estimated end of life. The supplies status page indicates when a supply level is very low. After an HP supply has reached the very low threshold, HP's premium protection warranty on that supply has ended.

The toner cartridge does not need to be replaced now unless the print quality is no longer acceptable. Consider having a replacement available to install when print quality is no longer acceptable.

If a toner cartridge or other replaceable maintenance part needs to be replaced, the supplies status page lists the genuine HP part numbers.

5. Check to see if a genuine HP cartridge is installed.

A genuine HP toner cartridge has the words "HP" or "Hewlett-Packard" on it, or has the HP logo on it. For more information on identifying HP cartridges go to www.hp.com/go/learnaboutsupplies.

Hewlett-Packard cannot recommend the use of non-HP supplies, either new or remanufactured. Because they are not HP products, HP cannot influence their design or control their quality. If you are using a refilled or remanufactured toner cartridge and are not satisfied with the print quality, replace the toner cartridge with a genuine HP toner cartridge.

Print a cleaning page

During the printing process paper, toner, and dust particles can accumulate inside the product and can cause print-quality issues such as toner specks or spatter, smears, streaks, lines, or repeating marks.

Follow these steps to clean the product's paper path.

1. On the product control panel, press the **OK** button.
2. Scroll to the **Service** menu, and press the **OK** button.
3. Scroll to the **Cleaning Page** option, and press the **OK** button.

A **Cleaning** message displays on the product control panel. The cleaning process takes a few minutes to complete. Do not turn the product off until the cleaning process has finished. When it is finished, discard the printed page.

Visually inspect the toner cartridge for damage

1. Remove the toner cartridge from the product, and verify that the sealing tape has been removed.
2. Check the memory chip for damage.
3. Examine the surface of the imaging drum on the toner cartridge.

 **CAUTION:** Do not touch the roller (imaging drum) on the cartridge. Fingerprints on the imaging drum can cause print-quality problems.

4. If there are any scratches, fingerprints, or other damage on the imaging drum, replace the toner cartridge.
5. If the imaging drum does not appear to be damaged, rock the toner cartridge gently several times and reinstall it. Print a few pages to see if the problem has resolved.

Check paper and the printing environment

Step one: Use paper that meets HP specifications

Some print-quality problems arise from using paper that does not meet HP specifications.

- Always use a paper type and weight that this product supports.
- Use paper that is of good quality and free of cuts, nicks, tears, spots, loose particles, dust, wrinkles, voids, staples, and curled or bent edges.
- Use paper that has not been previously printed on.
- Use paper that does not contain metallic material, such as glitter.
- Use paper that is designed for use in laser printers. Do not use paper that is designed only for use in Inkjet printers.
- Use paper that is not too rough. Using smoother paper generally results in better print quality.

Step two: Check the environment

The environment can directly affect print quality and is a common cause for print-quality or paper-feeding issues. Try the following solutions:

- Move the product away from drafty locations, such as open windows or doors, or air-conditioning vents.
- Make sure the product is not exposed to temperatures or humidity outside of product specifications.
- Do not place the product in a confined space, such as a cabinet.
- Place the product on a sturdy, level surface.

- Remove anything that is blocking the vents on the product. The product requires good air flow on all sides, including the top.
- Protect the product from airborne debris, dust, steam, grease, or other elements that can leave residue inside the product.

Check other print job settings

When printing from a software program, follow these steps to try to resolve the issue by adjusting other print-driver settings.

Check the EconoMode settings

HP does not recommend the full-time use of EconoMode. If EconoMode is used full-time, the toner supply might outlast the mechanical parts in the toner cartridge. If print quality begins to degrade and is no longer acceptable, consider replacing the toner cartridge.



NOTE: This feature is available with the PCL 6 print driver for Windows. If you are not using that driver, enable the feature by using the HP Embedded Web Server.

Follow these steps if the entire page is too dark or too light.

1. From the software program, select the **Print** option.
2. Select the product, and then click the **Properties** or **Preferences** button.
3. Click the **Paper/Quality** tab, and locate the **Print Quality** area.
4. If the entire page is too dark, use these settings:
 - Select the **600 dpi** option.
 - Select the **EconoMode** check box to enable it.

If the entire page is too light, use these settings:

- Select the **FastRes 1200** option.
 - Clear the **EconoMode** check box to disable it.
5. Click the **OK** button to close the **Document Properties** dialog box. In the **Print** dialog, click the **OK** button to print the job.

Try a different print driver

Try a different print driver when printing from a software program and the printed pages have unexpected lines in graphics, missing text, missing graphics, incorrect formatting, or substituted fonts.

Download any of the following drivers from the HP Web site: www.hp.com/support/ljM201, www.hp.com/support/ljM202.

HP PCL 6 driver	<ul style="list-style-type: none">• Provided as the default driver on the product CD. This driver is automatically installed unless a different one is selected.• Recommended for all Windows environments• Provides the overall best speed, print quality, and product-feature support for most users• Developed to align with the Windows Graphic Device Interface (GDI) for the best speed in Windows environments• Might not be fully compatible with third-party and custom software programs that are based on PCL 5
HP UPD PS driver	<ul style="list-style-type: none">• Recommended for printing with Adobe® software programs or with other highly graphics-intensive software programs• Provides support for printing from postscript emulation needs, or for postscript flash font support
HP UPD PCL 5	<ul style="list-style-type: none">• Recommended for general office printing in Windows environments• Compatible with previous PCL versions and older HP LaserJet products• The best choice for printing from third-party or custom software programs• The best choice when operating with mixed environments, which require the product to be set to PCL 5 (UNIX, Linux, mainframe)• Designed for use in corporate Windows environments to provide a single driver for use with multiple product models• Preferred when printing to multiple product models from a mobile Windows computer
HP UPD PCL 6	<ul style="list-style-type: none">• Recommended for printing in all Windows environments• Provides the overall best speed, print quality, and printer feature support for most users• Developed to align with Windows Graphic Device Interface (GDI) for best speed in Windows environments• Might not be fully compatible with third-party and custom software programs that are based on PCL 5

Solve wired network problems

Check the following items to verify that the product is communicating with the network. Before beginning, print a configuration page from the product control panel and locate the product IP address that is listed on this page.

- [Poor physical connection](#)
- [The computer is using the incorrect IP address for the product](#)
- [The computer is unable to communicate with the product](#)
- [The product is using incorrect link and duplex settings for the network](#)
- [New software programs might be causing compatibility problems](#)
- [The computer or workstation might be set up incorrectly](#)
- [The product is disabled, or other network settings are incorrect](#)



NOTE: HP does not support peer-to-peer networking, as the feature is a function of Microsoft operating systems and not of the HP print drivers. For more information, go to Microsoft at www.microsoft.com.

Poor physical connection

1. Verify that the product is attached to the correct network port using a cable of the correct length.
2. Verify that cable connections are secure.
3. Look at the network port connection on the back of the product, and verify that the amber activity light and the green link-status light are lit.
4. If the problem continues, try a different cable or port on the hub.

The computer is using the incorrect IP address for the product

1. Open the printer properties and click the **Ports** tab. Verify that the current IP address for the product is selected. The product IP address is listed on the product configuration page.
2. If you installed the product using the HP standard TCP/IP port, select the box labeled **Always print to this printer, even if its IP address changes**.
3. If you installed the product using a Microsoft standard TCP/IP port, use the hostname instead of the IP address.
4. If the IP address is correct, delete the product and then add it again.

The computer is unable to communicate with the product

1. Test network communication by pinging the network.
 - a. Open a command-line prompt on your computer.

- For Windows, click **Start**, click **Run**, type `cmd`, and then press **Enter**.
 - For OS X, go to **Applications**, then **Utilities**, and open **Terminal**.
- b. Type `ping` followed by the IP address for your product.
 - c. If the window displays round-trip times, the network is working.
2. If the ping command failed, verify that the network hubs are on, and then verify that the network settings, the product, and the computer are all configured for the same network.

The product is using incorrect link and duplex settings for the network

Hewlett-Packard recommends leaving these settings in automatic mode (the default setting). If you change these settings, you must also change them for your network.

New software programs might be causing compatibility problems

Verify that any new software programs are correctly installed and that they use the correct print driver.

The computer or workstation might be set up incorrectly

1. Check the network drivers, print drivers, and the network redirection settings.
2. Verify that the operating system is configured correctly.

The product is disabled, or other network settings are incorrect

1. Review the configuration page to check the status of the network protocol. Enable it if necessary.
2. Reconfigure the network settings if necessary.

Solve wireless network problems

- [Wireless connectivity checklist](#)
- [The product does not print after the wireless configuration completes](#)
- [The product does not print, and the computer has a third-party firewall installed](#)
- [The wireless connection does not work after moving the wireless router or product](#)
- [Cannot connect more computers to the wireless product](#)
- [The wireless product loses communication when connected to a VPN](#)
- [The network does not appear in the wireless networks list](#)
- [The wireless network is not functioning](#)
- [Perform a wireless network diagnostic test](#)
- [Reduce interference on a wireless network](#)

Wireless connectivity checklist

- Verify that the network cable is not connected.
- Verify that the product and the wireless router are turned on and have power. Also make sure that the wireless radio in the product is turned on.
- Verify that the service set identifier (SSID) is correct. Print a configuration page to determine the SSID. If you are not sure the SSID is correct, run the wireless setup again.
- With secured networks, verify that the security information is correct. If the security information is incorrect, run the wireless setup again.
- If the wireless network is working correctly, try accessing other computers on the wireless network. If the network has Internet access, try connecting to the Internet over a wireless connection.
- Verify that the encryption method (AES or TKIP) is the same for the product as it is for the wireless access point (on networks using WPA security).
- Verify that the product is within the range of the wireless network. For most networks, the product must be within 30 m (100 ft) of the wireless access point (wireless router).
- Verify that obstacles do not block the wireless signal. Remove any large metal objects between the access point and the product. Make sure poles, walls, or support columns containing metal or concrete do not separate the product and wireless access point.
- Verify that the product is located away from electronic devices that might interfere with the wireless signal. Many devices can interfere with the wireless signal including motors, cordless phones, security system cameras, other wireless networks, and some Bluetooth devices.
- Verify that the print driver is installed on the computer.
- Verify that you have selected the correct printer port.
- Verify that the computer and product connect to the same wireless network.
- For OS X, verify that the wireless router supports Bonjour.

The product does not print after the wireless configuration completes

1. Make sure that the product is turned on and in the ready state.
2. Turn off any third-party firewalls on your computer.
3. Make sure that the wireless network is working correctly.
4. Make sure that your computer is working correctly. If necessary, restart the computer.
5. Verify that you can open the product HP Embedded Web Server from a computer on the network.

The product does not print, and the computer has a third-party firewall installed

1. Update the firewall with the most recent update available from the manufacturer.
2. If programs request firewall access when you install the product or try to print, make sure you allow the programs to run.
3. Temporarily turn off the firewall, and then install the wireless product on the computer. Enable the firewall when you have completed the wireless installation.

The wireless connection does not work after moving the wireless router or product

1. Make sure that the router or product connects to the same network that your computer connects to.
2. Print a configuration page.
3. Compare the service set identifier (SSID) on the configuration page to the SSID in the printer configuration for the computer.
4. If the numbers are not the same, the devices are not connecting to the same network. Reconfigure the wireless setup for the product.

Cannot connect more computers to the wireless product

1. Make sure that the other computers are within the wireless range and that no obstacles block the signal. For most networks, the wireless range is within 30 m (100 ft) of the wireless access point.
2. Make sure that the product is turned on and in the ready state.
3. Turn off any third-party firewalls on your computer.
4. Make sure that the wireless network is working correctly.
5. Make sure that your computer is working correctly. If necessary, restart the computer.

The wireless product loses communication when connected to a VPN

- Typically, you cannot connect to a VPN and other networks at the same time.

The network does not appear in the wireless networks list

- Make sure the wireless router is turned on and has power.
- The network might be hidden. However, you can still connect to a hidden network.

The wireless network is not functioning

1. Make sure that the network cable is not connected.
2. To verify if the network has lost communication, try connecting other devices to the network.
3. Test network communication by pinging the network.
 - a. Open a command-line prompt on your computer.
 - For Windows, click **Start**, click **Run**, type `cmd`, and then press **Enter**.
 - For OS X, go to **Applications**, then **Utilities**, and open **Terminal**.
 - b. Type `ping` followed by the router IP address.
 - c. If the window displays round-trip times, the network is working.
4. Make sure that the router or product connects to the same network that the computer connects to.
 - a. Print a configuration page.
 - b. Compare the service set identifier (SSID) on the configuration report to the SSID in the printer configuration for the computer.
 - c. If the numbers are not the same, the devices are not connecting to the same network. Reconfigure the wireless setup for the product.

Perform a wireless network diagnostic test

From the product control panel, you can run a diagnostic test that provides information about the wireless network settings.

1. On the product control panel, press the **OK** button.
2. Open the **Self Diagnostics** menu.
3. Select **Run Wireless Test** to start the test. The product prints a test page that shows test results.

Reduce interference on a wireless network

The following tips can reduce interference in a wireless network:

- Keep the wireless devices away from large metal objects, such as filing cabinets, and other electromagnetic devices, such as microwaves and cordless telephones. These objects can disrupt radio signals.
- Keep the wireless devices away from large masonry structures and other building structures. These objects can absorb radio waves and lower signal strength.
- Position the wireless router in a central location in line of sight with the wireless products on the network.

Index

A

- accessories
 - ordering 20
 - part numbers 20
- acoustic specifications 4
- AirPrint 36

B

- bins, output
 - locating 5
- browser requirements
 - HP embedded Web Server 39

C

- cartridge
 - replacing 21
- checklist
 - wireless connectivity 70
- cleaning
 - paper path 64
- control panel
 - locating 5
- control panel buttons
 - locating 7
- covers, locating 5
- customer support
 - online 52

D

- defaults, restoring 53
- dimensions, product 2
- double-sided printing
 - Mac 32
 - Windows 29
- drivers
 - paper types 12
- duplex printing
 - Mac 32

- duplex printing (double-sided)
 - settings (Windows) 28
 - Windows 29
- duplexing
 - manually (Mac) 32
 - manually (Windows) 29

E

- EconoMode setting 47, 66
- economy settings 47
- electrical specifications 4
- Embedded Web Server
 - changing password 46
 - opening 46
- Embedded Web Server (EWS)
 - features 39
- Explorer, versions supported
 - HP Embedded Web Server 39

F

- factory-set defaults, restoring 53

H

- HP Customer Care 52
- HP Device Toolbox, using 39
- HP Embedded Web Server
 - changing password 46
 - opening 46
- HP Embedded Web Server (EWS)
 - features 39
- HP ePrint 35
- HP ePrint software 35
- HP EWS, using 39
- HP Utility 41
- HP Utility for Mac
 - Bonjour 41
 - features 41
- HP Utility, Mac 41
- HP Web Jetadmin 45

- HP Wireless Direct Printing 34

I

- interface ports
 - locating 6
- Internet Explorer, versions supported
 - HP Embedded Web Server 39

J

- jams
 - causes of 57
 - locating 56
- Jetadmin, HP Web 45

L

- labels
 - printing (Windows) 31

M

- Macintosh
 - HP Utility 41
- manual duplex
 - Mac 32
 - Windows 29
- media
 - supported sizes 10
- multiple pages per sheet
 - printing (Mac) 33
 - printing (Windows) 30

N

- Netscape Navigator, versions supported
 - HP embedded Web Server 39
- network
 - password, changing 46
 - password, setting 46
- network installation 38
- network port
 - locating 6

networks
 HP Web Jetadmin 45
 installing the product 38

O
on/off button, locating 5
online support 52
ordering
 supplies and accessories 20
output bin
 locating 5

P
pages per minute 2
pages per sheet
 selecting (Mac) 33
 selecting (Windows) 30

paper
 jams 57
 ordering 20
 selecting 65
 supported sizes 10
 supported types 12

paper pickup problems
 solving 55

paper type
 selecting (Windows) 31

paper types
 selecting (Mac) 33

part numbers
 supplies 20

power
 consumption 4

power connection
 locating 6

power switch, locating 5

power-down delay
 setting 47

print on both sides
 Mac 32
 manually, Windows 29
 Windows 29

printing on both sides
 settings (Windows) 28

product and serial number label
 locating 6

R
replacing toner cartridge 21
restoring factory-set defaults 53

S
security lock slot
 locating 6
serial number label
 locating 6
settings
 factory-set defaults, restoring 53
sleep delay
 disabling 47
 enabling 47
software
 HP Utility 41
special paper
 printing (Windows) 31
specifications
 electrical and acoustic 4
status
 HP Utility, Mac 41
supplies
 low threshold settings 54
 ordering 20
 part numbers 20
 replacing toner cartridge 21
 status, viewing with HP Utility for Mac 41
 using when low 54
supplies status
 checking 64
supplies status page
 printing 64
support
 online 52
supported media 10
supported operating systems 2
system requirements
 HP Embedded Web Server 39

T
technical support
 online 52
toner
 amount remaining 64
toner cartridge
 checking for damage 65
 low threshold settings 54
 replacing 21
 using when low 54
transparencies
 printing (Windows) 31

Tray 1
 loading 13
 orientation 13
Tray 2
 loading 15
 orientation 17
trays
 included 2
 locating 5
troubleshooting
 jams 57
 network problems 68
 wired network 68
 wireless network 70
two-sided printing
 settings (Windows) 28

U
USB port
 locating 6

W
Web browser requirements
 HP Embedded Web Server 39
Web sites
 customer support 52
 HP Web Jetadmin, downloading 45
weight, product 2
wireless network
 troubleshooting 70
wireless network interference 72



CF456-90908



Free Manuals Download Website

<http://myh66.com>

<http://usermanuals.us>

<http://www.somanuals.com>

<http://www.4manuals.cc>

<http://www.manual-lib.com>

<http://www.404manual.com>

<http://www.luxmanual.com>

<http://aubethermostatmanual.com>

Golf course search by state

<http://golfingnear.com>

Email search by domain

<http://emailbydomain.com>

Auto manuals search

<http://auto.somanuals.com>

TV manuals search

<http://tv.somanuals.com>