



COLOR LASERJET PRO MFP

User Guide



M176



M177



HP Color LaserJet Pro MFP M176, M177

User Guide

Copyright and License

© 2013 Copyright Hewlett-Packard Development Company, L.P.

Reproduction, adaptation, or translation without prior written permission is prohibited, except as allowed under the copyright laws.

The information contained herein is subject to change without notice.

The only warranties for HP products and services are set forth in the express warranty statements accompanying such products and services. Nothing herein should be construed as constituting an additional warranty. HP shall not be liable for technical or editorial errors or omissions contained herein.

Edition 1, 10/2013

Part number: CF548-90908

Trademark Credits

Adobe®, Acrobat®, and PostScript® are trademarks of Adobe Systems Incorporated.

Apple and the Apple logo are trademarks of Apple Computer, Inc., registered in the U.S. and other countries. iPod is a trademark of Apple Computer, Inc. iPod is for legal or rightholder-authorized copying only. Don't steal music.

Bluetooth is a trademark owned by its proprietor and used by Hewlett-Packard Company under license.

Microsoft®, Windows®, Windows® XP, and Windows Vista® are U.S. registered trademarks of Microsoft Corporation.

Table of contents

1 Product introduction	1
Product comparison	2
Product views	4
Product front view	4
Product back view	5
Control panel overview	6
LCD control-panel layout (M176n model)	6
Touchscreen control-panel layout (M177fw model)	7
Control-panel Home screen	8
2 Paper trays	11
Supported paper sizes and types	12
Supported paper sizes	12
Supported paper types	13
Load the input tray	15
3 Print	19
Print tasks (Windows)	20
How to print (Windows)	20
Manually print on both sides (Windows)	20
Print multiple pages per sheet (Windows)	22
Select the paper type (Windows)	25
Additional printing information	26
Print tasks (Mac OS X)	27
How to print (Mac OS X)	27
Manually print on both sides (Mac OS X)	27
Print multiple pages per sheet (Mac OS X)	28
Select the paper type (Mac OS X)	28
Additional printing information	28
Web-based printing	30
HP ePrint	30

HP ePrint software	30
AirPrint	31
Set up HP Wireless Direct Printing (touchscreen models only)	32
4 Copy	33
Make a copy	34
Copy on both sides (duplex)	35
Optimize copy quality	36
5 Scan	37
Scan by using the HP Scan software (Windows)	38
Scan by using the HP Scan software (Mac OS X)	39
6 Fax	41
Connect and configure the product for fax	42
Connect the product	42
Configure the product	43
Configure fax time, date, and header	43
Control panel	43
HP Fax Setup Wizard (Windows)	44
Configure for stand-alone fax	44
Configure for an answering machine	44
Configure for an extension phone	44
Install the HP Fax software (Windows, optional)	45
Send a fax	46
Send a fax by dialing manually from the product control panel	46
Send a fax from the HP software (Windows)	46
Create, edit, and delete speed-dial entries	47
Create and edit speed-dial entries	47
Delete speed-dial entries	47
7 Manage the product	49
Change the product connection type (Windows)	50
Use HP Web Services applications (touchscreen models only)	51
HP Device Toolbox (Windows)	52
HP Utility for Mac OS X	54
Open the HP Utility	54
HP Utility features	54
Product security features	56
Set or change the product password	56

Lock the product	57
Economy settings	58
Print with EconoMode	58
Configure the Sleep/Auto Off After setting	58
A <Color> cartridge is low or <Color> cartridge is very low message displays on the product control panel ..	60
Enable or disable the Very Low settings	60
Replace the toner cartridge	62
Replace the imaging drum	66
8 Solve problems	71
Control panel help system (touchscreen models only)	72
Restore the factory-set defaults	73
Solve paper feed or jam problems	74
The product does not pick up paper	74
The product picks up multiple sheets of paper	74
Frequent or recurring paper jams	74
Prevent paper jams	75
Clear jams from the input tray	76
Clear jams in the output bin	78
Clear jams in the document feeder	80
Improve print quality	82
Print from a different software program	82
Set the paper-type setting for the print job	82
Check the paper-type setting (Windows)	82
Check the paper-type setting (Mac OS X)	83
Check the toner-cartridge status	83
Calibrate the product to align the colors	84
Print a cleaning page	84
Perform additional print quality troubleshooting	85
Print the print quality page	85
Interpret the print quality page	85
Inspect the toner cartridge for damage	86
Check the paper and printing environment	86
Use paper that meets HP specifications	86
Check the product environment	87
Check the EconoMode settings	87
Adjust color settings (Windows)	87
Improve copy and scan quality	89
Check the scanner glass for dirt and smudges	89
Check the paper settings	89
Check the image adjustment settings	90

Optimize for text or pictures	90
Edge-to-edge copying	91
Clean the pickup rollers and separation pad in the document feeder	91
Improve fax image quality	93
Check the scanner glass for dirt or smudges	93
Check the send-fax resolution setting	93
Check the lightness/darkness setting	93
Check the Error Correction setting	94
Check the Fit-to-Page setting	94
Clean the pickup rollers and separation pad in the document feeder	94
Send to a different fax machine	95
Check the sender's fax machine	95
Solve wired network problems	96
Poor physical connection	96
The computer is using the incorrect IP address for the product	96
The computer is unable to communicate with the product	96
The product is using incorrect link and duplex settings for the network	97
New software programs might be causing compatibility problems	97
The computer or workstation might be set up incorrectly	97
The product is disabled, or other network settings are incorrect	97
Solve wireless network problems	98
Wireless connectivity checklist	98
The product does not print after the wireless configuration completes	99
The product does not print, and the computer has a third-party firewall installed	99
The wireless connection does not work after moving the wireless router or product	99
Cannot connect more computers to the wireless product	99
The wireless product loses communication when connected to a VPN	99
The network does not appear in the wireless networks list	99
The wireless network is not functioning	100
Perform a wireless network diagnostic test	100
Reduce interference on a wireless network	100
Solve fax problems	102
Check the hardware setup	102
Faxes are sending slowly	103
Fax quality is poor	104
Fax cuts off or prints on two pages	104
9 Parts, supplies, and accessories	105
Order parts, accessories, and supplies	106
Customer self-repair parts	106
Accessories	106

1 Product introduction

- [Product comparison](#)
- [Product views](#)
- [Control panel overview](#)

Go to www.hp.com/support/ljMFPM176series or www.hp.com/support/ljMFPM177series for HP's all-inclusive help for your product:

- Solve problems.
- Download software updates.
- Join support forums.
- Find warranty and regulatory information.

You can also go to www.hp.com/support for Worldwide support and other HP products.

Product comparison

		M176n	M177fw
		CF547A	CZ165A
Paper handling	Tray 1 (150-sheet capacity)	✓	✓
	Standard output bin (50-sheet capacity)	✓	✓
	Manual duplex printing	✓	✓
Supported operating systems	Windows 8, 32-bit	✓	✓
	Windows XP, 32-bit	✓	✓
	Windows Vista, 32-bit and 64-bit	✓	✓
	Windows 7, 32-bit and 64-bit	✓	✓
	Windows 2003 Server, 32-bit and 64-bit	✓	✓
	Windows 2008 Server, 32-bit and 64-bit	✓	✓
	Mac OS X v10.6.8 and later	✓	✓
	Linux	✓	✓
Supported print drivers	The HP PCLmS print driver is included on the in-box CD as the default print driver.	✓	✓
Connectivity	Hi-Speed USB 2.0	✓	✓
	10/100/1000 Ethernet LAN connection	✓	✓
	Wireless network connection		✓
Memory	128 MB RAM	✓	✓
Control-panel display	2-line LCD	✓	
	Color graphical touchscreen		✓
Print	Prints up to 16 A4-size pages per minute (ppm) or 17 Letter-size ppm monochrome and 4 ppm color	✓	✓
Copy	Copy resolution is 300 dpi scan, 600 dpi print	✓	✓
	Flatbed scanner supports page sizes up to 215.9 mm (8.5 in) wide and 297 mm (11.7 in) long	✓	✓
	Document feeder speed is 7.4 ppm		✓
Scan	Scan resolution is 300 dpi, 600 dpi, or 1200 dpi	✓	✓
	Flatbed scanner supports page sizes up to 215.9 mm (8.5 in) wide and 297 mm (11.7 in) long	✓	✓

	M176n	M177fw
	CF547A	CZ165A
	Document feeder speed is 7.4 ppm	✓
Fax	V.34 with two RJ-11 fax ports	✓
	Approximately 500 pages of fax storage, with four days of power-fail recovery	✓

Product views

Product front view

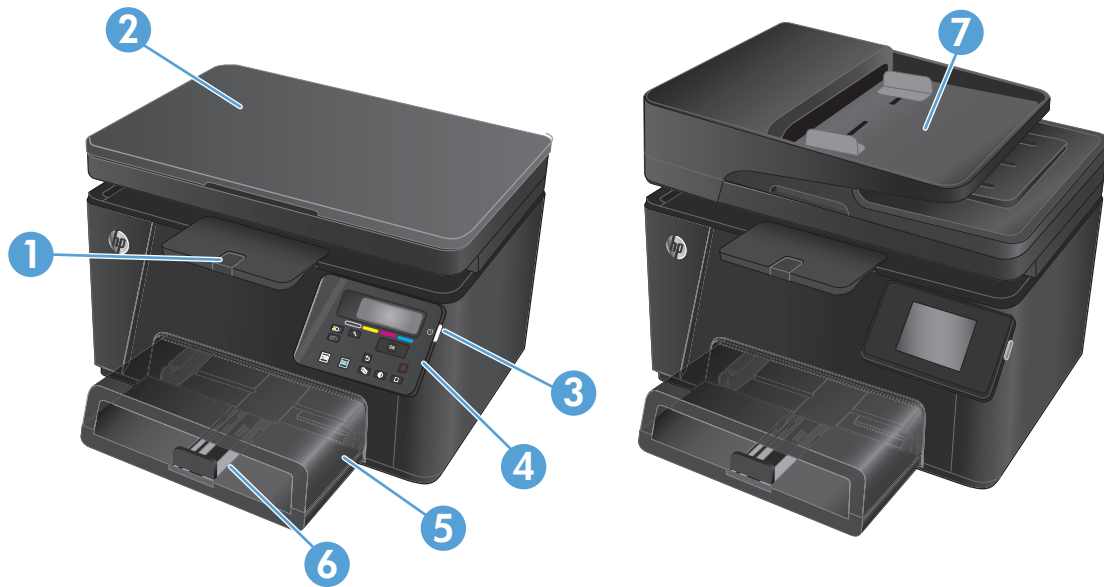

1	Output bin
2	Scanner
3	Power on/off button
4	Control panel
5	Dust cover
6	Input tray
7	Document feeder

Product back view

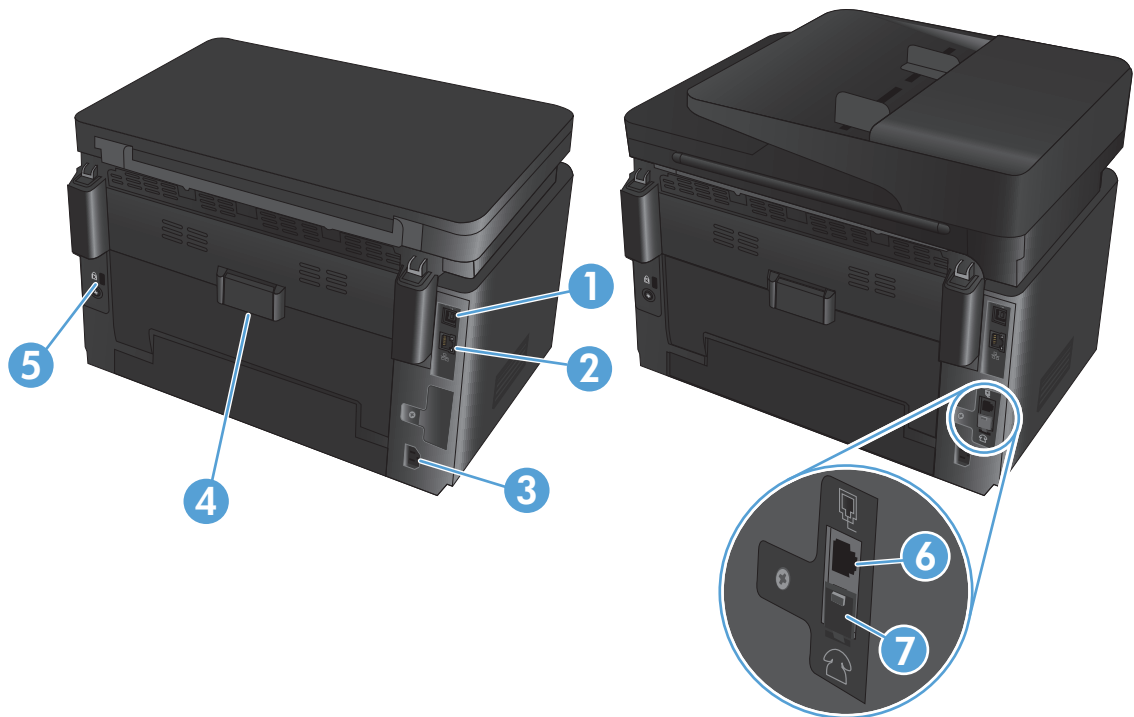

1	Hi-Speed USB 2.0
2	Ethernet port
3	Power connection
4	Rear door (provides access for clearing jams)
5	Slot for cable-type security lock
6	Fax "line in" port for attaching the fax phone line to the product
7	Telephone "line out" port for attaching an extension phone, answering machine, or other devices

Control panel overview

LCD control-panel layout (M176n model)

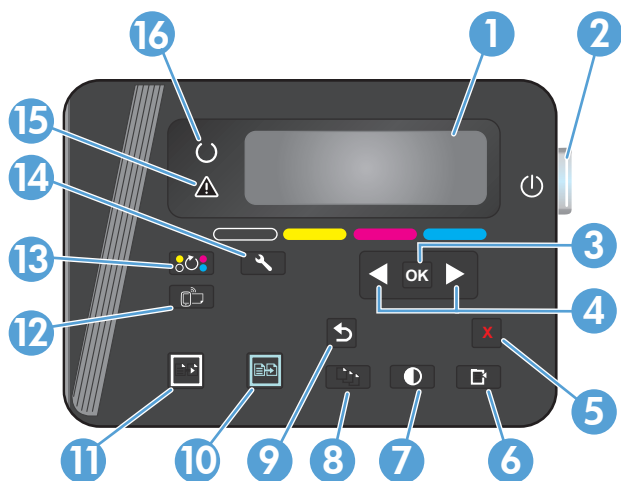

1	Control panel display	Provides information about the product; use the menus on the display to establish product settings
2	Power On/Off button	Turns the product on or off
3	OK button	Acknowledges a setting or confirms an action to proceed
4	Arrow buttons	Navigates the menus and adjusts certain settings
5	Cancel X button	Cancels a print job whenever the attention light is blinking or exits the control panel menus
6	Copy Menu  button	Opens the copy settings menu
7	Lighter/Darker  button	Controls the brightness or darkness of a copy
8	Number of Copies  button	Sets the number of copies for the current copy job
9	Back  button	Returns to the previous screen
10	Color copy  button	Starts a color copy job
11	Black and white copy  button	Starts a black and white copy job
12	ePrint  button	Opens the Web Services menu
13	Rotate toner cartridges  button	Rotates the toner cartridge carousel
14	Setup  button	Opens the Setup menu
15	Attention light	Indicates a problem with the product, view the display for a message
16	Ready light	Indicates that the product is ready or is processing a job

Touchscreen control-panel layout (M177fw model)

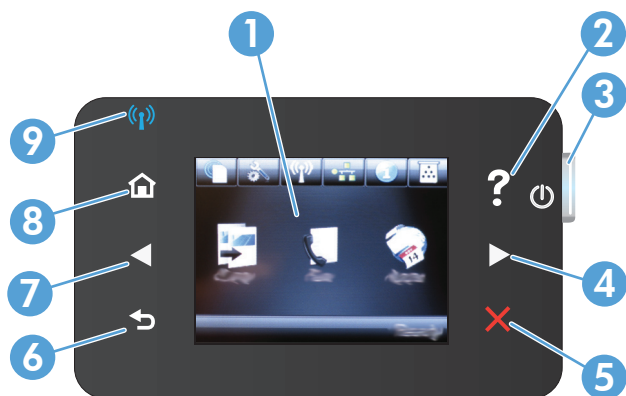

1	Touchscreen display	Provides access to the product features and indicates the current status of the product
2	Help button and light	Provides access to the control-panel help system
3	Power On/Off button	Turns the product on or off
4	Right arrow button and light	Moves the cursor to the right or moves the display to the next screen NOTE: This button illuminates only when the current screen can use this feature.
5	Cancel button and light	Clears settings, cancels the current job, or exits the current screen NOTE: This button illuminates only when the current screen can use this feature
6	Back button and light	Returns to the previous screen NOTE: This button illuminates only when the current screen can use this feature.
7	Left arrow button and light	Moves the cursor to the left or moves the display to the previous screen NOTE: This button illuminates only when the current screen can use this feature.
8	Home button and light	Provides access to the Home screen
9	Wireless light	Indicates the wireless network is enabled; the light blinks while the product is establishing a connection to the wireless network

Control-panel Home screen

The Home screen provides access to the product features, and it indicates the product status.

 **NOTE:** Depending on the product configuration, the features on the Home screen can vary. The layout might also be reversed for some languages.

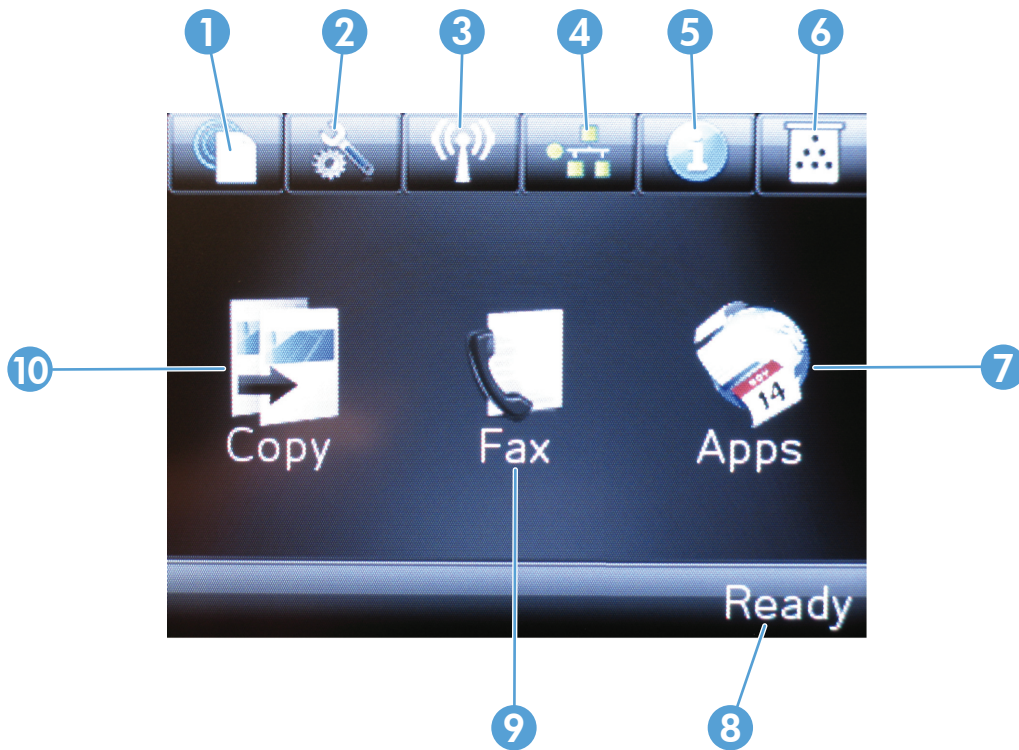

1	Web Services button	Provides quick access to HP Web Services features, including HP ePrint HP ePrint is a tool that prints documents by using any email enabled device to send them to the product's email address.
2	Setup button	Provides access to the main menus
3	Wireless button	Provides access to the Wireless menu and wireless status information NOTE: When you are connected to a wireless network, this icon changes to a set of signal strength bars. NOTE: This button does not display when the product is connected to a wired network.
4	Network button	Provides access to network settings and information. From the network settings screen, you can print the Network Summary page. NOTE: This button displays only when the product is connected to a network.
5	Information button	Provides product status information. From the status summary screen, you can print the Configuration Report page.
6	Supplies button	Provides information about supplies status. From the supplies summary screen, you can print the Supplies Status page.

7	Apps button	Provides access to the Apps menu to print directly from Web applications that you have downloaded from the HP Connected Web site at www.hpconnected.com
8	Product status	Indicates whether the product is ready or is processing a job
9	Fax button	Provides access to the fax features
10	Copy button	Provides access to the copy features

2 Paper trays

- [Supported paper sizes and types](#)
- [Load the input tray](#)

Go to www.hp.com/support/ljMFPM176series or www.hp.com/support/ljMFPM177series for HP's all-inclusive help for your product:

- Solve problems.
- Download software updates.
- Join support forums.
- Find warranty and regulatory information.

You can also go to www.hp.com/support for Worldwide support and other HP products.

Supported paper sizes and types

- [Supported paper sizes](#)
- [Supported paper types](#)

Supported paper sizes



NOTE: To obtain the best results, select the correct paper size and type in the print driver before printing.

Size	Dimensions
Letter	216 x 279 mm (8.5 x 11 in)
Legal	216 x 356 mm (8.5 x 14 in)
Executive	184 x 267 mm (7.3 x 10.5 in)
Oficio 8.5 x 13	216 x 330 mm (8.5 x 13 in)
4x6	102 x 152 mm (4 x 6 in)
5x8	127.0 x 203.2 mm (5.0 x 8.0 in)
A4	210 x 297 mm (8.3 x 11.7 in)
A5	148 x 210 mm (5.8 x 8.3 in)
A6	105 x 148 mm (4.1 x 5.8 in)
B5 (JIS)	182 x 257 mm (7.2 x 10.1 in)
10x15cm	100 x 150 mm (3.9 x 5.9 in)
16K	184 x 260 mm (7.2 x 10.3 in)
16K	195 x 270 mm (7.7 x 10.6 in)
16K	197 x 273 mm (7.8 x 10.8 in)
Japanese Postcard	100 x 148 mm (3.9 x 5.8 in)
Postcard (JIS)	
Double Japanese Postcard Rotated	200 x 148 mm (7.9 x 5.8 in)
D Postcard (JIS)	
Envelope #10	105 x 241 mm (4.1 x 9.5 in)
Envelope Monarch	98 x 191 mm (3.9 x 7.5 in)
Envelope B5	176 x 250 mm (6.9 x 9.8 in)
Envelope C5	162 x 229 mm (6.4 x 9 in)
Envelope DL	110 x 220 mm (4.3 x 8.7 in)
Custom	76 x 127 mm to 216 x 356 mm (3.0 x 5.0 in to 8.5 x 14 in)

Supported paper types

The product supports the following paper types:



NOTE: To obtain the best results, select the correct paper size and type in the print driver before printing.

- Plain
- Labels
- Letterhead
- Envelope
- Preprinted
- Prepunched
- Colored
- Bond
- Recycled
- Rough
- HP EcoSMART Lite
- HP LaserJet 90g
- HP Color Laser Matte 105g
- HP Premium Choice Matte 120g
- HP Brochure Matte 150g
- HP Cover Matte 200g
- HP Matte Photo 200g
- HP Premium Presentation Glossy 120g
- HP Brochure Glossy 150g
- HP Tri-fold Brochure Glossy 150g
- HP Brochure Glossy 200g
- HP Brochure Glossy 200g (faster printing)
- HP Brochure Glossy 200g (higher gloss)
- Light 60–74g
- Intermediate 85-95g
- Midweight 96–110g
- Heavy 111–130g
- Extra Heavy 131–175g

- Mid-Weight Glossy 96-110g
- Heavy Glossy 111-130g
- Extra Heavy Glossy 131-175g
- Card Glossy 176-220g
- Color Laser Transparency
- Heavy Envelope
- Heavy Rough
- HP Tough Paper

Load the input tray

 **NOTE:** The input tray has a maximum capacity of 150 sheets.

1. Remove the dust cover from the tray.



2. Load the paper into the tray. Make sure that the paper fits under the tabs and below the maximum-height indicators.

NOTE: For information about the paper orientation for different types of paper, see [Table 2-1 Input tray paper orientation on page 16](#).



- 3. Adjust the paper guides so that they lightly touch the paper stack but do not bend the paper.



- 4. Reinstall the dust cover on the tray.



Table 2-1 Input tray paper orientation

Paper type	Duplex mode	Paper size	Image orientation	How to load paper
Preprinted or letterhead	1-sided printing	Any compatible paper size	Portrait	Face-up Top edge leading into the product

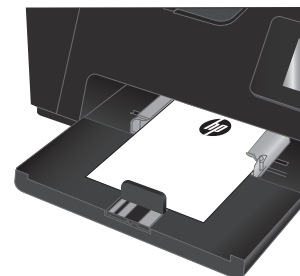
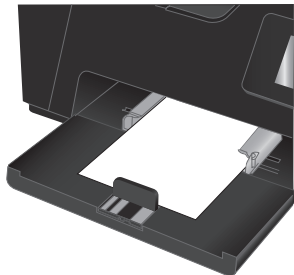
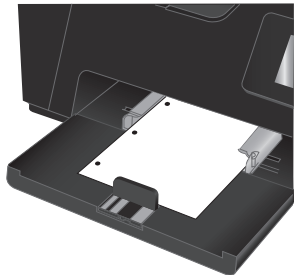
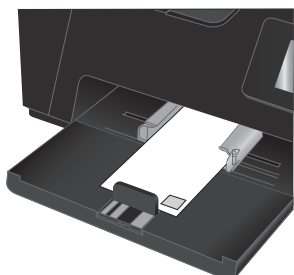

Table 2-1 Input tray paper orientation (continued)

Paper type	Duplex mode	Paper size	Image orientation	How to load paper
	2-sided printing	Any compatible paper size	Portrait	Face-down Top edge leading into the product 
Prepunched	1- or 2-sided printing	Any compatible paper size	Portrait	Face-up Holes toward the left of the product 
Envelopes	1-sided printing	Any compatible envelope size	Short edge of the envelope feeding into the product	Face-up Top edge toward the right of the tray, postage end entering the product last 

3 Print

- [Print tasks \(Windows\)](#)
- [Print tasks \(Mac OS X\)](#)
- [Web-based printing](#)
- [Set up HP Wireless Direct Printing \(touchscreen models only\)](#)

Go to www.hp.com/support/ljMFPM176series or www.hp.com/support/ljMFPM177series for HP's all-inclusive help for your product:

- Solve problems.
- Download software updates.
- Join support forums.
- Find warranty and regulatory information.

You can also go to www.hp.com/support for Worldwide support and other HP products.

Print tasks (Windows)

- [How to print \(Windows\)](#)
- [Manually print on both sides \(Windows\)](#)
- [Print multiple pages per sheet \(Windows\)](#)
- [Select the paper type \(Windows\)](#)
- [Additional printing information](#)

How to print (Windows)

The following procedure describes the basic printing process for Windows.

1. From the software program, select the **Print** option.
2. Select the product from the list of printers, and then click or tap the **Properties** or **Preferences** button to open the print driver.

 **NOTE:** The name of the button varies for different software programs.

3. Click or tap the tabs in the print driver to configure the available options.
4. Click or tap the **OK** button to return to the **Print** dialog box. Select the number of copies to print from this screen.
5. Click or tap the **OK** button to print the job.

Manually print on both sides (Windows)

1. From the software program, select the **Print** option.
2. Select the product from the list of printers, and then click or tap the **Properties** or **Preferences** button to open the print driver.

NOTE: The name of the button varies for different software programs.

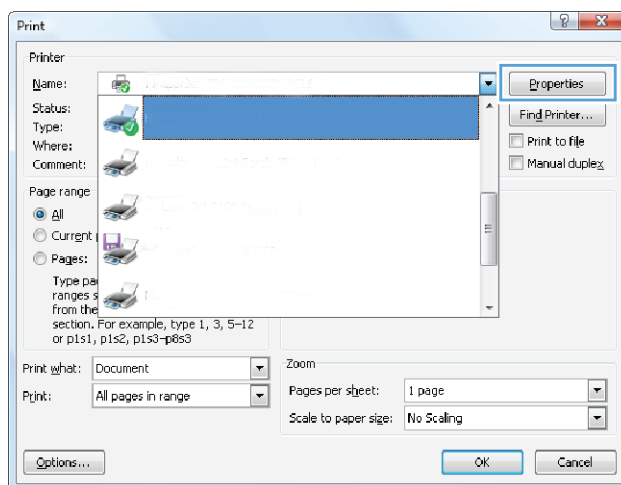

3. Click or tap the **Layout** tab.

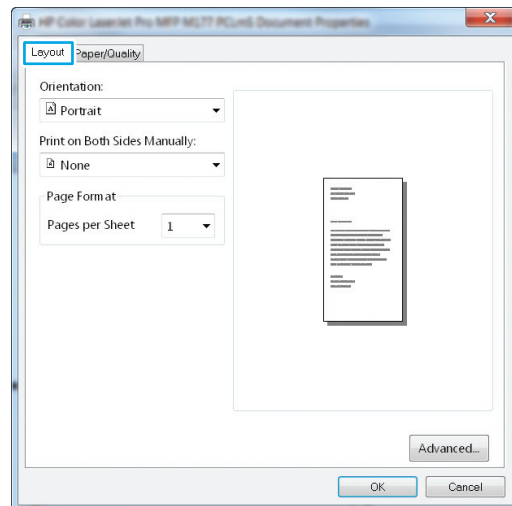

4. Select the appropriate duplex option from the **Print on Both Sides Manually** drop-down list, and then click or tap the **OK** button.

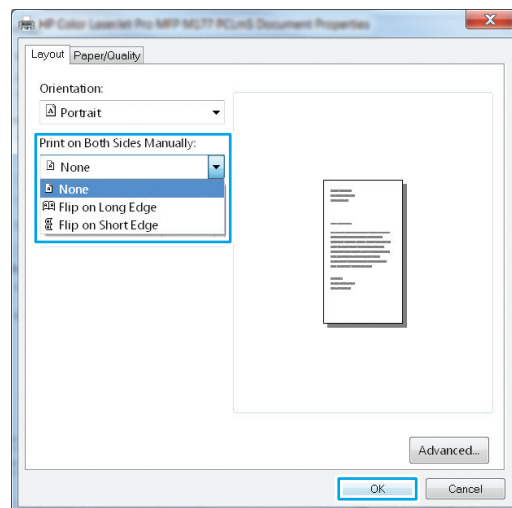

5. In the **Print** dialog box, click the **OK** button to print the job. The product will print the first side of all the pages in the document first.

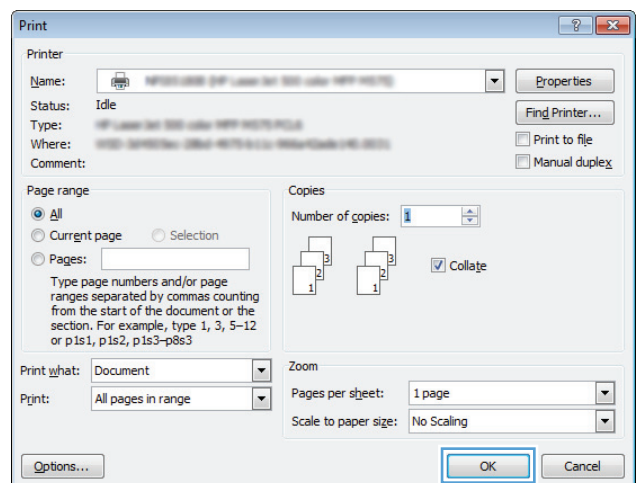

- Retrieve the printed stack from the output bin, and place it with the printed-side facing down, top edge first in the input tray.



- At the computer, click the **OK** button to print the second side of the job.
- If prompted, touch or press the appropriate control panel button to continue.

Print multiple pages per sheet (Windows)

- From the software program, select the **Print** option.
- Select the product from the list of printers, and then click or tap the **Properties** or **Preferences** button to open the print driver.

NOTE: The name of the button varies for different software programs.

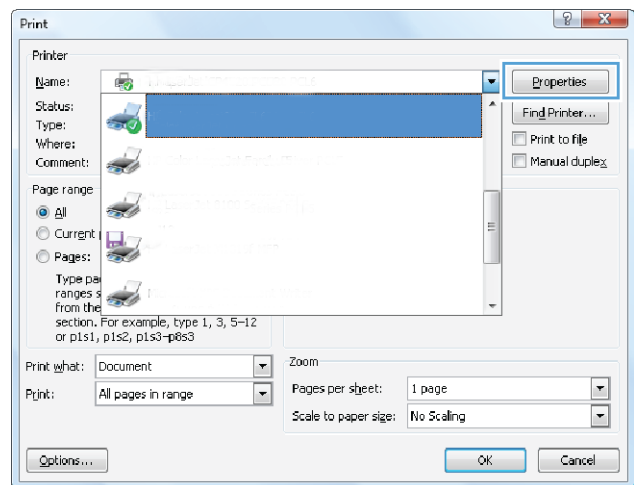

3. Click or tap the **Layout** tab.

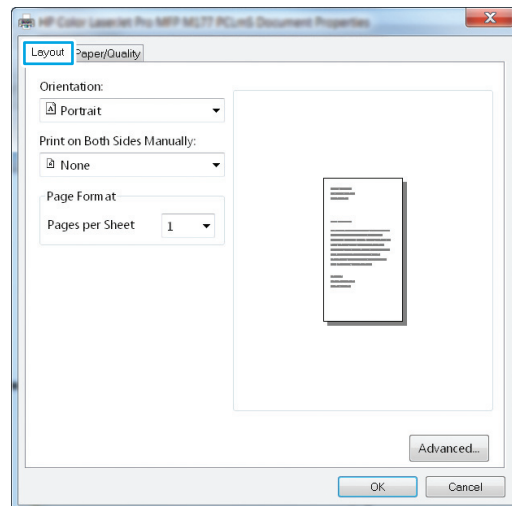

4. Select the correct **Orientation** option from the drop-down list.

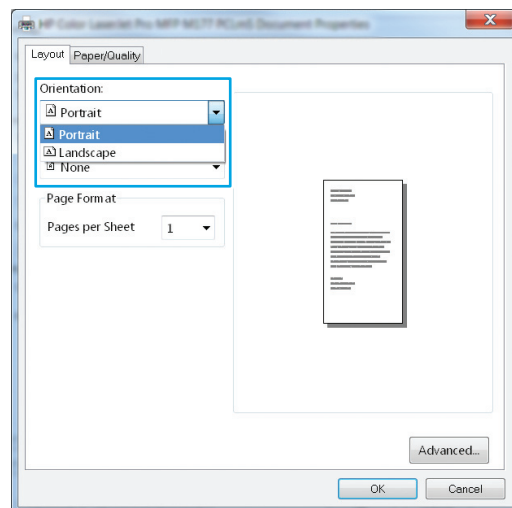

5. Select the correct number of pages per sheet from the **Pages per sheet** drop-down list, and then click or tap the **Advanced** button.

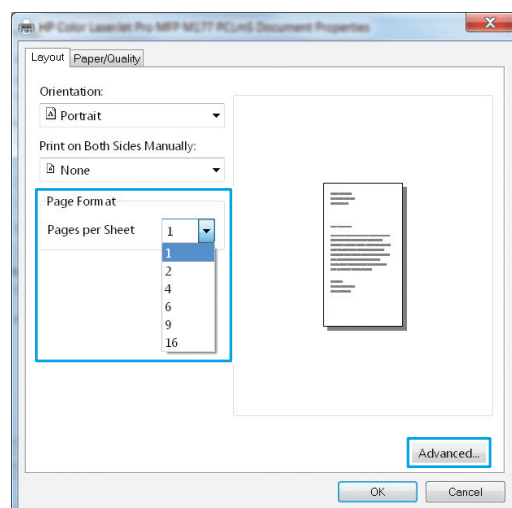

6. Select the correct **Pages per Sheet Layout** option from the drop-down list.

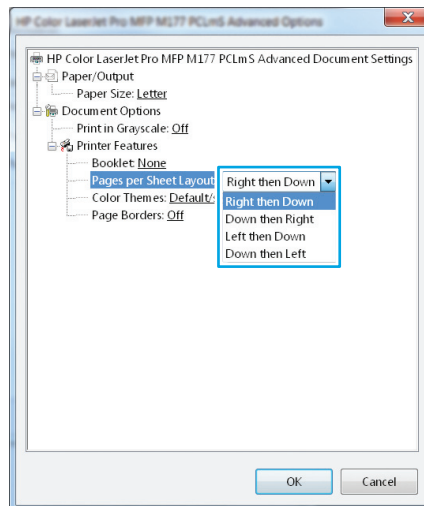

7. Select the correct **Page Borders** option from the drop-down list, click or tap the **OK** button to close the **Advanced Options** dialog box, and then click or tap the **OK** button to close the **Properties** or **Preferences** dialog box.

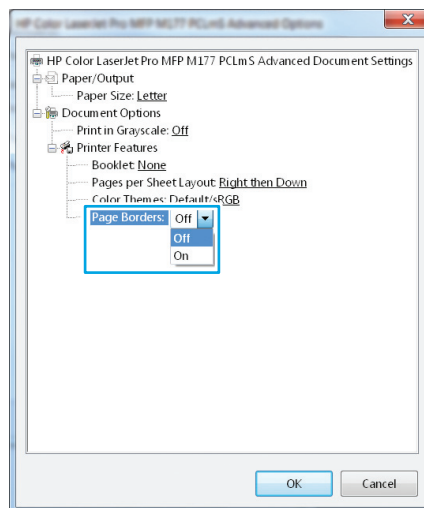

8. In the **Print** dialog box, click or tap the **OK** button to print the job.

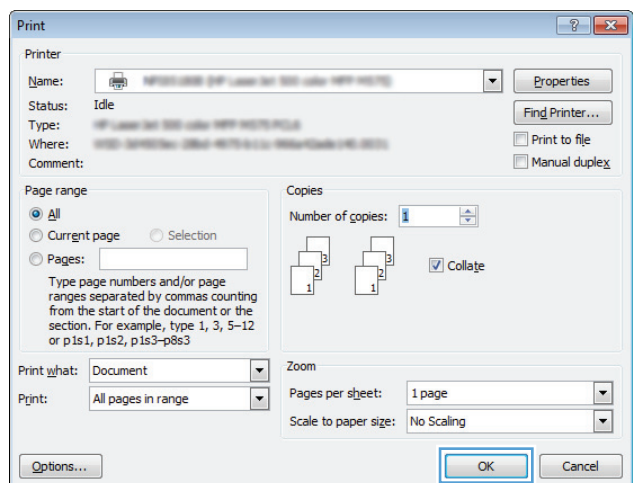

Select the paper type (Windows)

1. From the software program, select the **Print** option.
2. Select the product from the list of printers, and then click or tap the **Properties** or **Preferences** button to open the print driver.

NOTE: The name of the button varies for different software programs.

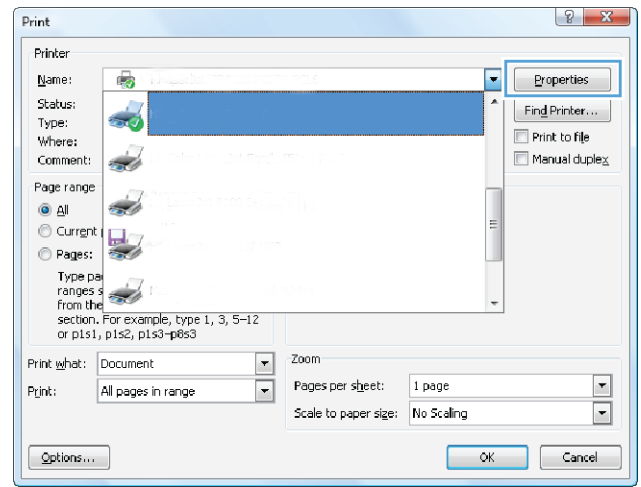

3. Click or tap the **Paper/Quality** tab.

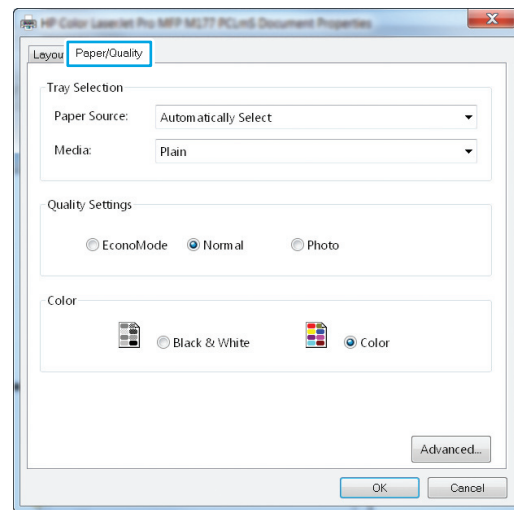

- From the **Media:** drop-down list, select the correct paper type, and then click or tap the **OK** button to close the **Properties** or **Preferences** dialog box.

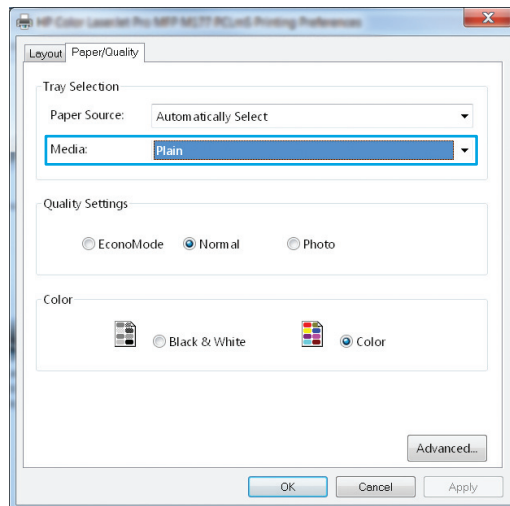

- In the **Print** dialog box, click the **OK** button to print the job.

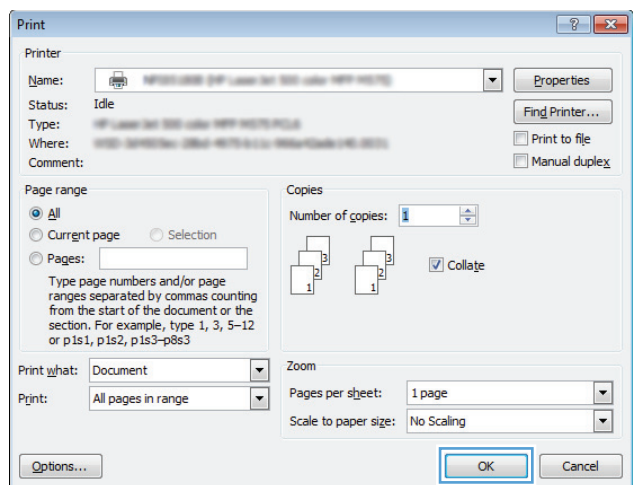

Additional printing information

Go to www.hp.com/support to visit the support Web site for this product and for details about performing specific print tasks, such as the following:

- Select the paper size
- Select the page orientation
- Create a booklet
- Select the quality settings
- Select page borders

Print tasks (Mac OS X)

- [How to print \(Mac OS X\)](#)
- [Manually print on both sides \(Mac OS X\)](#)
- [Print multiple pages per sheet \(Mac OS X\)](#)
- [Select the paper type \(Mac OS X\)](#)
- [Additional printing information](#)

How to print (Mac OS X)

The following procedure describes the basic printing process for Mac OS X.

1. Click the **File** menu, and then click the **Print** option.
2. In the **Printer** menu, select the product.
3. Open the menus drop-down list or click **Show Details**, and then select other menus to adjust the print settings.
4. Click the **Print** button.

Manually print on both sides (Mac OS X)



NOTE: This feature is available if you install the HP print driver. It might not be available if you are using AirPrint.

1. Click the **File** menu, and then click the **Print** option.
2. In the **Printer** menu, select this product.
3. Open the menus drop-down list or click **Show Details**, and then click the **Manual Duplex** menu.
4. Click the **Manual Duplex** box, and then select a binding option.
5. Click the **Print** button.
6. Go to the product, and remove any blank paper that is in the input tray.

7. Retrieve the printed stack from the output bin and place it with the printed-side facing down, top edge first in the input tray.



8. If prompted, touch the appropriate control panel button to continue.

Print multiple pages per sheet (Mac OS X)

1. Click the **File** menu, and then click the **Print** option.
2. In the **Printer** menu, select the product.
3. Open the menus drop-down list or click **Show Details**, and then click the **Layout** menu.
4. From the **Pages per Sheet** drop-down list, select the number of pages that you want to print on each sheet.
5. In the **Layout Direction** area, select the order and placement of the pages on the sheet.
6. From the **Borders** menu, select the type of border to print around each page on the sheet.
7. Click the **Print** button.

Select the paper type (Mac OS X)

1. Click the **File** menu, and then click the **Print** option.
2. In the **Printer** menu, select the product.
3. Open the menus drop-down list or click **Show Details**, and then click the **Finishing** menu.
4. Select a type from the **Media-type** drop-down list.
5. Click the **Print** button.

Additional printing information

Go to www.hp.com/support to visit the support Web site for this product and for details about performing specific print tasks, such as the following:

- Create and use printing shortcuts or presets
- Select the paper size, or use a custom paper size
- Select the page orientation
- Create a booklet
- Scale a document to fit a specific paper size
- Print the first or last pages of the document on different paper
- Print watermarks on a document

Web-based printing

Several options are available for remote printing over the Internet.

HP ePrint

Use HP ePrint to print documents by sending them as an email attachment to the product's email address from any email enabled device.

To use HP ePrint, the product must meet these requirements:

- The product must be connected to a wired or wireless network and have Internet access.
- HP Web Services must be enabled on the product, and the product must be registered with HP Connected.

LCD control panel

1. Find the product IP address.
 - a. On the product control panel, press the Setup  button.
 - b. Open the following menus:
 - **Network Setup**
 - **Show IP Address**
2. To open the HP Embedded Web Server, enter the product IP address into the address line of a Web browser on the computer.
3. Click the **HP Web Services** tab on the HP Embedded Web Server, and then click **Enable**. The product enables Web Services, and then prints an information page.

The information page contains the printer code that you use to register your HP product at HP Connected.

4. Go to www.hpconnected.com to create an HP ePrint account and complete the setup process.

Touchscreen control panel

1. From the Home screen on the product control panel, touch the Web Services  button.
2. Touch the [Enable Web Services](#) button. The product enables Web Services, and then prints an information page.

The information page contains the printer code that you use to register your HP product at HP Connected.

3. Go to www.hpconnected.com to create an HP ePrint account and complete the setup process.

For more information, go to www.hp.com/support to review additional support information for your product.

HP ePrint software

The HP ePrint software makes it easy to print from a desktop or laptop computer to any HP ePrint capable product. After installing the software, open the **Print** option from within your application, and then select **HP ePrint** from the installed printers list. This software makes it easy to find HP ePrint-enabled products that

are registered to your HP Connected account. The target HP product can be at your desk or in a remote location, such as a branch office or across the globe.

For Windows, the HP ePrint software also supports traditional direct IP printing to local network printers on the network (LAN or WAN) to supported PostScript® products.

Go to www.hp.com/go/eprintsoftware for drivers and information.

 **NOTE:** The HP ePrint software is a PDF workflow utility for Mac, and is not technically a print driver. HP ePrint software for Mac supports print paths only through HP Connected and does not support direct IP printing to local network printers.

AirPrint

Direct printing using Apple's AirPrint is supported for iOS 4.2 or later. Use AirPrint to print directly to the product from an iPad, iPhone (3GS or later), or iPod touch (third generation or later) in the following applications:

- Mail
- Photos
- Safari
- iBooks
- Select third-party applications

To use AirPrint, the product must be connected to the same wireless network as the Apple device. For more information about using AirPrint and about which HP products are compatible with AirPrint, go to www.hp.com/go/airprint.

 **NOTE:** AirPrint does not support USB connections. AirPrint provides print-only mobile functionality. AirPrint does not support scanning.

Set up HP Wireless Direct Printing (touchscreen models only)



NOTE: This feature is available with wireless models only and the product might require a firmware update to use this feature.

The HP Wireless Direct Printing feature lets you print from your wireless mobile device directly to an HP Wireless Direct-enabled product without requiring connection to an established network or the Internet. Use HP Wireless Direct to print wirelessly from the following devices:

- iPhone, iPad, or iTouch using Apple AirPrint or the HP ePrint mobile app
- Mobile devices that run Android, iOS, or Symbian using the HP ePrint Home & Biz application
- Any wireless capable computer with any operating system.

For more information on HP Wireless Direct, go to www.hp.com/go/wirelessprinting, and then click **HP Wireless Direct**.

To set up HP Wireless Direct from the control panel, complete the following steps:

1. From the Home screen on the product control panel, touch the Wireless  button.
2. Open the following menus:
 - [Wireless Menu](#)
 - [Wireless Direct Settings](#)
 - [On/Off](#)
3. Touch the [On](#) menu item. The product saves the setting and then returns the control panel to the [Wireless Direct Settings](#) menu.

4 Copy

- [Make a copy](#)
- [Copy on both sides \(duplex\)](#)
- [Optimize copy quality](#)



Go to www.hp.com/support/ljMFPM176series or www.hp.com/support/ljMFPM177series for HP's all-inclusive help for your product:

- Solve problems.
- Download software updates.
- Join support forums.
- Find warranty and regulatory information.

You can also go to www.hp.com/support for Worldwide support and other HP products.

Make a copy



LCD control panel

1. Load the document on the scanner glass according to the indicators on the product.
2. Close the scanner.
3. At the product control panel, press the Number of Copies  button.
4. Select the number of copies.
5. Press either the Black Start Copy  button or the Color Start Copy  button to start copying.



Touchscreen control panel

1. Load the document on the scanner glass according to the indicators on the product.
2. Close the scanner.
3. From the Home screen on the product control panel, touch the **Copy** button.
4. Touch the arrows to change the number of copies, or touch the existing number and type the number of copies.
5. Touch the **Black** or **Color** button to start copying.

Copy on both sides (duplex)

1. Load the document on the scanner glass according to the indicators on the product.
2. Close the scanner.
3. Start the copy job.
 - **LCD control panel:** On the product control panel, press either the Black Start Copy  button or the Color Start Copy  button.
 - **Touchscreen control panel:** From the Home screen on the product control panel, touch the **Copy** button, select the number of copies, and then touch the **Black** or **Color** button.
4. Retrieve the printed page from the output bin, and place it with the printed-side facing down, top edge first in input tray.





5. Flip the original document on the scanner glass to copy the second side.
6. Start the copy job.
 - **LCD control panel:** On the product control panel, press either the Black Start Copy  button or the Color Start Copy  button.
 - **Touchscreen control panel:** From the Home screen on the product control panel, touch the **Copy** button, select the number of copies, and then touch the **Black** or **Color** button.
7. Repeat this process until you have copied all of the pages.

Optimize copy quality

The following copy-quality settings are available:

- **Auto Select:** Use this setting when you are not concerned about the quality of the copy. This is the default setting.
- **Mixed:** Use this setting for documents that contain a mixture of text and graphics.
- **Text:** Use this setting for documents that contain mostly text.
- **Picture:** Use this setting for documents that contain mostly graphics.

LCD control panel

1. Load the document on the scanner glass according to the indicators on the product.
2. Close the scanner.
3. On the product control panel, press the Copy Menu  button.
4. Open the **Optimize** menu.
5. Use the arrow buttons to scroll through the options, and then press the **OK** button to select it.
6. Press either the Black Start Copy  button or the Color Start Copy  button to start copying.

Touchscreen control panel

1. Load the document on the scanner glass according to the indicators on the product.
2. Close the scanner.
3. From the Home screen on the product control panel, touch the **Copy** button.
4. Touch the **Settings** button, and then scroll to and touch the **Optimize** button.
5. Touch the arrow buttons to scroll through the options, and then touch an option to select it.
6. Touch the Back  button, and then touch the **Black** or **Color** button to start copying.

5 Scan

- [Scan by using the HP Scan software \(Windows\)](#)
- [Scan by using the HP Scan software \(Mac OS X\)](#)

Go to www.hp.com/support/ljMFPM176series or www.hp.com/support/ljMFPM177series for HP's all-inclusive help for your product:

- Solve problems.
- Download software updates.
- Join support forums.
- Find warranty and regulatory information.

You can also go to www.hp.com/support for Worldwide support and other HP products.

Scan by using the HP Scan software (Windows)

Use the HP Scan software to initiate scanning from software on your computer. You can save the scanned image as a file or send it to another software application.

1. Load the document on the scanner glass according to the indicators on the product.



NOTE: For best results, load small-size paper (Letter, A4, or smaller) with the long edge of the paper along the left side of the scanner glass.

2. Click **Start**, and then click **Programs** (or **All Programs** in Windows XP).
3. Click **HP**, and then select your product.
4. Click **HP Scan**, select a scanning shortcut, and then adjust the settings if necessary.
5. Click **Scan**.



NOTE: Click **Advanced Settings** to gain access to more options.

Click **Create New Shortcut** to create a customized set of settings and save it in the list of shortcuts.

Scan by using the HP Scan software (Mac OS X)

Use the HP Scan software to initiate scanning from software on your computer.

1. Load the document on the scanner glass according to the indicators on the product.



NOTE: For best results, load small-size paper (letter, A4, or smaller) with the long edge of the paper along the left side of the scanner glass.

2. Open the **HP Scan** software, which is located in the **Hewlett-Packard** folder inside the **Applications** folder.
3. Follow the on-screen instructions to scan the document.
4. When you have scanned all the pages, click the **Done** button to save them to a file.

6 Fax

- [Connect and configure the product for fax](#)
- [Send a fax](#)
- [Create, edit, and delete speed-dial entries](#)

Go to www.hp.com/support/ljMFPM176series or www.hp.com/support/ljMFPM177series for HP's all-inclusive help for your product:

- Solve problems.
- Download software updates.
- Join support forums.
- Find warranty and regulatory information.

You can also go to www.hp.com/support for Worldwide support and other HP products.

Connect and configure the product for fax

- [Connect the product](#)
- [Configure the product](#)
- [Install the HP Fax software \(Windows, optional\)](#)

Connect the product

The product is an analog device. HP recommends using the product on a dedicated analog telephone line.

 **NOTE:** Some countries/regions might require an adapter for the telephone cable that came with the product.

1. Connect the telephone cable to the fax port  on the product and to the telephone jack on the wall.

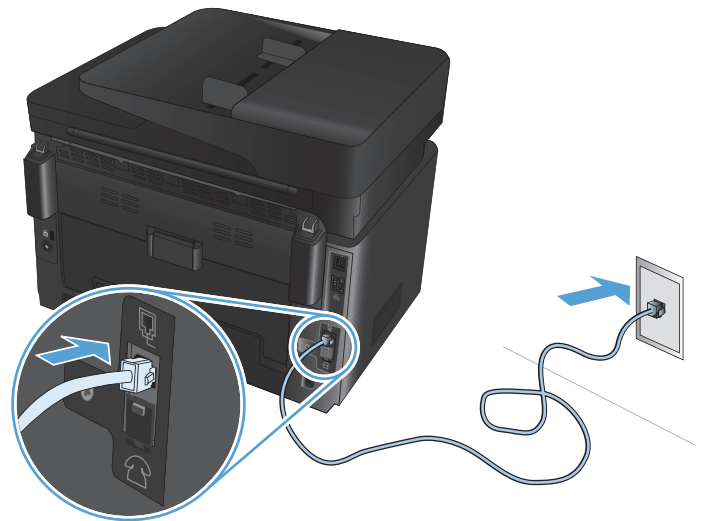

2. (Optional) To connect an answering machine or extension phone, pull down the rubber plug from the telephone port  on the product. Connect another telephone cable to the telephone port on the product and to the “line in” port on the answering machine or extension phone.

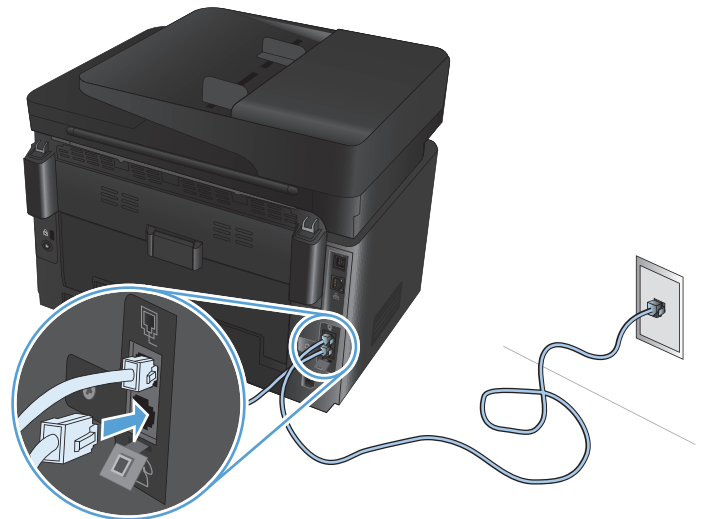

Configure the product

How you configure the product varies depending on whether you set it up for standalone fax, with an answering machine, or with an extension phone.

 **NOTE:** Configuring the fax time, date, and header settings is required to use the fax feature.

- [Configure fax time, date, and header](#)
- [Configure for stand-alone fax](#)
- [Configure for an answering machine](#)
- [Configure for an extension phone](#)

Configure fax time, date, and header

You might have configured these settings when you installed the software. You can configure these settings at any time by using the product control panel or the HP Fax Setup Wizard.

- [Control panel](#)
- [HP Fax Setup Wizard \(Windows\)](#)

Control panel

1. From the Home screen on the product control panel, select Setup .
2. Select [Fax Setup](#), and then select [Basic Setup](#).
3. Select [Time/Date](#).
4. Select the 12-hour clock or 24-hour clock.
5. Use the keypad to enter the current time, and then select [OK](#).
6. Select the date format.
7. Use the keypad to enter the current date, and then select [OK](#).
8. Select [Fax Header](#).
9. Use the keypad to enter your fax number, and then select [OK](#).

 **NOTE:** The maximum number of characters for the fax number is 20.

10. Use the keypad to enter your company name or header, and then select [OK](#).

To enter special characters that are not on the standard keypad, select [@#\\$](#) to open a keypad that contains special characters.

 **NOTE:** The maximum number of characters for the fax header is 40.

HP Fax Setup Wizard (Windows)

1. Click **Start**, and then click **Programs**.
2. Click **HP**, click the name of the product, and then click **Fax Setup Wizard**.
3. Follow the on-screen instructions to configure the fax settings.

Configure for stand-alone fax



You can use the product as a stand-alone fax machine without connecting it to a computer or a network.

1. From the Home screen on the product control panel, select Setup .
2. Select **Fax Setup**, and then select **Fax Set-Up Utility**.
3. Follow the on-screen prompts and select the appropriate response for each question.

 **NOTE:** The maximum number of characters for the fax number is 20. The maximum number of characters for the fax header is 40.

Configure for an answering machine

If you connect a telephone answering machine to the product, you need to configure the **Rings to Answer** and **Answer Mode** settings for the product. Follow these steps to configure the product.

1. From the Home screen on the product control panel, select Setup .
2. Select **Fax Setup**, and then select **Basic Setup**.
3. Select **Rings to Answer**.
4. Set the product rings-to-answer setting for at least one ring more than the number of rings for which the answering machine is set. Use the keypad to enter the number of rings, and then select **OK**.
5. Select Back  to return to the **Basic Setup** menu.
6. Select **Answer Mode**.
7. Select **TAM**, and then select **OK**.

With this setting, the product listens for fax tones after the answering machine has picked up the call. The product picks up a call if fax tones are detected.

Configure for an extension phone

If you connect an extension phone to the product, you need to change some fax settings for the product to work with this configuration. Follow these steps to configure the product.

1. From the Home screen on the product control panel, select Setup .
2. Select **Fax Setup**, and then select **Advanced Setup**.
3. Select **Extension Phone**.
4. Make sure that the **On** option is selected.

With this setting turned on, you can alert the product to pick up the incoming fax call by pressing 1-2-3 sequentially on the telephone keypad. Turn this setting off only if you use pulse dialing or if you have a

service from your telephone company that also uses the 1-2-3 sequence. The telephone company service does not work if it conflicts with the product.

5. Select Back ↩ twice to return to the **Fax Setup** menu.
6. Select **Basic Setup**, and then select **Answer Mode**.
7. Select **Fax/Tel**.

With this setting, the product automatically picks up all calls and determines if the call is a voice or fax call. If the call is a fax call, the product handles the call as an incoming fax. If the incoming call is detected as a voice call, the product generates an audible synthesized ring to alert you of an incoming voice call.

8. Select Back ↩ twice to return to the **Fax Setup** menu.
9. Select **Advanced Setup**, and then select **Fax/Tel Ring Time**.
10. Select the number of seconds after which the product should stop sounding the Fax/Tel audible ring to notify you of an incoming voice call.

Install the HP Fax software (Windows, optional)

With HP Fax software, you can fax electronic documents from a computer if you meet the following requirements:

- The product is connected directly to the computer or to a network to which the computer is connected.
- The product software is installed on the computer.
- The computer operating system is one that this product supports.

 **NOTE:** The HP Fax software that came with the product is the only computer fax program that works with the product. The product is not compatible with fax software produced by other manufacturers.

If the HP Fax software is not installed on your computer, use one of the following methods to install the software.

- **Software CD:** Insert the software CD that shipped with your HP product into the computer, and then follow the on-screen instructions.
- **Download from the Web:** Go to www.hp.com/support, click **Drivers & Software**, and then follow the on-screen instructions to download the latest HP software.

 **NOTE:** When prompted by the software installer, make sure that **HP Fax Software** is selected as one of the software components to install.

Send a fax

- [Send a fax by dialing manually from the product control panel](#)
- [Send a fax from the HP software \(Windows\)](#)

 **CAUTION:** To prevent damage to the product, do not use an original that contains correction tape, correction fluid, paper clips, or staples. Also, do not load photographs, small originals, or fragile originals into the document feeder.

Send a fax by dialing manually from the product control panel

1. Load the document.
 - If you are loading an original on the scanner glass, place it on the scanner glass face-down, in the left rear corner of the scanner glass.
 - If you are loading multiple pages in the document feeder, load the pages face-up, and then adjust the paper guides until they are snug against the paper.

 **NOTE:** If documents are in the document feeder and on the scanner glass at the same time, the product processes the document in the document feeder and not the one on the scanner glass.

2. From the Home screen on the product control panel, select **Fax**.
3. Use the keypad to enter the fax number.

 **NOTE:** To use access codes, credit cards, or calling cards, you must dial the fax number manually to allow for pauses and dialing codes. To send a fax to an international destination, dial manually to allow for pauses and international dialing codes. You cannot use speed dials with access codes, credit cards, calling cards, or to dial international destinations.

4. Select **Start Fax**.

 **NOTE:** If you are faxing from the scanner glass and your document includes multiple pages, follow the control panel prompts to confirm and load additional pages.

Send a fax from the HP software (Windows)

1. Load the document.
 - If you are loading an original on the scanner glass, place it on the scanner glass face-down, in the left rear corner of the scanner glass.
 - If you are loading multiple pages in the document feeder, load the pages face-up, and then adjust the paper guides until they are snug against the paper.

 **NOTE:** If documents are in the document feeder and on the scanner glass at the same time, the product processes the document in the document feeder and not the one on the scanner glass.

2. From the computer, click **Start**, click **Programs** (or **All Programs** in Windows XP), and then click **HP**.
3. Click the product name, and then click **HP Send Fax**. The fax software opens.
4. Enter the fax number of one or more recipients.
5. Click **Send Now**.

Create, edit, and delete speed-dial entries

You can store frequently dialed fax numbers (up to 100 entries) as speed-dial entries.

- [Create and edit speed-dial entries](#)
- [Delete speed-dial entries](#)

Create and edit speed-dial entries

1. From the Home screen on the product control panel, touch the **Fax** button.
2. Touch **Fax Menu**, and then touch **Phone Book Setup**.
3. Touch **Individual Setup**.
4. Select an unassigned number from the list.
5. Use the keypad to enter a name for the entry, and then touch the **OK** button.
6. Use the keypad to enter the fax number for the entry, and then touch the **OK** button.

Delete speed-dial entries

1. From the Home screen on the product control panel, touch the **Fax** button.
2. Touch **Fax Menu**, and then touch **Phone Book Setup**.
3. Touch **Delete Entry**.
4. Select the entry you want to delete, and then touch the **OK** button.



NOTE: If you want to delete all speed-dial entries, select **Delete All Entries**.

7 Manage the product

- [Change the product connection type \(Windows\)](#)
- [Use HP Web Services applications \(touchscreen models only\)](#)
- [HP Device Toolbox \(Windows\)](#)
- [HP Utility for Mac OS X](#)
- [Product security features](#)
- [Economy settings](#)
- [A <Color> cartridge is low or <Color> cartridge is very low message displays on the product control panel](#)
- [Replace the toner cartridge](#)
- [Replace the imaging drum](#)

Go to www.hp.com/support/ljMFPM176series or www.hp.com/support/ljMFPM177series for HP's all-inclusive help for your product:

- Solve problems.
- Download software updates.
- Join support forums.
- Find warranty and regulatory information.

You can also go to www.hp.com/support for Worldwide support and other HP products.

Change the product connection type (Windows)

If you are already using the product and you wish to change the way it is connected, use the **Reconfigure your HP Device** shortcut on your computer desktop to change the connection. For example, you can reconfigure the product to use a different wireless address, to connect to a wired or wireless network, or change from a network connection to a USB connection. You can change the configuration without inserting the product CD. After you select the type of connection you wish to make, the program goes directly to the portion of the product setup procedure that needs to change.

Use HP Web Services applications (touchscreen models only)

Several innovative applications are available for this product that you can download directly from the Internet. For more information and to download these applications go to the HP Connected Web site at www.hpconnected.com.

To use this feature, the product must be connected to a computer or network that has an Internet connection. HP Web Services must be enabled on the product.

1. From the Home screen on the product control panel, touch the Web Services  button.
2. Touch the [Enable Web Services](#) button.

After you download an application from the HP Connected Web site, it is available in the [Apps](#) menu on the product control panel. This process enables both HP Web Services and the [Apps](#) menu.

HP Device Toolbox (Windows)

Use the HP Device Toolbox for Windows to check product status or to view or change product settings from your computer. This tool opens the HP Embedded Web Server for the product.



NOTE: This tool is available only if you performed a full installation when you installed the product. Depending on how the product is connected, some features might not be available.

1. Click the **Start** button, and then click the **Programs** item.
2. Click your HP product group, and then click the **HP Device Toolbox** item.

Tab or section	Description
Home tab Provides product, status, and configuration information.	<ul style="list-style-type: none">• Device Status: Shows the product status and shows the approximate percent life remaining of HP supplies.• Supplies Status: Shows the approximate percent life remaining of HP supplies. Actual supply life remaining can vary. Consider having a replacement supply available to install when print quality is no longer acceptable. The supply does not need to be replaced unless the print quality is no longer acceptable.• Device Configuration: Shows the information found on the product configuration page.• Network Summary: Shows the information found on the product network configuration page.• Reports: Print the configuration and supplies status pages that the product generates.• Event Log: Shows a list of all product events and errors.
System tab Provides the ability to configure the product from your computer.	<ul style="list-style-type: none">• Device Information: Provides basic product and company information.• Paper Setup: Change the default paper-handling settings for the product.• Print Quality: Change the default print-quality settings for the product.• EcoSMART Console: Change the default times for entering Sleep mode or Auto Power Down mode. Configure which events cause the product to wake.• Paper Types: Configure print modes that correspond to the paper types that the product accepts.• System Setup: Change the system defaults for the product.• Service: Perform the cleaning procedure on the product.• Save and Restore: Save the current settings for the product to a file on the computer. Use this file to load the same settings onto another product or to restore these settings to this product at a later time.• Administration: Set or change the product password. Enable or disable product features. <p>NOTE: The System tab can be password-protected. If this product is on a network, always consult with the administrator before changing settings on this tab.</p>
Print tab Provides the ability to change default print settings from your computer.	<p>Printing: Change the default product print settings, such as number of copies and paper orientation. These are the same options that are available on the control panel.</p>

Tab or section	Description
Fax tab	<ul style="list-style-type: none"> • Phone Book: Add or delete entries in the fax phone book. • Junk Fax List: Set fax numbers to block from sending faxes to the product. • Fax Activity Log: Review recent fax activity for the product.
Networking tab Provides the ability to change network settings from your computer.	Network administrators can use this tab to control network-related settings for the product when it is connected to an IP-based network. It also allows the network administrator to set up Wireless Direct functionality. This tab does not appear if the product is directly connected to a computer.
HP Web Services tab	Use this tab to set up and use various Web tools with the product.
HP Smart Install tab	Use this tab to disable HP Smart Install or to download and install the product software.

HP Utility for Mac OS X

Use the HP Utility for Mac OS X to view or change product settings from your computer.

You can use the HP Utility when the product is connected with a USB cable or is connected to a TCP/IP-based network.

Open the HP Utility

From the Finder, click **Applications**, click **Hewlett-Packard**, and then click **HP Utility**.

If HP Utility is not included, use the following procedure to open it:

1. At the computer, open the Apple  menu, click the **System Preferences** menu, and then click the **Print & Fax** icon or the **Print & Scan** icon.
2. Select the product in the left side of the window.
3. Click the **Options & Supplies** button.
4. Click the **Utility** tab.
5. Click the **Open Printer Utility** button.

HP Utility features

The HP Utility toolbar is at the top of every page. It includes these items:

- **Devices:** Click this button to show or hide Mac products found by the HP Utility in the **Printers** pane at the left side of the screen.
- **All Settings:** Click this button to return to the HP Utility main page.
- **HP Support:** Click this button to open a browser and go to the HP support Web site for the product.
- **Supplies:** Click this button to open the HP SureSupply Web site.
- **Registration:** Click this button to open the HP registration Web site.
- **Recycling:** Click this button to open the HP Planet Partners Recycling Program Web site.

HP Utility consists of pages that you open by clicking in the **All Settings** list. The following table describes the tasks that you can perform with HP Utility.

Menu	Item	Description
Information and Support	Supplies Status	Show the product supplies status and provides links for ordering supplies online.
	Device Information	Show information about the currently selected product, including the product Service ID (if assigned), the firmware version (FW Version), the Serial Number, and the IP address.

Menu	Item	Description
	File Upload	Transfer files from the computer to the product. You can upload the following types of files: <ul style="list-style-type: none"> • HP LaserJet printer command language (.PRN) • Portable document format (.PDF) • Text (.TXT)
	HP Connected	Access the HP Connected Web site.
Information	Message Center	Display error events that have occurred with the product.
Printer Settings	Auto-off	Configure the product to automatically turn off after a period of inactivity. You can adjust the number of minutes after which the product turns off.
	Network Settings	Configure the network settings, such as the IPv4 settings, IPv6 settings, Bonjour settings, and other settings.
	Supplies Management	Configure how the product should behave when supplies are nearing the end of their estimated life.
	Trays Configuration	Change the paper size and type for each of the trays.
	Additional Settings	Open the HP Embedded Web Server (EWS) for the product. NOTE: USB connections are not supported.
Fax Settings	Basic Fax Settings	Set up the fields in the fax header and configure how the product answers incoming calls.
	Junk Fax Blocking	Store the fax numbers you want to block.
	Fax Forwarding	Set up the product to send the incoming faxes to a different number.
	Fax Logs	View the logs of all faxes.
	Fax Speed Dials	Add fax numbers to the speed dial list.

Product security features

The product supports security standards and recommended protocols that help you keep the product secure, protect critical information on your network, and simplify the way you monitor and maintain the product.

For in-depth information about HP's secure imaging and printing solutions, visit www.hp.com/go/secureprinting. The site provides links to white papers and FAQ documents about security features.

Set or change the product password

Use the HP Embedded Web Server to set a password or change an existing password for a product on a network.

LCD control panel

1. On the product control panel, press the Setup  button.
2. Open the following menus:
 - **Network Setup**
 - **Show IP Address**
3. To open the HP Embedded Web Server, enter the product IP address into the address line of a Web browser.

 **NOTE:** You can also access the HP Embedded Web Server from the HP Device Toolbox for Windows or the HP Utility for Mac OS X.

4. Click the **System** tab, and click the **Product Security** link.

 **NOTE:** If a password has previously been set, you are prompted to provide the password. Enter the password, and then click the **Apply** button.

5. Enter the new password in the **New Password** box and in the **Verify Password** box.
6. At the bottom of the window, click the **Apply** button to save the password.

Touchscreen control panel

1. From the Home screen on the product control panel, touch the Network  button to find the product IP address.
2. To open the HP Embedded Web Server, enter the product IP address into the address line of a Web browser.

 **NOTE:** You can also access the HP Embedded Web Server from the HP Device Toolbox for Windows or the HP Utility for Mac OS X.

3. Click the **System** tab, and then click the **Product Security** link.

 **NOTE:** If a password has previously been set, you are prompted to provide the password. Enter the password, and then click the **Apply** button.

4. Enter the new password in the **New Password** box and in the **Verify Password** box.
5. At the bottom of the window, click the **Apply** button to save the password.

Lock the product

1. You can attach a security cable to the slot on the back of the product.

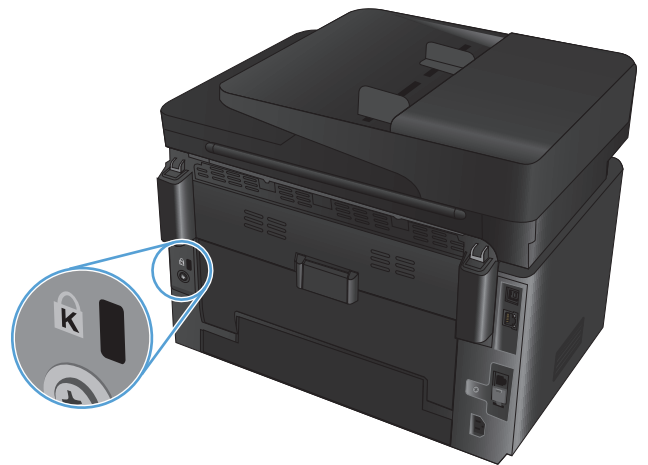

Economy settings

- [Print with EconoMode](#)
- [Configure the Sleep/Auto Off After setting](#)

Print with EconoMode

This product has an EconoMode option for printing drafts of documents. Using EconoMode can use less toner. However, using EconoMode can also reduce print quality.

HP does not recommend the full-time use of EconoMode. If EconoMode is used full-time, the toner supply might outlast the mechanical parts in the toner cartridge. If print quality begins to degrade and is no longer acceptable, consider replacing the toner cartridge.

 **NOTE:** If this option is not available in your print driver, you can set it using the HP Embedded Web Server.

1. From the software program, select the **Print** option.
2. Select the product, and then click the **Properties** or **Preferences** button.
3. Click the **Paper/Quality** tab.
4. Click the **EconoMode** check box.

Configure the Sleep/Auto Off After setting

LCD control panel

1. On the product control panel, press the Setup  button.
2. Open the following menus:
 - **System Setup**
 - **Energy Settings**
 - **Sleep/Auto Off After**
3. Use the arrow keys to select the time for the Sleep/Auto Off delay, and then press the **OK** button.

 **NOTE:** The default value is **15 Minutes**.

4. The product automatically wakes when it receives jobs or when you press a button on the product control panel. You can change which events cause the product to wake. Open the following menus:
 - **System Setup**
 - **Energy Settings**
 - **Wake/Auto On Events**

To turn off a wake event, select the event, and then select the **No** option.

Touchscreen control panel

1. From the Home screen on the product control panel, touch the Setup  button.
2. Open the following menus:
 - [System Setup](#)
 - [Energy Settings](#)
 - [Sleep/Auto Off After](#)
3. Select the time for the Sleep/Auto Off delay.



NOTE: The default value is **15 Minutes**.

4. The product automatically wakes when it receives jobs or when you touch the screen on the product control panel. You can change which events cause the product to wake. Open the following menus:
 - [System Setup](#)
 - [Energy Settings](#)
 - [Wake/Auto On Events](#)

To turn off a wake event, select the event, and then select the **No** option.

A <Color> cartridge is low or <Color> cartridge is very low message displays on the product control panel

A <Color> cartridge is low or <Color> cartridge is very low message displays on the product control panel, and the product does not print.

 **NOTE:** Toner level warnings and indicators provide estimates for planning purposes only. When an indicator shows low-toner levels, consider having a replacement cartridge available to avoid possible printing delays. You do not need to replace cartridges until print quality becomes unacceptable.

Once an HP toner cartridge has reached “very low”, HP’s Premium Protection Warranty on that toner cartridge has ended.

You can change the way the product reacts when supplies reach the Very Low state. You do not have to re-establish these settings when you install a new toner cartridge.

Enable or disable the Very Low settings

You can enable or disable the default settings at any time, and you do not have to re-enable them when you install a new toner cartridge.

LCD control panel

1. On the product control panel, press the Setup  button.
2. Open the following menus:
 - **System Setup**
 - **Supply Settings**
 - **Black Cartridge** or **Color Cartridge**
 - **Very Low Setting**
3. Select one of the following options, and then press the **OK** button:
 - Select the **Stop** option to set the product to stop printing until you replace the toner cartridge.
 - Select the **Prompt** option to set the product to stop printing and prompt you to replace the toner cartridge. You can acknowledge the prompt and continue printing.
 - Select the **Continue** option to set the product to alert you that the toner cartridge is very low, but to continue printing.
 - For color toner cartridges only, select the **Print Black** option to continue printing in black and white if the color toner cartridges are very low.

Touchscreen control panel

1. From the Home screen on the product control panel, touch the Setup  button.
2. Open the following menus:
 - [System Setup](#)
 - [Supply Settings](#)

- [Black Cartridge](#) or [Color Cartridge](#)
 - [Very Low Setting](#)
3. Select one of the following options:
- Select the [Stop](#) option to set the product to stop printing until you replace the toner cartridge.
 - Select the [Prompt](#) option to set the product to stop printing and prompt you to replace the toner cartridge. You can acknowledge the prompt and continue printing.
 - Select the [Continue](#) option to set the product to alert you that the toner cartridge is very low, but to continue printing.
 - For color toner cartridges only, select the [Print Black](#) option to continue printing in black and white if the color toner cartridges are very low.

For models with fax, when the product is set to the [Stop](#) option there is some risk that faxes will not print after the new cartridge is installed if your product has received more faxes than the memory can hold while stopped.

For models with fax, when the product is set to the [Prompt](#) option, there is some risk that faxes will not print after the new cartridge is installed if your product has received more faxes than the memory can hold while the product is waiting for the prompt to be acknowledged.

Once an HP toner cartridge has reached **Very Low**, HP's Premium Protection Warranty on that toner cartridge has ended. All print defects or cartridge failures incurred when an HP toner cartridge is used in [Continue](#) at very low mode will not be considered to be defects in materials or workmanship in the toner cartridge under the HP Print Cartridge Warranty Statement.

Replace the toner cartridge

When a toner cartridge approaches the end of useful life, you are prompted to order a replacement. You can continue printing with the current cartridge until redistributing the toner no longer yields acceptable print quality.

1. Rotate the cartridges to access the cartridge that needs replacement.

- **LCD Control panel:** Press the Rotate Cartridges  button to access the cartridge that needs replacement. The control panel indicates the cartridge that is accessible in the rotation.
- **Touchscreen control panel:** Touch the Supply icon for the cartridge that needs replacement. The cartridges rotate to the cartridge you select.

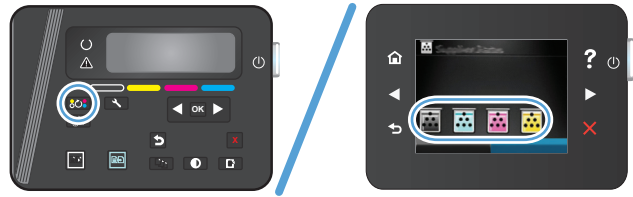

2. Lift the scanner assembly.

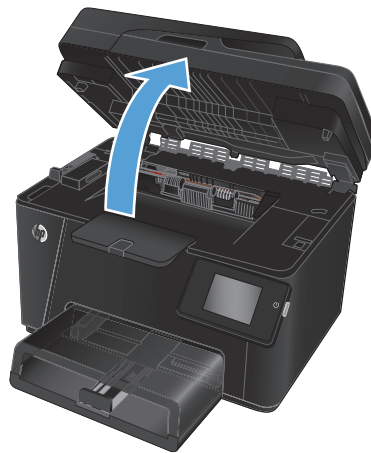

3. Open the top cover.

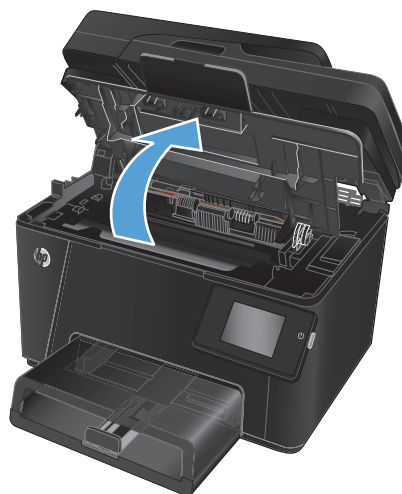

4. Remove the toner cartridge.

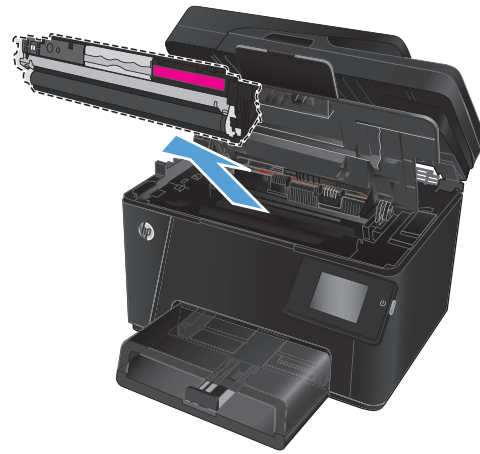

5. Remove the new toner cartridge from the bag. Place the used toner cartridge in the bag for recycling.

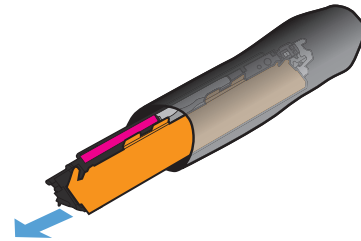

6. Grasp both sides of the toner cartridge and distribute the toner by gently rocking the cartridge.

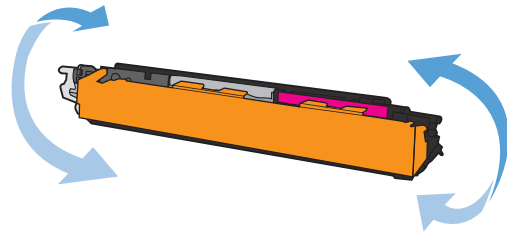

7. Grasp the toner cartridge by the center handle, and then pull the protective plastic shield straight off the cartridge.

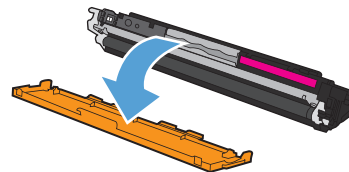

CAUTION: Do not touch the shutter or the surface of the roller.

8. Bend the tab on the left side of the cartridge until the tab breaks loose. Pull the tab until all the tape is removed from the cartridge. Place the tab and tape in the toner cartridge box to return for recycling.

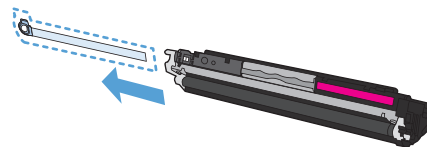

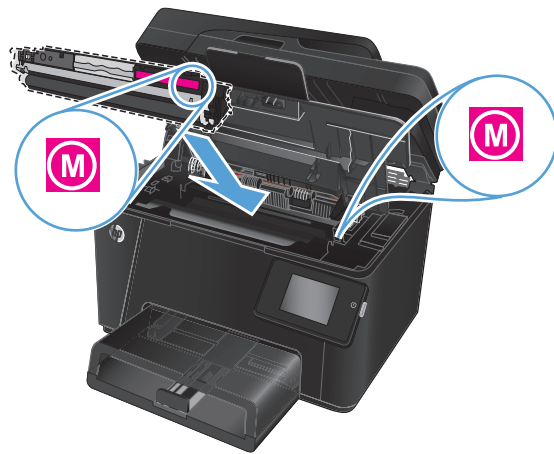

9. Align the toner cartridge with the tracks inside the product, and then insert the toner cartridge until it is firmly seated.

NOTE: Compare the color label on the toner cartridge to the color label in the carousel slot to make sure the toner cartridge color matches the carousel position.

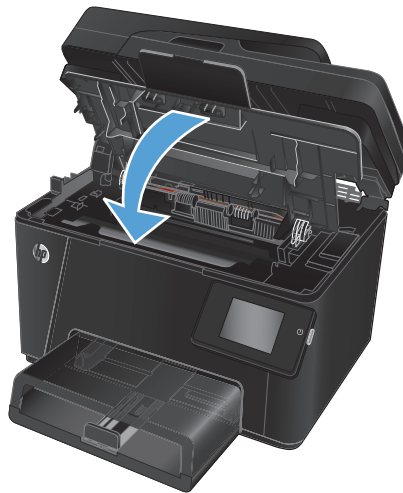

10. Close the top cover.



11. Rotate to the next cartridge that needs replacement.
- **LCD Control panel:** Press the Rotate Cartridges  button to move to the next

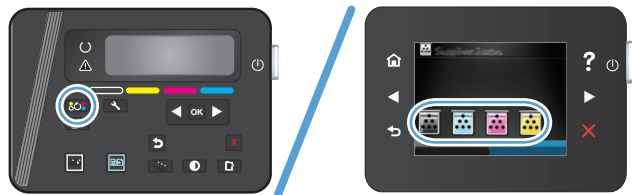

cartridge. Repeat this process until you have finished replacing toner cartridges.

- **Touchscreen control panel:** Touch the Supply icon for the cartridge that needs replacement. The cartridges rotate to the cartridge you select. Repeat this process until you have finished replacing toner cartridges.

NOTE: The top cover must be closed to rotate the cartridges.

12. When the cartridges have been replaced, close the scanner assembly.



Replace the imaging drum

1. Lift the scanner assembly.



2. Open the top cover.

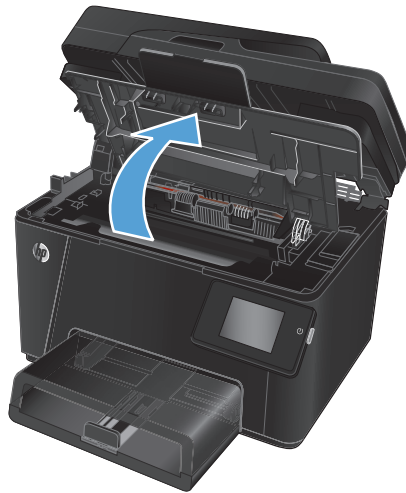

3. Remove the dust cover from the tray.

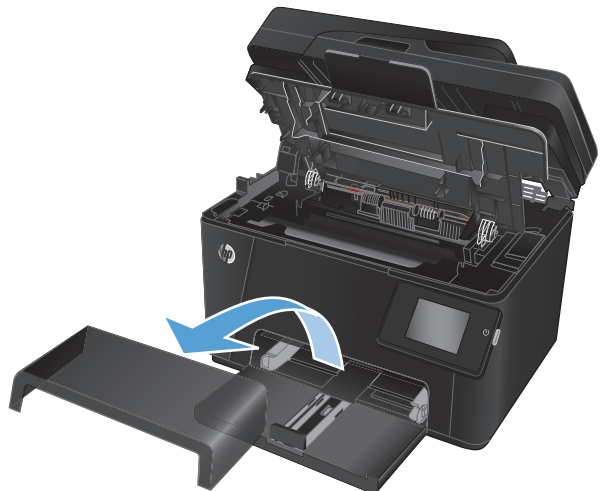

4. Open the front cover.



5. Lift the two levers that hold the imaging drum.



6. Remove the old imaging drum.



7. Remove the new imaging drum from the bag. Place the used imaging drum in the bag for recycling.

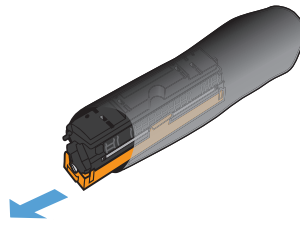

8. Remove the protective shielding from the new imaging drum.

CAUTION: To prevent damage, do not expose the imaging drum to light. Cover it with a piece of paper.

Do not touch the green roller. Fingerprints on the imaging drum can cause print-quality problems.

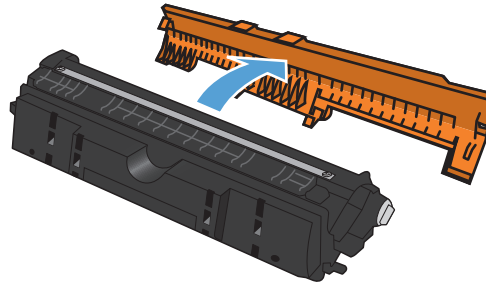

9. Insert the new imaging drum in the product.



10. Lower the two levers that hold the imaging drum.



11. Close the front cover.



12. Reinstall the dust cover on the tray.

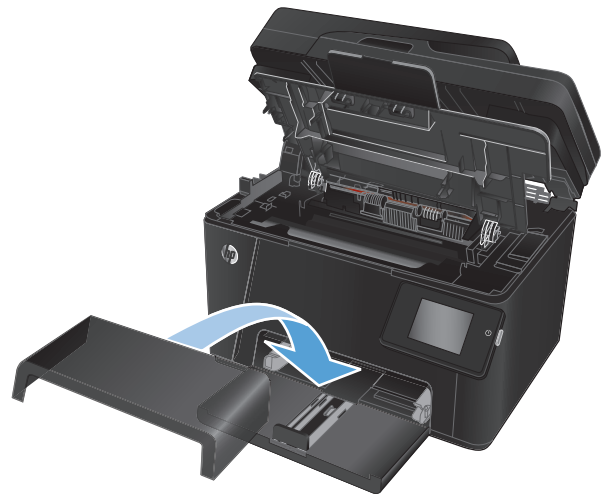

13. Close the top cover.

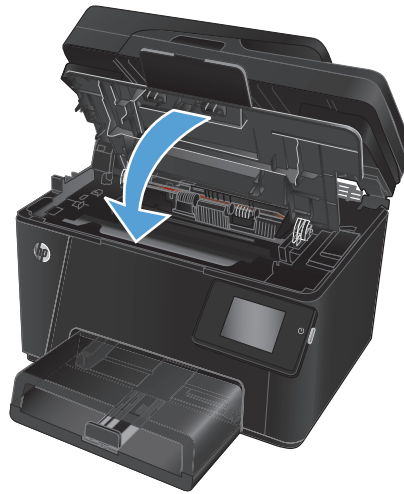

14. Close the scanner assembly.

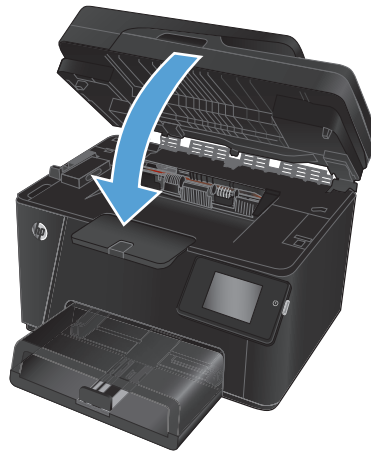

8 Solve problems

- [Control panel help system \(touchscreen models only\)](#)
- [Restore the factory-set defaults](#)
- [Solve paper feed or jam problems](#)
- [Clear jams from the input tray](#)
- [Clear jams in the output bin](#)
- [Clear jams in the document feeder](#)
- [Improve print quality](#)
- [Improve copy and scan quality](#)
- [Improve fax image quality](#)
- [Solve wired network problems](#)
- [Solve wireless network problems](#)
- [Solve fax problems](#)

Go to www.hp.com/support/ljMFPM176series or www.hp.com/support/ljMFPM177series for HP's all-inclusive help for your product:

- Solve problems.
- Download software updates.
- Join support forums.
- Find warranty and regulatory information.

You can also go to www.hp.com/support for Worldwide support and other HP products.

Control panel help system (touchscreen models only)

The product has a built-in Help system that explains how to use each screen. To open the Help system, touch the Help ? button in the upper-right corner of the screen.

For some screens, the Help opens to a global menu where you can search for specific topics. You can browse through the menu structure by touching the buttons in the menu.

Some Help screens include animations that guide you through procedures, such as clearing jams.

For screens that contain settings for individual jobs, the Help opens to a topic that explains the options for that screen.

If the product alerts you of an error or warning, touch the Help ? button to open a message that describes the problem. The message also contains instructions to help solve the problem.

Restore the factory-set defaults

Restoring the factory-set defaults returns all of the product and network settings to the factory defaults. It will not reset the page count, tray size, or language. To restore the product to the factory-default settings, follow these steps.

 **CAUTION:** Restoring the factory-set defaults returns all of the settings to the factory defaults, and it also deletes any pages that are stored in the memory.

1. On the product control panel, press or touch the Setup  button.
2. Open the **Service** menu.
3. Select the **Restore Defaults** option, and then press or touch the **OK** button.

The product automatically restarts.

Solve paper feed or jam problems

If the product has recurring problems with paper feeding or with jams, use the following information to reduce the number of occurrences.

The product does not pick up paper

If the product does not pick up paper from the tray, try these solutions.

1. Open the product and remove any jammed sheets of paper.
2. Load the tray with the correct size of paper for your job.
3. Make sure the paper size and type are set correctly on the product control panel.
4. Make sure the paper guides in the tray are adjusted correctly for the size of paper. Adjust the guides to the appropriate indentation in the tray.
5. Check the product control panel to see if the product is waiting for you to acknowledge a prompt to feed the paper manually. Load paper, and continue.
6. The rollers above the tray might be contaminated. Clean the rollers with a lint-free cloth dampened with warm water.

The product picks up multiple sheets of paper

If the product picks up multiple sheets of paper from the tray, try these solutions.

1. Remove the stack of paper from the tray and flex it, rotate it 180 degrees, and flip it over. *Do not fan the paper.* Return the stack of paper to the tray.
2. Use only paper that meets HP specifications for this product.
3. Use paper that is not wrinkled, folded, or damaged. If necessary, use paper from a different package.
4. Make sure the tray is not overfilled. If it is, remove the entire stack of paper from the tray, straighten the stack, and then return some of the paper to the tray.
5. Make sure the paper guides in the tray are adjusted correctly for the size of paper. Adjust the guides to the appropriate indentation in the tray.
6. Make sure the printing environment is within recommended specifications.

Frequent or recurring paper jams

Follow these steps to solve problems with frequent paper jams. If the first step does not resolve the problem continue with the next step until you have resolved the problem.

1. If paper has jammed in the product, clear the jam and then print a configuration page to test the product.
2. Check that the tray is configured for the correct paper size and type on the product control panel. Adjust paper settings if necessary.
3. Turn the product off, wait 30 seconds, and then turn it on again.
4. Print a cleaning page to remove excess toner from inside the product.

- a. From the Home screen on the product control panel, touch the Setup  button.
- b. Touch the [Service](#) menu.
- c. Touch the [Cleaning Page](#) button.
- d. Load plain letter or A4 paper when you are prompted.
- e. Touch the [OK](#) button to begin the cleaning process.

The product prints the first side and then prompts you to remove the page from the output bin and reload it in Tray 1, keeping the same orientation. Wait until the process is complete. Discard the page that prints.

5. Print a configuration page to test the product.
 - a. From the Home screen on the product control panel, touch the Setup  button.
 - b. Touch the [Reports](#) menu.
 - c. Touch the [Configuration Report](#) button.

If none of these steps resolves the problem, the product might need service. Contact HP customer support.

Prevent paper jams

To reduce the number of paper jams, try these solutions.

1. Use only paper that meets HP specifications for this product.
2. Use paper that is not wrinkled, folded, or damaged. If necessary, use paper from a different package.
3. Use paper that has not previously been printed or copied on.
4. Make sure the tray is not overfilled. If it is, remove the entire stack of paper from the tray, straighten the stack, and then return some of the paper to the tray.
5. Make sure the paper guides in the tray are adjusted correctly for the size of paper. Adjust the guides so they are touching the paper stack without bending it.
6. Make sure that the tray is fully inserted in the product.
7. If you are printing on heavy, embossed, or perforated paper, use the manual feed feature and feed sheets one at a time.
8. Verify that the tray is configured correctly for the paper type and size.
9. Make sure the printing environment is within recommended specifications.

Clear jams from the input tray

A **Jam in tray 1. Clear Jam and press [OK]** message displays on the product control panel.

1. Remove the dust cover from the tray.



2. Remove the stack of paper from the input tray.



3. Remove any jammed paper visible in the input tray area. Use both hands to remove jammed paper to avoid tearing the paper.



4. Reload paper in the input tray. Make sure that the paper fits under the tabs and below the maximum-height indicators.



5. Reinstall the dust cover on the tray.



Clear jams in the output bin

A **Jam in output bin** message displays on the product control panel.

1. If paper is visible in the output bin, grasp the leading edge with both hands and slowly remove it.



2. Open the rear door to check for jammed paper.



3. Remove any jammed paper. Use both hands to pull out the paper to avoid tearing.



4. Close the rear door.



Clear jams in the document feeder

A **Jam in the document feeder** message displays on the product control panel.

1. If paper is visible in the document feeder, grasp the leading edge with both hands and slowly remove it.



2. Lift the document feeder input tray.



3. Lift the jam-access cover.



4. Remove any jammed paper. Use both hands to pull out the paper to avoid tearing.



5. Close the jam-access cover.



6. Close the document-feeder input tray.



Improve print quality

- [Print from a different software program](#)
- [Set the paper-type setting for the print job](#)
- [Check the toner-cartridge status](#)
- [Calibrate the product to align the colors](#)
- [Print a cleaning page](#)
- [Perform additional print quality troubleshooting](#)
- [Inspect the toner cartridge for damage](#)
- [Check the paper and printing environment](#)
- [Check the EconoMode settings](#)
- [Adjust color settings \(Windows\)](#)

Print from a different software program

Try printing from a different software program. If the page prints correctly, the problem is with the software program from which you were printing.

Set the paper-type setting for the print job

Check the paper-type setting if you are printing from a software program and the pages have any of these problems:

- smeared print
- fuzzy print
- dark print
- curled paper
- scattered dots of toner
- loose toner
- small areas of missing toner

Check the paper-type setting (Windows)

1. From the software program, select the **Print** option.
2. Select the product, and then click the **Properties** or **Preferences** button.
3. Click the **Paper/Quality** tab.
4. From the **Media:** drop-down list, select the correct paper type.
5. Click the **OK** button to close the **Document Properties** dialog box. In the **Print** dialog box, click the **OK** button to print the job.

Check the paper-type setting (Mac OS X)

1. Click the **File** menu, and then click the **Print** option.
2. In the **Printer** menu, select the product.
3. By default, the print driver displays the **Copies & Pages** menu. Open the menus drop-down list, and then click the **Finishing** menu.
4. Select a type from the **Media-type** drop-down list.
5. Click the **Print** button.

Check the toner-cartridge status

Check the supplies status page for the following information:

- Estimated percentage of cartridge life remaining
- Approximate pages remaining
- Part numbers for HP toner cartridges
- Number of pages printed

Use the following procedures to print the supplies status page:

LCD control panel

1. On the product control panel, press the Setup  button.
2. Open the following menus:
 - **Reports**
 - **Supplies status**
3. Select **Print Supplies status page**, and then press the **OK** button.

Touchscreen control panel

1. From the Home screen on the product control panel, touch the Supplies  button.
2. Touch the **Report** button to print the supplies status page.

Calibrate the product to align the colors

If the printed output has colored shadows, blurry graphics, or areas that have poor color, you might need to calibrate the product to align the colors. Print the diagnostics page from the [Reports](#) menu on the control panel to check the color alignment. If the blocks of color on that page are not aligned with each other, you need to calibrate the product.

LCD control panel

1. On the product control panel, press the Setup  button.
2. Open the following menus:
 - **System Setup**
 - **Print Quality**
 - **Calibrate Color**
3. Select the **Calibrate Now** option, and then press the **OK** button.

Touchscreen control panel

1. From the Home screen on the product control panel, touch the Setup  button.
2. Open the following menus:
 - [System Setup](#)
 - [Print Quality](#)
 - [Color Calibration](#)
3. Select the [Calibrate now](#) option, and then press the **OK** button.

Print a cleaning page

LCD control panel

1. From the product control panel, press the Setup  button.
2. Open the **Service** menu.
3. Select the **Cleaning mode** option, and then press the **OK** button.

The product prints the first side and then prompts you to remove the page from the output bin and reload it in Tray 1, keeping the same orientation. Wait until the process is complete. Discard the page that prints.

Touchscreen control panel

1. From the Home screen on the product control panel, touch the Setup  button.
2. Touch the [Service](#) menu.
3. Touch the [Cleaning Page](#) button.

4. Load plain letter or A4 paper when you are prompted.
5. Touch the **OK** button to begin the cleaning process.

The product prints the first side and then prompts you to remove the page from the output bin and reload it in Tray 1, keeping the same orientation. Wait until the process is complete. Discard the page that prints.

Perform additional print quality troubleshooting

Print the print quality page

LCD control panel

1. From the product control panel, press the Setup  button.
2. Open the following menus:
 - **System Setup**
 - **Reports**
3. Select the **Print Quality Report** option, and then press the **OK** button.

Touchscreen control panel

1. From the Home screen on the product control panel, touch the Setup  button.
2. Open the **Reports** menu.
3. Touch the **Print Quality Page** option, and then touch the **OK** button.

Interpret the print quality page

This page contains five bands of color, which are divided into four groups as indicated in the following illustration. By examining each group, you can isolate the problem to a particular toner cartridge.

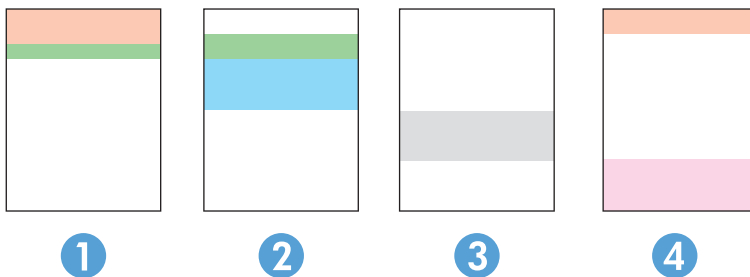

Section	Toner cartridge
1	Yellow
2	Cyan
3	Black
4	Magenta

- If dots or streaks appear in only one of the groups, replace the toner cartridge that correlates with that group.
- If dots appear in more than one group, print a cleaning page. If this does not solve the problem, determine if the dots are always the same color; for example, if magenta dots appear in all five color bands. If the dots are all the same color, replace that toner cartridge.
- If streaks appear in multiple color bands, contact HP. A component other than the toner cartridge is probably causing the problem.

Inspect the toner cartridge for damage

1. Remove the toner cartridges from the product, and verify that the sealing tape has been removed.
2. Grasp both sides of the toner cartridge and distribute the toner by gently rocking the cartridge.
3. Check the memory chips for damage.
4. Examine the surface of the roller on the toner cartridges.

 **CAUTION:** Do not touch the roller on the toner cartridges. Fingerprints on the roller can cause print-quality problems.

5. If you see any scratches, fingerprints, or other damage on the roller, replace the toner cartridge.
6. If the roller does not appear to be damaged, rock the toner cartridges gently several times and reinstall them. Print a few pages to see if the problem has resolved.

Check the paper and printing environment

Use paper that meets HP specifications

Use different paper if you are having any of the following problems:

- The printing is too light or seems faded in areas.
- Specks of toner are on the printed pages.
- Toner is smearing on the printed pages.
- Printed characters seem misformed.
- Printed pages are curled.

Always use a paper type and weight that this product supports. In addition, follow these guidelines when selecting paper:

- Use paper that is of good quality and free of cuts, nicks, tears, spots, loose particles, dust, wrinkles, voids, staples, and curled or bent edges.
- Use paper that has not been previously printed on.
- Use paper that is designed for use in laser printers. Do not use paper that is designed only for use in inkjet printers.
- Use paper that is not too rough. Using smoother paper generally results in better print quality.

Check the product environment

Verify that the product is operating within the environmental specifications listed in the product Warranty and Legal Guide.

Check the EconoMode settings

HP does not recommend the full-time use of EconoMode. If EconoMode is used full-time, the toner supply might outlast the mechanical parts in the toner cartridge. If print quality begins to degrade and is no longer acceptable, consider replacing the toner cartridge.

Follow these steps if the entire page is too dark or too light.

1. From the software program, select the **Print** option.
2. Select the product, and then click the **Properties** or **Preferences** button.
3. Click the **Paper/Quality** tab, and then locate the **Quality Settings** area.
4. If the entire page is too dark, select the **EconoMode** setting.

If the entire page is too light, make sure you are using the correct setting for the print job.

- If you are printing photos, select the **Photo** option.
 - For all other print jobs, select the **Normal** option.
5. Click the **OK** button to close the **Document Properties** dialog box. In the **Print** dialog box, click the **OK** button to print the job.

Adjust color settings (Windows)

Change the color theme

1. From the software program, select the **Print** option.
2. Select the product, and then click the **Properties** or **Preferences** button.
3. Click the **Advanced** button.
4. Select a color theme from the **Color Themes** drop-down list.
 - **None:** No color theme is used.
 - **Default/sRGB:** This theme sets the product to print RGB data in raw device mode. When using this theme, manage color in the software program or in the operating system for correct rendering.
 - **Vivid/sRGB:** The product increases the color saturation in the midtones. Use this theme when printing business graphics.

- **Photo (sRGB):** The product interprets RGB color as if it were printed as a photograph using a digital mini lab. The product renders deeper, more saturated colors differently than with the Default (sRGB) theme. Use this theme when printing photos.
 - **Photo (Adobe RGB 1998):** Use this theme with printing digital photos that use the AdobeRGB color space rather than sRGB. Turn off color management in the software program when using this theme.
5. Click the **OK** button to close the **Advanced Options** dialog box, and then click the **OK** button to close the **Document Properties** dialog box. In the **Print** dialog box, click the **OK** button to print the job.

Change the color options

1. From the software program, select the **Print** option.
2. Select the product, and then click the **Properties** or **Preferences** button.
3. Click the **Paper/Quality** tab.
4. In the **Color** section, select **Black & White** or **Color**.



NOTE: When **Black & White** is selected, the **Print in Grayscale** setting in the **Advanced Options** is automatically changed to the **Black print cartridge only** option.

5. Click the **OK** button to close the **Document Properties** dialog box. In the **Print** dialog box, click the **OK** button to print the job.

Improve copy and scan quality

Check the scanner glass for dirt and smudges

Over time, specks of debris might collect on the scanner glass and white plastic backing, which can affect performance. Use the following procedure to clean the scanner.

1. Press the power button to turn the product off, and then disconnect the power cable from the electrical outlet.
2. Open the scanner lid.
3. Clean the scanner glass and the white plastic backing underneath the scanner lid with a soft cloth or sponge that has been moistened with nonabrasive glass cleaner.

 **CAUTION:** Do not use abrasives, acetone, benzene, ammonia, ethyl alcohol, or carbon tetrachloride on any part of the product; these can damage the product. Do not place liquids directly on the glass or platen. They might seep and damage the product.

4. Dry the glass and white plastic parts with a chamois or a cellulose sponge to prevent spotting.
5. Connect the power cable to an outlet, and then press the power button to turn the product on.

Check the paper settings

LCD control panel

1. On the product control panel, press the Setup  button.
2. Open the following menus:
 - **System Setup**
 - **Paper Setup**
3. Select the **Def. paper size** option.
4. Select the name of the paper size that is in Tray 1, and then press the **OK** button.
5. Select the **Def. paper type** option.
6. Select the name of the paper type that is in Tray 1, and then press the **OK** button.

Touchscreen control panel

1. From the Home screen on the product control panel, touch the Setup  button.
2. Open the following menus:
 - **System Setup**
 - **Paper Setup**
3. Select the **Paper Size** option, and then touch the name of the paper size that is in Tray 1.
4. Select the **Paper Type** option, and then touch the name of the paper type that is in Tray 1.

Check the image adjustment settings

The following image adjustment settings are available:

- **Lightness:** Adjusts the lightness/darkness setting.
- **Contrast:** Adjusts the contrast between the lightest and darkest areas of the image.
- **Sharpen:** Adjusts clarity of text characters.
- **Background Removal:** Adjusts the darkness of the background of the image. This is especially useful for original documents that are printed on colored paper.
- **Color Balance:** Adjusts the red, green, and blue color hues.

LCD control panel

1. On the product control panel, press the Copy Menu  button.
2. Select the **Image Adjustment** menu.
3. Use the arrow buttons to scroll through the options, select the setting you want to adjust.
4. Use the arrow buttons to adjust the value for the setting, and then press the **OK** button to select an option.
5. Adjust another setting, or press the **OK** button to return to the main copy menu.

Touchscreen control panel

1. From the Home screen, touch the **Copy** button.
2. Touch the **Settings** button, and then scroll to and touch the **Image Adjustment** option.
3. Touch the name of the setting you want to adjust.
4. Touch the **—** or **+** buttons to adjust the value for the setting, and then touch the **OK** button.
5. Adjust another setting, or touch the **Back**  button to return to the main copy menu.



Optimize for text or pictures

The following copy-quality settings are available:

- **Auto Select:** Use this setting when you are not concerned about the quality of the copy. This is the default setting.
- **Mixed:** Use this setting for documents that contain a mixture of text and graphics.
- **Text:** Use this setting for documents that contain mostly text.
- **Picture:** Use this setting for documents that contain mostly graphics.

LCD control panel

1. Load the document onto the scanner glass.
2. On the product control panel, press the Copy Menu  button.
3. Select the **Optimize** menu.

4. Use the arrow buttons to scroll through the options, and then press the **OK** button to select an option.
5. Press either the Black Start Copy  button or the Color Start Copy  button to start copying.

Touchscreen control panel

1. Load the document onto the scanner glass.
2. From the Home screen on the product control panel, touch the **Copy** button.
3. Touch the **Settings** button, and then scroll to and touch the **Optimize** button. Touch the arrow buttons to scroll through the options, and then touch an option to select it.
4. Touch the Back  button, and then touch the **Black** or **Color** button to start copying.

Edge-to-edge copying

The product cannot print fully edge-to-edge. There is a 4 mm (0.2 inch) unprintable border around the page.

Considerations for printing or scanning documents with cropped edges:

- When the original is smaller than the output size, move the original 4 mm (0.2 inch) away from the corner indicated by the icon on the scanner. Recopy or scan in this position.
- When the original is the size of the printed output that you want, use the **Reduce/Enlarge** feature to reduce the image so the copy is not cropped.

Clean the pickup rollers and separation pad in the document feeder

If the document feeder experiences paper-handling problems, such as jams or multiple-page feeds, clean the document-feeder rollers and separation pad.

1. Lift the document-feeder input tray.



2. Use a moist, lint-free cloth to wipe both pickup rollers and the separation pad to remove dirt.

CAUTION: Do not use abrasives, acetone, benzene, ammonia, ethyl alcohol, or carbon tetrachloride on any part of the product; these can damage the product. Do not place liquids directly on the glass or platen. They might seep and damage the product.

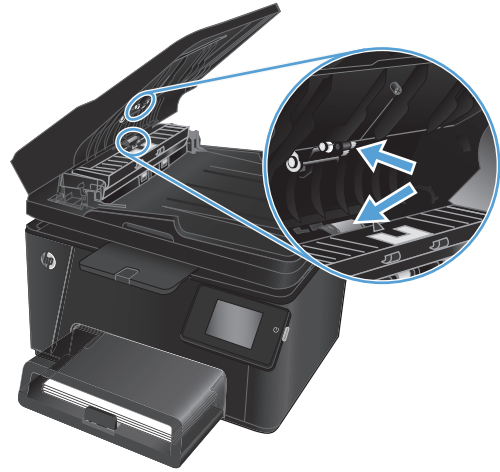

3. Close the document-feeder input tray.



Improve fax image quality

- [Check the scanner glass for dirt or smudges](#)
- [Check the send-fax resolution setting](#)
- [Check the lightness/darkness setting](#)
- [Check the Error Correction setting](#)
- [Check the Fit-to-Page setting](#)
- [Clean the pickup rollers and separation pad in the document feeder](#)
- [Send to a different fax machine](#)
- [Check the sender's fax machine](#)

Check the scanner glass for dirt or smudges

Over time, specks of debris might collect on the scanner glass and white plastic backing, which can affect performance. Use the following procedure to clean the scanner.

1. Press the power button to turn the product off, and then disconnect the power cable from the electrical outlet.
2. Open the scanner lid.
3. Clean the scanner glass, the document feeder strips, and the white plastic backing with a soft cloth or sponge that has been moistened with nonabrasive glass cleaner.

⚠ CAUTION: Do not use abrasives, acetone, benzene, ammonia, ethyl alcohol, or carbon tetrachloride on any part of the product; these can damage the product. Do not place liquids directly on the glass or platen. They might seep and damage the product.

4. Dry the glass and white plastic parts with a chamois or a cellulose sponge to prevent spotting.
5. Close the scanner lid.
6. Connect the power cable to an outlet, and then press the power button to turn the product on.

Check the send-fax resolution setting

1. From the Home screen on the product control panel, touch the Setup  button.
2. Select **Fax Setup**.
3. Select **Advanced Setup**, and then select **Fax Resolution**.
4. Select the desired resolution setting, and then touch **OK**.

Check the lightness/darkness setting

If the fax output is too light or too dark, check the lightness/darkness setting to make sure it is appropriate for the fax job.

1. From the Home screen on the product control panel, touch the Setup  button.
2. Select **Fax Setup**, and then select **Advanced Setup**.
3. Select **Lighter/Darker**, and then adjust the setting for your fax job.

Check the Error Correction setting

Usually, the product monitors the signals on the telephone line while it is sending or receiving a fax. If the product detects an error during the transmission and the error-correction setting is **On**, the product can request that the portion of the fax be resent. The factory-set default for error correction is **On**.

You should turn off error correction only if you are having trouble sending or receiving a fax, and you are willing to accept the errors in the transmission. Turning off the setting might be useful when you are trying to send a fax overseas or receive one from overseas, or if you are using a satellite telephone connection.

1. From the Home screen on the product control panel, touch the Setup  button.
2. Select **Service**, and then select **Fax Service**.
3. Select **Error Correction**, and then select **On**.

Check the Fit-to-Page setting

If the product printed a fax job off the page, turn on the fit-to-page feature from the product control panel.

 **NOTE:** Make sure that the default paper size setting matches the size of the paper in the tray.

1. From the Home screen on the product control panel, touch the Setup  button.
2. Select **Fax Setup**, and then select **Advanced Setup**.
3. Select **Fit to Page**, and then select **On**.

Clean the pickup rollers and separation pad in the document feeder

If the document feeder experiences paper-handling problems, such as jams or multiple-page feeds, clean the document-feeder rollers and separation pad.

1. Lift the document-feeder input tray.



2. Use a moist, lint-free cloth to wipe both pickup rollers and the separation pad to remove dirt.

CAUTION: Do not use abrasives, acetone, benzene, ammonia, ethyl alcohol, or carbon tetrachloride on any part of the product; these can damage the product. Do not place liquids directly on the glass or platen. They might seep and damage the product.

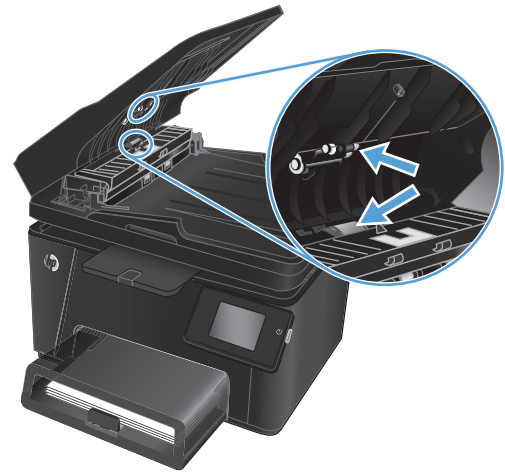

3. Close the document-feeder input tray.



Send to a different fax machine

Send the fax job to a different fax machine to see if another machine will successfully receive the fax job.

- If another fax machine receives the fax successfully, check the connection and settings on the original receiving fax machine.
- If another fax machine does not receive the fax successfully, check the fax settings on your product. If the fax is still unsuccessful, there might be interference on the phone line. Try to resend the fax later.

Check the sender's fax machine

Ask the sender to darken the contrast setting on the sending fax machine, and then resend the fax.

If the received fax quality is still poor, check the fax settings on your product.

Solve wired network problems

Check the following items to verify that the product is communicating with the network. Before beginning, print a configuration page from the product control panel and locate the product IP address that is listed on this page.

- [Poor physical connection](#)
- [The computer is using the incorrect IP address for the product](#)
- [The computer is unable to communicate with the product](#)
- [The product is using incorrect link and duplex settings for the network](#)
- [New software programs might be causing compatibility problems](#)
- [The computer or workstation might be set up incorrectly](#)
- [The product is disabled, or other network settings are incorrect](#)



NOTE: HP does not support peer-to-peer networking, as the feature is a function of Microsoft operating systems and not of the HP print drivers. For more information, go to Microsoft at www.microsoft.com.

Poor physical connection

1. Verify that the product is attached to the correct network port using a cable of the correct length.
2. Verify that cable connections are secure.
3. Look at the network port connection on the back of the product, and verify that the amber activity light and the green link-status light are lit.
4. If the problem continues, try a different cable or port on the hub.

The computer is using the incorrect IP address for the product

1. Open the printer properties and click the **Ports** tab. Verify that the current IP address for the product is selected. The product IP address is listed on the product configuration page.
2. If you installed the product using the HP standard TCP/IP port, select the box labeled **Always print to this printer, even if its IP address changes**.
3. If you installed the product using a Microsoft standard TCP/IP port, use the hostname instead of the IP address.
4. If the IP address is correct, delete the product and then add it again.

The computer is unable to communicate with the product

1. Test network communication by pinging the network.

- a. Open a command-line prompt on your computer. For Windows, click **Start**, click **Run**, type `cmd`, and then press **Enter**.
 - b. Type `ping` followed by the IP address for your product.

For Mac OS X, open the Network Utility, and then supply the IP address in the correct field in the **Ping** pane.
 - c. If the window displays round-trip times, the network is working.
2. If the ping command failed, verify that the network hubs are on, and then verify that the network settings, the product, and the computer are all configured for the same network.

The product is using incorrect link and duplex settings for the network

Hewlett-Packard recommends leaving these settings in automatic mode (the default setting). If you change these settings, you must also change them for your network.

New software programs might be causing compatibility problems

Verify that any new software programs are correctly installed and that they use the correct print driver.

The computer or workstation might be set up incorrectly

1. Check the network drivers, print drivers, and the network redirection settings.
2. Verify that the operating system is configured correctly.

The product is disabled, or other network settings are incorrect

1. Review the configuration page to check the status of the network protocol. Enable it if necessary.
2. Reconfigure the network settings if necessary.

Solve wireless network problems

- [Wireless connectivity checklist](#)
- [The product does not print after the wireless configuration completes](#)
- [The product does not print, and the computer has a third-party firewall installed](#)
- [The wireless connection does not work after moving the wireless router or product](#)
- [Cannot connect more computers to the wireless product](#)
- [The wireless product loses communication when connected to a VPN](#)
- [The network does not appear in the wireless networks list](#)
- [The wireless network is not functioning](#)
- [Perform a wireless network diagnostic test](#)
- [Reduce interference on a wireless network](#)

Wireless connectivity checklist

- Verify that the network cable is not connected.
- Verify that the product and the wireless router are turned on and have power. Also make sure that the wireless radio in the product is turned on.
- Verify that the service set identifier (SSID) is correct. Print a configuration page to determine the SSID. If you are not sure the SSID is correct, run the wireless setup again.
- With secured networks, verify that the security information is correct. If the security information is incorrect, run the wireless setup again.
- If the wireless network is working correctly, try accessing other computers on the wireless network. If the network has Internet access, try connecting to the Internet over a wireless connection.
- Verify that the encryption method (AES or TKIP) is the same for the product as it is for the wireless access point (on networks using WPA security).
- Verify that the product is within the range of the wireless network. For most networks, the product must be within 30 m (100 ft) of the wireless access point (wireless router).
- Verify that obstacles do not block the wireless signal. Remove any large metal objects between the access point and the product. Make sure poles, walls, or support columns containing metal or concrete do not separate the product and wireless access point.
- Verify that the product is located away from electronic devices that might interfere with the wireless signal. Many devices can interfere with the wireless signal including motors, cordless phones, security system cameras, other wireless networks, and some Bluetooth devices.
- Verify that the print driver is installed on the computer.
- Verify that you have selected the correct printer port.
- Verify that the computer and product connect to the same wireless network.
- For Mac OS X, verify that the wireless router supports Bonjour.

The product does not print after the wireless configuration completes

1. Make sure that the product is turned on and in the ready state.
2. Turn off any third-party firewalls on your computer.
3. Make sure that the wireless network is working correctly.
4. Make sure that your computer is working correctly. If necessary, restart the computer.
5. Verify that you can open the product HP Embedded Web Server from a computer on the network.

The product does not print, and the computer has a third-party firewall installed

1. Update the firewall with the most recent update available from the manufacturer.
2. If programs request firewall access when you install the product or try to print, make sure you allow the programs to run.
3. Temporarily turn off the firewall, and then install the wireless product on the computer. Enable the firewall when you have completed the wireless installation.

The wireless connection does not work after moving the wireless router or product

1. Make sure that the router or product connects to the same network that your computer connects to.
2. Print a configuration page.
3. Compare the service set identifier (SSID) on the configuration page to the SSID in the printer configuration for the computer.
4. If the numbers are not the same, the devices are not connecting to the same network. Reconfigure the wireless setup for the product.

Cannot connect more computers to the wireless product

1. Make sure that the other computers are within the wireless range and that no obstacles block the signal. For most networks, the wireless range is within 30 m (100 ft) of the wireless access point.
2. Make sure that the product is turned on and in the ready state.
3. Turn off any third-party firewalls on your computer.
4. Make sure that the wireless network is working correctly.
5. Make sure that your computer is working correctly. If necessary, restart the computer.

The wireless product loses communication when connected to a VPN

- Typically, you cannot connect to a VPN and other networks at the same time.

The network does not appear in the wireless networks list

- Make sure the wireless router is turned on and has power.
- The network might be hidden. However, you can still connect to a hidden network.

The wireless network is not functioning

1. Make sure that the network cable is not connected.
2. To verify if the network has lost communication, try connecting other devices to the network.
3. Test network communication by pinging the network.
 - a. Open a command-line prompt on your computer. For Windows, click **Start**, click **Run**, type `cmd`, and then press **Enter**.
 - b. Type `ping` followed by the router IP address.

For Mac OS X, open the Network Utility, and then supply the IP address in the correct field in the **Ping** pane.
 - c. If the window displays round-trip times, the network is working.
4. Make sure that the router or product connects to the same network that the computer connects to.
 - a. Print a configuration page.
 - b. Compare the service set identifier (SSID) on the configuration report to the SSID in the printer configuration for the computer.
 - c. If the numbers are not the same, the devices are not connecting to the same network. Reconfigure the wireless setup for the product.

Perform a wireless network diagnostic test

From the product control panel, you can run a diagnostic test that provides information about the wireless network settings.

LCD control panel

1. On the product control panel, press the Setup  button.
2. Select **Network Setup**, and then select **Wireless Menu**.
3. Select **Network Test**, and then press the **OK** button. The product prints a test page that shows test results.

Touchscreen control panel

1. From the Home screen on the product control panel, touch the Setup  button.
2. Select **Network Setup**, and then select **Wireless Menu**.
3. Select **Run Network Test**. The product prints a test page that shows test results.

Reduce interference on a wireless network

The following tips can reduce interference in a wireless network:

- Keep the wireless devices away from large metal objects, such as filing cabinets, and other electromagnetic devices, such as microwaves and cordless telephones. These objects can disrupt radio signals.
- Keep the wireless devices away from large masonry structures and other building structures. These objects can absorb radio waves and lower signal strength.
- Position the wireless router in a central location in line of sight with the wireless products on the network.

Solve fax problems

- [Check the hardware setup](#)
- [Faxes are sending slowly](#)
- [Fax quality is poor](#)
- [Fax cuts off or prints on two pages](#)

Check the hardware setup

- Several possible fixes are available. After each recommended action, retry faxing to see if the problem is resolved.
 - For best results during fax problem solving, make sure the line from the product is connected directly to the wall phone port. Disconnect all other devices that are connected to the product.
1. Verify that the telephone cord is connected to the correct port on the back of the product.
 2. Check the phone line by using the fax test:

- a. From the Home screen on the product control panel, touch the Setup  button.
- b. Select **Service**, and then select **Fax Service**.
- c. Select **Run Fax Test**. The product prints a fax test report.

The report contains the following possible results:

- **Pass:** The report contains all of the current fax settings for review.
- **Fail:** The report indicates the nature of the error and contains suggestions for how to resolve the issue.

3. Verify that the product firmware is current:

- a. Go to www.hp.com/support.
- b. Click **Drivers & Software**, type your product number in the window, and then click **Search**. If necessary, click your model in a list of similar products.

The **Software & Driver Downloads** page opens.

- c. Select your operating system from the drop-down menu, and then click **Next**.
- d. Click the plus sign next to **Firmware**, and then click **HP LaserJet Firmware Update Utility**.
- e. Click **Download**.
- f. When the download is complete, follow the on-screen instructions to install and run the utility.

The utility checks for firmware updates for your HP product. If updates are found, the utility installs the available update.

- g. When firmware updates are complete, try to resend the fax.

4. Verify that the fax was set up when the product software was installed.

From the computer, in the HP program folder, run the Fax Setup Utility.

5. Verify that the telephone service supports analog fax.

 **NOTE:** HP products are designed specifically for use with analog phone services.

- If using ISDN or digital PBX, contact your service provider for information about configuring to an analog fax line.
 - If using a VoIP service, change the **Fax Speed** to **Slow(V.29)** from the control panel. Ask if your service provider supports fax and for the recommended fax modem speed. Some companies might require an adapter.
 - If you are using a DSL service, make sure that a filter is included on the phone-line connection to the product. Contact the DSL service provider, or purchase a DSL filter if you do not have one. If a DSL filter is installed, try another filter because filters can be defective.
6. If the error persists, find more detailed problem-solving solutions in the sections that follow this one.

Faxes are sending slowly

The product is experiencing poor phone line quality.

- Retry sending the fax when the line conditions have improved.
- Check with the phone service provider that the line supports fax.
- Use white paper for the original. Do not use colors such as gray, yellow, or pink.
- Divide large fax jobs into smaller sections, and then fax them individually.
- Turn off the **Error Correction** setting:
 1. From the Home screen on the product control panel, touch the Setup  button.
 2. Select **Service**, and then select **Fax Service**.
 3. Select **Error Correction**, and then select **Off**.

 **NOTE:** Turning off Error Correction can reduce image quality.

- Increase the **Fax Speed** setting:
 1. From the Home screen on the product control panel, touch the Setup  button.
 2. Select **Fax Setup**, and then select **Advanced Setup**.
 3. Select **Fax Speed**, and then select the correct setting.
- Change the fax settings on the control panel to a lower resolution:

 **NOTE:** Higher resolution faxes can take longer to send than lower resolution faxes.

1. From the Home screen on the product control panel, touch the Setup  button.
2. Select **Fax Setup**, and then select **Advanced Setup**.
3. Select **Fax Resolution**, and then select the correct setting.

Fax quality is poor

Fax is blurry or light.



- Increase fax resolution when sending faxes. Resolution does not affect received faxes.
 1. From the Home screen on the product control panel, touch the Setup  button.
 2. Select **Fax Setup**, and then select **Advanced Setup**.
 3. Select **Fax Resolution**, and then select the correct setting.



NOTE: Increasing resolution slows transmission speed.

- Turn on the **Error Correction** setting from the control panel.
 1. From the Home screen on the product control panel, touch the Setup  button.
 2. Select **Service**, and then select **Fax Service**.
 3. Select **Error Correction**, and then select **On**.
- Check the toner cartridges and replace a cartridge if necessary.
- Ask the sender to darken the contrast setting on the sending fax machine, and then resend the fax.

Fax cuts off or prints on two pages

- Set the **Default Paper Size** setting. Faxes print on a single size of paper based on the **Default Paper Size** settings.
 1. From the Home screen on the product control panel, touch the Setup  button.
 2. Select **System Setup**, and then select **Paper Setup**.
 3. Select **Paper Size**, and then select the correct setting.
- Set the paper type and size for the tray used for faxes.
- Turn on the **Fit to Page** setting to print longer length faxes on letter or A4 size paper.
 1. From the Home screen on the product control panel, touch the Setup  button.
 2. Select **Fax Setup**, and then select **Advanced Setup**.
 3. Select **Fit to Page**, and then select **On**.



NOTE: If the **Fit to Page** setting is off and the **Default Paper Size** setting is set to Letter, a Legal-size original prints on two pages.

9 Parts, supplies, and accessories

- [Order parts, accessories, and supplies](#)
- [Customer self-repair parts](#)
- [Accessories](#)

Go to www.hp.com/support/ljMFPM176series or www.hp.com/support/ljMFPM177series for HP's all-inclusive help for your product:

- Solve problems.
- Download software updates.
- Join support forums.
- Find warranty and regulatory information.

You can also go to www.hp.com/support for Worldwide support and other HP products.

Order parts, accessories, and supplies

HP original toner cartridges and paper

www.hp.com/go/suresupply

Order genuine HP parts or accessories

www.hp.com/buy/parts

Order through service or support providers

Contact an HP-authorized service or support provider.

Customer self-repair parts

The following customer self-repair parts are available for the product.

- Parts listed as **Mandatory** self-replacement are to be installed by customers, unless you are willing to pay HP service personnel to perform the repair. For these parts, on-site or return-to-depot support is not provided under the HP product warranty.
- Parts listed as **Optional** self-replacement can be installed by HP service personnel at your request for no additional charge during the product warranty period.

Item	Description	Self-replacement options	Part number
HP 130A Black LaserJet Toner Cartridge	Replacement black toner cartridge	Mandatory	CF350A
HP 130A Cyan LaserJet Toner Cartridge	Replacement cyan toner cartridge	Mandatory	CF351A
HP 130A Magenta LaserJet Toner Cartridge	Replacement magenta toner cartridge	Mandatory	CF352A
HP 130A Yellow LaserJet Toner Cartridge	Replacement yellow toner cartridge	Mandatory	CF353A
Imaging Drum	Replacement imaging drum	Mandatory	CE314A
Pickup roller kit	Replacement pickup roller for the input tray	Mandatory	CF547-65001
Separation pad kit	Replacement separation pad for the input tray	Mandatory	CF547-65010
Paper pickup tray	Replacement input tray	Mandatory	CF547-65011
Paper delivery tray	Replacement output tray	Mandatory	CF547-65012
Dust cover	Replacement dust cover for input tray	Mandatory	CF547-65013

Accessories

Item

Description

Part number

USB cable

2-meter standard USB-compatible device connector

C6518A

Index

A

- accessories
 - ordering 106
 - part numbers 106
- AirPrint 31
- applications
 - downloading 51
- Apps menu 51

B

- bins, output
 - locating 4

C

- cartridge
 - replacing 62
- checklist
 - wireless connectivity 98
- cleaning
 - glass 89
 - paper path 84
- color alignment, calibrating 84
- color options
 - changing, Windows 87
- color theme
 - changing, Windows 87
- control panel
 - help 72
 - Home screen 8
 - LCD buttons and lights 6

- locating 4
- touchscreen buttons and lights 7
- copy quality
 - improving 89
- copying
 - edges of documents 91
 - multiple copies 34
 - optimizing for text or pictures 90
 - quality, adjusting 36
 - setting paper size and type 89
 - single copies 34
 - two-sided documents 35
- covers, locating 4
- customer self-repair
 - part numbers 106

D

- defaults, restoring 73
- document feeder 35
 - copying two-sided documents 35
- double-sided copying 35
- double-sided printing
 - Mac 27
 - Windows 20
- drivers
 - paper types 13
- drum
 - replacing 66
- duplex 35
- duplex printing
 - Mac 27
- duplex printing (double-sided)
 - Windows 20
- duplexing
 - manually (Mac) 27
 - manually (Windows) 20

E

- EconoMode setting 58, 87
- economy settings 58
- Embedded Web Server
 - changing password 56
 - opening 56

F

- factory-set defaults, restoring 73
- fax troubleshooting
 - hardware setup 102

G

- glass, cleaning 89

H

- hardware setup
 - fax troubleshooting 102
- help, control panel 72
- Home screen, control panel 8
- HP Device Toolbox, using 52
- HP Embedded Web Server
 - changing password 56
 - opening 56
- HP ePrint 30
- HP ePrint software 30
- HP Scan software (Mac) 39
- HP Scan software (Windows) 38
- HP Utility 54
- HP Utility for Mac
 - Bonjour 54
 - features 54
- HP Utility, Mac 54
- HP Web Services
 - applications 51
 - enabling 51
- HP Wireless Direct Printing 32

I

- imaging drum
 - replacing 66
- input tray
 - loading 15
- interface ports
 - locating 5

J

- jams
 - causes of 75

L

- labels
 - printing (Windows) 25
- loading
 - input tray 15
- lock
 - product 57

M

- Macintosh
 - HP Utility 54
- maintenance kits
 - part numbers 106

- manual duplex
 - Mac 27
 - Windows 20
- memory
 - included 2
- multiple pages per sheet
 - printing (Mac) 28
 - printing (Windows) 22
- N**
- network
 - password, changing 56
 - password, setting 56
- network installation 50
- networks
 - installing the product 50
 - models supporting 2
- number of copies, changing 34
- O**
- on/off button, locating 4
- online help, control panel 72
- ordering
 - supplies and accessories 106
- output bin
 - locating 4
- P**
- pages per minute 2
- pages per sheet
 - selecting (Mac) 28
 - selecting (Windows) 22
- paper
 - jams 75
 - ordering 106
 - selecting 86
 - supported sizes 12
 - supported types 13
- paper pickup problems
 - solving 74
- paper type
 - selecting (Windows) 25
- paper types
 - selecting (Mac) 28
- part numbers
 - customer self-repair 106
 - maintenance kits 106
 - supplies 106
- ports
 - locating 5

- power connection
 - locating 5
- power switch, locating 4
- print on both sides
 - Mac 27
 - manually, Windows 20
 - Windows 20
- print quality
 - improving 82
- print quality page
 - interpreting 85
 - printing 85
- R**
- replacing imaging drum 66
- replacing toner cartridge 62
- restoring factory-set defaults 73
- S**
- scan quality
 - improving 89
- scanner
 - glass cleaning 89
- scanning
 - from HP Scan software (Mac) 39
 - from HP Scan software (Windows) 38
- settings
 - factory-set defaults, restoring 73
- sleep delay
 - setting 58
- software
 - HP Utility 54
- special paper
 - printing (Windows) 25
- status
 - Home screen, control panel 8
 - HP Utility, Mac 54
- supplies
 - low threshold settings 60
 - ordering 106
 - part numbers 106
 - replacing imaging drum 66
 - replacing toner cartridge 62
 - status, viewing with HP Utility for Mac 54
 - using when low 60
- supplies status
 - checking 83

- supplies status page
 - printing 83
- supported paper sizes 12
- T**
- toner
 - amount remaining 83
- toner cartridge
 - checking for damage 86
 - low threshold settings 60
 - replacing 62
 - using when low 60
- transparencies
 - printing (Windows) 25
- Tray 1
 - orientation 16
- trays
 - included 2
 - locating 4
- troubleshooting
 - faxes 102
 - jams 75
 - network problems 96
 - paper feed problems 74
 - wired network 96
 - wireless network 98
- two-sided copying 35
- W**
- Web Services
 - applications 51
 - enabling 51
- wireless network
 - troubleshooting 98
- wireless network interference 100



CF548-90908



Free Manuals Download Website

<http://myh66.com>

<http://usermanuals.us>

<http://www.somanuals.com>

<http://www.4manuals.cc>

<http://www.manual-lib.com>

<http://www.404manual.com>

<http://www.luxmanual.com>

<http://aubethermostatmanual.com>

Golf course search by state

<http://golfingnear.com>

Email search by domain

<http://emailbydomain.com>

Auto manuals search

<http://auto.somanuals.com>

TV manuals search

<http://tv.somanuals.com>