



Color LaserJet Pro MFP M277

User Guide



www.hp.com/support/colorljMFPM277



HP Color LaserJet Pro MFP M277

User Guide

Copyright and License

© 2015 Copyright Hewlett-Packard Development Company, L.P.

Reproduction, adaptation, or translation without prior written permission is prohibited, except as allowed under the copyright laws.

The information contained herein is subject to change without notice.

The only warranties for HP products and services are set forth in the express warranty statements accompanying such products and services. Nothing herein should be construed as constituting an additional warranty. HP shall not be liable for technical or editorial errors or omissions contained herein.

Part number: B3Q10-90908

Edition 1, 4/2015

Trademark Credits

Adobe®, Adobe Photoshop®, Acrobat®, and PostScript® are trademarks of Adobe Systems Incorporated.

Apple and the Apple logo are trademarks of Apple Computer, Inc., registered in the U.S. and other countries. iPod is a trademark of Apple Computer, Inc. iPod is for legal or rightholder-authorized copying only. Don't steal music.

Microsoft®, Windows®, Windows® XP, and Windows Vista® are U.S. registered trademarks of Microsoft Corporation.

UNIX® is a registered trademark of The Open Group.

Table of contents

1 Product overview	1
Product views	2
Product front view	2
Product back view	3
Control-panel view	4
Home screen layout	5
How to use the touchscreen control panel	6
Product specifications	7
Introduction	7
Technical specifications	7
Supported operating systems	8
Mobile printing solutions	9
Product dimensions	11
Power consumption, electrical specifications, and acoustic emissions	12
Operating-environment range	12
Product hardware setup and software installation	13
2 Paper trays	15
Load paper into the single-sheet slot (Tray 1)	16
Introduction	16
Load paper into the single-sheet priority feed slot	16
Load an envelope in the single-sheet priority feed slot (Tray 1)	17
Tray 1 paper orientation	19
Load paper into Tray 2	20
Introduction	20
Load paper into Tray 2	20
Load envelopes in Tray 2	22
Tray 2 paper orientation	25
3 Supplies, accessories, and parts	27
Order supplies, accessories, and parts	28

Ordering	28
Supplies and accessories	28
Customer self-repair parts	28
Replace the toner cartridges	30
Introduction	30
Remove and replace the toner cartridges	31
4 Print	37
Print tasks (Windows)	38
How to print (Windows)	38
Automatically print on both sides (Windows)	39
Manually print on both sides (Windows)	39
Print multiple pages per sheet (Windows)	40
Select the paper type (Windows)	40
Print tasks (OS X)	41
How to print (OS X)	41
Automatically print on both sides (OS X)	41
Manually print on both sides (OS X)	41
Print multiple pages per sheet (OS X)	41
Select the paper type (OS X)	42
Mobile printing	43
Introduction	43
Wi-Fi Direct and NFC Printing (wireless models only)	43
HP ePrint via email	44
HP ePrint software	44
AirPrint	45
Android embedded printing	45
Use walk-up USB printing	46
5 Copy	47
Make a copy	48
Copy on both sides (duplex)	49
Copy on both sides automatically	49
Copy on both sides manually	49
6 Scan	51
Scan by using the HP Scan software (Windows)	52
Scan by using the HP Scan software (OS X)	53
Scan to a USB flash drive	54
Set up Scan to Network Folder	55

Introduction	55
Use the Scan to Network Folder Wizard (Windows)	55
Set up the Scan to Network Folder feature via the HP Embedded Web Server (Windows)	55
Set up the Scan to Network Folder feature on a Mac	56
Scan to a network folder	58
Set up Scan to E-mail	59
Introduction	59
Use the Scan to E-Mail Wizard (Windows)	59
Set up the Scan to Email feature via the HP Embedded Web Server (Windows)	59
Set up the Scan to Email feature on a Mac	61
Scan to email	63
Additional scan tasks	64

7 Fax 65

Set up to send and receive faxes	66
Before starting	66
Step 1: Identify the phone connection type	66
Step 2: Set up the fax	67
Dedicated phone line	67
Shared voice/fax line	68
Shared voice/fax line with an answering machine	69
Step 3: Configure the fax time, date, and header	71
HP Fax Setup Wizard	71
Product control panel	71
HP Embedded Web Server (EWS) and HP Device Toolbox (Windows)	72
Step 4: Run a fax test	72
Send a fax	74
Supported fax applications	74
Send a fax by dialing manually from the product control panel	74
Fax from the flatbed scanner	74
Fax from the document feeder	75
Use speed dials and group-dial entries	75
Cancel a fax	76
Send a fax using the HP software (Windows)	77
Create, edit, and delete speed-dial entries	78
Use the control panel to create and edit the fax phone book	78
Use phone-book data from other programs	78
Delete phone book entries	78

8 Manage the product 79

Use HP Web Services applications	80
--	----

Change the product connection type (Windows)	81
Advanced configuration with HP Embedded Web Server (EWS) and HP Device Toolbox (Windows)	82
Advanced configuration with HP Utility for OS X	85
Open HP Utility	85
HP Utility features	85
Configure IP network settings	88
Introduction	88
Printer sharing disclaimer	88
View or change network settings	88
Rename the product on a network	88
Manually configure IPv4 TCP/IP parameters from the control panel	89
Product security features	90
Introduction	90
Assign or change the system password using the Embedded Web Server	90
Economy settings	91
Introduction	91
Print with EconoMode	91
Configure the Sleep/Auto Off After setting	91
Set the Shut Down After delay and configure the product to use 1 watt or less of power	91
Configure the Delay Shut Down setting	92
HP Web Jetadmin	93
Update the firmware	94
Method one: Update the firmware using the control panel	94
Method two: Update the firmware using the Firmware Update Utility	95
9 Solve problems	97
Customer support	98
Control panel help system	99
Restore the factory-set defaults	100
A “Cartridge is low” or “Cartridge is very low” message displays on the product control panel	101
Change the “Very Low” settings	101
For products with fax capability	101
Order supplies	102
Product does not pick up paper or misfeeds	103
Introduction	103
The product does not pick up paper	103
The product picks up multiple sheets of paper	103
The document feeder jams, skews, or picks up multiple sheets of paper	103
Clear paper jams	105
Introduction	105
Experiencing frequent or recurring paper jams?	105

Paper jam locations	106
Clear paper jams in the document feeder	107
Clear paper jams in the single-sheet slot (Tray 1)	109
Clear paper jams in Tray 2	111
Clear paper jams in the rear door and the fuser area	113
Clear paper jams in the output bin	115
Clear paper jams in the duplexer (duplex models only)	116
Improve print quality	117
Introduction	117
Print from a different software program	117
Check the paper-type setting for the print job	117
Check the paper type setting (Windows)	117
Check the paper type setting (OS X)	118
Check toner-cartridge status	118
Print and interpret the print quality page	119
Clean the product	119
Print a cleaning page	119
Check the scanner glass for dirt and smudges	120
Visually inspect the toner cartridge	120
Check paper and the printing environment	120
Step one: Use paper that meets HP specifications	120
Step two: Check the environment	121
Calibrate the product to align the colors	121
Check other print job settings	121
Check the EconoMode settings	122
Adjust color settings (Windows)	122
Try a different print driver	123
Improve copy and scan image quality	125
Introduction	125
Check the scanner glass for dirt and smudges	125
Eliminate lines or streaks when using the document feeder	126
Check the paper settings	126
Check the image adjustment settings	126
Optimize for text or pictures	127
Check the scanner resolution and color settings on the computer	127
Resolution and color guidelines	127
Color	128
Edge-to-edge copying	128
Clean the pickup rollers and separation pad in the document feeder	128
Improve fax image quality	130
Introduction	130

Check the scanner glass for dirt and smudges	130
Check the send-fax resolution settings	131
Check the error-correction settings	131
Check the fit-to-page setting	131
Clean the pickup rollers and separation pad in the document feeder	131
Send to a different fax machine	133
Check the sender's fax machine	133
Solve wired network problems	134
Introduction	134
Poor physical connection	134
The computer is using the incorrect IP address for the product	134
The computer is unable to communicate with the product	134
The product is using incorrect link and duplex settings for the network	135
New software programs might be causing compatibility problems	135
The computer or workstation might be set up incorrectly	135
The product is disabled, or other network settings are incorrect	135
Solve wireless network problems	136
Introduction	136
Wireless connectivity checklist	136
The product does not print after the wireless configuration completes	137
The product does not print, and the computer has a third-party firewall installed	137
The wireless connection does not work after moving the wireless router or product	137
Cannot connect more computers to the wireless product	137
The wireless product loses communication when connected to a VPN	138
The network does not appear in the wireless networks list	138
The wireless network is not functioning	138
Perform a wireless network diagnostic test	138
Reduce interference on a wireless network	138
Solve fax problems	140
Introduction	140
Fax troubleshooting checklist	140
Solve general fax problems	141
Faxes are sending slowly	141
Fax quality is poor	142
Fax cuts off or prints on two pages	143
Index	145

1 Product overview

- [Product views](#)
- [Product specifications](#)
- [Product hardware setup and software installation](#)

For more information:

Go to www.hp.com/support/colorljMFPM277.

HP's all-inclusive help for the product includes the following information:

- Install and configure
- Learn and use
- Solve problems
- Download software updates
- Join support forums
- Find warranty and regulatory information

Product views

- [Product front view](#)
- [Product back view](#)
- [Control-panel view](#)

Product front view

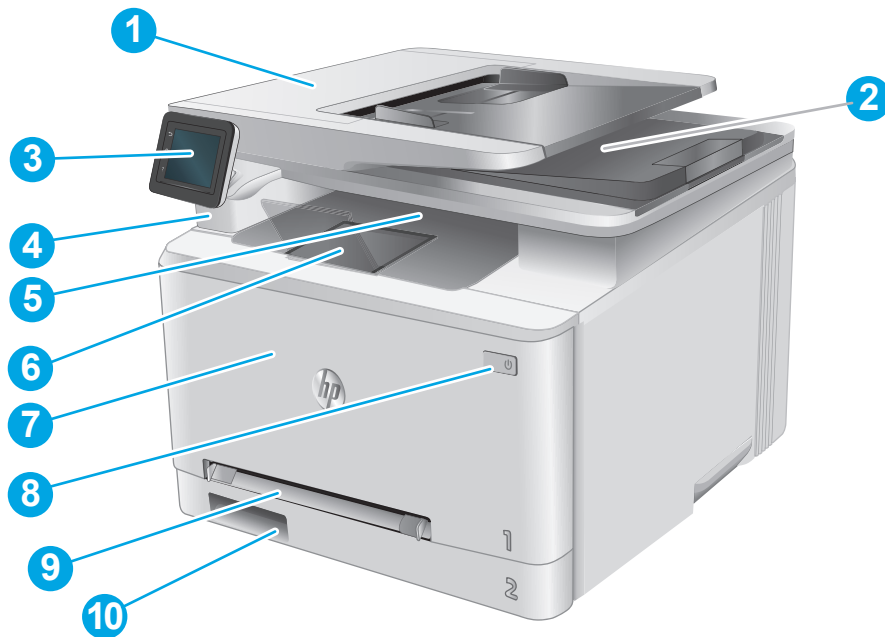

1	Document feeder
2	Scanner
3	Control panel (tilts up for easier viewing)
4	Walk-up USB port for printing and scanning without a computer
5	Output bin
6	Output bin extension
7	Front door (provides toner cartridge access)
8	Power on/off button
9	Single-sheet priority feed slot (Tray 1)
10	Main input tray (Tray 2)

Product back view

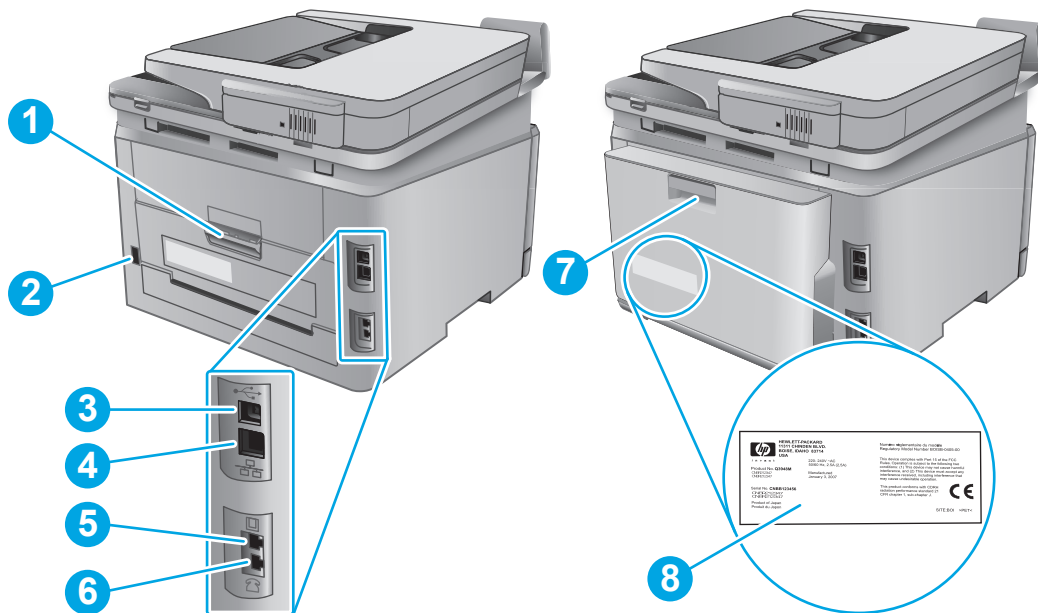

1	Rear door (provides access for clearing jams)
2	Power connection
3	USB port
4	Ethernet port
5	Fax line in port
6	Fax phone port
7	Duplexer (duplex models only)
8	Serial number and product number label

Control-panel view

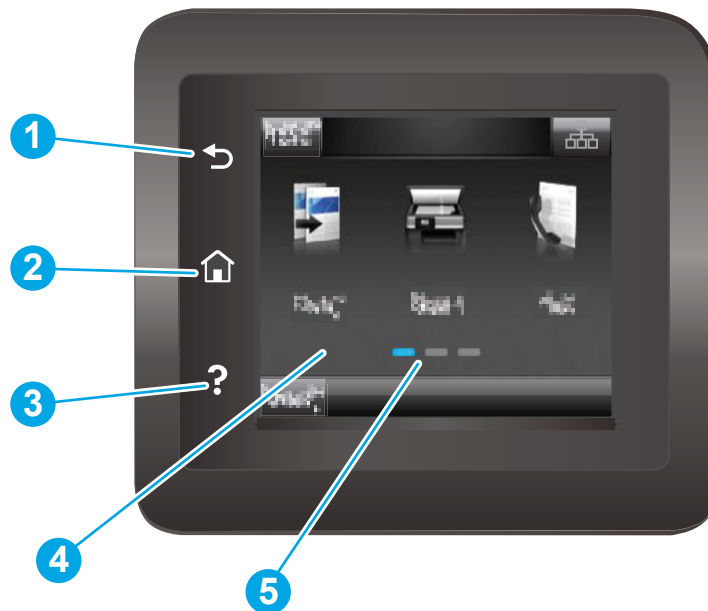

1	HP Back button	Returns to the previous screen
2	Home button	Provides access to the Home screen
3	Help button	Provides access to the control-panel help system
4	Color touchscreen	Provides access to menus, help animations, and product information.
5	Home page screen indicator	The display indicates which Home screen the control panel is currently displaying.











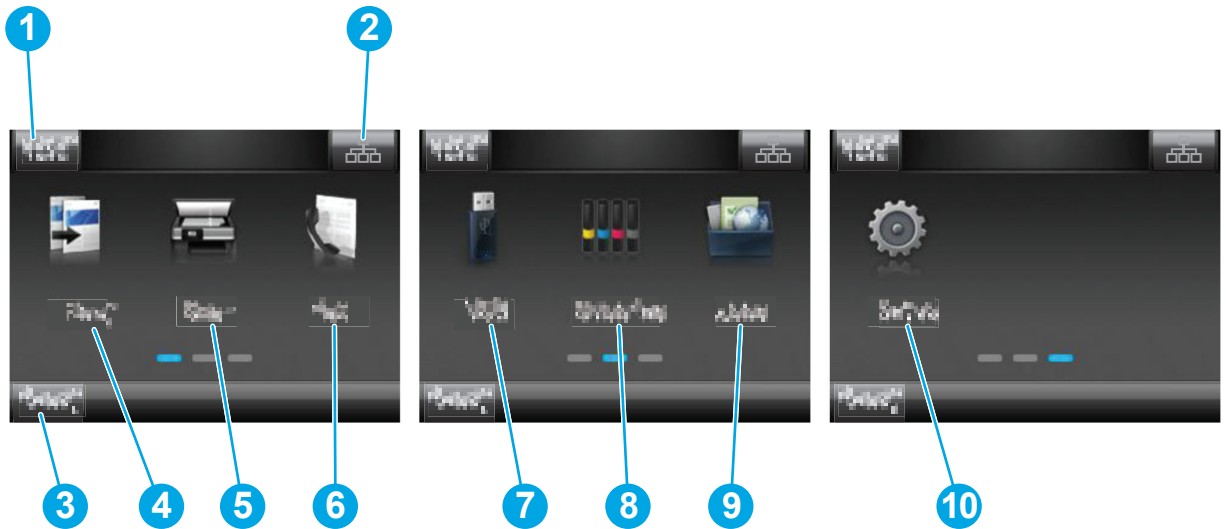

NOTE: While the control panel does not have a standard **Cancel** button, during many product processes a **Cancel** button appears on the touchscreen. This permits users to cancel a process before the product completes it.

Home screen layout

The Home screen provides access to the product features and indicates the current status of the product. Return to the Home screen at any time by touching the Home button on the product control panel.





 **NOTE:** The features that appear on the Home screen can vary, depending on the product configuration.

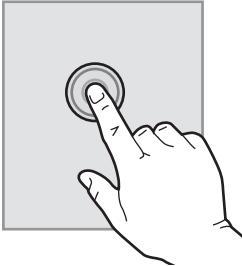

1	Reset button	Touch this button to reset any temporary job settings to the default product settings.
2	Connection Information button	Touch this button to open the Connection Information menu, which provides network information. The button appears as either a wired network icon  or a wireless network icon  , depending on the type of network to which the product is connected.
3	Product status	This screen area provides information about the overall product status.
4	Copy  button	Touch this button to open the copy feature.
5	Scan  button	Touch this button to open the scan features: <ul style="list-style-type: none"> • Scan to USB Drive • Scan to Network Folder • Scan to E-mail
6	Fax  button	Touch this button to open the fax features.
7	USB  button	Touch this button to open the USB Flash Drive menu.
8	Supplies  button	Touch this button to view information about supplies status.
9	Apps  button	Touch this button to open the Apps menu to print directly from select Web applications.
10	Setup  button	Touch this button to open the Setup menu.

How to use the touchscreen control panel

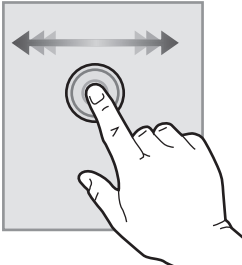
Use the following actions to use the product touchscreen control panel.

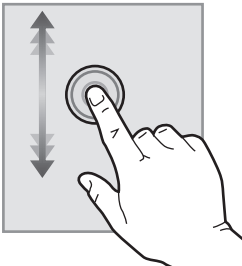
Action	Description	Example
Touch 	Touch an item on the screen to select that item or open that menu. Also, when scrolling through menus, briefly touch the screen to stop the scrolling.	Touch the Setup  button to open the Setup menu.
Swipe 	Touch the screen and then move the finger horizontally to scroll the screen sideways.	Swipe the Home screen to access the Setup  button.
Scroll 	Touch the screen, and then, without lifting the finger, move the finger vertically to move the screen.	Scroll through the Setup menu.

Product specifications

Introduction

 **IMPORTANT:** The following specifications are correct at the time of publication, but they are subject to change. For current information, see www.hp.com/support/colorljMFPM277.

- [Technical specifications](#)
- [Supported operating systems](#)
- [Mobile printing solutions](#)
- [Product dimensions](#)
- [Power consumption, electrical specifications, and acoustic emissions](#)
- [Operating-environment range](#)

Technical specifications

Model name		M277n	M277dw
Product number		B3Q10A	B3Q11A
Paper handling	Single-sheet priority feed slot (Tray 1)	✓	✓
	Tray 2 (150-sheet capacity)	✓	✓
	Automatic duplex printing	Not available	✓
Connectivity	10/100/1000 Ethernet LAN connection with IPv4 and IPv6	✓	✓
	Hi-Speed USB 2.0	✓	✓
	Print server for wireless network connectivity	Not available	✓
	Easy-access USB port	✓	✓
	HP near field communication (NFC) and Wi-Fi Direct for printing from mobile devices	Not available	✓
Control-panel display and input	Color touchscreen control panel	✓	✓
Print	Prints 18 pages per minute (ppm) on A4 and 19 ppm on letter-size paper	✓	✓
	Easy-access USB printing (no computer required)	✓	✓
Fax		✓	✓
Copy and Scan	Copies 19 pages per minute (ppm)	✓	✓
NOTE: Copy and scan speeds are subject to change. For the most current information, go to www.hp.com/support/colorljMFPM277 .	Scans 26 ppm		

Model name	M277n	M277dw
Product number	B3Q10A	B3Q11A
50-page document feeder	✓	✓
Scan to E-mail, Scan to USB, and Scan to Network Folder options	✓	✓

Supported operating systems

The following information applies to the product-specific Windows PCL 6 and OS X print drivers and to the in-box software installation CD.

Windows: The HP Software Installer CD installs the HP PCL.6 or HP PCL 6 driver depending on the Windows operating system along with optional software when using the full software installer.

Mac computers and OS X: Mac computers and Apple mobile devices are supported with this product. The OS X print driver and print utility are available for download from hp.com and may also be available via Apple Software Update. The HP installer software for OS X is not included in the in-box CD. Follow these steps to download the OS X installer software:

1. Go to www.hp.com/support/colorljMFPM277.
2. Select **Support Options**, and then under **Download Options** select **Drivers, Software & Firmware**.
3. Click the operating system version, and then click the **Download** button.

Operating system	Driver installed	Notes
Windows® XP SP3 or later, 32-bit	The HP PCL 6 product-specific print driver is installed for this operating system as part of the basic software installation. The basic installer installs the driver and scan application only.	The full software installation is not supported for this operating system. Use UPD drivers for 64-bit operating systems. Microsoft retired mainstream support for Windows XP in April 2009. HP will continue to provide best-effort support for the discontinued XP operating system.
Windows Vista®, 32-bit	The HP PCL 6 product-specific print driver is installed for this operating system as part of the basic software installation. The basic installer installs the driver only.	The full software installation is not supported for this operating system. Use UPD drivers for 64-bit operating systems.
Windows Server 2003 SP2 or later, 32-bit	The HP PCL 6 product-specific print driver is installed for this operating system as part of the basic software installation. The basic installer installs the driver only.	The full software installation is not supported for this operating system. Use UPD drivers for 64-bit operating systems. Microsoft retired mainstream support for Windows Server 2003 in July 2010. HP will continue to provide best-effort support for the discontinued Server 2003 operating system.
Windows 7 SP1 or later, 32-bit and 64-bit	The HP PCL 6 product-specific print driver is installed for this operating system as part of the full software installation.	

Operating system	Driver installed	Notes
Windows 8, 32-bit and 64-bit	The HP PCL 6 product-specific print driver is installed for this operating system as part of the full software installation.	Windows 8 RT support is provided through Microsoft IN OS Version 4, 32-bit driver.
Windows 8.1, 32-bit and 64-bit	The HP PCL 6 product-specific print driver is installed for this operating system as part of the full software installation.	Windows 8.1 RT support is provided through Microsoft IN OS Version 4, 32-bit driver.
Windows Server 2008 SP2, 32-bit	The HP PCL.6 product-specific print driver is installed for this operating system as part of the basic software installation.	
Windows Server 2008 SP2, 64-bit	The HP PCL.6 product-specific print driver is installed for this operating system as part of the basic software installation.	
Windows Server 2008 R2, SP 1, 64-bit	The HP PCL 6 product-specific print driver is installed for this operating system as part of the full software installation.	
Windows Server 2012, 64-bit	The software installer does not support Windows Server 2012 but the HP PCL 6 and HP PCL-6 version 4 product-specific print drivers do support it.	Download the driver from the HP Web site www.hp.com/support/colorljMFPM277 , and use the Windows Add Printer tool to install it.
Windows Server 2012 R2, 64 bit	The software installer does not support Windows Server 2012 but the HP PCL 6 and HP PCL-6 version 4 product-specific print drivers do support it.	Download the driver from the HP Web site www.hp.com/support/colorljMFPM277 , and use the Windows Add Printer tool to install it.
OS X 10.7 Lion, OS X 10.8 Mountain Lion, and OS X 10.9 Mavericks	The OS X print driver and print utility are available for download from hp.com and may also be available via Apple Software Update. The HP installer software for OS X is not included in the in-box CD.	For OS X, download the full installer from the support Web site for this product. <ol style="list-style-type: none"> Go to www.hp.com/support/colorljMFPM277. Select Support Options, and then under Download Options select Drivers, Software & Firmware. Click the operating system version, and then click the Download button.

 **NOTE:** For a current list of supported operating systems, go to www.hp.com/support/colorljMFPM277 for HP's all-inclusive help for the product.

 **NOTE:** For details on client and server operating systems and for HP UPD PCL6, UPD PCL 5, and UPD PS driver support for this product, go to www.hp.com/go/upd and click the **Specifications** tab.

Mobile printing solutions

The product supports the following software for mobile printing:

- HP ePrint software



NOTE: The HP ePrint Software supports the following operating systems: Windows Vista® (32-bit and 64-bit); Windows 7 SP 1 (32-bit and 64-bit); Windows 8 (32-bit and 64-bit); Windows 8.1 (32-bit and 64-bit); and OS X versions 10.6 Snow Leopard, 10.7 Lion, 10.8 Mountain Lion, and 10.9 Mavericks.

- HP ePrint via email (Requires HP Web Services to be enabled and the product to be registered with HP Connected)
- HP ePrint app (Available for Android, iOS, and Blackberry)
- ePrint Enterprise app (Supported on all products with ePrint Enterprise Server Software)
- HP All-in-One Remote app for iOS and Android devices
- Google Cloud Print
- AirPrint
- Android Printing

Product dimensions

Figure 1-1 Dimensions for the M277n models

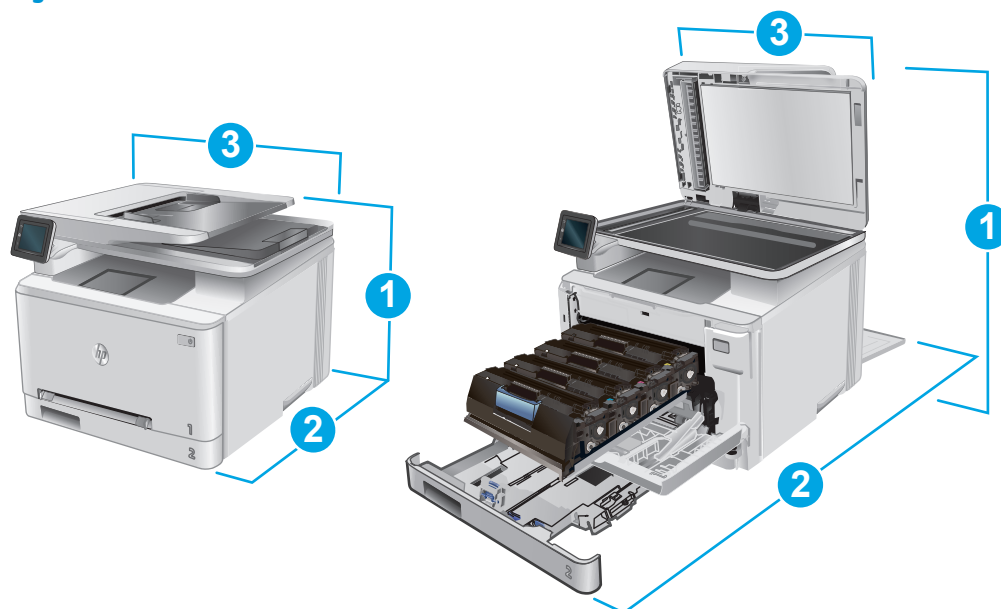

	Product fully closed	Product fully open
1. Height	322.2 mm (12.7 in)	578 mm (22.8 in)
2. Depth	384 mm (15.1 in)	849 mm (33.4 in)
3. Width	392 mm (15.4 in)	392 mm (15.4 in)
Weight (with cartridges)	17.4 kg (38.4 lb)	

Figure 1-2 Dimensions for the M277dw models

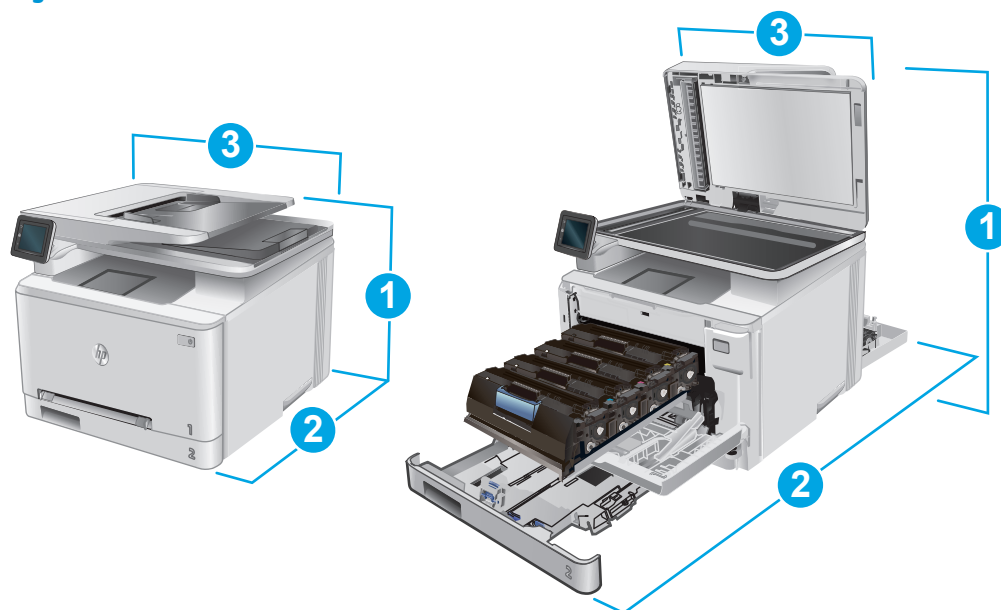

	Product fully closed	Product fully open
1. Height	322.2 mm (12.7 in)	578 mm (22.8 in)
2. Depth	417 mm (16.4 in)	1002 mm (39.4 in)
3. Width	392 mm (15.4 in)	392 mm (15.4 in)
Weight (with cartridges)	18.3 kg (40.3 lb)	

Power consumption, electrical specifications, and acoustic emissions

See www.hp.com/support/colorljMFPM277 for current information.

CAUTION: Power requirements are based on the country/region where the product is sold. Do not convert operating voltages. This will damage the product and void the product warranty.

Operating-environment range

Table 1-1 Operating-environment specifications

Environment	Recommended	Allowed
Temperature	17° to 27°C (62.6° to 80.6°F)	15° to 30°C (59° to 86°F)
Relative humidity	30% to 70% relative humidity (RH)	10% to 80% RH
Altitude	Not applicable	0 to 3048 m (0 to 10,000 ft)

Product hardware setup and software installation

For basic setup instructions, see the Hardware Installation Guide that came with the product. For additional instructions, go to HP support on the Web.

Go to www.hp.com/support/colorljMFPM277 for HP's all-inclusive help for the product. Find the following support:

- Install and configure
- Learn and use
- Solve problems
- Download software updates
- Join support forums
- Find warranty and regulatory information

2 Paper trays

- [Load paper into the single-sheet slot \(Tray 1\)](#)
- [Load paper into Tray 2](#)

For more information:

Go to www.hp.com/support/colorljMFPM277.

HP's all-inclusive help for the product includes the following information:

- Install and configure
- Learn and use
- Solve problems
- Download software updates
- Join support forums
- Find warranty and regulatory information

Load paper into the single-sheet slot (Tray 1)

Introduction

Use the single-sheet priority feed slot to print single-page documents, documents that require multiple paper types, or envelopes.

- [Load paper into the single-sheet priority feed slot](#)
- [Load an envelope in the single-sheet priority feed slot \(Tray 1\)](#)
- [Tray 1 paper orientation](#)

Load paper into the single-sheet priority feed slot

1. Move the paper width guides in the single-sheet priority feed slot outward.

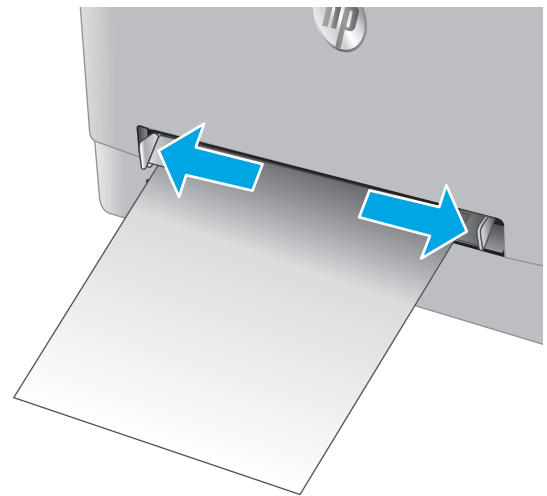

2. Place the top edge of the sheet at the opening, and then adjust the side guides so that they lightly touch the sheet, but do not bend it.

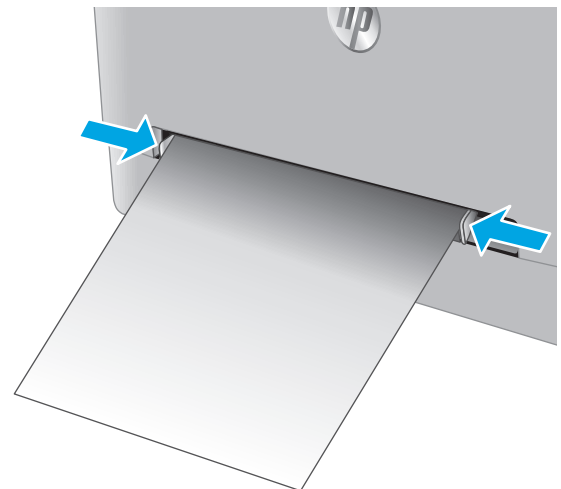

3. Insert the single sheet into the slot and hold it. The product will pull the sheet partially into the paper path. For information about how to orient the paper, see [Tray 1 paper orientation on page 19](#).

NOTE: Depending on the size of the paper, you might need to support the sheet with two hands until the sheet advances into the product.

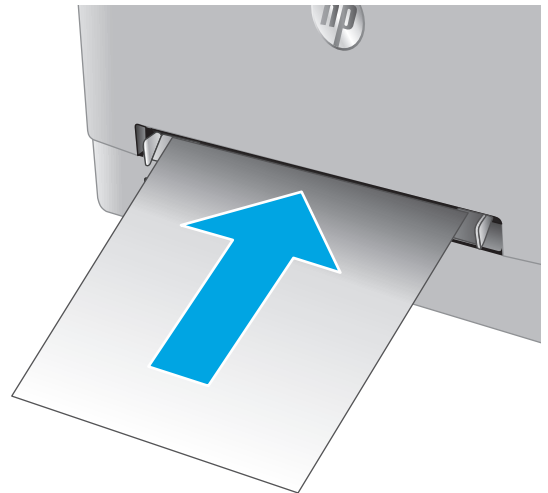

4. At the computer, begin the printing process from the software application. Make sure that the driver is set to the correct paper type and size for the paper being printed from the single-sheet priority feed slot.

Load an envelope in the single-sheet priority feed slot (Tray 1)

1. Move the paper width guides in the single-sheet priority feed slot outward.

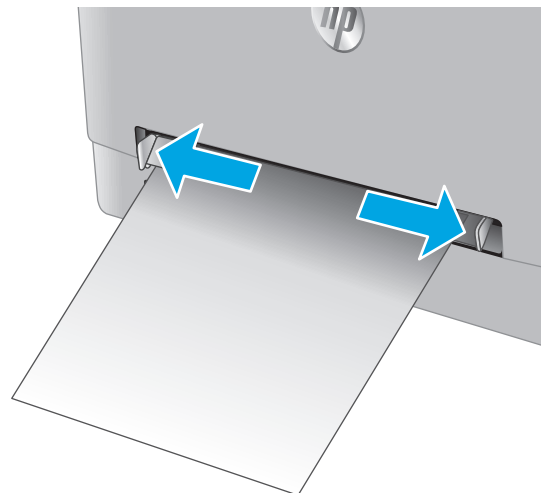

2. Place the right edge of the envelope, face-up, at the opening, and then adjust the side guides so that they lightly touch the envelope, but do not bend it.

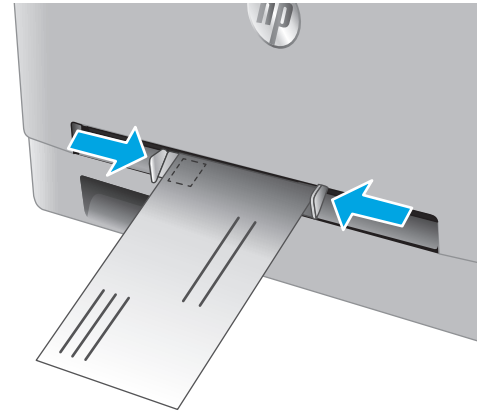

3. Insert the envelope into the slot and hold it. The product will pull the envelope partially into the paper path..

NOTE: Depending on the size of the envelope, you might need to support it with two hands until the envelope advances into the product.

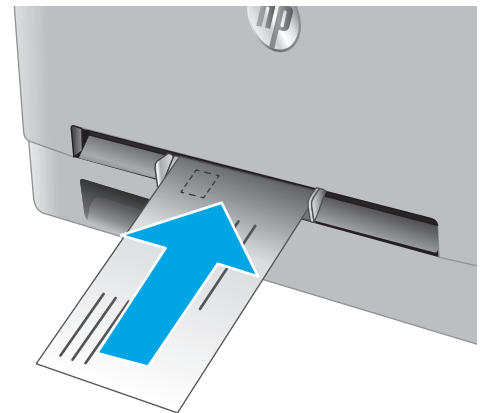

4. At the computer, begin the printing process from the software application. Make sure that the driver is set to the correct paper type and size for the envelope being printed from the single-sheet priority feed slot.

Tray 1 paper orientation

When using paper that requires a specific orientation, load it according to the information in the following table.

Paper type	Output	How to load paper
Letterhead or preprinted	1-sided printing	Face-up Top edge leading into the product
Letterhead or preprinted	2-sided printing	Face-down Top edge away from the product
Prepunched	1-sided printing or 2-sided printing	Face-up Holes toward the left side of the product

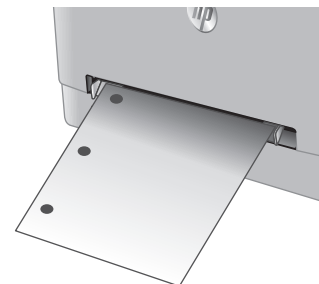

Load paper into Tray 2

Introduction

The following information describes how to load paper in Tray 2.

- [Load paper into Tray 2](#)
- [Load envelopes in Tray 2](#)
- [Tray 2 paper orientation](#)

Load paper into Tray 2

1. Open the tray.

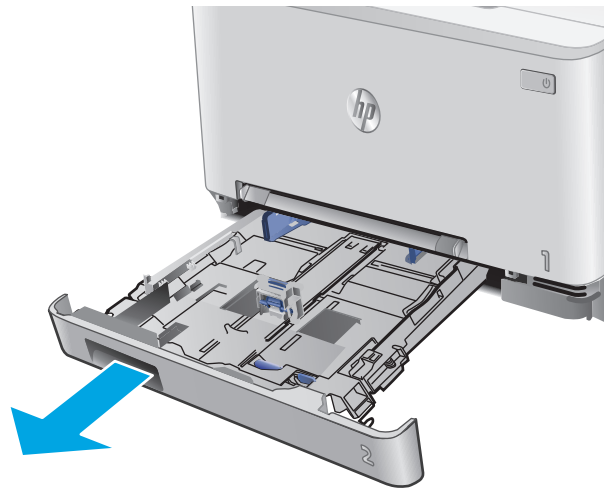

2. Adjust the paper guides by sliding the guides to the size of the paper being used.

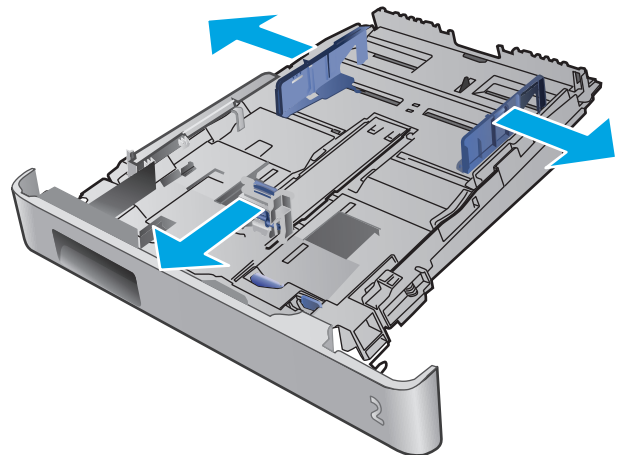

3. To load legal-size paper, extend the tray front by pressing the blue latch and pulling the front of the tray.

NOTE: When loaded with legal-size paper, Tray 2 extends from the front of the product approximately 51 mm (2 in).

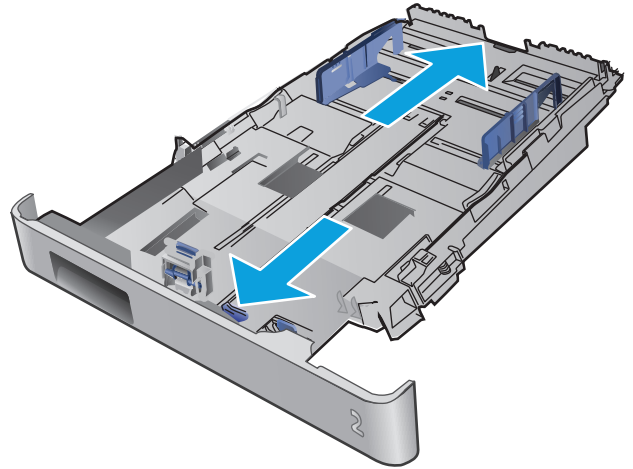

4. Load paper into the tray.

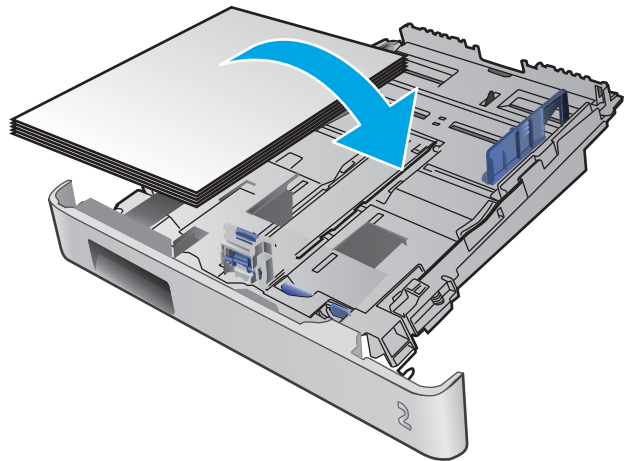

5. Make sure that the paper stack is flat at all four corners. Slide the paper length and width guides so that they are against the stack of paper.

NOTE: To prevent jams, do not overfill the tray. Be sure that the top of the stack is below the tray full indicator.

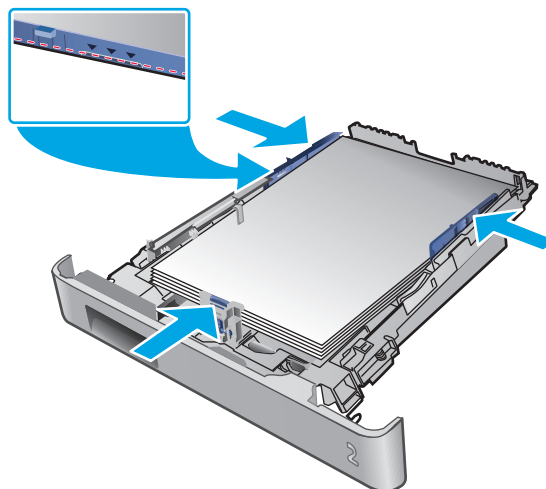

6. After making sure that the paper stack is below the tray full indicator, close the tray.



Load envelopes in Tray 2

1. Open the tray.

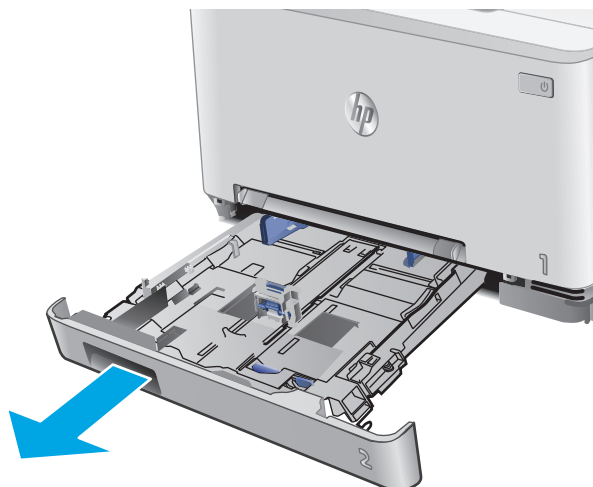

2. Adjust the paper guides by sliding the guides to the size of the envelopes being used.

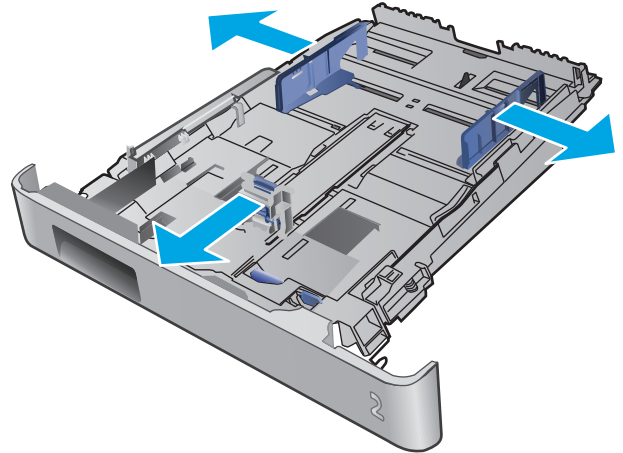

3. Load envelopes into the tray.

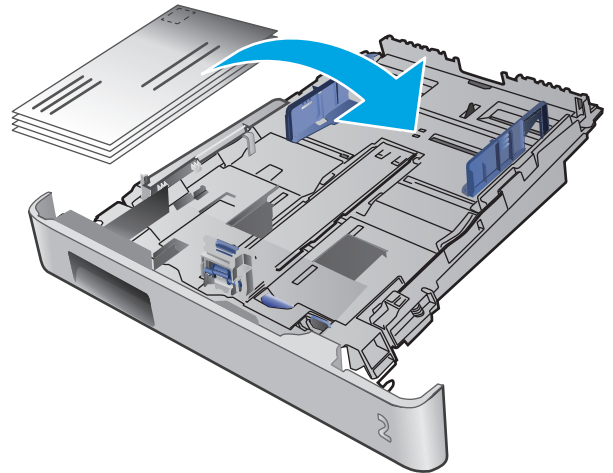

4. Make sure that the envelope stack is flat at all four corners. Slide the length and width guides so that they are against the stack.

NOTE: To prevent jams, do not overfill the tray. Be sure that the top of the stack is below the tray full indicator.

CAUTION: Loading more than five envelopes in Tray 2 can result in jams.

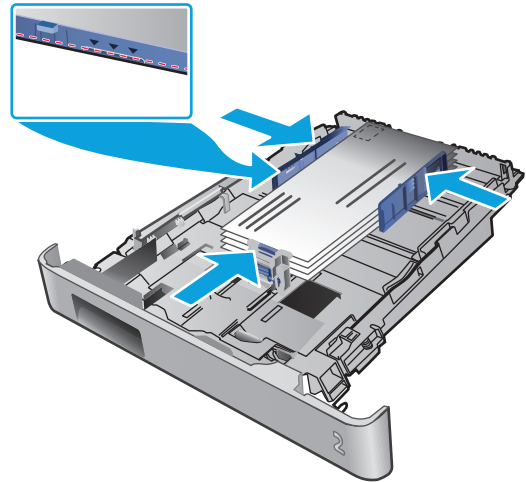

5. After making sure that the stack is below the tray full indicator, close the tray.

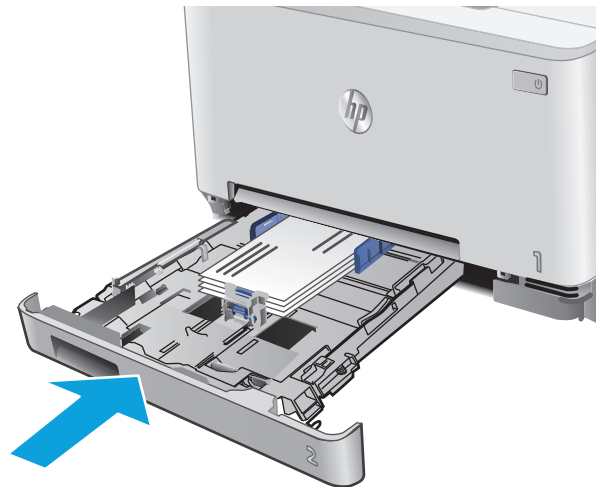

Tray 2 paper orientation

When using paper that requires a specific orientation, load it according to the information in the following table.

Paper type	Output	How to load paper
Letterhead or preprinted	1-sided printing	Face-up Top edge toward the product
Letterhead or preprinted	2-sided printing	Face-down Top edge away from the product
Prepunched	1-sided printing or 2-sided printing	Face-up Holes toward the left side of the product



3 Supplies, accessories, and parts

- [Order supplies, accessories, and parts](#)
- [Replace the toner cartridges](#)

For more information:

Go to www.hp.com/support/colorljMFPM277.

HP's all-inclusive help for the product includes the following information:

- Install and configure
- Learn and use
- Solve problems
- Download software updates
- Join support forums
- Find warranty and regulatory information

Order supplies, accessories, and parts

Ordering

Order supplies and paper	www.hp.com/go/suresupply
Order genuine HP parts or accessories	www.hp.com/buy/parts
Order through service or support providers	Contact an HP-authorized service or support provider.
Order using the HP Embedded Web Server (EWS)	To access, in a supported Web browser on the computer, enter the product IP address or host name in the address/URL field. The EWS contains a link to the HP SureSupply Web site, which provides options for purchasing Original HP supplies.

Supplies and accessories

Item	Description	Cartridge number	Part number
Supplies			
HP 201A Black Original LaserJet Toner Cartridge	Standard-capacity replacement black toner cartridge	201A	CF400A
HP 201X High Yield Black Original LaserJet Toner Cartridge	High-capacity replacement black toner cartridge	201X	CF400X
HP 201A Cyan Original LaserJet Toner Cartridge	Standard-capacity replacement cyan toner cartridge	201A	CF401A
HP 201X High Yield Cyan Original LaserJet Toner Cartridge	High-capacity replacement cyan toner cartridge	201X	CF401X
HP 201A Yellow Original LaserJet Toner Cartridge	Standard-capacity replacement yellow toner cartridge	201A	CF402A
HP 201X High Yield Yellow Original LaserJet Toner Cartridge	High-capacity replacement yellow toner cartridge	201X	CF402X
HP 201A Magenta Original LaserJet Toner Cartridge	Standard-capacity replacement magenta toner cartridge	201A	CF403A
HP 201X High Yield Magenta Original LaserJet Toner Cartridge	High-capacity replacement magenta toner cartridge	201X	CF403X
Accessories			
USB 2.0 printer cable	A-to-B cable (2-meter standard)		C6518A

Customer self-repair parts

Customer Self-Repair (CSR) parts are available for many HP LaserJet products to reduce repair time. More information about the CSR program and benefits can be found at www.hp.com/go/csr-support and www.hp.com/go/csr-faq.

Genuine HP replacement parts can be ordered at www.hp.com/buy/parts or by contacting an HP-authorized service or support provider. When ordering, one of the following will be needed: part number, serial number (found on back of printer), product number, or product name.

- Parts listed as **Mandatory** self-replacement are to be installed by customers, unless you are willing to pay HP service personnel to perform the repair. For these parts, on-site or return-to-depot support is not provided under the HP product warranty.
- Parts listed as **Optional** self-replacement can be installed by HP service personnel at your request for no additional charge during the product warranty period.

Item	Description	Self-replacement options	Part number
Single-sheet priority feed slot tray	Replacement tray for single-sheet priority feed slot (Tray 1)	Mandatory	RM2-5865-000
150-sheet paper input tray	Replacement cassette for Tray 2	Mandatory	RM2-5886-000

Replace the toner cartridges

Introduction

This product indicates when the toner cartridge level is low. The actual toner cartridge life remaining can vary. Consider having a replacement cartridge available to install when print quality is no longer acceptable.

To purchase cartridges or check cartridge compatibility for the product, go to HP SureSupply at www.hp.com/go/suresupply. Scroll to the bottom of the page and verify that the country/region is correct.

The product uses four colors and has a different toner cartridge for each color: yellow (Y), magenta (M), cyan (C), and black (K). The toner cartridges are inside the front door.

Item	Description	Cartridge number	Part number
HP 201A Black Original LaserJet Toner Cartridge	Standard-capacity replacement black toner cartridge	201A	CF400A
HP 201X High Yield Black Original LaserJet Toner Cartridge	High-capacity replacement black toner cartridge	201X	CF400X
HP 201A Cyan Original LaserJet Toner Cartridge	Standard-capacity replacement cyan toner cartridge	201A	CF401A
HP 201X High Yield Cyan Original LaserJet Toner Cartridge	High-capacity replacement cyan toner cartridge	201X	CF401X
HP 201A Yellow Original LaserJet Toner Cartridge	Standard-capacity replacement yellow toner cartridge	201A	CF402A
HP 201X High Yield Yellow Original LaserJet Toner Cartridge	High-capacity replacement yellow toner cartridge	201X	CF402X
HP 201A Magenta Original LaserJet Toner Cartridge	Standard-capacity replacement magenta toner cartridge	201A	CF403A
HP 201X High Yield Magenta Original LaserJet Toner Cartridge	High-capacity replacement magenta toner cartridge	201X	CF403X

Do not remove the toner cartridge from its package until it is time to install it.

CAUTION: To prevent damage to the toner cartridge, do not expose it to light for more than a few minutes. If the toner cartridge must be removed from the product for an extended period of time, place the cartridge in the original plastic packaging, or cover the cartridge with a light-weight, opaque item.

The following illustration shows the toner-cartridge components.

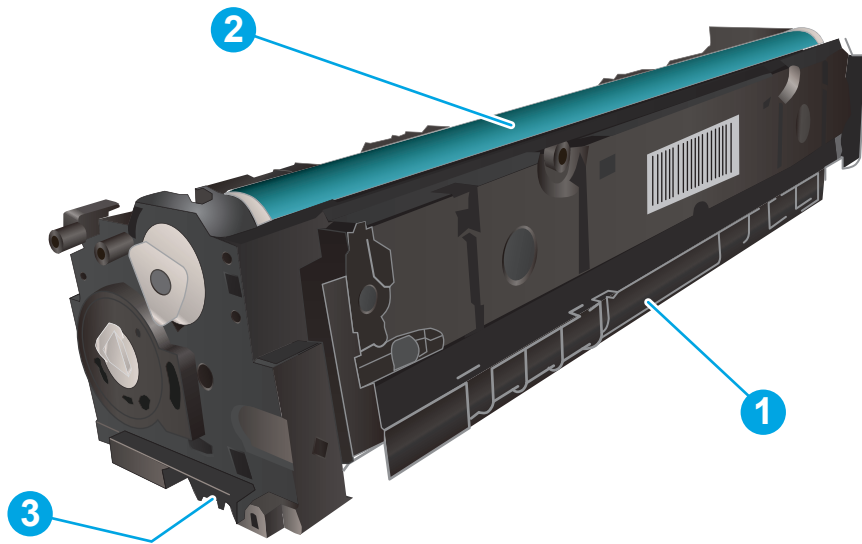

1	Handle
2	Imaging drum
3	Memory chip

CAUTION: If toner gets on clothing, wipe it off by using a dry cloth and wash the clothes in cold water. Hot water sets toner into fabric.

NOTE: Information about recycling used toner cartridges is in the toner cartridge box.

Remove and replace the toner cartridges

1. Open the front door.



2. Grasp the blue handle on the toner cartridge drawer, and then pull out the drawer.



3. Grasp the handle on the toner cartridge, and then pull the toner cartridge straight up to remove it.



4. Remove the new toner cartridge package from the box, and then pull the release tab on the packaging.

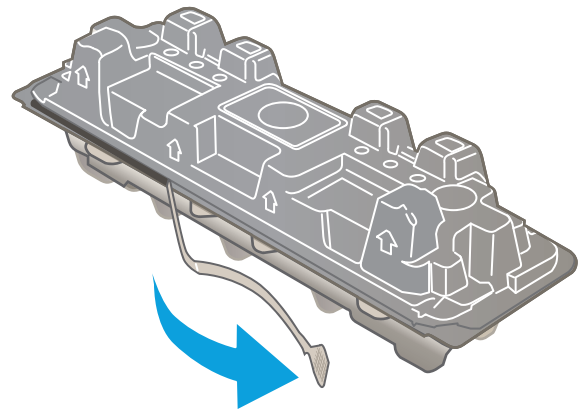

5. Remove the toner cartridge from the opened packaging shell.

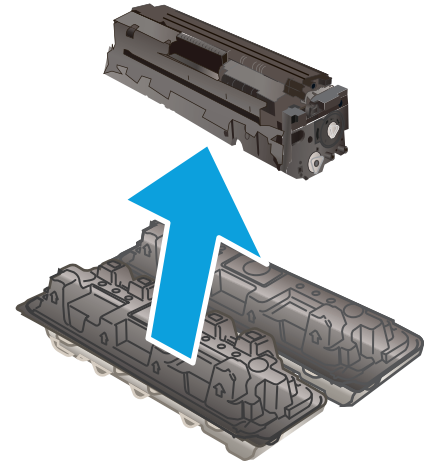

6. Gently rock the toner cartridge from front to back to distribute the toner evenly inside the cartridge.

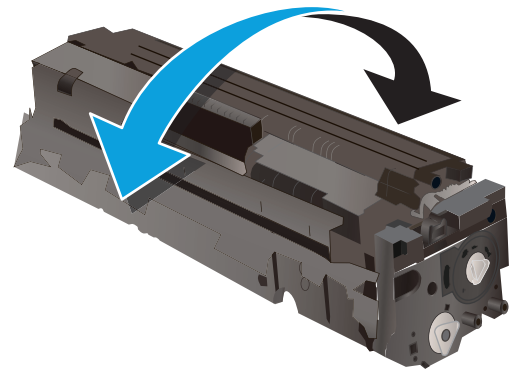

7. Do not touch the imaging drum on the bottom of the toner cartridge. Fingerprints on the imaging drum can cause print-quality problems.

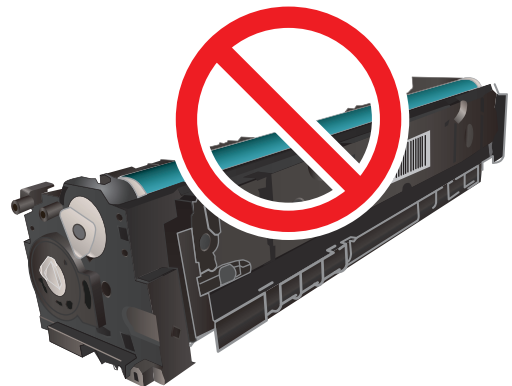

8. Insert the new toner cartridge into the drawer. Make sure that the color chip on the cartridge matches the color chip on the drawer.



9. Close the toner cartridge drawer.



10. Close the front door.



11. Place the used toner cartridge in the packaging from the new cartridge.

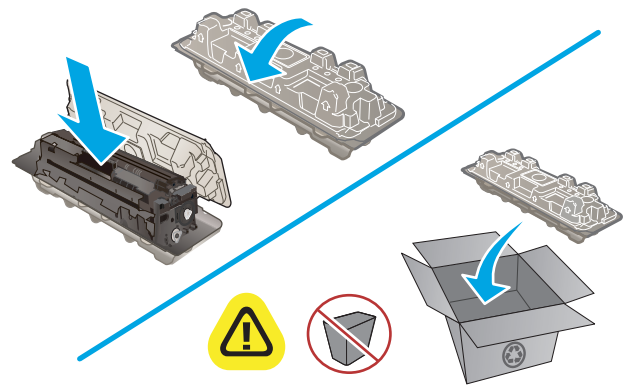

 <http://www.hp.com/recycle>

12. Use the pre-paid self-addressed label to return the used cartridge to HP for recycling (where available).

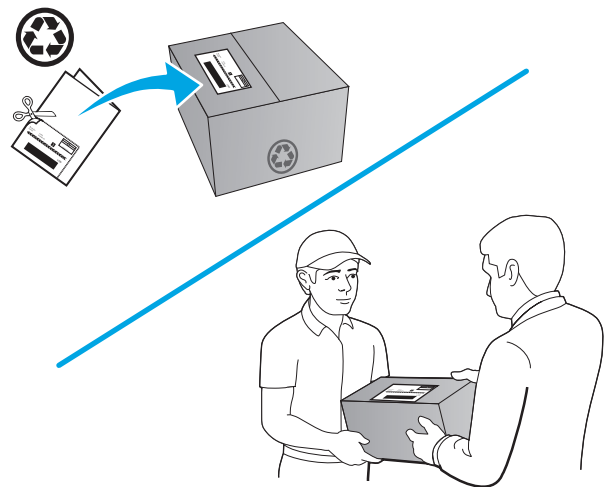

4 Print

- [Print tasks \(Windows\)](#)
- [Print tasks \(OS X\)](#)
- [Mobile printing](#)
- [Use walk-up USB printing](#)

For more information:

Go to www.hp.com/support/colorljMFPM277.

HP's all-inclusive help for the product includes the following information:

- Install and configure
- Learn and use
- Solve problems
- Download software updates
- Join support forums
- Find warranty and regulatory information

Print tasks (Windows)

How to print (Windows)

The following procedure describes the basic printing process for Windows.

1. From the software program, select the **Print** option.
2. Select the product from the list of printers. To change settings, click or tap the **Properties** or **Preferences** button to open the print driver.

 **NOTE:** The name of the button varies for different software programs.

 **NOTE:** To access these features from a Windows 8 or 8.1 Start screen, select **Devices**, select **Print**, and then select the printer.

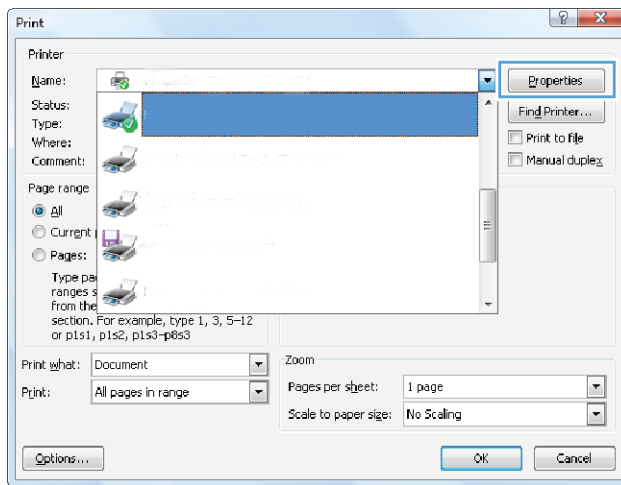

3. Click or tap the tabs in the print driver to configure the available options. For example, set the paper orientation on the **Finishing** tab, and set the paper source, paper type, paper size, and quality settings on the **Paper/Quality** tab.

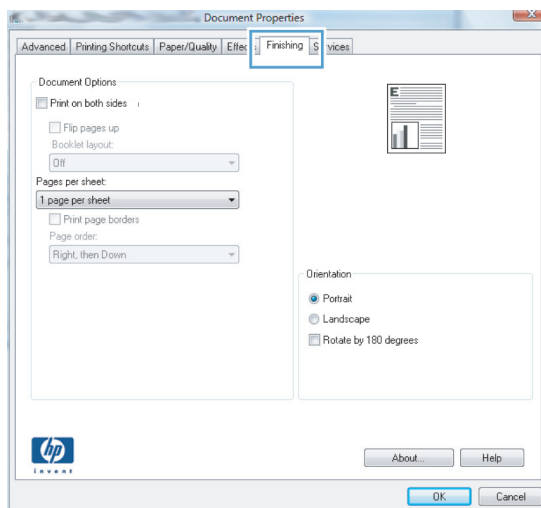

4. Click or tap the **OK** button to return to the **Print** dialog box. Select the number of copies to print from this screen.
5. Click or tap the **OK** button to print the job.

Automatically print on both sides (Windows)

Use this procedure for products that have an automatic duplexer installed. If the product does not have an automatic duplexer installed, or to print on paper types that the duplexer does not support, you can print on both sides manually.

1. From the software program, select the **Print** option.
2. Select the product from the list of printers, and then click or tap the **Properties** or **Preferences** button to open the print driver.



NOTE: The name of the button varies for different software programs.



NOTE: To access these features from a Windows 8 or 8.1 Start screen, select **Devices**, select **Print**, and then select the printer.

3. Click or tap the **Finishing** tab.
4. Select the **Print on both sides** check box. Click the **OK** button to close the **Document Properties** dialog box.
5. In the **Print** dialog box, click the **OK** button to print the job.

Manually print on both sides (Windows)

Use this procedure for products that do not have an automatic duplexer installed or to print on paper that the duplexer does not support.

1. From the software program, select the **Print** option.
2. Select the product from the list of printers, and then click or tap the **Properties** or **Preferences** button to open the print driver.



NOTE: The name of the button varies for different software programs.



NOTE: To access these features from a Windows 8 or 8.1 Start screen, select **Devices**, select **Print**, and then select the printer.

3. Click or tap the **Finishing** tab.
4. Select the **Print on both sides (manually)** check box. Click the **OK** button to print the first side of the job.
5. Retrieve the printed stack from the output bin, and place it in Tray 1.
6. If prompted, touch the appropriate control panel button to continue.

Print multiple pages per sheet (Windows)

1. From the software program, select the **Print** option.
2. Select the product from the list of printers, and then click or tap the **Properties** or **Preferences** button to open the print driver.

 **NOTE:** The name of the button varies for different software programs.

 **NOTE:** To access these features from a Windows 8 or 8.1 Start screen, select **Devices**, select **Print**, and then select the printer.

3. Click or tap the **Finishing** tab.
4. Select the number of pages per sheet from the **Pages per sheet** drop-down list.
5. Select the correct **Print page borders**, **Page order**, and **Orientation** options. Click the **OK** button to close the **Document Properties** dialog box.
6. In the **Print** dialog box, click the **OK** button to print the job.

Select the paper type (Windows)

1. From the software program, select the **Print** option.
2. Select the product from the list of printers, and then click or tap the **Properties** or **Preferences** button to open the print driver.

 **NOTE:** The name of the button varies for different software programs.

 **NOTE:** To access these features from a Windows 8 or 8.1 Start screen, select **Devices**, select **Print**, and then select the printer.

3. Click or tap the **Paper/Quality** tab.
4. From the **Paper type** drop-down list, select the paper type that best describes the paper being used, and then click the **OK** button..
5. Click the **OK** button to close the **Document Properties** dialog box. In the **Print** dialog box, click the **OK** button to print the job.

Print tasks (OS X)

How to print (OS X)

The following procedure describes the basic printing process for OS X.

1. Click the **File** menu, and then click the **Print** option.
2. Select the product.
3. Click **Show Details**, and then select other menus to adjust the print settings.
4. Click the **Print** button.

Automatically print on both sides (OS X)

 **NOTE:** This information applies to products that include an automatic duplexer.

 **NOTE:** This feature is available if you install the HP print driver. It might not be available if you are using AirPrint.

1. Click the **File** menu, and then click the **Print** option.
2. Select the product.
3. Click **Show Details**, and then click the **Layout** menu.
4. Select a binding option from the **Two-Sided** drop-down list.
5. Click the **Print** button.

Manually print on both sides (OS X)

 **NOTE:** This feature is available if you install the HP print driver. It might not be available if you are using AirPrint.

1. Click the **File** menu, and then click the **Print** option.
2. Select the product.
3. Click **Show Details**, and then click the **Manual Duplex** menu.
4. Click the **Manual Duplex** box, and select a binding option.
5. Click the **Print** button.
6. Go to the product, and remove any blank paper that is in Tray 1.
7. Retrieve the printed stack from the output bin and place it with the printed-side facing down in the input tray.
8. If prompted, touch the appropriate control panel button to continue.

Print multiple pages per sheet (OS X)

1. Click the **File** menu, and then click the **Print** option.
2. Select the product.

3. Click **Show Details**, and then click the **Layout** menu.
4. From the **Pages per Sheet** drop-down list, select the number of pages that you want to print on each sheet.
5. In the **Layout Direction** area, select the order and placement of the pages on the sheet.
6. From the **Borders** menu, select the type of border to print around each page on the sheet.
7. Click the **Print** button.

Select the paper type (OS X)

1. Click the **File** menu, and then click the **Print** option.
2. Select the product.
3. Click **Show Details**, and then click the **Media & Quality** menu or the **Paper/Quality** menu.
4. Select a type from the **Media-type** drop-down list.
5. Click the **Print** button.

Mobile printing

Introduction

HP offers multiple Mobile and ePrint solutions to enable wireless printing to an HP printer from a laptop, tablet, smartphone, or other mobile device. To see the full list and to determine the best choice, go to www.hp.com/go/LaserJetMobilePrinting (English only).

- [Wi-Fi Direct and NFC Printing \(wireless models only\)](#)
- [HP ePrint via email](#)
- [HP ePrint software](#)
- [AirPrint](#)
- [Android embedded printing](#)

Wi-Fi Direct and NFC Printing (wireless models only)

Wi-Fi Direct and NFC (Near Field Communication) enable printing from a wireless mobile device without requiring a connection to a network or the Internet.

NFC capabilities enable easy one-to-one print connection for mobile devices using device-to-device touch.

Use Wi-Fi Direct to print wirelessly from the following devices:

- iPhone, iPad, or iPod touch using Apple AirPrint or the HP ePrint app
- Android mobile devices using the HP ePrint App or the Android embedded print solution
- PC and Mac devices using the HP ePrint Software

Enable or disable Wi-Fi Direct

Wi-Fi Direct capabilities must be enabled first from the product control panel.

1. From the Home screen on the product control panel, touch the Connection Information  button.
2. Open the following menus:
 - [Wi-Fi Direct](#)
 - [Settings](#)
 - [On/Off](#)
3. Touch the [On](#) menu item. Touching the [Off](#) button disables Wi-Fi Direct printing.

For more information about wireless printing, go to www.hp.com/go/wirelessprinting.

For more information about how to print using Wi-Fi Direct, go to the product support home page: www.hp.com/support/colorljMFPM277.

HP ePrint via email

Use HP ePrint to print documents by sending them as an email attachment to the product's email address from any email-enabled device.

To use HP ePrint, the product must meet these requirements:

- The product must be connected to a wired or wireless network and have Internet access.
- HP Web Services must be enabled on the product, and the product must be registered with HP Connected or HP ePrint Center.
 1. From the Home screen on the product control panel, touch the Connection Information  button.
 2. Open the following menus:
 - ePrint
 - Settings
 - Enable Web Services
 3. Touch the **Print** button to read the terms of use agreement. Touch the **OK** button to accept the terms of use and enable HP Web Services

The product enables Web Services, and then prints an information page. The information page contains the printer code that you use to register this HP product at HP Connected or HP ePrint Center.
 4. Go to www.hpconnected.com or www.hp.com/go/eprintcenter to create an HP ePrint account and complete the ePrint via email setup process.

Go to www.hp.com/support/colorljMFPM277 to review additional support information for this product.

HP ePrint software

The HP ePrint software makes it easy to print from a Windows or Mac desktop or laptop computer to any HP ePrint-capable product. This software makes it easy to find HP ePrint-enabled products that are registered to your HP Connected account. The target HP printer can be located in the office or at locations across the globe.

- **Windows:** After installing the software, open the **Print** option from within your application, and then select **HP ePrint** from the installed printers list. Click the **Properties** button to configure print options.
- **Mac:** After installing the software, select **File, Print**, and then select the arrow next to **PDF** (in the bottom left of the driver screen). Select **HP ePrint**.

For Windows, the HP ePrint software supports TCP/IP printing to local network printers on the network (LAN or WAN) to products that support UPD PostScript®.

Windows and Mac both support IPP printing to LAN or WAN network-connected products that support ePCL.

Windows and Mac also both support printing PDF documents to public print locations and printing using HP ePrint via email through the cloud.

Go to www.hp.com/go/eprintsoftware for drivers and information.

 **NOTE:** The HP ePrint software is a PDF workflow utility for Mac, and is not technically a print driver.

 **NOTE:** HP ePrint Software does not support USB printing.

AirPrint

Direct printing using Apple's AirPrint is supported for iOS 4.2 or later and from Mac computers running OS X 10.7 Lion and newer. Use AirPrint to print directly to the product from an iPad, iPhone (3GS or later), or iPod touch (third generation or later) in the following mobile applications:

- Mail
- Photos
- Safari
- iBooks
- Select third-party applications

To use AirPrint, the product must be connected to the same wireless network as the Apple device. For more information about using AirPrint and about which HP products are compatible with AirPrint, go to the support Web site for this product:

www.hp.com/support/colorljMFPM277

 **NOTE:** AirPrint does not support USB connections.

Android embedded printing

HP's built-in print solution for Android and Kindle enables mobile devices to automatically find and print to HP printers that are either on a wireless network or within wireless range for wireless printing. The print solution is built into the supported operating systems, so installing drivers or downloading software is not necessary.

For more information on how to use Android embedded printing and which Android devices are supported, go to www.hp.com/support/colorljMFPM277.

Use walk-up USB printing

1. Insert the USB flash drive into the walk-up USB port on the product.
2. The **USB Flash Drive** menu opens with the following options:
 - **Print Documents**
 - **View and Print Photos**
 - **Scan to USB Drive**
3. To print a document, touch the **Print Documents** screen, and then touch the name of the folder on the USB drive where the document is stored. When the summary screen opens, you can touch it to adjust the settings. Touch the **Print** button to print the document.
4. To print photos, touch the **View and Print Photos** screen, and then touch the preview image to select each photo that you want to print. Touch the **Done** button. When the summary screen opens, you can touch it to adjust the settings. Touch the **Print** button to print the photos.
5. Retrieve the printed job from the output bin, and remove the USB flash drive.

5 Copy

- [Make a copy](#)
- [Copy on both sides \(duplex\)](#)

For more information:

Go to www.hp.com/support/colorljMFPM277.

HP's all-inclusive help for the product includes the following information:

- Install and configure
- Learn and use
- Solve problems
- Download software updates
- Join support forums
- Find warranty and regulatory information

Make a copy

1. Load the document on the scanner glass according to the indicators on the product.
2. From the Home screen on the product control panel, touch the **Copy**  button.
3. To optimize copy quality for different types of documents, touch the **Settings** button, and then scroll to and touch the **Optimize** button. Swipe the control panel screen to scroll through the options, and then touch an option to select it. The following copy-quality settings are available:
 - **Auto Select:** Use this setting when you are not concerned about the quality of the copy. This is the default setting.
 - **Mixed:** Use this setting for documents that contain a mixture of text and graphics.
 - **Text:** Use this setting for documents that contain mostly text.
 - **Picture:** Use this setting for documents that contain mostly graphics.
4. Touch **Number of Copies**, and then use the touchscreen keypad to adjust the number of copies.
5. Touch the **Black** or **Color** button to start copying.

Copy on both sides (duplex)

- [Copy on both sides automatically](#)
- [Copy on both sides manually](#)

Copy on both sides automatically

1. Load the original documents into the document feeder with the first page facing up, and with the top of the page leading.
2. Adjust the paper guides to fit the size of the document.
3. From the Home screen on the product control panel, touch the **Copy**  button.
4. Touch the **Settings** button.
5. Scroll to and touch the **Two-Sided** button.
6. Swipe through the options, and then touch an option to select it.
7. Touch the **Black** or **Color** button to start copying.

Copy on both sides manually

1. Place the document face-down on the scanner glass with the upper-left corner of the page in the upper-left corner of the glass. Close the scanner.
2. From the Home screen on the product control panel, touch the **Copy**  button.
3. Touch the **Settings** button.
4. Scroll to and touch the **Two-Sided** button.
5. Swipe through the options, and then touch an option to select it.
6. Touch the **Black** or **Color** button to start copying.
7. The product prompts you to load the next original document. Place it on the glass, and then touch the **OK** button.
8. Repeat this process until you have scanned the last page. Touch the **Done** button to finish printing the copies.

6 Scan

- [Scan by using the HP Scan software \(Windows\)](#)
- [Scan by using the HP Scan software \(OS X\)](#)
- [Scan to a USB flash drive](#)
- [Set up Scan to Network Folder](#)
- [Scan to a network folder](#)
- [Set up Scan to E-mail](#)
- [Scan to email](#)
- [Additional scan tasks](#)

For more information:

Go to www.hp.com/support/colorljMFPM277.

HP's all-inclusive help for the product includes the following information:

- Install and configure
- Learn and use
- Solve problems
- Download software updates
- Join support forums
- Find warranty and regulatory information

Scan by using the HP Scan software (Windows)

Use the HP Scan software to initiate scanning from software on your computer. You can save the scanned image as a file or send it to another software application.

1. Load the document in the document feeder or on the scanner glass according to the indicators on the product.
2. Click **Start**, and then click **Programs** (or **All Programs** in Windows XP).
3. Click **HP**, and then select your product.
4. Click **HP Scan**, select a scanning shortcut, and then adjust the settings if necessary.
5. Click **Scan**.



NOTE: Click **Advanced Settings** to gain access to more options.

Click **Create New Shortcut** to create a customized set of settings and save it in the list of shortcuts.

Scan by using the HP Scan software (OS X)

Use the HP Scan software to initiate scanning from software on your computer.

1. Load the document in the document feeder or on the scanner glass according to the indicators on the product.
2. Open **HP Scan**, which is located in the **Hewlett-Packard** folder inside the **Applications** folder.
3. Follow the on-screen instructions to scan the document.
4. When you have scanned all the pages, click **File** and then **Save** to save them to a file.

Scan to a USB flash drive

1. Load the document on the scanner glass according to the indicators on the product.
2. Insert a USB flash drive into the walk-up USB port.
3. From the Home screen on the product control panel, touch the **Scan**  button.
4. Touch the **Scan to USB Drive** screen.
5. Touch the **Scan** button to scan and save the file. The product creates a folder named **HPSCANS** on the USB drive, and it saves the file in .PDF or .JPG format using an automatically generated file name.



NOTE: When the summary screen opens, you can touch it to adjust settings.

You also can change the folder name.

Set up Scan to Network Folder

Introduction

To use this scan feature, the product must be connected to a network. This scan feature is not available until you configure it. To configure this feature, use the Scan to Network Folder Setup Wizard (Windows), which is installed in the HP program group for the product as part of the full software installation. You can also use the HP Embedded Web Server to configure these features. The following instructions describe configuring the feature by using both the Scan to Network Folder Wizard and the HP Embedded Web Server.

- [Use the Scan to Network Folder Wizard \(Windows\)](#)
- [Set up the Scan to Network Folder feature via the HP Embedded Web Server \(Windows\)](#)
- [Set up the Scan to Network Folder feature on a Mac](#)

Use the Scan to Network Folder Wizard (Windows)

Some HP products include driver installation from a software CD. At the end of this installation is an option to **Setup Scan to Folder and Email**. The setup wizards include the options for basic configuration.

After installation, access the setup wizard by clicking the **Start** button, selecting the **Programs** or **All Programs** item, and then clicking the **HP** item. Click the product name item, and then click the **Scan to Network Folder Wizard** to start the configuration process.

1. To add a new network folder, click the **New** button.
2. Enter the network folder address or click the **Browse** button to locate a folder to be shared. Enter the display name that will appear on the control panel. Click the **Next** button.
3. To share the folder with other users, check the box for that option. Enter the security pin if required. Click the **Next** button.
4. Enter the User Name and Password. Click the **Next** button.
5. Review the information and verify all the settings are correct. If there is an error, click the **Back** button to correct the error. When finished, click the **Save and Test** button to test the configuration and finish the setup.

Set up the Scan to Network Folder feature via the HP Embedded Web Server (Windows)

1. Open the HP Embedded Web Server (EWS):
 - a. From the Home screen on the product control panel, touch the Connection Information  /  button, and then touch the **Network Connected**  button or the **Network Wi-Fi ON**  button to display the IP address or host name.

- b. Open a Web browser, and in the address line, type the IP address or host name exactly as it displays on the product control panel. Press the **Enter** key on the computer keyboard. The EWS opens.



 **NOTE:** If the Web browser displays a **There is a problem with this website's security certificate** message when attempting to open the EWS, click **Continue to this website (not recommended)**.

Choosing **Continue to this website (not recommended)** will not harm the computer while navigating within the EWS for the HP product.

2. Click the **Scan** tab.
3. On the left navigation pane, click the **Network Folder Setup** link.
4. On the **Network Folder Configuration** page, click the **New** button.
 - a. In the **Network Folder Information** section, enter the Display Name and Network Path. If required, enter the network Username and Password.

 **NOTE:** The network folder must be shared for this feature to work. It can be shared for only you or for other users.





- b. Optional: To secure the folder from unauthorized access, enter a PIN in the **Secure the Folder Access with a PIN** section. This PIN will be required every time someone uses the scan to network folder feature.
- c. In the **Scan Settings** section, adjust the scan settings.

Review all the information, then click **Save and Test** to save the information and test the connection, or **Save Only** to save the information only.

Set up the Scan to Network Folder feature on a Mac

1. Use one of the following methods to open the Embedded Web Server (EWS) interface.

Use a Web browser to open the HP Embedded Web Server (EWS)

- a. From the Home screen on the product control panel, touch the Connection Information  /  button, and then touch the **Network Connected**  button or the **Network Wi-Fi ON**  button to display the IP address or host name.
- b. Open a Web browser, and in the address line, type the IP address or host name exactly as it displays on the product control panel. Press the **Enter** key on the computer keyboard. The EWS opens.

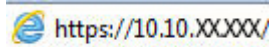

 **NOTE:** If the Web browser displays a **There is a problem with this website's security certificate** message when attempting to open the EWS, click **Continue to this website (not recommended)**.

Choosing **Continue to this website (not recommended)** will not harm the computer while navigating within the EWS for the HP product.

Use the HP Utility to open the HP Embedded Web Server (EWS)

- a. Open the HP Utility by clicking the HP Utility icon on the Dock, or click the **Go** menu, and then double-click HP Utility.
 - b. In the HP Utility, either click **Additional Settings**, and then click **Open Embedded Web Server**, or click **Scan to E-mail**. The EWS opens.
2. Click the **Scan** tab.
 3. On the left navigation pane, click the **Network Folder Setup** link.
 4. On the **Network Folder Configuration** page, click the **New** button.
 - In the **Network Folder Information** section, enter the Display Name and Network Path. If required, enter the network Username and Password.
 - In the **Secure the Folder Access with a PIN** section, enter the PIN.
 5. Review all the information, then click **Save and Test** to save the information and test the connection, or **Save Only** to save the information only.



NOTE: You can assign a 4-digit security PIN to prevent unauthorized persons from saving scans to the network folder. The PIN must be entered on the product control panel each time a scan is performed.



NOTE: To create additional network folders, repeat these steps for each folder.

Scan to a network folder

Use the product control panel to scan a document and save it to a folder on the network.



NOTE: In order to use this feature, the product must be connected to a network and the Scan to Network Folder feature must be configured by using the Scan to Network Folder Setup Wizard (Windows) or the HP Embedded Web Server.

1. Load the document on the scanner glass according to the indicators on the product.
2. From the Home screen on the product control panel, touch the [Scan](#) button.
3. Touch the [Scan to Network Folder](#) item.
4. In the list of network folders, select the folder to which you want to save the document.
5. The control panel screen displays the scan settings.
 - If you want to change any of the settings, touch the [Settings](#) button, and then change the settings.
 - If the settings are correct, go to the next step.
6. Touch the [Scan](#) button to start the scan job.

Set up Scan to E-mail

Introduction

To use this scan feature, the product must be connected to a network. This scan feature is not available until you configure it. To configure this feature, use the Scan to Email Setup Wizard (Windows), which is installed in the HP program group for the product as part of the full software installation. You can also use the HP Embedded Web Server to configure this feature. The following instructions describe configuring the feature by using both the Scan to Email Setup Wizard and the HP Embedded Web Server.

- [Use the Scan to E-Mail Wizard \(Windows\)](#)
- [Set up the Scan to Email feature via the HP Embedded Web Server \(Windows\)](#)
- [Set up the Scan to Email feature on a Mac](#)

Use the Scan to E-Mail Wizard (Windows)

Some HP products include driver installation from a software CD. At the end of this installation is an option to **Setup Scan to Folder and Email**. The setup wizards include the options for basic configuration.

After installation, access the setup wizard by clicking the **Start** button, selecting the **Programs** or **All Programs** item, and then clicking the **HP** item. Click the product name item, and then click the **Scan to E-mail Wizard** to start the configuration process.

1. To add a new outgoing email address, click the **New** button.
2. Enter the email address. Click the **Next** button.
3. In the **Display Name** box, type the name to display for this email address, and then click **Next**.

 **NOTE:** To secure the email profile, enter a 4-digit PIN. After a security PIN is assigned to a profile, the PIN must be entered on the product control panel before the product can send an email using that profile.

4. Enter the name or the IP address of the SMTP server and the SMTP server port number. If the outgoing SMTP server requires additional security authentication, click the check box labeled **E-mail Log-in Authentication** and enter the required User ID and Password. Click the **Next** button when finished.



 **NOTE:** If you do not know the SMTP server name, SMTP port number, or authentication information, contact the email/Internet service provider or system administrator for the information. SMTP server names and port names are typically easy to find by doing an Internet search. For example, use terms like "gmail smtp server name" or "yahoo smtp server name" to search.

5. Review the information and verify all the settings are correct. If there is an error, click the **Back** button to correct the error. When finished, click the **Save and Test** button to test the configuration and finish the setup.

 **NOTE:** Create additional outgoing email profiles to scan from more than one email account.

Set up the Scan to Email feature via the HP Embedded Web Server (Windows)

1. Open the HP Embedded Web Server (EWS):

- a. From the Home screen on the product control panel, touch the Connection Information  button, and then touch the **Network Connected**  button or the **Network Wi-Fi ON**  button to display the IP address or host name.
- b. Open a Web browser, and in the address line, type the IP address or host name exactly as it displays on the product control panel. Press the **Enter** key on the computer keyboard. The EWS opens.

 <https://10.10.XX.XXX/>

 **NOTE:** If the Web browser displays a **There is a problem with this website's security certificate** message when attempting to open the EWS, click **Continue to this website (not recommended)**.

Choosing **Continue to this website (not recommended)** will not harm the computer while navigating within the EWS for the HP product.

2. Click the **Scan** tab.
3. On the left navigation pane, click the **Scan to E-mail Setup** link.
4. On the **Scan to E-mail Setup** page, there is a list of settings to configure. These settings are also listed in the left navigation pane. To start, click the **Outgoing E-mail Profiles** link.
5. On the **Outgoing E-mail Profiles** page, click the **New** button.
 - In the **E-mail Address** area, enter the email address and display name.
 - In the **SMTP Server Settings** area, enter the SMTP server address and SMTP Port. The default port is already entered and in most cases does not need to be changed.

 **NOTE:** If you are using Google™ Gmail for email service, click the **Always use secure connection (SSL/TLS)** check box.

- In the **SMTP Authentication** area, click the check box **SMTP server requires authentication for outgoing e-mail messages** to configure the SMTP User ID and Password if required.

Ask your network administrator or your Internet service provider for the SMTP server setting information. If the SMTP server requires authentication, you also need to know the SMTP User ID and password. SMTP server names and port names are typically easy to find by doing an Internet search. For example, use terms like “gmail smtp server name” or “yahoo smtp server name”
- In the **Optional PIN** area, enter a PIN. This pin will be required every time an email is sent using the email address.
- In the **E-mail Message Preferences** area, configure the message preferences.





Review all the information, then click **Save and Test** to save the information and test the connection, or **Save Only** to save the information only.

6. To add email addresses to the address book accessible from the product, click the **E-mail Address Book** link and enter the required information. You can set up individual email addresses or email groups.
7. To configure default options, click the **E-mail options** link. Enter the default email subject, body text, and other scan settings.

Set up the Scan to Email feature on a Mac

1. Use one of the following methods to open the Embedded Web Server (EWS) interface.

Use a Web browser to open the HP Embedded Web Server (EWS)

- a. From the Home screen on the product control panel, touch the Connection Information  /  button, and then touch the **Network Connected**  button or the **Network Wi-Fi ON**  button to display the IP address or host name.
- b. Open a Web browser, and in the address line, type the IP address or host name exactly as it displays on the product control panel. Press the **Enter** key on the computer keyboard. The EWS opens.



 **NOTE:** If the Web browser displays a **There is a problem with this website's security certificate** message when attempting to open the EWS, click **Continue to this website (not recommended)**.

Choosing **Continue to this website (not recommended)** will not harm the computer while navigating within the EWS for the HP product.

Use the HP Utility to open the HP Embedded Web Server (EWS)

- a. Open the HP Utility by clicking the HP Utility icon on the Dock, or click the **Go** menu, and then double-click HP Utility.
 - b. In the HP Utility, either click **Additional Settings**, and then click **Open Embedded Web Server**, or click **Scan to E-mail**. The EWS opens.
2. Click the **Scan** tab.
 3. On the left navigation pane, click the **Scan to E-mail Setup** link.
 4. On the **Scan to E-mail Setup** page, there is a list of settings to configure. These settings are also listed in the left navigation pane. To start, click the **Outgoing E-mail Profiles** link.
 5. On the **Outgoing E-mail Profiles** page, click the **New** button.
 - In the **E-mail Address** area, enter the email address and display name.
 - In the **SMTP Server Settings** area, enter the SMTP server address and SMTP Port. The default port is already entered and in most cases does not need to be changed.

 **NOTE:** If you are using Google™ Gmail for email service, click the **Always use secure connection (SSL/TLS)** check box.

- In the **SMTP Authentication** area, click the checkbox labeled **SMTP server requires authentication for outgoing e-mail messages** to configure the SMTP User ID and Password if required.

 **NOTE:** Ask your network administrator or your Internet service provider for the SMTP server setting information. If the SMTP server requires authentication, you also need to know the SMTP User ID and password. SMTP server names and port names are typically easy to find by doing an Internet search. For example, use terms like “gmail smtp server name” or “yahoo smtp server name”.

- In the **Optional PIN** area, enter a PIN. This pin will be required every time an email is sent using the email address.
 - In the **E-mail Message Preferences** area, configure the message preferences.
6. To add email addresses to the address book accessible from the product, click the **E-mail Address Book** link and enter the required information. You can set up individual email addresses or email groups.
 7. To configure default options, click the **E-mail options** link. Enter the default email subject, body text, and other scan settings.
 8. Click **Save and Test** to complete the setup.



NOTE: Create additional outgoing email profiles to scan from more than one email account.

Scan to email

Use the product control panel to scan a file directly to an email address. The scanned file is sent to the address as an email message attachment.



NOTE: In order to use this feature, the product must be connected to a network and the Scan to Email feature must be configured by using the Scan to Email Setup Wizard (Windows) or the HP Embedded Web Server.

1. Load the document on the scanner glass according to the indicators on the product.
2. From the Home screen on the product control panel, touch the **Scan**  button.
3. Touch the **Scan to E-mail** item.
4. Touch the **Send an E-mail** item.
5. Select the **From** address that you want to use. This is also known as an “outgoing email profile.”



NOTE: If the PIN feature has been set up, enter the PIN and touch the **OK** button. However, a PIN is not required to use this feature.

6. Touch the **To** button and pick the address or group to which you want to send the file. Touch the **Done** button when finished.
 - To send the message to a different address, touch the **New** again and enter the email address.
7. Touch the **Subject** button if you would like to add a subject line
8. Touch the **Next** button.
9. The control panel screen displays the scan settings.
 - If you want to change any of the settings, touch the **Settings** button, and then change the settings.
 - If the settings are correct, go to the next step.
10. Touch the **Scan** button to start the scan job.

Additional scan tasks

Go to www.hp.com/support/colorljMFPM277.

Instructions are available for performing specific scan tasks, such as the following:

- How to scan a general photo or document
- How to scan as editable text (OCR)
- How to scan multiple pages into a single file

7 Fax

- [Set up to send and receive faxes](#)
- [Send a fax](#)
- [Send a fax using the HP software \(Windows\)](#)
- [Create, edit, and delete speed-dial entries](#)

For more information:

Go to www.hp.com/support/colorljMFPM277.

HP's all-inclusive help for the product includes the following information:

- Install and configure
- Learn and use
- Solve problems
- Download software updates
- Join support forums
- Find warranty and regulatory information

Set up to send and receive faxes

- [Before starting](#)
- [Step 1: Identify the phone connection type](#)
- [Step 2: Set up the fax](#)
- [Step 3: Configure the fax time, date, and header](#)
- [Step 4: Run a fax test](#)

Before starting

Make sure that the product was fully set up before connecting the fax service.



NOTE: Use the telephone cable and any adapters that shipped with the product to connect the product to the telephone jack.



NOTE: In countries/regions that use serial telephone systems, an adapter is shipped with the product. Use the adapter to connect other telecom devices to the same telephone jack the product is connected to.

Complete the instructions in each of the following four steps:

[Step 1: Identify the phone connection type on page 66.](#)

[Step 2: Set up the fax on page 67.](#)

[Step 3: Configure the fax time, date, and header on page 71.](#)

[Step 4: Run a fax test on page 72.](#)

Step 1: Identify the phone connection type

Review the following equipment and service types to determine which setup method to use. The method used depends on the equipment and services already installed on the phone system.



NOTE: The product is an analog device. HP recommends using the product on a dedicated analog telephone line.

- **Dedicated phone line:** The product is the only piece of equipment or service connected to the phone line
- **Voice calls:** Voice and fax calls use the same phone line
- **Answering machine:** An answering machine answers voice calls on the same phone line used for fax calls
- **Voice mail:** A voice-mail subscription service uses the same phone line as the fax
- **Distinctive ring service:** A service from the telephone company that allows several phone numbers to be associated with one phone line, and each number has a different ring pattern; the product detects the ring pattern assigned to it and answers the call
- **Computer dial-up modem:** A computer uses the phone line to connect to the Internet through a dial-up connection
- **DSL line:** A digital subscriber line (DSL) service from the telephone company; this service might be called ADSL in some countries/regions

- **PBX or ISDN phone system:** A private branch exchange (PBX) phone system or an integrated services digital network (ISDN) system
- **VoIP phone system:** Voice over Internet protocol (VoIP) through an Internet provider

Step 2: Set up the fax

Click the link below that best describes the environment in which the product will be sending and receiving faxes, and follow the setup instructions.

- [Dedicated phone line on page 67](#)
- [Shared voice/fax line on page 68](#)
- [Shared voice/fax line with an answering machine on page 69](#)

Instructions for only three of the connection types are included here. For more information about connecting the product with other connection types, go to the support Web site www.hp.com/support/colorljMFPM277.

 **NOTE:** This product is an analog fax device. HP recommends using the product on a dedicated analog telephone line. For a digital environment, such as DSL, PBX, ISDN, or VoIP, make sure to use the correct filters and configure the digital settings correctly. For more information, contact the digital service provider.

 **NOTE:** Do not connect more than three devices to the telephone line.

 **NOTE:** Voice mail is not supported with this product.

Dedicated phone line

Follow these steps to set up the product on a dedicated phone line with no additional services.

1. Connect the telephone cable to the fax port on the product and to the telephone jack on the wall.

 **NOTE:** Some countries/regions might require an adapter for the telephone cable that came with the product.

 **NOTE:** On some products, the fax port might be above the phone port. Refer to the icons on the product.

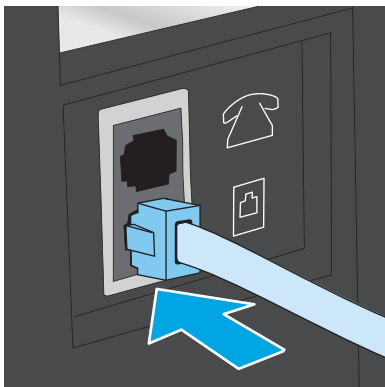

2. Set the product to answer fax calls automatically.
 - a. Turn the product on.
 - b. From the Home screen on the product control panel, touch the **Setup**  button.

- c. Touch the **Fax Setup** menu.
 - d. Touch the **Basic Setup** menu.
 - e. Touch the **Answer Mode** setting.
 - f. Touch the **Automatic** option.
3. Continue to [Step 3: Configure the fax time, date, and header on page 71](#).

Shared voice/fax line

Follow these steps to set up the product on a shared voice/fax line.

1. Disconnect any devices that are connected to the telephone jack.
2. Connect the telephone cable to the fax port on the product and to the telephone jack on the wall.

 **NOTE:** Some countries/regions might require an adapter to the telephone cable that came with the product.

 **NOTE:** On some products, the fax port might be above the phone port. Refer to the icons on the product.

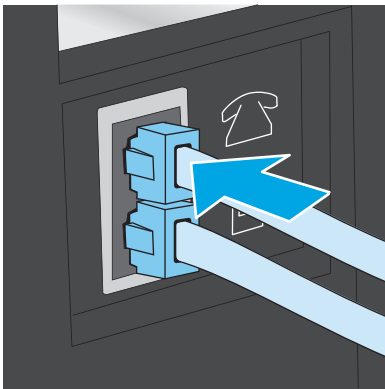

3. Remove the plug from the telephone line out port on the rear of the product, and then connect a phone to this port.
4. Set the product to answer fax calls automatically.
 - a. Turn the product on.
 - b. From the Home screen on the product control panel, touch the **Setup**  button.
 - c. Touch the **Fax Setup** menu.
 - d. Touch the **Basic Setup** menu.
 - e. Touch the **Answer Mode** setting, and then touch the **Automatic** option.
5. Set the product to check for a dial tone before sending a fax.

 **NOTE:** This prevents the product from sending a fax while someone is on the telephone.

- a. From the Home screen on the product control panel, touch the **Setup**  button.
 - b. Touch the **Fax Setup** menu.
 - c. Touch the **Advanced Setup** menu.
 - d. Touch the **Detect Dial Tone** setting, and then touch **On**.
6. Continue to [Step 3: Configure the fax time, date, and header on page 71](#).

Shared voice/fax line with an answering machine

Follow these steps to set up the product on a shared voice/fax line with an answering machine.

1. Disconnect any devices that are connected to the telephone jack.
2. Remove the plug from the telephone line out port on the rear of the product.
3. Connect the telephone cable to the fax port on the product and to the telephone jack on the wall.

 **NOTE:** Some countries/regions might require an adapter for the telephone cable that came with the product.

 **NOTE:** On some products, the fax port might be above the phone port. Refer to the icons on the product.

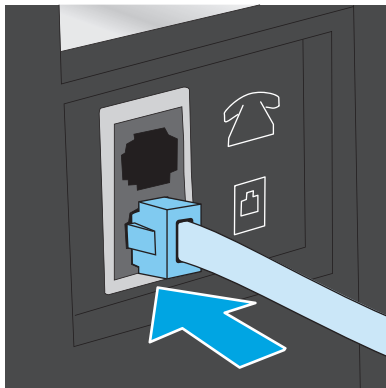

4. Connect the answering machine telephone cable to the telephone line out port on the rear of the product.



 **NOTE:** Connect the answering machine directly to the product, or the answering machine might record fax tones from a sending fax machine and the product might not receive faxes.

 **NOTE:** If the answering machine does not have a built-in telephone, connect a telephone to the **OUT** port on the answering machine for convenience.

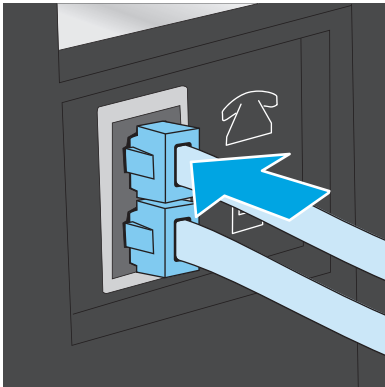

 **NOTE:** On some products, the fax port might be above the phone port. Refer to the icons on the product.



5. Configure the rings to answer setting on the product.

- a. Turn the product on.
- b. From the Home screen on the product control panel, touch the **Setup**  button.
- c. Touch the **Fax Setup** menu.
- d. Touch the **Basic Setup** menu.
- e. Touch the **Rings to Answer** option.
- f. Use the numeric keypad on the product control panel to set the number of rings to 5 or more, and then touch the **OK** button.
- g. Touch the Home  button to return to the main menu.

6. Set the product to answer fax calls automatically.

- a. From the Home screen on the product control panel, touch the **Setup**  button.
- b. Touch the **Fax Setup** menu.
- c. Touch the **Basic Setup** menu.
- d. Touch the **Answer Mode** setting, and then touch the **Automatic** option.
- e. Touch the Home  button to return to the main menu.

7. Set the product to check for a dial tone before sending a fax.

 **NOTE:** This prevents the product from sending a fax while someone is on the telephone.

- a. From the Home screen on the product control panel, touch the **Setup**  button.
 - b. Touch the **Fax Setup** menu.
 - c. Touch the **Advanced Setup** menu.
 - d. Touch the **Detect Dial Tone** setting, and then touch the **On** button.
8. Continue to [Step 3: Configure the fax time, date, and header on page 71](#).

Step 3: Configure the fax time, date, and header

Configure the product fax settings using one of the following methods:

- [HP Fax Setup Wizard on page 71](#) (recommended method)
- [Product control panel on page 71](#)
- [HP Embedded Web Server \(EWS\) and HP Device Toolbox \(Windows\) on page 72](#) (if the software is installed)

 **NOTE:** In the United States and many other countries/regions, setting the time, date, and other fax header information is a legal requirement.

HP Fax Setup Wizard

Access the Fax Setup Wizard after *initial* setup and software installation by following these steps.

1. Click **Start**, and then click **Programs**.
2. Click **HP**, click the name of the product, and then click **HP Fax Setup Wizard**.
3. Follow the on-screen instructions in the HP Fax Setup Wizard to configure the fax settings.
4. Continue to [Step 4: Run a fax test on page 72](#).

Product control panel

To use the control panel to set the date, time, and header, complete the following steps.

1. From the Home screen, touch the **Setup**  button.
2. Touch the **Fax Setup** menu.
3. Touch the **Basic Setup** menu.
4. Scroll to and touch the **Time/Date** button.
5. Select the **12-hour clock** or **24-hour clock**.
6. Use the keypad to enter the current time, and then touch the **OK** button.

 **NOTE:** Touch the **123** button to open a keypad that contains special characters, if needed.

7. Select the date format.
8. Use the keypad to enter the current date, and then touch the **OK** button.
9. Touch the **Fax Header** menu.

10. Use the keypad to enter the fax number, and then touch the **OK** button.

 **NOTE:** The maximum number of characters for the fax number is 20.

11. Use the keypad to enter the company name or header, and then touch the **OK** button.

 **NOTE:** The maximum number of characters for the fax header is 25.

12. Continue to [Step 4: Run a fax test on page 72](#).





HP Embedded Web Server (EWS) and HP Device Toolbox (Windows)

1. Start the HP EWS either from the **Start** menu or the a Web browser

Start menu

- a. Click the **Start** button, and then click the **Programs** item.
- b. Click your HP product group, and then click the **HP Device Toolbox** item.

Web browser

- a. From the Home screen on the product control panel, touch the Connection Information  /  button, and then touch the **Network Connected**  button or the **Network Wi-Fi ON**  button to display the IP address or host name.
- b. Open a Web browser, and in the address line, type the IP address or host name exactly as it displays on the product control panel. Press the **Enter** key on the computer keyboard. The EWS opens.



 **NOTE:** If the Web browser displays a **There is a problem with this website's security certificate** message when attempting to open the EWS, click **Continue to this website (not recommended)**.

Choosing Continue to this website (not recommended) will not harm the computer while navigating within the EWS for the HP product.

2. Click the **Fax** tab.
3. Follow the on-screen instructions to configure the fax settings.
4. Continue to [Step 4: Run a fax test on page 72](#).

Step 4: Run a fax test

Run a fax test to make sure that the fax is set up correctly.

1. From the Home screen, touch the **Setup**  button.
2. Scroll to and touch the **Service** menu.
3. Touch the **Fax Service** menu.
4. Touch the **Run Fax Test** option. The product prints a test report.
5. Review the report.

- If the report indicates the product **passed the test**, the product is ready to send and receive faxes.
- If the report indicates the product **failed the test**, review the report for more information about fixing the problem. The fax troubleshooting checklist has more information on resolving fax problems.

Send a fax

- [Supported fax applications](#)
- [Send a fax by dialing manually from the product control panel](#)
- [Fax from the flatbed scanner](#)
- [Fax from the document feeder](#)
- [Use speed dials and group-dial entries](#)
- [Cancel a fax](#)

Supported fax applications

The PC fax program that came with the product is the only PC fax program that works with the product. To continue to use a PC fax program previously installed on the computer, use the modem that is already connected to the computer; it will not function through the product modem.

Send a fax by dialing manually from the product control panel

1. Place the document in the document feeder or on the flatbed scanner glass.
2. On the product control panel, touch the **Fax**  button.
3. Use the keypad to enter the fax number.
4. Touch the **Start Fax** button to send the fax.

Fax from the flatbed scanner

1. Place the document face-down on the scanner glass.
2. From the Home screen on the product control panel, touch the **Fax**  button.
3. Use the keypad to enter the fax number.
4. Touch the **Start Fax** button.
5. The product prompts you to confirm that you are sending from the scanner glass. Touch the **Yes** button.
6. The product prompts you to load the first page. Touch the **OK** button.
7. The product scans the first page and then prompts you to load another page. If the document has multiple pages, touch the **Yes** button. Continue this process until you have scanned all the pages.
8. When you have scanned the last page, touch the **No** button at the prompt. The product sends the fax.

Fax from the document feeder

1. Insert the originals into the document feeder face-up.

CAUTION: To prevent damage to the product, do not use an original that contains correction tape, correction fluid, paper clips, or staples. Also, do not load photographs, small originals, or fragile originals into the document feeder.

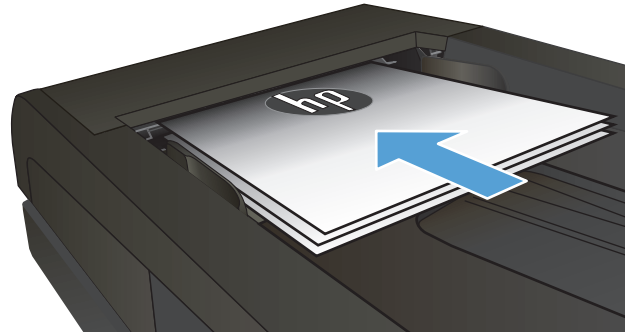

2. Adjust the paper guides until they are snug against the paper.

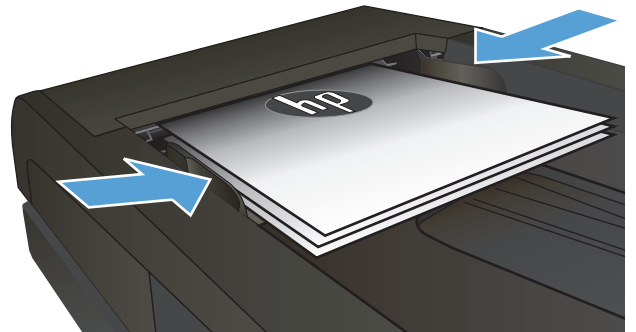



3. From the Home screen on the product control panel, touch the **Fax**  button.
4. Use the keypad to enter the fax number.
5. Touch the **Start Fax** button.

Use speed dials and group-dial entries

 **NOTE:** Phone book entries must be set up using the **Fax Menu** prior to using the phone book to send faxes.

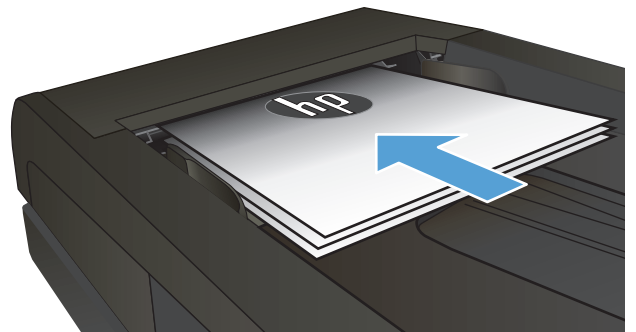
1. Load the document onto the scanner glass or into the document feeder.



2. From the Home screen on the product control panel, touch the **Fax**  button.
3. On the keypad, touch the fax phone book icon.
4. Touch the name of the individual or group entry that you want to use.
5. Touch the **Start Fax** button.

Cancel a fax

Cancel the current fax

- ▲ Touch the **Cancel** button on the control panel. Any pages that have not been transmitted are canceled. Touching the **Cancel** button also stops group-dial jobs.

Cancel a pending fax job

Use this procedure to cancel a fax job in the following situations:

The product is waiting to redial after encountering a busy signal, an unanswered call, or a communication error.

The fax is scheduled to be sent at a future time.

1. From the Home screen, touch the **Fax**  button.
2. Touch the **Fax Menu** button.
3. Touch the **Send Options** button.
4. Touch the **Fax Job Status** button.
5. Touch the fax number for the job that you want to cancel.

Send a fax using the HP software (Windows)

1. Load the document.
 - If you are loading an original on the scanner glass, place it on the scanner glass face-down, in the left rear corner of the scanner glass.
 - If you are loading multiple pages in the document feeder, load the pages face-up, and then adjust the paper guides until they are snug against the paper.
-
-  **NOTE:** If documents are in the document feeder and on the scanner glass at the same time, the product processes the document in the document feeder and not the one on the scanner glass.
2. Click **Start**, click **Programs** (or **All Programs** in Windows XP), and then click **HP**.
 3. Click the product name, and then click **HP Send Fax**. The fax software opens.
 4. Enter the fax number of one or more recipients.
 5. Click **Send Now**.

Create, edit, and delete speed-dial entries

You can store frequently dialed fax numbers (up to 120 entries) either as individual fax numbers or as groups of fax numbers.

- [Use the control panel to create and edit the fax phone book](#)
- [Use phone-book data from other programs](#)
- [Delete phone book entries](#)

Use the control panel to create and edit the fax phone book

1. From the Home screen on the product control panel, touch the **Fax** button.
2. Touch the **Fax Menu** button.
3. Touch the **Phone Book Setup** button.
4. Touch the **Individual Setup** button or the **Group Setup** button to create a speed dial entry.
5. Touch an unassigned number from the list.
6. Use the keypad to enter a name for the entry, and then touch the **OK** button.
7. Use the keypad to enter the fax number for the entry, and then touch the **OK** button.

Use phone-book data from other programs

 **TIP:** Before a phone book from another program can be imported, you must use the export feature in that other program.

HP Device Toolbox can import contact information from the following software program phone books.

- Microsoft Outlook
- Lotus Notes
- Microsoft Outlook Express
- A phone book previously exported from another HP product's Device Toolbox software

Delete phone book entries

You can delete all phone book entries that are programmed in the product.

 **CAUTION:** After phone book entries are deleted, they cannot be recovered.

1. From the Home screen on the product control panel, touch the **Fax** button.
2. Touch the **Fax Menu** button.
3. Touch the **Phone Book Setup** button.
4. Touch the **Delete Entry** button. Or, to delete all the entries, touch the **Delete All Entries** button.
5. Touch the entry that you want to delete.
6. Touch the **OK** button to confirm the deletion.

8 Manage the product

- [Use HP Web Services applications](#)
- [Change the product connection type \(Windows\)](#)
- [Advanced configuration with HP Embedded Web Server \(EWS\) and HP Device Toolbox \(Windows\)](#)
- [Advanced configuration with HP Utility for OS X](#)
- [Configure IP network settings](#)
- [Product security features](#)
- [Economy settings](#)
- [HP Web Jetadmin](#)
- [Update the firmware](#)

For more information:

Go to www.hp.com/support/colorljMFPM277.

HP's all-inclusive help for the product includes the following information:

- Install and configure
- Learn and use
- Solve problems
- Download software updates
- Join support forums
- Find warranty and regulatory information

Use HP Web Services applications

Several innovative applications are available for this product that you can download directly from the Internet. For more information and to download these applications go to the HP Connected Web site at www.hpconnected.com.

To use this feature, the product must be connected to a computer or network that has an Internet connection. HP Web Services must be enabled on the product.

1. From the Home screen on the product control panel, touch the Connection Information  button.
2. Open the following menus:
 - [ePrint](#)
 - [Settings](#)
3. Touch the [Enable Web Services](#) button.

After you download an application from the HP Connected Web site, it is available in the [Apps](#) menu on the product control panel. This process enables both HP Web Services and the [Apps](#)  button.

Change the product connection type (Windows)

If you are already using the product and you wish to change the way it is connected, use the **Reconfigure your HP Device** shortcut on your computer desktop to change the connection. For example, you can reconfigure the product to use a different wireless address, to connect to a wired or wireless network, or change from a network connection to a USB connection. You can change the configuration without inserting the product CD. After you select the type of connection you wish to make, the program goes directly to the portion of the product setup procedure that needs to change.

Advanced configuration with HP Embedded Web Server (EWS) and HP Device Toolbox (Windows)

Use the HP Embedded Web Server to manage printing functions from your computer instead of the product control panel.

- View product status information
- Determine the remaining life for all supplies and order new ones
- View and change tray configurations
- View and change the product control-panel menu configuration
- View and print internal pages
- Receive notification of product and supplies events
- View and change network configuration

The HP Embedded Web Server works when the product is connected to an IP-based network. The HP Embedded Web Server does not support IPX-based product connections. You do not have to have Internet access to open and use the HP Embedded Web Server.

When the product is connected to the network, the HP Embedded Web Server is automatically available.





 **NOTE:** HP Device Toolbox is available only if you performed a full installation when you installed the product. Depending on how the product is connected, some features might not be available.

 **NOTE:** The HP Embedded Web Server is not accessible beyond the network firewall.

Open the HP Embedded Web Server (EWS) from the Start menu

1. Click the **Start** button, and then click the **Programs** item.
2. Click your HP product group, and then click the **HP Device Toolbox** item.

Open the HP Embedded Web Server (EWS) from a Web browser

1. From the Home screen on the product control panel, touch the Connection Information  /  button, and then touch the **Network Connected**  button or the **Network Wi-Fi ON**  button to display the IP address or host name.
2. Open a Web browser, and in the address line, type the IP address or host name exactly as it displays on the product control panel. Press the **Enter** key on the computer keyboard. The EWS opens.

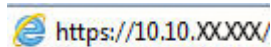
 <https://10.10.XX.XXX/>

 **NOTE:** If the Web browser displays a **There is a problem with this website's security certificate** message when attempting to open the EWS, click **Continue to this website (not recommended)**.

Choosing **Continue to this website (not recommended)** will not harm the computer while navigating within the EWS for the HP product.

Tab or section	Description
<p>Home tab</p> <p>Provides product, status, and configuration information.</p>	<ul style="list-style-type: none"> • Device Status: Shows the product status and shows the approximate percent life remaining of HP supplies. • Supplies Status: Shows the approximate percent life remaining of HP supplies. Actual supply life remaining can vary. Consider having a replacement supply available to install when print quality is no longer acceptable. The supply does not need to be replaced unless the print quality is no longer acceptable. • Device Configuration: Shows the information found on the product configuration page. • Network Summary: Shows the information found on the product network configuration page. • Reports: Print the configuration and supplies status pages that the product generates. • Event Log: Shows a list of all product events and errors.
<p>System tab</p> <p>Provides the ability to configure the product from your computer.</p>	<ul style="list-style-type: none"> • Device Information: Provides basic product and company information. • Paper Setup: Change the default paper-handling settings for the product. • Print Quality: Change the default print-quality settings for the product. • EcoSMART Console: Change the default times for entering Sleep mode or Auto Power Down mode. Configure which events cause the product to wake. • Paper Types: Configure print modes that correspond to the paper types that the product accepts. • System Setup: Change the system defaults for the product. • Service: Perform the cleaning procedure on the product. • Save and Restore: Save the current settings for the product to a file on the computer. Use this file to load the same settings onto another product or to restore these settings to this product at a later time. • Administration: Set or change the product password. Enable or disable product features. <p>NOTE: The System tab can be password-protected. If this product is on a network, always consult with the administrator before changing settings on this tab.</p>
<p>Print tab</p> <p>Provides the ability to change default print settings from your computer.</p>	<ul style="list-style-type: none"> • Printing: Change the default product print settings, such as number of copies and paper orientation. These are the same options that are available on the control panel. • PCL5c: View and change the PCL5c settings. • PostScript: Turn off or on the Print PS Errors feature.
<p>Fax tab</p> <p>(Fax products only)</p>	<ul style="list-style-type: none"> • Receive Options: Configure how the product handles incoming faxes. • Phone Book: Add or delete entries in the fax phone book. • Junk Fax List: Set fax numbers to block from sending faxes to the product. • Fax Activity Log: Review recent fax activity for the product.

Tab or section	Description
<p>Scan tab</p> <p>(MFP models only)</p>	<p>Configure the Scan to Network Folder and Scan to E-mail features.</p> <ul style="list-style-type: none"> • Network Folder Setup: Configure folders on the network to which the product can save a scanned file. • Scan to E-mail Setup: Begin the process to set up the Scan to E-mail feature. • Outgoing E-mail Profiles: Set an email address that will appear as the “from” address for all emails sent from the product. Configure the SMTP Server information. • E-mail Address Book: Add or delete entries in the email address book. • E-mail Options: Configure a default subject line and body text. Configure default scan settings for emails.
<p>Networking tab</p> <p>(Network-connected products only)</p> <p>Provides the ability to change network settings from your computer.</p>	<p>Network administrators can use this tab to control network-related settings for the product when it is connected to an IP-based network. It also allows the network administrator to set up Wireless Direct functionality. This tab does not appear if the product is directly connected to a computer.</p>
<p>HP Web Services tab</p>	<p>Use this tab to set up and use various Web tools with the product.</p>

Advanced configuration with HP Utility for OS X

Use the HP Utility to check product status or to view or change product settings from your computer.

You can use the HP Utility when the product is connected with a USB cable or is connected to a TCP/IP-based network.

Open HP Utility

1. At the computer, open the **System Preferences** menu, and then click **Print & Fax, Print & Scan, or Printers & Scanners**.
2. Select the product in the list.
3. Click the **Options & Supplies** button.
4. Click the **Utility** tab.
5. Click the **Open Printer Utility** button.

HP Utility features

The HP Utility toolbar includes these items:

- **Devices:** Click this button to show or hide Mac products found by the HP Utility.
- **All Settings:** Click this button to return to the HP Utility main view.
- **HP Support:** Click this button to open a browser and go to the HP support Web site.
- **Supplies:** Click this button to open the HP SureSupply Web site.
- **Registration:** Click this button to open the HP registration Web site.
- **Recycling:** Click this button to open the HP Planet Partners Recycling Program Web site.

HP Utility consists of pages that you open by clicking in the **All Settings** list. The following table describes the tasks that you can perform with HP Utility.

Item	Description
Supplies Status	Show the product supplies status and provides links for ordering supplies online.
Device Information	Show information about the currently selected product, including the product Service ID (if assigned), the firmware version (FW Version), the Serial Number, and the IP address.
Commands	Send special characters or print commands to the product after the print job. NOTE: This option is available only after you open the View menu and select the Show Advanced Options item.
Color Usage (Color products only)	Show information about color jobs that the product has produced.

Item	Description
File Upload	Transfer files from the computer to the product. You can upload the following types of files: <ul style="list-style-type: none"> HP LaserJet printer command language (.PRN) Portable document format (.PDF) Postscript (.PS) Text (.TXT)
Power Management	Configure the product economy settings.
Update Firmware	Transfer a firmware update file to the product. NOTE: This option is available only after you open the View menu and select the Show Advanced Options item.
HP Connected	Access the HP Connected Web site.
Upload Fonts	Upload fonts from the computer to the product.
Message Center	Display error events that have occurred with the product.
Duplex Mode	Turn on the automatic two-sided printing mode.
Network Settings (Network-connected products only)	Configure the network settings, such as the IPv4 settings, IPv6 settings, Bonjour settings, and other settings.
Supplies Management	Configure how the product should behave when supplies are nearing the end of their estimated life.
Trays Configuration	Change paper size and type for each of the trays.
Additional Settings	Open the HP Embedded Web Server (EWS) for the product. NOTE: USB connections are not supported.
Proxy Server Settings	Configure a proxy server for the product.
Basic Fax Settings (MFP fax models only)	Set up the fields in the fax header and configure how the product answers incoming calls.
Fax Forwarding (MFP fax models only)	: Set up the product to send the incoming faxes to a different number.
Fax Logs (MFP fax models only)	View the logs of all faxes.
Fax Speed Dials (MFP fax models only)	Add fax numbers to the speed dial list.
Junk Fax Blocking (MFP fax models only)	Store the fax numbers you want to block.

Item	Description
Scan to E-mail (MFP products only)	Open the HP Embedded Web Server (EWS) page for configuring settings for scanning to email.
Scan to Network Folder (MFP products only)	Open the HP Embedded Web Server (EWS) page for configuring settings for scanning to a network folder.

Configure IP network settings

Introduction

Use the following sections to configure the product network settings.





- [Printer sharing disclaimer](#)
- [View or change network settings](#)
- [Rename the product on a network](#)
- [Manually configure IPv4 TCP/IP parameters from the control panel](#)

Printer sharing disclaimer

HP does not support peer-to-peer networking, as the feature is a function of Microsoft operating systems and not of the HP printer drivers. Go to Microsoft at www.microsoft.com.

View or change network settings

Use the HP Embedded Web Server to view or change IP configuration settings.

1. Open the HP Embedded Web Server (EWS):
 - a. From the Home screen on the product control panel, touch the Connection Information  /  button, and then touch the **Network Connected**  button or the **Network Wi-Fi ON**  button to display the IP address or host name.
 - b. Open a Web browser, and in the address line, type the IP address or host name exactly as it displays on the product control panel. Press the **Enter** key on the computer keyboard. The EWS opens.

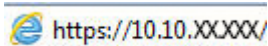





 **NOTE:** If the Web browser displays a **There is a problem with this website's security certificate** message when attempting to open the EWS, click **Continue to this website (not recommended)**.

Choosing **Continue to this website (not recommended)** will not harm the computer while navigating within the EWS for the HP product.

2. Click the **Networking** tab to obtain network information. Change settings as needed.

Rename the product on a network

If you want to rename the product on a network so that it can be uniquely identified, use the HP Embedded Web Server.

1. Open the HP Embedded Web Server (EWS):
 - a. From the Home screen on the product control panel, touch the Connection Information  /  button, and then touch the **Network Connected**  button or the **Network Wi-Fi ON**  button to display the IP address or host name.

- b. Open a Web browser, and in the address line, type the IP address or host name exactly as it displays on the product control panel. Press the **Enter** key on the computer keyboard. The EWS opens.



 **NOTE:** If the Web browser displays a **There is a problem with this website's security certificate** message when attempting to open the EWS, click **Continue to this website (not recommended)**.

Choosing **Continue to this website (not recommended)** will not harm the computer while navigating within the EWS for the HP product.

2. Open the **System** tab.
3. On the **Device Information** page, the default product name is in the **Device Status** field. You can change this name to uniquely identify this product.

 **NOTE:** Completing the other fields on this page is optional.

4. Click the **Apply** button to save the changes.

Manually configure IPv4 TCP/IP parameters from the control panel

Use the control-panel menus to manually set an IPv4 address, subnet mask, and default gateway.

1. From the Home screen on the product control panel, touch the **Setup**  button.
2. Scroll to and touch the **Network Setup** menu.
3. Touch the **IPv4 Config Method** menu, and then touch the **Manual** button.
4. Use the keypad on the touchscreen to enter the IP address, and touch the **OK** button. Touch the **Yes** button to confirm.
5. Use the keypad on the touchscreen to enter the subnet mask, and touch the **OK** button. Touch the **Yes** button to confirm.
6. Use the keypad on the touchscreen to enter the default gateway, and touch the **OK** button. Touch the **Yes** button to confirm.

Product security features





Introduction

The product includes several security features to restrict who has access to configuration settings, to secure data, and to prevent access to valuable hardware components.

- [Assign or change the system password using the Embedded Web Server](#)

Assign or change the system password using the Embedded Web Server

Assign an administrator password for access to the product and the HP Embedded Web Server so that unauthorized users cannot change the product settings.

1. Open the HP Embedded Web Server (EWS):
 - a. From the Home screen on the product control panel, touch the Connection Information  /  button, and then touch the **Network Connected**  button or the **Network Wi-Fi ON**  button to display the IP address or host name.
 - b. Open a Web browser, and in the address line, type the IP address or host name exactly as it displays on the product control panel. Press the **Enter** key on the computer keyboard. The EWS opens.

 <https://10.10.XXXXX/>

 **NOTE:** If the Web browser displays a **There is a problem with this website's security certificate** message when attempting to open the EWS, click **Continue to this website (not recommended)**.

Choosing **Continue to this website (not recommended)** will not harm the computer while navigating within the EWS for the HP product.

2. Click the **Security** tab.
3. Open the **General Security** menu.
4. In the area labeled **Set the Local Administrator Password**, enter the name to associate with the password in the **Username** field.
5. Enter the password in the **New Password** field, and then enter it again in the **Verify Password** field.

 **NOTE:** To change an existing password, first enter the existing password in the **Old Password** field.

6. Click the **Apply** button.

 **NOTE:** Make note of the password and store it in a safe place.

Economy settings

Introduction

The product includes several economy features to conserve energy and supplies.

- [Print with EconoMode](#)
- [Configure the Sleep/Auto Off After setting](#)
- [Set the Shut Down After delay and configure the product to use 1 watt or less of power](#)
- [Configure the Delay Shut Down setting](#)

Print with EconoMode

This product has an EconoMode option for printing drafts of documents. Using EconoMode can use less toner. However, using EconoMode can also reduce print quality.

HP does not recommend the full-time use of EconoMode. If EconoMode is used full-time, the toner supply might outlast the mechanical parts in the toner cartridge. If print quality begins to degrade and is no longer acceptable, consider replacing the toner cartridge.

 **NOTE:** If this option is not available in your print driver, you can set it using the HP Embedded Web Server.

1. From the software program, select the **Print** option.
2. Select the product, and then click the **Properties** or **Preferences** button.
3. Click the **Paper/Quality** tab.
4. Click the **EconoMode** check box.

Configure the Sleep/Auto Off After setting

1. From the Home screen on the product control panel, touch the **Setup**  button.
2. Open the following menus:
 - [System Setup](#)
 - [Energy Settings](#)
 - [Sleep/Auto Off After](#)
3. Select the time for the Sleep/Auto Off After delay.

Set the Shut Down After delay and configure the product to use 1 watt or less of power

 **NOTE:** After the product shuts down, the power consumption is 1 watt or less.

1. From the Home screen on the product control panel, touch the **Setup**  button.
2. Open the following menus:

- [System Setup](#)
 - [Energy Settings](#)
 - [Shut Down After](#)
3. Select the time for the Shut Down After delay.



NOTE: The default value is 4 hours.

Configure the Delay Shut Down setting

1. On the product control panel, touch the [Setup](#)  button.
2. Open the following menus:
 - [System Setup](#)
 - [Energy Settings](#)
 - [Delay Shut Down](#)
3. Select one of the delay options:
 - **No Delay:** The product shuts down after a period of inactivity determined by the Shut Down After setting.
 - **When Ports Are Active:** When this option is selected the product will not shut down unless all ports are inactive. An active network link or fax connection will prevent the product from shutting down.

HP Web Jetadmin

HP Web Jetadmin is an award-winning, industry-leading tool for efficiently managing a wide variety of networked HP products, including printers, multifunction products, and digital senders. This single solution allows you to remotely install, monitor, maintain, troubleshoot, and secure your printing and imaging environment — ultimately increasing business productivity by helping you save time, control costs, and protect your investment.

HP Web Jetadmin upgrades are periodically made available to provide support for specific product features. Go to www.hp.com/go/webjetadmin and click the **Self Help and Documentation** link to learn more about upgrades.

Update the firmware

HP offers periodic product updates, new Web Services apps, and new features to existing Web Services apps. Follow these steps to update the product firmware for a single product. When you update the firmware, Web Service apps will update automatically.

There are two supported methods to perform a firmware update on this product. Use only one of the following methods to update the product firmware.

Method one: Update the firmware using the control panel

Use these steps to load the firmware from the control panel (for network-connected products only), and/or set the product to automatically load future firmware updates. For USB-connected products, skip to method two.

1. Make sure the product is connected to a wired (Ethernet) or wireless network with an active Internet connection.

 **NOTE:** The product must be connected to the internet to update the firmware via a network connection.

2. From the Home screen on the product control panel, open the [Setup](#) menu.
 - For touchscreen control panels, touch the Setup  button.
 - For standard control panels, press the left or right arrow button.
3. Scroll to and open the [Service](#) menu, and then open the [LaserJet Update](#) menu.

 **NOTE:** If the [LaserJet Update](#) option is not listed, use method two.

4. Check for updates.
 - For touchscreen control panels, touch [Check for Updates Now](#).
 - For standard control panels, select **Check for Update**.

 **NOTE:** The product automatically checks for an update, and if a newer version is detected, the update process automatically starts.

5. Set the product to automatically update the firmware when updates become available.

From the Home screen on the product control panel, open the [Setup](#) menu.

- For touchscreen control panels, touch the Setup  button.
- For standard control panels, press the left or right arrow button.

Scroll to and open the [Service](#) menu, open the [LaserJet Update](#) menu, and then select the [Manage Updates](#) menu.

Set the product to automatically update the firmware.

- For touchscreen control panels, set the [Allow Updates](#) option to **YES**, and then set the [Check automatically](#) option to **ON**.
- For standard control panels, set the **Allow Updates** option to **YES**, and then set the **Automatic Check** option to **ON**.

Method two: Update the firmware using the Firmware Update Utility

Use these steps to manually download and install the Firmware Update Utility from HP.com.



NOTE: This method is the only firmware update option available for products connected to the computer via a USB cable. It also works for products connected to a network.

1. Go to www.hp.com/go/support, click the **Drivers & Software** link, type the product name in the search field, press the **ENTER** button, and then select the product from the list of search results.
2. Select the operating system.
3. Under the **Firmware** section, locate the **Firmware Update Utility**.
4. Click **Download**, click **Run**, and then click **Run** again.
5. When the utility launches, select the product from the drop-down list, and then click **Send Firmware**.



NOTE: To print a configuration page to verify the installed firmware version before or after the update process, click **Print Config**.

6. Follow the on-screen instructions to complete the installation, and then click the **Exit** button to close the utility.

9 Solve problems

- [Customer support](#)
- [Control panel help system](#)
- [Restore the factory-set defaults](#)
- [A “Cartridge is low” or “Cartridge is very low” message displays on the product control panel](#)
- [Product does not pick up paper or misfeeds](#)
- [Clear paper jams](#)
- [Improve print quality](#)
- [Improve copy and scan image quality](#)
- [Improve fax image quality](#)
- [Solve wired network problems](#)
- [Solve wireless network problems](#)
- [Solve fax problems](#)

For more information:

Go to www.hp.com/support/colorljMFPM277.

HP's all-inclusive help for the product includes the following information:

- Install and configure
- Learn and use
- Solve problems
- Download software updates
- Join support forums
- Find warranty and regulatory information

Customer support

Get telephone support for your country/region	Country/region phone numbers are on the flyer that was in the box with your product or at www.hp.com/support/
Have the product name, serial number, date of purchase, and problem description ready	
Get 24-hour Internet support, and download software utilities and drivers	www.hp.com/support/colorljMFPM277
Order additional HP service or maintenance agreements	www.hp.com/go/carepack
Register your product	www.register.hp.com

Control panel help system

The product has a built-in Help system that explains how to use each screen. To open the Help system, touch the Help  button in the upper-right corner of the screen.

For some screens, the Help opens to a global menu where you can search for specific topics. You can browse through the menu structure by touching the buttons in the menu.

Some Help screens include animations that guide you through procedures, such as clearing jams.

For screens that contain settings for individual jobs, the Help opens to a topic that explains the options for that screen.

If the product alerts you of an error or warning, touch the Help  button to open a message that describes the problem. The message also contains instructions to help solve the problem.

Restore the factory-set defaults

Restoring the factory-set defaults returns all of the product and network settings to the factory defaults. It will not reset the page count, tray size, or language. To restore the product to the factory-default settings, follow these steps.

⚠ CAUTION: Restoring the factory-set defaults returns all of the settings to the factory defaults, and it also deletes any pages that are stored in the memory.

1. On the product control panel, touch the Setup  button.
2. Scroll to and touch the **Service** menu.
3. Scroll to and touch the **Restore Defaults** button, and then touch the **OK** button.

The product automatically restarts.

A “Cartridge is low” or “Cartridge is very low” message displays on the product control panel

Cartridge is low: The product indicates when a toner cartridge level is low. Actual toner cartridge life remaining may vary. Consider having a replacement available to install when print quality is no longer acceptable. The toner cartridge does not need to be replaced now.

Cartridge is very low: The product indicates when the toner cartridge level is very low. Actual toner cartridge life remaining may vary. Consider having a replacement available to install when print quality is no longer acceptable. The toner cartridge does not need to be replaced now unless the print quality is no longer acceptable.

Once an HP toner cartridge has reached **Very Low**, HP’s Premium Protection Warranty on that toner cartridge has ended.

Change the “Very Low” settings

You can change the way the product reacts when supplies reach the Very Low state. You do not have to re-establish these settings when you install a new toner cartridge.

1. From the Home screen on the product control panel, touch the Setup  button.
2. Open the following menus:
 - [System Setup](#)
 - [Supply Settings](#)
 - [Black Cartridge](#) or [Color Cartridges](#)
 - [Very Low Setting](#)
3. Select one of the following options:
 - Select the [Continue](#) option to set the product to alert you that the toner cartridge is very low, but to continue printing.
 - Select the [Stop](#) option to set the product to stop printing until you replace the toner cartridge.
 - Select the [Prompt](#) option to set the product to stop printing and prompt you to replace the toner cartridge. You can acknowledge the prompt and continue printing. A customer configurable option on this product is "Prompt to Remind Me in 100 pages, 200 pages, 300 pages, 400 pages, or never." This option is provided as a customer convenience and is not an indication these pages will have acceptable print quality.

For products with fax capability

When the product is set to the [Stop](#) or [Prompt](#) option, there is some risk that faxes will not print when the product resumes printing. This can occur if the product has received more faxes than the memory can hold while the product is waiting.

The product can print faxes without interruption when it passes the Very Low threshold if you select the [Continue](#) option for the toner cartridge, but print quality might degrade.

Order supplies

Order supplies and paper	www.hp.com/go/suresupply
Order through service or support providers	Contact an HP-authorized service or support provider.
Order using the HP Embedded Web Server (EWS)	To access, in a supported Web browser on your computer, enter the product IP address or host name in the address/URL field. The EWS contains a link to the HP SureSupply Web site, which provides options for purchasing Original HP supplies.

Product does not pick up paper or misfeeds

Introduction

The following solutions can help solve problems if the product is not picking up paper from the tray or is picking up multiple sheets of paper at one time.

- [The product does not pick up paper](#)
- [The product picks up multiple sheets of paper](#)
- [The document feeder jams, skews, or picks up multiple sheets of paper](#)

The product does not pick up paper

If the product does not pick up paper from the tray, try these solutions.

1. Open the product and remove any jammed sheets of paper.
2. Load the tray with the correct size of paper for your job.
3. Make sure the paper size and type are set correctly on the product control panel.
4. Make sure the paper guides in the tray are adjusted correctly for the size of paper. Adjust the guides to the appropriate indentation in the tray.
5. Check the product control panel to see if the product is waiting for you to acknowledge a prompt to feed the paper manually. Load paper, and continue.
6. The rollers above the tray might be contaminated. Clean the rollers with a lint-free cloth dampened with warm water.

The product picks up multiple sheets of paper

If the product picks up multiple sheets of paper from the tray, try these solutions.

1. Remove the stack of paper from the tray and flex it, rotate it 180 degrees, and flip it over. *Do not fan the paper.* Return the stack of paper to the tray.
2. Use only paper that meets HP specifications for this product.
3. Use paper that is not wrinkled, folded, or damaged. If necessary, use paper from a different package.
4. Make sure the tray is not overfilled. If it is, remove the entire stack of paper from the tray, straighten the stack, and then return some of the paper to the tray.
5. Make sure the paper guides in the tray are adjusted correctly for the size of paper. Adjust the guides to the appropriate indentation in the tray.
6. Make sure the printing environment is within recommended specifications.

The document feeder jams, skews, or picks up multiple sheets of paper



NOTE: This information applies to MFP products only.

- The original might have something on it, such as staples or self-adhesive notes, that must be removed.
- Check that all rollers are in place and that the roller-access cover inside the document feeder is closed.

- Make sure that the top document-feeder cover is closed.
- The pages might not be placed correctly. Straighten the pages and adjust the paper guides to center the stack.
- The paper guides must be touching the sides of the paper stack to work correctly. Make sure that the paper stack is straight and the guides are against the paper stack.
- The document feeder input tray or output bin might contain more than the maximum number of pages. Make sure the paper stack fits below the guides in the input tray, and remove pages from the output bin.
- Verify that there are no pieces of paper, staples, paper clips, or other debris in the paper path.
- Clean the document-feeder rollers and the separation pad. Use compressed air or a clean, lint-free cloth moistened with warm water. If misfeeds still occur, replace the rollers.
- From the Home screen on the product control panel, scroll to and touch the [Supplies](#) button. Check the status of the document-feeder kit, and replace it if necessary.

Clear paper jams



Introduction

The following information includes instructions for clearing paper jams from the product.

- [Experiencing frequent or recurring paper jams?](#)
- [Paper jam locations](#)
- [Clear paper jams in the document feeder](#)
- [Clear paper jams in the single-sheet slot \(Tray 1\)](#)
- [Clear paper jams in Tray 2](#)
- [Clear paper jams in the rear door and the fuser area](#)
- [Clear paper jams in the output bin](#)
- [Clear paper jams in the duplexer \(duplex models only\)](#)

Experiencing frequent or recurring paper jams?

Follow these steps to solve problems with frequent paper jams. If the first step does not resolve the problem continue with the next step until you have resolved the problem.

1. If paper has jammed in the product, clear the jam and then print a configuration page to test the product.
2. Check that the tray is configured for the correct paper size and type on the product control panel. Adjust paper settings if necessary.
 - a. On the product control panel, press or touch the Setup  button.
 - b. Open the [System Setup](#) menu.
 - c. Open the [Paper setup](#) menu.
 - d. Select the tray from the list.
 - e. Select [Paper Type](#) and then select the type of paper that is in the tray.
 - f. Select [Paper Size](#) and then select the size of paper that is in the tray.
3. Turn the product off, wait 30 seconds, and then turn it on again.
4. Print a cleaning page to remove excess toner from inside the product.
 - a. On the product control panel, press or touch the Setup  button.
 - b. Open the [Service](#) menu.
 - c. Select [Cleaning Page](#).

- d. Load plain letter or A4 paper when you are prompted.
- e. Touch the **OK** button to begin the cleaning process.

The product prints the first side and then prompts you to remove the page from the output bin and reload it in Tray 1, keeping the same orientation. Wait until the process is complete. Discard the page that prints.

- 5. Print a configuration page to test the product.
 - a. On the product control panel, press or touch the Setup  button.
 - b. Open the **Reports** menu.
 - c. Select **Configuration Report**.

If none of these steps resolves the problem, the product might need service. Contact HP customer support.

Paper jam locations

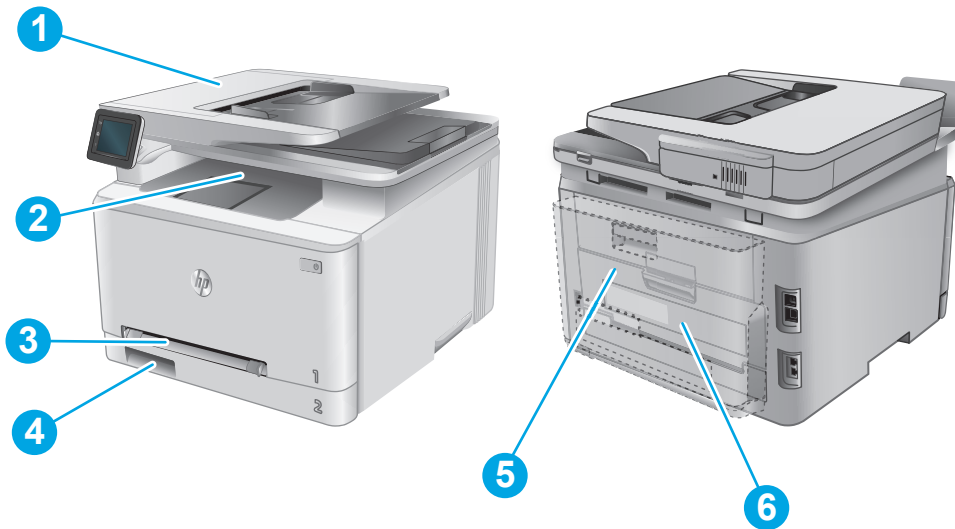

1	Document feeder	See Clear paper jams in the document feeder on page 107 .
2	Output bin	See Clear paper jams in the output bin on page 115 .
3	Single-sheet priority feed slot (Tray 1)	See Clear paper jams in the single-sheet slot (Tray 1) on page 109 .
4	Tray 2	See Clear paper jams in Tray 2 on page 111 .
5	Rear door and fuser area	See Clear paper jams in the rear door and the fuser area on page 113 .
6	Duplexer (duplex models only)	See Clear paper jams in the duplexer (duplex models only) on page 116 .

Clear paper jams in the document feeder

The following information describes how to clear paper jams in the document feeder. When a jam occurs, the control panel displays an animation that assists in clearing the jam.

1. Open the document-feeder cover.

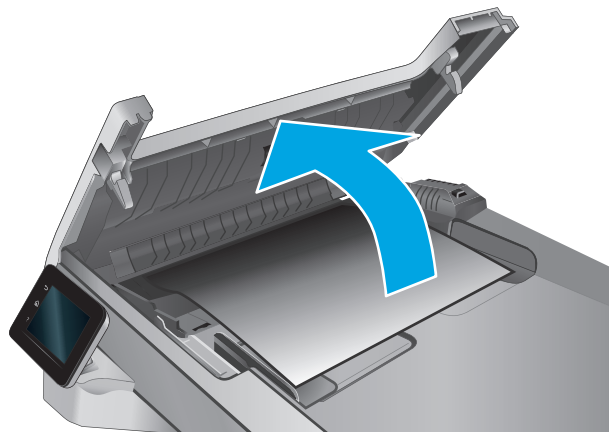

2. Remove any jammed paper.

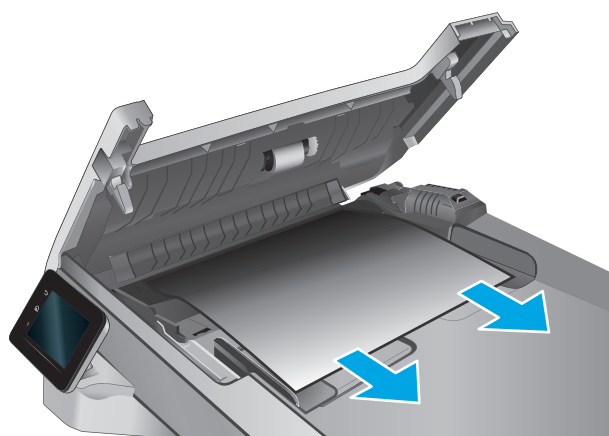

3. Close the scanner lid.

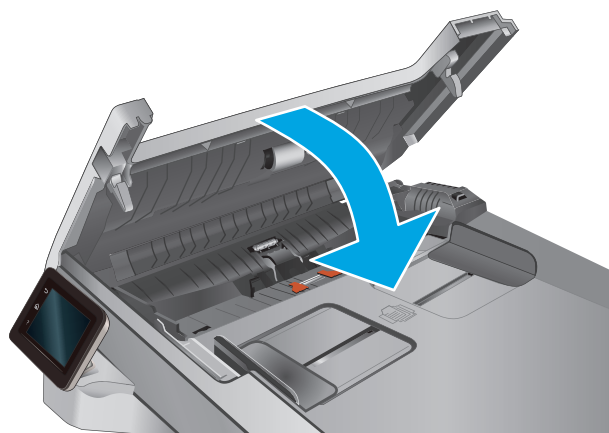

4. Lift the document feeder input tray to provide better access to the document feeder output bin, and then remove any jammed paper from the output area.



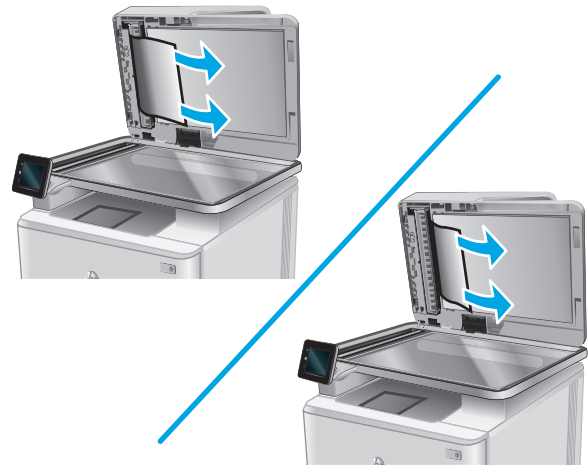

5. Open the scanner lid. If paper is jammed behind the white plastic backing, gently pull it out.



6. Lower the scanner lid.



 **NOTE:** To avoid jams, make sure the guides in the document-feeder input tray are adjusted tightly against the document. Remove all staples and paper clips from original documents.

 **NOTE:** Original documents that are printed on heavy, glossy paper can jam more frequently than originals that are printed on plain paper.

Clear paper jams in the single-sheet slot (Tray 1)

When a jam occurs, the control panel displays an animation that assists in clearing the jam.

1. Pull Tray 2 completely out of the product.

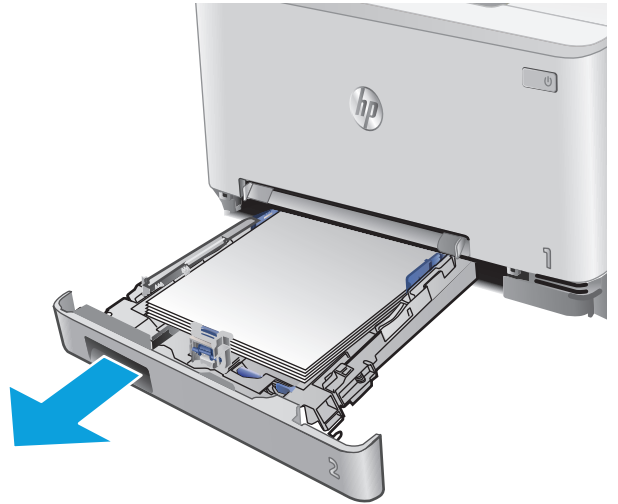

2. Push down on the single-sheet priority feed slot, and then pull out the feed slot tray.

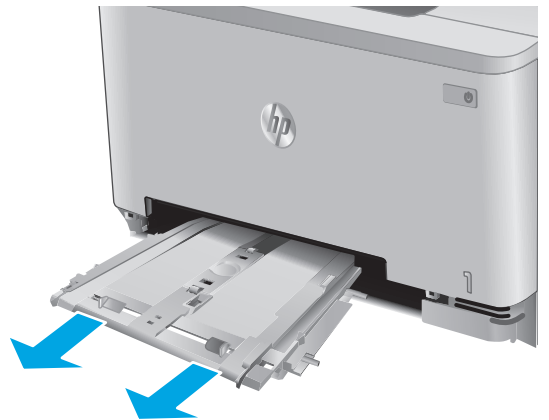

3. Gently pull any jammed paper straight out of the single-sheet priority feed slot.

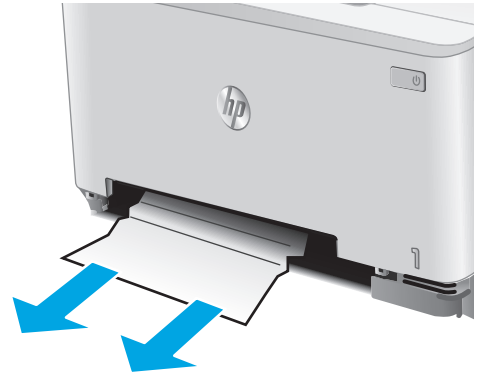

4. Push the single-sheet priority feed slot tray into the product.



5. Reinsert and close Tray 2.



Clear paper jams in Tray 2

Use the following procedure to check for a paper jam in Tray 2. When a jam occurs, the control panel displays an animation that assists in clearing the jam.

1. Pull the tray completely out of the product.

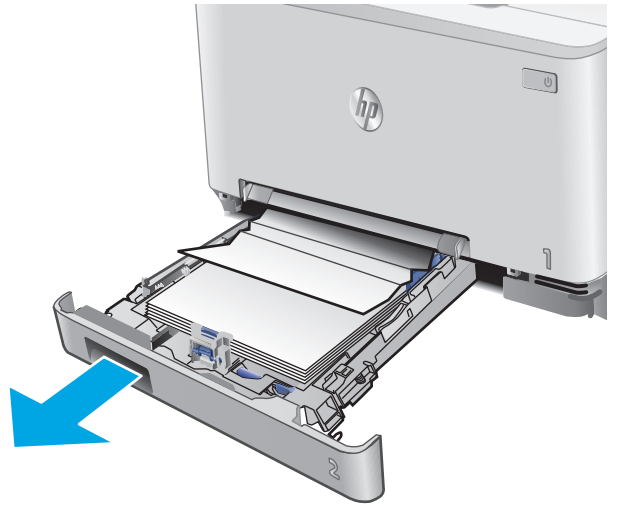

2. Remove any jammed or damaged sheets of paper.

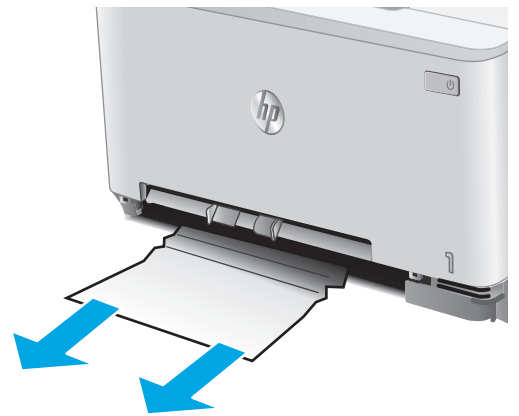

3. If no jammed paper is visible, or if jammed paper is deep enough in the Tray 2 cavity that it is difficult to remove, press down on the single-sheet priority feed slot, and then remove the feed slot tray.



4. Remove any jammed or damaged sheets of paper.

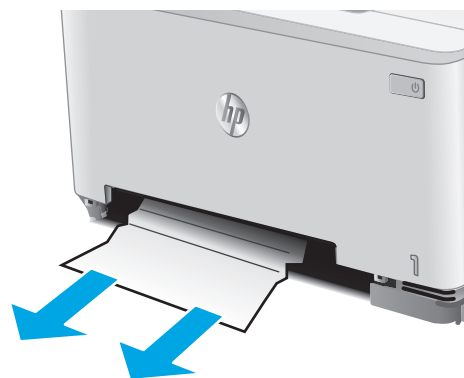

5. Push the single-sheet priority feed slot tray into the product.



6. Reinsert and close Tray 2.



Clear paper jams in the rear door and the fuser area

Use the following procedure to check for paper inside the rear door. When a jam occurs, the control panel displays an animation that assists in clearing the jam.

CAUTION: The fuser is located above the rear door, and it is hot. Do not attempt to reach into the area above the rear door until the fuser is cool.

1. Open the rear door.

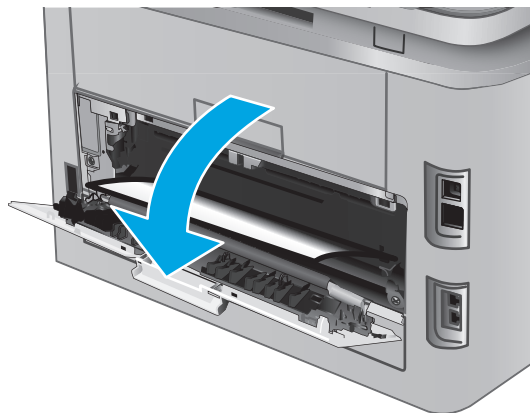

2. Gently pull out any jammed paper from the rollers in the rear door area.

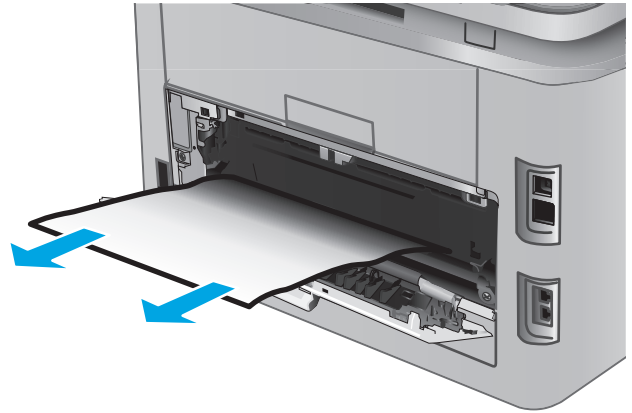

3. Close the rear door.

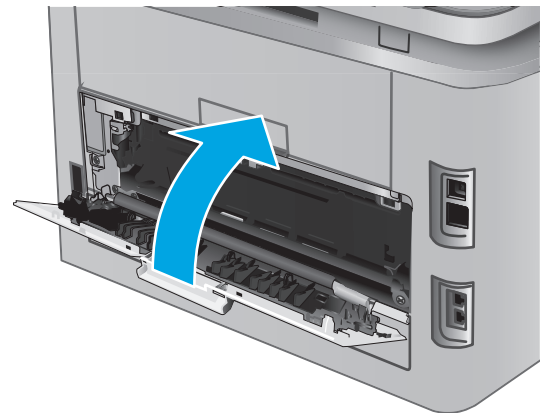

Clear paper jams in the output bin

Use the following procedure to clear jams in the output bin. When a jam occurs, the control panel displays an animation that assists in clearing the jam.

1. If paper is visible in the output bin, grasp the leading edge and remove it.



Clear paper jams in the duplexer (duplex models only)

Use the following procedure to check for paper in the duplexer. When a jam occurs, the control panel displays an animation that assists in clearing the jam.

1. At the rear of the product, open the duplexer.

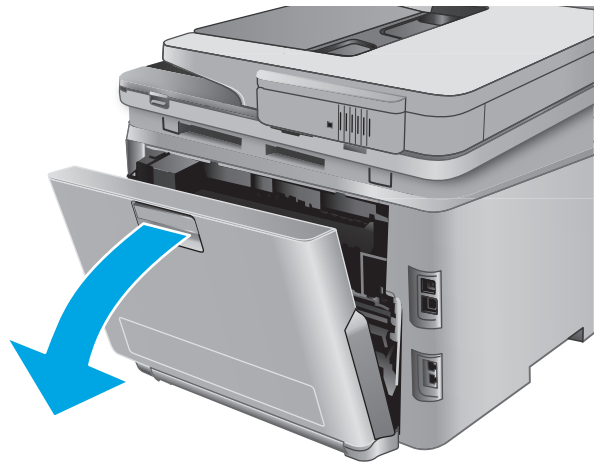

2. Remove any jammed or damaged sheets of paper.

CAUTION: The fuser is located above the rear door, and it is hot. Do not attempt to reach into the area above the rear door until the fuser is cool.



3. Close the duplexer.

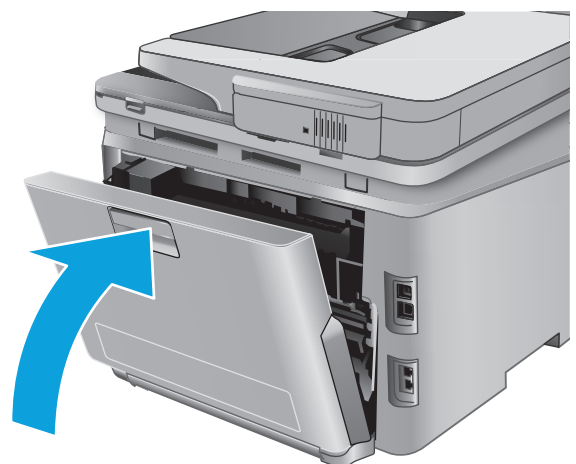

Improve print quality

Introduction

If the product is having print-quality problems, try the following solutions in the order presented to resolve the issue.

If the product is having scan, fax, or copy quality problems, try the following solutions and also see “Improve scan quality,” “Improve fax quality,” or “Improve copy quality” for further solutions.

- [Print from a different software program](#)
- [Check the paper-type setting for the print job](#)
- [Check toner-cartridge status](#)
- [Print and interpret the print quality page](#)
- [Clean the product](#)
- [Visually inspect the toner cartridge](#)
- [Check paper and the printing environment](#)
- [Calibrate the product to align the colors](#)
- [Check other print job settings](#)
- [Try a different print driver](#)

Print from a different software program

Try printing from a different software program. If the page prints correctly, the problem is with the software program from which you were printing.

Check the paper-type setting for the print job

Check the paper type setting when printing from a software program and the printed pages have smears, fuzzy or dark print, curled paper, scattered dots of toner, loose toner, or small areas of missing toner.

Check the paper type setting (Windows)

1. From the software program, select the **Print** option.
2. Select the product, and then click the **Properties** or **Preferences** button.
3. Click the **Paper/Quality** tab.
4. From the **Paper Type** drop-down list, click the **More...** option.
5. Expand the list of **Type is:** options.
6. Expand the category of paper types that best describes your paper.
7. Select the option for the type of paper you are using, and click the **OK** button.
8. Click the **OK** button to close the **Document Properties** dialog box. In the **Print** dialog box, click the **OK** button to print the job.

Check the paper type setting (OS X)

1. Click the **File** menu, and then click the **Print** option.
2. In the **Printer** menu, select the product.
3. By default, the print driver displays the **Copies & Pages** menu. Open the menus drop-down list, and then click the **Finishing** menu.
4. Select a type from the **Media Type** drop-down list.
5. Click the **Print** button.

Check toner-cartridge status

Check the supplies status page for the following information:

- Estimated percentage of cartridge life remaining
- Approximate pages remaining
- Part numbers for HP toner cartridges
- Number of pages printed

Use the following procedure to print the supplies status page:

1. From the Home screen on the product control panel, touch the **Supplies**  button.
2. Touch the **Report** button to print the supplies status page.
3. Check the percent of life remaining for the toner cartridges and if applicable, the status of other replaceable maintenance parts.

Print quality problems can occur when using a toner cartridge that is at its estimated end of life. The supplies status page indicates when a supply level is very low. After an HP supply has reached the very low threshold, HP's premium protection warranty on that supply has ended.

The toner cartridge does not need to be replaced now unless the print quality is no longer acceptable. Consider having a replacement available to install when print quality is no longer acceptable.

If you determine that you need to replace a toner cartridge or other replaceable maintenance parts, the supplies status page lists the genuine HP part numbers.

4. Check to see if you are using a genuine HP cartridge.

A genuine HP toner cartridge has the words "HP" or "Hewlett-Packard" on it, or has the HP logo on it. For more information on identifying HP cartridges go to www.hp.com/go/learnaboutsupplies.

Hewlett Packard cannot recommend the use of non-HP supplies, either new or remanufactured. Because they are not HP products, HP cannot influence their design or control their quality. If you are using a refilled or remanufactured toner cartridge and are not satisfied with the print quality, replace the toner cartridge with a genuine HP toner cartridge.

Print and interpret the print quality page

1. From the Home screen, touch the **Setup**  button.
2. Touch the **Reports** button.
3. Touch the **Print Quality Page** button.

This page contains five bands of color, which are divided into four groups as indicated in the following illustration. By examining each group, you can isolate the problem to a particular toner cartridge.

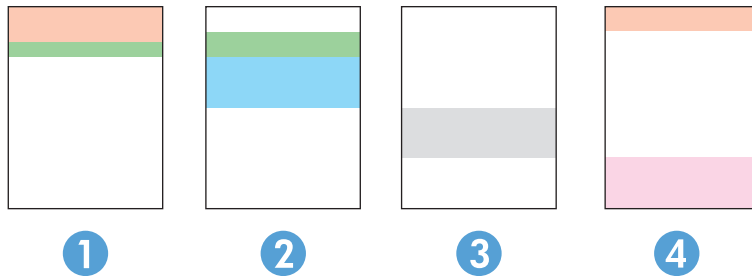

Section	Toner cartridge
1	Yellow
2	Cyan
3	Black
4	Magenta

- If dots or streaks appear in only one of the groups, replace the toner cartridge that correlates with that group.
- If dots appear in more than one group, print a cleaning page. If this does not solve the problem, determine if the dots are always the same color; for example, if magenta dots appear in all five color bands. If the dots are all the same color, replace that toner cartridge.
- If streaks appear in multiple color bands, contact HP. A component other than the toner cartridge is probably causing the problem.

Clean the product

Print a cleaning page

During the printing process paper, toner, and dust particles can accumulate inside the product and can cause print-quality issues such as toner specks or spatter, smears, streaks, lines, or repeating marks.

Use the following procedure to print a cleaning page.

1. From the Home screen on the product control panel, touch the **Setup**  button.
2. Touch the **Service** menu.
3. Touch the **Cleaning Page** button.

4. Load plain letter or A4 paper when you are prompted.
5. Touch the **OK** button to begin the cleaning process.

The product prints the first side and then prompts you to remove the page from the output bin and reload it in Tray 1, keeping the same orientation. Wait until the process is complete. Discard the page that prints.

Check the scanner glass for dirt and smudges

Over time, specks of debris might collect on the scanner glass and white plastic backing, which can affect performance. Use the following procedure to clean the scanner.

1. Press the power button to turn the product off, and then disconnect the power cable from the electrical outlet.
2. Open the scanner lid.
3. Clean the scanner glass and the white plastic backing underneath the scanner lid with a soft cloth or sponge that has been moistened with nonabrasive glass cleaner.

⚠ CAUTION: Do not use abrasives, acetone, benzene, ammonia, ethyl alcohol, or carbon tetrachloride on any part of the product; these can damage the product. Do not place liquids directly on the glass or platen. They might seep and damage the product.

4. Dry the glass and white plastic parts with a chamois or a cellulose sponge to prevent spotting.
5. Connect the power cable to an outlet, and then press the power button to turn the product on.

Visually inspect the toner cartridge

1. Remove the toner cartridge from the product, and verify that the sealing tape has been removed.
2. Check the memory chip for damage.
3. Examine the surface of the imaging drum on the toner cartridge.

⚠ CAUTION: Do not touch the roller (imaging drum) on the cartridge. Fingerprints on the imaging drum can cause print-quality problems.

4. If you see any scratches, fingerprints, or other damage on the imaging drum, replace the toner cartridge.
5. If the imaging drum does not appear to be damaged, rock the toner cartridge gently several times and reinstall it. Print a few pages to see if the problem has resolved.

Check paper and the printing environment

Step one: Use paper that meets HP specifications

Some print-quality problems arise from using paper that does not meet HP specifications.

- Always use a paper type and weight that this product supports.
- Use paper that is of good quality and free of cuts, nicks, tears, spots, loose particles, dust, wrinkles, voids, staples, and curled or bent edges.
- Use paper that has not been previously printed on.

- Use paper that does not contain metallic material, such as glitter.
- Use paper that is designed for use in laser printers. Do not use paper that is designed only for use in Inkjet printers.
- Use paper that is not too rough. Using smoother paper generally results in better print quality.

Step two: Check the environment

The environment can directly affect print quality and is a common cause for print-quality or paper-feeding issues. Try the following solutions:

- Move the product away from drafty locations, such as open windows or doors, or air-conditioning vents.
- Make sure the product is not exposed to temperatures or humidity outside of product specifications.
- Do not place the product in a confined space, such as a cabinet.
- Place the product on a sturdy, level surface.
- Remove anything that is blocking the vents on the product. The product requires good air flow on all sides, including the top.
- Protect the product from airborne debris, dust, steam, grease, or other elements that can leave residue inside the product.

Calibrate the product to align the colors

Calibration is a product function that optimizes print quality.

Follow these steps to resolve print print-quality problems such as misaligned color, colored shadows, blurry graphics, or other print-quality issues.

1. On the product control panel, touch the **Setup**  button.
2. Open the following menus:
 - **System Setup**
 - **Print Quality**
 - **Color Calibration**
 - **Calibrate Now**
3. A **Calibrating** message will display on the product control panel. The calibration process takes a few minutes to complete. Do not turn the product off until the calibration process has finished.
4. Wait while the product calibrates, and then try printing again.

Check other print job settings

When printing from a software program, follow these steps to try to resolve the issue by adjusting other print-driver settings.

Check the EconoMode settings

HP does not recommend the full-time use of EconoMode. If EconoMode is used full-time, the toner supply might outlast the mechanical parts in the toner cartridge. If print quality begins to degrade and is no longer acceptable, consider replacing the toner cartridge.



NOTE: This feature is available with the PCL 6 print driver for Windows. If you are not using that driver, you can enable the feature by using the HP Embedded Web Server.

Follow these steps if the entire page is too dark or too light.

1. From the software program, select the **Print** option.
2. Select the product, and then click the **Properties** or **Preferences** button.
3. Click the **Paper/Quality** tab, and locate the **Print Quality** area.
4. If the entire page is too dark, use these settings:

- Select the **600 dpi** option.
- Select the **EconoMode** check box to enable it.

If the entire page is too light, use these settings:

- Select the **FastRes 1200** option.
 - Clear the **EconoMode** check box to disable it.
5. Click the **OK** button to close the **Document Properties** dialog box. In the **Print** dialog, click the **OK** button to print the job.

Adjust color settings (Windows)

Follow these steps if colors on the printed page do not match colors on the computer screen, or if the colors on the printed page are not satisfactory.

Change the color theme

1. From the software program, select the **Print** option.
2. Select the product, and then click the **Properties** or **Preferences** button.
3. Click the **Color** tab.
4. Select the **HP EasyColor** check box to clear it.
5. Select a color theme from the **Color Themes** drop-down list.
 - **Default (sRGB):** This theme sets the product to print RGB data in raw device mode. When using this theme, manage color in the software program or in the operating system for correct rendering.
 - **Vivid (sRGB):** The product increases the color saturation in the midtones. Use this theme when printing business graphics.
 - **Photo (sRGB):** The product interprets RGB color as if it were printed as a photograph using a digital mini lab. The product renders deeper, more saturated colors differently than with the Default (sRGB) theme. Use this theme when printing photos.

- **Photo (Adobe RGB 1998):** Use this theme with printing digital photos that use the AdobeRGB color space rather than sRGB. Turn off color management in the software program when using this theme.
 - **None:** No color theme is used.
 - **Custom Profile:** Select this option to use a custom input profile to accurately control color output (for example, to emulate a specific HP Color LaserJet product). Download custom profiles from www.hp.com.
6. Click the **OK** button to close the **Document Properties** dialog box. In the **Print** dialog box, click the **OK** button to print the job.

Change the color options

1. From the software program, select the **Print** option.
 2. Select the product, and then click the **Properties** or **Preferences** button.
 3. Click the **Color** tab.
 4. Select the **HP EasyColor** check box to clear it.
 5. Click the **Automatic** or **Manual** setting.
 - **Automatic** setting: Select this setting for most color print jobs
 - **Manual** setting: Select this setting to adjust the color settings independently from other settings. Click the **Settings** button to open the manual color-adjustment window.
-
-  **NOTE:** Changing color settings manually can impact output. HP recommends that only color graphics experts change these settings.
-
6. Click the **Print in Grayscale** option to print a color document in black and shades of gray. Use this option to print color documents for photocopying or faxing. Also use this option to print draft copies or to save color toner.
 7. Click the **OK** button to close the **Document Properties** dialog box. In the **Print** dialog box, click the **OK** button to print the job.

Try a different print driver

You might need to use a different print driver when printing from a software program and the printed pages have unexpected lines in graphics, missing text, missing graphics, incorrect formatting, or substituted fonts.

Download any of the following drivers from the HP Web site: www.hp.com/support/colorljMFPM277.

HP PCL 6 driver

- Provided as the default driver on the product CD. This driver is automatically installed unless you select a different one.
- Recommended for all Windows environments
- Provides the overall best speed, print quality, and product-feature support for most users
- Developed to align with the Windows Graphic Device Interface (GDI) for the best speed in Windows environments
- Might not be fully compatible with third-party and custom software programs that are based on PCL 5

HP UPD PS driver

- Recommended for printing with Adobe® software programs or with other highly graphics-intensive software programs
- Provides support for printing from postscript emulation needs, or for postscript flash font support

HP UPD PCL 5

- Recommended for general office printing in Windows environments
- Compatible with previous PCL versions and older HP LaserJet products
- The best choice for printing from third-party or custom software programs
- The best choice when operating with mixed environments, which require the product to be set to PCL 5 (UNIX, Linux, mainframe)
- Designed for use in corporate Windows environments to provide a single driver for use with multiple product models
- Preferred when printing to multiple product models from a mobile Windows computer

HP UPD PCL 6

- Recommended for printing in all Windows environments
 - Provides the overall best speed, print quality, and printer feature support for most users
 - Developed to align with Windows Graphic Device Interface (GDI) for best speed in Windows environments
 - Might not be fully compatible with third-party and custom software programs that are based on PCL 5
-

Improve copy and scan image quality

Introduction

If the product is having image quality problems, try the following solutions in the order presented to resolve the issue.

- [Check the scanner glass for dirt and smudges](#)
- [Eliminate lines or streaks when using the document feeder](#)
- [Check the paper settings](#)
- [Check the image adjustment settings](#)
- [Optimize for text or pictures](#)
- [Check the scanner resolution and color settings on the computer](#)
- [Edge-to-edge copying](#)
- [Clean the pickup rollers and separation pad in the document feeder](#)

Try these few simple steps first:

- Use the flatbed scanner rather than the document feeder.
- Use high-quality originals.
- When using the document feeder, load the original document into the feeder correctly, using the paper guides, to avoid unclear or skewed images.

If the problem still exists, try these additional solutions. If they do not fix the problem, see “Improve print quality” for further solutions.

Check the scanner glass for dirt and smudges

Over time, specks of debris might collect on the scanner glass and white plastic backing, which can affect performance. Use the following procedure to clean the scanner.

1. Press the power button to turn the product off, and then disconnect the power cable from the electrical outlet.
2. Open the scanner lid.
3. Clean the scanner glass and the white plastic backing underneath the scanner lid with a soft cloth or sponge that has been moistened with nonabrasive glass cleaner.

⚠ CAUTION: Do not use abrasives, acetone, benzene, ammonia, ethyl alcohol, or carbon tetrachloride on any part of the product; these can damage the product. Do not place liquids directly on the glass or platen. They might seep and damage the product.

4. Dry the glass and white plastic parts with a chamois or a cellulose sponge to prevent spotting.
5. Connect the power cable to an outlet, and then press the power button to turn the product on.

Eliminate lines or streaks when using the document feeder

If lines or streaks appear on copied or scanned documents when using the document feeder, use the procedure below to clean debris from the document feeder glass. Debris can include dust, paper or toner dust, residue from sticky note adhesive, correction fluid or tape, ink, fingerprints, and more.

1. Open the scanner lid.
2. Locate the one-inch strip of glass to the left of the main scanner flatbed glass, and then use a soft, lint-free cloth moistened with water to clean the glass strip.

 **CAUTION:** Do not use abrasives, acetone, benzene, ammonia, ethyl alcohol, or carbon tetrachloride on any part of the product; these can damage the product. Do not place liquids directly on the glass or platen. They might seep and damage the product.

3. On the underside of the scanner lid above the strip of glass, use a soft, lint-free cloth moistened with water to clean the upper plastic strip.
4. Dry the glass strip and the upper strip with a soft, dry cloth to prevent spotting, and then try again to copy or scan.

Check the paper settings

1. From the Home screen on the product control panel, touch the **Copy** button.
2. Touch the **Settings** button, and then scroll to and touch the **Paper** button.
3. From the list of paper sizes, touch the name of the paper size that is in the tray.
4. From the list of paper types, touch the name of the paper type that is in the tray.

Check the image adjustment settings

1. From the Home screen, touch the **Copy** button.
2. Touch the **Settings** button, and then scroll to and touch the **Image Adjustment** button.
3. Touch the name of the setting you want to adjust.
 - **Lightness:** Adjusts the lightness/darkness setting.
 - **Contrast:** Adjusts the contrast between the lightest and darkest areas of the image.
 - **Sharpen:** Adjusts clarity of text characters.
 - **Background Removal:** Adjusts the darkness of the background of the image. This is especially useful for original documents that are printed on colored paper.
 - **Color Balance:** Adjusts the red, green, and blue color hues.
 - **Grayness:** Adjusts the vividness of colors.
4. Touch the **—** or **+** buttons to adjust the value for the setting, and then touch the **OK** button.
5. Adjust another setting, or touch the back arrow to return to the main copy menu.

Optimize for text or pictures

1. From the Home screen on the product control panel, touch the **Copy** button.
2. Touch the **Settings** button, and then scroll to and touch the **Optimize** button.
3. Touch the name of the setting you want to adjust.
 - **Auto Select:** Use this setting when you are not concerned about the quality of the copy. This is the default setting.
 - **Mixed:** Use this setting for documents that contain a mixture of text and graphics.
 - **Text:** Use this setting for documents that contain mostly text.
 - **Picture:** Use this setting for documents that contain mostly graphics.

Check the scanner resolution and color settings on the computer

If you are printing a scanned image, and the quality is not what you expected, you might have selected a resolution or color setting in the scanner software that does not match your needs. Resolution and color affect the following features of scanned images:

- Image clarity
- Texture of gradations (smooth or rough)
- Scan time
- File size

Scanning resolution is measured in pixels per inch (ppi).



NOTE: Scanning ppi levels are not interchangeable with printing dpi (dots per inch) levels.

Color, grayscale, and black and white define the number of colors possible. You can adjust the scanner hardware resolution to up to 1200 ppi.

The resolution and color guidelines table lists simple tips that you can follow to meet your scanning needs.



NOTE: Setting the resolution and color to a high value can create large files that take up disk space and slow the scanning process. Before setting the resolution and color, determine how you are going to use the scanned image.

Resolution and color guidelines

The following table describes the recommended resolution and color settings for different types of scan jobs.



NOTE: The default resolution is 200 ppi.

Intended use	Recommended resolution	Recommended color settings
Fax	150 ppi	<ul style="list-style-type: none">• Black and White

Intended use	Recommended resolution	Recommended color settings
Email	150 ppi	<ul style="list-style-type: none"> • Black and White, if the image does not require smooth gradation • Grayscale, if the image requires smooth gradation • Color, if the image is in color
Edit text	300 ppi	<ul style="list-style-type: none"> • Black and White
Print (graphics or text)	600 ppi for complex graphics, or if you want to significantly enlarge the document 300 ppi for normal graphics and text 150 ppi for photos	<ul style="list-style-type: none"> • Black and White for text and line art • Grayscale for shaded or colored graphics and photos • Color, if the image is in color
Display on screen	75 ppi	<ul style="list-style-type: none"> • Black and White for text • Grayscale for graphics and photos • Color, if the image is in color

Color

You can set the color values to the following settings when scanning.

Setting	Recommended use
Color	Use this setting for high-quality color photos or documents in which the color is important.
Black and White	Use this setting for text documents.
Grayscale	Use this setting when file size is an issue or when you want to scan a document or photograph quickly.

Edge-to-edge copying

The product cannot print fully edge-to-edge. There is a 4 mm (1/6 inch) unprintable border around the page.

Considerations for printing or scanning documents with cropped edges:

- When the original is smaller than the output size, move the original 4 mm (1/6 inch) away from the corner indicated by the icon on the scanner. Recopy or scan in this position.
- When the original is the size of the printed output that you want, use the [Reduce/Enlarge](#) feature to reduce the image so the copy is not cropped.

Clean the pickup rollers and separation pad in the document feeder

If the document feeder experiences paper-handling problems, such as jams or multiple-page feeds, clean the document-feeder rollers and separation pad.

1. Open the document-feeder access cover.

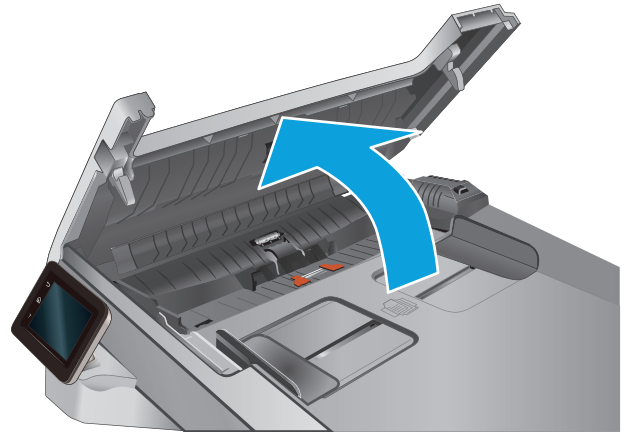

2. Use a moist, lint-free cloth to wipe both pickup rollers and the separation pad to remove dirt.

CAUTION: Do not use abrasives, acetone, benzene, ammonia, ethyl alcohol, or carbon tetrachloride on any part of the product; these can damage the product. Do not place liquids directly on the glass or platen. They might seep and damage the product.

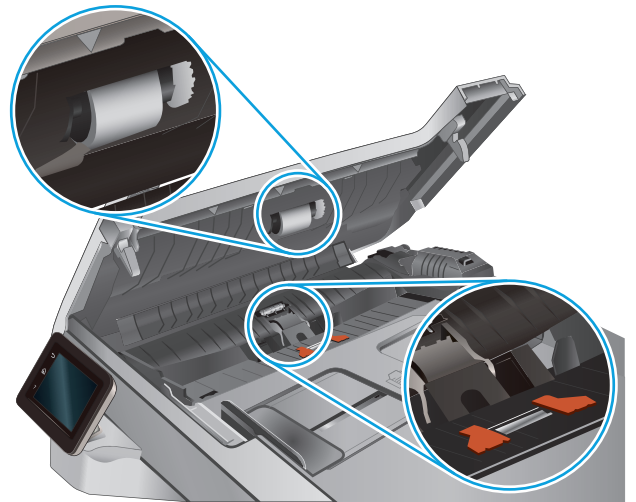

3. Close the document feeder access cover.

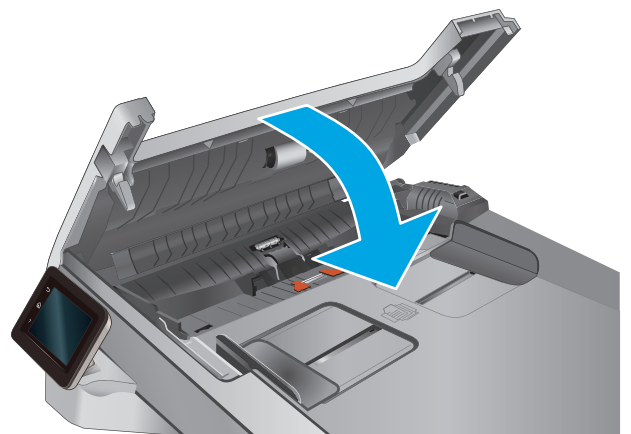

Improve fax image quality

Introduction

If the product is having image quality problems, try the following solutions in the order presented to resolve the issue.

- [Check the scanner glass for dirt and smudges](#)
- [Check the send-fax resolution settings](#)
- [Check the error-correction settings](#)
- [Check the fit-to-page setting](#)
- [Clean the pickup rollers and separation pad in the document feeder](#)
- [Send to a different fax machine](#)
- [Check the sender's fax machine](#)

Try these few simple steps first:

- Use the flatbed scanner rather than the document feeder.
- Use high-quality originals.
- When using the document feeder, load the original document into the feeder correctly, using the paper guides, to avoid unclear or skewed images.

If the problem still exists, try these additional solutions. If they do not fix the problem, see “Improve print quality” for further solutions.

Check the scanner glass for dirt and smudges

Over time, specks of debris might collect on the scanner glass and white plastic backing, which can affect performance. Use the following procedure to clean the scanner.

1. Press the power button to turn the product off, and then disconnect the power cable from the electrical outlet.
2. Open the scanner lid.
3. Clean the scanner glass and the white plastic backing underneath the scanner lid with a soft cloth or sponge that has been moistened with nonabrasive glass cleaner.

 **CAUTION:** Do not use abrasives, acetone, benzene, ammonia, ethyl alcohol, or carbon tetrachloride on any part of the product; these can damage the product. Do not place liquids directly on the glass or platen. They might seep and damage the product.

4. Dry the glass and white plastic parts with a chamois or a cellulose sponge to prevent spotting.
5. Connect the power cable to an outlet, and then press the power button to turn the product on.

Check the send-fax resolution settings

If the product was unable to send a fax because the receiving fax machine did not answer or was busy, the product attempts to redial based on the redial-on-busy, redial-on-no-answer, and redial-on-communication-error options.

1. From the Home screen on the product control panel, touch the Setup  button.
2. Touch the [Fax Setup](#) menu.
3. Touch the [Advanced Setup](#) menu.
4. Open the [Fax Resolution](#) menu.

Check the error-correction settings

Usually, the product monitors the signals on the telephone line while it is sending or receiving a fax. If the product detects an error during the transmission and the error-correction setting is [On](#), the product can request that the portion of the fax be resent. The factory-set default for error correction is [On](#).

You should turn off error correction only if you are having trouble sending or receiving a fax, and you are willing to accept the errors in the transmission. Turning off the setting might be useful when you are trying to send a fax overseas or receive one from overseas, or if you are using a satellite telephone connection.

1. From the Home screen on the product control panel, touch the Setup  button.
2. Touch the [Service](#) menu.
3. Touch the [Fax Service](#) menu.
4. Touch the [Error Correction](#) button, and then touch the [On](#) button.

Check the fit-to-page setting

If the product printed a fax job off the page, turn on the fit-to-page feature from the product control panel.

 **NOTE:** Make sure that the default paper size setting matches the size of the paper in the tray.

1. From the Home screen on the product control panel, touch the Setup  button.
2. Touch the [Fax Setup](#) menu.
3. Touch the [Advanced Setup](#) menu.
4. Touch the [Fit to Page](#) button, and then touch the [On](#) button.

Clean the pickup rollers and separation pad in the document feeder

If the document feeder experiences paper-handling problems, such as jams or multiple-page feeds, clean the document-feeder rollers and separation pad.

1. Open the document-feeder access cover.

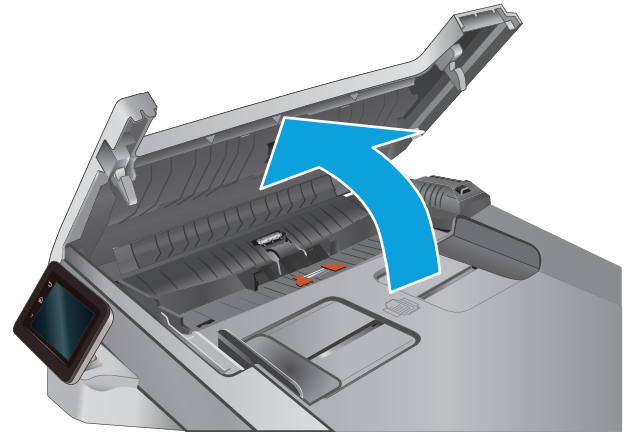

2. Use a moist, lint-free cloth to wipe both pickup rollers and the separation pad to remove dirt.

CAUTION: Do not use abrasives, acetone, benzene, ammonia, ethyl alcohol, or carbon tetrachloride on any part of the product; these can damage the product. Do not place liquids directly on the glass or platen. They might seep and damage the product.

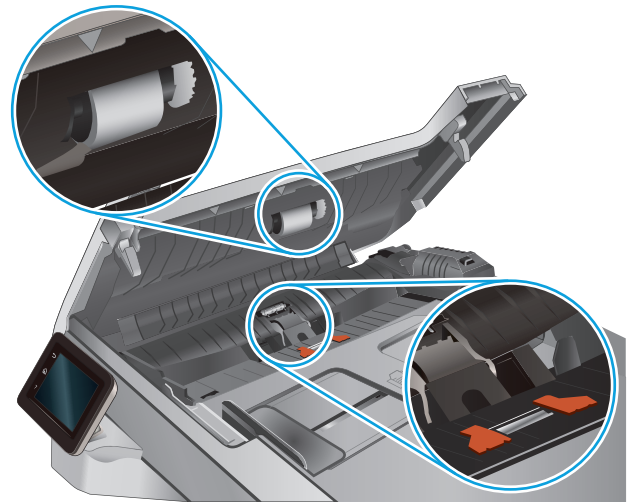

3. Close the document feeder access cover.

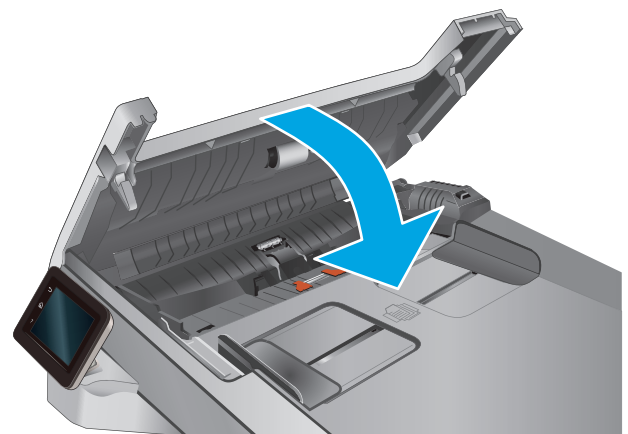

Send to a different fax machine

Try sending the fax to a different fax machine. If the fax quality is better, the problem is related to the initial recipient's fax machine settings or supplies status.

Check the sender's fax machine

Ask the sender to try sending from a different fax machine. If the fax quality is better, the problem is with the sender's fax machine. If a different fax machine is unavailable, ask the sender to consider making the following changes:

- Make sure the original document is on white (not colored) paper.
- Increase the fax resolution, quality level, or contrast settings.
- If possible, send the fax from a computer software program.

Solve wired network problems

Introduction

Check the following items to verify that the product is communicating with the network. Before beginning, print a configuration page from the product control panel and locate the product IP address that is listed on this page.

- [Poor physical connection](#)
- [The computer is using the incorrect IP address for the product](#)
- [The computer is unable to communicate with the product](#)
- [The product is using incorrect link and duplex settings for the network](#)
- [New software programs might be causing compatibility problems](#)
- [The computer or workstation might be set up incorrectly](#)
- [The product is disabled, or other network settings are incorrect](#)



NOTE: HP does not support peer-to-peer networking, as the feature is a function of Microsoft operating systems and not of the HP print drivers. For more information, go to Microsoft at www.microsoft.com.

Poor physical connection

1. Verify that the product is attached to the correct network port using a cable of the correct length.
2. Verify that cable connections are secure.
3. Look at the network port connection on the back of the product, and verify that the amber activity light and the green link-status light are lit.
4. If the problem continues, try a different cable or port on the hub.

The computer is using the incorrect IP address for the product

1. Open the printer properties and click the **Ports** tab. Verify that the current IP address for the product is selected. The product IP address is listed on the product configuration page.
2. If you installed the product using the HP standard TCP/IP port, select the box labeled **Always print to this printer, even if its IP address changes**.
3. If you installed the product using a Microsoft standard TCP/IP port, use the hostname instead of the IP address.
4. If the IP address is correct, delete the product and then add it again.

The computer is unable to communicate with the product

1. Test network communication by pinging the network.
 - a. Open a command-line prompt on your computer.

- For Windows, click **Start**, click **Run**, type `cmd`, and then press **Enter**.
 - For OS X, go to **Applications**, then **Utilities**, and open **Terminal**.
- b. Type `ping` followed by the IP address for your product.
 - c. If the window displays round-trip times, the network is working.
2. If the ping command failed, verify that the network hubs are on, and then verify that the network settings, the product, and the computer are all configured for the same network.

The product is using incorrect link and duplex settings for the network

Hewlett-Packard recommends leaving these settings in automatic mode (the default setting). If you change these settings, you must also change them for your network.

New software programs might be causing compatibility problems

Verify that any new software programs are correctly installed and that they use the correct print driver.

The computer or workstation might be set up incorrectly

1. Check the network drivers, print drivers, and the network redirection settings.
2. Verify that the operating system is configured correctly.

The product is disabled, or other network settings are incorrect

1. Review the configuration page to check the status of the network protocol. Enable it if necessary.
2. Reconfigure the network settings if necessary.

Solve wireless network problems

Introduction

Use the troubleshooting information to help resolve issues.



NOTE: To determine whether HP NFC and HP wireless direct printing are enabled on your product, print a configuration page from the product control panel. If a page titled [Wireless](#) is included, HP Jetdirect 2800w NFC & Wireless Direct Accessory printing is enabled on the product.

- [Wireless connectivity checklist](#)
- [The product does not print after the wireless configuration completes](#)
- [The product does not print, and the computer has a third-party firewall installed](#)
- [The wireless connection does not work after moving the wireless router or product](#)
- [Cannot connect more computers to the wireless product](#)
- [The wireless product loses communication when connected to a VPN](#)
- [The network does not appear in the wireless networks list](#)
- [The wireless network is not functioning](#)
- [Perform a wireless network diagnostic test](#)
- [Reduce interference on a wireless network](#)

Wireless connectivity checklist

- Verify that the network cable is not connected.
- Verify that the product and the wireless router are turned on and have power. Also make sure that the wireless radio in the product is turned on.
- Verify that the service set identifier (SSID) is correct. Print a configuration page to determine the SSID. If you are not sure the SSID is correct, run the wireless setup again.
- With secured networks, verify that the security information is correct. If the security information is incorrect, run the wireless setup again.
- If the wireless network is working correctly, try accessing other computers on the wireless network. If the network has Internet access, try connecting to the Internet over a wireless connection.
- Verify that the encryption method (AES or TKIP) is the same for the product as it is for the wireless access point (on networks using WPA security).
- Verify that the product is within the range of the wireless network. For most networks, the product must be within 30 m (100 ft) of the wireless access point (wireless router).
- Verify that obstacles do not block the wireless signal. Remove any large metal objects between the access point and the product. Make sure poles, walls, or support columns containing metal or concrete do not separate the product and wireless access point.

- Verify that the product is located away from electronic devices that might interfere with the wireless signal. Many devices can interfere with the wireless signal including motors, cordless phones, security system cameras, other wireless networks, and some Bluetooth devices.
- Verify that the print driver is installed on the computer.
- Verify that you have selected the correct printer port.
- Verify that the computer and product connect to the same wireless network.
- For OS X, verify that the wireless router supports Bonjour.

The product does not print after the wireless configuration completes

1. Make sure that the product is turned on and in the ready state.
2. Turn off any third-party firewalls on your computer.
3. Make sure that the wireless network is working correctly.
4. Make sure that your computer is working correctly. If necessary, restart the computer.
5. Verify that you can open the product HP Embedded Web Server from a computer on the network.

The product does not print, and the computer has a third-party firewall installed

1. Update the firewall with the most recent update available from the manufacturer.
2. If programs request firewall access when you install the product or try to print, make sure you allow the programs to run.
3. Temporarily turn off the firewall, and then install the wireless product on the computer. Enable the firewall when you have completed the wireless installation.

The wireless connection does not work after moving the wireless router or product

1. Make sure that the router or product connects to the same network that your computer connects to.
2. Print a configuration page.
3. Compare the service set identifier (SSID) on the configuration page to the SSID in the printer configuration for the computer.
4. If the numbers are not the same, the devices are not connecting to the same network. Reconfigure the wireless setup for the product.

Cannot connect more computers to the wireless product

1. Make sure that the other computers are within the wireless range and that no obstacles block the signal. For most networks, the wireless range is within 30 m (100 ft) of the wireless access point.
2. Make sure that the product is turned on and in the ready state.
3. Turn off any third-party firewalls on your computer.
4. Make sure that the wireless network is working correctly.
5. Make sure that your computer is working correctly. If necessary, restart the computer.

The wireless product loses communication when connected to a VPN

- Typically, you cannot connect to a VPN and other networks at the same time.

The network does not appear in the wireless networks list

- Make sure the wireless router is turned on and has power.
- The network might be hidden. However, you can still connect to a hidden network.

The wireless network is not functioning

1. Make sure that the network cable is not connected.
2. To verify if the network has lost communication, try connecting other devices to the network.
3. Test network communication by pinging the network.
 - a. Open a command-line prompt on your computer.
 - For Windows, click **Start**, click **Run**, type `cmd`, and then press **Enter**.
 - For OS X, go to **Applications**, then **Utilities**, and open **Terminal**.
 - b. Type `ping` followed by the router IP address.
 - c. If the window displays round-trip times, the network is working.
4. Make sure that the router or product connects to the same network that the computer connects to.
 - a. Print a configuration page.
 - b. Compare the service set identifier (SSID) on the configuration report to the SSID in the printer configuration for the computer.
 - c. If the numbers are not the same, the devices are not connecting to the same network. Reconfigure the wireless setup for the product.

Perform a wireless network diagnostic test

From the product control panel, you can run a diagnostic test that provides information about the wireless network settings.

1. From the Home screen on the product control panel, touch the **Setup**  button.
2. Open the **Self Diagnostics** menu.
3. Touch the **Run Wireless Test** button to start the test. The product prints a test page that shows test results.

Reduce interference on a wireless network

The following tips can reduce interference in a wireless network:

- Keep the wireless devices away from large metal objects, such as filing cabinets, and other electromagnetic devices, such as microwaves and cordless telephones. These objects can disrupt radio signals.
- Keep the wireless devices away from large masonry structures and other building structures. These objects can absorb radio waves and lower signal strength.
- Position the wireless router in a central location in line of sight with the wireless products on the network.

Solve fax problems

Introduction

Use the fax troubleshooting information to help resolve issues.

- [Fax troubleshooting checklist](#)
- [Solve general fax problems](#)

Fax troubleshooting checklist

- Several possible fixes are available. After each recommended action, retry faxing to see if the problem is resolved.
- For best results during fax problem solving, make sure the line from the product is connected directly to the wall phone port. Disconnect all other devices that are connected to the product.

1. Verify that the telephone cord is connected to the correct port on the back of the product.

2. Check the phone line by using the fax test:

- a. From the Home screen on the product control panel, touch the Setup  button, and then touch the [Service](#) menu.
- b. Select the [Fax Service](#) menu.
- c. Select the [Run Fax Test](#) option. The product prints a fax test report.

The report contains the following possible results:

- **Pass:** The report contains all of the current fax settings for review.
- **Fail:** The report indicates the nature of the error and contains suggestions for how to resolve the issue.

3. Verify that the product firmware is current:

- a. Print a configuration page from the control panel [Reports](#) menu to obtain the current firmware date code.
- b. Go to www.hp.com/go/support, click the **Drivers & Software** link, type the product name in the search field, press the [ENTER](#) button, and then select the product from the list of search results.
- c. Select the operating system.
- d. Under the **Firmware** section, locate the **Firmware Update Utility**.



NOTE: Make sure to use the firmware update utility that is specific to the printer model.

- e. Click **Download**, click **Run**, and then click **Run** again.
- f. When the utility launches, select the product from the drop-down list, and then click **Send Firmware**.



NOTE: To print a configuration page to verify the installed firmware version before or after the update process, click **Print Config**.

- g.** Follow the on-screen instructions to complete the installation, and then click the **Exit** button to close the utility.

- 4.** Verify that the fax was set up when the product software was installed.

From the computer, in the HP program folder, run the Fax Setup Utility.

- 5.** Verify that the telephone service supports analog fax.

- If using ISDN or digital PBX, contact your service provider for information about configuring to an analog fax line.
- If using a VoIP service, change the **Fax Speed** setting to **Slow(V.29)** from the control panel. Ask if your service provider supports fax and for the recommended fax modem speed. Some companies might require an adapter.
- If you are using a DSL service, make sure that a filter is included on the phone-line connection to the product. Contact the DSL service provider, or purchase a DSL filter if you do not have one. If a DSL filter is installed, try another filter because filters can be defective.

Solve general fax problems

- [Faxes are sending slowly](#)
- [Fax quality is poor](#)
- [Fax cuts off or prints on two pages](#)

Faxes are sending slowly

The product is experiencing poor phone line quality.

- Retry sending the fax when the line conditions have improved.
- Check with the phone service provider that the line supports fax.
- Turn off the **Error Correction** setting.
 - a. Open the **Setup Menu** menu.
 - b. Open the **Service** menu.
 - c. Open the **Fax Service** menu.
 - d. Open the **Error Correction** menu.
 - e. Select the **Off** setting.



NOTE: This can reduce image quality.

- Use white paper for the original. Do not use colors such as gray, yellow, or pink.
- Increase the **Fax Speed** setting.

- a. Open the [Setup Menu](#) menu.
- b. Open the [Fax Setup](#) menu.
- c. Open the [Advanced Setup](#) menu.
- d. Open the [Fax Speed](#) menu.
- e. Select the correct setting.
- Divide large fax jobs into smaller sections, and then fax them individually.
- Change the fax settings on the control panel to a lower resolution.
 - a. Open the [Setup Menu](#) menu.
 - b. Open the [Fax Setup](#) menu.
 - c. Open the [Advanced Setup](#) menu.
 - d. Open the [Fax Resolution](#) menu.
 - e. Select the correct setting.

Fax quality is poor

Fax is blurry or light.

- Increase fax resolution when sending faxes. Resolution does not affect received faxes.
 - a. Open the [Setup Menu](#) menu.
 - b. Open the [Fax Setup](#) menu.
 - c. Open the [Advanced Setup](#) menu.
 - d. Open the [Fax Resolution](#) menu.
 - e. Select the correct setting.



NOTE: Increasing resolution slows transmission speed.

- Turn on the [Error Correction](#) setting from the control panel.
 - a. Open the [Setup Menu](#) menu.
 - b. Open the [Service](#) menu.
 - c. Open the [Fax Service](#) menu.
 - d. Open the [Error Correction](#) menu.
 - e. Select the [On](#) setting.
- Check the toner cartridges and replace if necessary.
- Ask the sender to darken the contrast setting on the sending fax machine, and then resend the fax.

Fax cuts off or prints on two pages

- Set the **Default Paper Size** setting. Faxes print on a single size of paper based on the **Default Paper Size** settings.
 - a. Open the **Setup Menu** menu.
 - b. Open the **System Setup** menu.
 - c. Open the **Paper Setup** menu.
 - d. Open the **Default Paper Size** menu.
 - e. Select the correct setting.
- Set the paper type and size for the tray used for faxes.
- Turn on the **Fit to Page** setting to print longer length faxes on letter or A4 size paper.
 - a. Open the **Setup Menu** menu.
 - b. Open the **Fax Setup** menu.
 - c. Open the **Advanced Setup** menu.
 - d. Open the **Fit to Page** menu.
 - e. Select the **On** setting.



NOTE: If the **Fit to Page** setting is off and the **Default Paper Size** setting is set to letter, a legal size original prints on two pages.

Index

A

- accessories
 - ordering 28
 - part numbers 28
- acoustic specifications 12
- AirPrint 45
- Android devices
 - printing from 45
- applications
 - downloading 80
- Apps menu 80

B

- bins, output
 - locating 2
- browser requirements
 - HP Embedded Web Server 82

C

- calibrate
 - colors 121
- cartridge
 - replacing 30
- checklist
 - fax troubleshooting 140
 - wireless connectivity 136
- cleaning
 - glass 120, 125, 130
 - paper path 119
- color options
 - changing, Windows 122
- color theme
 - changing, Windows 122
- colors
 - calibrate 121
- control panel
 - help 99
 - locating 2

- control panel buttons
 - locating 4
- copying
 - edges of documents 128
 - multiple copies 48
 - optimizing for text or pictures 127
 - setting paper size and type 126
 - single copies 48
 - two-sided documents 49
- covers, locating 2
- customer support
 - online 98

D

- defaults, restoring 100
- dimensions, product 11
- document feeder 49
 - copying two-sided documents 49
 - faxing from 75
 - jams 107
 - paper-feeding problems 103
- double-sided copying 49
- double-sided printing
 - Mac 41
 - Windows 39
- drivers, supported 8
- duplex 49
- duplex printing
 - Mac 41
- duplex printing (double-sided)
 - settings (Windows) 39
 - Windows 39
- duplexer
 - jams 116
- duplexing
 - manually (Mac) 41
 - manually (Windows) 39

E

- EconoMode setting 91, 122
- economy settings 91
- electrical specifications 12
- Embedded Web Server (EWS)
 - assigning passwords 90
 - features 82
- envelopes
 - loading in Tray 1 16
 - orientation 19
- Explorer, versions supported
 - HP Embedded Web Server 82

F

- factory-set defaults, restoring 100
- fax
 - solve general problems 141
 - speed dials 75
- fax ports
 - locating 3
- fax troubleshooting
 - checklist 140
- faxing
 - from the document feeder 75
 - from the flatbed scanner 74
- fuser
 - jams 113

G

- glass, cleaning 120, 125, 130

H

- help, control panel 99
- HP Customer Care 98
- HP Device Toolbox, using 82
- HP Embedded Web Server (EWS)
 - features 82
- HP ePrint 44
- HP ePrint software 44

- HP EWS, using 82
- HP Scan software (OS X) 53
- HP Scan software (Windows) 52
- HP Utility 85
- HP Utility for Mac
 - Bonjour 85
 - features 85
- HP Utility, Mac 85
- HP Web Jetadmin 93
- HP Web Services
 - applications 80
 - enabling 80

- I**
- interface ports
 - locating 3
- Internet Explorer, versions supported
 - HP Embedded Web Server 82

- J**
- jams
 - document feeder 107
 - duplexer 116
 - fuser 113
 - locations 106
 - output bin 115
 - rear door 113
 - single-sheet priority feed slot 109
 - Tray 1 109
 - Tray 2 111
- Jetadmin, HP Web 93

- L**
- labels
 - printing (Windows) 40
- loading
 - paper in Tray 1 16
 - paper in Tray 2 20

- M**
- Macintosh
 - HP Utility 85
- maintenance kits
 - part numbers 28
- manual duplex
 - Mac 41
 - Windows 39
- memory
 - included 7

- memory chip (toner)
 - locating 30
- mobile printing
 - Android devices 45
- mobile printing solutions 7
- mobile printing, software supported 9
- multiple pages per sheet
 - printing (Mac) 41
 - printing (Windows) 40

- N**
- Near Field Communication printing 43
- Netscape Navigator, versions supported
 - HP Embedded Web Server 82
- network installation 81
- network port
 - locating 3
- networks
 - HP Web Jetadmin 93
 - installing the product 81
 - supported 7
- NFC printing 43
- number of copies, changing 48

- O**
- on/off button, locating 2
- online help, control panel 99
- online support 98
- operating systems (OS)
 - supported 7
- operating systems, supported 8
- ordering
 - supplies and accessories 28
- OS (operating system)
 - supported 7
- output bin
 - clear jams 115
 - locating 2

- P**
- pages per minute 7
- pages per sheet
 - selecting (Mac) 41
 - selecting (Windows) 40
- paper
 - loading Tray 1 16
 - loading Tray 2 20
 - selecting 120

- Tray 1 orientation 19
- Tray 2 orientation 25
- paper jams
 - document feeder 107
 - duplexer 116
 - fuser 113
 - locations 106
 - output bin 115
 - rear door 113
 - single-sheet priority feed slot 109
 - Tray 1 109
 - Tray 2 111
- paper pickup problems
 - solving 103
- paper type
 - selecting (Windows) 40
- paper types
 - selecting (Mac) 42
- paper, ordering 28
- part numbers
 - accessories 28
 - replacement parts 28
 - staple cartridges 28
 - supplies 28
 - toner cartridge 28
 - toner cartridges 28
- phone book, fax
 - adding entries 75
 - deleting all entries 78
- power
 - consumption 12
- power connection
 - locating 3
- power switch, locating 2
- print drivers, supported 8
- print media
 - loading in Tray 1 16
- print on both sides
 - Mac 41
 - manually, Windows 39
 - Windows 39
- printing
 - from USB flash drives 46
- printing on both sides
 - settings (Windows) 39
- product and serial number label
 - locating 3

R

- rear door
 - jams 113
- replacement parts
 - part numbers 28
- replacing
 - toner cartridges 30
- restoring factory-set defaults 100

S

- scanner
 - faxing from 74
 - glass cleaning 120, 125, 130
- scanning
 - from HP Scan software (OS X) 53
 - from HP Scan software (Windows) 52
- security lock slot
 - locating 3
- serial number label
 - locating 3
- settings
 - factory-set defaults, restoring 100
- shut down after delay
 - setting 91
- single-sheet priority feed slot
 - jams 109
 - loading 16
 - paper orientation 19
- sleep delay
 - setting 91
- software
 - HP Utility 85
- solve problems
 - fax 141
- special paper
 - printing (Windows) 40
- specifications
 - electrical and acoustic 12
- speed dials
 - programming 75
- staple cartridges
 - part numbers 28
- status
 - HP Utility, Mac 85
- supplies
 - low threshold settings 101
 - ordering 28

- part numbers 28
- replacing toner cartridges 30
- status, viewing with HP Utility for Mac 85
- using when low 101
- supplies status 118
- support
 - online 98
- system requirements
 - HP Embedded Web Server 82

T

- technical support
 - online 98
- toner cartridge
 - checking for damage 120
 - low threshold settings 101
 - part numbers 28
 - using when low 101
- toner cartridges
 - components 30
 - part numbers 28
 - replacing 30
- toner-cartridge status 118
- transparencies
 - printing (Windows) 40
- Tray 1
 - jams 109
 - loading 16
 - paper orientation 19
- Tray 2
 - jams 111
 - loading 20
 - paper orientation 25
- trays
 - capacity 7
 - included 7
 - locating 2
- troubleshooting
 - faxes 140
 - network problems 134
 - wired network 134
 - wireless network 136
- two-sided copying 49
- two-sided printing
 - settings (Windows) 39

U

- USB flash drives
 - printing from 46

- USB port
 - locating 3

W

- walk-up USB port
 - locating 2
- walk-up USB printing 46
- Web browser requirements
 - HP Embedded Web Server 82
- Web Services
 - applications 80
 - enabling 80
- Web sites
 - customer support 98
 - HP Web Jetadmin, downloading 93
- weight, product 11
- Wi-Fi Direct Printing 43
- wireless network
 - troubleshooting 136
- wireless network interference 138



B3Q10-90908



Free Manuals Download Website

<http://myh66.com>

<http://usermanuals.us>

<http://www.somanuals.com>

<http://www.4manuals.cc>

<http://www.manual-lib.com>

<http://www.404manual.com>

<http://www.luxmanual.com>

<http://aubethermostatmanual.com>

Golf course search by state

<http://golfingnear.com>

Email search by domain

<http://emailbydomain.com>

Auto manuals search

<http://auto.somanuals.com>

TV manuals search

<http://tv.somanuals.com>