



OFFICEJET PRO 8500A

User Guide





HP Officejet Pro 8500A (A910) e-All-in-One series

User Guide

Copyright information

© 2010 Copyright Hewlett-Packard Development Company, L.P.

Hewlett-Packard Company notices

The information contained in this document is subject to change without notice.

All rights reserved. Reproduction, adaptation, or translation of this material is prohibited without prior written permission of Hewlett-Packard, except as allowed under copyright laws.

The only warranties for HP products and services are set forth in the express warranty statements accompanying such products and services. Nothing herein should be construed as constituting an additional warranty. HP shall not be liable for technical or editorial errors or omissions contained herein.

Acknowledgements

Windows, Windows XP, and Windows Vista are U.S. registered trademarks of Microsoft Corporation.

ENERGY STAR and the ENERGY STAR mark are registered U.S. marks.

Safety information



Always follow basic safety precautions when using this product to reduce risk of injury from fire or electric shock.

1. Read and understand all instructions in the documentation that comes with the printer.
2. Observe all warnings and instructions marked on the product.
3. Unplug this product from wall outlets before cleaning.
4. Do not install or use this product near water, or when you are wet.
5. Install the product securely on a stable surface.
6. Install the product in a protected location where no one can step on or trip over the line cord, and the line cord cannot be damaged.
7. If the product does not operate normally, see [Solve a problem](#).
8. There are no user-serviceable parts inside. Refer servicing to qualified service personnel.

Accessibility

The printer provides a number of features that make it accessible for people with disabilities.

Visual

The printer software is accessible for users with visual impairments or low vision through the use of your operating system's accessibility options and features. It also supports most assistive technology such as screen readers, Braille readers, and voice-to-text applications. For users who are color blind, colored buttons and tabs used in the software and on the printer control panel have simple text or icon labels that convey the appropriate action.

Mobility

For users with mobility impairments, the printer software functions can be executed through keyboard commands. The software also supports Windows accessibility options such as StickyKeys, ToggleKeys, FilterKeys, and MouseKeys. The printer doors, buttons, paper trays, and paper guides can be operated by users with limited strength and reach.

Support

For more details about the accessibility of this product and HP's commitment to product accessibility, visit HP's Web site at www.hp.com/accessibility.

For accessibility information for the Mac OS X, visit the Apple Web site at www.apple.com/accessibility.

Contents

1 Get started	
Accessibility	10
Eco-Tips	11
Understand the printer parts	11
Front view	11
Printing supplies area	12
Back view	13
Use the printer control panel	13
Overview of buttons and lights	13
HP Officejet Pro 8500A (A910a-f)	14
HP OfficeJet Pro 8500A (A910g-z)	15
Control-panel display icons	16
Change printer settings	18
Select the mode	18
Change printer settings	18
Finding the printer model number	18
Select print media	19
Recommended papers for printing and copying	19
Recommended papers for photo printing	20
Tips for selecting and using media	21
Load an original on the scanner glass	21
Load an original in the automatic document feeder (ADF)	22
Load media	23
Load standard-size media	23
Load envelopes	24
Load cards and photo paper	25
Load transparencies	26
Load custom-size media	26
Insert a memory device	27
Install the accessories	28
Install the duplexer	29
Install Tray 2	29
Turn on accessories in the printer driver	30
To turn on accessories on Windows computers	30
To turn on accessories on Macintosh computers	30
Maintain the printer	30
Clean the scanner glass	30
Clean the exterior	31
Clean the automatic document feeder	31
Turn the printer off	32
2 Print	
Print documents	33
Print documents (Windows)	34
Print documents (Mac OS X)	34

Print brochures	34
Print brochures (Windows)	34
Print brochures (Mac OS X)	35
Print on envelopes	35
Print on envelopes (Windows)	35
Print on envelopes (Mac OS X)	36
Print photos	36
Print photos on photo paper (Windows)	36
Print photos on photo paper (Mac OS X)	37
Print photos from a memory device	37
Print DPOF photos	38
Print on special and custom-size paper	39
Print on special or custom-size paper (Mac OS X)	39
Print borderless documents	39
Print borderless documents (Windows)	40
Print borderless documents (Mac OS X)	40
3 Scan	
Scan an original	43
Scan to a computer	43
Scan to a memory card	44
Scan using Webscan	44
Scanning documents as editable text	45
4 HP Digital Solutions	
What are HP Digital Solutions?	46
HP Direct Digital Filing	46
HP Digital Fax	46
Requirements	47
Set up the HP Digital Solutions	48
Set up HP Direct Digital Filing	48
Set Up Scan to Network Folder	49
Set Up Scan to E-mail	50
Set Up HP Digital Fax	52
Use the HP Digital Solutions	53
Use HP Scan to Network Folder	53
Use Scan to E-mail	53
Use HP Digital Fax	54
5 Copy	
Copy documents	55
Change copy settings	55

6 Fax

- Send a fax57
 - Send a standard fax57
 - Send a standard fax from the computer58
 - Send a fax manually from a phone59
 - Send a fax using monitor dialing60
 - Send a fax from memory60
 - Schedule a fax to send later61
 - Send a fax to multiple recipients62
 - Send a fax in Error Correction Mode62
- Receive a fax63
 - Receive a fax manually63
 - Set up backup fax64
 - Reprint received faxes from memory65
 - Poll to receive a fax65
 - Forward faxes to another number65
 - Set the paper size for received faxes66
 - Set automatic reduction for incoming faxes66
 - Block unwanted fax numbers67
 - Add numbers to the junk fax list67
 - Remove numbers from the junk fax list68
 - Print a Junk Fax Report68
 - Receive faxes to your computer (Fax to PC and Fax to Mac)68
 - Fax to PC and Fax to Mac requirements69
 - Activate Fax to PC and Fax to Mac69
 - Modify Fax to PC or Fax to Mac settings69
- Set up speed-dial entries70
 - Set up and change speed-dial entries70
 - Set up and change group speed-dial entries71
 - Delete speed-dial entries72
 - Print a list of speed-dial entries72
- Change fax settings72
 - Configure the fax header72
 - Set the answer mode (Auto answer)73
 - Set the number of rings before answering73
 - Change the answer ring pattern for distinctive ring73
 - Set the dial type74
 - Set the redial options75
 - Set the fax speed75
 - Set the fax sound volume76
- Fax and digital phone services76
- Fax over Internet Protocol76
- Use reports77
 - Print fax confirmation reports77
 - Print fax error reports78
 - Print and view the fax log79
 - Clear the fax log79
 - Print the details of the last fax transaction79
 - Print a Caller ID Report79
 - View the Call History79

7 Web	
HP Apps	81
Marketsplash by HP	82
8 Work with ink cartridges	
Information on ink cartridges and the printheads	83
Check the estimated ink levels	84
Replace the ink cartridges	84
Store printing supplies	86
Store ink cartridges	86
Store printheads	86
9 Solve a problem	
HP support	87
Obtain electronic support	88
HP support by phone	88
Before you call	88
Phone support period	89
Telephone support numbers	89
After the phone support period	91
General troubleshooting tips and resources	91
Solve printing problems	91
The printer shuts down unexpectedly	92
Alignment fails	92
The printer is not responding (nothing prints)	92
Printer takes a long time to print	93
Blank or partial page printed	93
Something on the page is missing or incorrect	93
Placement of the text or graphics is wrong	94
Solve print quality problems	94
General print quality troubleshooting	95
Meaningless characters print	95
Ink is smearing	96
Ink is not filling the text or graphics completely	96
Output is faded or dull colored	97
Colors are printing as black and white	97
Wrong colors are printing	97
Printout shows bleeding colors	97
The printout has a horizontal band of distortion near the bottom of a borderless print	98
Colors do not line up correctly	98
Text or graphics are streaked	99
Something on the page is missing or incorrect	99
Printhead maintenance	99
To check printhead health	100
To print the print quality diagnostic page	100
To align the printheads	101
To calibrate the linefeed	102
To clean the printheads	102
To clean the printhead contacts manually	103
To replace the printheads	105
Solve paper-feed problems	108

Contents

Solve copy problems	109
No copy came out	109
Copies are blank	110
Documents are missing or faded	110
Size is reduced	110
Copy quality is poor	111
Copy defects are apparent	111
The printer prints half a page, then ejects the paper	112
Paper mismatch	112
Solve scan problems	112
Scanner did nothing	112
Scan takes too long	113
Part of the document did not scan or text is missing	113
Text cannot be edited	113
Error messages appear	114
Scanned image quality is poor	114
Scan defects are apparent	115
Solve fax problems	116
The fax test failed	116
Solve problems using HP Web sites and services	129
Solve problems using HP Web services	129
Solve problems using HP Web sites	130
Solve HP Digital Solutions problems	130
Solving HP Direct Digital Filing problems	130
Common problems	130
Unable to scan to network folder	131
Unable to scan to e-mail	132
The sharing dialog box is different after setting up HP Direct Digital Filing (Windows)	132
Solving HP Digital Fax problems	132
Solve memory device problems	134
The printer cannot read the memory device	134
The printer cannot read photos on the memory device	135
Solve wired (Ethernet) network problems	135
General network troubleshooting	135
Network port created does not match printer IP address (Windows)	136
Solve wireless problems	136
Basic wireless troubleshooting	136
Advanced wireless troubleshooting	137
Step 1: Make sure your computer is connected to your network	137
Step 2: Make sure that the printer is connected to your network	138
Step 3: Check to see if the firewall software is blocking communication	139
Step 4: Make sure the printer is online and ready	140
Step 5: Make sure the wireless version of the printer is set as the default printer driver (Windows only)	140
Step 6: Make sure the HP Network Devices Support service is running (Windows only)	141
Add hardware addresses to a wireless access point (WAP)	141
Configure your firewall to work with printers	142

Solve printer management problems	143
Embedded Web server cannot be opened	144
Troubleshoot installation issues	145
Hardware installation suggestions	145
HP software installation suggestions	145
Solve network problems	146
Understand the Self Test Diagnostic Page	147
Understand the network configuration page	148
Clear jams	150
Clear paper jams	151
Avoid paper jams	153
A Technical information	
Warranty information	154
Hewlett-Packard limited warranty statement	155
Ink cartridge warranty information	156
Printer specifications	157
Physical specifications	157
Product features and capacities	157
Processor and memory specifications	158
System requirements	158
Network protocol specifications	159
Embedded Web server specifications	159
Media specifications	159
Understand specifications for supported media	160
Set minimum margins	163
Guidelines for printing on both sides of a page	163
Print specifications	164
Copy specifications	164
Fax specifications	164
Scan specifications	165
HP Web site specifications	165
Environmental specifications	165
Electrical specifications	165
Acoustic emission specifications	166
Memory device specifications	166
Memory card specifications	166
USB flash drives	166

Contents

Regulatory information	167
FCC statement	168
Notice to users in Korea	168
VCCI (Class B) compliance statement for users in Japan	168
Notice to users in Japan about the power cord	169
Noise emission statement for Germany	169
LED indicator statement	169
Gloss of housing of peripheral devices for Germany	169
Notice to users of the U.S. telephone network: FCC requirements	170
Notice to users of the Canadian telephone network	171
Notice to users in the European Economic Area	172
Notice to users of the German telephone network	172
Australia wired fax statement	172
Regulatory information for wireless products	172
Exposure to radio frequency radiation	173
Notice to users in Brazil	173
Notice to users in Canada	173
Notice to users in Taiwan	174
European Union regulatory notice	175
Regulatory model number	175
Declaration of conformity	176
Environmental product stewardship program	177
Paper use	177
Plastics	177
Material safety data sheets	177
Recycling program	177
HP inkjet supplies recycling program	177
Disposal of waste equipment by users in private households in the European Union	178
Power consumption	179
Chemical Substances	179
RoHS notices (China only)	179
Third-party licenses	180
B HP supplies and accessories	
Order printing supplies online	188
Supplies	188
Ink cartridges and printheads	188
HP media	189

C	Additional fax setup	
	Set up faxing (parallel phone systems)	190
	Select the correct fax setup for your home or office	191
	Case A: Separate fax line (no voice calls received)	193
	Case B: Set up the printer with DSL	194
	Case C: Set up the printer with a PBX phone system or an ISDN line	195
	Case D: Fax with a distinctive ring service on the same line	196
	Case E: Shared voice/fax line	197
	Case F: Shared voice/fax line with voice mail	198
	Case G: Fax line shared with computer modem (no voice calls received)	199
	Set up the printer with a computer dial-up modem	199
	Set up the printer with a computer DSL/ADSL modem	201
	Case H: Shared voice/fax line with computer modem	202
	Shared voice/fax with computer dial-up modem	202
	Shared voice/fax with computer DSL/ADSL modem	204
	Case I: Shared voice/fax line with answering machine	206
	Case J: Shared voice/fax line with computer modem and answering machine	207
	Shared voice/fax line with computer dial-up modem and answering machine	207
	Shared voice/fax line with computer DSL/ADSL modem and answering machine	209
	Case K: Shared voice/fax line with computer dial-up modem and voice mail	211
	Serial-type fax setup	213
	Test fax setup	213
D	Network setup	
	Change basic network settings	215
	View and print network settings	215
	Turn the wireless radio on and off	215
	Change advanced network settings	215
	Set link speed	216
	View IP settings	216
	Change IP settings	216
	Configure the printer's firewall settings	216
	Creating and using firewall rules	217
	Reset network settings	219
	Set up the printer for wireless communication	219
	To set up a wireless communication using the Wireless Setup Wizard	219
	Understand 802.11 wireless network settings	220
	Test the wireless connection	221
	Change the connection method	221
	Guidelines for ensuring wireless network security	221
	To add hardware addresses to a WAP	222
	Other guidelines	222
	Guidelines for reducing interference on a wireless network	222
	Uninstall and reinstall the HP software	222
E	Printer management tools	
	HP printer software (Windows)	225
	HP Utility (Mac OS X)	225

Contents

Embedded Web server	225
About cookies	226
To open the embedded Web server	226
Index	233

1 Get started

This guide provides details about how to use the printer and how to resolve problems.

- [Accessibility](#)
- [Eco-Tips](#)
- [Understand the printer parts](#)
- [Use the printer control panel](#)
- [Finding the printer model number](#)
- [Select print media](#)
- [Load an original on the scanner glass](#)
- [Load an original in the automatic document feeder \(ADF\)](#)
- [Load media](#)
- [Insert a memory device](#)
- [Install the accessories](#)
- [Maintain the printer](#)
- [Turn the printer off](#)

 **NOTE:** If you are using the printer with a computer running Windows XP Starter Edition, Windows Vista Starter Edition, or Windows 7 Starter Edition, some features might not be available. For more information, see [Operating system compatibility](#).

Accessibility

The printer provides a number of features that make it accessible for people with disabilities.

Visual

The HP software provided with the printer is accessible for users with visual impairments or low vision by using your operating system's accessibility options and features. The software also supports most assistive technology such as screen readers, Braille readers, and voice-to-text applications. For users who are color blind, colored buttons and tabs used in the HP software and on the printer control panel have simple text or icon labels that convey the appropriate action.

Mobility

For users with mobility impairments, the HP software functions can be executed through keyboard commands. The HP software also supports Windows accessibility options such as StickyKeys, ToggleKeys, FilterKeys, and MouseKeys. The printer doors, buttons, paper trays, and paper guides can be operated by users with limited strength and reach.

Support

For more details about the accessibility of this printer and HP's commitment to product accessibility, visit HP's Web site at www.hp.com/accessibility.

For accessibility information for Mac OS X, visit the Apple Web site at www.apple.com/accessibility.

Eco-Tips

HP is committed to helping customers reduce their environmental footprint. HP has provided these Eco-Tips to help you focus on ways to assess and reduce the impact of your printing choices. In addition to specific features in this printer, please visit the HP Eco Solutions Web site for more information on HP's environmental initiatives.

www.hp.com/hpinfo/globalcitizenship/environment/

- **Duplex printing:** Use **Paper-saving Printing** to print two-sided documents with multiple pages on same sheet to reduce paper usage. For more information, see [Print on both sides \(duplexing\)](#).
- **Energy Savings Information:** To determine the ENERGY STAR® qualification status for this printer, see [Power consumption](#).
- **Recycled Materials:** For more information regarding recycling of HP products, please visit: www.hp.com/hpinfo/globalcitizenship/environment/recycle/

Understand the printer parts

This section contains the following topics:

- [Front view](#)
- [Printing supplies area](#)
- [Back view](#)

Front view

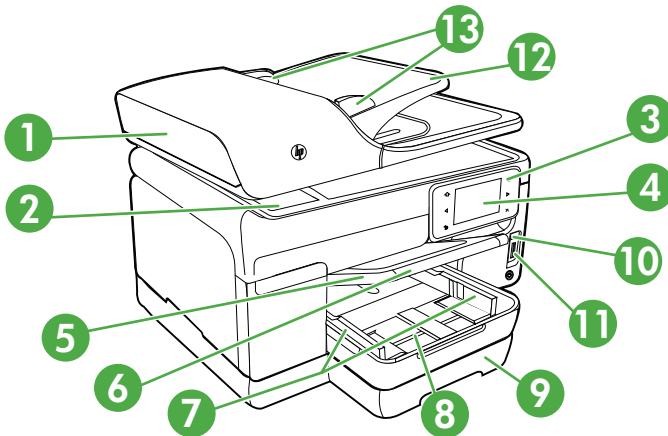

1	Automatic document feeder (ADF)
2	Scanner glass
3	Control panel (differs based on the printer model that you have)
4	Control-panel display (differs based on the printer model that you have)
5	Output tray
6	Output tray extension
7	Width guides
8	Tray 1
9	Tray 2 (available with some models)
10	Front universal serial bus (USB) port (PictBridge-enabled)
11	Memory card slots
12	Document feeder tray
13	Width guides

Printing supplies area

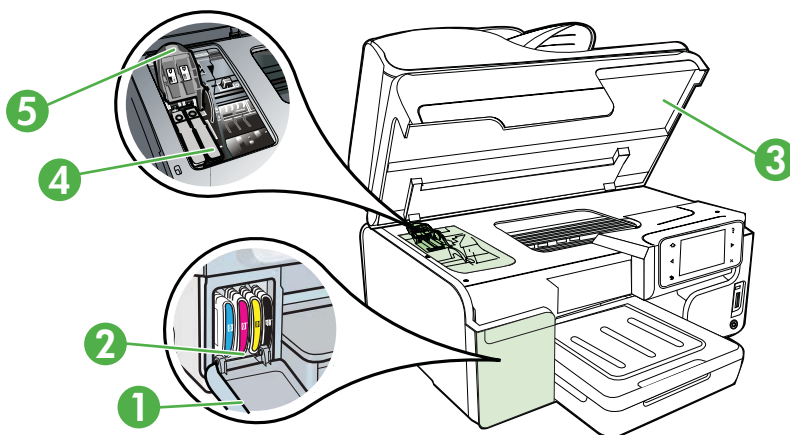

1	Ink cartridge door
2	Ink cartridges
3	Print-carriage access door
4	Printhead latch
5	Printheads

Back view

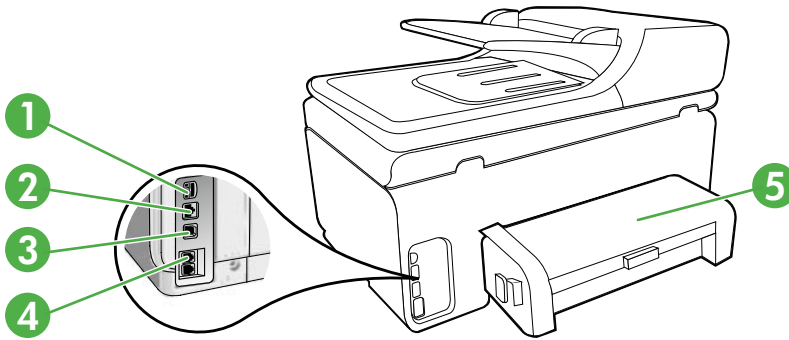

1	Power input
2	Ethernet network port
3	Rear universal serial bus (USB) port
4	Fax ports (1-LINE and 2-EXT)
5	Automatic two-sided printing accessory (duplexer)

Use the printer control panel

This section contains the following topics:

- [Overview of buttons and lights](#)
- [Control-panel display icons](#)
- [Change printer settings](#)

Overview of buttons and lights

The following diagrams and related tables provide a quick reference to the printer control panel features for each printer model. For more information, see [Finding the printer model number](#)

HP Officejet Pro 8500A (A910a-f)

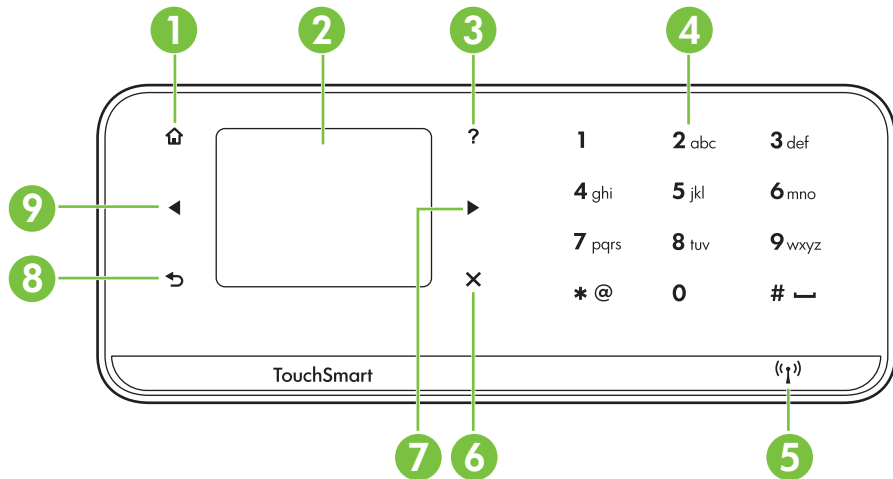





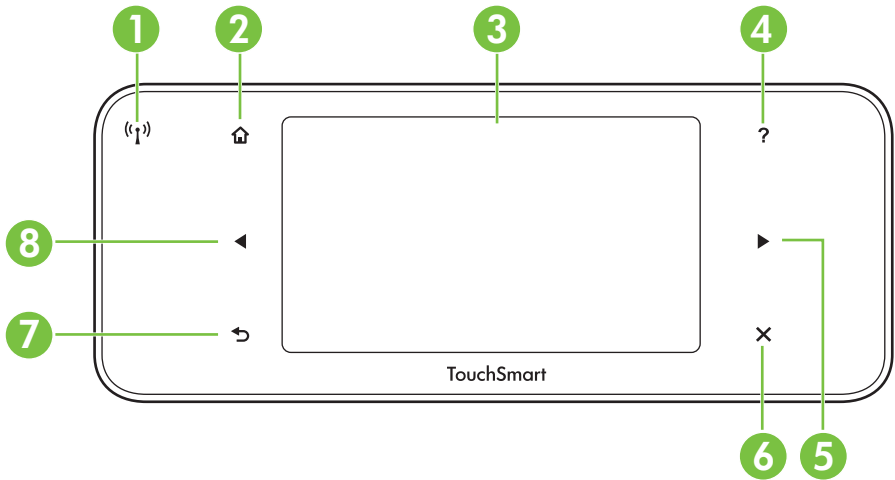

Label	Name and Description
1	Home button: Press this button to return to the home screen from any other screen.
2	Control-panel display: Touch the screen to select menu options. For information about the icons that appear on the display, see Control-panel display icons .
3	Help button: Opens the Help menu.
4	Keypad: Use the keypad to enter numbers and text.
5	Wireless button: The button is lit when the 802.11 wireless feature is on. Touch this button to view or print the Wireless Summary or to access Setup options and the Network Menu.
6	Cancel: Stops a job, exits a menu, or exits settings.
7	Right arrow button: Navigates through settings in the menus.
8	Back button: Touch this button to return to the previous menu.
9	Left arrow button: Navigates through settings in the menus.

HP OfficeJet Pro 8500A (A910g-z)

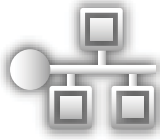







Label	Name and Description
1	Wireless icon: The button is lit when the 802.11 wireless feature is on. Touch this button to view or print the Wireless Summary or to access Setup options and the Network Menu.
2	Home: Press this to return to the home screen from any other screen.
3	Control-panel display: Touch the screen to select menu options. For information about the icons that appear on the display, see Control-panel display icons .
4	Help button: Opens the Help menu.
5	Right arrow button: Navigates through settings in the menus.
6	Cancel: Stops a job, exits a menu, or exits settings.
7	Back button: Touch this button to return to the previous menu.
8	Left arrow button: Navigates through settings in the menus.

Control-panel display icons

Icon	Purpose
	<p>Shows that a wired network connection exists.</p>
	<p>Shows that a wireless network connection exists. The signal strength is indicated by the number of curved lines. This is for infrastructure mode. For more information, see Set up the printer for wireless communication.</p>
	<p>Shows that ePrint is turned on. For more information, see HP ePrint.</p>
	<p>Displays screen where you can make copies or select other options.</p>
	<p>Displays screen where you can make a fax, or choose fax settings.</p>
	<p>Displays a screen where you can make a scan, or change scan settings.</p>

(continued)

Icon	Purpose
 The icon shows a blue globe with a grid pattern, a document with a blue header, and a black square with a white downward-pointing arrow and the text 'HP Apps'.	Displays a screen where you can use HP Apps. For more information, see HP Apps
 The icon shows a stack of printed photos with a blue and orange landscape scene.	Displays the Photo screen for selecting options.
 The icon shows a wrench and a gear.	Displays the Setup screen for generating reports, changing fax and other maintenance settings, and accessing the Help screen. The topic that you select from the Help screen opens a help window on your computer screen.
 The icon shows a blue Ethernet cable plugged into a black network port with green wireless signal waves emanating from it.	Displays the Network screen for selecting options. Officejet Pro 8500A (A910g-z only)
 The icon shows a blue book with a magnifying glass over it.	Provides more information about the printer's features. Officejet Pro 8500A (A910g-z only)
 The icon shows a blue ink cartridge with a blue drop of ink above it, all inside a white box.	Displays screen where you can see information about the ink cartridges, including fill levels. This icon has a red border when an ink cartridge needs attention. Officejet Pro 8500A (A910a-f only) NOTE: Ink level warnings and indicators provide estimates for planning purposes only. When you receive a low-ink warning message, consider having a replacement cartridge available to avoid possible printing delays. You do not need to replace cartridges until prompted to do so.
 The icon shows a green telephone handset with a grey arrow pointing towards it.	Displays the status of the Auto Answer function. Touch Auto Answer to turn it on or off. For more information, see Set the answer mode (Auto answer) . Officejet Pro 8500A (A910a-f only)

Change printer settings

Use the control panel to change the printer's mode and settings, print reports, or get help for the printer.



 **TIP:** If the printer is connected to a computer, you can also change the printer settings using HP software tools available on your computer, such as the HP printer software, the HP Utility (Mac OS X), or the EWS. For more information about these tools, see [Printer management tools](#).

This section contains the following topics:



- [Select the mode](#)
- [Change printer settings](#)

Select the mode

The main menu of the control-panel display shows the available modes for the printer.



 **NOTE:** To select a mode, touch the left arrow  or the right arrow  to see the available modes, and then touch the icon to select the desired mode. Follow the prompts on the control-panel display to complete the job. The control-panel display returns to the main menu when the job is finished.

To select a different mode

Touch the  to return to the main menu. Touch left arrow  or right arrow  to scroll through the available modes, and then touch the icon to select the desired mode.

To change settings for a mode



1. After selecting a mode, touch the arrow buttons to scroll through the available settings, and then touch the setting you want to change.
2. Follow the prompts on the display to change the settings, and then touch **Done**.

 **NOTE:** Use the  button to return to the previous menu.

Change printer settings

To change the printer settings or print reports, use the options available in the Setup menu:

1. Touch right arrow , and then touch **Setup**.
2. Touch the arrow buttons to scroll through the menus.
3. Touch the menu items to select menus or options.

 **NOTE:** Use the  button to return to the previous menu.

Finding the printer model number

In addition to the model name that appears on the front of the printer, this printer has a specific model number. You can use this number when obtaining support and to help determine which supplies or accessories are available for your printer.

The model number is printed on a label located inside the printer, near the ink cartridges area.

Select print media

The printer is designed to work well with most types of office media. It is best to test a variety of print media types before buying large quantities. Use HP media for optimum print quality. Visit the HP Web site at www.hp.com for more information about HP media.

	<p>HP recommends plain papers with the ColorLok logo for printing and copying of everyday documents. All papers with the ColorLok logo are independently tested to meet high standards of reliability and print quality, and produce documents with crisp, vivid color, bolder blacks and dry faster than ordinary plain papers. Look for papers with the ColorLok logo in a variety of weights and sizes from major paper manufacturers.</p>
---	---

This section contains the following topics:

- [Recommended papers for printing and copying](#)
- [Recommended papers for photo printing](#)
- [Tips for selecting and using media](#)

Recommended papers for printing and copying

If you want the best print quality, HP recommends using HP papers that are specifically designed for the type of project you are printing.

Depending on your country/region, some of these papers might not be available.

<p>HP Brochure Paper HP Superior Inkjet Paper</p>	<p>These papers are glossy-coated or matte-coated on both sides for two-sided use. They are the perfect choice for near-photographic reproductions and business graphics for report covers, special presentations, brochures, mailers, and calendars.</p>
<p>HP Bright White Inkjet Paper</p>	<p>HP Bright White Inkjet Paper delivers high-contrast colors and sharp text. It is opaque enough for two-sided color usage with no show-through, which makes it ideal for newsletters, reports, and flyers. It features ColorLok Technology for less smearing, bolder blacks and vivid colors.</p>
<p>HP Printing Paper</p>	<p>HP Printing Paper is a high-quality multifunction paper. It produces documents that look and feel more substantial than documents printed on standard multipurpose or copy paper. It features ColorLok Technology for less smearing, bolder blacks and vivid colors. It is acid-free for longer lasting documents.</p>
<p>HP Office Paper</p>	<p>HP Office Paper is a high-quality multifunction paper. It is suitable for copies, drafts, memos and other everyday documents. It features ColorLok Technology for less smearing, bolder blacks and vivid colors. It is acid-free for longer lasting documents</p>
<p>HP Office Recycled Paper</p>	<p>HP Office Recycled Paper is a high-quality multifunction paper made with 30% recycled fiber. It features ColorLok Technology for less</p>

(continued)

	smearing, bolder blacks and vivid colors. It is acid-free for longer lasting documents.
HP Premium Presentation Paper HP Professional Paper	These papers are heavy two-sided matte papers perfect for presentation, proposals, reports and newsletters. They are heavyweight for an impressive look and feel.
HP Premium Inkjet Transparency Film	HP Premium Inkjet Transparency Film makes your color presentations vivid and even more impressive. This film is easy to use and handle and dries quickly without smudging.
HP Advanced Photo Paper	This thick photo paper features an instant-dry finish for easy handling without smudging. It resists water, smears, fingerprints, and humidity. Your prints have a look and feel comparable to a store processed photo. It is available in several sizes, including A4, 8.5 x 11 inch, 10 x 15 cm (4 x 6 inch), 13x18 cm (5 x7 inch) and two finishes – glossy or soft gloss (satin matte). It is acid-free for longer lasting documents.
HP Everyday Photo Paper	Print colorful, everyday snapshots at a low cost, using paper designed for casual photo printing. This affordable, photo paper dries quickly for easy handling. Get sharp, crisp images when you use this paper with any inkjet printer. Available in semi-gloss finish in 8.5 x11 inch, A4, 4 x 6 inch and 10 x 15 cm. It is acid-free for longer lasting documents.
HP Iron-On Transfers	HP Iron-on Transfers (for color fabrics or for light or white fabrics) are the ideal solution for creating custom T-shirts from your digital photos.

To order HP papers and other supplies, go to www.hp.com/buy/supplies. If prompted, select your country/region, follow the prompts to select your printer, and then click one of the shopping links on the page.

 **NOTE:** At this time, some portions of the HP Web site are available in English only.

Recommended papers for photo printing

If you want the best print quality, HP recommends using HP papers that are specifically designed for the type of project you are printing.

Depending on your country/region, some of these papers might not be available.

HP Advanced Photo Paper

This thick photo paper features an instant-dry finish for easy handling without smudging. It resists water, smears, fingerprints, and humidity. Your prints have a look and feel comparable to a store processed photo. It is available in several sizes, including A4, 8.5 x 11 inch, 10 x 15 cm (4 x 6 inch), 13 x 18 cm (5 x 7 inch) and two finishes – glossy or soft gloss (satin matte). It is acid-free for longer lasting documents.

HP Everyday Photo Paper

Print colorful, everyday snapshots at a low cost, using paper designed for casual photo printing. This affordable, photo paper dries quickly for easy handling. Get sharp, crisp images when you use this paper with any inkjet printer. Available in semi-gloss finish in 8.5 x 11 inch, A4, 4 x 6 inch and 10 x 15 cm. It is acid-free for longer lasting documents.

HP Photo Value Packs

HP Photo Value Packs conveniently package Original HP ink cartridges and HP Advanced Photo Paper to save you time and take the guesswork out of printing affordable professional photos with your HP printer. Original HP inks and HP Advanced Photo Paper have been designed to work together so your photos are long lasting and vivid, print after print. Great for printing out an entire vacation's worth of photos or multiple prints to share.

To order HP papers and other supplies, go to www.hp.com/buy/supplies. If prompted, select your country/region, follow the prompts to select your printer, and then click one of the shopping links on the page.

 **NOTE:** At this time, some portions of the HP Web site are available in English only.

Tips for selecting and using media

For the best results, observe the following guidelines.

- Always use media that conforms to the printer specifications. For more information, see [Media specifications](#).
- Load only one type of media at a time into a tray or automatic document feeder (ADF) (some models only).
- When loading the trays and ADF (some models only), make sure the media is loaded correctly. For more information, see [Load media](#) or [Load an original in the automatic document feeder \(ADF\)](#).
- Do not overload the tray or ADF (some models only). For more information, see [Load media](#) or [Load an original in the automatic document feeder \(ADF\)](#).
- To prevent jams, poor print quality, and other printing problems, avoid loading the following media in the trays or ADF (some models only):
 - Multipart forms
 - Media that is damaged, curled, or wrinkled
 - Media with cutouts or perforations
 - Media that is heavily textured, embossed, or does not accept ink well
 - Media that is too lightweight or stretches easily
 - Media that contains staples or clips

 **NOTE:** To scan, copy, or fax documents that contain pages that do not conform to these guidelines, use the scanner glass. For more information, see [Load an original on the scanner glass](#).

Load an original on the scanner glass

You can copy, scan, or fax up to Letter- or A4-size originals by loading them on the glass.

 **NOTE:** Many of the special features do not work correctly if the glass and lid backing are not clean. For more information, see [Maintain the printer](#).

To load an original on the scanner glass

Use these steps to load an original on the scanner glass.

1. Lift the scanner lid.
2. Load your original print-side down.

 **TIP:** For more help on loading an original, refer to the engraved guides along the edge of the glass.

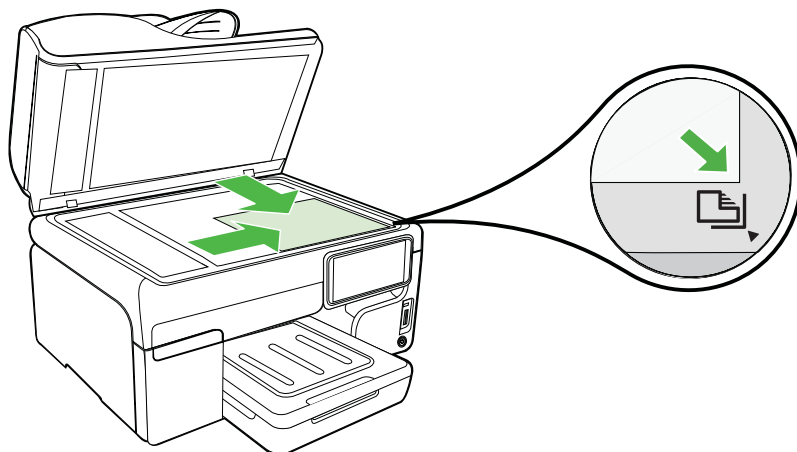

3. Close the lid.

Load an original in the automatic document feeder (ADF)

You can copy, scan, or fax a one-sided, single- or multiple-page, A4- or Letter-size document by placing it in the automatic document feeder tray.

 **CAUTION:** Do not load photos in the ADF; this might cause damage to your photos.

 **NOTE:** Two-sided Legal-size documents cannot be scanned, copied, or faxed using the ADF.

NOTE: Some features, such as the **Fit to Page** copy feature, do not work when you load your originals in the ADF. You must load your originals on the glass.

The document feeder tray holds a maximum of 35 or 50 sheets of plain paper, depending on the printer model.

To load an original in the document feeder tray

Use these steps to load a document in the automatic document feeder.

1. Load your original print-side up into the document feeder tray. Place the pages so that the top edge of the document goes in first. Slide the media into the automatic

document feeder until you hear a tone or see a message on the display indicating that the loaded pages were detected.

 **TIP:** For more help on loading originals in the automatic document feeder, refer to the diagram engraved in the document feeder tray.

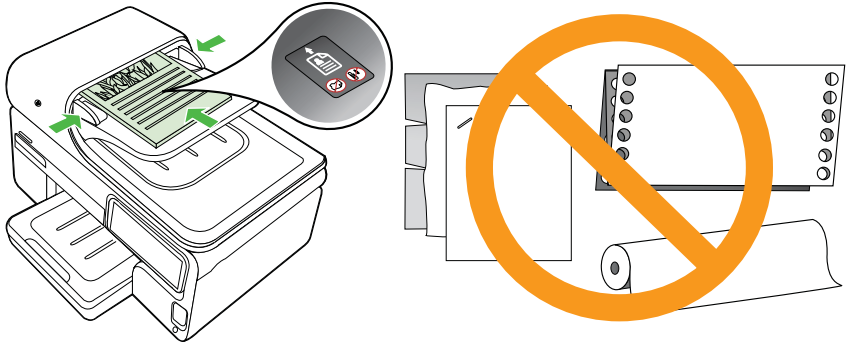

2. Slide the width guides inward until they stop at the left and right edges of the media.

 **NOTE:** Remove all originals from the document feeder tray before lifting the lid on the printer.

Load media

This section provides instructions for loading media into the printer.

This section contains the following topics:

- [Load standard-size media](#)
- [Load envelopes](#)
- [Load cards and photo paper](#)
- [Load transparencies](#)
- [Load custom-size media](#)

Load standard-size media

To load media

Use these instructions to load standard media.

1. Lift the output tray.
2. Slide the paper width guide out as far as possible.

 **NOTE:** If you are loading larger sized media, pull the input tray to extend it.

3. Insert the media print-side down along the right of the main tray. Make sure the stack of media aligns with the right and back edges of the tray, and does not exceed the line marking in the tray.

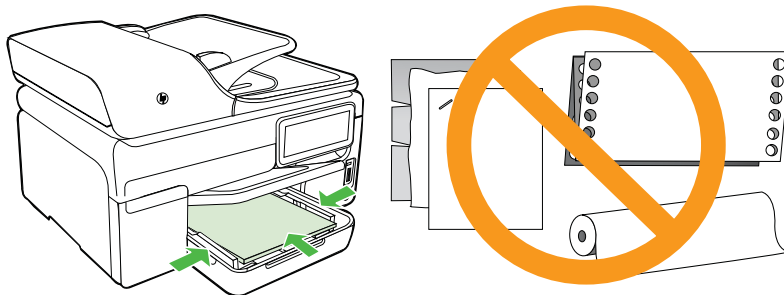

 **NOTE:** Do not load paper while the printer is printing.

4. Slide the media guides in the tray to adjust them for the media size that you have loaded.
5. Lower the output tray.
6. Pull out the tray extender.

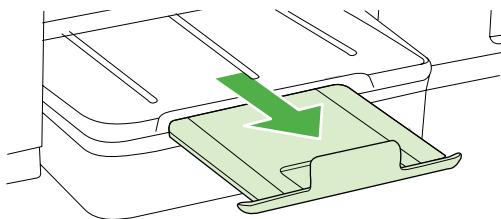

Load envelopes

To load envelopes

Use these instructions to load an envelope

1. Lift the output tray.
2. Slide the paper width guide out as far as possible.

 **NOTE:** If you are loading larger sized media, pull the input tray to extend it.

3. Load envelopes according to the graphic. Make sure the stack of envelopes does not exceed the line marking in the tray.

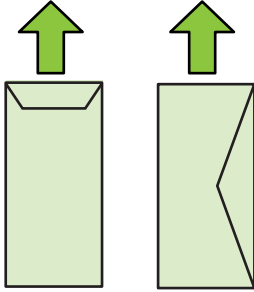

 **NOTE:** Do not load paper while the printer is printing.

4. Slide the media guides in the tray to adjust them for the media size that you have loaded.
5. Lower the output tray.
6. Pull out the tray extender.

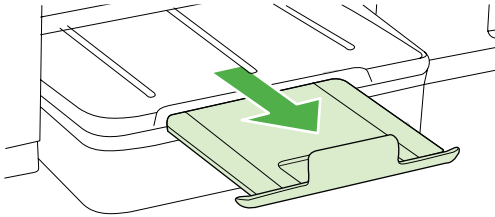

Load cards and photo paper

To load cards and photo paper

Use these instructions to load photo paper.

1. Lift the output tray.
2. Slide the paper width guide out as far as possible.

 **NOTE:** If you are loading larger sized media, pull the input tray to extend it.

3. Insert the media print-side down along the right of the main tray. Make sure the stack of media aligns with the right and back edges of the tray, and does not exceed the line marking in the tray. If the photo paper has a tab along one edge, make sure the tab is pointing towards the front of the printer.

 **NOTE:** Do not load paper while the printer is printing.

4. Slide the media guides in the tray to adjust them for the media size that you have loaded.

5. Lower the output tray.
6. Pull out the tray extender.

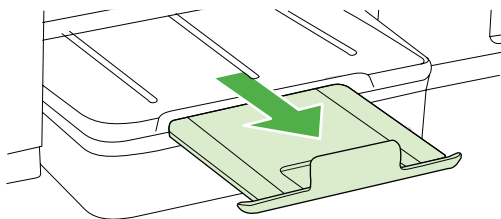

Load transparencies

To load transparencies

1. Lift the output tray.
2. Slide the paper width guide out as far as possible.

 **NOTE:** If you are loading larger sized media, pull the input tray to extend it.

3. Insert the transparencies, rough-side or print-side down, along the right of the main tray. Make sure the adhesive strip is pointing towards the back of the printer and that the stack of transparencies aligns with the right and back edges of the tray. Also, make sure the stack does not exceed the line marking in the tray.

 **NOTE:** Do not load paper while the printer is printing.

4. Slide the media guides in the tray to adjust them for the media size that you have loaded.
5. Lower the output tray.
6. Pull out the tray extender.

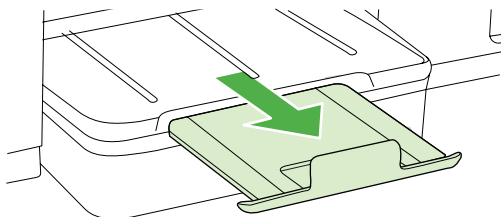

Load custom-size media

To load cards and photo paper

Use these instructions to load custom-size media.

 **CAUTION:** Use only custom-size media that is supported by the printer. For more information, see [Media specifications](#).

1. Lift the output tray.
2. Slide the paper width guide out as far as possible.

 **NOTE:** If you are loading larger sized media, pull the input tray to extend it.

3. Insert the media print-side down along the right of the main tray. Make sure the stack of media aligns with the right and back edges of the tray, and does not exceed the line marking in the tray.

 **NOTE:** Do not load paper while the printer is printing.

4. Slide the media guides in the tray to adjust them for the media size that you have loaded.
5. Lower the output tray.
6. Pull out the tray extender.

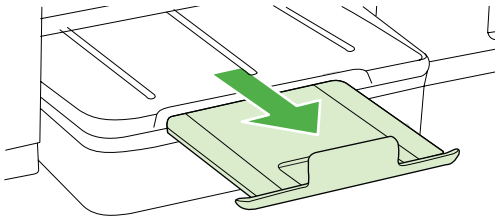

Insert a memory device

If your digital camera uses a memory card to store photos, you can insert the memory card into the printer to print or save your photos.

 **CAUTION:** Attempting to remove a memory card while it is being accessed can damage files on the card. You can safely remove a card only when the photo light is not blinking. Also, never insert more than one memory card at a time as this can also damage files on the memory cards.

 **NOTE:** The printer does not support encrypted memory cards.

For more information on the supported memory cards, see [Memory device specifications](#).

To insert a memory card

1. Turn the memory card so that the label faces up, and the contacts are facing the printer.
2. Insert the memory card into the corresponding memory card slot.

 **NOTE:** You cannot insert more than one memory card in the printer.

To connect a storage device

1. If you are connecting a digital camera, change the USB mode of the camera to storage mode, and then connect one end of the USB cable to the camera.



NOTE: Different cameras use different terms to describe the storage mode. For instance, some cameras have a digital camera setting and a disk drive setting. In this instance, the disk drive setting is the storage mode setting. If storage mode does not work on your camera, you might need to upgrade the camera firmware. For more information, see the documentation that came with the camera.

2. Insert the USB storage device or the other end of the camera's USB cable to the USB port on the front of the printer.



NOTE: If your USB device does not fit into this port due to size limitations, or if the connector on the device is shorter than 11 mm (0.43 in), you will need to purchase a USB extension cable in order to use your device with this port. For more information on supported USB devices, see [Memory card specifications](#).

Install the accessories

This section contains the following topics:

- [Install the duplexer](#)
- [Install Tray 2](#)
- [Turn on accessories in the printer driver](#)

Install the duplexer

You can print on both sides of a sheet of paper automatically. For information on using the duplexer, see [Print on both sides \(duplexing\)](#).

To install the duplexer

- ▲ Slide the duplexer into the printer until the unit locks into place. Do not press the buttons on either side of the duplexer when installing the unit; use them only for removing the unit from the printer.

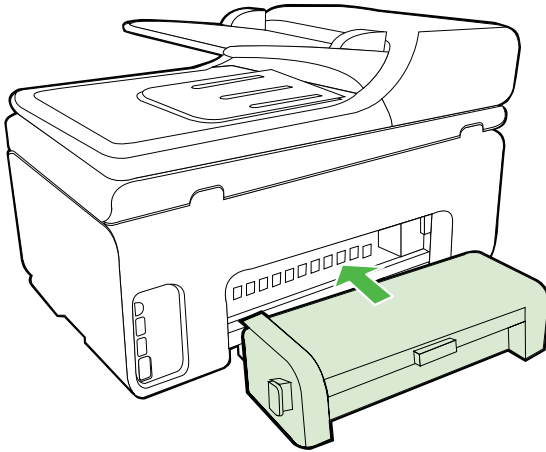

Install Tray 2

 **NOTE:** This feature is available with some models of the printer.

Tray 2 can hold up to 250 sheets of plain paper. For ordering information, see [HP supplies and accessories](#).

To install Tray 2

1. Unpack the tray, remove the packing tapes and materials, and move the tray to the prepared location. The surface must be sturdy and level.
2. Turn off the printer, and disconnect the power cord.
3. Set the printer on top of the tray.

△ **CAUTION:** Be careful to keep your fingers and hands clear of the bottom of the printer.

4. Connect the power cord and turn on the printer.
5. Enable Tray 2 in the printer driver. For more information, see [Turn on accessories in the printer driver](#).

Turn on accessories in the printer driver

- [To turn on accessories on Windows computers](#)
- [To turn on accessories on Macintosh computers](#)

To turn on accessories on Windows computers

1. Click **Start**, point to **Settings**, and then click **Printers** or **Printers and Faxes**.
- Or -
Click **Start**, click **Control Panel**, and then double-click **Printers**.
2. Right-click the printer icon, and then click **Properties**.
3. Select the **Device Settings** tab. Click the accessory that you want to turn on, click **Installed** from the drop-down menu, and then click **OK**.

To turn on accessories on Macintosh computers

The Mac OS automatically turns on all accessories in the printer driver when you install the printer software. If you add a new accessory later, follow these steps:

1. Open the **System Preferences** and then select **Print & Fax**.
2. Click **Options & Supplies**.
3. Click the **Driver** tab.
4. Select the options you want to install, and then click **OK**.

Maintain the printer

This section provides instructions for keeping the printer in top working condition. Perform these maintenance procedures as necessary.

- [Clean the scanner glass](#)
- [Clean the exterior](#)
- [Clean the automatic document feeder](#)

Clean the scanner glass

 **NOTE:** Dust or dirt on the scanner glass, scanner lid backing, or scanner frame can slow down performance, degrade the quality of scans, and affect the accuracy of special features such as fitting copies to a certain page size.

To clean the scanner glass

1. Turn the printer off. For more information, see [Turn the printer off](#).
2. Lift the scanner lid.

3. Clean the glass by using a soft, lint-free cloth that has been sprayed with a mild glass cleaner. Dry the glass with a dry, soft, lint-free cloth.

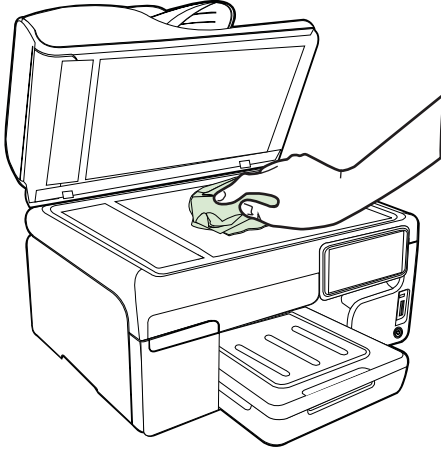

△ **CAUTION:** Use only glass cleaner to clean the scanner glass. Avoid cleaners that contain abrasives, acetone, benzene, and carbon tetrachloride, all of which can damage the scanner glass. Avoid isopropyl alcohol because it can leave streaks on the glass.

CAUTION: Do not spray the glass cleaner directly on the glass. If too much glass cleaner is applied, the cleaner could leak under the glass and damage the scanner.

4. Close the scanner lid, and turn on the printer.

Clean the exterior

△ **WARNING!** Before cleaning the printer, turn off the power and unplug the power cord from the electrical socket.

Use a soft, damp, lint-free cloth to wipe dust, smudges, and stains off of the case. The exterior of the printer does not require cleaning. Keep fluids away from the interior of the printer, as well as from the printer control panel.

Clean the automatic document feeder

If the automatic document feeder picks up multiple pages or if it does not pick up plain paper, you can clean the rollers and separator pad. Lift the automatic document feeder

cover to access the pick assembly inside the automatic document feeder, clean the rollers or separator pad, and then close the cover.

To clean the rollers or separator pad

1. Remove all originals from the document feeder tray.
2. Lift the automatic document feeder cover (1).
This provides easy access to the rollers (2) and separator pad (3).

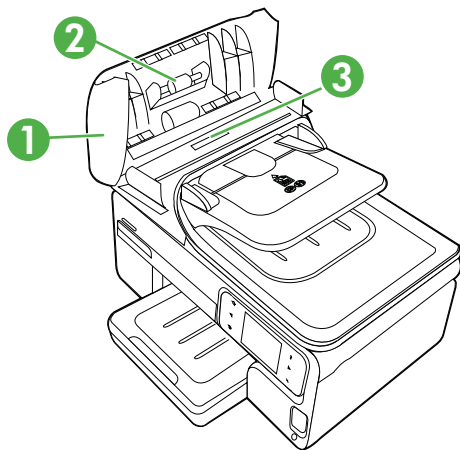

1	Automatic document feeder cover
2	Rollers
3	Separator pad

3. Lightly dampen a clean lint-free cloth with distilled water, then squeeze any excess liquid from the cloth.
4. Use the damp cloth to wipe any residue off the rollers or separator pad.

 **NOTE:** If the residue does not come off using distilled water, try using isopropyl (rubbing) alcohol.

5. Close the cover of the automatic document feeder.







Turn the printer off

Turn the printer off by pressing the **Power** button located on the printer. Wait until the power light turns off before unplugging the power cord or turning off a power strip. If you incorrectly turn the printer off, the print carriage might not return to the correct position causing problems with the ink cartridges and print quality issues.

2 Print

Most print settings are automatically handled by the software application. Change the settings manually only when you want to change print quality, print on specific types of paper, or use special features. For more information about selecting the best print media for your documents, see [Select print media](#).

Choose a print job to continue:

	Print documents
	Print brochures
	Print on envelopes
	Print photos
	Print on special and custom-size paper
	Print borderless documents

Print documents

 **NOTE:** With certain types of paper, you can print on both sides of a sheet of paper (called “two-sided printing” or “duplex printing”). For more information, see [Print on both sides \(duplexing\)](#).

NOTE: You can print from anywhere by using HP's ePrint feature. For more information, see [HP ePrint](#).

Follow the instructions for your operating system.

- [Print documents \(Windows\)](#)
- [Print documents \(Mac OS X\)](#)

Print documents (Windows)

1. Load paper in the tray. For more information, see [Load media](#).
2. On the **File** menu in your software application, click **Print**.
3. Make sure the printer you want to use is selected.
4. To change settings, click the button that opens the **Properties** dialog box. Depending on your software application, this button might be called **Properties**, **Options**, **Printer Setup**, **Printer**, or **Preferences**.
5. Change the paper orientation on the **Layout** tab, and paper source, media type, paper size, and quality settings on the **Paper/Quality** tab. To print in black and white, click the **Advanced** tab, and then change the **Print in Grayscale** option.
6. Click **OK**.
7. Click **Print** or **OK** to begin printing.

Print documents (Mac OS X)

1. Load paper in the tray. For more information, see [Load media](#).
2. From the **File** menu in your software application, click **Print**.
3. Make sure the printer you want to use is selected.
4. Change the print settings for the option provided in the pop-up menus, as appropriate for your project.



NOTE: Click the blue disclosure triangle next to the **Printer** selection to access these options.

5. Click **Print** to begin printing.

Print brochures



NOTE: You can print from anywhere by using HP's ePrint feature. For more information, see [HP ePrint](#).

Follow the instructions for your operating system.

- [Print brochures \(Windows\)](#)
- [Print brochures \(Mac OS X\)](#)

Print brochures (Windows)



NOTE: To set print settings for all print jobs, make the changes in the HP software provided with the printer. For more information on the HP software, see [Printer management tools](#).

1. Load paper in the tray. For more information, see [Load media](#).
2. On the **File** menu in your software application, click **Print**.
3. Make sure the printer you want to use is selected.
4. To change settings, click the button that opens the **Properties** dialog box. Depending on your software application, this button might be called **Properties**, **Options**, **Printer Setup**, **Printer**, or **Preferences**.
5. Change the paper orientation on the **Layout** tab, and paper source, media type, paper size, and quality settings on the **Paper/Quality** tab. To print in black and white, click the **Advanced** tab, and then change the **Print in Grayscale** option.
6. Click **OK**.
7. Click **OK**.
8. Click **Print** to begin printing.

Print brochures (Mac OS X)

1. Load paper in the tray. For more information, see [Load media](#).
2. From the **File** menu in your software application, click **Print**.
3. Make sure the printer you want to use is selected.
4. Select **Paper Type/Quality** from the pop-up menu (located below the Orientation setting), and then select the following settings:
 - **Paper Type:** the appropriate brochure paper type
 - **Quality:** **Normal** or **Best**



NOTE: Click the blue disclosure triangle next to the **Printer** selection to access these options.

5. Select any other print settings that you want, and then click **Print** to begin printing.

Print on envelopes

When selecting envelopes, avoid envelopes that have a very slick finish, self-stick adhesives, clasps, or windows. Also, avoid envelopes with thick, irregular, or curled edges, or areas that are wrinkled, torn, or otherwise damaged.

Make sure the envelopes you load in the printer are tightly constructed and that the folds are sharply creased.



NOTE: For more information about printing on envelopes, see the documentation available with the software program you are using.

Follow the instructions for your operating system.

- [Print on envelopes \(Windows\)](#)
- [Print on envelopes \(Mac OS X\)](#)

Print on envelopes (Windows)

1. Load envelopes in the tray. For more information, see [Load media](#).
2. On the **File** menu in your software application, click **Print**.
3. Make sure the printer you want to use is selected.

4. To change settings, click the button that opens the **Properties** dialog box. Depending on your software application, this button might be called **Properties**, **Options**, **Printer Setup**, **Printer**, or **Preferences**.
5. On the **Layout** tab, change the orientation to **Landscape**.
6. Click **Paper/Quality**, and then select the appropriate envelope type from the **Paper Size** drop-down list.

 **TIP:** You can change more options for the print job by using the features available on the other tabs in the dialog box.

7. Click **OK**, and then click **Print** or **OK** to begin printing.

Print on envelopes (Mac OS X)

1. Load envelopes in the tray. For more information, see [Load media](#).
2. From the **File** menu in your software application, click **Print**.
3. Make sure the printer you want to use is selected.
4. select the appropriate envelope size in the **Paper Size** pop-up menu.
5. Select the **Orientation** option.

 **NOTE:** If your computer is using Mac OS X (v10.5 or v10.6), click the blue disclosure triangle next to the **Printer** selection to access these options.

6. Select any other print settings that you want, and then click **Print** to begin printing.

Print photos

Do not leave unused photo paper in the input tray. The paper might start to curl, which could reduce the quality of your printout. Photo paper should be flat before printing.

Follow the instructions for your operating system.

- [Print photos on photo paper \(Windows\)](#)
- [Print photos on photo paper \(Mac OS X\)](#)
- [Print photos from a memory device](#)
- [Print DPOF photos](#)

Print photos on photo paper (Windows)

1. Load paper in the tray. For more information, see [Load media](#).
2. On the **File** menu in your software application, click **Print**.
3. Make sure the printer you want to use is selected.
4. To change settings, click the option that opens the printer **Properties** dialog box. Depending on your software application, this option might be called **Properties**, **Options**, **Printer Setup**, **Printer**, or **Preferences**.
5. To print the photo in black and white, click the **Advanced** tab and then change the **Print in Grayscale** option.
6. Click **OK**, and then click **Print** or **OK** to begin printing.

Print photos on photo paper (Mac OS X)

1. Load paper in the tray. For more information, see [Load media](#).
2. From the **File** menu in your software application, click **Print**.
3. Make sure the printer you want to use is selected.
4. Click **Paper Type/Quality** from the pop-up menu (located below the **Orientation** setting), and then select the following settings:
 - **Paper Type:** The appropriate photo paper type
 - **Quality: Best or Maximum dpi**



NOTE: Click the blue disclosure triangle next to the **Printer** selection to access these options.

5. Select the appropriate **Photo Fix** options:
 - **Off:** applies no HP Real Life Technologies to the image.
 - **Basic:** automatically focuses the image; moderately adjusts image sharpness.
6. To print the photo in black and white, click **Grayscale** from the **Color** pop-up menu, and then select one of the following options:
 - **High Quality:** uses all the available colors to print your photo in grayscale. This creates smooth and natural shades of gray.
 - **Black Print Cartridge Only:** uses black ink to print your photo in grayscale. The gray shading is created by varying patterns of black dots, which might result in a grainy image.
7. Select any other print settings that you want, and then click **Print** to begin printing.

Print photos from a memory device

You can insert supported memory cards into the slots located on the front of the printer. In addition, you can connect a USB storage device (such as a keychain drive or portable hard drive) to the USB port on the front of the printer. You can also connect a digital camera in storage mode to the USB port on the front of the printer and print photos directly from the camera.

For more information about using memory devices, see [Insert a memory device](#).

-
- △ **CAUTION:** Attempting to remove a memory device while it is being accessed can damage files on the card. You can safely remove a card only when the status light is not blinking. Also, never insert more than one storage device at a time as this can also damage files on the storage device.
-

To print selected photos



NOTE: This function is only available if the memory device does not contain Digital Print Order Format (DPOF) content.

1. Insert your memory card into the appropriate slot on the printer. The **Photo** screen appears on the control panel display.
 2. Touch **View & Print**. The photos are displayed.
 3. Do one of the following.
 - a. Touch **Select All**.
 - b. Touch **Settings** to make changes to layout, paper type, or date stamp, and then select **Done**.
 - c. Touch **Print**. The preview screen appears. You have options on this screen to adjust the settings or add more photos. Touch the **right** and **left** arrows to preview all photos.
 - d. Touch **Print** to print all the photos on the memory card.
- or -
- a. Touch a photo you want to print. The photo enlarges and gives you several editing options.
 - Touch the **up** and **down** arrows to specify the number of copies you want to print.
 - Touch the **Full Screen** icon to enlarge the photo to fill the screen.
 - Touch **Edit** to make changes to the photo before printing, such as Rotate, Crop, and Red Eye Removal.
 - b. When you are finished making changes to the photo, touch **Done**. The preview image of the selected photo appears.
 - c. Touch one of the following options.
 - Touch **Add More** to select and edit more photos.
 - Touch **Settings** to make changes to the way the photos are printed, such as layout, paper type, and date stamp, and then select **Done**.
 - Touch **Print** to print the selected photos.

Print DPOF photos

Camera-selected photos are photos you marked for printing with your digital camera. Depending on your camera, the camera might identify page layout, number of copies, rotation, and other print settings.

The printer supports the Digital Print Order Format (DPOF) file format 1.1, so you do not have to reselect the photos to print.

When you print camera-selected photos, the printer's print settings do not apply; the DPOF settings for page layout and number of copies override those of the printer.

 **NOTE:** Not all digital cameras enable you to tag your photos for printing. See the documentation that came with your digital camera to see if your camera supports DPOF file format 1.1.

To print camera-selected photos using the DPOF standard

1. Insert your memory device into the appropriate slot on the printer.
2. When prompted, do one of the following:
 - Touch **OK** to print all DPOF-tagged photos.
 - Touch **No** to bypass DPOF printing.

Print on special and custom-size paper

If your application supports custom-size paper, set the size in the application before printing the document. If not, set the size in the printer driver. You might need to reformat existing documents to print them correctly on custom-size paper.

Use only custom-size paper that is supported by the printer. For more information, see [Media specifications](#).

 **NOTE:** With certain types of paper, you can print on both sides of a sheet of paper (called “two-sided printing” or “duplex printing”). For more information, see [Print on both sides \(duplexing\)](#).

Follow the instructions for your operating system.

- [Print on special or custom-size paper \(Mac OS X\)](#)

Print on special or custom-size paper (Mac OS X)

 **NOTE:** Before you can print on custom-size paper, you must set up the custom size in the HP software provided with the printer. For instructions, see [Set up custom sizes \(Mac OS X\)](#).

1. Load the appropriate paper in the tray. For more information, see [Load media](#).
2. From the **File** menu in your software application, click **Print**.
3. Make sure the printer you want to use is selected.
4. Under **Destination Paper Size**, click **Scale to fit paper size**, and then select the custom size.
Select any other print settings that you want, and then click **Print** to begin printing.
5. Change any other settings, and then click **Print** to begin printing.

Set up custom sizes (Mac OS X)

1. From the **File** menu in your software application, click **Print**.
2. Select the desired printer in the **Format for** pop-up menu.
3. Select **Manage Custom Sizes** in the **Paper Size** pop-up menu.
4. Click the + on the left side of the screen, double-click **Untitled**, and type a name for the new, custom size.
5. In the **Width** and **Height** boxes, type the dimensions, and then set the margins, if you want to customize them.
6. Click **OK**.

Print borderless documents

Borderless printing lets you print to the edges of certain photo media types and a range of standard media sizes.

 **NOTE:** You cannot print a borderless document if the paper type is set to **Plain paper**.

NOTE: Before printing a borderless document, open the file in a software application and assign the image size. Make sure the size corresponds to the media size on which you are printing the image.

NOTE: Not all applications support borderless printing.

Follow the instructions for your operating system.

- [Print borderless documents \(Windows\)](#)
- [Print borderless documents \(Mac OS X\)](#)

Print borderless documents (Windows)

1. Load paper in the tray. For more information, see [Load media](#).
2. On the **File** menu in your software application, click **Print**.
3. Make sure the printer you want to use is selected.
4. To change settings, click the button that opens the **Properties** dialog box. Depending on your software application, this button might be called **Properties**, **Options**, **Printer Setup**, **Printer**, or **Preferences**.
5. Click the **Advanced** tab.
6. In the **Borderless Printing** option, click **Print Borderless**.
7. Click the **Paper/Quality** tab. In the **Media** drop-down list, select the appropriate paper type.
8. Click **OK**, and then click **Print** or **OK** to begin printing.

Print borderless documents (Mac OS X)



NOTE: Follow these instructions to enable borderless printing.

Mac OS 10.6. Under **Paper Type/Quality**, click to select the **Print Borderless** check box and adjust the **Borderless Expansion** setting as needed.

1. Load paper in the tray. For more information, see [Load media](#).
 2. From the **File** menu in your software application, click **Print**.
 3. Make sure the printer you want to use is selected.
 4. Click **Paper Type/Quality** from the pop-up menu (located below the **Orientation** setting), and then select the following settings:
 - **Paper Type:** The appropriate paper type
 - **Quality: Best** or **Maximum dpi**
-



NOTE: Click the blue disclosure triangle next to the **Printer** selection to access these options.

5. If necessary, select the appropriate **Photo Fix** options:
 - **Off:** applies no HP Real Life Technologies to the image.
 - **Basic:** automatically focuses the image; moderately adjusts image sharpness.
6. Select any other print settings that you want, and then click **Print** to begin printing.

HP ePrint

With HP ePrint, you can print from email connected mobile phones, netbooks, or other mobile devices—anywhere, anytime. Using your mobile device service and the printer's Web Services, you can print documents to a printer that could be sitting next to you or sitting thousands of miles away.

To use the HP ePrint service, you need to have the following components:

- An HP ePrint-enabled printer that is connected to the Internet (either using an Ethernet cable or wireless connection)
- A device that has a functioning email capability

Follow the instructions on the printer's control panel to enable and set up the printer's Web Services. For more information, see www.hp.com/go/ePrintCenter.

Print on both sides (duplexing)

You can print on both sides of a sheet of media automatically by using the duplexer.

 **NOTE:** The printer driver does not support manual duplexing. Two-sided printing requires an HP Automatic Two-sided Printing Accessory (duplexer) to be installed on the printer. A duplexer is standard on all models of the HP Officejet Pro 8500A (A910) e-All-in-One series printer.

NOTE: You can perform manual duplexing by first printing only the odd pages, flipping the pages over, and then printing only the even pages.

Perform two-sided printing (Windows)

1. Load the appropriate media. For more information, see [Guidelines for printing on both sides of a page](#) and [Load media](#).
2. Make sure the duplexer is installed correctly. For more information, see [Install the duplexer](#).
3. With a document open, click **Print** on the **File** menu, and then select **Print on Both Sides** on the **Layout** tab.
4. Change any other settings, and then click **OK**.
5. Print your document.

Perform two-sided printing (Mac OS X)

 **NOTE:** Follow these instructions to enable two-sided printing and to change binding options.

Mac OS 10.5. Click **Two-Sided Printing** under **Copies & Pages**, and then select the appropriate binding type.

Mac OS 10.6. On the print dialog box, click to select the **Two-Sided** check box next to the **Copies** and **Collated** options. If the **Two-Sided** option is not available, verify that the duplex accessory is enabled in the printer driver. Select the binding type on the **Layout** panel.

1. Load the appropriate media. For more information, see [Guidelines for printing on both sides of a page](#) and [Load media](#).
2. Make sure the duplexer is installed correctly. For more information, see [Install the duplexer](#).
3. Verify that you are using the correct printer and page size in the **Page Setup**.
4. On the **File** menu, click **Print**.
5. Select the option to print on both sides.
6. Change any other settings, and then click **Print**.

3 Scan

You can use the printer's control panel to scan documents, photos, and other originals and send them to a variety of destinations, such as a folder on a computer. You can also scan these originals from your computer using either the HP software provided with the printer or TWAIN-compliant or WIA-compliant programs.

When scanning documents, you can use the HP software to scan documents into a format that you can search, copy, paste, and edit.

 **NOTE:** Some scan functions are only available after you install the HP software.

 **TIP:** If you have problems scanning documents, see [Solve scan problems](#)

This section contains the following topics:

- [Scan an original](#)
- [Scan using Webscan](#)
- [Scanning documents as editable text](#)

Scan an original

This section contains the following topics:

 **NOTE:** Your printer and computer must be connected and turned on.

NOTE: If you are scanning an original from the printer control panel or from your computer using a the HP printer software, the HP software provided with the printer must also be installed and running on your computer prior to scanning.

NOTE: If you are scanning a borderless original, load the original on the scanner glass, not the ADF.

- [Scan to a computer](#)
- [Scan to a memory card](#)

Scan to a computer

To scan an original to a computer from the printer control panel

Use these steps to scan from the control panel.

1. Load your original print-side down in the right-front corner of the glass or in the ADF. For more information, see [Load an original on the scanner glass](#) or [Load an original in the automatic document feeder \(ADF\)](#).
2. Touch **Scan**, and then select **Computer**.

 **NOTE:** Windows users: If your computer does not appear in the list of destinations, you will need to restart your HP software's scan function on the destination computer.

3. Touch **Document Type** to select the type of document you want to save. Make changes to scan options, if needed.
4. Touch **Start Scan**.

To scan an original from HP printer software

1. Load your original print-side down in the right-front corner of the glass or in the ADF. For more information, see [Load an original on the scanner glass](#) or [Load an original in the automatic document feeder \(ADF\)](#).
2. On the computer, open the HP scanning software:
 - **Windows:** From the computer desktop, click **Start**, select **Programs** or **All Programs**, select the folder for your HP printer, and then select **HP Scan**.
 - **Mac OS X:** Click the **HP Utility** icon in the Dock, click **Applications**, and then double-click **HP Scan 3**.
3. To start the scan, click **Scan**.



NOTE: For more information, see the online Help provided with the scanning software.

Scan to a memory card

To scan an original to a computer from the printer control panel

Use these steps to scan an original to a memory card.

1. Load your original print-side down in the right-front corner of the glass or in the ADF. For more information, see [Load an original on the scanner glass](#) or [Load an original in the automatic document feeder \(ADF\)](#).
2. Insert a memory card. For more information, see [Insert a memory device](#).
3. Touch **Scan**, and then select **Memory Device**.
4. Touch **Document Type** to select the type of document you want to save. Make changes to scan options, if needed.
5. Touch **Start Scan**.

Scan using Webscan

Webscan is a feature of the embedded Web server that lets you scan photos and documents from your printer to your computer using a Web browser. This feature is available even if you did not install the printer software on your computer.

For more information, see [Embedded Web server](#).

To scan using Webscan

1. Load your original print-side down in the right-front corner of the glass or in the ADF. For more information, see [Load an original on the scanner glass](#) or [Load an original on the scanner glass](#) or [Load an original in the automatic document feeder \(ADF\)](#).
2. Open the embedded Web server. For more information, see [Embedded Web server](#).
3. Click the **Scan** tab, click **Webscan** in the left pane, change any settings, and then click **Start Scan**.

Scanning documents as editable text

When scanning documents, you can use the HP software to scan documents into a format that you can search, copy, paste, and edit. This allows you to edit letters, newspaper clippings, and many other documents.

To ensure that the software can convert your documents successfully, do the following:

- **Make sure the scanner glass or ADF window is clean.**
When the printer scans the document, smudges or dust on the scanner glass or ADF window can be scanned, as well, and can prevent the software from converting the document to editable text.
- **Make sure the document is loaded correctly.**
When scanning documents as editable text from the ADF, the original must be loaded into the ADF with the top forward and face up. When scanning from the scanner glass, the original must be loaded with the top facing the right edge of the scanner glass. Also, make sure the document is not skewed. For more information, see [Load an original on the scanner glass](#) or [Load an original in the automatic document feeder \(ADF\)](#).
- **Make sure the text on the document is clear.**
To successfully convert the document to editable text, the original must be clear and of high quality. The following conditions can cause the software to not convert the document successfully:
 - The text on the original is faint or wrinkled.
 - The text is too small.
 - The structure of the document is too complex.
 - The text is tightly spaced. For example, if the text that the software converts has missing or combined characters, "rn" might appear as "m."
 - The text is on a colored background. Colored backgrounds can cause images in the foreground to blend too much.

4 HP Digital Solutions

The printer includes a collection of digital solutions that can help you simplify and streamline your work. These digital solutions include the following:

- HP Direct Digital Filing (including Scan to Network Folder and Scan to E-mail)
- HP Digital Fax (including Fax to Network Folder and Fax to E-mail)

 **NOTE:** If you are using the HP Officejet Pro 8500A (A910a-f), you can only use Scan to Network Folder and Fax to Network Folder. To find your model number, see [Finding the printer model number](#).

This section contains the following topics:

- [What are HP Digital Solutions?](#)
- [Requirements](#)
- [Set up the HP Digital Solutions](#)
- [Use the HP Digital Solutions](#)

What are HP Digital Solutions?

HP Digital Solutions are a set of tools provided with this printer that can help improve your office productivity.

HP Direct Digital Filing

HP Direct Digital Filing provides robust, general-office scanning—as well as basic, versatile, document-management capabilities—for multiple users over a network. With HP Direct Digital Filing, you can simply walk up to the printer, touch a button on the printer's control panel, and either scan documents directly to computer folders on your network or quickly share them with business partners as e-mail attachments—and all without using additional scanning software.

These scanned documents can be sent to a shared network folder for personal or group access or to one or more e-mail addresses for quick sharing. In addition, you can configure specific scan settings for each scan destination, allowing you to make sure that the best settings are being used for each specific task.

HP Digital Fax

Never lose important faxes misplaced within a stack of paper pages again!

With HP Digital Fax, you can save incoming, black-and-white faxes to a computer folder on your network for easy sharing and storage, or you can forward faxes through e-mail—allowing you to receive important faxes from anywhere while working away from the office.

In addition, you can turn off fax printing altogether — saving money on paper and ink, as well as helping reduce paper consumption and waste.

Requirements

Before you set up the digital solutions, make sure you have the following:

For all HP Digital Solutions

- **A network connection**

The printer can be connected either through a wireless connection or using an Ethernet cable.

 **NOTE:** If the printer is connected using a USB cable, you scan documents to a computer or attach scans to an e-mail message using the HP software. For more information, see [Scan an original](#). You can receive faxes to your computer using Fax to PC or Fax to Mac. For more information, see [Receive faxes to your computer \(Fax to PC and Fax to Mac\)](#).

- **The HP software**

HP recommends that you set up the HP Digital Solutions using the HP software provided with the printer.

 **TIP:** If you would like to set up the HP Digital Solutions without installing the HP software, you can use the printer's embedded Web server.

For Scan to Network Folder, Fax to Network Folder

- **Appropriate privileges on the network**

You must have write access to the folder.

- **The name of the computer where the folder is located**

For information about finding the computer name, see the documentation for your operating system.

- **The network address for the folder**

On computer running Windows, network addresses are usually written in this format: \\mypc\sharedfolder\

- **A Windows shared folder or an SMB Shared Folder (Mac OS X only)**

For information about finding the computer name, see the documentation for your operating system.

- **A username and password for the network (if necessary)**

For example, the Windows or Mac OS X username and password used to log onto the network.

 **NOTE:** HP Direct Digital Filing does not support Active Directory.

For Scan to E-mail, Fax to E-mail

Note: If you are using the HP Officejet Pro 8500A (A910a-f), you can only use Scan to Network Folder and Fax to Network Folder. To find your model number, see [Finding the printer model number](#).

- A valid email address
- Outgoing SMTP server information
- An active Internet connection

If you are setting up Scan to E-mail or Fax to E-mail on a computer running Windows, the setup wizard can automatically detect the e-mail settings for the following e-mail applications:

- Microsoft Outlook 2003–2007 (Windows XP, Windows Vista, and Windows 7)
- Outlook Express (Windows XP)
- Windows Mail (Windows Vista)
- Mozilla Thunderbird (Windows XP, Windows Vista, and Windows 7)
- Qualcomm Eudora (version 7.0 and above) (Windows XP and Windows Vista)
- Netscape (version 7.0) (Windows XP)

However, if your e-mail application is not listed above, you can still set up and use Scan to E-mail and Fax to E-mail if your e-mail application meets the requirements listed in this section.

Set up the HP Digital Solutions

You can set up the HP Digital Solutions using the HP software provided with the printer—either using software wizards that you can open from the HP printer software (Windows) or the HP Utility (Mac OS X).

 **TIP:** You can also use the printer's embedded Web server (EWS) to set up the HP Digital Solutions. For more information about using the EWS, see [Embedded Web server](#).

 **NOTE:** If you are using the printer in an IPv6-only network environment, you must set up the digital solutions using the EWS.

This section contains the following topics:

- [Set up HP Direct Digital Filing](#)
- [Set Up HP Digital Fax](#)

Set up HP Direct Digital Filing

To set up HP Direct Digital Filing, follow the appropriate instructions.

 **NOTE:** You can also use these steps to change settings in the future or turn off the feature.

This section contains the following topics:

- [Set Up Scan to Network Folder](#)
- [Set Up Scan to E-mail](#)

Set Up Scan to Network Folder

You can configure up to 10 destination folders for each printer.

 **NOTE:** To use Scan to Network Folder, you must have created and configured the folder you are using on a computer connected to the network. You cannot create a folder from the printer's control panel. Also, make sure the folder preferences are set to provide read and write access. For more information about creating folders on the network and setting folder preferences, see the documentation for your operating system.

After you finish setting up Scan to Network Folder, the HP software automatically saves the configurations to the printer.

To set up Scan to Network Folder, complete the following steps for your operating system.

Windows

1. Open the HP Printer Software. For more information, see [HP printer software \(Windows\)](#).
2. Double-click **Scanner Actions**, and then double-click **Scan to Network Folder Wizard**.
3. Follow the onscreen instructions.

 **NOTE:** After you create destination folders, you can use the printer's EWS to customize the scan settings for these folders. On the last screen of the Scan to Network Folder Wizard, make sure the **Launch embedded Web server when finished** checkbox is selected. When you click **Finish**, the EWS is displayed in your computer's default Web browser. For more information about the embedded Web server, see [Embedded Web server](#).

Mac OS X

1. Open the HP Utility. For more information, see [HP Utility \(Mac OS X\)](#).
2. Click **Additional Settings**. The printer's embedded Web server (EWS) opens in your computer's default Web browser.
3. On the **Home** tab, click **Network Folder Setup** in the **Setup** box.
4. Click **New**, and then follow the onscreen instructions.

 **NOTE:** You can customize the scan settings for each destination folder.

5. After you have entered the required information about the network folder, click **Save and Test** to make sure the link to the network folder is working correctly. The entry is added to the **Network Folder** list.

Embedded Web server (EWS)

1. Open the embedded Web server (EWS). For more information, see [Embedded Web server](#).
2. On the **Home** tab, click **Network Folder Setup** in the **Setup** box.

3. Click **New**, and then follow the onscreen instructions.

 **NOTE:** You can customize the scan settings for each destination folder.

4. After you have entered the required information about the network folder, click **Save and Test** to make sure the link to the network folder is working correctly. The entry is added to the **Network Folder** list.

Set Up Scan to E-mail

You can use the printer to scan documents and send them to one or more e-mail addresses as attachments—without additional scanning software. You do not need to scan files from your computer and attach them to e-mail messages.

 **NOTE:** If you are using the HP Officejet Pro 8500A (A910a-f), you can only use Scan to Network Folder and Fax to Network Folder. To find your model number, see [Finding the printer model number](#).

To use the Scan to E-mail feature, complete the following steps:

Step 1: Set the Outgoing E-mail Profiles

Configure the e-mail address which will appear in the FROM portion of the e-mail message sent by the printer. You can add up to 10 Outgoing E-mail Profiles. You can use the HP software installed on your computer to create these profiles.

Step 2: Add e-mail addresses to the E-mail Address Book

Manage the list of people to whom you can send e-mail messages from the printer. You can add up to 5 e-mail addresses or e-mail groups, as well as their corresponding contact names. To add e-mail addresses, you must use the printer's embedded Web server (EWS).

Step 3: Configure other e-mail options

You can configure default SUBJECT and body text that is included in all e-mail messages sent from the printer. To configure these options, you must use the printer's EWS.

Step 1: Set up the outgoing e-mail profiles

To set up the outgoing e-mail profile used by the printer, complete the following steps for your operating system.

Windows

1. Open the HP printer software. For more information, see [HP printer software \(Windows\)](#).
2. Double-click **Scanner Actions**, and then double-click **Scan to E-mail Wizard**.
3. Click **New**, and then follow the onscreen instructions.

 **NOTE:** After you set the Outgoing E-mail Profile, you can use the printer's embedded Web server (EWS) to add more Outgoing E-mail Profiles, add e-mail addresses to the E-mail Address Book, and configure other e-mail options. To open the EWS automatically, make sure the **Launch embedded Web server when finished** checkbox is selected on the last screen of the Scan to E-mail Wizard. When you click **Finish**, the EWS is displayed in your computer's default Web browser. For more information about the embedded Web server, see [Embedded Web server](#)

Mac OS X

1. Open the HP Utility. For more information, see [HP Utility \(Mac OS X\)](#).
2. Click **Additional Settings**. The printer's embedded Web server (EWS) opens in your computer's default Web browser.
3. On the **Home** tab, click **Outgoing E-mail Profiles** in the **Setup** box.
4. Click **New**, and then follow the onscreen instructions.
5. After you have entered the required information about the network folder, click **Save and Test** to make sure the link to the network folder is working correctly. The entry is added to the **Outgoing E-mail Profiles** list.

Embedded Web server (EWS)

1. Open the embedded Web server (EWS). For more information, see [Embedded Web server](#).
2. On the **Home** tab, click **Outgoing E-mail Profiles** in the **Setup** box.
3. Click **New**, and then follow the onscreen instructions.
4. After you have entered the required information about the network folder, click **Save and Test** to make sure the link to the network folder is working correctly. The entry is added to the **Outgoing E-mail Profile List**.

Step 2: Add e-mail addresses to the E-mail Address Book

To add e-mail addresses to the E-mail Address Book, complete the following steps:

1. Open the embedded Web server (EWS). For more information, see [Embedded Web server](#).
2. On the **Scan** tab, click **E-mail Address Book**.
3. Click **New** to add a single e-mail address.
-Or-
Click **Group** to create an e-mail distribution list.

 **NOTE:** Before you can create an e-mail distribution list, you must have already added at least one e-mail address to the E-mail Address Book.

4. Follow the onscreen instructions. The entry is added to the **E-mail Address Book**.

 **NOTE:** Contact names appear on the printer's control-panel display and in your e-mail application.

Step 3: Configure other e-mail options

To configure other e-mail options (such as configuring default SUBJECT and body text that is included in all e-mail messages sent from the printer, as well as scan settings used when sending e-mail from the printer), complete the following steps:

1. Open the embedded Web server (EWS). For more information, see [Embedded Web server](#).
2. On the **Scan** tab, click **E-mail Options**.
3. Change any settings, and then click **Apply**.

Set Up HP Digital Fax

With HP Digital Fax, the printer automatically receives faxes and saves the faxes directly to a network folder (Fax to Network Folder) or forwards these faxes as email attachments (Fax to E-mail).

 **NOTE:** You can configure HP Digital Fax either to use Fax to Network Folder or to use Fax to E-mail. You cannot use both at the same time.

NOTE: If you are using the HP Officejet Pro 8500A (A910a-f), you can only use Scan to Network Folder and Fax to Network Folder. To find your model number, see [Finding the printer model number](#).

Received faxes are saved as TIFF (Tagged Image File Format) files.

 **CAUTION:** HP Digital Fax is available for receiving black-and-white faxes only. Color faxes are printed instead of being saved to the computer.

Windows

1. Open the HP printer software.
2. Double-click **Fax Actions**, and then double-click **Digital Fax Setup Wizard**.
3. Follow the onscreen instructions.

 **NOTE:** After you set up HP Digital Fax, you can use the printer's embedded Web server (EWS) to edit HP Digital Fax settings. To open the EWS automatically, make sure the **Launch embedded Web server** when finished checkbox is selected on the last screen of the Digital Fax Setup Wizard. When you click **Finish**, the EWS is displayed in your computer's default Web browser. For more information about the embedded Web server, see [Embedded Web server](#).

Mac OS X

1. Open the HP Utility. For more information, see [HP Utility \(Mac OS X\)](#).
2. Click **Additional Settings**. The printer's embedded Web server (EWS) opens in your computer's default Web browser.
3. On the **Home** tab, click **Fax to E-mail/Network Folder** in the **Setup** box.
4. Follow the onscreen instructions.
5. After you have entered the required information, click **Save and Test** to make sure the link to the network folder is working correctly.

Embedded Web server (EWS)

1. On the **Home** tab, click **Fax to E-mail/Network Folder** in the **Setup** box.
2. Follow the onscreen instructions.
3. After you have entered the required information, click **Save and Test** to make sure the link to the network folder is working correctly.

Use the HP Digital Solutions

To use the HP Digital Solutions available with the printer, follow the appropriate instructions.

Use HP Scan to Network Folder

1. Load your original print-side down in the right-front corner of the glass or in the ADF. For more information, see [Load an original on the scanner glass](#) or [Load an original in the automatic document feeder \(ADF\)](#).
2. Touch **Scan**, and then touch **Network Folder**.
3. On the control-panel display, select the name that corresponds to the folder you want to use.
4. If prompted, enter the PIN.
5. Change any scan settings, and then touch **Start Scan**.

 **NOTE:** The connection might take some time, depending on network traffic and connection speed.

Use Scan to E-mail

 **NOTE:** If you are using the HP Officejet Pro 8500A (A910a-f), you can only use Scan to Network Folder and Fax to Network Folder. To find your model number, see [Finding the printer model number](#).

1. Load your original print-side down in the right-front corner of the glass or in the ADF. For more information, see [Load an original on the scanner glass](#) or [Load an original in the automatic document feeder \(ADF\)](#).
2. Touch **Scan**, and then touch **E-mail**.
3. On the control-panel display, select the name that corresponds to the Outgoing E-mail Profile you want to use.
4. If prompted, enter the PIN.
5. Select the TO e-mail address (the e-mail recipient) or enter an e-mail address.
6. Enter or change the SUBJECT for the e-mail message.
7. Change any scan settings, and then touch **Start Scan**.

 **NOTE:** The connection might take some time, depending on network traffic and connection speed.

Use HP Digital Fax

After you set up HP Digital Fax, any black-and-white faxes that you receive print, by default, and then are saved to the designated destination—either the network folder or email address that you have specified:

- If you are using Fax to Network Folder, this process happens in the background. HP Digital Fax does not notify you when faxes are saved to the network folder.
- If you are using Fax to E-mail and if your e-mail application is set to notify you when new e-mail messages arrive in your inbox, you can see when new faxes arrive.

 **NOTE:** If you are using the HP Officejet Pro 8500A (A910a-f), you can only use Scan to Network Folder and Fax to Network Folder. To find your model number, see [Finding the printer model number](#).

5 Copy

You can produce high-quality color and grayscale copies on a variety of paper types and sizes.

 **NOTE:** If you are copying a document when a fax arrives, the fax is stored in the printer's memory until the copying finishes. This can reduce the number of fax pages stored in memory.

This section contains the following topics:

- [Copy documents](#)
- [Change copy settings](#)

Copy documents

You can make quality copies from the printer control panel.

To copy documents

1. Make sure you have paper loaded in the main tray.
2. Place your original face down on the scanner glass or face up in the ADF.

 **NOTE:** If you are copying a photo, place the photo on the scanner glass face down, as shown on the icon on the edge of the scanner glass.

3. Touch **Copy**.
4. Change any additional settings. For more information, see [Change copy settings](#)
5. To start the copy job, touch one of the following:
 - **Start Black:** To select a black-and-white copy job.
 - **Start Color :** To select a color copy job.

 **NOTE:** If you have a color original, selecting the **Black** function produces a black-and-white copy of the color original, while selecting the **Color** function produces a full-color copy of the color original.

Change copy settings

You can customize copy jobs using the various settings available from the printer's control panel, including the following:

- Number of copies
- Copy paper size
- Copy paper type
- Copy speed or quality
- Lighter/Darker settings
- Resizing originals to fit on different paper sizes

You can use these settings for single copy jobs, or you can save settings to be used as defaults for future jobs.

To change copy settings for a single job

1. Touch **Copy**.
2. Select the copy function settings you want to change.
3. Touch **Start Black** or **Start Color**.

To save the current settings as defaults for future jobs

1. Touch **Copy**.
2. Make any changes to the copy function settings, and then touch **Settings**.
3. Touch down arrow ▼, and then select **Set As New Defaults** .
4. Touch **Yes, change defaults**, and then select **Done**.

6 Fax

You can use the printer to send and receive faxes, including color faxes. You can schedule faxes to be sent at a later time and set up speed-dials to send faxes quickly and easily to frequently used numbers. From the printer control panel, you can also set a number of fax options, such as resolution and the contrast between lightness and darkness on the faxes you send.

 **NOTE:** Before you begin faxing, make sure you have set up the printer correctly for faxing. You might have already done this as part of the initial setup, by using either the control panel or the HP software provided with the printer. You can verify the fax is set up correctly by running the fax setup test from the control panel. For more information on the fax test, see [Test fax setup](#).

This section contains the following topics:

- [Send a fax](#)
- [Receive a fax](#)
- [Set up speed-dial entries](#)
- [Change fax settings](#)
- [Fax and digital phone services](#)
- [Fax over Internet Protocol](#)
- [Use reports](#)

Send a fax

You can send a fax in a variety of ways. Using the printer control panel, you can send a black-and-white or color fax. You can also send a fax manually from an attached phone. This allows you to speak with the recipient before sending the fax.

This section contains the following topics:

- [Send a standard fax](#)
- [Send a standard fax from the computer](#)
- [Send a fax manually from a phone](#)
- [Send a fax using monitor dialing](#)
- [Send a fax from memory](#)
- [Schedule a fax to send later](#)
- [Send a fax to multiple recipients](#)
- [Send a fax in Error Correction Mode](#)

Send a standard fax

You can easily send a single- or multiple-page black-and-white or color fax by using the printer control panel.

 **NOTE:** If you need printed confirmation that your faxes were successfully sent, enable fax confirmation **before** sending any faxes.

-  **TIP:** You can also send a fax manually from a phone or by using monitor dialing. These features allow you to control the pace of your dialing. They are also useful when you want to use a calling card to charge the call and you have to respond to tone prompts while dialing.
-

To send a standard fax from the printer control panel

1. Load your original print-side down in the right-front corner of the glass or in the ADF. For more information, see [Load an original on the scanner glass](#) or [Load an original in the automatic document feeder \(ADF\)](#).
2. Touch **Fax**.
3. Enter the fax number by using the keypad.

 **TIP:** To add a pause in the fax number you are entering, touch * repeatedly, until a dash (-) appears on the display.

4. Touch **Start Black** or **Start Color**.
If the printer detects an original loaded in the automatic document feeder, it sends the document to the number you entered.

 **TIP:** If the recipient reports issues with the quality of the fax you sent, you can try changing the resolution or contrast of your fax.

Send a standard fax from the computer

You can send a document on your computer as a fax, without printing a copy and faxing it from the printer.

 **NOTE:** Faxes sent from your computer by this method use the printer's fax connection, not your Internet connection or computer modem. Therefore, make sure the printer is connected to a working telephone line and that the fax function is set up and functioning correctly.

To use this feature, you must install the printer software using the installation program provided on the HP software CD provided with the printer.

Windows

1. Open the document on your computer that you want to fax.
2. On the **File** menu in your software application, click **Print**.
3. From the **Name** list, select the printer that has “**fax**” in the name.
4. To change settings (such as selecting to send the document as a black fax or a color fax), click the button that opens the **Properties** dialog box. Depending on your software application, this button might be called **Properties**, **Options**, **Printer Setup**, **Printer**, or **Preferences**.
5. After you have changed any settings, click **OK**.
6. Click **Print** or **OK**.
7. Enter the fax number and other information for the recipient, change any further settings for the fax, and then click **Send Fax**. The printer begins dialing the fax number and faxing the document.

Mac OS X

1. Open the document on your computer that you want to fax.
2. From the **File** menu in your software application, click **Print**.
3. Select the printer that has “**(Fax)**” in the name.
4. Select **Fax Recipients** from the pop-up menu below the **Orientation** setting.



NOTE: If you cannot find the pop-up menu, try clicking the blue disclosure triangle next to the **Printer selection**.

5. Enter the fax number and other information in the boxes provided, and then click **Add to Recipients**.
6. Select the **Fax Mode** and any other fax options you want, and then click **Send Fax Now** to begin dialing the fax number and faxing the document.

Send a fax manually from a phone

Sending a fax manually allows you to make a phone call and talk with the recipient before you send the fax. This is useful if you want to inform the recipient that you are going to send them a fax before sending it. When you send a fax manually, you can hear the dial tones, telephone prompts, or other sounds through the handset on your telephone. This makes it easy for you to use a calling card to send your fax.

Depending on how the recipient has their fax machine set up, the recipient might answer the phone, or the fax machine might take the call. If a person answers the phone, you can speak with the recipient before sending the fax. If a fax machine answers the call, you can send the fax directly to the fax machine when you hear the fax tones from the receiving fax machine.

To send a fax manually from an extension phone

1. Load your original print-side down in the right-front corner of the glass or in the ADF. For more information, see [Load an original on the scanner glass](#) or [Load an original in the automatic document feeder \(ADF\)](#).
2. Touch **Fax**.
3. Dial the number by using the keypad on the phone that is connected to the printer.



NOTE: Do not use the keypad on the control panel of the printer when manually sending a fax. You must use the keypad on your phone to dial the recipient's number.

4. If the recipient answers the telephone, you can engage in a conversation before sending your fax.

 **NOTE:** If a fax machine answers the call, you will hear fax tones from the receiving fax machine. Proceed to the next step to transmit the fax.

5. When you are ready to send the fax, touch **Start Black** or **Start Color**.

 **NOTE:** If prompted, select **Send Fax**.

If you were speaking with the recipient before sending the fax, inform the recipient that they should press **Start** on their fax machine after they hear fax tones.

The telephone line is silent while the fax is transmitting. At this point, you can hang up the telephone. If you want to continue speaking with the recipient, remain on the line until the fax transmission is complete.

Send a fax using monitor dialing

Monitor dialing allows you to dial a number from the printer control panel as you would dial a regular telephone. When you send a fax using monitor dialing, you can hear the dial tones, telephone prompts, or other sounds through the speakers on the printer. This enables you to respond to prompts while dialing, as well as control the pace of your dialing.

 **TIP:** If you are using a calling card and do not enter your PIN fast enough, the printer might start sending fax tones too soon and cause your PIN not to be recognized by the calling card service. If this is the case, you can create a speed dial entry to store the PIN for your calling card. For more information, see [Set up speed-dial entries](#).

 **NOTE:** Make sure the volume is turned on to hear a dial tone.



To send a fax using monitor dialing from the printer control panel

1. Load your originals. For additional information, see [Load an original on the scanner glass](#) or [Load an original in the automatic document feeder \(ADF\)](#).

2. Touch **Fax**, and then touch **Start Black** or **Start Color**.

If the printer detects an original loaded in the automatic document feeder, you hear a dial tone.

3. When you hear the dial tone, enter the number by using the keypad on the printer control panel.
4. Follow any prompts that might occur.

 **TIP:** If you are using a calling card to send a fax and you have your calling card PIN stored as a speed dial, when prompted to enter your PIN, touch  (Speed Dial) to select the speed dial entry where you have your PIN stored.

Your fax is sent when the receiving fax machine answers.



Send a fax from memory

You can scan a black-and-white fax into memory and then send the fax from memory. This feature is useful if the fax number you are trying to reach is busy or temporarily

unavailable. The printer scans the originals into memory and sends them once it is able to connect to the receiving fax machine. After the printer scans the pages into memory, you can immediately remove the originals from the document feeder tray or scanner glass.

 **NOTE:** You can only send a black-and-white fax from memory.

To send a fax from memory

1. Load your originals. For additional information, see [Load an original on the scanner glass](#) or [Load an original in the automatic document feeder \(ADF\)](#).
2. Touch **Fax**, and then touch **Fax Options** or **Fax Settings**.
3. Touch **Scan and Fax**.
4. Enter the fax number by using the keypad, touch  (Speed Dial) to select a speed dial, or touch  (Call History) to select a previously dialed or received number.
5. Touch **Start Fax**.
The printer scans the originals into memory and sends the fax when the receiving fax machine is available.



Schedule a fax to send later

You can schedule a black-and-white fax to be sent within the next 24 hours. This enables you to send a black-and-white fax late in the evening, when phone lines are not as busy or phone rates are lower, for example. The printer automatically sends your fax at the specified time.

You can only schedule one fax to be sent at a time. You can continue to send faxes normally, however, while a fax is scheduled.

 **NOTE:** You can only send faxes in black-and-white.

To schedule a fax from the printer control panel

1. Load your originals. For additional information, see [Load an original on the scanner glass](#) or [Load an original in the automatic document feeder \(ADF\)](#).
2. Touch **Fax**, and then touch **Fax Options** or **Fax Settings**.
3. Touch **Send Fax Later**.
4. Enter the send time by using the numeric keypad, touch **AM** or **PM**, and then select **Done**.
5. Enter the fax number by using the keypad, touch  (Speed Dial) to select a speed dial, or touch  (Call History) to select a previously dialed or received number.
6. Touch **Start Fax**.
The printer scans all pages and the scheduled time appears on the display. The fax is sent at the scheduled time.

To cancel a scheduled fax

1. Touch the **Send Fax Later** message on the display.
– OR –
Touch **Fax**, and then select **Fax Options** or **Fax Settings**.
2. Touch **Cancel Scheduled Fax** .

Send a fax to multiple recipients

You can send a fax to multiple recipients at once by grouping individual speed dial entries into group speed dial entries.

To send a fax to multiple recipients using group speed dial

1. Load your originals. For additional information, see [Load an original on the scanner glass](#) or [Load an original in the automatic document feeder \(ADF\)](#).
2. Touch **Fax**, touch  (Speed Dial), and then select the group you want to fax to.
3. Touch **Start Black**.

If the printer detects an original loaded in the automatic document feeder, it sends the document to each number in the group speed dial entry.

 **NOTE:** You can only use group speed dial entries to send faxes in black and white, because of memory limitations. The printer scans the fax into memory then dials the first number. When a connection is made, it sends the fax and dials the next number. If a number is busy or not answering, the printer follows the settings for **Busy Redial** and **No Answer Redial**. If a connection cannot be made, the next number is dialed and an error report is generated.



Send a fax in Error Correction Mode

Error Correction Mode (ECM) prevents loss of data due to poor phone lines by detecting errors that occur during transmission and automatically requesting retransmission of the erroneous portion. Phone charges are unaffected, or might even be reduced, on good phone lines. On poor phone lines, ECM increases sending time and phone charges, but sends the data much more reliably. The default setting is **On**. Turn ECM off only if it increases phone charges substantially, and if you can accept poorer quality in exchange for reduced charges.

Before turning the ECM setting off, consider the following. If you turn ECM off

- The quality and transmission speed of faxes you send and receive are affected.
- The **Fax Speed** is automatically set to **Medium**.
- You no longer send or receive faxes in color.

To change the ECM setting from the control panel

1. From the Home screen, touch right arrow , and then select **Setup**.
2. Touch **Fax Setup** and then select **Advanced Fax Setup**.
3. Touch down arrow , and then select **Error Correction Mode**.
4. Select **On** or **Off**.

Receive a fax

You can receive faxes automatically or manually. If you turn off the **Auto Answer** option, you must receive faxes manually. If you turn on the **Auto Answer** option (the default setting), the printer automatically answers incoming calls and receives faxes after the number of rings that are specified by the **Rings to Answer** setting. (The default **Rings to Answer** setting is five rings.)

If you receive a Legal-size or larger fax and the printer is not currently set to use Legal-size paper, the printer reduces the fax so that it fits on the paper that is loaded. If you have disabled the **Automatic Reduction** feature, the printer prints the fax on two pages.

 **NOTE:** If you are copying a document when a fax arrives, the fax is stored in the printer memory until the copying finishes. This can reduce the number of fax pages stored in memory.

- [Receive a fax manually](#)
- [Set up backup fax](#)
- [Reprint received faxes from memory](#)
- [Poll to receive a fax](#)
- [Forward faxes to another number](#)
- [Set the paper size for received faxes](#)
- [Set automatic reduction for incoming faxes](#)
- [Block unwanted fax numbers](#)
- [Receive faxes to your computer \(Fax to PC and Fax to Mac\)](#)

Receive a fax manually

When you are on the phone, the person you are speaking with can send you a fax while you are still connected. This is referred to as manual faxing. Use the instructions in this section to receive a manual fax.

 **NOTE:** You can pick up the handset to talk or listen for fax tones.

You can receive faxes manually from a phone that is:

- Directly connected to the printer (on the 2-EXT port)
- On the same phone line, but not directly connected to the printer

To receive a fax manually

1. Make sure the printer is turned on and you have paper loaded in the main tray.
2. Remove any originals from the document feeder tray.
3. Set the **Rings to Answer** setting to a high number to allow you to answer the incoming call before the printer answers. Or, turn off the **Auto Answer** setting so that the printer does not automatically answer incoming calls.

4. If you are currently on the phone with the sender, instruct the sender to press **Start** on their fax machine.
5. When you hear fax tones from a sending fax machine, do the following:
 - a. Touch **Fax**, and then select **Start Black** or **Start Color**.
 - b. After the printer begins to receive the fax, you can hang up the phone or remain on the line. The phone line is silent during fax transmission.

Set up backup fax

Depending on your preference and security requirements, you can set up the printer to store all the faxes it receives, only the faxes it receives while the printer is in an error condition, or none of the faxes it receives.

The following backup fax modes are available:

On	<p>The default setting. When Backup fax is On, the printer stores all received faxes in memory. This enables you to reprint up to eight of the most recently printed faxes if they are still saved in memory.</p> <p>NOTE: When printer memory is low, it overwrites the oldest, printed faxes as it receives new faxes. If the memory becomes full of unprinted faxes, the printer stops answering incoming fax calls.</p> <p>NOTE: If you receive a fax that is too large, such as a very detailed color photo, it might not be stored in memory due to memory limitations.</p>
On Error Only	<p>Causes the printer to store faxes in memory only if an error condition exists that prevents the printer from printing the faxes (for example, if the printer runs out of paper). The printer continues to store incoming faxes as long as there is memory available. (If the memory becomes full, the printer stops answering incoming fax calls.) When the error condition is resolved, the faxes stored in memory print automatically, and then they are deleted from memory.</p>
Off	<p>Faxes are never stored in memory. For example, you might want to turn off Backup fax for security purposes. If an error condition occurs that prevents the printer from printing (for example, the printer runs out of paper), the printer stops answering incoming fax calls.</p>

 **NOTE:** If backup fax is enabled and you turn the printer off, all faxes stored in memory are deleted, including any unprinted faxes that you might have received while the printer was in an error condition. You must contact the senders to ask them to resend any unprinted faxes. For a list of the faxes you have received, print the **Fax Log**. The **Fax Log** is not deleted when the printer is turned off.

To set backup fax from the printer control panel

1. Touch right arrow , and then select **Setup**.
2. Touch **Fax Setup**, and then select **Advanced Fax Setup**.
3. Touch **Backup Fax Reception**.
4. Touch **On**, **On Error Only**, or **Off**.

Reprint received faxes from memory

If you set the **Backup fax** mode to **On**, the received faxes are stored in memory, whether the printer has an error condition or not.

 **NOTE:** After the memory becomes full, the oldest, printed faxes are overwritten as new faxes are received. If all the stored faxes are unprinted, the printer does not receive any fax calls until you print or delete the faxes from memory. You might also want to delete the faxes in memory for security or privacy purposes.

Depending on the sizes of the faxes in memory, you can reprint up to eight of the most recently printed faxes, if they are still in memory. For example, you might need to reprint your faxes if you lost the copy of your last printout.

To reprint faxes in memory from the printer control panel

1. Make sure you have paper loaded in the main tray.
2. Touch right arrow , and then select **Setup**.
3. Touch **Tools** or **Fax Tools**, and then select **Reprint Faxes in Memory**.
The faxes are printed in the reverse order from which they were received with the most recently received fax printed first, and so on.
4. If you want to stop reprinting the faxes in memory, touch **Cancel**.

Poll to receive a fax

Polling allows the printer to ask another fax machine to send a fax that it has in its queue. When you use the **Poll to Receive** feature, the printer calls the designated fax machine and requests the fax from it. The designated fax machine must be set for polling and have a fax ready to send.

 **NOTE:** The printer does not support polling pass codes. Polling pass codes are a security feature that require the receiving fax machine to provide a pass code to the printer it is polling in order to receive the fax. Make sure the printer you are polling does not have a pass code set up (or has not changed the default pass code) or the printer cannot receive the fax.

To set up poll to receive a fax from the printer control panel

1. Touch **Fax**, and then select **Fax Settings** or **Other Methods**.
2. Touch **Poll to Receive**.
3. Enter the fax number of the other fax machine.
4. Touch **Start Fax**.

Forward faxes to another number

You can set up the printer to forward your faxes to another fax number. A received color fax is forwarded in black and white.

HP recommends that you verify the number you are forwarding to is a working fax line. Send a test fax to make sure the fax machine is able to receive your forwarded faxes.

To forward faxes from the printer control panel

1. Touch **Setup**.
2. Touch **Fax Settings** or **Fax Setup**, and then select **Advanced Fax Setup**.
3. Touch **Fax Forwarding**.
4. Touch **On (Print and Forward)** to print and forward the fax, or select **On (Forward)** to forward the fax.

 **NOTE:** If the printer is not able to forward the fax to the designated fax machine (for example, if it is not turned on), the printer prints the fax. If you set up the printer to print error reports for received faxes, it also prints an error report.

5. At the prompt, enter the number of the fax machine intended to receive the forwarded faxes, and then touch **Done**. Repeat for each of the following prompts: start date, start time, end date, and end time.
6. Fax forwarding is activated. Touch **Ok** to confirm.
If the printer loses power when fax forwarding is set up, it saves the fax forwarding setting and phone number. When the power is restored to the printer, the fax forwarding setting is still **On**.

 **NOTE:** You can cancel fax forwarding by selecting **Off** from the **Fax Forwarding** menu.

Set the paper size for received faxes

You can select the paper size for received faxes. The paper size you select should match what is loaded in your main tray. Faxes can be printed on Letter, A4, or Legal paper only.

 **NOTE:** If an incorrect paper size is loaded in the main tray when you receive a fax, the fax does not print and an error message appears on the display. Load letter, A4, or legal paper, and then touch **OK** to print the fax.

To set the paper size for received faxes from the printer control panel

1. Touch right arrow , and then select **Setup**.
2. Touch **Fax Setup**, and then select **Basic Fax Setup**.
3. Touch **Fax Paper Size**, and then select an option.

Set automatic reduction for incoming faxes

The **Automatic Reduction** setting determines what the printer does if it receives a fax that is too large for the default paper size. This setting is turned on by default, so the image of the incoming fax is reduced to fit on one page, if possible. If this feature is turned off, information that does not fit on the first page is printed on a second page. **Automatic Reduction** is useful when you receive a Legal-size fax and Letter-size paper is loaded in the main tray.

To set automatic reduction from the printer control panel

1. Touch right arrow , and then select **Setup**.
2. Touch **Fax Setup**, and then select **Advanced Fax Setup**.
3. Touch **Automatic Reduction**, and then select **On** or **Off**.

Block unwanted fax numbers

If you subscribe to a caller ID service through your phone provider, you can block specific fax numbers so the printer does not print faxes received from those numbers. When an incoming fax call is received, the printer compares the number to the list of junk fax numbers to determine if the call should be blocked. If the number matches a number in the blocked fax numbers list, the fax is not printed. (The maximum number of fax numbers you can block varies by model.)

 **NOTE:** This feature is not supported in all countries/regions. If it is not supported in your country/region, **Junk Fax Blocker** does not appear in the **Fax Options** or **Fax Settings** menu.

NOTE: If no phone numbers are added in the Caller ID list, it is assumed that a Caller ID service has not been subscribed to with the phone company.

- [Add numbers to the junk fax list](#)
- [Remove numbers from the junk fax list](#)
- [Print a Junk Fax Report](#)

Add numbers to the junk fax list

You can block specific numbers by adding them to the junk fax list.

To add a number to the junk fax list



1. Touch **Setup**.
2. Touch **Fax Setup**, and then select **Basic Fax Setup**.
3. Touch **Junk Fax Blocker**.
4. A message appears stating that Caller ID is required to block junk faxes. Touch **OK** to continue.
5. Touch **Add Numbers**.
6. To select a fax number to block from the caller ID list, touch **Select from Caller ID History**.
- or -
To manually enter a fax number to block, touch **Enter new number**.
7. After entering a fax number to block, touch **Done**.

 **NOTE:** Make sure you enter the fax number as it appears on the control-panel display, and not the fax number that appears on the fax header of the received fax, as these numbers can be different.

Remove numbers from the junk fax list

If you no longer want to block a fax number, you can remove a number from your junk fax list.



To remove numbers from the list of junk fax numbers

1. Touch right arrow , and then select **Setup**.
2. Touch **Fax Setup**, and then select **Basic Fax Setup**.
3. Touch down arrow , and then select **Junk Fax Blocker** or **Junk Fax Blocker Setup**.
4. Touch **Remove Numbers**.
5. Touch the number you want to remove, and then select **OK**.

Print a Junk Fax Report

Use the following procedure to print a list of blocked junk fax numbers.

To print a Junk Fax Report

1. Touch right arrow , and then select **Setup**.
2. Touch **Fax Setup**, and then select **Basic Fax Setup**.
3. Touch down arrow , and then select **Junk Fax Blocker**.
4. Touch **Print Reports**, and then select **Junk Fax List**.

Receive faxes to your computer (Fax to PC and Fax to Mac)

If the printer is connected to your computer with a USB cable, you can use Fax to PC and Fax to Mac to automatically receive faxes and save faxes directly to your computer. With Fax to PC and Fax to Mac, you can store digital copies of your faxes easily and also eliminate the hassle of dealing with bulky paper files.

 **NOTE:** If the printer is connected to a network using an Ethernet cable or a wireless connection, you can use HP Digital Fax instead. For more information, see [HP Digital Solutions](#).

Received faxes are saved as TIFF (Tagged Image File Format). Once the fax is received, you get an on-screen notification with a link to the folder where the fax is saved.

The files are named in the following method: XXXX_YYYYYYYY_ZZZZZZ.tif, where X is the sender's information, Y is the date, and Z is the time that the fax was received.

 **NOTE:** Fax to PC and Fax to Mac are available for receiving black-and-white faxes only. Color faxes are printed instead of being saved to the computer.

This section contains the following topics:

- [Fax to PC and Fax to Mac requirements](#)
- [Activate Fax to PC and Fax to Mac](#)
- [Modify Fax to PC or Fax to Mac settings](#)

Fax to PC and Fax to Mac requirements

- The administrator computer, the computer that activated the Fax to PC or Fax to Mac feature, must be on at all times. Only one computer can act as the Fax to PC or Fax to Mac administrator computer.
- The destination folder's computer or server must be on at all times. The destination computer must also be awake, faxes will not be saved if the computer is asleep or in hibernate mode.
- Paper must be loaded in the input tray.

Activate Fax to PC and Fax to Mac

On a computer running Windows, you can use the Digital Fax Setup Wizard to activate Fax to PC. On a Macintosh computer, you can use the HP Utility.

To set up Fax to PC (Windows)

1. Open the HP printer software. For more information, see [HP printer software \(Windows\)](#).
2. Double-click **Fax Actions**, and then double-click **Digital Fax Setup Wizard**.
3. Follow the onscreen instructions.

To set up Fax to Mac (Mac OS X)

1. Open the HP Utility. For more information, see [HP Utility \(Mac OS X\)](#).
2. Click the **Application** icon on the toolbar.
3. Double-click **HP Setup Assistant**, and then follow the onscreen instructions.

Modify Fax to PC or Fax to Mac settings

You can update the Fax to PC settings from your computer at any time from the Digital Fax Setup Wizard. You can update the Fax to Mac settings from the HP Utility.

You can turn off Fax to PC or Fax to Mac and disable printing faxes from the printer's control panel.

To modify settings from the printer's control panel

1. Touch  (right arrow), and then select **Setup**.
2. Touch **Fax Setup**, touch **Basic Fax Setup**, and then touch **Fax to PC**.
3. Select the setting that you want to change. You can change the following settings:
 - **View PC hostname:** View the name of the computer that is set up to administer Fax to PC or Fax to Mac.
 - **Turn Off:** Turn off Fax to PC or Fax to Mac.



NOTE: Use the HP software on your computer to turn on Fax to PC or Fax to Mac.

- **Disable Fax Print:** Choose this option to print faxes as they are received. If you turn off printing, color faxes will still print.

To modify settings from the HP software (Windows)

1. Open the HP printer software. For more information, see [HP printer software \(Windows\)](#).
2. Double-click **Fax Actions**, and then double-click **Digital Fax Setup Wizard**.
3. Follow the onscreen instructions.

To modify settings from the HP software (Mac OS X)

1. Open the HP Utility. For more information, see [HP Utility \(Mac OS X\)](#).
2. Click the **Application** icon on the toolbar.
3. Double-click **HP Setup Assistant**, and then follow the onscreen instructions.

Turn off Fax to PC or Fax to Mac

1. Touch  (right arrow), and then select **Setup**.
2. Touch **Fax Setup**, touch **Basic Fax Setup**, and then touch **Fax to PC**.
3. Touch **Turn Off**.

Set up speed-dial entries

You can set up frequently used fax numbers as speed-dial entries. This lets you dial those numbers quickly by using the printer's control panel.

 **TIP:** In addition to creating and managing speed-dial entries from the printer's control panel, you can also use tools available on your computer, such as the HP software included with the printer and the printer's embedded Web server (EWS). For more information, see [Printer management tools](#).

This section contains the following topics:

- [Set up and change speed-dial entries](#)
- [Set up and change group speed-dial entries](#)
- [Delete speed-dial entries](#)
- [Print a list of speed-dial entries](#)

Set up and change speed-dial entries

You can store fax numbers as speed-dial entries.

To set up speed-dial entries

1. On the printer's control panel, touch right arrow , and then touch **Setup**.
2. Touch **Fax Setup**, and then select **Speed Dial Setup**.
3. Touch **Add/Edit Speed Dial**, and then touch an unused entry number.
4. Type the fax number, and then touch **Next**.

 **NOTE:** Be sure to include any pauses or other required numbers, such as an area code, an access code for numbers outside a PBX system (usually a 9 or 0), or a long-distance prefix.

5. Type the name for the speed-dial entry, and then touch **Done**.

To change speed-dial entries

1. On the printer's control panel, touch right arrow , and then touch **Setup**.
2. Touch **Fax Setup**, and then select **Speed Dial Setup**.
3. Touch **Add/Edit Speed Dial**, and then touch the speed-dial entry you want to change.
4. If you want to change the fax number, type the new number, and then touch **Next**.

 **NOTE:** Be sure to include any pauses or other required numbers, such as an area code, an access code for numbers outside a PBX system (usually a 9 or 0), or a long-distance prefix.

5. If you want to change the name of the speed-dial entry, type the new name, and then touch **Done**.

Set up and change group speed-dial entries

You can store groups of fax numbers as group speed-dial entries.

To set up group speed-dial entries

 **NOTE:** Before you can create a group speed-dial entry, you must have already created at least one speed-dial entry.

1. On the printer's control panel, touch right arrow , and then touch **Setup**.
2. Touch **Fax Setup**, and then select **Speed Dial Setup**.
3. Touch **Group Speed Dial**, and then touch an unused entry number.
4. Touch the speed-dial entries you want to include in the group speed-dial entry, and then touch **OK**.
5. Type the name for the speed-dial entry, and then touch **Done**.

To change group speed-dial entries

1. On the printer's control panel, touch right arrow , and then touch **Setup**.
2. Touch **Fax Setup**, and then select **Speed Dial Setup**.
3. Select **Group Speed Dial**, and then touch the entry you want to change.
4. If you want to add or remove speed-dial entries from the group, touch the speed-dial entries you want to include or those you want to remove, and then touch **OK**.
5. If you want to change the name of the group speed-dial, type the new name, and then touch **Done**.

Delete speed-dial entries

To delete speed-dial entries or group speed-dial entries, complete the following steps:

1. On the printer's control panel, touchright arrow , and then touch **Setup**.
2. Touch **Fax Setup**, and then select **Speed Dial Setup**.
3. Touch **Delete Speed Dial**, touch the entry you want to delete, and then touch **Yes** to confirm.



NOTE: Deleting a group speed-dial entry does not delete the individual speed-dial entries.

Print a list of speed-dial entries

To print a list of all of the speed-dial entries that have been set up, complete the following steps:

1. Load paper in the tray. For more information, see [Load media](#).
2. On the printer's control panel, touch right arrow , and then touch **Setup**.
3. Touch **Fax Setup**, and then select **Speed Dial Setup**.
4. Touch **Print Speed Dial List**.

Change fax settings

After completing the steps in the getting started guide that came with the printer, use the following steps to change the initial settings or to configure other options for faxing.

- [Configure the fax header](#)
- [Set the answer mode \(Auto answer\)](#)
- [Set the number of rings before answering](#)
- [Change the answer ring pattern for distinctive ring](#)
- [Set the dial type](#)
- [Set the redial options](#)
- [Set the fax speed](#)
- [Set the fax sound volume](#)

Configure the fax header

The fax header prints your name and fax number on the top of every fax you send. HP recommends that you set up the fax header by using the HP software provided with the printer. You can also set up the fax header from the printer control panel, as described here.



NOTE: In some countries/regions, the fax header information is a legal requirement.

To set or change the fax header

1. Touch right arrow , and then select **Setup**.
2. Touch **Fax Setup**, and then select **Basic Fax Setup**.
3. Touch **Fax Header**.

4. Enter your personal or company name, and then touch **Done**.
5. Enter your fax number, and then touch **Done**.

Set the answer mode (Auto answer)

The answer mode determines whether the printer answers incoming calls.

- Turn on the **Auto Answer** setting if you want the printer to answer faxes **automatically**. The printer answers all incoming calls and faxes.
- Turn off the **Auto Answer** setting if you want to receive faxes **manually**. You must be available to respond in person to the incoming fax call or else the printer does not receive faxes.

To set the answer mode

1. Touch **Setup**.
2. Touch **Fax Setup**, and then select **Basic Fax Setup**.
3. Touch **Auto Answer**, and then select **On** or **Off**.

When **Auto Answer** is **On**, the printer answers calls automatically. When **Auto Answer** is **Off**, it does not answer calls.

Set the number of rings before answering

If you turn on the **Auto Answer** setting, you can specify how many rings occur before incoming calls are automatically answered.

The **Rings to Answer** setting is important if you have an answering machine on the same phone line as the printer, because you want the answering machine to answer the phone before the printer does. The number of rings to answer for the printer should be greater than the number of rings to answer for the answering machine.

For example, set your answering machine to a low number of rings and the printer to answer in the maximum number of rings. (The maximum number of rings varies by country/region.) In this setup, the answering machine answers the call and the printer monitors the line. If the printer detects fax tones, it receives the fax. If the call is a voice call, the answering machine records the incoming message.

To set the number of rings before answering

1. Touch **Setup**.
2. Touch **Fax Setup**, and then select **Basic Fax Setup**.
3. Touch **Rings to Answer**.
4. Touch up arrow ▲ or down arrow ▼ to change the number of rings.
5. Touch **Done** to accept the setting.

Change the answer ring pattern for distinctive ring

Many phone companies offer a distinctive ring feature that allows you to have several phone numbers on one phone line. When you subscribe to this service, each number is assigned a different ring pattern. You can set up the printer to answer incoming calls that have a specific ring pattern.

If you connect the printer to a line with distinctive ring, have your telephone company assign one ring pattern to voice calls and another ring pattern to fax calls. HP recommends that you request double or triple rings for a fax number. When the printer detects the specified ring pattern, it answers the call and receives the fax.

 **TIP:** You can also use the Ring Pattern Detection feature in the printer's control panel to set distinctive ring. With this feature, the printer recognizes and records the ring pattern of an incoming call and, based on this call, automatically determines the distinctive ring pattern assigned by your telephone company to fax calls.

If you do not have a distinctive ring service, use the default ring pattern, which is **All Rings**.

 **NOTE:** The printer cannot receive faxes when the main phone number is off the hook.

To change the answer ring pattern for distinctive ring

1. Verify that the printer is set to answer fax calls automatically.
2. On the printer control panel, touch **Setup**.
3. Touch **Fax Setup**, and then select **Advanced Fax Setup**
4. Touch **Distinctive Ring**.
5. A message appears stating that this setting should not be changed unless you have multiple numbers on the same telephone line. Touch **Yes** to continue.
6. Do one of the following:
 - Touch the ring pattern assigned by your telephone company to fax calls.
 - Or -
 - Touch **Ring Pattern Detection**, and then follow the instructions on the printer's control panel.

 **NOTE:** If the Ring Pattern Detection feature cannot detect the ring pattern or if you cancel the feature before it finishes, the ring pattern is automatically set to **All Rings**.

NOTE: If you are using either a PBX phone system that has different ring patterns for internal and external calls, you must call the fax number from an external number.

Set the dial type

Use this procedure to set tone-dialing or pulse-dialing mode. The factory-set default is **Tone**. Do not change the setting unless you know that your phone line cannot use tone dialing.

 **NOTE:** The pulse-dialing option is not available in all countries/regions.

To set the dial type

1. Touch right arrow , and then select **Setup**.
2. Touch **Fax Setup**, and then select **Basic Fax Setup**.

3. Touch down arrow ▼, and then select **Tone or Pulse Dialing**.
4. Touch to select **Tone Dialing** or **Pulse Dialing**.

Set the redial options

If the printer was unable to send a fax because the receiving fax machine did not answer or was busy, the printer attempts to redial based on the settings for the busy-redial and no-answer-redial options. Use the following procedure to turn the options on or off.

- **Busy redial:** If this option is turned on, the printer redials automatically if it receives a busy signal. The factory-set default for this option is **ON**.
- **No answer redial:** If this option is turned on, the printer redials automatically if the receiving fax machine does not answer. The factory-set default for this option is **OFF**.

To set the redial options

1. Touch right arrow ►, and then select **Setup**.
2. Touch **Fax Setup**, and then select **Advanced Fax Setup**.
3. Touch **Busy Redial** or **No Answer Redial**, and then select the appropriate options.

Set the fax speed

You can set the fax speed used to communicate between your printer and other fax machines when sending and receiving faxes.

If you use one of the following, setting the fax speed to a slower speed might be required:

- An Internet phone service
- A PBX system
- Fax over Internet Protocol (FoIP)
- An integrated services digital network (ISDN) service

If you experience problems sending and receiving faxes, try using a lower **Fax Speed**. The following table provides the available fax speed settings.

Fax speed setting	Fax speed
Fast	v.34 (33600 baud)
Medium	v.17 (14400 baud)
Slow	v.29 (9600 baud)

To set the fax speed

1. Touch right arrow ►, and then select **Setup**.
2. Touch **Fax Setup**, and then touch **Advanced Fax Setup**.
3. Touch **Fax Speed**.
4. Touch to select an option.

Set the fax sound volume

Use this procedure to increase or decrease the volume of the fax sounds.

To set the fax sound volume

1. Touch right arrow , and then select **Setup**.
2. Touch **Fax Setup**, and then select **Basic Fax Setup**.
3. Touch **Fax Sound Volume**.
4. Touch to select **Soft**, **Loud**, or **Off**.

Fax and digital phone services

Many telephone companies provide their customers with digital phone services, such as the following:

- DSL: A Digital subscriber line (DSL) service through your telephone company. (DSL might be called ADSL in your country/region.)
- PBX : A private branch exchange (PBX) phone system
- ISDN: An integrated services digital network (ISDN) system.
- FoIP: A low-cost phone service that allows you to send and receive faxes with your printer by using the Internet. This method is called Fax over Internet Protocol (FoIP). For more information, see [Fax over Internet Protocol](#).

HP printers are designed specifically for use with traditional analog phone services. If you are in a digital phone environment (such as DSL/ADSL, PBX, or ISDN), you might need to use digital-to-analog filters or converters when setting up the printer for faxing.

 **NOTE:** HP does not guarantee that the printer will be compatible with all digital service lines or providers, in all digital environments, or with all digital-to-analog converters. It is always recommended that you discuss with the telephone company directly for the correct setup options based on their line services provided.

Fax over Internet Protocol

You might be able to subscribe to a low cost phone service that allows you to send and receive faxes with your printer by using the Internet. This method is called Fax over Internet Protocol (FoIP).

You probably use a FoIP service (provided by your telephone company) when you:

- Dial a special access code along with the fax number, or
- Have an IP converter box that connects to the Internet and provides analog phone ports for the fax connection.

 **NOTE:** You can only send and receive faxes by connecting a phone cord to the port labeled "1-LINE" on the printer. This means that your connection to the Internet must be done either through a converter box (which supplies regular analog phone jacks for fax connections) or your telephone company.

 **TIP:** Support for traditional fax transmission over any Internet protocol telephone systems are often limited. If you experience problems faxing, try using a slower fax speed or disabling the fax error-correction mode (ECM). However, if you turn off ECM, you cannot send and receive color faxes. (For more information about changing the fax speed, see [Set the fax speed](#). For more information about using ECM, see [Send a fax in Error Correction Mode](#).)

If you have questions about Internet faxing, contact your Internet faxing services support department or your local service provider for further assistance.

Use reports

You can set up the printer to print error reports and confirmation reports automatically for each fax you send and receive. You can also manually print system reports as required; these reports provide useful system information about the printer.

By default, the printer is set to print a report only if there is a problem sending or receiving a fax. A confirmation message that indicates whether a fax was successfully sent appears briefly on the control-panel display after each transaction.

 **NOTE:** If the reports are not legible, you can check the estimated ink levels from the control panel, the HP software (Windows), or HP Utility (Mac OS X). For more information, see [Printer management tools](#).

NOTE: Ink level alerts and indicators provide estimates for planning purposes only. When you receive a low-ink alert, consider having a replacement cartridge available to avoid possible printing delays. You do not need to replace the ink cartridges until print quality becomes unacceptable.

NOTE: Ensure that the printheads and ink cartridges are in good conditions and installed properly. For more information, see [Work with ink cartridges](#).

This section contains the following topics:

- [Print fax confirmation reports](#)
- [Print fax error reports](#)
- [Print and view the fax log](#)
- [Clear the fax log](#)
- [Print the details of the last fax transaction](#)
- [Print a Caller ID Report](#)
- [View the Call History](#)

Print fax confirmation reports

If you require printed confirmation that your faxes were successfully sent, follow these instructions to enable fax confirmation **before** sending any faxes. Select either **On (Fax Send)** or **On (Send and Receive)**.

The default fax confirmation setting is **Off**. This means that a confirmation report is not printed for each fax sent or received. A confirmation message indicating whether a fax was successfully sent appears briefly on the control-panel display after each transaction.

 **NOTE:** You can include an image of the first page of the fax on the Fax Sent Confirmation report if you select **On (Fax Send)** or **On (Send and Receive)**, and if you scan the fax to send from memory or use the **Scan and Fax** option.

To enable fax confirmation

1. Touch right arrow , and then select **Setup**.
2. Touch **Fax Setup**, and then select **Fax Reports**.
3. Touch **Fax Confirmation**.
4. Touch to select one of the following options.

Off	Does not print a fax confirmation report when you send and receive faxes successfully. This is the default setting.
On (Fax Send)	Prints a fax confirmation report for every fax you send.
On (Fax Receive)	Prints a fax confirmation report for every fax you receive.
On (Send and Receive)	Prints a fax confirmation report for every fax you send and receive.



To include an image of the fax on the report

1. Touch **Setup**.
2. Touch **Fax Reports**, and then select **Fax Confirmation**.
3. Touch **On (Fax Send)** or **On (Send and Receive)**.
4. Touch **Fax Confirmation with image**.

Print fax error reports

You can configure the printer so that it automatically prints a report when there is an error during transmission or reception.

To set the printer to print fax error reports automatically



1. Touch right arrow , and then select **Setup**.
2. Touch **Fax Setup**, touch down arrow , and then select **Fax Reports**.
3. Touch **Fax Error Report**.
4. Touch to select one of the following.

On (Send and Receive)	Prints whenever a transmission error occurs.
Off	Prints whenever a receiving error occurs.
On (Fax Send)	Prints whenever a fax error occurs. This is the default setting.
On (Fax Receive)	Does not print any fax error reports.

Print and view the fax log

You can print a log of faxes that have been received and sent by the printer.

To print the fax log from the printer control panel

1. Touch right arrow , and then select **Setup**.
2. Touch **Fax Setup**, touch down arrow , and then select **Fax Reports**.
3. Touch **Fax Log**.

Clear the fax log

Use the following steps to clear the fax log.



NOTE: Clearing the fax log also deletes all faxes stored in memory.



To clear the fax log

1. Touch right arrow , and then select **Setup**.
2. Do one of the following:
 - Touch **Tools**.
 - Or -
 - Touch **Fax Setup**, and then select **Fax Tools**.
3. Touch **Clear Fax Log**.

Print the details of the last fax transaction

The Last Fax Transaction report prints the details of the last fax transaction to occur. Details include the fax number, number of pages, and the fax status.



To print the Last Fax Transaction report

1. Touch right arrow , and then select **Setup**.
2. Touch **Fax Setup**, touch down arrow , and then select **Fax Reports**.
3. Touch **Last Transaction**.

Print a Caller ID Report

Use the following procedure to print a list of Caller ID fax numbers.

To print a Caller ID History Report

1. Touch right arrow , and then select **Setup**.
2. Touch **Fax Setup**, touch down arrow , and then select **Fax Reports**.
3. Touch down arrow , and then select **Caller ID Report**.



View the Call History

Use the following procedure to view a list of all the calls placed from the printer.



NOTE: The call history cannot be printed. You can only view it from the printer's control panel display.

To view the Call History

1. Touch right arrow , and then select **Fax**.
2. Touch  (Call History).

7 Web

The printer offers innovative, Web-enabled solutions that can help you quickly access the Internet, obtain documents, and print them faster and with less hassle—and all without using a computer. In addition, you can use a Web service (Marketsplash by HP) to create and print professional-quality marketing materials.

 **NOTE:** To use these Web features, the printer must be connected to the Internet (either using an Ethernet cable or wireless connection). You cannot use these Web features if the printer is connected using a USB cable.

NOTE: In addition to these solutions, you can send print jobs to the printer remotely from mobile devices. With this service, called HP ePrint, you can print from email connected mobile phones, netbooks, or other mobile devices—anywhere, anytime. For more information, see [HP ePrint](#).

This section contains the following topics:

- [HP Apps](#)
- [Marketsplash by HP](#)

HP Apps

HP Apps provide a quick and easy way to access, store, and print business information without a computer. Using HP Apps, you can gain access to content stored on the Web, such as business forms, news, archiving, and more—right from the printer's control-panel display.

To use HP Apps, the printer needs to be connected to the Internet (either using an Ethernet cable or wireless connection). Follow the instructions on the printer's control panel to enable and set up this service.

New Apps are periodically added, and you can select and download to the printer's control panel for use.

For more information, visit www.hp.com/go/ePrintCenter.

 **NOTE:** For a list of system requirements for this Web site, see [HP Web site specifications](#).

Marketsplash by HP

Grow your business using online HP tools and services to create and print professional marketing materials. With Marketsplash, you can do the following:

- Quickly and easily create amazing, professional-quality brochures, flyers, business cards, and more. Choose from thousands of customizable templates created by award-winning business graphic designers.
- A variety of print options allow you to get exactly what you need, when you need it. For immediate, high-quality results, print on your printer. Other options are available online from HP and our partners. Achieve the professional quality you expect, while minimizing printing costs.
- Keep all of your marketing materials organized and readily accessible in your Marketsplash account, available from any computer and directly from the printer's control-panel display (on select models only).

To get started, select **Marketsplash by HP** in the HP printer software that came with your printer. Or for more information, visit marketsplash.com.

 **NOTE:** For a list of system requirements for this Web site, see [HP Web site specifications](#).

NOTE: Not all Marketsplash tools and services are available in all countries, regions and languages. Visit marketsplash.com for the most current information.

8 Work with ink cartridges

To ensure the best print quality from the printer, you need to perform some simple maintenance procedures. This section provides guidelines for handling the ink cartridges, instructions for replacing the ink cartridges, and aligning and cleaning the printhead.

This section contains the following topics:

- [Information on ink cartridges and the printheads](#)
- [Check the estimated ink levels](#)
- [Replace the ink cartridges](#)
- [Store printing supplies](#)

Information on ink cartridges and the printheads

The following tips help maintain HP ink cartridges and ensure consistent print quality.

- The instructions in this user guide are for replacing ink cartridges, and are not intended for first time installation.
- If you need to replace an ink cartridge, wait until you have the new ink cartridge available to install before removing the old cartridge.

△ **CAUTION:** Wait until you have a new ink cartridge available before removing the old ink cartridge. Do not leave the ink cartridge outside of the printer for an extended period of time.

- Keep all ink cartridges in the original sealed packages until they are needed.
- Store ink cartridges in the same orientation packages hang on store shelves or, if out of box, with label facing down.
- Be sure to turn off the printer properly. For more information, see [Turn the printer off](#).
- Store ink cartridges at room temperature (15-35° C or 59-95° F).
- You do not need to replace the cartridges until you are prompted by the printer.
- A significant decrease in print quality might be caused by a clogged printhead. Possible solutions include cleaning the printheads. Cleaning the printheads uses some ink.
- Do not clean the printheads unnecessarily. This wastes ink and shortens the life of the cartridges.
- Handle ink cartridges carefully. Dropping, jarring, or rough handling during installation can cause temporary printing problems.
- If you are transporting the printer, do the following to prevent ink leaking from the printer or other damage from occurring to the printer:
 - Make sure you turn off the printer by pressing  (Power) button. The printhead assembly should be parked on the right side of the printer, in the service station. For more information, see [Turn the printer off](#).
 - Make sure you leave the ink cartridges and printheads installed.
 - The printer must be transported sitting flat; it should not be placed on its side, back, front, or top.

Related topics

- [Check the estimated ink levels](#)
- [To clean the printheads](#)

Check the estimated ink levels

You can check the estimated ink levels from the printer software or the embedded Web server. For information about using these tools, see [Printer management tools](#). You can also print the Printer Status page to view this information (see [Understand the Self Test Diagnostic Page](#)).

 **NOTE:** Ink level warnings and indicators provide estimates for planning purposes only. When you receive a low-ink warning message, consider having a replacement cartridge available to avoid possible printing delays. You do not need to replace cartridges until prompted to do so.

NOTE: If you have installed a refilled or remanufactured cartridge, or a cartridge that has been used in another printer, the ink level indicator might be inaccurate or unavailable.

NOTE: Ink from the cartridges is used in the printing process in a number of different ways, including in the initialization process, which prepares the printer and cartridges for printing, and in printhead servicing, which keeps print nozzles clear and ink flowing smoothly. In addition, some residual ink is left in the cartridge after it is used. For more information, see www.hp.com/go/inkusage.

Replace the ink cartridges

 **NOTE:** For information on recycling used ink supplies, see [HP inkjet supplies recycling program](#).

If you do not already have replacement ink cartridges for the printer, see [HP supplies and accessories](#).

 **NOTE:** At this time, some portions of the HP Web site are available in English only.

 **CAUTION:** Wait until you have a new ink cartridge available before removing the old ink cartridge. Do not leave the ink cartridge outside of the printer for an extended period of time. This can result in damage to both the printer and the ink cartridge.

To replace the ink cartridges

Use these steps to replace the ink cartridges.

1. Gently pull open the ink cartridge cover.

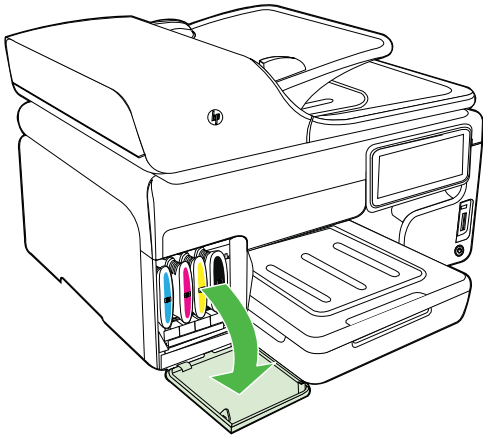

2. Remove the ink cartridge that requires replacement by grasping it and pulling it firmly toward you.

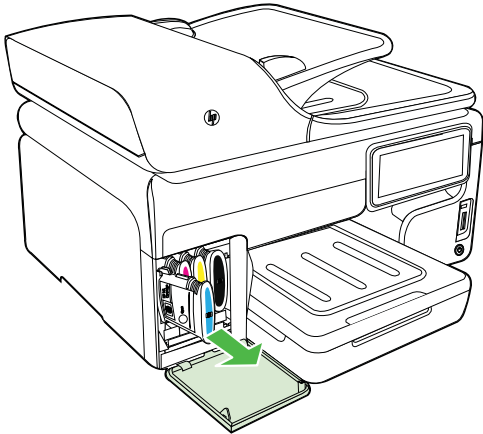

3. Remove the new ink cartridge from its package.
4. Align the cartridge with its color-coded slot and insert the cartridge into the slot. Press down firmly on the cartridge to ensure proper contact.
5. Close the ink cartridge cover.

Store printing supplies

This section covers the following topics:

- [Store ink cartridges](#)
- [Store printheads](#)

Store ink cartridges

Ink cartridges can be left in the printer for extended periods of time. If you remove the ink cartridges, place them in an airtight container, such as a resealable plastic bag.

Store printheads

Printheads can be left in the printer for extended periods of time. However, to assure optimal printhead health, be sure to turn the printer off correctly. For more information, see [Turn the printer off](#).

9 Solve a problem

The information in [Solve a problem](#) suggests solutions to common problems. If your printer is not operating correctly and those suggestions did not solve your problem, try using one of the following support services to obtain assistance.

This section contains the following topics:

- [HP support](#)
- [General troubleshooting tips and resources](#)
- [Solve printing problems](#)
- [Solve print quality problems](#)
- [Solve paper-feed problems](#)
- [Solve copy problems](#)
- [Solve scan problems](#)
- [Solve fax problems](#)
- [Solve problems using HP Web sites and services](#)
- [Solve HP Digital Solutions problems](#)
- [Solve memory device problems](#)
- [Solve wired \(Ethernet\) network problems](#)
- [Solve wireless problems](#)
- [Configure your firewall to work with printers](#)
- [Solve printer management problems](#)
- [Troubleshoot installation issues](#)
- [Understand the Self Test Diagnostic Page](#)
- [Understand the network configuration page](#)
- [Clear jams](#)

HP support

If you have a problem, follow these steps

1. Check the documentation that came with the printer.
2. Visit the HP online support Web site at www.hp.com/support. HP online support is available to all HP customers. It is the fastest source for up-to-date printer information and expert assistance and includes the following features:
 - Fast access to qualified online support specialists
 - HP software and driver updates for the HP printer
 - Valuable troubleshooting information for common problems
 - Proactive printer updates, support alerts, and HP newsgrams that are available when you register the printerFor more information, see [Obtain electronic support](#).
3. Call HP support. Support options and availability vary by printer, country/region, and language. For more information, see [HP support by phone](#).

Obtain electronic support

To find support and warranty information, go to the HP Web site at www.hp.com/support. If prompted, select your country/region, and then click **Contact HP** for information on calling for technical support.

This Web site also offers technical support, drivers, supplies, ordering information and other options such as:

- Access online support pages.
- Send HP an email message for answers to your questions.
- Connect with an HP technician by using online chat.
- Check for HP software updates.

You can also obtain support from the HP software for Windows or Mac OS X, which provide easy, step-by-step solutions to common printing problems. For more information, see [Printer management tools](#).

Support options and availability vary by printer, country/region, and language.

HP support by phone

The phone support numbers and associated costs listed here are those in effect at time of publication and are applicable only for calls made on a land line. Different rates may apply for mobile phones.

For the most current HP list of telephone support numbers and call costs information, see www.hp.com/support.

During the warranty period, you may obtain assistance from the HP Customer Care Center.

 **NOTE:** HP does not provide telephone support for Linux printing. All support is provided online at the following web site: <https://launchpad.net/hplip>. Click the **Ask a question** button to begin the support process.

The HPLIP Web site does not provide support for Windows or Mac OS X. If you are using these operating systems, see www.hp.com/support.

This section contains the following topics:

- [Before you call](#)
- [Phone support period](#)
- [Telephone support numbers](#)
- [After the phone support period](#)

Before you call

Call HP support while you are in front of the computer and the printer. Be prepared to provide the following information:

- Model number (for more information, see [Finding the printer model number](#))
- Serial number (located on the back or bottom of the printer)

- Messages that appear when the situation occurs
- Answers to these questions:
 - Has this situation happened before?
 - Can you re-create it?
 - Did you add any new hardware or software to your computer at about the time that this situation began?
 - Did anything else occur prior to this situation (such as a thunderstorm or moving the printer)?

Phone support period

One year of phone support is available in North America, Asia Pacific, and Latin America (including Mexico).

Telephone support numbers

In many locations, HP provides toll free telephone support during the warranty period. However, some of the support numbers might not be toll free.

For the most current list of telephone support numbers, see www.hp.com/support.



www.hp.com/support

Africa (English speaking)	+27 11 2345872
Afrique (francophone)	+33 1 4993 9230
021 672 280	الجزائر
Algérie	021 67 22 80
Argentina (Buenos Aires)	54-11-4708-1600
Argentina	0-800-555-5000
Australia	1300 721 147
Australia (out-of-warranty)	1902 910 910
Österreich	+43 0820 87 4417 doppelter Ortstarif
17212049	البحرين
België	+32 078 600 019 Peak Hours: 0,05€ p/m Low Hours: 0,27 € p/m
Belgique	+32 078 600 020 Peak Hours: 0,05€ p/m Low Hours: 0,27 €/m
Brasil (Sao Paulo)	55-11-4004-7751
Brasil	0-800-709-7751
Canada	1-(800)-474-6836 (1-800 hp invent)
Central America & The Caribbean	www.hp.com/la/soporte
Chile	800-360-999
中国	1068687980
中国	800-810-3888
Colombia (Bogotá)	571-606-9191
Colombia	01-8000-51-4746-8368
Costa Rica	0-800-011-1046
Česká republika	810 222 222 1.53 CZN/min
Danmark	+45 70 202 845 Opkald: 0,145 (kr. pr. min.) Pr. min. man-lør 08.00-19.30: 0,25 Pr. min. øvrige tidspunkter: 0,125
Ecuador (Andinatel)	1-999-119 ☎ 800-711-2884
Ecuador (Pacifitel)	1-800-225-528 ☎ 800-711-2884
(02) 6910602	مصر
El Salvador	800-6160
España	+34 902 010 059 0,94 € p/m
France	+33 0969 320 435
Deutschland	+49 01805 652 180 0,14 €/Min aus dem deutschen Festnetz - bei Anrufen aus Mobilfunknetzen können andere Preise gelten
Ελλάδα	801-11-75400
Κύπρος	+800 9 2654
Guatemala	1-800-711-2884
香港特別行政區	(852) 2802 4098
India	1-800-425-7737
India	91-80-28526900
Indonesia	+62 (21) 350 3408
+971 4 224 9189	العراق
+971 4 224 9189	الكويت
+971 4 224 9189	ليبنان
+971 4 224 9189	قطر
+971 4 224 9189	اليمن
Ireland	+353 1890 923 902 Calls cost Cost 5.1 cent peak / 1.3 cent off-peak per minute
Italia	+39 848 800 871 costo telefonico locale
Jamaica	1-800-711-2884
日本	0570-000511

日本	03-3335-9800
0800 222 47	الأردن
한국	1588-3003
Luxembourg (Français)	+352 900 40 006 0.15 €/min
Luxemburg (Deutsch)	+352 900 40 007 0.15 €/Min
Madagascar	262 262 51 21 21
Magyarország	06 40 200 629 7,2 HUF/perc vezetékes telefonra
Malaysia	1800 88 8588
Mauritius	262 262 210 404
México (Ciudad de México)	55-5258-9922
México	01-800-472-68368
Maroc	0801 005 010
Nederland	+31 0900 2020 165 0.10 €/Min
New Zealand	0800 441 147
Nigeria	(01) 271 2320
Norge	+47 815 62 070 starter på 0,59 Kr per min., deretter 0,39 Kr per min. Fra mobiltelefon gjelder mobiltelefonaktier.
24791773	عمان
Panamá	1-800-711-2884
Paraguay	009 800 54 1 0006
Perú	0-800-10111
Philippines	2 867 3551
Polska	(22) 583 43 73 Koszt połączenia:- z tel. stacjonarnego jak za 1 impuls wg taryfy operatora, - z tel. komórkowego wg taryfy operatora.
Portugal	+351 808 201 492 Custo: 8 cêntimos no primeiro minuto e 3 cêntimos restantes minutos
Puerto Rico	1-877-232-0589
República Dominicana	1-800-711-2884
Reunion	0820 890 323
România	0801 033 390 (021 204 7090)
Россия (Москва)	495 777 3284
Россия (Санкт-Петербург)	812 332 4240
800 897 1415	السعودية
Singapore	+65 6272 5300
Slovenská republika	0850 111 256
South Africa (RSA)	0860 104 771
Suomi	+358 0 203 66 767
Sverige	+46 077 120 4765 0,23 kr/min
Switzerland	+41 0848 672 672 0,08 CHF/min.
臺灣	02-8722-8000
ไทย	+66 (2) 353 9000
071 891 391	تونس
Trinidad & Tobago	1-800-711-2884
Tunisie	23 926 000
Türkiye (İstanbul, Ankara, İzmir & Bursa)	0(212) 444 0307 Yerel numara: 444 0307
Україна	(044) 230-51-06
600 54 47 47	الإمارات العربية المتحدة
United Kingdom	0844 369 0369 0.50 £ p/m
United States	1-(800)-474-6836
Uruguay	0004-054-177
Venezuela (Caracas)	58-212-278-8666
Venezuela	0-800-474-68368
Việt Nam	+84 88234530

After the phone support period

After the phone support period, help is available from HP at an additional cost. Help may also be available at the HP online support Web site: www.hp.com/support. Contact your HP dealer or call the support phone number for your country/region to learn more about support options.

General troubleshooting tips and resources

 **NOTE:** Many of the following steps require HP software. If you did not install the HP software, you can install it using the HP software CD included with the printer, or you can download the HP software from the HP support Web site (www.hp.com/support).

Try these when you begin troubleshooting a printing problem.

- For a paper jam, see [Clear jams](#).
- For paper-feed problems, such as the paper skew and paper pick, see [Solve paper-feed problems](#).
- Power light is on and not blinking. When the printer is turned on for the first time, it takes approximately 12 minutes to initialize it after the ink cartridges are installed.
- Power cord and other cables are working, and are firmly connected to the printer. Make sure the printer is connected firmly to a functioning alternating current (AC) power outlet, and is turned on. For voltage requirements, see [Electrical specifications](#).
- Media is loaded correctly in the input tray and is not jammed in the printer.
- All packing tapes and materials are removed.
- The printer is set as the current or default printer. For Windows, set it as the default in the Printers folder. For Mac OS X, set it as the default in the Print & Fax section of the System Preferences. See your computer's documentation for more information.
- **Pause Printing** is not selected if you are using a computer running Windows.
- You are not running too many programs when you are performing a task. Close programs that you are not using or restart the computer before attempting the task again.

Solve printing problems

This section contains the following topics:

- [The printer shuts down unexpectedly](#)
- [Alignment fails](#)
- [The printer is not responding \(nothing prints\)](#)
- [Printer takes a long time to print](#)
- [Blank or partial page printed](#)
- [Something on the page is missing or incorrect](#)
- [Placement of the text or graphics is wrong](#)

The printer shuts down unexpectedly

Check the power and power connections

Make sure the printer is connected firmly to a functioning alternating current (AC) power outlet. For voltage requirements, see [Electrical specifications](#).

Alignment fails

If the alignment process fails, make sure you have loaded unused, plain white paper into the input tray. If you have colored paper loaded in the input tray when you align the ink cartridges, the alignment fails.

If the alignment process fails repeatedly, you might have a defective sensor or ink cartridge. Contact HP support. Go to www.hp.com/support. If prompted, select your country/region, and then click **Contact HP** for information on calling for technical support.

The printer is not responding (nothing prints)

There are print jobs stuck in the print queue

Open the print queue, cancel all documents, and then reboot the computer. Try to print after the computer reboots. Refer to the Help system for the operating system for more information.

Check the printer setup

For more information, see [General troubleshooting tips and resources](#).

Check the HP software installation

If the printer is turned off when printing, an alert message should appear on your computer screen; otherwise, the HP software provided with the printer might not be installed correctly. To resolve this, uninstall the HP software completely, and then reinstall the HP software. For more information, see [Uninstall and reinstall the HP software](#).

Check the cable connections

- Make sure both ends of the USB cable or Ethernet cable are secure.
- If the printer is connected to a network, check the following:
 - Check the Link light on the back of the printer.
 - Make sure you are not using a phone cord to connect the printer.

Check any personal firewall software installed on the computer

The personal software firewall is a security program that protects a computer from intrusion. However, the firewall might block communication between the computer and the printer. If there is a problem communicating with the printer, try temporarily disabling the firewall. If the problem persists, the firewall is not the source of the communication problem. Re-enable the firewall.

Printer takes a long time to print

Check the system configuration and resources

Make sure the computer meets the minimum system requirements for the printer. For more information, see [System requirements](#).

Check the HP software settings

Print speed is slower when you select high print-quality settings. To increase the print speed, select different print settings in the printer driver. For more information, see [Print](#).

Blank or partial page printed

Clean the printhead

Complete the printhead cleaning procedure. For more information, see [To clean the printheads](#). The printhead may need to be cleaned if the printer was turned off incorrectly.



NOTE: Incorrectly turning off the printer can cause print quality problems like blank or partial pages. Printhead cleaning can solve these problems, but turning off the printer correctly can prevent them in the first place. Always turn the printer off by pressing the **Power** button on the printer. Wait until the **Power** light goes out before unplugging the power cord or turning off a power strip.

Check the media settings

- Make sure you select the correct print quality settings in the printer driver for the media loaded in the trays.
- Make sure the page settings in the printer driver match the page size of media loaded in the tray.

More than one page is being picked

For more information on paper-feed problems, see [Solve paper-feed problems](#).

There is a blank page in the file

Check the file to make sure there is no blank page.

Something on the page is missing or incorrect

Check the Print Quality Diagnostic page

Print a Print Quality Diagnostic page to help you decide whether to run any maintenance tools to improve the print quality of your printouts. For more information, see [Understand the Self Test Diagnostic Page](#).

Check the margin settings

Make sure the margin settings for the document do not exceed the printable area of the printer. For more information, see [Set minimum margins](#).

Check the color print settings

Make sure **Print in Grayscale** is not selected in the printer driver.

Check the printer location and length of USB cable

High electromagnetic fields (such as those generated by USB cables) can sometimes cause slight distortions to printouts. Move the printer away from the source of the electromagnetic fields. Also, it is recommended that you use a USB cable that is less than 3 meters (9.8 feet) long to minimize the effects of these electromagnetic fields.

Placement of the text or graphics is wrong

Check how the media is loaded

Make sure the media width and length guides fit snugly against the edges of the stack of media, and make sure the tray is not overloaded. For more information, see [Load media](#).

Check the media size

- Content on a page might be cut off if the document size is larger than the media that you are using.
- Make sure the media size selected in the printer driver match the size of media loaded in the tray.

Check the margin settings

If the text or graphics are cut off at the edges of the page, make sure the margin settings for the document do not exceed the printable area of your printer. For more information, see [Set minimum margins](#).

Check the page-orientation setting

Make sure the media size and page orientation selected in the application match the settings in the printer driver. For more information, see [Print](#).

Check the printer location and length of USB cable

High electromagnetic fields (such as those generated by USB cables) can sometimes cause slight distortions to printouts. Move the printer away from the source of the electromagnetic fields. Also, it is recommended that you use a USB cable that is less than 3 meters (9.8 feet) long to minimize the effects of these electromagnetic fields.

If the above solutions do not work, the problem may be caused by the inability of the application to interpret print settings correctly. See the release notes for known software conflicts, refer to the application's documentation, or contact the software manufacturer for specific help.

Solve print quality problems

- [General print quality troubleshooting](#)
- [Meaningless characters print](#)
- [Ink is smearing](#)

- [Ink is not filling the text or graphics completely](#)
- [Output is faded or dull colored](#)
- [Colors are printing as black and white](#)
- [Wrong colors are printing](#)
- [Printout shows bleeding colors](#)
- [The printout has a horizontal band of distortion near the bottom of a borderless print](#)
- [Colors do not line up correctly](#)
- [Text or graphics are streaked](#)
- [Something on the page is missing or incorrect](#)
- [Printhead maintenance](#)

General print quality troubleshooting

Check the printheads and ink cartridges

Print the print quality diagnostic page on a clean sheet of white paper. Evaluate any problem areas, and perform the recommended actions. For more information, see [Printhead maintenance](#).



NOTE: HP cannot guarantee the quality of refilled, remanufactured, or non-HP ink cartridges.

Check the paper quality

Make sure the media meets HP specifications, and try to print again. For more information, see [Media specifications](#).

Check the type of media loaded in the printer

- Make sure the tray supports the type of media you have loaded. For more information, see [Media specifications](#).
- Make sure you have selected the tray in the printer driver that contains the media that you want to use.

Check the printer location and length of USB cable

It is recommended that you use a USB cable that is less than 3 meters (9.8 feet) long to minimize the effects of these electromagnetic fields. You can also try to use a different USB cable to see if the USB cable has failed.

Meaningless characters print

If an interruption occurs to a job that is printing, the printer might not recognize the rest of the job.

Cancel the print job and wait for the printer to return to the ready state. If the printer does not return to the ready state, cancel all jobs in the printer driver, power cycle the printer, and then print the document.

Check the cable connections

If the printer and computer are connected with a USB cable, the problem may be due to a poor cable connection.

Make sure the cable connections at both ends are secure. If the problem persists, turn the printer off, disconnect the cable from the printer, turn on the printer without connecting the cable, and delete any remaining jobs from the print spooler. When the Power light is on and not flashing, reconnect the cable.

Check the document file

The document file may be damaged. If you can print other documents from the same application, try printing a backup copy of your document, if available.

Ink is smearing

Check the print settings

- When you print documents that use a lot of ink, allow more time to dry before handling the printouts. This is especially true for transparencies. In the printer driver, select the **Best** print quality, and also increase the ink drying time and reduce the ink saturation, using the ink volume under the advanced features (Windows) or ink features (Mac OS X). However, note that decreasing ink saturation might give printouts a "washed-out" quality.
- Color documents that have rich, blended colors can wrinkle or smear when printed using the **Best** print quality. Try using another print mode, such as **Normal**, to reduce ink, or use HP Premium Paper designed for printing vivid color documents. For more information, see [Print](#).

Check the media type

- Some types of media do not accept ink well. For these types of media, ink dries more slowly and smearing may occur. For more information, see [Media specifications](#).
- Make sure that the media in the tray matches the media type selected in the printer driver.

Ink is not filling the text or graphics completely

Check the media type

Some media types are not suitable for use with the printer. For more information, see [Media specifications](#).

Check the printheads

Print the print quality diagnostic page on a clean sheet of white paper. Evaluate any problem areas, and perform the recommended actions. For more information, see [Printhead maintenance](#).

Output is faded or dull colored

Check the print mode

The **Draft** or **Fast** mode in the printer driver allows you to print at a faster rate, which is good for printing drafts. To get better results, select **Normal** or **Best**. For more information, see [Print](#).

Check the paper type setting

When printing on transparencies or other special media, select the corresponding media type in the printer driver. For more information, see [Print on special and custom-size paper](#).

Colors are printing as black and white

Check the print settings

Make sure **Print in Grayscale** is not selected in the printer driver. Open the HP software included with the printer, click the **Advanced** tab, and then select **Off** from the **Print in Grayscale** drop-down menu.

Wrong colors are printing

Check the print settings

Make sure **Print in Grayscale** is not selected in the printer driver. Open the HP software included with the printer, click the **Advanced** tab, and then select **Off** from the **Print in Grayscale** drop-down menu.

Check the printheads

Print the print quality diagnostic page on a clean sheet of white paper. Evaluate any problem areas, and perform the recommended actions. For more information, see [Printhead maintenance](#).

Check the print cartridges.

HP cannot guarantee the quality of refilled, remanufactured, or non-HP ink cartridges.

Printout shows bleeding colors

Check the ink cartridges

Make sure you are using genuine HP ink. HP cannot guarantee the quality of refilled, remanufactured, or non-HP ink cartridges. For ordering information, see [Supplies](#).

Check the printheads

Print the print quality diagnostic page on a clean sheet of white paper. Evaluate any problem areas, and perform the recommended actions. For more information, see [Printhead maintenance](#).

The printout has a horizontal band of distortion near the bottom of a borderless print

Check the paper type

HP recommends that you use HP papers or any other paper type that is appropriate for the printer. Always make sure the paper you are printing on is flat. Uncurl paper by bending it in the opposite direction of the curl. For best results when printing images, use HP Advanced Photo Paper. Store photo media in its original packaging inside a resealable plastic bag on a flat surface, in a cool place. When you are ready to print, remove only the paper you plan to use immediately. When you have finished printing, return any unused photo paper to the original package and reseal the bag. This prevents the photo paper from curling. For more information, see [Media specifications](#).

Use a higher print quality setting

Check the print quality setting and make sure it is not set too low. Print the image with a high print quality setting, such as **Best** or **Maximum** dpi.

Rotate the image

- If the problem persists, use the HP software provided with the printer or another software application to rotate your image 180 degrees so that the light blue, gray, or brown hues in your image do not print at the bottom of the page. The defect is more noticeable in areas of uniform light colors, so rotating the image may help.
- There could be a problem with the printhead. Clean the printhead. For more information, see [To clean the printheads](#).

Colors do not line up correctly

Check the printheads

Print the print quality diagnostic page on a clean sheet of white paper. Evaluate any problem areas, and perform the recommended actions. For more information, see [Printhead maintenance](#).

Check the graphics placement

Use the zoom or print preview feature of your software to check for gaps in the placement of graphics on the page.

Text or graphics are streaked

Check the printheads

Print the print quality diagnostic page on a clean sheet of white paper. Evaluate any problem areas, and perform the recommended actions. For more information, see [Printhead maintenance](#).

Something on the page is missing or incorrect

Check the printheads

Print the print quality diagnostic page on a clean sheet of white paper. Evaluate any problem areas, and perform the recommended actions. For more information, see [Printhead maintenance](#).

Check the margin settings

Make sure the margin settings for the document do not exceed the printable area of the printer. For more information, see [Set minimum margins](#).

Check the color print settings

Make sure **Print in Grayscale** is not selected in the printer driver.

Printhead maintenance

If printed characters are incomplete, or printouts are streaked, the ink nozzles might be clogged and you might need to clean the printheads.

When the quality of printouts deteriorates, follow these steps:

1. Check the health of the printheads. For more information, see [To check printhead health](#).
2. Print the print quality diagnostic page on a clean sheet of white paper. Evaluate any problem areas, and perform the recommended actions. For more information, see [Printhead maintenance](#).
3. Clean the printheads. For more information, see [To clean the printheads](#).
4. Replace the printheads if the problems persist after cleaning. For more information, see [Solve wireless problems](#).

This section covers the following printhead maintenance tasks:

- [To check printhead health](#)
- [To print the print quality diagnostic page](#)
- [To align the printheads](#)
- [To calibrate the linefeed](#)
- [To clean the printheads](#)
- [To clean the printhead contacts manually](#)
- [To replace the printheads](#)

To check printhead health

Use one of the following means to check the printhead health. If any printhead has a Replace status, then perform one or more of the maintenance functions, or clean or replace the printhead.

- **Self Test Diagnostic Report:** Print the self test diagnostic report on a clean sheet of white paper, and check the printhead health section. For more information, see [Understand the Self Test Diagnostic Page](#).
- **Embedded Web server:** Open the embedded Web server. For more information, see [To open the embedded Web server](#). Click the **Information** tab, and then click **Ink Supplies** in the left pane.
- **HP Software (Windows):** Open the HP software that was included with the printer. For more information, see [Open the HP software](#). Click the **Information** tab, and then click **Printhead Health**.

To print the print quality diagnostic page

Use the print quality diagnostic page to diagnose issues affecting the print quality. This helps you decide whether to run any maintenance tools to improve the print quality of your printouts. You can also view the ink level information, and the printhead health status on the page.

 **NOTE:** Before printing the print quality diagnostic page, make sure you load paper. For more information, see [Load media](#).

Ink level warnings and indicators provide estimates for planning purposes only. When you receive a low-ink warning message, consider having a replacement cartridge available to avoid possible printing delays. You do not need to replace cartridges until prompted to do so.

-
- **Control panel:** Touch right arrow , touch **Reports**, and then select **Print Quality Page**.
 - **Embedded Web server:** Click the **Settings** tab, click **Device Services** in the left pane, select **Print a PQ (Print Quality) Diagnostic Page** from the drop-down list in the **Print Quality** section, and then click **Run Diagnostic**.
 - **HP Software (Windows):** Open the HP software that was included with the printer. Click the **Device Services** tab, and then click **Print the Print Quality Diagnostic Page** and follow the onscreen instructions.
 - **HP Utility (Mac OS X):** Click the **HP Utility** icon in the Dock, and then click **Print Quality Diagnostics**.

HP Officejet Pro Series
PQ Diagnostic Page

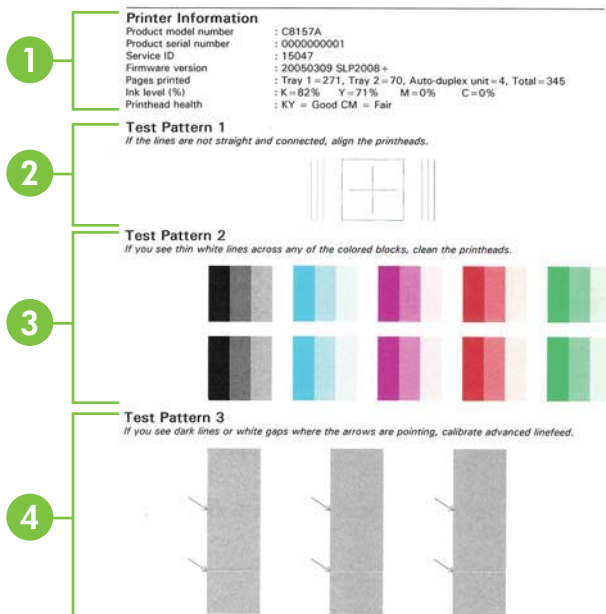



1	<p>Printer Information: Shows printer information (such as the printer model number, serial number, and firmware version number), the number of pages printed from the trays and duplexer, the ink level information, and the printhead health status.</p> <p>NOTE: Ink level warnings and indicators provide estimates for planning purposes only. When you receive a low-ink warning message, consider having a replacement cartridge available to avoid possible printing delays. You do not need to replace cartridges until prompted to do so.</p>
2	<p>Test Pattern 1: If the lines are not straight and connected, align the printheads. For more information, see To align the printheads.</p>
3	<p>Test Pattern 2: If there are thin white lines across any of the colored blocks, clean the printheads. For more information, see To clean the printheads.</p> <p>NOTE: If there are thin white lines across all the color blocks and thin white lines across the gray blocks in Test Pattern 3, do NOT clean the printhead. Calibrate the linefeed instead. For more information, see To calibrate the linefeed.</p>
4	<p>Test Pattern 3: If there are dark lines or white gaps where the arrows are pointing, calibrate the linefeed. For more information, see To calibrate the linefeed.</p>

To align the printheads

Whenever you replace a printhead, the printer automatically aligns the printheads to ensure the best print quality. However, if the lines in Test Pattern 1 on the Print Quality

Diagnostic page are not straight and connected, you can start the alignment process manually. For more information, see [Understand the Self Test Diagnostic Page](#).

 **NOTE:** Before aligning the printheads, make sure you load plain paper. For more information, see [Load media](#).

- **Control panel:** Touch right arrow , touch **Setup**, touch **Tools**, and then select **Align Printer**.
- **Embedded Web server:** Click the **Settings** tab, click **Device Services** in the left pane, select **Align Printer** from the drop-down list in the **Print Quality** section, and then click **Run Diagnostic**.
- **HP Software (Windows):** Open the HP software that was included with the printer. Click **Printer Actions**, click **Maintenance Tasks**, and then click **Align Printheads**.
- **HP Utility (Mac OS X):** Click the **HP Utility** icon in the Dock, and then click **Align**.

To calibrate the linefeed

If Test Pattern 3 on the Print Quality Diagnostic page shows white gaps or dark lines, you need to calibrate the linefeed. For more information, see [Understand the Self Test Diagnostic Page](#).

- **Control panel:** Touch right arrow , touch **Tools**, and then select **Calibrate Linefeed**.
- **Embedded Web server:** Click the **Settings** tab, click **Device Services** in the left pane, select **Calibrate Linefeed** from the drop-down list in the **Print Quality** section, and then click **Run Diagnostic**.
- **HP Software (Windows):** Open the HP software that was included with the printer. Click the **Device Services** tab, and then click **Linefeed Calibration** and follow the onscreen instructions.
- **HP Utility (Mac OS X):** Click the **HP Utility** icon in the Dock, and then click **Calibrate Linefeed**.

To clean the printheads

To determine whether the printheads need to be cleaned, print a Print Quality Diagnostic page. For more information, see [Understand the Self Test Diagnostic Page](#).

 **NOTE:** Cleaning uses ink, so clean the printheads only when necessary.

The cleaning process takes a few minutes. Some noise might be generated in the process.

Before cleaning the printheads, make sure you load paper. For more information, see [Load media](#).

- **Control panel:** Press **Setup**, select **Tools**, and then select **Clean Printhead**.
- **Embedded Web server:** Click the **Device Settings** tab, click **Device Services** in the left pane, select **Clean Printheads** from the drop-down list in the **Print Quality** section, and then click **Run Diagnostic**.

- **HP Software (Windows):** Open the HP software that was included with the printer. Click the **Device Services** tab, and then click **Clean Printheads** and follow the onscreen instructions.
- **HP Utility (Mac OS X):** Click the **HP Utility** icon in the Dock, and then click **Clean Printheads**.

To clean the printhead contacts manually

After the printheads are installed, you might get a control-panel message telling you the printer cannot print. If you receive this message, you might need to clean the electrical contacts on the printheads and in the printer. Make sure there is paper in the printer before you start. See [Load media](#) for more information.

△ **CAUTION:** Electrical contacts contain sensitive electronic components that can be damaged easily.

1. Open the top cover.
2. Touch **Change Printheads** on the printer control panel. Wait for the carriage to stop moving, and then unplug the power cord from the printer.
3. Lift the printhead latch.

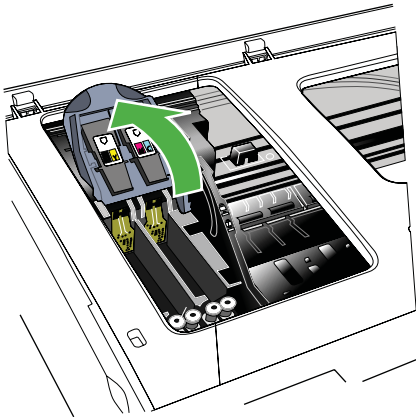

4. Lift the handle of the printhead (which corresponds to the control-panel message) and use it to pull the printhead out of its slot.

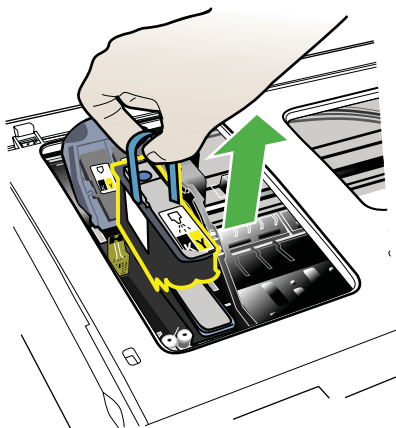

5. Obtain clean, dry, soft and lint-free cleaning material. Suitable materials include paper coffee filters and eyeglass lens cleaning paper.

△ **CAUTION:** Do not use water.

6. Wipe the electrical contacts on the printhead but do not touch the nozzles.

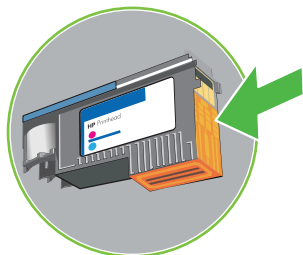

 **NOTE:** The electrical contacts are small copper-color squares, grouped on one face of the printhead.

The nozzles are on a different face of the printhead. Ink is visible on the nozzles.

△ **CAUTION:** Touching the nozzles can cause permanent nozzle damage.

CAUTION: Ink can permanently mark clothing.

7. After cleaning, place the printhead on a sheet of paper or paper towel. Make sure the nozzles are facing up and are not in contact with the paper.

8. Clean the electrical contacts in the printhead slot inside the printer with a clean, dry, soft and lint-free cloth.

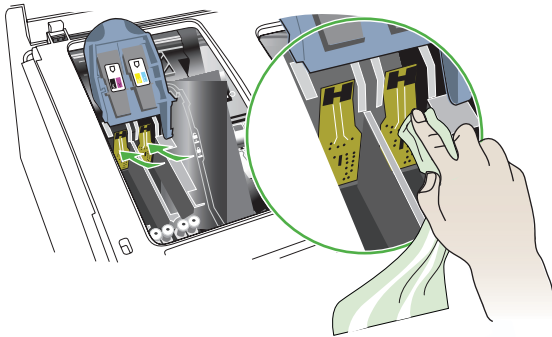

9. Plug in the power cord and turn on the printer. The control panel should indicate that the printhead is missing.
10. Insert the printhead into its color-coded slot (the label on the printhead must match the label on the printhead latch). Press down firmly on the printhead to ensure proper contact.
11. Where necessary, repeat the steps for the remaining printheads.
12. Pull the printhead latch all the way forward, and then press down to ensure that the latch is engaged correctly. You might have to apply some pressure to engage the latch.
13. Close the top cover.
14. If the control-panel message remains, repeat the cleaning procedure for the printhead that corresponds to the message.
15. If the control-panel message remains, replace the printhead which corresponds to the message.
16. Wait while the printer initializes the printheads and prints the alignment pages. If the printer does not print the pages, start the alignment process manually. For more information, see [To align the printheads](#).

To replace the printheads

 **NOTE:** To find out which printheads work with your printer, see [Supplies](#).

Replace the printheads only when the printhead health indicates that the printheads need replacement. For more information, see [To check printhead health](#).

1. Open the top cover.
2. Touch **Change Printheads** on the printer control panel. Wait for the carriage to stop moving.

3. Lift the printhead latch.

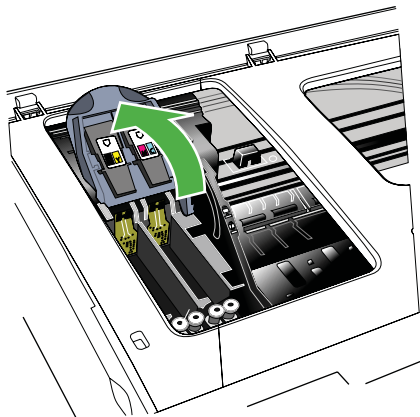

4. Lift the handle of a printhead and use it to pull the printhead out of its slot.

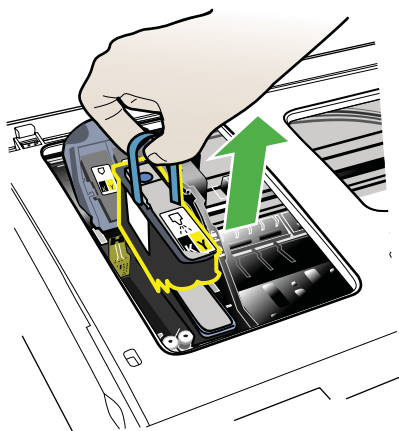

5. Before installing a printhead, shake the printhead up and down at least six times while the printhead is still in its packaging.

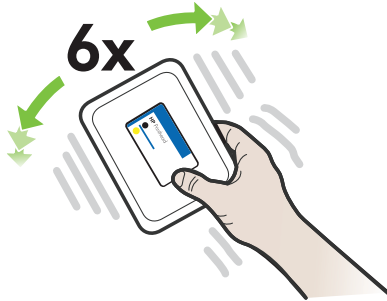

6. Remove the new printhead from its package, and then remove its orange protective caps.

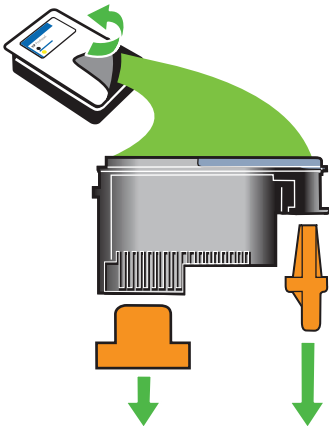

△ **CAUTION:** Do not shake printheads after the caps are removed.

7. Insert the printhead into its color-coded slot (the label on the printhead must match the label on the printhead latch). Press down firmly on the printhead to ensure proper contact.
8. Pull the printhead latch all the way forward, and then press down to ensure that the latch is engaged correctly. You might have to apply some pressure to engage the latch.
9. Close the top cover.
10. Wait while the printer initializes the printheads and prints the alignment pages. If the printer does not print the pages, start the alignment process manually. For more information, see [To align the printheads](#).

Solve paper-feed problems

Media is not supported for the printer or tray

Use only media that is supported for the printer and the tray being used. For more information, see [Media specifications](#).

Media is not picked up from a tray

- Make sure media is loaded in the tray. For more information, see [Load media](#). Fan the media before loading.
- Make sure the paper guides are set to the correct markings in the tray for the media size you are loading. Also make sure the guides are snug, but not tight, against the stack.
- Make sure media in the tray is not curled. Uncurl paper by bending it in the opposite direction of the curl.
- When using thin special media, make sure that the tray is completely loaded. If you are using special media that is only available in small quantities, try placing the special media on top of other paper of the same size to help fill the tray. (Some media is picked up more easily if the tray is full.)
- If you are using thick special media (such as brochure paper), load media so that the tray is between 1/4 and 3/4 full. If necessary, place the media on top of other paper of the same size so that the stack height is within this range.

Media is not coming out correctly

- Make sure the output tray extender is fully extended; otherwise, printed pages may fall off the printer.

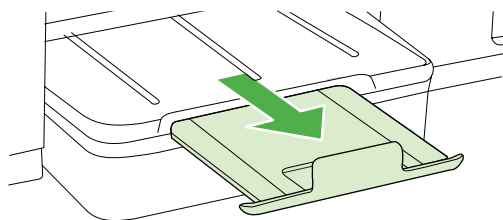

- Remove excess media from the output tray. There is a limit to the number of sheets the tray can hold.

Pages are skewing

- Make sure the media loaded in the trays is aligned to the paper guides. If needed, pull out the trays from the printer and reload the media correctly, making sure that the paper guides are aligned correctly.
- Load media into the printer only when it is not printing.

Multiple pages are being picked up

- Fan the media before loading.
- Make sure the paper guides are set to the correct markings in the tray for the media size you are loading. Also make sure the guides are snug, but not tight, against the stack.
- Make sure the tray is not overloaded with paper.
- When using thin special media, make sure that the tray is completely loaded. If you are using special media that is only available in small quantities, try placing the special media on top of other paper of the same size to help fill the tray. (Some media is picked up more easily if the tray is full.)
- If you are using thick special media (such as brochure paper), load media so that the tray is between 1/4 and 3/4 full. If necessary, place the media on top of other paper of the same size so that the stack height is within this range.
- Use HP media for optimum performance and efficiency.

Solve copy problems

If the following topics do not help, see [HP support](#) for information about HP support.

- [No copy came out](#)
- [Copies are blank](#)
- [Documents are missing or faded](#)
- [Size is reduced](#)
- [Copy quality is poor](#)
- [Copy defects are apparent](#)
- [The printer prints half a page, then ejects the paper](#)
- [Paper mismatch](#)

No copy came out

- **Check the power**
Make sure that the power cord is securely connected, and the printer turned on.
- **Check the status of the printer**
 - The printer might be busy with another job. Check the control-panel display for information about the status of jobs. Wait for any job that is processing to finish.
 - The printer might be jammed. Check for jams. See [Clear jams](#).
- **Check the trays**
Make sure that media is loaded. See [Load media](#) for more information.

Copies are blank

- **Check the media**

The media might not meet Hewlett-Packard media specifications (for example, the media is too moist or too rough). See [Media specifications](#) for more information.
- **Check the settings**

The contrast setting might be set too light. On the printer control panel, touch **Copy**, touch **Lighter Darker**, and then use the arrows to create darker copies.
- **Check the trays**

If you are copying from the automatic document feeder (ADF), make sure that the originals have been loaded correctly. For more information, see [Load an original in the automatic document feeder \(ADF\)](#).

Documents are missing or faded

- **Check the media**

The media might not meet Hewlett-Packard media specifications (for example, the media is too moist or too rough). See [Media specifications](#) for more information.
- **Check the settings**

The quality setting of **Fast** (which produces draft-quality copies) might be responsible for the missing or faded documents. Change to the **Normal** or **Best** setting.
- **Check the original**
 - The accuracy of the copy depends on the quality and size of the original. Use the **Copy** menu to adjust the brightness of the copy. If the original is too light, the copy might not be able to compensate, even if you adjust the contrast.
 - Colored backgrounds might cause images in the foreground to blend into the background, or the background might appear in a different shade.
 - If you are copying a borderless original, load the original on the scanner glass, not the ADF. For more information, see [Load an original on the scanner glass](#).
 - If you are copying a photo, be sure to load it on the scanner glass as indicated by the icon on the scan bed.

Size is reduced

- The reduce/enlarge or other copy feature might have been set from the printer control panel to reduce the scanned image. Check the settings for the copy job to make sure that they are for normal size.
- The HP software settings might be set to reduce the scanned image. Change the settings, if needed. See the onscreen Help for the HP software for more information.

Copy quality is poor

- **Take steps to improve the copy quality**
 - Use quality originals.
 - Load the media correctly. If the media is loaded incorrectly, it might skew, causing unclear images. See [Media specifications](#) for more information.
 - Use or make a carrier sheet to protect your originals.
- **Check the printer**
 - The scanner lid might not be closed correctly.
 - The scanner glass or lid backing might need cleaning. See [Maintain the printer](#) for more information.
 - The automatic document feeder (ADF) might need cleaning. See [Maintain the printer](#) for more information.
- Print a Print Quality Diagnostic Page. Check for nozzle health problems that can cause streaks, wrong colors, and other poor quality copy problems. For more information, see [Printhead maintenance](#).

Copy defects are apparent

- **Vertical white or faded stripes**

The media might not meet Hewlett-Packard media specifications (for example, the media is too moist or too rough). See [Media specifications](#) for more information.
- **Too light or dark**

Try adjusting the contrast and copy-quality settings.
- **Unwanted lines**

The scanner glass, lid backing, or frame might need cleaning. See [Maintain the printer](#) for more information.
- **Black dots or streaks**

Ink, glue, correction fluid, or an unwanted substance might be on the scanner glass or lid backing. Try cleaning the printer. See [Maintain the printer](#) for more information.
- **Copy is slanted or skewed**

If you are using the automatic document feeder (ADF), check the following:

 - Make sure that the ADF input tray is not too full.
 - Make sure that the ADF width adjusters are snug against the sides of the media.
- **Unclear text**
 - Try adjusting the contrast and copy-quality settings.
 - The default enhancement setting might not be suitable for the job. Check the setting and change it to enhance text or photographs, if needed. For more information, see [Change copy settings](#).
- **Incompletely filled text or graphics**

Try adjusting the contrast and copy-quality settings.

- **Large, black typefaces look splotchy (not smooth)**
The default enhancement setting might not be suitable for the job. Check the setting and change it to enhance text or photographs, if needed. For more information, see [Change copy settings](#).
- **Horizontal grainy or white bands in light-gray to medium-gray areas**
The default enhancement setting might not be suitable for the job. Check the setting and change it to enhance text or photographs, if needed. For more information, see [Change copy settings](#).

The printer prints half a page, then ejects the paper

Check the ink cartridges

Make sure the correct ink cartridges are installed and the ink cartridges are not low on ink. For more information, see [Printer management tools](#) and [Understand the Self Test Diagnostic Page](#).

HP cannot guarantee the quality of non-HP ink cartridges.

Paper mismatch

Check the settings

Verify that the loaded media size and type matches the control panel settings.

Solve scan problems

If the following topics do not help, see [HP support](#) for information about HP support.

 **NOTE:** If you are starting the scan from a computer, see the HP software Help for troubleshooting information.

- [Scanner did nothing](#)
- [Scan takes too long](#)
- [Part of the document did not scan or text is missing](#)
- [Text cannot be edited](#)
- [Error messages appear](#)
- [Scanned image quality is poor](#)
- [Scan defects are apparent](#)

Scanner did nothing

- **Check the original**
Make sure that the original is loaded correctly. For more information, see [Load an original on the scanner glass](#).
- **Check the printer**
The printer might be coming out of PowerSave mode after a period of inactivity, which delays processing a short while. Wait until the printer reaches the **READY** state.

Scan takes too long

- **Check the settings**
 - If you set the resolution too high, the scan job takes longer and results in larger files. To obtain good results, do not use a resolution that is higher than needed. You can lower the resolution to scan more quickly.
 - If you acquire an image through TWAIN, you can change the settings so that the original scans in black and white. See the onscreen Help for the TWAIN program for information.
- **Check the status of the printer**

If you sent a print or copy job before you tried to scan, the scan starts if the scanner is not busy. However, the printing and scanning processes share memory, which means that the scan might be slower.

Part of the document did not scan or text is missing

- **Check the original**
 - Make sure that you loaded the original correctly. For more information, see [Load an original on the scanner glass](#).
 - If you scanned the document from the ADF, try scanning the document directly from the scanner glass. For more information, see [Load an original on the scanner glass](#).
 - Colored backgrounds can cause images in the foreground to blend into the background. Try adjusting the settings before you scan the original, or try enhancing the image after you scan the original.
- **Check the settings**
 - Make sure that the input media size is large enough for the original that you are scanning.
 - If you are using the HP Printer Software, the default settings in the HP Printer Software might be set to automatically perform a specific task other than the one that you are attempting. See the onscreen Help for the HP Printer Software for instructions about changing the properties.

Text cannot be edited

- **Check the settings**
 - Make sure that the OCR software is set to edit text.
 - When you scan the original, make sure that you select a document type that creates editable text. If text is classified as a graphic, it is not converted to text.
 - Your OCR program might be linked to a word-processing program that does not perform OCR tasks. See the HP software Help for more information about linking programs.
- **Check the originals**
 - For OCR, the original must be loaded into the ADF with the top forward and face-up. Make sure that you loaded the original correctly. For more information, see [Load an original on the scanner glass](#).
 - The OCR program might not recognize text that is tightly spaced. For example, if the text that the OCR program converts has missing or combined characters, "rn" might appear as "m."

- The accuracy of the OCR program depends on the image quality, text size, and structure of the original and the quality of the scan itself. Make sure that your original has good image quality.
- Colored backgrounds can cause images in the foreground to blend too much. Try adjusting the settings before you scan the original, or try enhancing the image after you scan the original. If you are performing an OCR operation on an original, any colored text on the original does not scan well, if at all.

Error messages appear

- **Unable to activate TWAIN source or An error occurred while acquiring the image**
 - If you are acquiring an image from another device, such as a digital camera or another scanner, make sure that the other device is TWAIN-compliant. Devices that are not TWAIN-compliant do not work with the HP software provided with the printer.
 - If you are using a USB connection, make sure that you have connected the USB Device Cable to the correct port on the back of your computer.
 - Verify that the correct TWAIN source is selected. In the HP software, check the TWAIN source by selecting **Select Scanner** on the **File** menu.
- **Reload document and then restart job**

Touch **OK** on the printer control panel, and then reload the remaining documents in the ADF. For more information see [Load an original on the scanner glass](#).

Scanned image quality is poor

The original is a second-generation photo or picture

Reprinted photographs, such as those in newspapers or magazines, are printed by using tiny dots of ink that make an interpretation of the original photograph, which degrades the quality. Often, the ink dots form unwanted patterns that can be detected when the image is scanned or printed or when the image appears on a screen. If the following suggestions do not solve the problem, you might need to use a better-quality version of the original.

- To eliminate the patterns, try reducing the size of the image after scanning.
- Print the scanned image to see if the quality is better.
- Make sure that the resolution and color settings are correct for the type of scan job.
- For best results, use the scanner glass for scanning rather than the ADF.

Text or images on the back of a two-sided original appear in the scan

Two-sided originals can "bleed" text or images from the back side to the scan if the originals are printed on media that is too thin or too transparent.

The scanned image is skewed (crooked)

The original might have been loaded incorrectly. Be sure to use the media guides when you load the originals into the ADF. For more information, see [Load an original on the scanner glass](#).

The image quality is better when printed

The image that appears on the screen is not always an accurate representation of the quality of the scan.

- Try adjusting your computer monitor settings to use more colors (or levels of gray). On Windows computers, you typically make this adjustment by opening **Display** on the Windows control panel.
- Try adjusting the resolution and color settings.

The scanned image shows blots, lines, vertical white stripes, or other defects

- If the scanner glass is dirty, the image produced does not have optimum clarity. See [Maintain the printer](#) for cleaning instructions.
- The defects might be on the original and are not a result of the scanning process.

Graphics look different from the original

Scan at a higher resolution.

 **NOTE:** Scanning at high resolution can take a long time, and it can take up a large amount of space on your computer.

Take steps to improve the scan quality

- Use the glass to scan rather than the ADF.
- Use high-quality originals.
- Place the media correctly. If the media is placed incorrectly on the scanner glass, it might skew, which causes unclear images. For more information, see [Load an original on the scanner glass](#).
- Adjust the HP software settings according to how you plan to use the scanned page.
- Use or make a carrier sheet to protect your originals.
- Clean the scanner glass. See [Clean the scanner glass](#) for more information.

Scan defects are apparent

• **Blank pages**

Make sure that the original document is placed correctly. Place the original document face down on the flatbed scanner with the top-left corner of the document located in the lower-right corner of the scanner glass.

• **Too light or dark**

- Try adjusting the settings. Be sure to use the correct resolution and color settings.
- The original image might be very light or dark or might be printed on colored paper.

• **Unwanted lines**

Ink, glue, correction fluid, or an unwanted substance might be on the scanner glass. Try cleaning the scanner glass. See [Maintain the printer](#) for more information.

- **Black dots or streaks**
 - Ink, glue, correction fluid, or an unwanted substance might be on the scanner glass; the scanner glass might be dirty or scratched; or the lid backing might be dirty. Try cleaning the scanner glass and lid backing. See [Maintain the printer](#) for more information. If cleaning does not correct the problem, the scanner glass or lid backing might need to be replaced.
 - The defects might be on the original and are not a result of the scanning process.
- **Unclear text**
Try adjusting the settings. Make sure that the resolution and color settings are correct.
- **Size is reduced**
The HP software settings might be set to reduce the scanned image. See the HP printer software Help for more information about changing the settings.

Solve fax problems

This section contains fax setup troubleshooting information for the printer. If the printer is not set up correctly for faxing, you might experience problems when sending faxes, receiving faxes, or both.

If you are having faxing problems, you can print a fax test report to check the status of the printer. The test fails if the printer is not set up correctly for faxing. Perform this test after you have completed setting up the printer for faxing. For more information, see [Test fax setup](#).

If the test fails, review the report for information on how to fix any problems found. For more information, see [The fax test failed](#).

- [The fax test failed](#)
- [The display always shows Phone Off Hook](#)
- [The printer is having problems sending and receiving faxes](#)
- [The printer is having problems sending a manual fax](#)
- [The printer cannot receive faxes, but can send faxes](#)
- [The printer cannot send faxes, but can receive faxes](#)
- [Fax tones are recorded on my answering machine](#)
- [The phone cord that came with my printer is not long enough](#)
- [Color faxes do not print](#)
- [The computer cannot receive faxes \(Fax to PC and Fax to Mac\)](#)

The fax test failed

If you ran a fax test and the test failed, review the report for basic information about the error. For more detailed information, check the report to see which part of the test failed, and then review the appropriate topic in this section for solutions to try.

This section contains the following topics:

- [The "Fax Hardware Test" failed](#)
- [The "Fax Connected to Active Telephone Wall Jack" test failed](#)

- The "Phone Cord Connected to Correct Port on Fax" test failed
- The "Using Correct Type of Phone Cord with Fax" test failed
- The "Dial Tone Detection" test failed
- The "Fax Line Condition" test failed

The "Fax Hardware Test" failed

Solution:

- Turn the printer off by using the **Power** button located on the printer control panel and then unplug the power cord from the back of the printer. After a few seconds, plug the power cord in again, and then turn the power on. Run the test again. If the test fails again, continue reviewing the troubleshooting information in this section.
- Try to send or receive a test fax. If you can send or receive a fax successfully, there might not be a problem.
- If you are running the test from the **Fax Setup Wizard** (Windows) or **HP Setup Assistant** (Mac OS X), make sure the printer is not busy completing another task, such as receiving a fax or making a copy. Check the display for a message indicating that the printer is busy. If it is busy, wait until it is finished and in the idle state before running the test.
- Make sure you use the phone cord that came with the printer. If you do not use the supplied phone cord to connect from the telephone wall jack to the printer, you might not be able to send or receive faxes. After you plug in the phone cord that came with the printer, run the fax test again.
- If you are using a phone splitter, this can cause faxing problems. (A splitter is a two-cord connector that plugs into a telephone wall jack.) Try removing the splitter and connecting the printer directly to the telephone wall jack.

After you resolve any problems found, run the fax test again to make sure it passes and the printer is ready for faxing. If the **Fax Hardware Test** continues to fail and you experience problems faxing, contact HP support. Go to www.hp.com/support. If prompted, select your country/region, and then click **Contact HP** for information on calling for technical support.

The "Fax Connected to Active Telephone Wall Jack" test failed

Solution:

- Check the connection between the telephone wall jack and the printer to make sure the phone cord is secure.
- Make sure you use the phone cord that came with the printer. If you do not use the supplied phone cord to connect from the telephone wall jack to the printer, you might not be able to send or receive faxes. After you plug in the phone cord that came with the printer, run the fax test again.

- Make sure you have correctly connected the printer to the telephone wall jack. Using the phone cord supplied in the box with the printer, connect one end to your telephone wall jack, then connect the other end to the port labeled 1-LINE on the back of the printer. For more information on setting up the printer for faxing, see [Additional fax setup](#).
- If you are using a phone splitter, this can cause faxing problems. (A splitter is a two-cord connector that plugs into a telephone wall jack.) Try removing the splitter and connecting the printer directly to the telephone wall jack.
- Try connecting a working phone and phone cord to the telephone wall jack that you are using for the printer and check for a dial tone. If you do not hear a dial tone, contact your telephone company and have them check the line.
- Try to send or receive a test fax. If you can send or receive a fax successfully, there might not be a problem.

After you resolve any problems found, run the fax test again to make sure it passes and the printer is ready for faxing.

The "Phone Cord Connected to Correct Port on Fax" test failed

Solution: Plug the phone cord into the correct port.

1. Using the phone cord supplied in the box with the printer, connect one end to your telephone wall jack, then connect the other end to the port labeled 1-LINE on the back of the printer.

 **NOTE:** If you use the 2-EXT port to connect to the telephone wall jack, you cannot send or receive faxes. The 2-EXT port should only be used to connect other equipment, such as an answering machine.

Figure 9-1 Back view of the printer



1	Telephone wall jack
2	Use the phone cord supplied in the box with the printer to connect to the "1-LINE" port

2. After you have connected the phone cord to the port labeled 1-LINE, run the fax test again to make sure it passes and the printer is ready for faxing.
3. Try to send or receive a test fax.
 - Make sure you use the phone cord that came with the printer. If you do not use the supplied phone cord to connect from the telephone wall jack to the printer, you might not be able to send or receive faxes. After you plug in the phone cord that came with the printer, run the fax test again.
 - If you are using a phone splitter, this can cause faxing problems. (A splitter is a two-cord connector that plugs into a telephone wall jack.) Try removing the splitter and connecting the printer directly to the telephone wall jack.

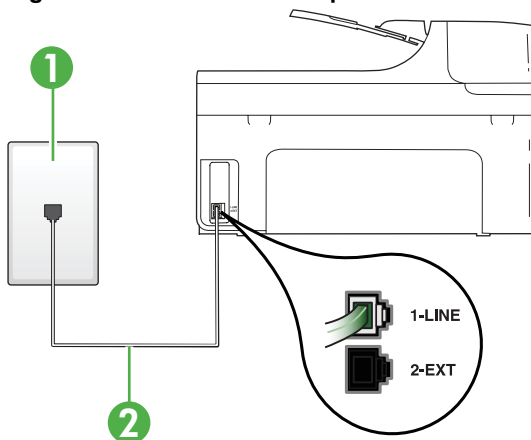
The "Using Correct Type of Phone Cord with Fax" test failed

Solution:

- Make sure you used the phone cord supplied in the box with the printer to connect to the telephone wall jack. One end of the phone cord should be connected to the port labeled 1-LINE on the back of the printer, and the other end to your telephone wall jack, as shown in the illustration.

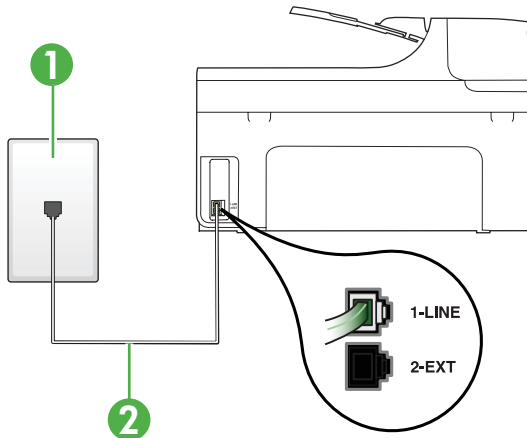

1	Telephone wall jack
2	Use the phone cord supplied in the box with the printer to connect to the "1-LINE" port

If the phone cord that came with the printer is not long enough, you can use a coupler to extend the length. You can purchase a coupler at an electronics store that carries phone accessories. You also need another phone cord, which can be a standard phone cord that you might already have in your home or office.

- Check the connection between the telephone wall jack and the printer to make sure the phone cord is secure.

- Make sure you use the phone cord that came with the printer. If you do not use the supplied phone cord to connect from the telephone wall jack to the printer, you might not be able to send or receive faxes. After you plug in the phone cord that came with the printer, run the fax test again.
 - If you are using a phone splitter, this can cause faxing problems. (A splitter is a two-cord connector that plugs into a telephone wall jack.) Try removing the splitter and connecting the printer directly to the telephone wall jack.
-

The "Dial Tone Detection" test failed

Solution:

- Other equipment, which uses the same phone line as the printer, might be causing the test to fail. To find out if other equipment is causing a problem, disconnect everything from the phone line, and then run the test again. If the **Dial Tone Detection Test** passes without the other equipment, then one or more pieces of the equipment is causing problems; try adding them back one at a time and rerunning the test each time, until you identify which piece of equipment is causing the problem.
- Try connecting a working phone and phone cord to the telephone wall jack that you are using for the printer and check for a dial tone. If you do not hear a dial tone, contact your telephone company and have them check the line.
- Make sure you have correctly connected the printer to the telephone wall jack. Using the phone cord supplied in the box with the printer, connect one end to your telephone wall jack, then connect the other end to the port labeled 1-LINE on the back of the printer.
- If you are using a phone splitter, this can cause faxing problems. (A splitter is a two-cord connector that plugs into a telephone wall jack.) Try removing the splitter and connecting the printer directly to the telephone wall jack.
- If your telephone system is not using a standard dial tone, such as some PBX systems, this might cause the test to fail. This does not cause a problem sending or receiving faxes. Try sending or receiving a test fax.
- Check to make sure the country/region setting is set appropriately for your country/region. If the country/region setting is not set or is set incorrectly, the test might fail and you might have problems sending and receiving faxes.
- Make sure you connect the printer to an analog phone line or you cannot send or receive faxes. To check if your phone line is digital, connect a regular analog phone to the line and listen for a dial tone. If you do not hear a normal sounding dial tone, it might be a phone line set up for digital phones. Connect the printer to an analog phone line and try sending or receiving a fax.
- Make sure you use the phone cord that came with the printer. If you do not use the supplied phone cord to connect from the telephone wall jack to the printer, you might not be able to send or receive faxes. After you plug in the phone cord that came with the printer, run the fax test again.

After you resolve any problems found, run the fax test again to make sure it passes and the printer is ready for faxing. If the **Dial Tone Detection test**

continues to fail, contact your telephone company and have them check the phone line.

The "Fax Line Condition" test failed

Solution:

- Make sure you connect the printer to an analog phone line or you cannot send or receive faxes. To check if your phone line is digital, connect a regular analog phone to the line and listen for a dial tone. If you do not hear a normal sounding dial tone, it might be a phone line set up for digital phones. Connect the printer to an analog phone line and try sending or receiving a fax.
- Check the connection between the telephone wall jack and the printer to make sure the phone cord is secure.
- Make sure you have correctly connected the printer to the telephone wall jack. Using the phone cord supplied in the box with the printer, connect one end to your telephone wall jack, then connect the other end to the port labeled 1-LINE on the back of the printer.
- Other equipment, which uses the same phone line as the printer, might be causing the test to fail. To find out if other equipment is causing a problem, disconnect everything from the phone line, and then run the test again.
 - If the **Fax Line Condition Test** passes without the other equipment, then one or more pieces of the equipment is causing problems; try adding them back one at a time and rerunning the test each time, until you identify which piece of equipment is causing the problem.
 - If the **Fax Line Condition Test** fails without the other equipment, connect the printer to a working phone line and continue reviewing the troubleshooting information in this section.
- If you are using a phone splitter, this can cause faxing problems. (A splitter is a two-cord connector that plugs into a telephone wall jack.) Try removing the splitter and connecting the printer directly to the telephone wall jack.
- Make sure you use the phone cord that came with the printer. If you do not use the supplied phone cord to connect from the telephone wall jack to the printer, you might not be able to send or receive faxes. After you plug in the phone cord that came with the printer, run the fax test again.

After you resolve any problems found, run the fax test again to make sure it passes and the printer is ready for faxing. If the **Fax Line Condition** test continues to fail and you experience problems faxing, contact your telephone company and have them check the phone line.

The display always shows Phone Off Hook

Solution: You are using the wrong type of phone cord. Make sure you are using the phone cord that came with the printer to connect the printer to your phone line. If the phone cord that came with the printer is not long enough, you can use a coupler to extend the length. You can purchase a coupler at an electronics store

that carries phone accessories. You also need another phone cord, which can be a standard phone cord that you might already have in your home or office.

Solution: Other equipment that uses the same phone line as the printer might be in use. Make sure extension phones (phones on the same phone line, but not connected to the printer) or other equipment are not in use or off the hook. For example, you cannot use the printer for faxing if an extension phone is off the hook, or if you are using a computer dial-up modem to send email or access the Internet.

The printer is having problems sending and receiving faxes

Solution: Make sure the printer is turned on. Look at the display on the printer. If the display is blank and the **Power** light is not lit, the printer is turned off. Make sure the power cord is firmly connected to the printer and plugged into a power outlet. Press the **Power** button to turn on the printer.

After turning on the printer, HP recommends you wait five minutes before sending or receiving a fax. The printer cannot send or receive faxes while it is initializing after being turned on.

Solution: If Fax to PC or Fax to Mac has been enabled, you may not be able to send or receive faxes if the fax memory is full (limited by printer memory).

Solution:

- Make sure you used the phone cord supplied in the box with the printer to connect to the telephone wall jack. One end of the phone cord should be

connected to the port labeled 1-LINE on the back of the printer and the other end to your telephone wall jack, as shown in the illustration.

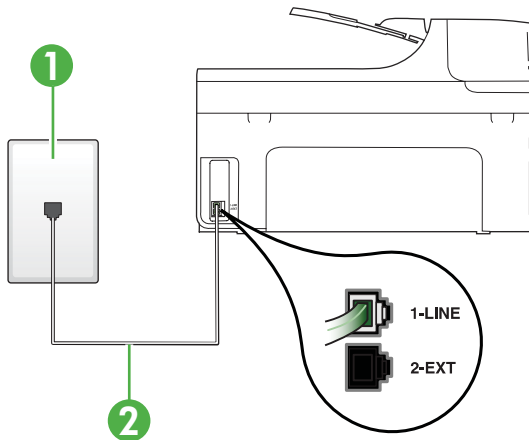

1	Telephone wall jack
2	Use the phone cord supplied in the box with the printer to connect to the "1-LINE" port

If the phone cord that came with the printer is not long enough, you can use a coupler to extend the length. You can purchase a coupler at an electronics store that carries phone accessories. You also need another phone cord, which can be a standard phone cord that you might already have in your home or office.

- Try connecting a working phone and phone cord to the telephone wall jack that you are using for the printer and check for a dial tone. If you do not hear a dial tone, call your local telephone company for service.
- Other equipment, which uses the same phone line as the printer, might be in use. For example, you cannot use the printer for faxing if an extension phone is off the hook, or if you are using a computer dial-up modem to send an email or access the Internet.
- Check to see if another process has caused an error. Check the display or your computer for an error message providing information about the problem and how to solve it. If there is an error, the printer cannot send or receive a fax until the error condition is resolved.
- The phone line connection might be noisy. Phone lines with poor sound quality (noise) can cause faxing problems. Check the sound quality of the phone line by plugging a phone into the telephone wall jack and listening for static or other noise. If you hear noise, turn **Error Correction Mode (ECM)** off and try faxing again. For information about changing ECM, see [Send a fax in Error Correction Mode](#). If the problem persists, contact your telephone company.
- If you are using a digital subscriber line (DSL) service, make sure that you have a DSL filter connected or you cannot fax successfully. For more information, see [Case B: Set up the printer with DSL](#).

- Make sure the printer is not connected to a telephone wall jack that is set up for digital phones. To check if your phone line is digital, connect a regular analog phone to the line and listen for a dial tone. If you do not hear a normal sounding dial tone, it might be a phone line set up for digital phones.
- If you are using either a private branch exchange (PBX) or an integrated services digital network (ISDN) converter/terminal adapter, make sure the printer is connected to the correct port and the terminal adapter is set to the correct switch type for your country/region, if possible. For more information, see [Case C: Set up the printer with a PBX phone system or an ISDN line](#).
- If the printer shares the same phone line with a DSL service, the DSL modem might not be grounded correctly. If the DSL modem is not grounded correctly, it can create noise on the phone line. Phone lines with poor sound quality (noise) can cause faxing problems. You can check the sound quality of the phone line by plugging a phone into the telephone wall jack and listening for static or other noise. If you hear noise, turn off your DSL modem and completely remove power for at least 15 minutes. Turn the DSL modem back on and listen to the dial tone again.

 **NOTE:** You might notice static on the phone line again in the future. If the printer stops sending and receiving faxes, repeat this process.

If the phone line is still noisy, contact your telephone company. For information on turning your DSL modem off, contact your DSL provider for support.

- If you are using a phone splitter, this can cause faxing problems. (A splitter is a two-cord connector that plugs into a telephone wall jack.) Try removing the splitter and connecting the printer directly to the telephone wall jack.

The printer is having problems sending a manual fax

Solution:

 **NOTE:** This possible solution applies only in the countries/regions that receive a 2-wire phone cord in the box with the printer, including: Argentina, Australia, Brazil, Canada, Chile, China, Colombia, Greece, India, Indonesia, Ireland, Japan, Korea, Latin America, Malaysia, Mexico, Philippines, Poland, Portugal, Russia, Saudi Arabia, Singapore, Spain, Taiwan, Thailand, USA, Venezuela, and Vietnam.

- Make sure the telephone you use to initiate the fax call is connected directly to the printer. To send a fax manually, the telephone must be connected directly to the port labeled 2-EXT on the printer, as shown in the illustration.

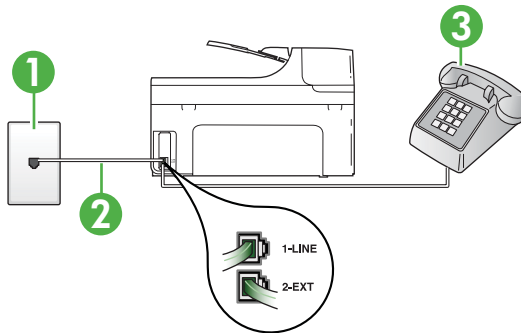

1	Telephone wall jack
2	Use the phone cord supplied in the box with the printer to connect to the "1-LINE" port
3	Telephone

- If you are sending a fax manually from your phone that is connected directly to the printer, you must use the keypad on the telephone to send the fax. You cannot use the keypad on the printer control panel.

 **NOTE:** If using a serial-type phone system, please connect your phone directly on top of the printer cable which has a wall plug attached to it.

The printer cannot receive faxes, but can send faxes

Solution:

- If you are not using a distinctive ring service, check to make sure that the **Distinctive Ring** feature on the printer is set to **All Rings**. For more information, see [Change the answer ring pattern for distinctive ring](#).
- If **Auto Answer** is set to **Off**, you need to receive faxes manually; otherwise, the printer cannot receive the fax. For information on receiving faxes manually, see [Receive a fax manually](#).
- If you have a voice mail service at the same phone number you use for fax calls, you must receive faxes manually, not automatically. This means that you must be available to respond in person to incoming fax calls. For information on setting up the printer when you have a voice mail service, see [Case F: Shared voice/fax line with voice mail](#). For information on receiving faxes manually, see [Receive a fax manually](#).

- If you have a computer dial-up modem on the same phone line with the printer, check to make sure that the software that came with your modem is not set to receive faxes automatically. Modems that are set up to receive faxes automatically take over the phone line to receive all incoming faxes, which prevents the printer from receiving fax calls.
- If you have an answering machine on the same phone line with the printer, you might have one of the following problems:
 - Your answering machine might not be set up correctly with the printer.
 - Your outgoing message might be too long or too loud to allow the printer to detect fax tones, and the sending fax machine might disconnect.
 - Your answering machine might not have enough quiet time after your outgoing message to allow the printer to detect fax tones. This problem is most common with digital answering machines.

The following actions might help solve these problems:

- When you have an answering machine on the same phone line you use for fax calls, try connecting the answering machine directly to the printer as described in [Case I: Shared voice/fax line with answering machine](#).
- Make sure the printer is set to receive faxes automatically. For information on setting up the printer to receive faxes automatically, see [Receive a fax](#).
- Make sure the **Rings to Answer** setting is set to a greater number of rings than the answering machine. For more information, see [Set the number of rings before answering](#).
- Disconnect the answering machine and then try receiving a fax. If faxing is successful without the answering machine, the answering machine might be causing the problem.
- Reconnect the answering machine and record your outgoing message again. Record a message that is approximately 10 seconds in duration. Speak slowly and at a low volume when recording your message. Leave at least 5 seconds of silence at the end of the voice message. There should be no background noise when recording this silent time. Try to receive a fax again.



NOTE: Some digital answering machines might not retain the recorded silence at the end of your outgoing message. Play back your outgoing message to check.

- If the printer shares the same phone line with other types of phone equipment, such as an answering machine, a computer dial-up modem, or a multi-port switch box, the fax signal level might be reduced. The signal level can also be reduced if you use a splitter or connect extra cables to extend the length of your phone. A reduced fax signal can cause problems during fax reception. To find out if other equipment is causing a problem, disconnect everything except the printer from the phone line, and then try to receive a fax. If you can receive faxes successfully without the other equipment, one or more pieces of the other equipment is causing problems; try adding them back one at a time and receiving a fax each time, until you identify which equipment is causing the problem.
 - If you have a special ring pattern for your fax phone number (using a distinctive ring service through your telephone company), make sure that the **Distinctive Ring** feature on the printer is set to match. For more information, see [Change the answer ring pattern for distinctive ring](#).
-

The printer cannot send faxes, but can receive faxes

Solution:

- The printer might be dialing too fast or too soon. You might need to insert some pauses in the number sequence. For example, if you need to access an outside line before dialing the phone number, insert a pause following the access number. If your number is 95555555, and 9 accesses an outside line, you might insert pauses as follows: 9-555-5555. To enter a pause in the fax number you are typing, touch the **Space (#)** button repeatedly, until a dash (-) appears on the display.
You can also send the fax using monitor dialing. This enables you to listen to the phone line as you dial. You can set the pace of your dialing and respond to prompts as you dial. For more information, see [Send a fax using monitor dialing](#).
 - The number you entered when sending the fax is not in the proper format or the receiving fax machine is having problems. To check this, try calling the fax number from a telephone and listen for fax tones. If you cannot hear fax tones, the receiving fax machine might not be turned on or connected, or a voice mail service could be interfering with the recipient's phone line. You can also ask the recipient to check the receiving fax machine for any problems.
-

Fax tones are recorded on my answering machine

Solution:

- When you have an answering machine on the same phone line you use for fax calls, try connecting the answering machine directly to the printer as described in [Case I: Shared voice/fax line with answering machine](#). If you do not connect the answering machine as recommended, fax tones might be recorded on your answering machine.
 - Make sure the printer is set to receive faxes automatically and that the **Rings to Answer** setting is correct. The number of rings to answer for the printer should be greater than the number of rings to answer for the answering machine. If the answering machine and the printer are set to the same number of rings to answer, both devices answer the call and fax tones are recorded on the answering machine.
 - Set your answering machine to a low number of rings and the printer to answer in the maximum number of rings supported. (The maximum number of rings varies by country/region.) In this setup, the answering machine answers the call and the printer monitors the line. If the printer detects fax tones, the printer receives the fax. If the call is a voice call, the answering machine records the incoming message. For more information, see [Set the number of rings before answering](#).
-

The phone cord that came with my printer is not long enough

Solution: If the phone cord that came with the printer is not long enough, you can use a coupler to extend the length. You can purchase a coupler at an electronics store that carries phone accessories. You also need another phone cord, which can be a standard phone cord that you might already have in your home or office.

 **TIP:** If the printer came with a 2-wire phone cord adaptor, you can use it with a 4-wire phone cord to extend the length. For information on using the 2-wire phone cord adaptor, see the documentation that came with it.

To extend your phone cord

1. Using the phone cord supplied in the box with the printer, connect one end to the coupler, then connect the other end to the port labeled 1-LINE on the back of the printer.
 2. Connect another phone cord to the open port on the coupler and to the telephone wall jack.
-

Color faxes do not print

Cause: The Incoming Fax Printing option is turned off.

Solution: To print color faxes, make sure that the Incoming Fax Printing option in the printer control panel is turned on.

The computer cannot receive faxes (Fax to PC and Fax to Mac)

Cause: The computer selected to receive faxes is turned off.

Solution: Make sure the computer selected to receive faxes is switched on at all times.

Cause: Different computers are configured for setup and receiving faxes and one of them may be switched off.

Solution: If the computer receiving faxes is different from the one used for setup, both computers should be switched on at all times.

Cause: Fax to PC or Fax to Mac is not activated or the computer is not configured to receive faxes.

Solution: Activate Fax to PC or Fax to Mac and make sure the computer is configured to receive faxes.

Solve problems using HP Web sites and services

This section provides solutions to common problems using HP Web sites and services.

- [Solve problems using HP Web services](#)
- [Solve problems using HP Web sites](#)

Solve problems using HP Web services

If you are having problems using the HP Apps or other Web services from the printer's control panel, check the following:

- Make sure the printer is connected to the Internet.
-

 **NOTE:** To use the printer's Web features, the printer must be connected to the Internet (either using an Ethernet cable or wireless connection). You cannot use these Web features if the printer is connected using a USB cable.

- Make sure the network hub, switch, or router is turned on and working correctly.
- If you are connecting the printer using an Ethernet cable, make sure you are not connecting the printer using a phone cord or a crossover cable to connect the printer to the network and that the Ethernet cable is securely connected to the printer. For more information, see [Solve wired \(Ethernet\) network problems](#).
- If you are connecting the printer using a wireless connection, make sure the wireless network is functioning properly. For more information, see [Solve wireless problems](#).

Solve problems using HP Web sites

If you are having problems using HP Web sites from your computer, check the following:

- Make sure the computer that you are using is connected to the network.
- Make sure the Web browser meets the minimum system requirements. For more information, see [HP Web site specifications](#).
- If your Web browser uses any proxy settings to connect to the Internet, try turning off these settings. For more information, see the documentation available with your Web browser.

Solve HP Digital Solutions problems

This section covers the following topics:

- [Solving HP Direct Digital Filing problems](#)
- [Solving HP Digital Fax problems](#)

Solving HP Direct Digital Filing problems

This section covers the following topics:

- [Common problems](#)
- [Unable to scan to network folder](#)
- [Unable to scan to e-mail](#)
- [The sharing dialog box is different after setting up HP Direct Digital Filing \(Windows\)](#)

Common problems

Scanned images are incorrectly cropped when scanning using Automatic paper size

Use the correct paper size if available, and only use Automatic when using small media/photos.

The printer is not set up correctly on the network

Make sure that the printer is set up properly and connected to the network:

- Try printing a document using the printer.
- Check the network settings for the printer and make sure it has a valid IP address.
- PING the printer and make sure that it is responding. For more information, see the documentation for your operating system.
- If you are connecting the printer using an Ethernet cable, make sure you are not connecting the printer using a phone cord or a crossover cable to connect the printer to the network and that the Ethernet cable is securely connected to the printer. For more information, see [Solve wired \(Ethernet\) network problems](#).
- If you are connecting the printer using a wireless connection, make sure the wireless network is functioning properly. For more information, see [Solve wireless problems](#).

The server name cannot be found or resolved

Connection to the server might fail if the server name provided during setup cannot be resolved to a specific IP address.

- Try to use the IP address of the server.
- When using DNS, be sure to do the following:
 - Try to use fully qualified DNS names.
 - Make sure the DNS server is set up correctly on the printer.

 **TIP:** If you have recently changed the DNS settings, turn off and then turn on the printer.

For more information, contact your network administrator or the person who set up your network.

Unable to scan to network folder

 **NOTE:** HP Direct Digital Filing does not support Active Directory.

The computer where the network folder is located is turned off

Make sure the computer where the network folder is stored is turned on and connected to the network.

The network folder has not been set up correctly

- Make sure the folder is created on the server. For more information, see the documentation available for your operating system.
- Make sure the folder has been shared and that users can both read and write to the folder. If you are using a Macintosh computer, make sure you have enabled SMB sharing. For more information, see the documentation available for your operating system.
- Make sure the folder name uses only the letters or characters supported by the operating system. For more information, see the documentation available with the operating system.
- Make sure the folder name is entered in the correct format in the HP software. For more information, see the information in the wizard or the setup assistant.
- Make sure the valid username and password have been entered. For more information, see the information in the wizard or the setup assistant.

The disk is full

Make sure the server containing the network folder has sufficient free disk space.

The printer cannot create a unique filename using the assigned prefix and suffix

The printer can create up to 9,999 files using the same prefix and suffix. If you have scanned many files to a folder, change the prefix.

The filename prefix has not been set up correctly

Make sure the folder name and filename uses only the letters or characters supported by the operating system. For more information, see the documentation available with the operating system.

Unable to scan to e-mail

 **NOTE:** If you are using the HP Officejet Pro 8500A (A910a-f), you can only use Scan to Network Folder and Fax to Network Folder. To find your model number, see [Finding the printer model number](#).

The e-mail profile has not been set up correctly

Make sure the valid outgoing SMTP server settings have been specified in the HP software. For more information about the SMTP server settings, see the documentation provided by your e-mail service provider.

E-mail messages are sent to some recipients but not to others when sending to multiple recipients

The e-mail addresses might not be correct or might not be recognized by the e-mail server. Make sure that the e-mail addresses for all e-mail recipients have been entered correctly in the HP software. Check your e-mail Inbox for any delivery notification failure messages from the e-mail server.

Sending large e-mail messages

Some e-mail servers have been configured to reject e-mail messages larger than a pre-determined size. To determine if your e-mail server has a maximum file-size limit, see the documentation provided by your e-mail service provider. If the e-mail server does have such a limit, change the maximum e-mail attachment size for the outgoing e-mail profile to a value smaller than that of the e-mail server.

The sharing dialog box is different after setting up HP Direct Digital Filing (Windows)

If you are using a computer running Windows XP, you can set up folders using Simple File Sharing (SFS). A folder set up using SFS is shared anonymously: it does not require a username or password, and all users can read and write to the folder. Also, the dialog box used to enable sharing is different from the standard, Windows sharing dialog box.

However, to ensure that data sent from the printer is secure, the Scan to Network Folder Wizard does not support SFS, and the computer displays the standard sharing dialog box instead of the SFS dialog box. For more information, see the documentation available for your operating system.

Solving HP Digital Fax problems

 **NOTE:** Fax to Network Folder does not support Active Directory.

NOTE: If you are using the HP Officejet Pro 8500A (A910a-f), you can only use Scan to Network Folder and Fax to Network Folder. To find your model number, see [Finding the printer model number](#).

The computer where the network folder is located is turned off

If you are using Fax to Network Folder, make sure the computer selected to receive faxes is switched on at all times and connected to the network.

The network folder has not been set up correctly

If you are using Fax to Network Folder, verify the following:

- Make sure the folder is created on the server. For more information, see the documentation available for your operating system.
- Make sure the folder has been shared and that users can both read and write to the folder. If you are using a Macintosh computer, make sure you have enabled SMB sharing. For more information, see the documentation available for your operating system.
- Make sure the folder name uses only the letters or characters supported by the operating system. For more information, see the documentation available with the operating system.
- Make sure the folder name is entered in the correct format in the HP software. For more information, see the information in the wizard or the setup assistant.
- Make sure the valid username and password have been entered. For more information, see the information in the wizard or the setup assistant.

Error conditions are interfering with HP Digital Fax

If the printer has been configured to print incoming faxes but is out of paper, load paper in the input tray or resolve the error condition. After the incoming faxes are printed, they are saved to the network folder or forwarded to the designated e-mail address once printed.

The internal memory is full

If the internal memory in the printer is full, you cannot send or receive faxes. If the memory is full because too many unsaved faxes have been stored, follow the instructions on the printer's control panel.

△ **CAUTION:** Clearing the fax log and the internal memory deletes any unsaved faxes stored in the printer's memory.

Incorrect date and time on faxes

If you are in a country/region that is observing Daylight Savings Time, the time stamp for faxes might not always reflect the accurate time for your local time zone. In addition, the default filename of faxes archived (which includes a time stamp) might also be affected.

To see the correct times when faxes are received, print the fax log from the printer control panel.

To enable the correct time to be reported on faxes during Daylight Savings Time, use the EWS to manually change the time zone used by the printer to one that reflects the correct time:

- Open a supported Web browser (such as Microsoft Internet Explorer, Opera, Mozilla Firefox, or Safari) on your computer.
- Type the IP address that has been assigned to printer.
For example, if you are using an IPv4 network environment and the IP address is 123.123.123.123, type the following address into the Web browser:
http://123.123.123.123
If you are using an IPv6-only network environment and the IP address is FE80::BA:D0FF:FE39:73E7, type the following address into the Web browser:
http://[FE80::BA:D0FF:FE39:73E7]
The EWS page appears in the Web browser window.
For more information about using the EWS, see [Embedded Web server](#).
- Click the **Settings** tab, and then, under **Preferences**, click **Time Zone**.
- Select the time zone that corresponds to the correct time (typically a time zone that is one hour ahead of yours).

 **NOTE:** When your country/region returns to Standard Time, change the time zone to reflect your time zone.

Solve memory device problems

If the following topics do not help, see [HP support](#) for information about HP support.

 **NOTE:** If you are starting a memory device operation from a computer, see the software Help for troubleshooting information.

- [The printer cannot read the memory device](#)
- [The printer cannot read photos on the memory device](#)

The printer cannot read the memory device

- **Check the memory device**
 - Make sure that the memory device is one of the supported types. For more information, see [Memory device specifications](#).
 - Some memory devices have a switch that controls how they can be used. Make sure that the switch is set so that the memory device can be read.

- Inspect the ends of the memory device for dirt or material that closes a hole or spoils a metal contact. Clean the contacts with a lint-free cloth and small amounts of isopropyl alcohol.
- Make sure that the memory device is working correctly by testing it with other devices.
- **Check the memory device slot**
 - Make sure that the memory device is fully inserted into the correct slot. For more information, see [Insert a memory device](#).
 - Remove the memory card (when the light is not blinking) and shine a flashlight into the empty slot. See if any of the small pins inside are bent. When the computer is off, you can straighten slightly bent pins by using the tip of a thin, retracted ballpoint pen. If a pin has bent in such a way that it touches another pin, replace the memory card reader or have the printer serviced. For more information, see [HP support](#).
 - Make sure that only one memory device has been inserted at a time in the slots. An error message should appear on the control-panel display if more than one memory device is inserted.

The printer cannot read photos on the memory device

Check the memory device

The memory device might be corrupt.

Solve wired (Ethernet) network problems

If you are unable to connect the printer to your wired (Ethernet) network, perform one or more of the following tasks.



NOTE: After correcting any of the following, run the installation program again.

- [General network troubleshooting](#)
- [Network port created does not match printer IP address \(Windows\)](#)

General network troubleshooting

If you are unable to install the HP software provided with the printer, verify that:

- All cable connections to the computer and the printer are secure.
- The network is operational and the network hub is turned on.
- All applications, including virus protection programs, spyware protection programs, and firewalls, are closed or disabled for computers running Windows
- The printer is installed on the same subnet as the computers that use the printer.

If the installation program cannot discover the printer, print the network configuration page, and enter the IP address manually in the installation program. For more information, see [Understand the network configuration page](#).

Though it is not recommended that you assign the printer with a static IP address, you might resolve some installation problems (such as a conflict with a personal firewall) by doing so.

Network port created does not match printer IP address (Windows)

If you are using a computer running Windows, make sure that the network ports created in the printer driver match the printer IP address:

1. Print the printer's network configuration page
2. Click **Start**, point to **Settings**, and then click **Printers** or **Printers and Faxes**.
- or -
Click **Start**, click **Control Panel**, and then double-click **Printers**.
3. Right-click the printer icon, click **Properties**, and then click the **Ports** tab.
4. Select the TCP/IP port for the printer, and then click **Configure Port**.
5. Compare the IP address listed in the dialog box and make sure it matches the IP address listed on the network configuration page. If the IP addresses are different, change the IP address in the dialog box to match the address on the network configuration page.
6. Click **OK** twice to save the settings and close the dialog boxes.

Solve wireless problems

If the printer is unable to communicate with the network after completing the wireless setup and HP software installation, perform one or more of these tasks in the following order.

- [Basic wireless troubleshooting](#)
- [Advanced wireless troubleshooting](#)

Basic wireless troubleshooting

Perform the following steps in the order presented.

 **NOTE:** If this is the first time you are setting up the wireless connection, and you are using the HP software included with the printer, make sure that the USB cable is connected to the printer and the computer.

Step 1 - Make sure the wireless (802.11) light is turned on

If the blue light near the printer's wireless button is not lit, the wireless capabilities might not have been turned on. To turn on wireless, touch right arrow , touch **Network**, touch **Wireless**, touch **Wireless Radio**, and then select **Yes**.

 **NOTE:** If your printer supports Ethernet networking, make sure that an Ethernet cable has not been connected to the printer. Connecting an Ethernet cable turns off the printer's wireless capabilities.

Step 2 - Restart components of the wireless network

Turn off the router and the printer, and then turn them back on in this order: router first and then the printer. If you still are unable to connect, turn off the router, printer, and your computer. Sometimes, turning off the power and then turning it back on recovers a network communication issue.

Step 3 - Run the Wireless Network Test

For wireless networking issues, run the Wireless Network Test. To print a Wireless Network Test page, touch right arrow , touch **Network**, touch **Wireless**, and then select **Wireless Network Test**. If a problem is detected, the printed test report includes recommendations that might help solve the problem.

Advanced wireless troubleshooting

If you have tried the suggestions provided in the Basic troubleshooting section and are still unable to connect to your printer to the wireless network, try the following suggestions in the order presented:

- [Step 1: Make sure your computer is connected to your network](#)
- [Step 2: Make sure that the printer is connected to your network](#)
- [Step 3: Check to see if the firewall software is blocking communication](#)
- [Step 4: Make sure the printer is online and ready](#)
- [Step 5: Make sure the wireless version of the printer is set as the default printer driver \(Windows only\)](#)
- [Step 6: Make sure the HP Network Devices Support service is running \(Windows only\)](#)
- [Add hardware addresses to a wireless access point \(WAP\)](#)

Step 1: Make sure your computer is connected to your network

To check a wired (Ethernet) connection

- ▲ Many computers have indicator lights beside the port where the Ethernet cable from the router connects to your computer. Usually there are two indicator lights, one that is on and another that blinks. If your computer has indicator lights, check to see if the indicator lights are on. If the lights are not on, try reconnecting the Ethernet cable to the computer and the router. If you still do not see lights, there might be a problem with the router, the Ethernet cable, or your computer.



NOTE: Macintosh computers do not have indicator lights. To check the Ethernet connection on a Macintosh computer, click **System Preferences** in the Dock, and then click **Network**. If the Ethernet connection is working correctly, **Built-in Ethernet** appears in the list of connections, along with the IP address and other status information. If **Built-in Ethernet** does not appear in the list, there might be a problem with the router, the Ethernet cable, or your computer. For more information, click the Help button in the window.

To check a wireless connection

1. Make sure that your computer's wireless has been turned on. (For more information, see the documentation that came with your computer.)
2. If you are not using a unique network name (SSID), then it is possible that your wireless computer could be connected to a nearby network that is not yours. The following steps can help you determine if your computer is connected to your network.

Windows

- a. Click **Start**, click **Control Panel**, point to **Network Connections**, and then click **View Network Status and Tasks**.
or
Click **Start**, select **Settings**, click **Control Panel**, double-click **Network Connections**, click the **View** menu, and then select **Details**.
Leave the network dialog box open while you continue to the next step.
- b. Disconnect the power cord from the wireless router. The connection status of your computer should change to **Not Connected**.
- c. Reconnect the power cord to the wireless router. The connection status should change to **Connected**.

Mac OS X

- ▲ Click the **AirPort** icon in the menu bar at the top of the screen. From the menu that appears, you can determine if the AirPort is turned on and which wireless network your computer is connected to.



NOTE: For more detailed information about your AirPort connection, click **System Preferences** in the Dock, and then click **Network**. If the wireless connection is working correctly, a green dot appears next to AirPort in the list of connections. For more information, click the Help button in the window.

If you are unable to get your computer connected to your network, contact the person who set up your network or the router manufacturer as there might be a hardware issue with either your router or computer.

If you are able to access the Internet and are using a computer running Windows, you can also access HP Network Assistant at www.hp.com/sbso/wireless/tools-setup.html?jumpid=reg_R1002_USEN for help in setting up a network. (This Web site is only available in English.)

Step 2: Make sure that the printer is connected to your network

If your printer is not connected to the same network as your computer, you cannot use the printer over the network. Follow the steps described in this section to find out if your printer is actively connected to the correct network.



NOTE: If your wireless router or Apple AirPort Base Station is using a hidden SSID, your printer cannot automatically detect the network.

A: Make sure the printer is on the network

1. If the printer supports Ethernet networking and is connected to an Ethernet network, make sure an Ethernet cable is not plugged into the back of the printer. If an Ethernet cable is plugged into the back, then wireless connectivity is disabled.
2. If the printer is connected to a wireless network, print the printer's Wireless Configuration page. For more information, see [Understand the network configuration page](#).
 - ▲ After the page has been printed, check the Network Status and URL:

Network Status	<ul style="list-style-type: none">• If the Network Status is Ready, the printer is actively connected to a network.• If the Network Status is Offline, the printer is not connected to a network. Run the Wireless Network Test (using the instructions at the beginning of this section) and follow any recommendations.
URL	The URL shown here is the network address assigned to the printer by your router. You need this to connect to the embedded Web server.

B: Check to see if you can access the EWS

- ▲ After you establish that the computer and the printer both have active connections to a network, you can verify if they are on the same network by accessing the printer's EWS. For more information, see [Embedded Web server](#).

To access the EWS

- a. On your computer, open the Web browser you typically use to access the Internet (for example, Internet Explorer or Safari). In the address box, type the URL of the printer as it was shown on the network configuration page (for example, <http://192.168.1.101>).



NOTE: If you are using a proxy server in your browser, you might need to disable it to access the EWS.

- b. If you can access the EWS, try using the printer over the network (such as to print) to see if your network setup was successful.
- c. If you cannot access the EWS or are still having problems using the printer over the network, continue to the next section regarding firewalls.

Step 3: Check to see if the firewall software is blocking communication

If you cannot access the EWS and are sure both the computer and printer have active connections to the same network, the firewall security software might be blocking communication. Temporarily turn off any firewall security software running on your computer and then try to access the EWS again. If you can access the EWS, try using the printer (for printing).

If you are able to access the EWS and use your printer with the firewall turned off, you need to reconfigure your firewall settings to allow the computer and printer to communicate with each other over the network. For more information, see [Configure your firewall to work with printers](#).

If you are able to access the EWS, but are still unable to use the printer even with the firewall turned off, try enabling the firewall software to recognize the printer.

Step 4: Make sure the printer is online and ready

If you have the HP software installed, you can check the printer's status from your computer to see if the printer is paused or offline, preventing you from using it.

To check the printer's status, complete the following steps:

Windows

1. Click **Start**, point to **Settings**, and then click **Printers** or **Printers and Faxes**.
- Or -
Click **Start**, click **Control Panel**, and then double-click **Printers**.
2. If the printers on your computer are not being displayed in Details view, click the **View** menu, and then click **Details**.
3. Do one of the following, depending on the printer status:
 - a. If the printer is **Offline**, right-click the printer, and click **Use Printer Online**.
 - b. If the printer is **Paused**, right-click the printer, and click **Resume Printing**.
4. Try using the printer over the network.

Mac OS X

1. Click **System Preferences** in the Dock, and then click **Print & Fax**.
2. Select the printer, and then click **Print Queue**.
3. If **Jobs Stopped** appears in the window that appears, click **Start Jobs**.

If you can use the printer after performing the steps above but find that the symptoms persist as you continue to use the printer, your firewall might be interfering. If you still cannot use the printer over the network, continue to the next section for additional troubleshooting help.

Step 5: Make sure the wireless version of the printer is set as the default printer driver (Windows only)

If you install the HP software again, the installer might create a second version of the printer driver in your **Printers** or **Printers and Faxes** folder. If you have difficulties

printing or connecting to the printer, make sure the correct version of the printer driver is set as the default.

1. Click **Start**, point to **Settings**, and then click **Printers** or **Printers and Faxes**.
- Or -
Click **Start**, click **Control Panel**, and then double-click **Printers**.
2. Determine if the version of the printer driver in the **Printers** or **Printers and Faxes** folder is connected wirelessly:
 - a. Right-click the printer icon, and then click **Properties**, **Document Defaults**, or **Printing Preferences**.
 - b. On the **Ports** tab, look for a port in the list with a checkmark. The version of the printer driver that is connected wirelessly has **Standard TCP/IP Port** as the Port description, next to the checkmark.
3. Right-click the printer icon for the version of the printer driver that is connected wirelessly, and select **Set as Default Printer**.

 **NOTE:** If there is more than one icon in the folder for the printer, right-click the printer icon for the version of the printer driver that is connected wirelessly, and select **Set as Default Printer**.

Step 6: Make sure the HP Network Devices Support service is running (Windows only)

To restart the HP Network Device Support service

1. Delete any print jobs currently in the print queue.
2. On the desktop, right-click **My Computer** or **Computer**, and then click **Manage**.
3. Double-click **Services and Applications**, and then click **Services**.
4. Scroll down the list of services, right click **HP Network Devices Support**, and then click **Restart**.
5. After the service restarts, try using the printer over the network again.

If you are able to use the printer over the network, your network setup was successful.

If you still cannot use the printer over the network or if you have to periodically perform this step in order to use your printer over the network, your firewall might be interfering.

If this still does not work, there might be a problem with your network configuration or router. Contact the person who set up your network or the router manufacturer for help.

Add hardware addresses to a wireless access point (WAP)

MAC filtering is a security feature in which a WAP is configured with a list of MAC addresses (also called “hardware addresses”) of devices that are allowed to gain access to the network through the WAP. If the WAP does not have the hardware address of a device attempting to access the network, the WAP denies the device

access to the network. If the WAP filters MAC addresses, then the printer's MAC address must be added to the WAP's list of accepted MAC addresses.

- Print the network configuration page. For more information, see [Understand the network configuration page](#).
- Open the WAP's configuration utility, and add the printer's hardware address to the list of accepted MAC addresses.

Configure your firewall to work with printers

A personal firewall, which is security software running on your computer, can block network communication between your printer and your computer.

If you are having problems such as:

- Printer not found when installing HP software
- Unable to print, print job stuck in queue or printer goes offline
- Scan communication errors or scanner busy messages
- Unable to see printer status on your computer

The firewall might be preventing your printer from notifying computers on your network where it can be found. If the HP software cannot find the printer during installation (and you know the printer is on the network), or you have already successfully installed HP software and experience problems, try the following:

1. If you are using a computer running Windows, in the firewall configuration utility, look for an option to trust computers on the local subnet (sometimes called the "scope" or "zone"). By trusting all computers on the local subnet, computers and devices in your home or office can communicate with each other while still being protected from the internet. This is the easiest approach to use.
2. If you do not have the option to trust computers on the local subnet, add incoming UDP port 427 to your firewall's list of allowed ports.



NOTE: Not all firewalls require you to differentiate between incoming and outgoing ports, but some do.

Another common problem is that HP software is not set as a trusted software by your firewall to access the network. This can happen if you answered "block" to any firewall dialog boxes that appeared when you installed the HP software.

If this occurs, and if you are using a computer running Windows, check that the following programs are in your firewall's list of trusted applications; add any that are missing.

- **hpqkygrp.exe**, located in **C:\program files\HP\ digital imaging\bin**
- **hpqscnvw.exe**, located in **C:\program files\HP\ digital imaging\bin**
- or -
- **hpiscnapp.exe**, located in **C:\program files\HP\ digital imaging\bin**
- **hpqste08.exe**, located in **C:\program files\HP\ digital imaging\bin**
- **hpqtra08.exe**, located in **C:\program files\HP\ digital imaging\bin**
- **hpqthb08.exe**, located in **C:\program files\HP\ digital imaging\bin**

 **NOTE:** Refer to your firewall documentation on how to configure the firewall port settings and how to add HP files to the “trusted” list.

Some firewalls continue to cause interference even after you disable them. If you continue to have problems after configuring the firewall as described above and if you are using a computer running Windows, you might need to uninstall the firewall software in order to use the printer over the network.

Advanced firewall information

The following ports are also used by your printer and might need to be opened on your firewall configuration. Incoming ports (UDP) are destination ports on the computer while outgoing ports (TCP) are destination ports on the printer.

- **Incoming (UDP) ports:** 137, 138, 161, 427
- **Outgoing (TCP) ports:** 137, 139, 427, 9100, 9220, 9500

The ports are used for the following functions:

Printing

- **UDP ports:** 427, 137, 161
- **TCP port:** 9100

Photo card upload

- **UDP ports:** 137, 138, 427
- **TCP port:** 139

Scanning

- **UDP port:** 427
- **TCP ports:** 9220, 9500

HP printer status

UDP port: 161

Faxing

- **UDP port:** 427
- **TCP port:** 9220

HP printer installation

UDP port: 427

Solve printer management problems

This section provides solutions to common problems that involve managing the printer. This section contains the following topic:

- [Embedded Web server cannot be opened](#)



NOTE: To use the embedded EWS, the printer must be connected to a network using either an Ethernet or a wireless connection. You cannot use the embedded Web server if the printer is connected to a computer with a USB cable.

Embedded Web server cannot be opened

Check your network setup

- Make sure you are not using a phone cord or a crossover cable to connect the printer to the network.
- Make sure the network cable is securely connected to the printer.
- Make sure the network hub, switch, or router is turned on and working correctly.

Check the computer

Make sure the computer that you are using is connected to the network.



NOTE: To use the EWS, the printer must be connected to a network using either an Ethernet or a wireless connection. You cannot use the embedded Web server if the printer is connected to a computer with a USB cable.

Check your Web browser

- Make sure the Web browser meets the minimum system requirements. For more information, see [System requirements](#).
- If your Web browser uses any proxy settings to connect to the Internet, try turning off these settings. For more information, see the documentation available with your Web browser.
- Make sure JavaScript and cookies are enabled in your Web browser. For more information, see the documentation available with your Web browser.

Check the printer IP address

- To check the IP address of the printer, obtain the IP address by printing a network configuration page. Touch **right arrow**, select **Setup**, select **Network**, and then select **Print Network Settings**.
- Ping the printer using the IP address from the command prompt.
For example, if the IP address is 123.123.123.123, type the following at the MS-DOS prompt:

```
C:\>ping 123.123.123.123
```

Or, in Mac OS X, use one of the following methods:
 - Open Terminal (available in the Applications > Utilities folder) and type the following: `ping 123.123.123`
 - Open the Network Utility (available in the Applications > Utilities folder) and click the **Ping** tab.
If a reply appears, the IP address is correct. If a time-out response appears, the IP address is incorrect.

Troubleshoot installation issues

If the following topics do not help, see [HP support](#) for information about HP support.

- [Hardware installation suggestions](#)
- [HP software installation suggestions](#)
- [Solve network problems](#)

Hardware installation suggestions

Check the printer

- Make sure that all packing tape and material have been removed from outside and inside the printer.
- Make sure that the printer is loaded with paper.
- Make sure that no lights are on or blinking except the Ready light, which should be on. If the Attention light is blinking, check for messages on the printer control panel.

Check the hardware connections

- Make sure that any cords and cables that you are using are in good working order.
- Make sure that the power cord is connected securely to both the printer and to a working power outlet.

Check the printheads and ink cartridges

- Make sure that all of the printheads and ink cartridges are firmly installed in their correct, color-coded slot. Press down firmly on each one to ensure proper contact. The printer cannot work if they are not all installed.
- Make sure that the printhead latch is closed correctly.
- If the display shows a printhead error message, clean the contacts on the printheads.

HP software installation suggestions

Check the computer system

- Make sure that your computer is running one of the supported operating systems.
- Make sure that the computer meets at least the minimum system requirements.
- In the Windows Device Manager, make sure that the USB drivers have not been disabled.
- If you are using a computer running Windows, and the computer cannot detect the printer, run the uninstallation utility (util\ccc\uninstall.bat on the installation CD) to perform a clean uninstallation of the printer driver. Restart your computer, and reinstall the printer driver.

Verify installation preliminaries

- Make sure to use the installation CD that contains the correct HP software for your operating system.
- Before installing HP software, make sure that all other programs are closed.
- If the computer does not recognize the path to the CD-ROM drive that you type, make sure that you are specifying the correct drive letter.
- If the computer cannot recognize the installation CD in the CD-ROM drive, inspect the installation CD for damage. You can download the printer driver from the HP Web site (www.hp.com/support).



NOTE: After correcting any problems, run the installation program again.

Solve network problems

General network troubleshooting

- If you are unable to install the HP software, verify that:
 - All cable connections to the computer and the printer are secure.
 - The network is operational and the network hub is turned on.
 - All applications, including virus protection programs, spyware protection programs, and firewalls, are closed or disabled for computers running Windows.
 - Make sure the printer is installed on the same subnet as the computers that use the printer.
 - If the installation program cannot discover the printer, print the network configuration page and enter the IP address manually in the installation program. For more information, see [Understand the network configuration page](#).
- If you are using a computer running Windows, make sure that the network ports created in the printer driver match the printer IP address:
 - Print the printer's network configuration page.
 - Click **Start**, then click **Printers** or **Printers and Faxes**.
- Or -
Click **Start**, click **Control Panel**, and then double-click **Printers**.
 - Right-click the printer icon, click **Properties**, and then click the **Ports** tab.
 - Select the TCP/IP port for the printer, and then click **Configure Port**.
 - Compare the IP address listed in the dialog box and make sure it matches the IP address listed on the network configuration page. If the IP addresses are different, change the IP address in the dialog box to match the address on the network configuration page.
 - Click **OK** twice to save the settings and close the dialog boxes.

Problems connecting to a wired network

- If the **Network** light on the printer control panel does not turn on, make sure that all of the "General network troubleshooting" conditions are met.
- Though it is not recommended that you assign the printer with a static IP address, you might resolve some installation problems (such as a conflict with a personal firewall) by doing so.

To reset the printer's network settings

1. Touch right arrow ►, touch **Network**, touch **Restore Network Defaults**, and then select **Yes**. A message appears stating that the network defaults have been restored.
2. Touch right arrow ►, touch **Reports**, and then select **Print Network Configuration Page** to print the network configuration page and verify that the network settings have been reset.

Understand the Self Test Diagnostic Page

Use the self test diagnostic page to view current printer information and ink cartridge status. Also use the self test diagnostic page to help you troubleshoot problems with the printer.

The self test diagnostic page also contains a log of recent events.

If you need to call HP, it is often useful to print the self test diagnostic page before calling.

HP Officejet Pro 8500 A910 Series
Self Test Diagnostic Page

Printer Information

Product name: HP Officejet Pro 8500 A910
Product model number: CM726A
Product serial number: CN61813375
Service ID: 20070
Firmware version: LRL2FA0301N
Autoduplex unit: Installed
Pages printed: Tray 1=25, Tray 2=0, Total=25, Auto-duplex unit=0
Country/Region: USA
HP#(21)
URL: <http://hp.com>

Ink Cartridge Status

Color	Black	Yellow	Magenta	Cyan
Ink cartridge level*				
Part number	HP 940	HP 940	HP 940	HP 940
Expiration date (Y-M-D)	2012-09-16	INTRODUCTORY 2012-09-16	INTRODUCTORY 2012-09-16	INTRODUCTORY 2012-09-16
IK	*Estimates only. Actual ink levels may vary.			
Supported Ink Cartridges	103			
Black	-HP 940XL, HP 940			
Yellow, Magenta, Cyan	-HP 940XL, HP 940			

*Cartridge numbers may differ in some countries/regions.
*Not all cartridges are available in all regions.

Printhead Status

Color	Black/Yellow	Magenta/Cyan
Print Head Health	Good	Good
Part number	HP 940 (C4900A)	HP 940 (C4901A)
Sense #	5180079	5180042
End of warranty date (Y-M-D)	2011-07-16	2011-07-16
Accumulated ink usage (ml)	Black 15/Yellow 4	Magenta 3/Cyan 4

1. **Printer Information:** Shows printer information (such as the printer name, model number, serial number, and firmware version number), the accessories that are installed (such as the duplexer), and the number of pages printed from the trays and accessories.
2. **Ink Cartridge Status:** Shows the estimated ink levels (represented in graphical form as gauges) and the part numbers and expiration dates of the ink cartridges.



NOTE: Ink level warnings and indicators provide estimates for planning purposes only. When you receive a low-ink warning message, consider having a replacement cartridge available to avoid possible printing delays. You do not need to replace cartridges until prompted to do so.

3. **Printhead Status:** Shows the status of the printhead health and the part numbers, first-installation dates, and end-of-warranty dates of the printheads, as well as the accumulated ink usage. The status options for the printhead are: good, fair, and replace. If the status is “fair,” then the print quality must be monitored, but the printhead does not need to be replaced. If the status is “replace,” then the printhead must be replaced.

To print the Self Test Diagnostic Page

From the Home screen, touch right arrow , and then select **Setup**. Touch **Reports**, and then select **Printer Status Report**.

Understand the network configuration page

If the printer is connected to a network, you can print a network configuration page to view the network settings for the printer. You can use the network configuration page

to help troubleshoot network connectivity problems. If you need to call HP, it is often useful to print this page before calling.

HP Network Configuration Page		
1	General Information	
	Network Status	Offline
	Active Connection Type	None
	URL(s) for Embedded Web Server	http://10.0.0.0
	Firmware Revision	Rev. 01.0000000
	Hostname	HP-1000
	Serial Number	BY100012345678
Admin Password	None Set	
2	802.3 Wired	
	Hardware Address (MAC)	08:00:27:00:00:00
3	802.11 Wireless	
	Hardware Address (MAC)	08:00:27:00:00:00
	Status	Disconnected
4	Communication Mode	Ad-hoc
	Network Name (SSID)	HP-100000000000
	Port 9100	
	Status	Enabled
4	mDNS	
	Status	Enabled
4	Service Name	HP-100000000000
	LPP	
5	Microsoft Web Services	
	Web Discovery	Enabled
	Web Print	Enabled

- 1. General Information:** Shows information about the current status and active connection type of the network, and other information, such as the URL of the embedded Web server.
- 2. 802.3 Wired:** Shows information about the active wired network connection, such as the IP address, subnet mask, default gateway, as well as the hardware address of the printer.
- 3. 802.11 Wireless (some models):** Shows information about your wireless network connection, such as the hostname, IP address, subnet mask, default gateway, and server.
- 4. Miscellaneous:** Shows information about more advanced network settings.
 - Port 9100:** The printer supports raw IP printing through TCP Port 9100. This HP-proprietary TCP/IP port on the printer is the default port for printing. It is accessed by HP software (for example, the HP Standard Port).
 - LPD:** Line Printer Daemon (LPD) refers to the protocol and programs associated with line-printer spooling services that may be installed on various TCP/IP systems.



NOTE: The LPD functionality can be used with any host implementation of LPD that complies with the RFC 1179 document. The process for configuring printer spoolers, however, might differ. See your system documentation for information about configuring these systems.

- **Bonjour:** Bonjour services (which use mDNS, or Multicast Domain Name System) are typically used on small networks for IP address and name resolution (through UDP port 5353), where a conventional DNS server is not used.
- **SLP:** Service Location Protocol (SLP) is an Internet standard network protocol that provides a framework to allow networking applications to discover the existence, location, and configuration of networked services in enterprise networks. This protocol simplifies discovery and use of network resources such as printers, Web servers, fax machines, video cameras, files systems, backup devices (tape drives), databases, directories, mail servers, calendars.
- **Microsoft Web Services:** Enable or disable the Microsoft Web Services Dynamic Discovery (WS Discovery) protocols or Microsoft Web Services for Devices (WSD) Print services supported on the printer. Disable unused print services to prevent access through those services.

 **NOTE:** For more information about WS Discovery and WSD Print, visit www.microsoft.com.

- **SNMP:** SNMP (Simple Network Management Protocol) is used by network management applications for device management. The printer supports SNMPv1 protocol on IP networks.
 - **WINS:** If you have a Dynamic Host Configuration Protocol (DHCP) server on your network, the printer automatically obtains its IP address from that server and registers its name with any RFC 1001 and 1002-compliant dynamic name services as long as a WINS server IP address has been specified.
- 5. Connected PC(s):** Lists the computers connected to this printer, as well as the last time these computers accessed the printer.

To print the network configuration page from the printer control panel

From the Home screen, touch right arrow , and then select **Setup**. Touch **Reports**, and then select **Network Configuration Page**.

Clear jams

Occasionally, media becomes jammed during a job. Try the following remedies before you attempt to clear the jam.

- Make sure that you are printing with media that meets specifications. For more information, see [Media specifications](#).
- Make sure that you are printing with media that is not wrinkled, folded, or damaged.
- Make sure that the printer is clean. For more information, see [Maintain the printer](#).
- Make sure that the trays are loaded correctly and are not too full. For more information, see [Load media](#).

This section contains the following topics:

- [Clear paper jams](#)
- [Avoid paper jams](#)

Clear paper jams

If the paper was loaded in the input tray, you might need to clear the paper jam from the duplexer.

Paper can also jam in the automatic document feeder. Several common actions can cause paper to jam the automatic document feeder:

- Placing too much paper in the document feeder tray. For information on the maximum number of sheets allowed in the automatic document feeder, see [Media specifications](#).
- Using paper that is too thick or too thin for the printer.
- Trying to add paper to the document feeder tray while the printer is feeding pages.

To clear a jam

Use these steps to clear a paper jam.

1. Remove all media from the output tray.

△ **CAUTION:** Trying to clear a paper jam from the front of the printer can damage the print mechanism. Always access and clear paper jams through the duplexer.

2. Check the duplexer.

- a. Push the button on either side of the duplexer, and then remove the panel or unit.

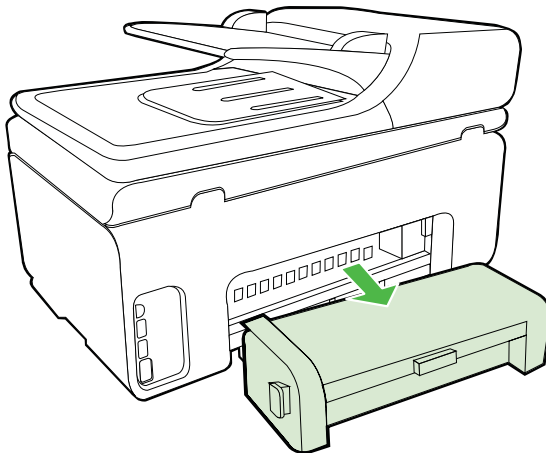

- b. Locate any jammed media inside the printer, grasp it with both hands and then pull it towards you.

- c. If the jam is not there, push the latch on the top of the duplexer and lower its cover. If the jam is inside, carefully remove it. Close the cover.

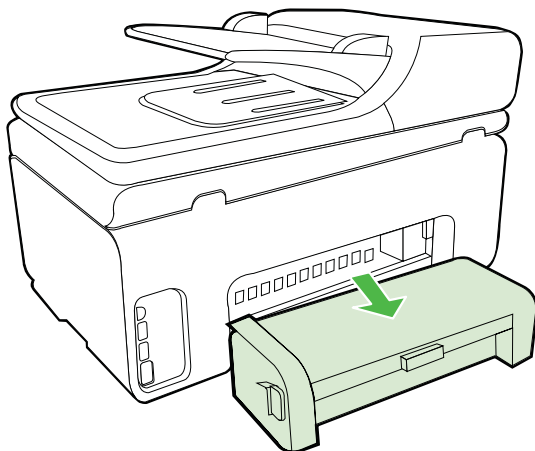

- d. Reinsert the duplexer into the printer.
3. Open the top cover and remove any debris.
 4. If you have not found the jam and have Tray 2 installed, pull out the tray and remove the jammed media, if possible. If not, do the following:
 - a. Ensure the printer is turned off and disconnect the power cord.
 - b. Lift the printer off Tray 2.
 - c. Remove the jammed media from the bottom of the printer or from Tray 2.
 - d. Reposition the printer on top of Tray 2.
 5. Open the print carriage access door. If there is paper remaining inside the printer, ensure the carriage has moved to the right of the printer, free any paper scraps or wrinkled media, and pull the media towards you through the top of the printer.

⚠ WARNING! Do not reach into the printer when it is on and the carriage is stuck. When you open the print carriage access door, the carriage should return to its position on the right side of the printer. If it does not move to the right, turn off the printer before you remove any jam.

6. After clearing the jam, close all covers, turn on the printer (if you turned it off) and resend the print job.

To clear a paper jam in the automatic document feeder

1. Lift the cover of the automatic document feeder.

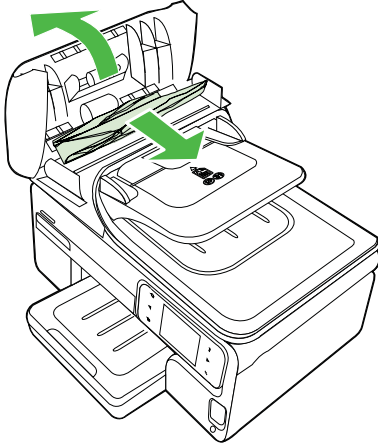

2. Gently pull the paper out of the rollers.

△ **CAUTION:** If the paper tears when you are removing it from the rollers, check the rollers and wheels for torn pieces of paper that might remain inside the printer. If you do not remove all the pieces of paper from the printer, more paper jams are likely to occur.

3. Close the cover of the automatic document feeder.

Avoid paper jams

To help avoid paper jams, follow these guidelines.

- Remove printed papers from the output tray frequently.
- Prevent curled or wrinkled paper by storing all unused paper flat in a resealable bag.
- Ensure that paper loaded in the input tray lays flat and the edges are not bent or torn.
- Do not combine different paper types and paper sizes in the input tray; the entire stack of paper in the input tray must be the same size and type.
- Adjust the paper-width guide in the input tray to fit snugly against all paper. Make sure the paper-width guide does not bend the paper in the input tray.
- Do not force paper too far forward in the input tray.
- Use paper types that are recommended for the printer. For more information, see [Media specifications](#).

A Technical information

This section contains the following topics:

- [Warranty information](#)
- [Printer specifications](#)
- [Regulatory information](#)
- [Environmental product stewardship program](#)
- [Third-party licenses](#)

Warranty information

This section contains the following topics:

- [Hewlett-Packard limited warranty statement](#)
- [Ink cartridge warranty information](#)

Hewlett-Packard limited warranty statement

HP product	Duration of limited warranty
Software Media	90 days
Printer	1 year
Print or Ink cartridges	Until the HP ink is depleted or the "end of warranty" date printed on the cartridge has been reached, whichever occurs first. This warranty does not cover HP ink products that have been refilled, remanufactured, refurbished, misused, or tampered with.
Printheads (only applies to products with customer replaceable printheads)	1 year
Accessories	1 year unless otherwise stated

A. Extent of limited warranty

- Hewlett-Packard (HP) warrants to the end-user customer that the HP products specified above will be free from defects in materials and workmanship for the duration specified above, which duration begins on the date of purchase by the customer.
- For software products, HP's limited warranty applies only to a failure to execute programming instructions. HP does not warrant that the operation of any product will be interrupted or error free.
- HP's limited warranty covers only those defects that arise as a result of normal use of the product, and does not cover any other problems, including those that arise as a result of:
 - Improper maintenance or modification;
 - Software, media, parts, or supplies not provided or supported by HP;
 - Operation outside the product's specifications;
 - Unauthorized modification or misuse.
- For HP printer products, the use of a non-HP cartridge or a refilled cartridge does not affect either the warranty to the customer or any HP support contract with the customer. However, if printer failure or damage is attributable to the use of a non-HP or refilled cartridge or an expired ink cartridge, HP will charge its standard time and materials charges to service the printer for the particular failure or damage.
- If HP receives, during the applicable warranty period, notice of a defect in any product which is covered by HP's warranty, HP shall either repair or replace the product, at HP's option.
- If HP is unable to repair or replace, as applicable, a defective product which is covered by HP's warranty, HP shall, within a reasonable time after being notified of the defect, refund the purchase price for the product.
- HP shall have no obligation to repair, replace, or refund until the customer returns the defective product to HP.
- Any replacement product may be either new or like-new, provided that it has functionality at least equal to that of the product being replaced.
- HP products may contain remanufactured parts, components, or materials equivalent to new in performance.
- HP's Limited Warranty Statement is valid in any country where the covered HP product is distributed by HP. Contracts for additional warranty services, such as on-site service, may be available from any authorized HP service facility in countries where the product is distributed by HP or by an authorized importer.

B. Limitations of warranty

TO THE EXTENT ALLOWED BY LOCAL LAW, NEITHER HP NOR ITS THIRD PARTY SUPPLIERS MAKES ANY OTHER WARRANTY OR CONDITION OF ANY KIND, WHETHER EXPRESS OR IMPLIED WARRANTIES OR CONDITIONS OF MERCHANTABILITY, SATISFACTORY QUALITY, AND FITNESS FOR A PARTICULAR PURPOSE.

C. Limitations of liability

- To the extent allowed by local law, the remedies provided in this Warranty Statement are the customer's sole and exclusive remedies.
- TO THE EXTENT ALLOWED BY LOCAL LAW, EXCEPT FOR THE OBLIGATIONS SPECIFICALLY SET FORTH IN THIS WARRANTY STATEMENT, IN NO EVENT SHALL HP OR ITS THIRD PARTY SUPPLIERS BE LIABLE FOR DIRECT, INDIRECT, SPECIAL, INCIDENTAL, OR CONSEQUENTIAL DAMAGES, WHETHER BASED ON CONTRACT, TORT, OR ANY OTHER LEGAL THEORY AND WHETHER ADVISED OF THE POSSIBILITY OF SUCH DAMAGES.

D. Local law

- This Warranty Statement gives the customer specific legal rights. The customer may also have other rights which vary from state to state in the United States, from province to province in Canada, and from country to country elsewhere in the world.
- To the extent that this Warranty Statement is inconsistent with local law, this Warranty Statement shall be deemed modified to be consistent with such local law. Under such local law, certain disclaimers and limitations of this Warranty Statement may not apply to the customer. For example, some states in the United States, as well as some governments outside the United States (including provinces in Canada), may:
 - Preclude the disclaimers and limitations in this Warranty Statement from limiting the statutory rights of a consumer (e.g., the United Kingdom);
 - Otherwise restrict the ability of a manufacturer to enforce such disclaimers or limitations; or
 - Grant the customer additional warranty rights, specify the duration of implied warranties which the manufacturer cannot disclaim, or allow limitations on the duration of implied warranties.
- THE TERMS IN THIS WARRANTY STATEMENT, EXCEPT TO THE EXTENT LAWFULLY PERMITTED, DO NOT EXCLUDE, RESTRICT, OR MODIFY, AND ARE IN ADDITION TO, THE MANDATORY STATUTORY RIGHTS APPLICABLE TO THE SALE OF THE HP PRODUCTS TO SUCH CUSTOMERS.

HP Limited Warranty

Dear Customer,

You will find below the name and address of the HP entity responsible for the performance of the HP Limited Warranty in your country.

You may have additional statutory rights against the seller based on your purchase agreement. Those rights are not in any way affected by this HP Limited Warranty.

Ireland: Hewlett-Packard Ireland Limited, 63-74 Sir John Rogerson's Quay, Dublin 2

United Kingdom: Hewlett-Packard Ltd, Cain Road, Bracknell, GB-Berks RG12 1HN

Malta: Hewlett Packard International Trade BV, Branch 48, Sqaq Nru 2, Triq ix-Xatt, Pieta MSD08, Malta

South Africa: Hewlett-Packard South Africa Ltd, 12 Autumn Street, Rivonia, Sandton, 2128, Republic of South Africa

Ink cartridge warranty information

The HP cartridge warranty is applicable when the product is used in its designated HP printing device. This warranty does not cover HP ink products that have been refilled, remanufactured, refurbished, misused, or tampered with.

During the warranty period the product is covered as long as the HP ink is not depleted and the end of warranty date has not been reached. The end of warranty date, in YYYY-MM format, may be found on the product as indicated:

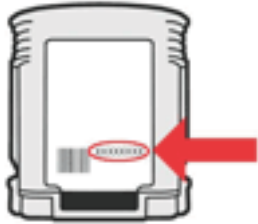

Printer specifications

This section contains the following topics:

- [Physical specifications](#)
- [Product features and capacities](#)
- [Processor and memory specifications](#)
- [System requirements](#)
- [Network protocol specifications](#)
- [Embedded Web server specifications](#)
- [Media specifications](#)
- [Print specifications](#)
- [Copy specifications](#)
- [Fax specifications](#)
- [Scan specifications](#)
- [HP Web site specifications](#)
- [Environmental specifications](#)
- [Electrical specifications](#)
- [Acoustic emission specifications](#)
- [Memory device specifications](#)

Physical specifications



NOTE: To find your model number, see [Finding the printer model number](#).

Size (width x height x depth)

HP OfficeJet Pro 8500A (A910a-f): 502 x 283 x 472 mm (19.8 x 11.1 x 18.6 inches)

HP OfficeJet Pro 8500A (A910g-z): 502 x 306 x 472 mm (19.8 x 12.1 x 18.6 inches)

With Tray 2: Adds 67 mm (2.6 inches) to the height of the printer.

Printer weight (does not include printing supplies)

HP OfficeJet Pro 8500A (A910a-f) 11.5 kg (25.4 lb)

HP OfficeJet Pro 8500A (A910g-z): 12.3 kg (27.1 lb)

With Tray 2: Adds 2.7 kg (6.0 lb)

Product features and capacities

Feature	Capacity
Connectivity	<ul style="list-style-type: none">• USB 2.0-compliant high speed• USB host connector is only supported up to full speed.• Wireless 802.11b/g/n• Wired network
Print method	Drop-on-demand thermal inkjet printing
Ink cartridges	Four ink cartridges (one each for black, cyan, magenta, and yellow) NOTE: Not all ink cartridges are supported in all countries/regions.

(continued)

Feature	Capacity
Printheads	Two printheads (one black and yellow, and one magenta and cyan)
Supply yields	Visit www.hp.com/go/learnaboutsupplies/ for more information on estimated ink cartridge yields.
Printer languages	HP PCL 3
Font support	US fonts: CG Times, CG Times Italic, Universe, Universe Italic, Courier, Courier Italic, Letter Gothic, Letter Gothic Italic.
Duty cycle	Up to 15,000 pages per month
Printer control-panel language support Language availability varies by country/region.	Bulgarian, Croatian, Czech, Danish, Dutch, English, Finnish, French, German, Greek, Hungarian, Italian, Japanese, Korean, Norwegian, Polish, Portuguese, Romanian, Russian, Simplified Chinese, Slovak, Slovenian, Spanish, Swedish, Traditional Chinese, Turkish.

Processor and memory specifications

Printer processor

ARM R4

Printer memory

HP OfficeJet Pro 8500A (A910a-f): 64 MB built-in RAM

HP OfficeJet Pro 8500A (A910g-z): 128 MB built-in RAM

System requirements



NOTE: For the most current information about supported operating systems and system requirements, visit <http://www.hp.com/support/>.

Operating system compatibility

- Windows XP Service Pack 2, Windows Vista, Windows 7
- Mac OS X v10.5, v10.6
- Linux (For more information, see <http://hplipopensource.com/hplip-web/index.html>)

Minimum system requirements

- Microsoft Windows 7: 1 GHz 32-bit (x86) or 64-bit (x64) processor; 1 GB (32-bit) or 2 GB (64-bit) RAM, 1.5 GB hard disk space, CD-ROM/DVD drive or Internet connection, USB port
- Microsoft Windows Vista: 800 MHz 32-bit (x86) or 64-bit (x64) processor; 512 MB RAM, 2.0 GB hard disk space, CD-ROM/DVD drive or Internet connection, USB port
- Microsoft Windows XP (32-bit) Service Pack 2: Intel® Pentium® II, Celeron® or compatible processor; 233 MHz or higher; 128 MB RAM, 750 MB hard disk space, CD-ROM/DVD drive or Internet connection, USB port
- Mac OS X v10.5.8, v10.6: PowerPC G4, G5, or Intel Core processor, 300 MB free hard disk space

Network protocol specifications

Network operating system compatibility

- Windows XP (32-bit) (Professional and Home Editions), Windows Vista 32-bit and 64-bit (Ultimate Edition, Enterprise Edition and Business Edition), Windows 7 (32-bit and 64-bit)
- Windows Small Business Server 2003 32-bit and 64-bit, Windows 2003 Server 32-bit and 64-bit, Windows 2003 Server R2 32-bit and 64-bit (Standard Edition, Enterprise Edition)
- Windows Small Business Server 2008 64-bit, Windows 2008 Server 32-bit and 64-bit, Windows 2008 Server R2 64-bit (Standard Edition, Enterprise Edition)
- Citrix XenDesktop 4
- Citrix XenServer 5.5
- Mac OS X v.10.5, v10.6
- Microsoft Windows 2003 Server Terminal Services
- Microsoft Windows 2003 Server Terminal Services with Citrix Presentation Server 4.0
- Microsoft Windows 2003 Server Terminal Services with Citrix Presentation Server 4.5
- Microsoft Windows 2003 Server Terminal Services with Citrix XenApp 5.0
- Microsoft Windows 2003 Server Terminal Services with Citrix Metaframe XP with Feature Release 3
- Microsoft Windows 2003 Small Business Server Terminal Services
- Microsoft Windows Server 2008 Terminal Services
- Microsoft Windows Small Business Server 2008 Terminal Services
- Microsoft Windows 2008 Server Terminal Services with Citrix XenApp 5.0
- Novell Netware 6.5, Open Enterprise Server 2

Compatible network protocols

TCP/IP

Network management

Embedded Web server (Ability to remotely configure and manage network printers)

Embedded Web server specifications

Requirements

- A TCP/IP-based network (IPX/SPX-based networks are not supported)
- A Web browser (either Microsoft Internet Explorer 7.0 or higher, Opera 8.0 or higher, Mozilla Firefox 2.0 or higher, Safari 3.0 or higher, or Google Chrome 3.0 or higher)
- A network connection (you cannot use the embedded Web server connected directly to a computer with a USB cable)
- An Internet connection (required for some features)



NOTE: You can open the embedded Web server without being connected to the Internet. However, some features are not available.

NOTE: The embedded Web server must be on the same side of a firewall as the printer.

Media specifications

Use these tables to determine the correct media to use with your printer, and determine what features work with your media.

- [Understand specifications for supported media](#)
- [Set minimum margins](#)
- [Guidelines for printing on both sides of a page](#)

Understand specifications for supported media

Use the tables to determine the correct media to use with your printer, and to determine what features work with your media.

- [Understand supported sizes](#)
- [Understand supported media types and weights](#)

Understand supported sizes

 **NOTE:** Tray 2 is available with some models.

Media size	Tray 1	Tray 2	Duplexer	ADF
Standard media sizes				
U.S. Letter (216 x 279 mm; 8.5 x 11 inches)	✓	✓	✓	✓
8.5 x 13 inches (216 x 330 mm)*	✓	✓		
U.S. Legal (216 x 356 mm; 8.5 x 14 inches)	✓	✓		✓
A4 (210 x 297 mm; 8.3 x 11.7 inches)*	✓	✓	✓	✓
U.S. Executive (184 x 267 mm; 7.25 x 10.5 inches)	✓	✓	✓	✓
U.S. Statement (140 x 216 mm; 5.5 x 8.5 inches)	✓			
B5 (JIS) (182 x 257 mm; 7.17 x 10.12 inches)*	✓	✓	✓	✓
A5 (148 x 210 mm; 5.8 x 8.3 inches)*	✓		✓	
6 x 8 inches	✓		✓	
Envelopes				
U.S. #10 Envelope (105 x 241 mm; 4.12 x 9.5 inches)	✓			
Monarch Envelope (98 x 191 mm; 3.88 x 7.5 inches)	✓			
Card Envelope (111 x 152 mm; 4.4 x 6 inches)	✓			
A2 Envelope (111 x 146 mm; 4.37 x 5.75 inches)	✓			
DL Envelope (110 x 220 mm; 4.3 x 8.7 inches)	✓			
C5 Envelope (162 x 229 mm; 6.4 x 9 inches)	✓			

(continued)

Media size	Tray 1	Tray 2	Duplexer	ADF
C6 Envelope (114 x 162 mm; 4.5 x 6.4 inches)	✓			
Japanese Envelope Chou #3 (120 x 235 mm; 4.7 x 9.3 inches)	✓			
Japanese Envelope Chou #4 (90 x 205 mm; 3.5 x 8.1 inches)	✓			
Cards				
Index card (76.2 x 127 mm; 3 x 5 inches)	✓			
Index card (102 x 152 mm; 4 x 6 inches)	✓		✓	
Index card (127 x 203 mm; 5 x 8 inches)	✓		✓	
A6 card (105 x 148.5 mm; 4.13 x 5.83 inches)*	✓		✓	
A4 index card (210 x 297 mm; 8.3 x 11.7 inches)	✓		✓	
Hagaki** (100 x 148 mm; 3.9 x 5.8 inches)*	✓			
Ofuku Hagaki** (200 x 148 mm; 7.8 x 5.8 inches)	✓			
Photo media				
Photo media (76.2 x 127 mm; 3 x 5 inches)	✓			
Photo media (102 x 152 mm; 4 x 6 inches)*	✓			
Photo media (5 x 7 inches)*	✓			
Photo media (8 x 10 inches)*	✓			
Photo media (8.5 x 11 inches)*	✓			
Photo L (89 x 127 mm; 3.5 x 5 inches)*	✓			
Photo 2L (127 x 178 mm)*	✓			
13 x 18 cm*	✓			
Other media				
Custom-sized media between 76.2 to 216 mm wide and 127 to	✓			

(continued)

Media size	Tray 1	Tray 2	Duplexer	ADF
356 mm long (3 to 8.5 inches wide and 5 to 14 inches long)				
Custom-sized media (ADF) between 127 to 216 mm wide and 241 to 305 mm long (5 to 8.5 inches wide and 9.5 to 12 inches long)				✓

* These sizes can be used for borderless printing.

** The printer is compatible with plain and inkjet hagaki from Japan Post only. It is not compatible with photo hagaki from Japan Post.

Understand supported media types and weights

 **NOTE:** Tray 2 is available with some models.

Tray	Type	Weight	Capacity
Tray 1	Paper	60 to 105 g/m ² (16 to 28 lb bond)	Up to 250 sheets of plain paper (25 mm or 1 inch stacked)
	Transparencies		Up to 70 sheets (17 mm or 0.67 inch stacked)
	Photo media	250 g/m ² (66 lb bond)	Up to 100 sheets (17 mm or 0.67 inch stacked)
	Labels		Up to 100 sheets (17 mm or 0.67 inch stacked)
	Envelopes	75 to 90 g/m ² (20 to 24 lb bond envelope)	Up to 30 sheets (17 mm or 0.67 inch stacked)
	Cards	Up to 200 g/m ² (110 lb index)	Up to 80 cards
Tray 2	Plain paper only	60 to 105 g/m ² (16 to 28 lb bond)	Up to 250 sheets of plain paper (25 mm or 1.0 inch stacked)
Duplexer	Paper	60 to 105 g/m ² (16 to 28 lb bond)	Not applicable
Output-bin	All supported media		Up to 150 sheets of plain paper (text printing)

(continued)

Tray	Type	Weight	Capacity
Automatic Document Feeder	Paper	60 to 75 g/m ² (16 to 20 lb bond)	50 sheets

Set minimum margins

The document margins must match (or exceed) these margin settings in portrait orientation.

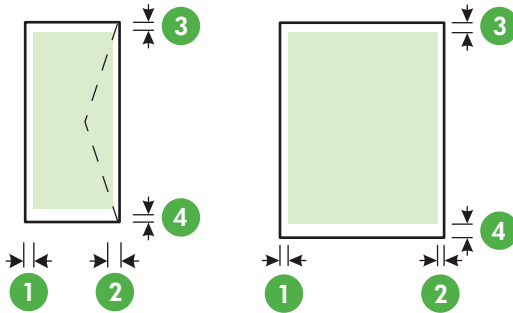

Media	(1) Left margin	(2) Right margin	(3) Top margin	(4) Bottom margin
U.S. Letter	3.3 mm (0.13 inch)	3.3 mm (0.13 inch)	3.3 mm (0.13 inch)	3.3 mm (0.13 inch (Windows) 0.47 inch (Macintosh and Linux))
U.S. Legal				
A4				
U.S. Executive				
U.S. Statement				
8.5 x 13 inch				
B5				
A5				
Cards				
Custom-sized media				
Photo media				
Envelopes	3.3 mm (0.13 inch)	3.3 mm (0.13 inch)	16.5 mm (0.65 inch)	16.5 mm (0.65 inch)

 **NOTE:** If you are using the duplexer, the minimum top and bottom margins must be at least 12 mm (0.47 inch).

Guidelines for printing on both sides of a page

- Always use media that conforms to the printer specifications. For more information, see [Media specifications](#).
- Specify two-sided printing options in your application or in the printer driver.
- Do not print on both sides of transparencies, envelopes, photo paper, glossy media, or paper lighter than 16 lb bond (60 g/m²) or heavier than 28 lb bond (105 g/m²). Jams might occur with these media types.

- Several kinds of media require a specific orientation when you print on both sides of a page. These include letterhead, preprinted paper, and paper with watermarks and prepunched holes. When you print from a computer running Windows, the printer prints the first side of the media first. Load the media with the print side facing down.
- For auto-duplexing, when printing finishes on one side of the media, the printer holds the media and pauses while the ink dries. Once the ink dries, the media is pulled back into the printer and the second side is printed. When printing is complete, the media is dropped onto the output tray. Do not grab it before printing is complete.
- You can print on both sides of supported custom-sized media by turning the media over and feeding it into the printer again. For more information, see [Media specifications](#).

Print specifications

Black print resolution

Up to 1200 dpi with pigmented black ink

Color print resolution

HP enhanced photo quality with Viverna inks (up to 4800 by 1200 dpi Optimized on HP Premium Plus photo papers with 1200 x 1200 input dpi)

Copy specifications

- Digital image processing
- Up to 99 copies from original (varies by model)
- Digital zoom: from 25 to 400% (varies by model)
- Fit to page, copy preview

Fax specifications

- Walk-up black-and-white and color fax capability.
- Up to 110 speed dials (varies by model).
- Up to 120-page memory (varies by model, based on ITU-T Test Image #1 at standard resolution). More complicated pages or higher resolution takes longer and uses more memory.
- Manual fax send and receive.
- Automatic busy redial up to five times (varies by model).
- Automatic no-answer redial one time (varies by model).
- Confirmation and activity reports.
- CCITT/ITU Group 3 fax with Error Correction Mode.
- 33.6 Kbps transmission.
- 3 seconds per page speed at 33.6 Kbps (based on ITU-T Test Image #1 at standard resolution). More complicated pages or higher resolution takes longer and uses more memory.
- Ring detect with automatic fax/answering machine switching.

	Photo (dpi)	Very Fine (dpi)	Fine (dpi)	Standard (dpi)
Black	196 x 203 (8-bit grayscale)	300 x 300	196 x 203	196 x 98
Color	200 x 200	200 x 200	200 x 200	200 x 200

Fax to PC Specifications

- Supported file type: Uncompressed TIFF
- Supported fax types: black-and-white faxes

Scan specifications

- Integrated OCR software automatically converts scanned text to editable text
- Twain-compliant interface
- Resolution: 4800 x 4800 ppi optical
- Color: 24-bit color, 8-bit grayscale (256 levels of gray)
- Maximum scan size from glass:
HP Officejet Pro 8500A (A910a-f): 216 x 297 mm (8.5 x 11.7 inches)
HP Officejet Pro 8500A (A910g-z): 216 x 356 mm (8.5 x 14 inches)



NOTE: To find your model number, see [Finding the printer model number](#).

- Maximum scan size from ADF: 216 x 356 mm (8.5 x 14 inches)

HP Web site specifications

The following Web-enabled features are available for this printer:

- [HP Apps](#)
- [Marketsplash by HP](#)
- [HP ePrint](#)

Requirements

- A Web browser (either Microsoft Internet Explorer 6.0 or higher, Mozilla Firefox 2.0 or higher, Safari 3.2.3 or higher, or Google Chrome 3.0) with the Adobe Flash plug-in (version 10 or higher).
- An Internet connection

Environmental specifications

Operating environment

Operating temperature: 5° to 40° C (41° to 104° F)

Recommended operating conditions: 15° to 32° C (59° to 90° F)

Recommended relative humidity: 25 to 75% noncondensing

Storage environment

Storage temperature: -40° to 60° C (-40° to 140° F)

Storage relative humidity: Up to 90% noncondensing at a temperature of 60° C (140° F)

Electrical specifications

Power supply

Universal power adapter (external)

Power requirements

Input voltage: 100 to 240 VAC ($\pm 10\%$), 50/60 Hz ($\pm 3\text{Hz}$)

Output voltage: 32 Vdc at 2000 mA

Power consumption

30 watts printing (Fast Draft Mode); 32 watts copying (Fast Draft Mode)

Acoustic emission specifications

Print in Draft mode, noise levels per ISO 7779

HP Officejet Pro 8500A (A910a-f)

- Sound pressure (bystander position)
LpAm 57 (dBA) (mono Draft print)
- Sound power
LwAd 7.1 (BA)

HP Officejet Pro 8500A (A910g-z)

- Sound pressure (bystander position)
LpAm 56 (dBA) (mono Draft print)
- Sound power
LwAd 7.0 (BA)

Memory device specifications

This section contains the following topics:

- [Memory card specifications](#)
- [USB flash drives](#)

Memory card specifications

Specifications

- Maximum recommended number of files on a memory card: 1,000
- Maximum recommended individual file size: 12 megapixel maximum, 8 MB maximum
- Maximum recommended memory card size: 1 GB (solid state only)



NOTE: Approaching any of the recommended maximums on a memory card might cause the performance of the printer to be slower than expected.

Supported memory card types

- Secure Digital
- High Capacity Secure Digital
- Memory Stick
- MultiMediaCard (MMC)
- xD-Picture Card

USB flash drives

USB flash drives

HP has fully tested the following USB flash drives with the printer:

- **SanDisk Cruzer Micro:** High-speed, 0120-256, 256 MB
- **Iomega Micro Mini:** Full-speed, 064-0417450-YCAE032171, 128 MB
- **Kingston DataTraveler II:** High-speed, KF112504 f5274-006, 128 MB and 256 MB
- **Lexar Media JumpDrive:** 256 MB



NOTE: You might be able to use other USB flash drives with the printer. However, HP cannot guarantee that they correct functionality with the printer because they have not been fully tested.

Regulatory information

The printer meets product requirements from regulatory agencies in your country/region.

This section contains the following topics:

- [FCC statement](#)
- [Notice to users in Korea](#)
- [VCCI \(Class B\) compliance statement for users in Japan](#)
- [Notice to users in Japan about the power cord](#)
- [Noise emission statement for Germany](#)
- [LED indicator statement](#)
- [Gloss of housing of peripheral devices for Germany](#)
- [Notice to users of the U.S. telephone network: FCC requirements](#)
- [Notice to users of the Canadian telephone network](#)
- [Notice to users in the European Economic Area](#)
- [Notice to users of the German telephone network](#)
- [Australia wired fax statement](#)
- [Regulatory information for wireless products](#)
- [Regulatory model number](#)
- [Declaration of conformity](#)

FCC statement

FCC statement

The United States Federal Communications Commission (in 47 CFR 15.105) has specified that the following notice be brought to the attention of users of this product.

This equipment has been tested and found to comply with the limits for a Class B digital device, pursuant to Part 15 of the FCC Rules. These limits are designed to provide reasonable protection against harmful interference in a residential installation. This equipment generates, uses and can radiate radio frequency energy and, if not installed and used in accordance with the instructions, may cause harmful interference to radio communications. However, there is no guarantee that interference will not occur in a particular installation. If this equipment does cause harmful interference to radio or television reception, which can be determined by turning the equipment off and on, the user is encouraged to try to correct the interference by one or more of the following measures:

- Reorient the receiving antenna.
- Increase the separation between the equipment and the receiver.
- Connect the equipment into an outlet on a circuit different from that to which the receiver is connected.
- Consult the dealer or an experienced radio/TV technician for help.

For further information, contact:

Manager of Corporate Product Regulations
Hewlett-Packard Company
3000 Hanover Street
Palo Alto, Ca 94304
(650) 857-1501

Modifications (part 15.21)

The FCC requires the user to be notified that any changes or modifications made to this device that are not expressly approved by HP may void the user's authority to operate the equipment.

This device complies with Part 15 of the FCC Rules. Operation is subject to the following two conditions: (1) this device may not cause harmful interference, and (2) this device must accept any interference received, including interference that may cause undesired operation.

Notice to users in Korea

사용자 안내문(B급 기기)

이 기기는 비업무용으로 전자파 적합 등록을 받은 기기로서, 주거지역에서는 물론 모든 지역에서 사용할 수 있습니다.

VCCI (Class B) compliance statement for users in Japan

この装置は、クラスB情報技術装置です。この装置は、家庭環境で使用することを目的としていますが、この装置がラジオやテレビジョン受信機に近接して使用されると、受信障害を引き起こすことがあります。取扱説明書に従って正しい取り扱いをして下さい。

VCCI-B

Notice to users in Japan about the power cord

製品には、同梱された電源コードをお使い下さい。
同梱された電源コードは、他の製品では使用出来ません。

Noise emission statement for Germany

Geräuschemission

LpA < 70 dB am Arbeitsplatz im Normalbetrieb nach DIN 45635 T. 19

LED indicator statement

LED indicator statement

The display LEDs meet the requirements of EN 60825-1.

Gloss of housing of peripheral devices for Germany

Das Gerät ist nicht für die Benutzung im unmittelbaren Gesichtsfeld am Bildschirmarbeitsplatz vorgesehen. Um störende Reflexionen am Bildschirmarbeitsplatz zu vermeiden, darf dieses Produkt nicht im unmittelbaren Gesichtsfeld platziert werden.

Notice to users of the U.S. telephone network: FCC requirements

Notice to users of the U.S. telephone network: FCC requirements

This equipment complies with FCC rules, Part 68. On this equipment is a label that contains, among other information, the FCC Registration Number and Ringer Equivalent Number (REN) for this equipment. If requested, provide this information to your telephone company.

An FCC compliant telephone cord and modular plug is provided with this equipment. This equipment is designed to be connected to the telephone network or premises wiring using a compatible modular jack which is Part 68 compliant. This equipment connects to the telephone network through the following standard network interface jack: USOC RJ-11C.

The REN is useful to determine the quantity of devices you may connect to your telephone line and still have all of those devices ring when your number is called. Too many devices on one line might result in failure to ring in response to an incoming call. In most, but not all, areas the sum of the RENs of all devices should not exceed five (5). To be certain of the number of devices you may connect to your line, as determined by the REN, you should call your local telephone company to determine the maximum REN for your calling area.

If this equipment causes harm to the telephone network, your telephone company might discontinue your service temporarily. If possible, they will notify you in advance. If advance notice is not practical, you will be notified as soon as possible. You will also be advised of your right to file a complaint with the FCC. Your telephone company might make changes in its facilities, equipment, operations, or procedures that could affect the proper operation of your equipment. If they do, you will be given advance notice so you will have the opportunity to maintain uninterrupted service. If you experience trouble with this equipment, please contact the manufacturer, or look elsewhere in this manual, for warranty or repair information. Your telephone company might ask you to disconnect this equipment from the network until the problem has been corrected or until you are sure that the equipment is not malfunctioning.

This equipment may not be used on coin service provided by the telephone company.

Connection to party lines is subject to state tariffs. Contact your state public utility commission, public service commission, or corporation commission for more information.

This equipment includes automatic dialing capability. When programming and/or making test calls to emergency numbers:

- Remain on the line and explain to the dispatcher the reason for the call.
- Perform such activities in the off-peak hours, such as early morning or late evening.



Note The FCC hearing aid compatibility rules for telephones are not applicable to this equipment.

The Telephone Consumer Protection Act of 1991 makes it unlawful for any person to use a computer or other electronic device, including fax machines, to send any message unless such message clearly contains in a margin at the top or bottom of each transmitted page or on the first page of transmission, the date and time it is sent and an identification of the business, other entity, or other individual sending the message and the telephone number of the sending machine or such business, other entity, or individual. (The telephone number provided might not be a 900 number or any other number for which charges exceed local or long-distance transmission charges.) In order to program this information into your fax machine, you should complete the steps described in the software.

Notice to users of the Canadian telephone network

Note à l'attention des utilisateurs du réseau téléphonique canadien/Notice to users of the Canadian telephone network

Cet appareil est conforme aux spécifications techniques des équipements terminaux d'Industrie Canada. Le numéro d'enregistrement atteste de la conformité de l'appareil. L'abréviation IC qui précède le numéro d'enregistrement indique que l'enregistrement a été effectué dans le cadre d'une Déclaration de conformité stipulant que les spécifications techniques d'Industrie Canada ont été respectées. Néanmoins, cette abréviation ne signifie en aucun cas que l'appareil a été validé par Industrie Canada.

Pour leur propre sécurité, les utilisateurs doivent s'assurer que les prises électriques reliées à la terre de la source d'alimentation, des lignes téléphoniques et du circuit métallique d'alimentation en eau sont, le cas échéant, branchées les unes aux autres. Cette précaution est particulièrement importante dans les zones rurales.



Remarque Le numéro REN (Ringer Equivalence Number) attribué à chaque appareil terminal fournit une indication sur le nombre maximal de terminaux qui peuvent être connectés à une interface téléphonique. La terminaison d'une interface peut se composer de n'importe quelle combinaison d'appareils, à condition que le total des numéros REN ne dépasse pas 5.

Basé sur les résultats de tests FCC Partie 68, le numéro REN de ce produit est 0.0B.

This equipment meets the applicable Industry Canada Terminal Equipment Technical Specifications. This is confirmed by the registration number. The abbreviation IC before the registration number signifies that registration was performed based on a Declaration of Conformity indicating that Industry Canada technical specifications were met. It does not imply that Industry Canada approved the equipment.

Users should ensure for their own protection that the electrical ground connections of the power utility, telephone lines and internal metallic water pipe system, if present, are connected together. This precaution might be particularly important in rural areas.



Note The REN (Ringer Equivalence Number) assigned to each terminal device provides an indication of the maximum number of terminals allowed to be connected to a telephone interface. The termination on an interface might consist of any combination of devices subject only to the requirement that the sum of the Ringer Equivalence Numbers of all the devices does not exceed 5.

The REN for this product is 0.0B, based on FCC Part 68 test results.

Notice to users in the European Economic Area

Notice to users in the European Economic Area



This product is designed to be connected to the analog Switched Telecommunication Networks (PSTN) of the European Economic Area (EEA) countries/regions.

Network compatibility depends on customer selected settings, which must be reset to use the equipment on a telephone network in a country/region other than where the product was purchased. Contact the vendor or Hewlett-Packard Company if additional product support is necessary.

This equipment has been certified by the manufacturer in accordance with Directive 1999/5/EC (annex II) for Pan-European single-terminal connection to the public switched telephone network (PSTN). However, due to differences between the individual PSTNs provided in different countries, the approval does not, of itself, give an unconditional assurance of successful operation on every PSTN network termination point.

In the event of problems, you should contact your equipment supplier in the first instance.

This equipment is designed for DTMF tone dialing and loop disconnect dialing. In the unlikely event of problems with loop disconnect dialing, it is recommended to use this equipment only with the DTMF tone dial setting.

Notice to users of the German telephone network

Hinweis für Benutzer des deutschen Telefonnetzes

Dieses HP-Fax ist nur für den Anschluss eines analogen Public Switched Telephone Network (PSTN) gedacht. Schließen Sie den TAE N-Telefonstecker, der im Lieferumfang des HP All-in-One enthalten ist, an die Wandsteckdose (TAE 6) Code N an. Dieses HP-Fax kann als einzelnes Gerät und/oder in Verbindung (mit seriellem Anschluss) mit anderen zugelassenen Endgeräten verwendet werden.

Australia wired fax statement

In Australia, the HP device must be connected to Telecommunication Network through a line cord which meets the requirements of the Technical Standard AS/ACIF S008.

Regulatory information for wireless products

This section contains the following regulatory information pertaining to wireless products:

- [Exposure to radio frequency radiation](#)
- [Notice to users in Brazil](#)
- [Notice to users in Canada](#)
- [Notice to users in Taiwan](#)
- [European Union regulatory notice](#)

Exposure to radio frequency radiation

Exposure to radio frequency radiation



Caution The radiated output power of this device is far below the FCC radio frequency exposure limits. Nevertheless, the device shall be used in such a manner that the potential for human contact during normal operation is minimized. This product and any attached external antenna, if supported, shall be placed in such a manner to minimize the potential for human contact during normal operation. In order to avoid the possibility of exceeding the FCC radio frequency exposure limits, human proximity to the antenna shall not be less than 20 cm (8 inches) during normal operation.

Notice to users in Brazil

Aviso aos usuários no Brasil

Este equipamento opera em caráter secundário, isto é, não tem direito à proteção contra interferência prejudicial, mesmo de estações do mesmo tipo, e não pode causar interferência a sistemas operando em caráter primário. (Res.ANATEL 282/2001).

Notice to users in Canada

Notice to users in Canada/Note à l'attention des utilisateurs canadiens

For Indoor Use. This digital apparatus does not exceed the Class B limits for radio noise emissions from the digital apparatus set out in the Radio Interference Regulations of the Canadian Department of Communications. The internal wireless radio complies with RSS 210 and RSS GEN of Industry Canada.

Utiliser à l'intérieur. Le présent appareil numérique n'émet pas de bruit radioélectrique dépassant les limites applicables aux appareils numériques de la classe B prescrites dans le Règlement sur le brouillage radioélectrique édicté par le ministère des Communications du Canada. Le composant RF interne est conforme à la norme RSS-210 and RSS GEN d'Industrie Canada.

Notice to users in Taiwan

低功率電波輻射性電機管理辦法

第十二條

經型式認證合格之低功率射頻電機，非經許可，公司、商號或使用者均不得擅自變更頻率、加大功率或變更設計之特性及功能。

第十四條

低功率射頻電機之使用不得影響飛航安全及干擾合法通信；經發現有干擾現象時，應立即停用，並改善至無干擾時方得繼續使用。

前項合法通信，指依電信法規定作業之無線電通信。低功率射頻電機須忍受合法通信或工業、科學及醫藥用電波輻射性電機設備之干擾。

European Union regulatory notice

European Union Regulatory Notice

Products bearing the CE marking comply with the following EU Directives:

- Low Voltage Directive 2006/95/EC
- EMC Directive 2004/108/EC

CE compliance of this product is valid only if powered with the correct CE-marked AC adapter provided by HP.

If this product has telecommunications functionality, it also complies with the essential requirements of the following EU Directive:

- R&TTE Directive 1999/5/EC

Compliance with these directives implies conformity to harmonized European standards (European Norms) that are listed in the EU Declaration of Conformity issued by HP for this product or product family. This compliance is indicated by the following conformity marking placed on the product.



The wireless telecommunications functionality of this product may be used in the following EU and EFTA countries:

Austria, Belgium, Bulgaria, Cyprus, Czech Republic, Denmark, Estonia, Finland, France, Germany, Greece, Hungary, Iceland, Ireland, Italy, Latvia, Liechtenstein, Lithuania, Luxembourg, Malta, Netherlands, Norway, Poland, Portugal, Romania, Slovak Republic, Slovenia, Spain, Sweden, Switzerland and United Kingdom.

Products with 2.4-GHz wireless LAN devices

France

For 2.4 GHz Wireless LAN operation of this product certain restrictions apply: This product may be used indoor for the entire 2400-2483.5 MHz frequency band (channels 1-13). For outdoor use, only 2400-2454 MHz frequency band (channels 1-9) may be used. For the latest requirements, see <http://www.art-telecom.fr>.

Italy

License required for use. Verify with your dealer or directly with the General Direction for Frequency Planning and Management (Direzione Generale Pianificazione e Gestione Frequenze).

Regulatory model number

For regulatory identification purposes, your product is assigned a Regulatory Model Number. The Regulatory Model Number for your product is SNPRC-1000-01. This regulatory number should not be confused with the marketing name (HP Officejet Pro 8500A (A910) e-All-in-One series) or product number.

Declaration of conformity

		DECLARATION OF CONFORMITY according to ISO/IEC 17050-1 and EN 17050-1	
Supplier's Name:	Hewlett-Packard Company	DoC#: SNPRC-1001-01-A	
Supplier's Address:	138, Depot Road, #02-01, #04-01 Singapore 109683		
declares, that the product			
Product Name and Model:	HP Officejet Pro 8500A e-All-in-One, HP Officejet Pro 8500A Plus e-All-in-One HP Officejet Pro 8500A Premium e-All-in-One		
Regulatory Model Number:¹⁾	SNPRC-1001-01		
Product Options:	C9101A / Automatic 2-Sided Printing Device CM759A / 2 nd Tray		
Power adaptor:	0957-2262, 0957-2283		
Radio Module Number:	SDGOB-0892		
conforms to the following Product Specifications and Regulations:			
Safety:	IEC 60950-1, Ed 2 (2005) / EN 60950-1, Ed 2 (2006) EN 62311:2008		
EMC:	CISPR 22:2005 +A1:2005 / EN55022:2006 +A1:2007 Class B EN 55024:1998 +A1:2001 + A2:2003 EN 61000-3-2:2006 EN 61000-3-3:1995 +A1: 2001 + A2:2005 FCC CFR 47, Part 15 Class B / ICES-003, Issue 4 Class B		
Telecom:	EN 301 489-1 V1.8.1:2008 / EN 301 489-17 V1.3.2:2008 EN 300 328 V1.7.1 : 2006 TBR 21: 1998 ³⁾ FCC Rules and Regulations 47CFR Part 68 TIA-968-A-1+A-2+A-3+A-4+A-5 Telecommunications – Telephone Terminal Equipment CS-03, Part I, Issue 9, Feb 2005		
Energy Use:	Regulation (EC) No. 1275/2008 ENERGY STAR® Qualified Imaging Equipment Operational Mode (OM) Test Procedure Regulation (EC) No. 278/2009 Test Method for Calculating the Energy Efficiency of Single-Voltage External AC-DC and AC-AC Power supplies		
Supplementary Information:			
1. This product is assigned a Regulatory Model Number which stays with the regulatory aspects of the design. The Regulatory Model Number is the main product identifier in the regulatory documentation and test reports, this number should not be confused with the marketing name or the product numbers.			
2. This product complies with the requirements of the Low Voltage Directive 2006/95/EC, the EMC Directive 2004/108/EC, EuP Directive 2005/32/EC, the R&TTE Directive 99/5/EC and the European Council Recommendation 1999/519/EC on the limitation of Electromagnetic fields to the general public and carries the CE marking accordingly. In addition, it complies with the WEEE Directive 2002/96/EC and RoHS Directive 2002/95/EC.			
3. This product complies with TBR21:1998, except clause 4.7.1 (DC characteristic), which complies with ES 203 021-3, clause 4.7.1.			
4. This Device complies with Part 15 of the FCC Rules. Operation is subject to the following two Conditions: (1) This device may not cause harmful interference, and (2) this device must accept any interference received, including interference that may cause undesired operation.			
5. The product was tested in a typical configuration.			
6. The power adapter 0957-2283 is for India and China market only.			
Singapore January 2010		<hr/> Yik Hou Meng Product Regulations Manager Customer Assurance, Business Printing Division	
Local contact for regulatory topics only: EMEA: Hewlett-Packard GmbH, HQ-TRE, Herrenberger Strasse 140, 71034 Boeblingen, Germany www.hp.com/go/certificates USA: Hewlett-Packard, 3000 Hanover St., Palo Alto 94304, U.S.A. 650-857-1501			

Environmental product stewardship program

Hewlett-Packard is committed to providing quality products in an environmentally sound manner. Design for recycling has been incorporated into this product. The number of materials has been kept to a minimum while ensuring proper functionality and reliability. Dissimilar materials have been designed to separate easily. Fasteners and other connections are easy to locate, access, and remove using common tools. High priority parts have been designed to access quickly for efficient disassembly and repair.

For more information, visit HP's Commitment to the Environment Web site at:

www.hp.com/hpinfo/globalcitizenship/environment/index.html

This section contains the following topics:

- [Paper use](#)
- [Plastics](#)
- [Material safety data sheets](#)
- [Recycling program](#)
- [HP inkjet supplies recycling program](#)
- [Disposal of waste equipment by users in private households in the European Union](#)
- [Power consumption](#)
- [Chemical Substances](#)
- [RoHS notices \(China only\)](#)

Paper use

This product is suited for the use of recycled paper according to DIN 19309 and EN 12281:2002.

Plastics

Plastic parts over 25 grams are marked according to international standards that enhance the ability to identify plastics for recycling purposes at the end of product life.

Material safety data sheets

Material safety data sheets (MSDS) can be obtained from the HP Web site at:

www.hp.com/go/msds

Recycling program

HP offers an increasing number of product return and recycling programs in many countries/regions, and partners with some of the largest electronic recycling centers throughout the world. HP conserves resources by reselling some of its most popular products. For more information regarding recycling of HP products, please visit:

www.hp.com/hpinfo/globalcitizenship/environment/recycle/

HP inkjet supplies recycling program

HP is committed to protecting the environment. The HP Inkjet Supplies Recycling Program is available in many countries/regions, and lets you recycle used print cartridges and ink cartridges free of charge. For more information, go to the following Web site:

www.hp.com/hpinfo/globalcitizenship/environment/recycle/

Disposal of waste equipment by users in private households in the European Union



English	Disposal of Waste Equipment by Users in Private Households in the European Union This symbol on the product or on its packaging indicates that this product must not be disposed of with your other household waste. Instead, it is your responsibility to dispose of your waste equipment by handing it over to a designated collection point for the recycling of waste electrical and electronic equipment. The separate collection and recycling of your waste equipment of this kind of disposal will help to conserve natural resources and ensure that it is recycled in a manner that protects human health and the environment. For more information about where you can drop off your waste equipment for recycling, please contact your local city office, your household waste disposal service or the shop where you purchased the product.
Français	Évacuation des équipements usagés par les utilisateurs dans les foyers privés au sein de l'Union européenne La présence de ce symbole sur le produit ou sur son emballage indique que vous ne pouvez pas vous débarrasser de ce produit de la même façon que des déchets courants. Au contraire, vous êtes responsable de l'évacuation de vos équipements usagés et, à cet effet, vous êtes tenu de les remettre à un point de collecte agréé pour le recyclage des équipements électriques et électroniques usagés. Le tri, l'évacuation et le recyclage séparés de vos équipements usagés permettent de préserver les ressources naturelles et de s'assurer que ces équipements sont recyclés dans le respect de la santé humaine et de l'environnement. Pour plus d'informations sur les lieux de collecte des équipements usagés, veuillez contacter votre mairie, votre service de traitement des déchets ménagers ou le magasin où vous avez acheté le produit.
Deutsch	Entsorgung von Elektrogeräten durch Benutzer in privaten Haushalten in der EU Dieses Symbol auf dem Produkt oder dessen Verpackung gibt an, dass das Produkt nicht zusammen mit dem Restmüll entsorgt werden darf. Es obliegt daher Ihrer Verantwortung, das Gerät an einer entsprechenden Stelle für die Entsorgung oder Wiederverwertung von Elektrogeräten aller Art abzugeben (z.B. einen Wertstoffhof). Die separate Sammlung und das Recycling Ihrer alten Elektrogeräte zum Zeitpunkt Ihrer Entsorgung trägt zum Schutz der Umwelt bei und gewährleistet, dass sie auf eine Art und Weise recycelt werden, die keine Gefährdung für die Gesundheit des Menschen und der Umwelt darstellt. Weitere Informationen darüber, wo Sie alte Elektrogeräte zum Recyceln abgeben können, erhalten Sie bei den örtlichen Behörden, Wertstoffhöfen oder dort, wo Sie das Gerät erworben haben.
Italiano	Smaltimento di apparecchiature da rottamare da parte di privati nell'Unione Europea Questo simbolo che appare sul prodotto o sulla confezione indica che il prodotto non deve essere smaltito assieme agli altri rifiuti domestici. Gli utenti devono provvedere allo smaltimento delle apparecchiature da rottamare portandolo al luogo di raccolta indicato per il riciclaggio delle apparecchiature elettriche ed elettroniche. Lo raccolta e il riciclaggio separati delle apparecchiature da rottamare in fase di smaltimento favoriscono la conservazione delle risorse naturali e garantiscono che tali apparecchiature vengano trattate nel rispetto dell'ambiente e della tutela della salute. Per ulteriori informazioni sui punti di raccolta delle apparecchiature da rottamare, contattare il proprio comune di residenza, il servizio di smaltimento dei rifiuti locale o il negozio presso il quale è stato acquistato il prodotto.
Español	Eliminación de residuos de aparatos eléctricos y electrónicos por parte de usuarios domésticos en la Unión Europea Este símbolo en el producto o en el embalaje indica que no se puede desechar el producto junto con los residuos domésticos. Por el contrario, si debe eliminar este tipo de residuo, es responsabilidad del usuario entregarlo en un punto de recogida designado de reciclado de aparatos eléctricos y electrónicos. El reciclaje y el reciclado por separado de estos residuos en el momento de la eliminación ayudará a preservar recursos naturales y a garantizar que el reciclaje protege la salud y el medio ambiente. Si desea información adicional sobre los lugares donde puede dejar estos residuos para su reciclado, póngase en contacto con las autoridades locales de su ciudad, con el servicio de gestión de residuos domésticos o con la tienda donde adquirió el producto.
Česky	Likvidace vysloužilého zařízení uživateli v domácnosti v zemích EU Toto znáčka na produktu nebo na jeho obalu označuje, že tento produkt nesmí být likvidován společným vývozem do běžného domovního odpadu. Odpovědné za to, že vyloučené zařízení bude předáno k recyklaci, je uživatel. Předání k recyklaci musí být likvidováno v předem určených místech. Likvidace vysloužilého zařízení samostatným způsobem a recyklací nepomáhá zachovávat přírodních zdrojů a zajišťuje, že recyklace proběhne způsobem chránícím lidské zdraví a životní prostředí. Další informace o tom, kam můžete vysloužilé zařízení předat k recyklaci, můžete získat od úřadů místní samosprávy, od společnosti provádějící svoz a likvidaci domovního odpadu nebo v obchodě, kde jste produkt zakoupili.
Dansk	Bortskaffelse af affaldsudrustning for brugere i private husholdninger i EU Dette symbol på produktet eller på dets emballage indikerer, at produktet ikke må bortskaffes sammen med andet husholdningsaffald. I stedet er det din ansvar at aflevere dit affaldsudrustning ved et afleveringssted til genbrug eller til behandling med henblik på genbrug af elektrisk og elektronisk affaldsudrustning. Den separate indsamling og genbrug af dit affaldsudrustning på tidspunktet for bortskaffelse er med til at bevare naturlige ressourcer og sikre, at genbrug finder sted på en måde, der beskytter menneskers helbred samt miljøet. Hvis du vil vide mere om, hvor du kan aflevere dit affaldsudrustning til genbrug, kan du kontakte kommunen, dit lokale miljøcenter eller anden forretning, hvor du købte produktet.
Nederlands	Afvoer van afgedankte apparatuur door gebruikers in particuliere huishoudens in de Europese Unie Dit symbool op het product of de verpakking geeft aan dat dit product niet mag worden afgevoerd met het huishoudelijk afval. Het is u verantwoordelijkheid uw afgedankte apparatuur af te leveren op een aangewezen inzamelpunt voor de verwerking van afgedankte elektrische en elektronische apparatuur. De gescheiden verzameling en vervoer van uw afgedankte apparatuur draagt bij tot het sparen van natuurlijke bronnen en tot het teruggeven van materiaal op een wijze die de volksgezondheid en het milieu beschermt. Voor meer informatie over waar u uw afgedankte apparatuur kunt inleveren voor recycling kunt u contact opnemen met het gemeentehuis in uw woonplaats, de reinigingsdienst of de winkel waar u het product hebt aangekocht.
Eesti	Ermooldajadest kasutatud kõrvaldatavate seadmete käitlemine Euroopa Liidus Kui tootel või toote pakendil on see sümbol, ei tohi seda toodet viiea teha koos muude kodumajapidamiste elektrilise ja elektroonikaseadmetega ühiseltäetavusse. Ühiseltäetavusse seadmete eraldi kogumise ja käitlemise ohtu süüta loovateks ning tagades, et käitlemine toimib inimeste tervisele ja keskkonnale ohult. Lisateavust selle kohta, kuhu seadme ühiseltäetavusse käitlemaks viia, saate küsida kohaliku omavalitsuse, ettevõtte või kasutajakeskuse käest.
Suomi	Hävitetävien laitteiden käsittely kotitalouksissa Euroopan unionin alueella Tämä kollektio- tai kierrätysmerkki on tuotteen tai sen pakkauksen merkki, joka ei saa jätetä yhdessä muun kotitalouksen jätteen kanssa. Käytävien velloisuus on huolehdittava siitä, että hävitetävää laite kollektio- tai kierrätyskeskukseen, jolla on erillinen keräys- ja käsittelypaikka sähkö- ja elektronikalaitteiden keräys- ja käsittelyä varten. Käytävien velloisuus ja erillinen käsittely auttavat säästämään luonnonvaroja. Niin toimittamalla vaimennetaan myös, että keräilytätä tapahtuu tavalla, joka suojelee ihmisten tervyyttä ja ympäristöä. Saat tarvittavassa laitteistojen käsitely-yhteistyökeskuksesta paikallista neuvontaa, josta voit saada lisätietoja tuotteen hävittämisestä.
Ελληνικά	Απόρριψη χρηστών οικιακών στην Ευρωπαϊκή Ένωση Το παρόν σύμβολο στον εξοπλισμό ή στη συσκευασία του υποδεικνύει ότι το προϊόν αυτό δεν πρέπει να πεταχτεί μαζί με άλλα οικιακά απόβλητα. Αντίθετα, ευθύνη σας είναι να απορρίψετε τις ηλεκτρικές συσκευές σε ένα καθορισμένο σημείο συλλογής απορριμμάτων για την ανακύκλωση ή σε ένα ανακυκλώσιμο σημείο συλλογής για την ανακύκλωση. Η χωριστή συλλογή και ανακύκλωση των χρηστών οικιακών ή των συμβόλων στη διατήρηση των φυσικών πόρων και της ανακύκλωσης ή σε άλλους τρόπους, ώστε να προστατευτεί η υγεία των ανθρώπων και το περιβάλλον. Για περισσότερες πληροφορίες σχετικά με το πού μπορείτε να απορρίψετε τις ηλεκτρικές συσκευές για ανακύκλωση, επικοινωνήστε με τις κατά τόπους αρμόδιες αρχές ή με το κατάστημα από το οποίο αγοράσατε το προϊόν.
Magyar	A hulladékok nyakozése a megághozártásokban az Európai Unióban Ez a szimbólum, amely a termék vagy annak csomagolásán van feltüntetve, azt jelzi, hogy a termék nem kezelhető együtt az egyéb háztartási hulladékkal. Az Ön feladata, hogy a kezelési hulladékokat egyéltáson átviselje kijelölt gyűjtőhelyre, amely az elektronikus hulladékoknak és az elektronika berendezések újrahazavonására alkalmasított. A hulladékokat elkülönítve gyűjtése és újrahazavonása hozzájárul a természeti erőforrások megőrzéséhez, egyúttal azt is biztosítja, hogy a hulladék újrahazavonása az egészséges és a környezetet nem ártalmas módon történjen. Ha tájékozottabb szeretne lenni azokkal a helyekkel, ahol leadhatja újrahazavonásra a hulladékokat, forduljon a helyi önkormányzatához, a háztartási hulladék begyűjtésével foglalkozó vállalatához vagy a termék forgalmazójához.
Latvianki	Lietuvoti avbrivnosnis no nedergirij elektriskj Eropas Savienības privātoju mēģināmcilvēks Šis simbols uz ierīces vai tās iepakojuma norāda, ka šis produkts nedrīkst tikt kopā ar pārējiem mājokļa atkritumiem. Jūs esat atbildīgi par atbrivnosnis no nedergirij ierīces, ko nodrošināt nodarītāja savākoties vietā, lai tiku veikta nedergirij elektriskj un elektroniskj aprīkojuma atbrivnosnis pārstādite. Speciāla nedergirij ierīces avbrivnosnis atbrivnosni pārstādite palīdz ietaupīt dabas resursus un nodrošina atbrivnosni pārstādite, kas sargā cilvēku veselību un apkārtējo vidi. Lai iegūtu papildu informāciju par to, kur avbrivnosni pārstādite var nodot nedergirij ierīci, lūdzam sazināties ar vietējo pašvaldību, mājokļa atkritumu atbrivnosnis dienestu vai veikala, kurā iegādājāties ierīci.
Polki	Użytkowniki avbrivnosnis sprzetu przez użytkowników domowych w Unii Europejskiej Symbol ten umieszczony na produkcie lub opakowaniu oznacza, że tego produktu nie należy wyrzucać razem z innymi odpadami domowymi. Użytkownik jest odpowiedzialny za dostarczenie zużytego sprzetu do wyznaczonego punktu gromadzenia zużytych urządzeń elektrycznych i elektronicznych. Gromadzenie odpadów i recykling przez tego rodzaju przyrzeczenia sio do ochrony zasobów naturalnych i jest bezpieczny dla zdrowia i środowiska naturalnego. Dostaw informacji na temat sposobu użytkowania zużytych urządzeń można uzyskać z odpowiednich władz lokalnych, w przedsiębiorstwie zajmującym się usuwaniem odpadów lub w miejscu zakupu produktu.
Portugalski	Descarte de equipamentos por usuários em residências da União Europeia Este símbolo no produto ou no embalagem indica que o produto não pode ser descartado junto com o lixo doméstico. No entanto, é sua responsabilidade levar os equipamentos a serem descartados a um ponto de coleta designado para o reciclagem de equipamentos eletro-eletrônicos. A coleta separada e o reciclagem dos equipamentos no momento do descarte ajudam na conservação dos recursos naturais e garantem que os equipamentos serão reciclados de forma a proteger a saúde das pessoas e o meio ambiente. Para obter mais informações sobre onde descartar equipamentos para reciclagem, entre em contato com o escritório local de sua cidade, o serviço de limpeza pública de seu bairro ou a loja em que adquiriu o produto.
Slovenščina	Postop poravnavatov v krajnjih Europejski eni pri vyhadzavani zariadenia v domacem poravnavatav do odpadu Toto symbol na produktu alebo na jeho obale znamená, že nesmie by vyhadzaný s iným komunálnym odpadom. Namieto toho máte povinnos odvážať toto zariadenie na zbernom mieste, kde sa zabezpečuje recyklácia elektrických a elektronicznych zariadení. Separovaný zber a recyklácia zariadenia určeneho na odpad pomáha chrániť prírodné zdroje a zabezpečuje taký spôsob recyklácie, ktorý bude zdravý ľudské životné prostredie. Ďalšie informácie o separovanom zbere a recyklácii získate na miestnom zbernom úrade, vo firme zabezpečujúcej zber vášho komunálneho odpadu alebo v predajni, kde ste produkt kúpili.
Slovenščina	Ravnane z odpadno opremo v gospodinjstvih znotraj Evropske unije To znaki na izdelku ali na embalaži izdelka pomeni, da izdelka ne smete odpadati skupaj z drugim gospodinjstvenim odpadki. Odpadno opremo se dolni odnati na zbrnem mestu za recikliranje odpadne elektricne in elektronicne opreme. Z ločenim zbiranjem in recikliranjem odpadne opreme ob odlaganju opreme ohraniti naravnne vire in zagotoviti, da bo odpadna oprema reciklirana tako, da se varuje zdravje ljudi in okolje. Več informacij o mestih, kjer lahko oddate odpadno opremo za recikliranje, lahko dobite na občini, v komunalnem podjetju ali trgovini, kjer ste izdelek kupili.
Svenska	Kassering av förbrukningsmaterial, för hem- och privatvårdare i EU Produkt eller produktförpackning med den här symbolen får inte kasseras med vanlig hushållsavfall. I stället får du ansvar för att produkten lämnas till en behörig återvinningstjänst för hantering av avskrotade elektriska och elektroniska produkter. Den separata samlningen och återvinningen av avskrotade elektriska och elektroniska produkter hjälper till att bevara våra naturliga resurser. Dessutom skyddas både människor och miljön när produkter återvinns på rätt sätt. Kommunala myndigheter, sophanteringsföretag eller butik där varan köptes kan ge mer information om var återvinning kasserade produkter för återvinning.

Power consumption

Hewlett-Packard printing and imaging equipment marked with the ENERGY STAR® logo is qualified to the U.S. Environmental Protection Agency's ENERGY STAR specifications for imaging equipment. The following mark appears on ENERGY STAR qualified imaging products:



ENERGY STAR is a U.S. registered service mark of the U.S. EPA. As an ENERGY STAR partner, HP has determined that this product meets ENERGY STAR guidelines for energy efficiency.

Additional ENERGY STAR qualified imaging product model information is listed at:

www.hp.com/go/energystar

Chemical Substances

HP is committed to providing our customers with information about the chemical substances in our products as needed to comply with legal requirements such as REACH (*Regulation EC No 1907/2006 of the European Parliament and the Council*). A chemical information report for this product can be found at: www.hp.com/go/reach

RoHS notices (China only)

Toxic and hazardous substance table

有毒有害物质表						
根据中国《电子信息产品污染控制管理办法》						
零件描述	有毒有害物质和元素					
	铅	汞	镉	六价铬	多溴联苯	多溴联苯醚
外壳和托盘*	0	0	0	0	0	0
电线*	0	0	0	0	0	0
印刷电路板*	X	0	0	0	0	0
打印系统*	X	0	0	0	0	0
显示器*	X	0	0	0	0	0
喷墨打印机墨盒*	0	0	0	0	0	0
驱动光盘*	X	0	0	0	0	0
扫描仪*	X	X	0	0	0	0
网络配件*	X	0	0	0	0	0
电路板*	X	0	0	0	0	0
自动双面打印系统*	0	0	0	0	0	0
外部电源*	X	0	0	0	0	0

0: 指此部件的所有均一材料中包含的这种有毒有害物质, 含量低于SJ/T11363-2006的限制
X: 指此部件使用的均一材料中至少有一种包含的这种有毒有害物质, 含量高于SJ/T11363-2006的限制
注: 环保使用期限的参考标识取决于产品正常工作的温度和湿度等条件
*以上只适用于使用这些部件的产品

Third-party licenses

HP Officejet Pro 8500A (A910) series third-party licenses

LICENSE.aes-pubdom--crypto

/* rijndael-alg-fst.c

*

* @version 3.0 (December 2000)

*

* Optimised ANSI C code for the Rijndael cipher (now AES)

*

* @author Vincent Rijmen <vincent.rijmen@esat.kuleuven.ac.be>

* @author Antoon Bosselaers <antoon.bosselaers@esat.kuleuven.ac.be>

* @author Paulo Barreto <paulo.barreto@terra.com.br>

*

* This code is hereby placed in the public domain.

*

* THIS SOFTWARE IS PROVIDED BY THE AUTHORS "AS IS" AND ANY EXPRESS
* OR IMPLIED WARRANTIES, INCLUDING, BUT NOT LIMITED TO, THE IMPLIED
* WARRANTIES OF MERCHANTABILITY AND FITNESS FOR A PARTICULAR PURPOSE
* ARE DISCLAIMED. IN NO EVENT SHALL THE AUTHORS OR CONTRIBUTORS BE
* LIABLE FOR ANY DIRECT, INDIRECT, INCIDENTAL, SPECIAL, EXEMPLARY, OR
* CONSEQUENTIAL DAMAGES (INCLUDING, BUT NOT LIMITED TO, PROCUREMENT OF
* SUBSTITUTE GOODS OR SERVICES; LOSS OF USE, DATA, OR PROFITS; OR
* BUSINESS INTERRUPTION) HOWEVER CAUSED AND ON ANY THEORY OF LIABILITY,
* WHETHER IN CONTRACT, STRICT LIABILITY, OR TORT (INCLUDING NEGLIGENCE
* OR OTHERWISE) ARISING IN ANY WAY OUT OF THE USE OF THIS SOFTWARE,
* EVEN IF ADVISED OF THE POSSIBILITY OF SUCH DAMAGE.

*/

LICENSE.expatsmit--expat

Copyright (c) 1998, 1999, 2000 Thai Open Source Software Center Ltd

Permission is hereby granted, free of charge, to any person obtaining a copy of this software and associated documentation files (the "Software"), to deal in the Software without restriction, including without limitation the rights to use, copy, modify, merge, publish, distribute, sublicense, and/or sell copies of the Software, and to permit persons to whom the Software is furnished to do so, subject to the following conditions:

The above copyright notice and this permission notice shall be included in all copies or substantial portions of the Software.

THE SOFTWARE IS PROVIDED "AS IS", WITHOUT WARRANTY OF ANY KIND, EXPRESS OR IMPLIED, INCLUDING BUT NOT LIMITED TO THE WARRANTIES OF MERCHANTABILITY, FITNESS FOR A PARTICULAR PURPOSE AND NONINFRINGEMENT. IN NO EVENT SHALL THE AUTHORS OR COPYRIGHT HOLDERS BE LIABLE FOR ANY CLAIM, DAMAGES OR OTHER LIABILITY, WHETHER IN AN ACTION OF CONTRACT, TORT OR OTHERWISE, ARISING FROM, OUT OF OR IN CONNECTION WITH THE SOFTWARE OR THE USE OR OTHER DEALINGS IN THE SOFTWARE.

LICENSE.md4-pubdom--jm_share_folder

LibTomCrypt is public domain. As should all quality software be.

All of the software was either written by or donated to Tom St Denis for the purposes of this project. The only exception is the SAFER.C source which has no known license status (assumed copyrighted) which is why SAFER.C is shipped as disabled.

Tom St Denis

LICENSE.md5-pubdom--jm_share_folder

LibTomCrypt is public domain. As should all quality software be.

All of the software was either written by or donated to Tom St Denis for the purposes of this project. The only exception is the SAFER.C source which has no known license status (assumed copyrighted) which is why SAFER.C is shipped as disabled.

Tom St Denis

LICENSE.open_ssl--open_ssl

Copyright (C) 1995-1998 Eric Young (eay@cryptsoft.com)

All rights reserved.

This package is an SSL implementation written by Eric Young (eay@cryptsoft.com). The implementation was written so as to conform with Netscapes SSL.

This library is free for commercial and non-commercial use as long as the following conditions are aheared to. The following conditions apply to all code found in this distribution, be it the RC4, RSA, lhash, DES, etc., code; not just the SSL code. The SSL documentation included with this distribution is covered by the same copyright terms except that the holder is Tim Hudson (tjh@cryptsoft.com).

Copyright remains Eric Young's, and as such any Copyright notices in

the code are not to be removed.

If this package is used in a product, Eric Young should be given attribution as the author of the parts of the library used.

This can be in the form of a textual message at program startup or in documentation (online or textual) provided with the package.

Redistribution and use in source and binary forms, with or without modification, are permitted provided that the following conditions are met:

1. Redistributions of source code must retain the copyright notice, this list of conditions and the following disclaimer.
2. Redistributions in binary form must reproduce the above copyright notice, this list of conditions and the following disclaimer in the documentation and/or other materials provided with the distribution.
3. All advertising materials mentioning features or use of this software must display the following acknowledgement:

"This product includes cryptographic software written by Eric Young (eay@cryptsoft.com)"

The word 'cryptographic' can be left out if the routines from the library being used are not cryptographic related :-).

4. If you include any Windows specific code (or a derivative thereof) from the apps directory (application code) you must include an acknowledgement: "This product includes software written by Tim Hudson (tjh@cryptsoft.com)"

THIS SOFTWARE IS PROVIDED BY ERIC YOUNG ``AS IS" AND ANY EXPRESS OR IMPLIED WARRANTIES, INCLUDING, BUT NOT LIMITED TO, THE IMPLIED WARRANTIES OF MERCHANTABILITY AND FITNESS FOR A PARTICULAR PURPOSE ARE DISCLAIMED. IN NO EVENT SHALL THE AUTHOR OR CONTRIBUTORS BE LIABLE FOR ANY DIRECT, INDIRECT, INCIDENTAL, SPECIAL, EXEMPLARY, OR CONSEQUENTIAL DAMAGES (INCLUDING, BUT NOT LIMITED TO, PROCUREMENT OF SUBSTITUTE GOODS OR SERVICES; LOSS OF USE, DATA, OR PROFITS; OR BUSINESS INTERRUPTION) HOWEVER CAUSED AND ON ANY THEORY OF LIABILITY, WHETHER IN CONTRACT, STRICT LIABILITY, OR TORT (INCLUDING NEGLIGENCE OR OTHERWISE) ARISING IN ANY WAY OUT OF THE USE OF THIS SOFTWARE, EVEN IF ADVISED OF THE POSSIBILITY OF SUCH DAMAGE.

The licence and distribution terms for any publicly available version or derivative of this code cannot be changed. i.e. this code cannot simply be copied and put under another distribution licence [including the GNU Public Licence.]

=====
Copyright (c) 1998-2001 The OpenSSL Project. All rights reserved.

Redistribution and use in source and binary forms, with or without

modification, are permitted provided that the following conditions are met:

1. Redistributions of source code must retain the above copyright notice, this list of conditions and the following disclaimer.
2. Redistributions in binary form must reproduce the above copyright notice, this list of conditions and the following disclaimer in the documentation and/or other materials provided with the distribution.
3. All advertising materials mentioning features or use of this software must display the following acknowledgment:
"This product includes software developed by the OpenSSL Project for use in the OpenSSL Toolkit. (<http://www.openssl.org/>)"
4. The names "OpenSSL Toolkit" and "OpenSSL Project" must not be used to endorse or promote products derived from this software without prior written permission. For written permission, please contact openssl-core@openssl.org.
5. Products derived from this software may not be called "OpenSSL" nor may "OpenSSL" appear in their names without prior written permission of the OpenSSL Project.
6. Redistributions of any form whatsoever must retain the following acknowledgment:
"This product includes software developed by the OpenSSL Project for use in the OpenSSL Toolkit (<http://www.openssl.org/>)"

THIS SOFTWARE IS PROVIDED BY THE OpenSSL PROJECT ``AS IS'' AND ANY EXPRESSED OR IMPLIED WARRANTIES, INCLUDING, BUT NOT LIMITED TO, THE IMPLIED WARRANTIES OF MERCHANTABILITY AND FITNESS FOR A PARTICULAR PURPOSE ARE DISCLAIMED. IN NO EVENT SHALL THE OpenSSL PROJECT OR ITS CONTRIBUTORS BE LIABLE FOR ANY DIRECT, INDIRECT, INCIDENTAL, SPECIAL, EXEMPLARY, OR CONSEQUENTIAL DAMAGES (INCLUDING, BUT NOT LIMITED TO, PROCUREMENT OF SUBSTITUTE GOODS OR SERVICES; LOSS OF USE, DATA, OR PROFITS; OR BUSINESS INTERRUPTION) HOWEVER CAUSED AND ON ANY THEORY OF LIABILITY, WHETHER IN CONTRACT, STRICT LIABILITY, OR TORT (INCLUDING NEGLIGENCE OR OTHERWISE) ARISING IN ANY WAY OUT OF THE USE OF THIS SOFTWARE, EVEN IF ADVISED OF THE POSSIBILITY OF SUCH DAMAGE.

=====

This product includes cryptographic software written by Eric Young (eay@cryptsoft.com). This product includes software written by Tim

Hudson (tjh@cryptsoft.com).

=====
Copyright (c) 1998-2006 The OpenSSL Project. All rights reserved.

Redistribution and use in source and binary forms, with or without modification, are permitted provided that the following conditions are met:

1. Redistributions of source code must retain the above copyright notice, this list of conditions and the following disclaimer.
2. Redistributions in binary form must reproduce the above copyright notice, this list of conditions and the following disclaimer in the documentation and/or other materials provided with the distribution.
3. All advertising materials mentioning features or use of this software must display the following acknowledgment:
"This product includes software developed by the OpenSSL Project for use in the OpenSSL Toolkit. (<http://www.openssl.org/>)"
4. The names "OpenSSL Toolkit" and "OpenSSL Project" must not be used to endorse or promote products derived from this software without prior written permission. For written permission, please contact openssl-core@openssl.org.
5. Products derived from this software may not be called "OpenSSL" nor may "OpenSSL" appear in their names without prior written permission of the OpenSSL Project.
6. Redistributions of any form whatsoever must retain the following acknowledgment:
"This product includes software developed by the OpenSSL Project for use in the OpenSSL Toolkit (<http://www.openssl.org/>)"

THIS SOFTWARE IS PROVIDED BY THE OpenSSL PROJECT ``AS IS" AND ANY EXPRESSED OR IMPLIED WARRANTIES, INCLUDING, BUT NOT LIMITED TO, THE IMPLIED WARRANTIES OF MERCHANTABILITY AND FITNESS FOR A PARTICULAR PURPOSE ARE DISCLAIMED. IN NO EVENT SHALL THE OpenSSL PROJECT OR ITS CONTRIBUTORS BE LIABLE FOR ANY DIRECT, INDIRECT, INCIDENTAL, SPECIAL, EXEMPLARY, OR CONSEQUENTIAL DAMAGES (INCLUDING, BUT NOT LIMITED TO, PROCUREMENT OF SUBSTITUTE GOODS OR SERVICES; LOSS OF USE, DATA, OR PROFITS; OR BUSINESS INTERRUPTION) HOWEVER CAUSED AND ON ANY THEORY OF LIABILITY, WHETHER IN CONTRACT,

STRICT LIABILITY, OR TORT (INCLUDING NEGLIGENCE OR OTHERWISE)
ARISING IN ANY WAY OUT OF THE USE OF THIS SOFTWARE, EVEN IF ADVISED
OF THE POSSIBILITY OF SUCH DAMAGE.

=====
This product includes cryptographic software written by Eric Young
(eay@cryptsoft.com). This product includes software written by Tim
Hudson (tjh@cryptsoft.com).

=====
Copyright 2002 Sun Microsystems, Inc. ALL RIGHTS RESERVED.
ECC cipher suite support in OpenSSL originally developed by
SUN MICROSYSTEMS, INC., and contributed to the OpenSSL project.

LICENSE.sha2-bsd--nos_crypto

/* FIPS 180-2 SHA-224/256/384/512 implementation
* Last update: 02/02/2007
* Issue date: 04/30/2005
*
* Copyright (C) 2005, 2007 Olivier Gay <olivier.gay@a3.epfl.ch>
* All rights reserved.
*
* Redistribution and use in source and binary forms, with or without
* modification, are permitted provided that the following conditions
* are met:
* 1. Redistributions of source code must retain the above copyright
* notice, this list of conditions and the following disclaimer.
* 2. Redistributions in binary form must reproduce the above copyright
* notice, this list of conditions and the following disclaimer in the
* documentation and/or other materials provided with the distribution.
* 3. Neither the name of the project nor the names of its contributors
* may be used to endorse or promote products derived from this software
* without specific prior written permission.
*
* THIS SOFTWARE IS PROVIDED BY THE PROJECT AND CONTRIBUTORS ``AS IS'' AND
* ANY EXPRESS OR IMPLIED WARRANTIES, INCLUDING, BUT NOT LIMITED TO, THE
* IMPLIED WARRANTIES OF MERCHANTABILITY AND FITNESS FOR A PARTICULAR
* PURPOSE
* ARE DISCLAIMED. IN NO EVENT SHALL THE PROJECT OR CONTRIBUTORS BE LIABLE
* FOR ANY DIRECT, INDIRECT, INCIDENTAL, SPECIAL, EXEMPLARY, OR CONSEQUENTIAL
* DAMAGES (INCLUDING, BUT NOT LIMITED TO, PROCUREMENT OF SUBSTITUTE GOODS
* OR SERVICES; LOSS OF USE, DATA, OR PROFITS; OR BUSINESS INTERRUPTION)
* HOWEVER CAUSED AND ON ANY THEORY OF LIABILITY, WHETHER IN CONTRACT,
* STRICT

* LIABILITY, OR TORT (INCLUDING NEGLIGENCE OR OTHERWISE) ARISING IN ANY WAY
* OUT OF THE USE OF THIS SOFTWARE, EVEN IF ADVISED OF THE POSSIBILITY OF
* SUCH DAMAGE.
*/

LICENSE.unicode--jm_share_folder

/*

* Copyright 2001-2004 Unicode, Inc.

*

* Disclaimer

*

* This source code is provided as is by Unicode, Inc. No claims are
* made as to fitness for any particular purpose. No warranties of any
* kind are expressed or implied. The recipient agrees to determine
* applicability of information provided. If this file has been
* purchased on magnetic or optical media from Unicode, Inc., the
* sole remedy for any claim will be exchange of defective media
* within 90 days of receipt.

*

* Limitations on Rights to Redistribute This Code

*

* Unicode, Inc. hereby grants the right to freely use the information
* supplied in this file in the creation of products supporting the
* Unicode Standard, and to make copies of this file in any form
* for internal or external distribution as long as this notice
* remains attached.

*/

LICENSE.zlib--zlib

zlib.h -- interface of the 'zlib' general purpose compression library
version 1.2.3, July 18th, 2005

Copyright (C) 1995-2005 Jean-loup Gailly and Mark Adler

This software is provided 'as-is', without any express or implied
warranty. In no event will the authors be held liable for any damages
arising from the use of this software.

Permission is granted to anyone to use this software for any purpose,
including commercial applications, and to alter it and redistribute it
freely, subject to the following restrictions:

1. The origin of this software must not be misrepresented; you must not
claim that you wrote the original software. If you use this software

in a product, an acknowledgment in the product documentation would be appreciated but is not required.

2. Altered source versions must be plainly marked as such, and must not be misrepresented as being the original software.

3. This notice may not be removed or altered from any source distribution.

Jean-loup Gailly Mark Adler

jloup@gzip.org madler@alumni.caltech.edu

The data format used by the zlib library is described by RFCs (Request for Comments) 1950 to 1952 in the files <http://www.ietf.org/rfc/rfc1950.txt> (zlib format), [rfc1951.txt](#) (deflate format) and [rfc1952.txt](#) (gzip format).

B HP supplies and accessories

This section provides information on HP supplies and accessories for the printer. The information is subject to changes, visit the HP Web site (www.hpshopping.com) for the latest updates. You may also make purchases through the Web site.

This section contains the following topics:

- [Order printing supplies online](#)
- [Supplies](#)

Order printing supplies online

To order supplies online or create a printable shopping list, open the HP software that came with your printer and click **Shopping**. Select **Shop for Supplies Online**. The HP software uploads, with your permission, printer information, including model number, serial number, and estimated ink levels. The HP supplies that work in your printer are pre-selected. You can change quantities, add or remove items, and then print the list or purchase online at the HP Store or other online retailers (options differ by country/region). Cartridge information and links to online shopping also appear on ink alert messages.

You can also order online by visiting www.hp.com/buy/supplies. If prompted, select your country/region, follow the prompts to select your printer, and then the supplies you need.

 **NOTE:** Ordering cartridges online is not supported in all countries/regions. However, many countries have information on ordering by telephone, locating a local store and printing a shopping list. In addition, you can select the 'How to Buy' option at the top of the www.hp.com/buy/supplies page to obtain information about purchasing HP products in your country.

Supplies

- [Ink cartridges and printheads](#)
- [HP media](#)

Ink cartridges and printheads

Ordering cartridges online is not supported in all countries/regions. However, many countries have information on ordering by telephone, locating a local store and printing a shopping list. In addition, you can select the How to Buy option at the top of the www.hp.com/buy/supplies page to obtain information about purchasing HP products in your country.

Use only the replacement cartridges that have the same cartridge number as the ink cartridge you are replacing. You can find the cartridge number in the following places:

- In the embedded Web server, by clicking the **Tools** tab, and then, under **Product Information** clicking **Ink Gauge**. For more information, see [Embedded Web server](#).
- On the label of the ink cartridge you are replacing.
- On the printer status page (see [Understand the Self Test Diagnostic Page](#)).

 **NOTE:** Ink level warnings and indicators provide estimates for planning purposes only. When you receive a low-ink warning message, consider having a replacement cartridge available to avoid possible printing delays. You do not need to replace cartridges until prompted to do so.

HP media

To order media such as HP Premium Paper, go to www.hp.com.



HP recommends plain papers with the ColorLok logo for printing and copying of everyday documents. All papers with the ColorLok logo are independently tested to meet high standards of reliability and print quality, and produce documents with crisp, vivid color, bolder blacks, and that dry faster than ordinary plain papers. Look for papers with the ColorLok logo in a variety of weights and sizes from major paper manufacturers.

C Additional fax setup

After completing all the steps in the getting started guide, use the instructions in this section to complete your fax setup. Keep your getting started guide for later use.

In this section, you learn how to set up the printer so that faxing works successfully with equipment and services you might already have on the same phone line.

 **TIP:** You can also use the Fax Setup Wizard (Windows) or HP Setup Assistant (Mac OS X) to help you quickly set up some important fax settings such as the answer mode and fax header information. You can access these tools through the HP software you installed with the printer. After you run these tools, follow the procedures in this section to complete your fax setup.

This section contains the following topics:

- [Set up faxing \(parallel phone systems\)](#)
- [Serial-type fax setup](#)
- [Test fax setup](#)

Set up faxing (parallel phone systems)

Before you begin setting up the printer for faxing, determine which kind of phone system your country/region uses. The instructions for fax setup differ depending on whether you have a serial- or parallel-type phone system.

- If you do not see your country/region listed in the table, you probably have a serial-type phone system. In a serial-type phone system, the connector type on your shared telephone equipment (modems, phones, and answering machines) does not allow a physical connection to the "2-EXT" port on the printer. Instead, all equipment must be connected at the telephone wall jack.

 **NOTE:** In some countries/regions that use serial-type phone systems, the phone cord that came with the printer might have an additional wall plug attached to it. This enables you to connect other telecom devices to the wall jack where you plug in the printer. You might need to connect the supplied phone cord to the adapter provided for your country/region.

- If your country/region is listed in the table, you probably have a parallel-type telephone system. In a parallel-type phone system, you are able to connect shared telephone equipment to the phone line by using the "2-EXT" port on the back of the printer.

 **NOTE:** If you have a parallel-type phone system, HP recommends you use the 2-wire phone cord supplied with the printer to connect it to the telephone wall jack.

Table C-1 Countries/regions with a parallel-type phone system

Argentina	Australia	Brazil
Canada	Chile	China
Colombia	Greece	India
Indonesia	Ireland	Japan
Korea	Latin America	Malaysia

Countries/regions with a parallel-type phone system (continued)

Mexico	Philippines	Poland
Portugal	Russia	Saudi Arabia
Singapore	Spain	Taiwan
Thailand	USA	Venezuela
Vietnam		

If you are unsure which kind of telephone system you have (serial or parallel), check with your telephone company.

This section contains the following topics:

- [Select the correct fax setup for your home or office](#)
- [Case A: Separate fax line \(no voice calls received\)](#)
- [Case B: Set up the printer with DSL](#)
- [Case C: Set up the printer with a PBX phone system or an ISDN line](#)
- [Case D: Fax with a distinctive ring service on the same line](#)
- [Case E: Shared voice/fax line](#)
- [Case F: Shared voice/fax line with voice mail](#)
- [Case G: Fax line shared with computer modem \(no voice calls received\)](#)
- [Case H: Shared voice/fax line with computer modem](#)
- [Case I: Shared voice/fax line with answering machine](#)
- [Case J: Shared voice/fax line with computer modem and answering machine](#)
- [Case K: Shared voice/fax line with computer dial-up modem and voice mail](#)

Select the correct fax setup for your home or office

To fax successfully, you need to know what types of equipment and services (if any) share the same phone line with the printer. This is important because you might need to connect some of your existing office equipment directly to the printer, and you might also need to change some fax settings before you can fax successfully.

1. Determine if your telephone system is serial or parallel (see [Set up faxing \(parallel phone systems\)](#)).
 - a. Serial-type telephone system — See [Serial-type fax setup](#).
 - b. Parallel-type telephone system — Go to step 2.
2. Select the combination of equipment and services sharing your fax line.
 - DSL: A Digital subscriber line (DSL) service through your telephone company. (DSL might be called ADSL in your country/region.)
 - PBX: A private branch exchange (PBX) phone system or an integrated services digital network (ISDN) system.
 - Distinctive ring service: A distinctive ring service through your telephone company provides multiple telephone numbers with different ring patterns.
 - Voice calls: Voice calls are received at the same phone number you use for fax calls on the printer.

- Computer dial-up modem: A computer dial-up modem is on the same phone line as the printer. If you answer Yes to any of the following questions, you are using a computer dial-up modem:
 - Do you send and receive faxes directly to and from your computer software applications through a dial-up connection?
 - Do you send and receive email messages on your computer through a dial-up connection?
 - Do you access the Internet from your computer through a dial-up connection?
 - Answering machine: An answering machine that answers voice calls at the same phone number you use for fax calls on the printer.
 - Voice mail service: A voice mail subscription through your telephone company at the same number you use for fax calls on the printer.
3. From the following table, select the combination of equipment and services applicable to your home or office setting. Then look up the recommended fax setup. Step-by-step instructions are included for each case in the sections that follow.

 **NOTE:** If your home or office setup is not described in this section, set up the printer as you would a regular analog phone. Make sure you use the phone cord supplied in the box to connect one end to your telephone wall jack and the other end to the port labeled 1-LINE on the back of the printer. If you use another phone cord, you might experience problems sending and receiving faxes.

You might need to connect the supplied phone cord to the adapter provided for your country/region.

Other equipment or services sharing your fax line							Recommended fax setup
DSL	PBX	Distinctive ring service	Voice calls	Computer dial-up modem	Answering machine	Voice mail service	
							Case A: <u>Separate fax line (no voice calls received)</u>
✓							Case B: <u>Set up the printer with DSL</u>
	✓						Case C: <u>Set up the printer with a PBX phone system or an ISDN line</u>
		✓					Case D: <u>Fax with a distinctive ring service on the same line</u>
			✓				Case E: <u>Shared voice/fax line</u>
			✓			✓	Case F: <u>Shared voice/fax line with voice mail</u>
				✓			Case G: <u>Fax line shared with</u>

(continued)

Other equipment or services sharing your fax line							Recommended fax setup
DSL	PBX	Distinctive ring service	Voice calls	Computer dial-up modem	Answering machine	Voice mail service	
							<u>computer modem (no voice calls received)</u>
			✓	✓			<u>Case H: Shared voice/fax line with computer modem</u>
			✓		✓		<u>Case I: Shared voice/fax line with answering machine</u>
			✓	✓	✓		<u>Case J: Shared voice/fax line with computer modem and answering machine</u>
			✓	✓		✓	<u>Case K: Shared voice/fax line with computer dial-up modem and voice mail</u>

Case A: Separate fax line (no voice calls received)

If you have a separate phone line on which you receive no voice calls, and you have no other equipment connected on this phone line, set up the printer as described in this section.

Back view of the printer

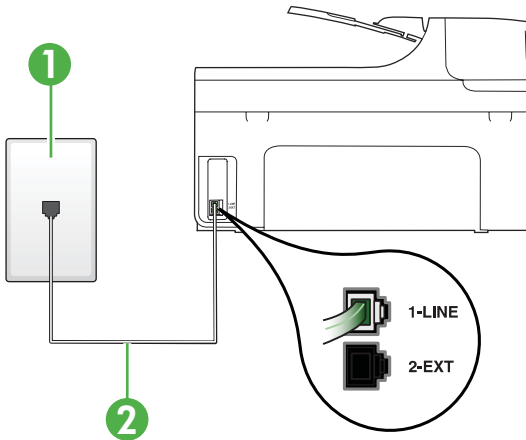

1	Telephone wall jack
2	Use the phone cord supplied in the box with the printer to connect to the 1-LINE port You might need to connect the supplied phone cord to the adapter provided for your country/region.

To set up the printer with a separate fax line

- Using the phone cord supplied in the box with the printer, connect one end to your telephone wall jack, then connect the other end to the port labeled 1-LINE on the back of the printer.

 **NOTE:** You might need to connect the supplied phone cord to the adapter provided for your country/region.

If you do not use the supplied cord to connect from the telephone wall jack to the printer, you might not be able to fax successfully. This special phone cord is different from the phone cords you might already have in your home or office.

- Turn on the **Auto Answer** setting.
- (Optional) Change the **Rings to Answer** setting to the lowest setting (two rings).
- Run a fax test.

When the phone rings, the printer answers automatically after the number of rings you set in the **Rings to Answer** setting. The printer begins emitting fax reception tones to the sending fax machine and receives the fax.

Case B: Set up the printer with DSL

If you have a DSL service through your telephone company, and do not connect any equipment to the printer, use the instructions in this section to connect a DSL filter between the telephone wall jack and the printer. The DSL filter removes the digital signal that can interfere with the printer, so the printer can communicate correctly with the phone line. (DSL might be called ADSL in your country/region.)

 **NOTE:** If you have a DSL line and you do not connect the DSL filter, you cannot send and receive faxes with the printer.

Back view of the printer

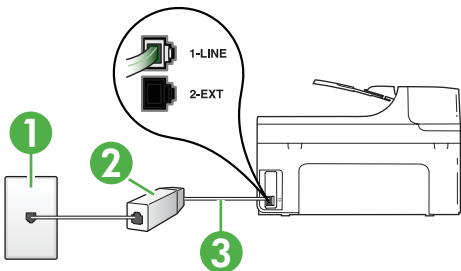

1	Telephone wall jack
2	DSL (or ADSL) filter and cord supplied by your DSL provider
3	Use the phone cord supplied in the box with the printer to connect to the 1-LINE port

You might need to connect the supplied phone cord to the adapter provided for your country/region.
--

To set up the printer with DSL

1. Obtain a DSL filter from your DSL provider.
2. Using the phone cord supplied in the box with the printer, connect one end to the open port on the DSL filter, and then connect the other end to the port labeled 1-LINE on the back of the printer.

 **NOTE:** You might need to connect the supplied phone cord to the adapter provided for your country/region.

If you do not use the supplied cord to connect from the DSL filter to the printer, you might not be able to fax successfully. This special phone cord is different from the phone cords you might already have in your home or office.

As only one phone cord is supplied, you might need to obtain additional phone cords for this setup.

-
3. Connect an additional phone cord from the DSL filter to the telephone wall jack.
 4. Run a fax test.

If you encounter problems setting up the printer with optional equipment, contact your local service provider or vendor for further assistance.

Case C: Set up the printer with a PBX phone system or an ISDN line

If you are using either a PBX phone system or an ISDN converter/terminal adapter, make sure you do the following:

- If you are using either a PBX or an ISDN converter/terminal adaptor, connect the printer to the port that is designated for fax and phone use. Also, make sure that the terminal adapter is set to the correct switch type for your country/region, if possible.

 **NOTE:** Some ISDN systems allow you to configure the ports for specific phone equipment. For example, you might have assigned one port for telephone and Group 3 fax and another port for multiple purposes. If you have problems when connected to the fax/phone port of your ISDN converter, try using the port designated for multiple purposes; it might be labeled "multi-combi" or something similar.

- If you are using a PBX phone system, set the call waiting tone to "off."

 **NOTE:** Many digital PBX systems include a call-waiting tone that is set to "on" by default. The call waiting tone interferes with any fax transmission, and you cannot send or receive faxes with the printer. Refer to the documentation that came with your PBX phone system for instructions on how to turn off the call-waiting tone.

-
- If you are using a PBX phone system, dial the number for an outside line before dialing the fax number.
 - Make sure you use the supplied cord to connect from the telephone wall jack to the printer. If you do not, you might not be able to fax successfully. This special phone cord is different from the phone cords you might already have in your home or office. If the supplied phone cord is too short, you can purchase a coupler from your local electronics store and extend it. You might need to connect the supplied phone cord to the adapter provided for your country/region.

If you encounter problems setting up the printer with optional equipment, contact your local service provider or vendor for further assistance.

Case D: Fax with a distinctive ring service on the same line

If you subscribe to a distinctive ring service (through your telephone company) that allows you to have multiple phone numbers on one phone line, each with a different ring pattern, set up the printer as described in this section.

Back view of the printer

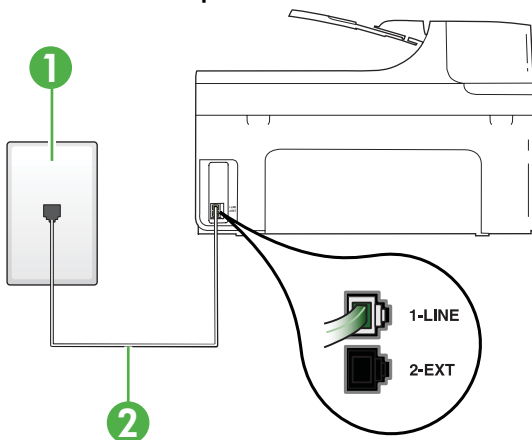

1	Telephone wall jack
2	Use the phone cord supplied in the box with the printer to connect to the 1-LINE port You might need to connect the supplied phone cord to the adapter provided for your country/region.

To set up the printer with a distinctive ring service

- Using the phone cord supplied in the box with the printer, connect one end to your telephone wall jack, then connect the other end to the port labeled 1-LINE on the back of the printer.

 **NOTE:** You might need to connect the supplied phone cord to the adapter provided for your country/region.

If you do not use the supplied cord to connect from the telephone wall jack to the printer, you might not be able to fax successfully. This special phone cord is different from the phone cords you might already have in your home or office.

- Turn on the **Auto Answer** setting.
- Change the **Distinctive Ring** setting to match the pattern that the telephone company assigned to your fax number.

 **NOTE:** By default, the printer is set to answer all ring patterns. If you do not set the **Distinctive Ring** to match the ring pattern assigned to your fax number, the printer might answer both voice calls and fax calls or it might not answer at all.

 **TIP:** You can also use the Ring Pattern Detection feature in the printer's control panel to set distinctive ring. With this feature, the printer recognizes and records the ring pattern of an incoming call and, based on this call, automatically determines the distinctive ring pattern assigned by your telephone company to fax calls. For more information, see [Change the answer ring pattern for distinctive ring](#).

4. (Optional) Change the **Rings to Answer** setting to the lowest setting (two rings).
5. Run a fax test.

The printer automatically answers incoming calls that have the ring pattern you selected (**Distinctive Ring** setting) after the number of rings you selected (**Rings to Answer** setting). The printer begins emitting fax reception tones to the sending fax machine and receives the fax.

If you encounter problems setting up the printer with optional equipment, contact your local service provider or vendor for further assistance.

Case E: Shared voice/fax line

If you receive both voice calls and fax calls at the same phone number, and you have no other office equipment (or voice mail) on this phone line, set up the printer as described in this section.

Back view of the printer

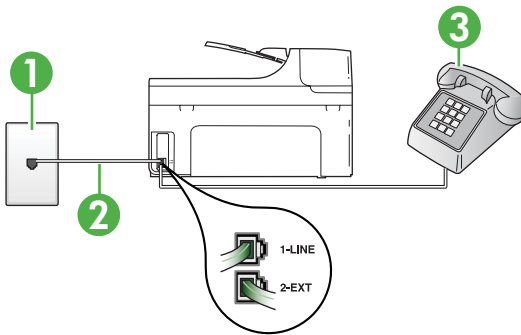

1	Telephone wall jack
2	Use the phone cord supplied in the box with the printer to connect to the 1-LINE port You might need to connect the supplied phone cord to the adapter provided for your country/region.
3	Telephone (optional)

To set up the printer with a shared voice/fax line

1. Using the phone cord supplied in the box with the printer, connect one end to your telephone wall jack, then connect the other end to the port labeled 1-LINE on the back of the printer.

 **NOTE:** You might need to connect the supplied phone cord to the adapter provided for your country/region.

If you do not use the supplied cord to connect from the telephone wall jack to the printer, you might not be able to fax successfully. This special phone cord is different from the phone cords you might already have in your home or office.

2. Do one of the following:
 - If you have a parallel-type phone system, remove the white plug from the port labeled 2-EXT on the back of the printer, and then connect a phone to this port.
 - If you have a serial-type phone system, you might plug your phone directly on top of the printer cable which has a wall plug attached to it.

3. Now you need to decide how you want the printer to answer calls, automatically or manually:
 - If you set up the printer to answer calls **automatically**, it answers all incoming calls and receives faxes. The printer cannot distinguish between fax and voice calls in this case; if you suspect the call is a voice call, you need to answer it before the printer answers the call. To set up the printer to answer calls automatically, turn on the **Auto Answer** setting.
 - If you set up the printer to answer faxes **manually**, you must be available to respond in person to incoming fax calls or the printer cannot receive faxes. To set up the printer to answer calls manually, turn off the **Auto Answer** setting.
4. Run a fax test.

If you pick up the phone before the printer answers the call and hear fax tones from a sending fax machine, you need to answer the fax call manually.

If you encounter problems setting up the printer with optional equipment, contact your local service provider or vendor for further assistance.

Case F: Shared voice/fax line with voice mail

If you receive both voice calls and fax calls at the same phone number, and you also subscribe to a voice mail service through your telephone company, set up the printer as described in this section.

 **NOTE:** You cannot receive faxes automatically if you have a voice mail service at the same phone number you use for fax calls. You must receive faxes manually; this means you must be available to respond in person to incoming fax calls. If you want to receive faxes automatically instead, contact your telephone company to subscribe to a distinctive ring service, or to obtain a separate phone line for faxing.

Back view of the printer

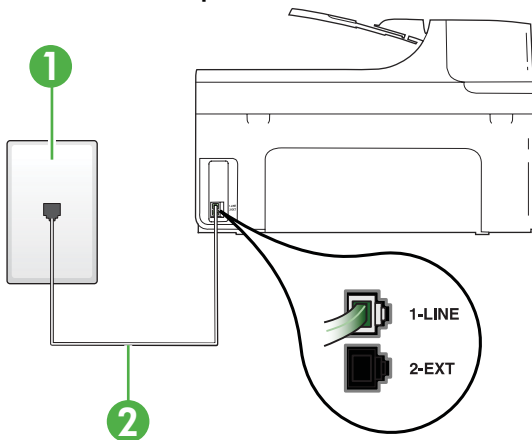

1	Telephone wall jack
2	Use the phone cord supplied in the box with the printer to connect to the "1-LINE" port You might need to connect the supplied phone cord to the adapter provided for your country/region.

To set up the printer with voice mail

1. Using the phone cord supplied in the box with the printer, connect one end to your telephone wall jack, then connect the other end to the port labeled 1-LINE on the back of the printer. You might need to connect the supplied phone cord to the adapter provided for your country/region.

 **NOTE:** You might need to connect the supplied phone cord to the adapter provided for your country/region.

If you do not use the supplied cord to connect from the telephone wall jack to the printer, you might not be able to fax successfully. This special phone cord is different from the phone cords you might already have in your home or office.

2. Turn off the **Auto Answer** setting.
3. Run a fax test.

You must be available to respond in person to incoming fax calls, or the printer cannot receive faxes. You must initiate the manual fax before voicemail picks up the line.

If you encounter problems setting up the printer with optional equipment, contact your local service provider or vendor for further assistance.

Case G: Fax line shared with computer modem (no voice calls received)

If you have a fax line on which you receive no voice calls, and you also have a computer modem connected on this line, set up the printer as described in this section.

 **NOTE:** If you have a computer dial-up modem, your computer dial-up modem shares the phone line with the printer. You cannot use both your modem and the printer simultaneously. For example, you cannot use the printer for faxing while you are using your computer dial-up modem to send an email or access the Internet.

- [Set up the printer with a computer dial-up modem](#)
- [Set up the printer with a computer DSL/ADSL modem](#)

Set up the printer with a computer dial-up modem

If you are using the same phone line for sending faxes and for a computer dial-up modem, follow these directions for setting up the printer.

Back view of the printer

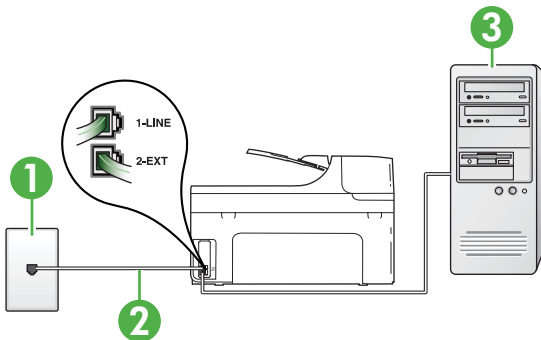

1	Telephone wall jack
2	Use the phone cord supplied in the box with the printer to connect to the "1-LINE" port You might need to connect the supplied phone cord to the adapter provided for your country/region.
3	Computer with modem

To set up the printer with a computer dial-up modem

1. Remove the white plug from the port labeled 2-EXT on the back of the printer.
2. Find the phone cord that connects from the back of your computer (your computer dial-up modem) to a telephone wall jack. Disconnect the cord from the telephone wall jack and plug it into the port labeled 2-EXT on the back of the printer.
3. Using the phone cord supplied in the box with the printer, connect one end to your telephone wall jack, then connect the other end to the port labeled 1-LINE on the back of the printer.



NOTE: You might need to connect the supplied phone cord to the adapter provided for your country/region.

If you do not use the supplied cord to connect from the telephone wall jack to the printer, you might not be able to fax successfully. This special phone cord is different from the phone cords you might already have in your home or office.

4. If your modem software is set to receive faxes to your computer automatically, turn off that setting.



NOTE: If you do not turn off the automatic fax reception setting in your modem software, the printer cannot receive faxes.

5. Turn on the **Auto Answer** setting.
6. (Optional) Change the **Rings to Answer** setting to the lowest setting (two rings).
7. Run a fax test.

When the phone rings, the printer automatically answers after the number of rings you set in the **Rings to Answer** setting. The printer begins emitting fax reception tones to the sending fax machine and receives the fax.

If you encounter problems setting up the printer with optional equipment, contact your local service provider or vendor for further assistance.

Set up the printer with a computer DSL/ADSL modem

If you have a DSL line and use that phone line to send faxes, follow these instructions to set up your fax.

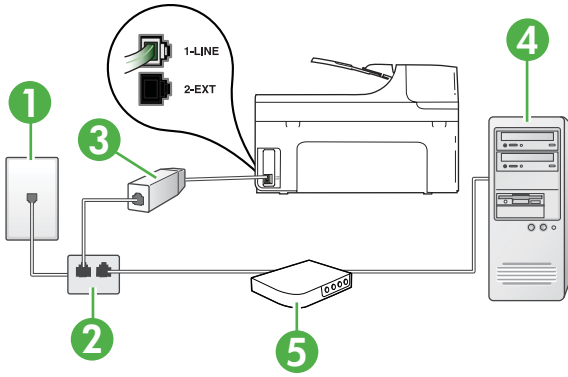

1	Telephone wall jack
2	Parallel splitter
3	DSL/ADSL filter Connect one end of the phone jack that was supplied with the printer to connect to the 1-LINE port on the back of the printer. Connect the other end of the cord to the DSL/ADSL filter. You might need to connect the supplied phone cord to the adapter provided for your country/region.
4	Computer
5	Computer DSL/ADSL modem

 **NOTE:** You need to purchase a parallel splitter. A parallel splitter has one RJ-11 port on the front and two RJ-11 ports on the back. Do not use a 2-line phone splitter, a serial splitter, or a parallel splitter which has two RJ-11 ports on the front and a plug on the back.



To set up the printer with a computer DSL/ADSL modem

1. Obtain a DSL filter from your DSL provider.
2. Using the phone cord provided in the box with the printer, connect one end to the DSL filter, and then connect the other end to the port labeled 1-LINE on the back of the printer.



NOTE: You might need to connect the supplied phone cord to the adapter provided for your country/region.

If you do not use the supplied cord to connect from the DSL filter to the back of the printer, you might not be able to fax successfully. This special phone cord is different from the phone cords you might already have in your home or office.

3. Connect the DSL filter to the parallel splitter.
4. Connect the DSL modem to the parallel splitter.
5. Connect the parallel splitter to the wall jack.
6. Run a fax test.

When the phone rings, the printer automatically answers after the number of rings you set in the **Rings to Answer** setting. The printer begins emitting fax reception tones to the sending fax machine and receives the fax.

If you encounter problems setting up the printer with optional equipment, contact your local service provider or vendor for further assistance.

Case H: Shared voice/fax line with computer modem

There are two different ways to set up the printer with your computer based on the number of phone ports on your computer. Before you begin, check your computer to see if it has one or two phone ports.



NOTE: If your computer has only one phone port, you need to purchase a parallel splitter (also called a coupler), as shown in the illustration. (A parallel splitter has one RJ-11 port on the front and two RJ-11 ports on the back. Do not use a two-line phone splitter, a serial splitter, or a parallel splitter which has two RJ-11 ports on the front and a plug on the back.)

- [Shared voice/fax with computer dial-up modem](#)
- [Shared voice/fax with computer DSL/ADSL modem](#)

Shared voice/fax with computer dial-up modem

If you use your phone line for both fax and telephone calls, use these instructions to set up your fax.

There are two different ways to set up the printer with your computer based on the number of phone ports on your computer. Before you begin, check your computer to see if it has one or two phone ports.



NOTE: If your computer has only one phone port, you need to purchase a parallel splitter (also called a coupler), as shown in the illustration. (A parallel splitter has one RJ-11 port on the front and two RJ-11 ports on the back. Do not use a two-line phone splitter, a serial splitter, or a parallel splitter which has two RJ-11 ports on the front and a plug on the back.)

Example of a parallel splitter



To set up the printer on the same phone line as a computer with two phone ports

Back view of the printer

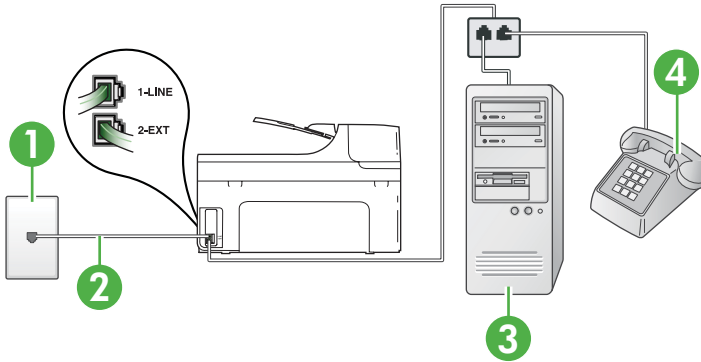

1	Telephone wall jack
2	Use the phone cord supplied in the box with the printer to connect to the 1-LINE port. You might need to connect the supplied phone cord to the adapter provided for your country/region.
3	Computer with modem
4	Telephone

1. Remove the white plug from the port labeled 2-EXT on the back of the printer.
2. Find the phone cord that connects from the back of your computer (your computer dial-up modem) to a telephone wall jack. Disconnect the cord from the telephone wall jack and plug it into the port labeled 2-EXT on the back of the printer.
3. Connect a phone to the "OUT" port on the back of your computer dial-up modem.
4. Using the phone cord supplied in the box with the printer, connect one end to your telephone wall jack, then connect the other end to the port labeled 1-LINE on the back of the printer.

 **NOTE:** You might need to connect the supplied phone cord to the adapter provided for your country/region.

If you do not use the supplied cord to connect from the telephone wall jack to the printer, you might not be able to fax successfully. This special phone cord is different from the phone cords you might already have in your home or office.

5. If your modem software is set to receive faxes to your computer automatically, turn off that setting.

 **NOTE:** If you do not turn off the automatic fax reception setting in your modem software, the printer cannot receive faxes.

6. Now you need to decide how you want the printer to answer calls, automatically or manually:
 - If you set up the printer to answer calls **automatically**, it answers all incoming calls and receives faxes. The printer cannot distinguish between fax and voice calls in this case; if you suspect the call is a voice call, you need to answer it before the printer answers the call. To set up the printer to answer calls automatically, turn on the **Auto Answer** setting.
 - If you set up the printer to answer faxes **manually**, you must be available to respond in person to incoming fax calls or the printer cannot receive faxes. To set up the printer to answer calls manually, turn off the **Auto Answer** setting.
7. Run a fax test.

If you pick up the phone before the printer answers the call and hear fax tones from a sending fax machine, you need to answer the fax call manually.

If you use your phone line for voice, fax, and your computer dial-up modem, follow these directions to set up your fax.

If you encounter problems setting up the printer with optional equipment, contact your local service provider or vendor for further assistance.

Shared voice/fax with computer DSL/ADSL modem

Use these instructions if your computer has a DSL/ADSL modem

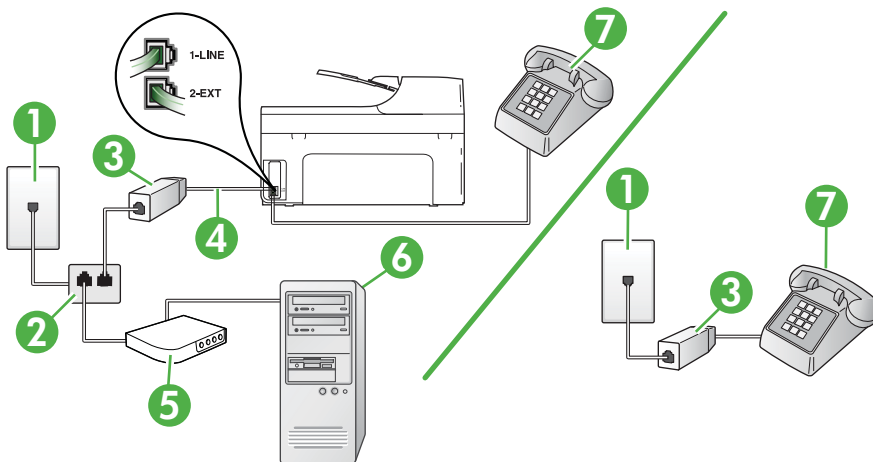

1	Telephone wall jack
2	Parallel splitter
3	DSL/ADSL filter
4	Phone cord supplied with the printer You might need to connect the supplied phone cord to the adapter provided for your country/region.
5	DSL/ADSL modem
6	Computer
7	Telephone

 **NOTE:** You need to purchase a parallel splitter. A parallel splitter has one RJ-11 port on the front and two RJ-11 ports on the back. Do not use a 2-line phone splitter, a serial splitter, or a parallel splitter which has two RJ-11 ports on the front and a plug on the back.



To set up the printer with a computer DSL/ADSL modem

1. Obtain a DSL filter from your DSL provider.

 **NOTE:** Phones in other parts of the home/office sharing the same phone number with DSL service need to be connected to additional DSL filters to avoid noise when making voice calls.

2. Using the phone cord supplied in the box with the printers, connect one end to the DSL filter, then connect the other end to the port labeled 1-LINE on the back of the printer.

 **NOTE:** You might need to connect the supplied phone cord to the adapter provided for your country/region.

If you do not use the supplied cord to connect from the DSL filter to the printer, you might not be able to fax successfully. This special phone cord is different from phone cords you might already have in your home or office.

3. If you have a parallel-type phone system, remove the white plug from the port labeled 2-EXT on the back of the printer, and then connect a phone to this port.
4. Connect the DSL filter to the parallel splitter.
5. Connect the DSL modem to the parallel splitter.
6. Connect the parallel splitter to the wall jack.
7. Run a fax test.

When the phone rings, the printer automatically answers after the number of rings you set in the **Rings to Answer** setting. The printer begins emitting fax reception tones to the sending fax machine and receives the fax.

If you encounter problems setting up the printer with optional equipment, contact your local service provider or vendor for further assistance.

Case I: Shared voice/fax line with answering machine

If you receive both voice calls and fax calls at the same phone number, and you also have an answering machine that answers voice calls at this phone number, set up the printer as described in this section.

Back view of the printer

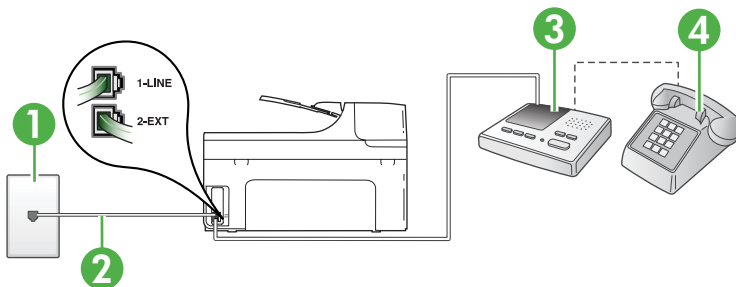

1	Telephone wall jack
2	Use the phone cord provided to connect to the 1-LINE port on the back of the printer You might need to connect the supplied phone cord to the adapter provided for your country/region.
3	Answering machine
4	Telephone (optional)

To set up the printer with a shared voice/fax line with answering machine

1. Remove the white plug from the port labeled 2-EXT on the back of the printer.
2. Unplug your answering machine from the telephone wall jack, and connect it to the port labeled 2-EXT on the back of the printer.

 **NOTE:** If you do not connect your answering machine directly to the printer, fax tones from a sending fax machine might be recorded on your answering machine, and you might not receive faxes with the printer.

3. Using the phone cord supplied in the box with the printer, connect one end to your telephone wall jack, then connect the other end to the port labeled 1-LINE on the back of the printer.

 **NOTE:** You might need to connect the supplied phone cord to the adapter provided for your country/region.
If you do not use the supplied cord to connect from the telephone wall jack to the printer, you might not be able to fax successfully. This special phone cord is different from the phone cords you might already have in your home or office.

4. (Optional) If your answering machine does not have a built-in phone, for convenience you might want to connect a phone to the back of your answering machine at the "OUT" port.

 **NOTE:** If your answering machine does not let you connect an external phone, you can purchase and use a parallel splitter (also known as a coupler) to connect both the answering machine and telephone to the printer. You can use standard phone cords for these connections.

5. Turn on the **Auto Answer** setting.
6. Set your answering machine to answer after a low number of rings.
7. Change the **Rings to Answer** setting on the printer to the maximum number of rings supported by your printer. (The maximum number of rings varies by country/region.)
8. Run a fax test.

When the phone rings, your answering machine answers after the number of rings you have set, and then plays your recorded greeting. The printer monitors the call during this time, "listening" for fax tones. If incoming fax tones are detected, the printer emits fax reception tones and receives the fax; if there are no fax tones, the printer stops monitoring the line and your answering machine can record a voice message.

If you encounter problems setting up the printer with optional equipment, contact your local service provider or vendor for further assistance.

Case J: Shared voice/fax line with computer modem and answering machine

If you receive both voice calls and fax calls at the same phone number, and you also have a computer modem and answering machine connected on this phone line, set up the printer as described in this section.

 **NOTE:** Since your computer dial-up modem shares the phone line with the printer, you cannot use both your modem and the printer simultaneously. For example, you cannot use the printer for faxing while you are using your computer dial-up modem to send an email or access the Internet.

- [Shared voice/fax line with computer dial-up modem and answering machine](#)
- [Shared voice/fax line with computer DSL/ADSL modem and answering machine](#)

Shared voice/fax line with computer dial-up modem and answering machine

There are two different ways to set up the printer with your computer based on the number of phone ports on your computer. Before you begin, check your computer to see if it has one or two phone ports

 **NOTE:** If your computer has only one phone port, you need to purchase a parallel splitter (also called a coupler), as shown in the illustration. (A parallel splitter has one RJ-11 port on the front and two RJ-11 ports on the back. Do not use a two-line phone splitter, a serial splitter, or a parallel splitter which has two RJ-11 ports on the front and a plug on the back.)

Example of a parallel splitter



To set up the printer on the same phone line as a computer with two phone ports

Back view of the printer

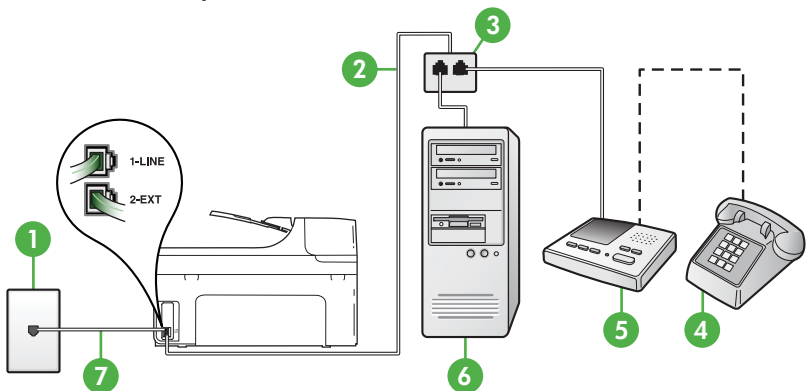

1	Telephone wall jack
2	"IN" phone port on your computer
3	"OUT" phone port on your computer
4	Telephone (optional)
5	Answering machine
6	Computer with modem
7	Use the phone cord supplied in the box with the printer to connect to the 1-LINE port. You might need to connect the supplied phone cord to the adapter provided for your country/region.

1. Remove the white plug from the port labeled 2-EXT on the back of the printer.
2. Find the phone cord that connects from the back of your computer (your computer dial-up modem) to a telephone wall jack. Disconnect the cord from the telephone wall jack and plug it into the port labeled 2-EXT on the back of the printer.
3. Unplug your answering machine from the telephone wall jack, and connect it to the port labeled "OUT" on the back of the computer (the computer dial-up modem).
4. Using the phone cord supplied in the box with the printer, connect one end to your telephone wall jack, then connect the other end to the port labeled 1-LINE on the back of the printer.

 **NOTE:** You might need to connect the supplied phone cord to the adapter provided for your country/region.

If you do not use the supplied cord to connect from the telephone wall jack to the printer, you might not be able to fax successfully. This special phone cord is different from the phone cords you might already have in your home or office.

- (Optional) If your answering machine does not have a built-in phone, for convenience you might want to connect a phone to the back of your answering machine at the "OUT" port.

 **NOTE:** If your answering machine does not let you connect an external phone, you can purchase and use a parallel splitter (also known as a coupler) to connect both the answering machine and telephone to the printer. You can use standard phone cords for these connections.

- If your modem software is set to receive faxes to your computer automatically, turn off that setting.

 **NOTE:** If you do not turn off the automatic fax reception setting in your modem software, the printer cannot receive faxes.

- Turn on the **Auto Answer** setting.
- Set your answering machine to answer after a low number of rings.
- Change the **Rings to Answer** setting on the printer to the maximum number of rings supported by the product. (The maximum number of rings varies by country/region.)
- Run a fax test.

When the phone rings, your answering machine answers after the number of rings you have set, and then plays your recorded greeting. The printer monitors the call during this time, "listening" for fax tones. If incoming fax tones are detected, the printer emits fax reception tones and receives the fax; if there are no fax tones, the printer stops monitoring the line and your answering machine can record a voice message.

If you encounter problems setting up the printer with optional equipment, contact your local service provider or vendor for further assistance.

Shared voice/fax line with computer DSL/ADSL modem and answering machine

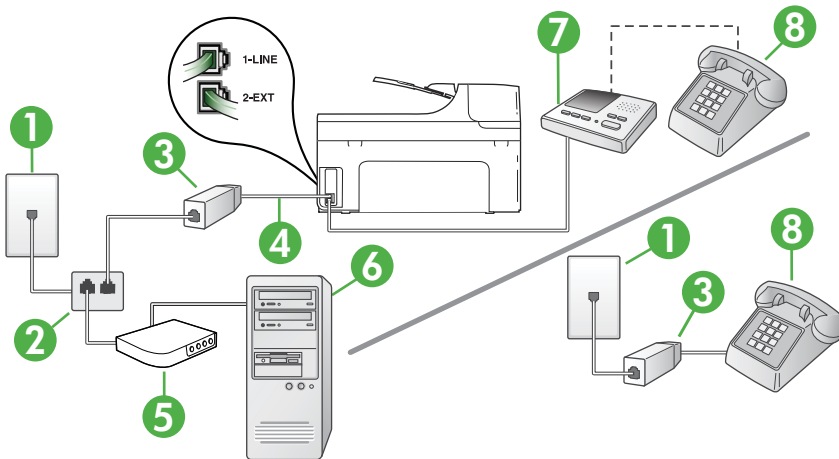

1	Telephone wall jack
2	Parallel splitter
3	DSL/ADSL filter

(continued)

4	Phone cord provided with the printer connected to the 1-LINE port on the back of the printer You might need to connect the supplied phone cord to the adapter provided for your country/region.
5	DSL/ADSL modem
6	Computer
7	Answering machine
8	Telephone (optional)

 **NOTE:** You need to purchase a parallel splitter. A parallel splitter has one RJ-11 port on the front and two RJ-11 ports on the back. Do not use a 2-line phone splitter, a serial splitter, or a parallel splitter which has two RJ-11 ports on the front and a plug on the back.



To set up the printer with a computer DSL/ADSL modem

1. Obtain a DSL/ADSL filter from your DSL/ADSL provider.

 **NOTE:** Phones in other parts of the home/office sharing the same phone number with DSL/ADSL service need to be connected to additional DSL/ADSL filters, to avoid noise when making voice calls.

2. Using the phone cord supplied in the box with the printer, connect one end to the DSL/ADSL filter, then connect the other end to the port labeled 1-LINE on the back of the printer.

 **NOTE:** You might need to connect the supplied phone cord to the adapter provided for your country/region.

If you do not use the supplied cord to connect from the DSL/ADSL filter to the printer, you might not be able to fax successfully. This special phone cord is different from the phone cords you might already have in your home or office.

3. Connect the DSL/ADSL filter to the splitter.
4. Unplug the answering machine from the telephone wall jack, and connect it to the port labeled 2-EXT on the back of the printer.

 **NOTE:** If you do not connect your answering machine directly to the printer, fax tones from a sending fax machine might be recorded on your answering machine, and you might not receive faxes with the printer.

5. Connect the DSL modem to the parallel splitter.
6. Connect the parallel splitter to the wall jack.
7. Set your answering machine to answer after a low number of rings.
8. Change your **Rings to Answer** setting on the printer to the maximum number of rings supported by the printer.

 **NOTE:** The maximum number of rings varies by country/region.

9. Run a fax test.

When the phone rings, your answering machine answers after the number of rings you have set, and then play your recorded greeting. The printer monitors the call during this time, "listening" for fax tones. If incoming fax tones are detected, the printer emits fax reception tones and receive the fax; if there are no fax tones, the printer stops monitoring the line and your answering machine can record a voice message.

If you use the same phone line for telephone, fax, and have a computer DSL modem, follow these instructions to set up your fax.

If you encounter problems setting up the printer with optional equipment, contact your local service provider or vendor for further assistance.

Case K: Shared voice/fax line with computer dial-up modem and voice mail

If you receive both voice calls and fax calls at the same phone number, use a computer dial-up modem on the same phone line, and subscribe to a voice mail service through your telephone company, set up the printer as described in this section.

 **NOTE:** You cannot receive faxes automatically if you have a voice mail service at the same phone number you use for fax calls. You must receive faxes manually; this means you must be available to respond in person to incoming fax calls. If you want to receive faxes automatically instead, contact your telephone company to subscribe to a distinctive ring service, or to obtain a separate phone line for faxing.

Since your computer dial-up modem shares the phone line with the printer, you cannot use both your modem and the printer simultaneously. For example, you cannot use the printer for faxing if you are using your computer dial-up modem to send an email or access the Internet.

There are two different ways to set up the printer with your computer based on the number of phone ports on your computer. Before you begin, check your computer to see if it has one or two phone ports.

- If your computer has only one phone port, you need to purchase a parallel splitter (also called a coupler), as shown in the illustration. (A parallel splitter has one RJ-11 port on the front and two RJ-11 ports on the back. Do not use a two-line phone splitter, a serial splitter, or a parallel splitter which has two RJ-11 ports on the front and a plug on the back.)

Example of a parallel splitter



- If your computer has two phone ports, set up the printer as follows:

Back view of the printer

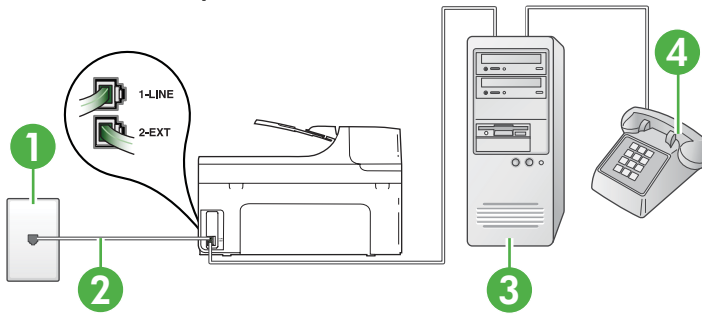

1	Telephone wall jack
2	Use the phone cord supplied in the box with the printer to connect to the 1-LINE port You might need to connect the supplied phone cord to the adapter provided for your country/region.
3	Parallel splitter
4	Computer with modem
5	Telephone

To set up the printer on the same phone line as a computer with two phone ports

1. Remove the white plug from the port labeled 2-EXT on the back of the printer.
2. Find the phone cord that connects from the back of your computer (your computer dial-up modem) to a telephone wall jack. Disconnect the cord from the telephone wall jack and plug it into the port labeled 2-EXT on the back of the printer.
3. Connect a phone to the "OUT" port on the back of your computer dial-up modem.
4. Using the phone cord supplied in the box with the printer, connect one end to your telephone wall jack, then connect the other end to the port labeled 1-LINE on the back of the printer.

 **NOTE:** You might need to connect the supplied phone cord to the adapter provided for your country/region.
If you do not use the supplied cord to connect from the telephone wall jack to the printer, you might not be able to fax successfully. This special phone cord is different from the phone cords you might already have in your home or office.

5. If your modem software is set to receive faxes to your computer automatically, turn off that setting.

 **NOTE:** If you do not turn off the automatic fax reception setting in your modem software, the printer cannot receive faxes.

6. Turn off the **Auto Answer** setting.
7. Run a fax test.

You must be available to respond in person to incoming fax calls, or the printer cannot receive faxes.

If you encounter problems setting up the printer with optional equipment, contact your local service provider or vendor for further assistance.

Serial-type fax setup

For information on setting up the printer for faxing using a serial-type phone system, see the Fax Configuration Web site for your country/region.

Austria	www.hp.com/at/faxconfig
Germany	www.hp.com/de/faxconfig
Switzerland (French)	www.hp.com/ch/fr/faxconfig
Switzerland (German)	www.hp.com/ch/de/faxconfig
United Kingdom	www.hp.com/uk/faxconfig
Finland	www.hp.fi/faxconfig
Denmark	www.hp.dk/faxconfig
Sweden	www.hp.se/faxconfig
Norway	www.hp.no/faxconfig
Netherlands	www.hp.nl/faxconfig
Belgium (Dutch)	www.hp.be/nl/faxconfig
Belgium (French)	www.hp.be/fr/faxconfig
Portugal	www.hp.pt/faxconfig
Spain	www.hp.es/faxconfig
France	www.hp.com/fr/faxconfig
Ireland	www.hp.com/ie/faxconfig
Italy	www.hp.com/it/faxconfig

Test fax setup

You can test your fax setup to check the status of the printer and to make sure it is set up correctly for faxing. Perform this test after you have completed setting up the printer for faxing. The test does the following:

- Tests the fax hardware
- Verifies the correct type of phone cord is connected to the printer
- Checks that the phone cord is plugged into the correct port
- Checks for a dial tone
- Checks for an active phone line
- Tests the status of your phone line connection

The printer prints a report with the results of the test. If the test fails, review the report for information on how to fix the problem and rerun the test.

To test fax setup via the printer control panel

1. Set up the printer for faxing according to your particular home or office setup instructions.
2. Make sure the ink cartridges are installed, and that full-size paper is loaded in the input tray before starting the test.
3. From the printer control panel, touch right arrow , and then select **Setup**.
4. Select **Tools**, and then select **Run Fax Test**.
The printer displays the status of the test on the display and prints a report.
5. Review the report.
 - If the test passes and you are still having problems faxing, check the fax settings listed in the report to verify the settings are correct. A blank or incorrect fax setting can cause problems faxing.
 - If the test fails, review the report for more information on how to fix any problems found.

D Network setup

You can manage network settings for the printer through the printer control panel as described in the next section. Additional advanced settings are available in the embedded Web server, a configuration and status tool you access from your Web browser using an existing network connection to the printer. For more information, see [Embedded Web server](#).

This section contains the following topics:

- [Change basic network settings](#)
- [Change advanced network settings](#)
- [Set up the printer for wireless communication](#)
- [Uninstall and reinstall the HP software](#)

Change basic network settings

The control-panel options enable you to set up and manage a wireless connection and to perform a variety of network management tasks. This includes viewing the network settings, restoring the network defaults, turning the wireless radio on and off, and changing the network settings.

This section contains the following topics:

- [View and print network settings](#)
- [Turn the wireless radio on and off](#)

View and print network settings

You can display a summary of the network settings on the printer control panel or the HP software that came with the printer. You can print a more detailed network configuration page, which lists all of the important network settings such as the IP address, link speed, DNS, and mDNS. For more information, see [Understand the network configuration page](#).

Turn the wireless radio on and off

The wireless radio is on by default, as indicated by the blue light on the front of the printer. In order to stay connected to a wireless network, the radio must stay on. However, if your printer is connected to a wired network or you have a USB connection, the radio is not used. In this case you might want to turn the radio off.

1. Touch right arrow , and then select **Network**.
2. Touch **Wireless**, select **Wireless Radio**, and then select **On** to turn the radio on, or **Off** to turn the radio off.

Change advanced network settings

△ **CAUTION:** Network settings are provided for your convenience. However, unless you are an advanced user, you should not change some of these settings (such as the link speed, IP settings, default gateway, and firewall settings).

This section contains the following topics:

- [Set link speed](#)
- [View IP settings](#)
- [Change IP settings](#)
- [Configure the printer's firewall settings](#)
- [Reset network settings](#)

Set link speed

You can change the speed at which data is transmitted over the network. The default is **Automatic**.

1. Touch right arrow , and then select **Network**.
2. Select **Advanced Setup**, then select **Link Speed**.
3. Touch the number next to the link speed that matches your network hardware:
 - 1. **Automatic**
 - 2. **10-Full**
 - 3. **10-Half**
 - 4. **100-Full**
 - 5. **100-Half**

View IP settings

To view the IP address of the printer:

- Print the network configuration page. For more information, see [Understand the network configuration page](#).
- Or, open the HP software (Windows), click the **Network Settings** tab, click the **Wired** or **Wireless** tab (depending on the current connection), and then click **IP Settings**.

Change IP settings

The default IP setting for the IP settings is **Automatic**, which sets the IP settings automatically. However, if you are an advanced user, you might want to manually change settings such as the IP address, subnet mask, or the default gateway.

 **CAUTION:** Be careful when manually assigning an IP address. If you enter an invalid IP address during the installation, your network components cannot connect with the printer.

1. Touch right arrow , and then select **Network**.
2. Select **Advanced Setup**, and then select **IP Settings**.
3. A message appears warning that changing the IP address removes the printer from the network. Touch **OK** to continue.
4. **Automatic** is selected by default. To change the settings manually, touch **Manual**.
5. Touch the IP setting:
 - **IP Address**
 - **Subnet Mask**
 - **Default Gateway**
6. Enter your changes, and then touch **Done**.

Configure the printer's firewall settings

Firewall features provide network-layer security on both IPv4 and IPv6 networks. The firewall provides simple control of IP addresses that are allowed access.

 **NOTE:** In addition to firewall protection at the network layer, the printer also supports an SNMPv3 agent at the application layer for management application security, and open secure sockets layer (SSL) standards at the transport layer for secure client-server applications, such as client-server authentication or HTTPS Web browsing.

For firewall operation on the printer, you must configure a firewall policy to apply to specified IP traffic. Firewall policy pages are accessed through the EWS and displayed by your Web browser. After a policy is configured, it is not activated until you click **Apply** in the EWS.

Creating and using firewall rules

Firewall rules allow you to control IP traffic. Use firewall rules to allow or drop IP traffic based on IP addresses and services.

Enter up to ten rules, each rule specifying the host addresses, services, and the action to take for those addresses and services.

This section contains the following topics:

- [Create a firewall rule](#)
- [Change the priority of firewall rules](#)
- [Change firewall options](#)
- [Reset firewall settings](#)
- [Limitations to rules, templates, and services](#)

Create a firewall rule

To create a firewall rule, complete the following steps:

1. Open the embedded Web server. For more information, see [Embedded Web server](#).
2. Click the **Settings** tab, click **Firewall Rules**.
3. Click **New**, and then follow the onscreen instructions.

Change the priority of firewall rules

To change the priority in which a firewall rule is used, complete the following steps:

1. Open the embedded Web server. For more information, see [Embedded Web server](#).
2. Click the **Settings** tab, click **Firewall Rules Priority**.
3. Select the priority in which you want the rule to be used from the **Rule Precedence** list, with 1 having the highest priority and 10 having the lowest priority.
4. Click **Apply**.

Change firewall options

To change firewall options for the printer, complete the following steps:

1. Open the embedded Web server. For more information, see [Embedded Web server](#).
2. Click the **Settings** tab, click **Firewall Options**.
3. Change any settings, and then click **Apply**.

 **NOTE:** After clicking **Apply**, the connection to the EWS might be temporarily disrupted for a short period of time. If the IP address was unchanged, the EWS connection will be enabled again. However, if the IP address was changed, use the new IP address to open the EWS.

Reset firewall settings

To reset the firewall settings to the factory defaults, restore the printer's network settings. For more information, see [To reset the printer's network settings](#).

Limitations to rules, templates, and services

When creating firewall rules, note the following limitations to rules, templates, and services.

Item	Limit
Maximum number of rules.	11
Maximum number of Address Templates.	12

(continued)

Item	Limit
<p>Note the following:</p> <ul style="list-style-type: none"> • All IP Addresses Results in two (2) address template rules. One for all IPv4 addresses, and another for all IPv6 addresses. • All non link local IPv6 Results in four (4) address template rules: <ul style="list-style-type: none"> ◦ :: to FE7F:FFFF:FFFF:FFFF:FFFF:FFF:FFFF for both local and remote addresses ◦ :: to FE7F:FFFF:FFFF:FFFF:FFFF:FFF:FFFF for local addresses ◦ FE81:: to FFFF:FFFF:FFFF:FFFF:FFFF:FFF:FFFF for remote addresses ◦ FE81:: to FFFF:FFFF:FFFF:FFFF:FFFF:FFF:FFFF for local addresses, ◦ :: to FE7F:FFFF:FFFF:FFFF:FFFF:FFF:FFFF for remote addresses ◦ FE81:: to FFFF:FFFF:FFFF:FFFF:FFFF:FFF:FFFF for both local and remote addresses • All Broadcast/Multicast Addresses Results in four (4) address template rules: <ul style="list-style-type: none"> ◦ 224.0.0.0 to 239.255.255.255 IPv4 local addresses and all IPv4 remote addresses ◦ A single IPv4 local address, and all IPv4 remote addresses ◦ 255.255.255.255 local address, and all IPv4 remote addresses ◦ FF00:: / 8 local IPv6 addresses, and all IPv6 remote addresses <p>NOTE: To avoid multiple rules for these predefined address templates, you can create custom address templates.</p>	
Maximum number of user-defined address templates.	5
<p>Maximum number of services you can add to a user-defined service template.</p> <p>NOTE: The predefined All Services template is not subject to this limitation and includes all services supported by the print server.</p>	64
Maximum number of services you can add to the policy.	64

(continued)

Item	Limit
For example, if a user-defined service template consists of 64 services, then it is the only service template you can use.	
Maximum number of service templates in the policy.	10
Maximum number of user-defined custom service templates.	5

Reset network settings

To reset the administrator password and network settings, complete the following steps:

1. Touch right arrow , and then select **Network**.
2. Touch **Restore Network Defaults**, and then select **Yes**.

 **NOTE:** Print the network configuration page and verify that the network settings have been reset. For more information, see [Understand the network configuration page](#).

By default, the network name (SSID) is “hpsetup” and the communication mode is “ad hoc.”

NOTE: Resetting the printer’s network settings also resets the printer’s firewall settings. For more information about configuring the printer’s firewall settings, see [Configure the printer’s firewall settings](#).

Set up the printer for wireless communication

You may set up the printer for wireless communication.

 **NOTE:** If you encounter problems, see [Solve wireless problems](#).

Make sure the printer is not connected to the network using a network cable.

The sending device must have built-in 802.11 capabilities or an 802.11 wireless card installed.

The printer and the computers that use it must be on the same subnet.

Before installing the HP software, you might want to find out the settings of your network. Obtain the information from your system administrators, or complete the following tasks:

- Obtain your network’s network name or Service Set Identifier (SSID) and communication mode (infrastructure or ad hoc) from the configuration utility for the network’s wireless access point (WAP) or the computer’s network card.
- Find out the type of encryption your network uses, such as Wired Equivalent Privacy (WEP).
- Find out the security password or encryption key of the wireless device.

This section contains the following topics:

- [To set up a wireless communication using the Wireless Setup Wizard](#)
- [Understand 802.11 wireless network settings](#)
- [Test the wireless connection](#)
- [Change the connection method](#)
- [Guidelines for ensuring wireless network security](#)
- [Guidelines for reducing interference on a wireless network](#)

To set up a wireless communication using the Wireless Setup Wizard

The Wireless Setup Wizard provides an easy way to set up and manage a wireless connection (both infrastructure and ad hoc connections) to your printer.

 **NOTE:** To connect to an infrastructure network, you must have a wireless network set up and running.

1. Set up the printer hardware. See the getting started guide or the setup poster that came with your printer.
 2. On the printer control panel, touch right arrow , and then select **Network**.
 3. Touch **Wireless**, select **Wireless Setup Wizard**, and then touch **OK**.
 4. Follow the display instructions to complete the setup.
-

 **NOTE:** If you cannot find the network name (SSID) and WPA key or WEP passphrase, contact your network administrator or the person who set up the wireless network.

NOTE: If you want to connect the printer using an ad hoc connection, connect your computer to the network name (SSID) "hpsetup". (This network name is the default, ad hoc network created by the printer.) If your printer was previously configured for a different network, you can restore the network defaults to enable the printer to use "hpsetup". To restore network defaults, see [Reset network settings](#).

Understand 802.11 wireless network settings

Network name (SSID)

By default, the printer looks for the wireless network name or SSID named "hpsetup." Your network may have a different SSID.

Communication mode

There are two communication mode options:

- **Ad hoc:** On an ad hoc network, the printer is set to ad hoc communication mode and communicates directly with other wireless devices without the use of a WAP. All devices on the ad hoc network must:
 - Be 802.11 compatible
 - Have ad hoc as the communication mode
 - Have the same network name (SSID)
 - Be on the same subnet and same channel
 - Have the same 802.11 security settings
- **Infrastructure (recommended):** On an infrastructure network, the printer is set to infrastructure communication mode and communicates with other devices on the network, whether the devices are wired or wireless, through a WAP. WAPs commonly act as routers or gateways on small networks.

Security settings

- **Network authentication:** The printer's factory default setting is 'Open,' which does not require security for authorization or encryption. The other possible values are 'OpenThenShared,' 'Shared,' and 'WPA-PSK' (Wi-Fi® Protected Access Pre-Shared Key). WPA increases the level of over-the-air data protection and access control on existing and future Wi-Fi networks. It addresses all known weaknesses of WEP, the original native security mechanism in the 802.11 standard.

WPA2 is the second generation of WPA security; it provides enterprise and consumer Wi-Fi users with a high level of assurance that only authorized users can access their wireless networks.

- **Data encryption:**
 - Wired Equivalent Privacy (WEP) provides security by encrypting data sent over radio waves from one wireless device to another wireless device. Devices on a WEP-enabled network use WEP keys to encode data. If your network uses WEP, you must know the WEP key(s) it uses.



NOTE: Shared WEP key encryption is not supported.

- WPA uses the Temporal Key Integrity Protocol (TKIP) for encryption and employs 802.1X authentication with one of the standard Extensible Authentication Protocol (EAP) types available today.
- WPA2 provides a new encryption scheme, the Advanced Encryption Standard (AES). AES is defined in counter cipher-block chaining mode (CCM) and supports the Independent Basic Service Set (IBSS) to enable security between client workstations operating in ad hoc mode.

Test the wireless connection

Print the wireless test page for information about the printer's wireless connection. The wireless test page provides information about the printer's status, MAC address, and IP address. If the printer is connected to a network, the test page displays details about the network settings.

1. Touch right arrow , and then select **Network**.
2. Touch **Wireless**, and then select **Wireless Network Test**.

Change the connection method

If you have installed the HP software and connected your printer using a USB, Ethernet, or wireless connection, you can change to a different connection any time you want.



NOTE: If you are changing to a wireless connection, make sure that an Ethernet cable has not been connected to the printer. Connecting an Ethernet cable turns off the printer's wireless capabilities.

To change the connection method (Windows)



NOTE: If you are changing to a wireless connection, make sure that an Ethernet cable has not been connected to the printer. Connecting an Ethernet cable turns off the printer's wireless capabilities.

1. On the computer desktop, click **Start**, select **Programs** or **All Programs**, click **HP**, select your printer name, and then click **Connect a New Printer**.
2. Follow the onscreen instructions.

To change the connection method (Mac OS X)

1. Open the HP Utility. For more information, see [HP Utility \(Mac OS X\)](#).
2. Click the **Application** icon on the toolbar.
3. Double-click **HP Setup Assistant**, and then follow the onscreen instructions.

Guidelines for ensuring wireless network security

This section contains the following topics:

- [To add hardware addresses to a WAP](#)
- [Other guidelines](#)

To add hardware addresses to a WAP

MAC filtering is a security feature in which a WAP is configured with a list of MAC addresses (also called "hardware addresses") of devices that are allowed to gain access to the network through the WAP.

If the WAP does not have the hardware address of a device attempting to access the network, the WAP denies the device access to the network.

If the WAP filters MAC addresses, then the printer's MAC address must be added to the WAP's list of accepted MAC addresses.

1. Print the network configuration page. For information on the network configuration page, see [Understand the network configuration page](#).
2. Open the WAP's configuration utility, and add the printer's hardware address to the list of accepted MAC addresses.

Other guidelines

To keep the wireless network secure, follow these guidelines:

- Use a password with at least 20 random characters. You can use up to 64 characters in a WPA password.
- Avoid any common words or phrases, easy sequences of characters (such as all 1s), and personally-identifiable information for passwords. Always use random strings composed of uppercase and lowercase letters, numbers, and if allowed, special characters such as punctuation.
- Change the password periodically.
- Change the default password provided by the manufacturer for administrator access to the access point or wireless router. Some routers let you change the administrator name as well.
- Turn off administrative access over wireless if possible. If you do this, you need to connect to the router with a wired Ethernet connection when you want to make configuration changes.
- Turn off remote administrative access over the Internet on your router, if possible. You can use Remote Desktop to make an encrypted connection to a computer running behind your router and make configuration changes from the local computer you are accessing over the Internet.
- To avoid accidentally connecting to another party's wireless network, turn off the setting to automatically connect to non-preferred networks. This is disabled by default in Windows XP.

Guidelines for reducing interference on a wireless network

The following tips will help reduce the chances for interference in a wireless network:

- Keep the wireless devices away from large metal objects, such as filing cabinets, and other electromagnetic devices, such as microwaves and cordless telephones, as these objects can disrupt radio signals.
- Keep the wireless devices away from large masonry structures and other building structures as these objects can absorb radio waves and lower signal strength.
- For an infrastructure network, position the WAP in a central location in line of sight with the wireless devices on the network.
- Keep all wireless devices on the network within range of one another.

Uninstall and reinstall the HP software

If your installation is incomplete, or if you connected the USB cable to the computer before prompted by the HP software installation screen, you might need to uninstall and then reinstall the HP software that came with the printer. Do not simply delete the printer application files from

your computer. Make sure to remove them correctly using the uninstall utility provided when you installed the HP software.

To uninstall from a Windows computer, method 1

1. Disconnect the printer from your computer. Do not connect it to your computer until after you have reinstalled the HP software.
2. On the computer desktop, click **Start**, select **Programs** or **All Programs**, click **HP**, click the printer name, and then click **Uninstall**.
3. Follow the onscreen instructions.
4. If you are asked whether you would like to remove shared files, click **No**.
Other programs that use these files might not work correctly if the files are deleted.
5. Restart your computer.
6. To reinstall the HP software, insert the HP software CD into your computer's CD drive, and follow the onscreen instructions.
7. Connect the printer when the HP software prompts you to connect it to the computer.
8. Press the **Power** button to turn the printer on.
After connecting and turning on the printer, you might have to wait several minutes for all of the Plug and Play events to complete.
9. Follow the onscreen instructions.

To uninstall from a Windows computer, method 2

 **NOTE:** Use this method if **Uninstall** is not available in the Windows Start menu.

1. On the computer desktop, click **Start**, select **Settings**, click **Control Panel**, and then click **Add/Remove Programs**.
- Or -
Click **Start**, click **Control Panel**, and then double-click **Programs and Features**.
2. Select the printer name, and then click **Change/Remove** or **Uninstall/Change**.
Follow the onscreen instructions.
3. Disconnect the printer from your computer.
4. Restart your computer.

 **NOTE:** It is important that you disconnect the printer before restarting your computer. Do not connect the printer to your computer until after you have reinstalled the HP software.

5. Insert the HP software CD into your computer's CD drive and then start the Setup program.
6. Follow the onscreen instructions.

To uninstall from a Macintosh computer, method 1

1. Open the HP Utility. For instructions, see [Open HP Utility](#).
2. Click the Application icon on the toolbar.
3. Double click **HP Uninstaller**, and then click **Continue**.
4. Select the product to uninstall, and then click **Uninstall**.
5. When prompted, type the correct administrator's name and password, and then click **OK**.
6. Follow the onscreen instructions.
7. When the **HP Uninstaller** finishes, restart your computer.

To uninstall from a Macintosh computer, method 2

1. Open the Finder, select **Applications**, and then select **Hewlett-Packard**.
2. Double-click **HP Uninstaller**, and then click **Continue**.
3. When prompted, type the correct administrator's name and password, and then click **OK**.

4. Follow the onscreen instructions.
5. When the **HP Uninstaller** finishes, restart your computer.

E Printer management tools

This section contains the following topics:

- [HP printer software \(Windows\)](#)
- [HP Utility \(Mac OS X\)](#)
- [Embedded Web server](#)

HP printer software (Windows)

The HP software provided with the printer provides maintenance information about the printer.

 **NOTE:** The HP printer software can be installed from the HP Software CD if the computer meets the system requirements.

Open the HP software

From the computer desktop, click the **Start** tab, select **Programs** or **All Programs**, select **HP**, select the folder for your HP printer, and then select your HP printer.

HP Utility (Mac OS X)

The HP Utility contains tools to configure print settings, calibrate the printer, order supplies online, and find Web site support information.

 **NOTE:** On a Macintosh computer, the features available in the HP Utility vary depending on the selected printer.

Ink level warnings and indicators provide estimates for planning purposes only. When you receive a low-ink warning message, consider having a replacement cartridge available to avoid possible printing delays. You do not need to replace cartridges until prompted to do so.

 **TIP:** When the HP Utility is opened, you can gain access to the Dock menu shortcuts by selecting and holding the mouse button over the appropriate icon for the HP Utility in the Dock.

Open HP Utility

To open the HP Utility

- ▲ Click the HP Utility icon in the Dock.

 **NOTE:** If the icon does not appear in the Dock, click the Spotlight icon on the right side of the menu bar, type `HP Utility` in the box, and then click the **HP Utility** entry.

Embedded Web server

When the printer is connected to a network, you can use the embedded Web server to view status information, change settings, and manage it from your computer.

 **NOTE:** For a list of system requirements for the embedded Web server, see [Embedded Web server specifications](#).

To view or change some settings, you might need a password.

You can open and use the embedded Web server without being connected to the Internet. However, some features are not available.

This section contains the following topics:

- [About cookies](#)
- [To open the embedded Web server](#)

About cookies

The embedded Web server (EWS) places very small text files (cookies) on your hard drive when you are browsing. These files let the EWS recognize your computer the next time you visit. For example, if you have configured the EWS language, a cookie helps remember which language you have selected so that the next time you access the EWS, the pages are displayed in that language. Though some cookies are cleared at the end of each session (such as the cookie that stores the selected language), others (such as the cookie that stores customer-specific preferences) are stored on the computer until you clear them manually.

You can configure your browser to accept all cookies, or you can configure it to alert you every time a cookie is offered, which allows you to decide which cookies to accept or refuse. You can also use your browser to remove unwanted cookies.

 **NOTE:** Depending on your printer, if you disable cookies, you also disable one or more of the following features:

- Starting where you left the application (especially useful when using setup wizards)
- Remembering the EWS browser language setting
- Personalizing the EWS Home page

For information about how to change your privacy and cookie settings and how to view or delete cookies, see the documentation available with your Web browser.

To open the embedded Web server

 **NOTE:** The printer must be on a network and must have an IP address. The IP address and hostname for the printer are listed on the status report. For more information, see [Understand the network configuration page](#).

In a supported Web browser on your computer, type the IP address or hostname that has been assigned to the printer.

For example, if the IP address is 123.123.123.123, type the following address into the Web browser: `http://123.123.123.123`.

 **TIP:** After opening the embedded Web server, you can bookmark it so that you can return to it quickly.

F How do I?

- [Get started](#)
- [Print](#)
- [Scan](#)
- [Copy](#)
- [Fax](#)
- [HP Digital Solutions](#)
- [Work with ink cartridges](#)
- [Solve a problem](#)

G Errors (Windows)

Fax memory full

If Backup Fax Reception or HP Digital Fax (Fax to PC or Fax to Mac) is enabled and the printer has a problem (such as a paper jam), the printer saves incoming faxes to memory until the problem is resolved. However, the printer's memory might fill up with faxes that have not been printed yet or transferred to the computer.

To solve this problem, resolve any problems with the printer.

For more information, see [Solve fax problems](#).

Printer disconnected

The computer cannot communicate with the printer because one of the following events has occurred:

- The printer has been turned off.
- The cable connecting the printer - such as a USB cable or a network (Ethernet) cable – has been disconnected.
- If the printer is connected to a wireless network, the wireless connection has been broken.

To solve this problem, try the following solutions:

- Make sure the printer is turned on and that the  (Power) light is on.
- Make sure the power cord and other cables are working and are firmly connected to the printer.
- Make sure the power cord is connected firmly to a functioning, alternating current (AC) power outlet.
- If the printer is connected to a network, make sure the network is functioning properly. For more information, see [Solve wired \(Ethernet\) network problems](#).
- If the printer is connected to a wireless network, make sure the wireless network is functioning properly. For more information, see [Solve wireless problems](#).

Ink Alert

The ink cartridge identified in the message is low on ink.

Ink level warnings and indicators provide estimates for planning purposes only. When you receive a low ink warning message, consider having a replacement cartridge available to avoid possible printing delays. You do not need to replace cartridges until prompted to do so.

For information about replacing ink cartridges, see [Replace the ink cartridges](#). For information about ordering ink cartridges, see [Order printing supplies online](#). For information about recycling used ink supplies, see [HP inkjet supplies recycling program](#).



NOTE: Ink from the cartridges is used in the printing process in a number of different ways, including in the initialization process, which prepares the printer and cartridges for printing. In addition, some residual ink is left in the cartridge after it is used. For more information see www.hp.com/go/inkusage.

Printhead problem

The printhead identified in the message is missing, not detected, or incorrectly installed in the printer.

To solve this problem, try the following solutions. Solutions are listed in order, with the most likely solution first. If the first solution does not solve the problem, continue trying the remaining solutions until the issue is resolved.

- Solution 1: Turn the printer off and on.
- Solution 2: Install the printheads correctly.
- Solution 3: Clean the electrical contacts.
- Solution 4: Replace the printhead.

Solution 1: Turn the printer off and on.

Turn off the printer, and then turn it on again.

If the problem persists, try the next solution.

Solution 2: Install the printheads correctly.

Make sure all of the printheads are properly installed:

 **CAUTION:** The printheads contain electrical contacts contain sensitive electronic components that can be damaged easily.

1. Open the print-carriage access door.
2. Touch Change Printheads on the printer control panel. Wait for the carriage to stop moving, and then unplug the power cord from the printer.
3. Lift the printhead latch.
4. Lift the handle of the printhead (which corresponds to the message) and use it to pull the printhead out of its slot.
5. Insert the printhead into its color-coded slot. (The label on the printhead must match the label on the printhead latch). Press down firmly on the printhead to ensure proper contact.
6. If necessary, repeat the steps for the remaining printhead.
7. Pull the printhead latch all the way forward, and then press down to ensure that the latch is engaged correctly. You might have to apply some pressure to engage the latch.
8. Close the print-carriage access door and check if the error message has gone away.

If the problem persists, try the next solution.

Solution 3: Clean the electrical contacts

Clean the electrical contacts on the printhead. For more information, see [To clean the printhead contacts manually](#).

If the problem persists, try the next solution.

Solution 4: Replace the printhead

Replace the indicated printhead. For more information, see [Solve wireless problems](#).

 **NOTE:** If the printhead is still under warranty, contact HP support for service or replacement. For more information about the printhead warranty, see [Solve wireless problems](#).

If the problem persists after you replace the cartridge, contact HP support. For more information, see [HP support](#).

Cartridge Problem

The ink cartridge identified in the message is missing, damaged, or inserted into the wrong slot in the printer.

 **NOTE:** If the cartridge is identified in the message as incompatible, see [Order printing supplies online](#) for information about obtaining cartridges for the printer.

To solve this problem, try the following solutions. Solutions are listed in order, with the most likely solution first. If the first solution does not solve the problem, continue trying the remaining solutions until the issue is resolved.

- Solution 1: Turn the printer off and on
- Solution 2: Install the ink cartridges correctly
- Solution 3: Clean the electrical contacts
- Solution 4: Replace the ink cartridge

Solution 1: Turn the printer off and on

Turn off the printer, and then turn it on again.

If the problem persists, try the next solution.

Solution 2: Install the ink cartridges correctly

Make sure all of the ink cartridges are properly installed:

1. Gently pull open the ink cartridge cover.
2. Remove the ink cartridge by grasping it and pulling it firmly toward you.
3. Insert the cartridge into the slot. Press firmly on the cartridge to ensure proper contact.
4. Close the ink cartridge cover and check if the error message has gone away.

If the problem persists, try the next solution.

Solution 3: Replace the ink cartridge

Replace the indicated ink cartridge. For more information, see [Order printing supplies online](#).



NOTE: If your cartridge is still under warranty, contact HP support for service or replacement. For more information about ink cartridge warranty, see [Ink cartridge warranty information](#). If the problem persists after you replace the cartridge, contact HP support. For more information, see [HP support](#).

Paper Mismatch

The paper size or type selected in the printer driver does not match the paper loaded in the printer. Make sure that the correct paper is loaded in the printer, and then print the document again. For more information, see [Load media](#).



NOTE: If the paper loaded in the printer is the correct size, change the selected paper size in the printer driver, and then print the document again.

The cartridge cradle cannot move

Something is blocking the ink cartridge cradle (the part of the printer that holds the ink cartridges).

To clear the obstruction, press (the Power button) to turn off the printer, and then check the printer for jams.

For more information, see [Clear jams](#).

Paper Jam

Paper has become jammed in the printer.

Before you try to clear the jam, check the following:

- Make sure that you have loaded paper that meets specifications and is not wrinkled, folded, or damaged. For more information, see [Media specifications](#).
- Make sure that the printer is clean. For more information, see [Maintain the printer](#).
- Make sure that the trays are loaded correctly and are not too full. For more information, see [Load media](#).

For instructions on clearing jams, as well as more information about how to avoid jams, see [Clear jams](#).

The printer is out of paper

The default tray is empty.

Load more paper, and then touch **OK**.

For more information, see [Load media](#).

Printer Offline

The printer is currently offline. While offline, the printer cannot be used.

To change the printer's status, complete the following steps.

1. Click **Start**, point to **Settings**, and then click **Printers** or **Printers and Faxes**.
- Or -
Click **Start**, click **Control Panel**, and then double-click **Printers**.
2. If the printers listed in the dialog box are not being displayed in Details view, click the **View** menu, and then click **Details**.
3. If the printer is Offline, right-click the printer, and click **Use Printer Online**.
4. Try using the printer again.

Printer Paused

The printer is currently paused. While paused, new jobs are added to the queue but are not printed.

To change the printer's status, complete the following steps.

1. Click **Start**, point to **Settings**, and then click **Printers** or **Printers and Faxes**.
- Or -
Click **Start**, click **Control Panel**, and then double-click **Printers**.
2. If the printers listed in the dialog box are not being displayed in Details view, click the **View** menu, and then click **Details**.
3. If the printer is paused, right-click the printer, and click **Resume Printing**.
4. Try using the printer again.



Document failed to print

The printer could not print the document because a problem occurred in the printing system.

For information about solving printing problems, see [Solve printing problems](#).

Printer failure

There was a problem with the printer. Usually, you can resolve such problems by completing the following steps:

1. Press  (the Power button) to turn off the printer.
2. Unplug the power cord, and then plug in the power cord again.
3. Press  (the Power button) to turn on the printer.

If this problem persists, write down the error code provided in the message, and then contact HP support. For more information about contacting HP support, see [HP support](#).

Door or cover open

Before the printer can print documents, all doors and covers must be closed.



TIP: When completely closed, most doors and covers snap into place.

If the problem persists after you've securely closed all doors and covers, contact HP support. For more information, see [HP support](#).

Previously used ink cartridge installed

The ink cartridge identified in the message was previously used in a different printer.

You can use ink cartridges in different printers, but if the cartridge was left outside of a printer for an extended period of time, the print quality of your documents might be affected. Also, if you use ink cartridges that have been used in a different printer, the ink level indicator might be inaccurate or unavailable.

If the print quality is unsatisfactory, try cleaning the printheads. For more information, see [To clean the printheads](#).



NOTE: Ink from the cartridges is used in the printing process in a number of different ways, including in the initialization process, which prepares the printer and cartridges for printing, and in printhead servicing, which keeps print nozzles clear and ink flowing smoothly. In addition, some residual ink is left in the cartridge after it is used. For more information, see www.hp.com/go/inkusage.

For more information about storing ink cartridges, see [Supplies](#).

Index

Symbols/Numerics

(ADF) automatic document feeder
clean 31
feeding problems, troubleshoot 31

A

accessibility 3, 10
accessories
installation 28
self test diagnostic page 148
turn on and off in driver 30
warranty 155
acoustic emissions 166
ADF (automatic document feeder)
capacity 22
load originals 22
media sizes supported 160
ADSL, fax setup with
parallel phone systems 194
after the support period 91
aligning printheads 101
answer ring pattern
change 73
parallel phone systems 196
answering machine
fax tones recorded 128
set up with fax (parallel phone systems) 206
set up with fax and modem 207
automatic document feeder (ADF)
capacity 22
clean 31
feeding problems, troubleshoot 31
load originals 22
media sizes supported 160
automatic fax reduction 66

B

backup fax 64
baud rate 75

black and white pages
copy 55
fax 57
troubleshoot 97

black dots or streaks, troubleshoot
copies 111
scan 116
blank pages, troubleshoot
copy 110
print 93
scan 115

blocked fax numbers
set up 67

both sides, print on 41
broadcast faxing
send 62

buttons, control panel 13

C

calibrate linefeed 102
cameras
insert memory cards 27
cancel
scheduled fax 62
Cancel button 14, 15
capacity
ADF 22
trays 162
cards
sizes supported 161
tray supporting 162
cartridges. *See* ink cartridges
clean
automatic document feeder 31
exterior 31
printheads 102, 103
scanner glass 30
clear
fax logs 79
color copy 55
colored text, and OCR 45
colors
bleeding 97
faded or dull 97

print black and white, troubleshoot 97
troubleshoot 98
wrong 97
computer modem
shared with fax (parallel phone systems) 199
shared with fax and answering machine (parallel phone systems) 207
shared with fax and voice line (parallel phone systems) 202
shared with fax and voice mail (parallel phone systems) 211

Configure

firewall 142
confirmation reports, fax 77
connection type
change 221
connectors, locating 13
control panel
buttons 13
lights 13
status icons 16

Copy 16

copy
quality 111
settings 55
specifications 164
troubleshoot 109

copy settings

copy 56
correct port test, fax 118
custom-size paper
Mac OS 39
print on 39
custom-sized media
sizes supported 161
customer support
electronic 88

cut-off pages, troubleshoot 94

- D**
- dark images, troubleshoot
 - copies 111
 - scans 115
 - Declaration of Conformity (DOC) 176
 - default settings
 - copy 56
 - dial tone test, failure 120
 - dial type, setting 74
 - dial-up modem
 - shared with fax (parallel phone systems) 199
 - shared with fax and answering machine (parallel phone systems) 207
 - shared with fax and voice line (parallel phone systems) 202
 - shared with fax and voice mail (parallel phone systems) 211
 - digital cameras
 - connect 38
 - insert memory cards 27
 - distinctive ringing
 - change 73
 - parallel phone systems 196
 - DOC 176
 - dots or streaks, troubleshoot
 - copies 111
 - dots, troubleshoot
 - scan 116
 - double-sided printing 41
 - driver
 - accessories settings 30
 - warranty 155
 - DSL, fax setup with
 - parallel phone systems 194
 - duplexer
 - clear jams 150
 - installation 29
 - margins, minimum 163
 - media sizes supported 160
 - media types and weights supported 162
 - turn on and off in driver 30
 - duty cycle 158
- E**
- ECM. *See* error correction mode
- F**
- edit
 - text in OCR program 45
 - electrical specifications 165
 - embedded Web server
 - about 225
 - opening 226
 - system requirements 159
 - troubleshoot, cannot be opened 144
 - Webscan 44
 - envelopes
 - sizes supported 160
 - tray supporting 162
 - environmental
 - specifications 165
 - environmental sustainability program 177
 - error correction mode 62
 - error messages
 - unable to activate TWAIN source 114
 - error reports, fax 78
 - EWS. *See* embedded Web server
- F**
- faded copies 110
 - faded stripes on copies, troubleshoot 111
 - fax
 - answer mode 73
 - answering machine and modem, shared with (parallel phone systems) 207
 - answering machine troubleshoot 128
 - answering machine, set up (parallel phone systems) 206
 - auto answer 73
 - backup fax 64
 - blocking numbers 67
 - confirmation reports 77
 - dial tone test, failed 120
 - dial type, setting 74
 - distinctive ringing setup (parallel phone systems) 196
 - distinctive ringing, change pattern 73
 - DSL, set up (parallel phone systems) 194
 - error correction mode 62
 - error reports 78
 - forwarding 65
 - header 72
 - Internet Protocol, over 76
 - ISDN line, set up (parallel phone systems) 195
 - line condition test, failed 121
 - log, clear 79
 - log, print 79
 - manual receive 63
 - modem and answering machine, shared with (parallel phone systems) 207
 - modem and voice line, shared with (parallel phone systems) 202
 - modem and voice mail, shared with (parallel phone systems) 211
 - modem, shared with (parallel phone systems) 199
 - monitor dialing 60, 62
 - paper size 66
 - parallel phone systems 190
 - PBX system, set up (parallel phone systems) 195
 - phone cord connection test, failed 118
 - phone cord too short 128
 - phone cord type test, failed 119
 - poll to receive 65
 - print last transaction details 79
 - receive 63
 - receive, troubleshoot 122, 125
 - redial options 75
 - reduction 66
 - reports 77
 - reprint 65
 - rings to answer 73
 - schedule 61
 - send 57
 - send, troubleshoot 122, 124, 127
 - separate line setup (parallel phone systems) 193
 - settings, change 72

- setup types 191
 - shared phone line setup
 - (parallel phone systems) 197
 - sound volume 76
 - specifications 164
 - speed 75
 - test failed 116
 - test setup 213
 - troubleshoot 116
 - voice mail, set up (parallel phone systems) 198
 - wall jack test, failed 117
 - Fax screen 16
 - Firewall
 - configure 142
 - firewall settings 216, 217
 - firewalls, troubleshoot 92
 - FoIP 76
 - fonts supported 158
 - forwarding faxes 65
- G**
- glass, scanner
 - clean 30
 - load originals 21
 - locating 11
 - grainy or white bands on
 - copies, troubleshoot 112
 - graphics
 - incompletely filled on
 - copies 111
 - ink not filling in 96
 - look different from original
 - scan 115
 - missing lines or dots 99
- H**
- hardware, fax setup test 117
 - header, fax 72
 - Help 17
 - Hewlett-Packard Company
 - notices 3
 - HP software
 - uninstall from Mac OS X 223
 - uninstall from Windows 223
 - HP Utility (Mac OS X)
 - opening 225
 - humidity specifications 165
- I**
- ink cartridge door, locating 12
- ink cartridges**
- check ink levels 84
 - expiration dates 148
 - locating 12
 - ordering online 188
 - part numbers 148, 188
 - replace 84
 - status 148
 - supported 157
 - tips 83
 - warranty 155
 - yields 158
- ink level icons 17**
- ink levels, check 84**
- ink smearing, troubleshoot 96**
- installation**
- accessories 28
 - duplexer 29
 - hardware installation
 - suggestions 145
 - HP software installation
 - suggestions 145
 - ink cartridges 84
 - tray 2 29
 - troubleshooting issues 145
- Internet Protocol**
- fax, using 76
- IP address**
- checking for printer 144
- IP settings 216**
- ISDN line, set up with fax**
- parallel phone systems 195
- J**
- jams**
- clear 150
 - media to avoid 21
 - paper 151, 153
- junk fax mode 67**
- L**
- language, printer 158**
- light images, troubleshoot**
- copies 111
 - scans 115
- lights, control panel 13**
- line condition test, fax 121**
- linefeed, calibrate 102**
- lines**
- copies, troubleshoot 111
 - scans, troubleshoot 115
- link speed, setting 216**
- load**
- photo 25, 26
 - tray 23, 24
- load cards 25, 26**
- load envelopes 24**
- load media 23**
- load transparencies 26**
- log, fax**
- print 79
- M**
- Mac OS**
- custom-size paper 39
 - Print borderless 40
 - Print photos 37
 - print settings 34
 - turn accessories on and off
 - in driver 30
- Mac OS X**
- HP Utility 225
 - uninstall HP software 223
- maintenance**
- check ink levels 84
- manual faxing**
- receive 63
 - send 59, 60
- margins**
- duplexer 163
 - setting, specifications 163
- media**
- ADF capacity 22
 - clear jams 150
 - duplexing 41
 - HP, order 189
 - load tray 23
 - print on custom-size 39
 - selecting 21
 - skewed pages 108
 - specifications 159, 160
 - supported sizes 160
 - troubleshoot feeding 108
 - types and weights
 - supported 162
- memory**
- reprint faxes 65
 - save faxes 64
 - specifications 158
- memory cards**
- insert 27
 - print DPOF files 38
 - print files 37
 - specifications 166

- memory devices
 - troubleshoot 134
- missing lines or dots,
 - troubleshoot 99
- missing or incorrect
 - information, troubleshoot 93, 99
- MMC memory card
 - insert 27
- model number 148
- modem
 - shared with fax (parallel phone systems) 199
 - shared with fax and answering machine (parallel phone systems) 207
 - shared with fax and voice line (parallel phone systems) 202
 - shared with fax and voice mail (parallel phone systems) 211
- monitor dialing 60, 62
- multi-feeds, troubleshoot 109

N

- network port
 - address 136
- networks
 - advanced settings 215
 - connector illustration 13
 - firewall settings 216, 217
 - firewalls, troubleshoot 92
 - IP settings 216
 - link speed 216
 - operating systems
 - supported 159
 - protocols supported 159
 - settings, change 215
 - solve problems 146
 - system requirements 159
 - view and print settings 215
 - wireless communication
 - setup 219
 - wireless settings 148, 220
- noise information 166

O

- OCR
 - edit scanned documents 45
 - troubleshoot 113

- operating environment
 - specifications 165
- operating systems
 - supported 158
- originals
 - scan 43
- output tray
 - locating 11
 - media supported 162

P

- pages per month (duty cycle) 158
- paper
 - jams 151, 153
 - size, set for fax 66
- paper-feed problems,
 - troubleshoot 108
- parallel phone systems
 - answering machine
 - setup 206
 - countries/regions with 190
 - distinctive ringing setup 196
 - DSL setup 194
 - ISDN setup 195
 - modem and answering machine setup 207
 - modem and voice mail
 - setup 211
 - modem setup 199
 - modem shared with voice line setup 202
 - PBX setup 195
 - separate line setup 193
 - setup types 191
 - shared line setup 197
- PBX system, set up with fax
 - parallel phone systems 195
- PCL 3 support 158
- phone cord
 - connected to correct port
 - test failed 118
 - correct type test failed 119
 - extend 128
- phone line, answer ring
 - pattern 73
- phone support 88
- phone support period
 - period for support 89
- phone, fax from
 - receive 63
 - send, 59

- photo media
 - sizes supported 161
- Photo screen 17
- photos
 - insert memory cards 27
 - print from DPOF files 38
 - print from memory cards 37
 - troubleshoot memory devices 135
- poll to receive fax 65
- ports, specifications 157
- power
 - specifications 165
 - troubleshoot 92
- power input, locating 13
- print
 - double-sided 41
 - fax logs 79
 - fax reports 77
 - faxes 65
 - last fax details 79
 - photos from DPOF file 38
 - photos from memory cards 37
 - self test diagnostic page 148
 - slow 93
 - troubleshoot 91
- Print borderless
 - Mac OS 40
 - Windows 40
- Print brochures
 - print 35
- Print envelope 35
- Print envelopes
 - Mac OS 36
- Print photos
 - Mac OS 37
 - Windows 36
- print quality
 - diagnostic page 100
 - troubleshoot 94
- Print quality diagnostic
 - page 100
- print-carriage access door,
 - locating 12
- printer control panel
 - locating 11
 - network settings 215
 - scan from 43
 - send faxes 58
- printer driver
 - accessories settings 30
 - warranty 155

Index

- printer software (Windows)
 - about 225
 - opening 225
- printhead latch, locating 12
- printheads
 - aligning 101
 - clean 102
 - clean contacts manually 103
 - health, check 100
 - maintaining 99
 - ordering online 188
 - replace 105
 - status 100, 148
 - supported 158
- processor specifications 158
- pulse dialing 74
- Q**
- quality, troubleshoot
 - copy 111
 - diagnostic page 100
 - print 94
 - scan 114
- R**
- radio interference
 - reducing 222
 - regulatory information 172
- radio, turn off 215
- rear access panel
 - clear jams 150
 - illustration 13
- receive faxes
 - auto answer mode 73
 - automatically 63
 - blocking numbers 67
 - forwarding 65
 - manually 63
 - polling 65
 - rings to answer 73
 - troubleshoot 122, 125
- recycle
 - print cartridges 177
- redial options, setting 75
- reduce fax 66
- regulatory information 167, 172
- regulatory model number 175
- replace
 - ink cartridges 84
 - printheads 105
- report
 - wireless test 221
- reports
 - confirmation, fax 77
 - error, fax 78
 - fax test failed 116
- reprint
 - faxes from memory 65
- right navigation button 14, 15
- rings to answer 73
- S**
- save
 - faxes in memory 64
- scan
 - error messages 114
 - from printer control panel 43
 - from Webscan 44
 - OCR 45
 - quality 114
 - Scan screen 16
 - scan specifications 165
 - slow 113
 - troubleshoot 112
- Scan screen 16
- scanner glass
 - clean 30
 - load originals 21
 - locating 11
- schedule fax 61
- Secure Digital memory card
 - insert 27
- security
 - wireless communication 221
 - wireless settings 220
- self test diagnostic page
 - information on 147
 - print 148
- send faxes
 - basic fax 57
 - manually 59
 - memory, from 60
 - monitor dialing 60, 62
 - schedule 61
 - troubleshoot 122, 124, 127
- send scans
 - for OCR 45
 - troubleshoot 112
- serial number 148
- serial phone systems
 - countries/regions with 190
 - setup types 191
- settings
 - copy 55
 - network 215
- speed, fax 75
- volume, fax 76
- Setup 17
- setup
 - answering machine
 - (parallel phone systems) 206
 - answering machine and modem (parallel phone systems) 207
 - computer modem (parallel phone systems) 199
 - computer modem and answering machine (parallel phone systems) 207
 - computer modem and voice line (parallel phone systems) 202
 - computer modem and voice mail (parallel phone systems) 211
 - distinctive ringing 73
 - distinctive ringing (parallel phone systems) 196
 - DSL (parallel phone systems) 194
 - fax scenarios 191
 - fax, with parallel phone systems 190
 - ISDN line (parallel phone systems) 195
 - PBX system (parallel phone systems) 195
 - separate fax line (parallel phone systems) 193
 - shared phone line (parallel phone systems) 197
 - test fax 213
 - voice mail (parallel phone systems) 198
 - voice mail and computer modem (parallel phone systems) 211
- size
 - scans, troubleshoot 116
 - troubleshoot copy 110
- skew, troubleshoot
 - copy 111
 - print 108
 - scan 114
- slow print, troubleshoot 93

- software
 - accessories settings 30
 - OCR 45
 - warranty 155
 - Webscan 44
- sound pressure 166
- specifications
 - acoustic emissions 166
 - electrical 165
 - media 159, 160
 - network protocols 159
 - operating environment 165
 - physical 157
 - processor and memory 158
 - storage environment 165
 - system requirements 158
- speed
 - troubleshoot for
 - scanner 113
 - troubleshoot print 93
- speed dial
 - send fax 57
- status
 - network configuration
 - page 148
 - self test diagnostic page 148
- status icons 16
- storage devices
 - USB flash drives
 - supported 166
- storage environment
 - specifications 165
- streaks, troubleshoot
 - copies 111
 - scan 116
- stripes on scans,
 - troubleshoot 115
- subscriber identification code 72
- supplies
 - ordering online 188
 - self test diagnostic page 148
 - yields 158
- support 87
- system requirements 158

T

- technical information
 - copy specifications 164
 - fax specifications 164
 - memory card
 - specifications 166
 - scan specifications 165

- telephone line, answer ring
 - pattern 73
- telephone wall jack, fax 117
- telephone, fax from
 - receive 63
 - send 59
- temperature specifications 165
- tests, fax
 - dial tone, failed 120
 - failed 116
 - fax line condition 121
 - fax phone cord type test
 - failed 119
 - hardware, failed 117
 - port connection, failed 118
 - setup 213
 - telephone wall jack 117
- text
 - cannot be edited after
 - scan, troubleshoot 113
 - incompletely filled on
 - copies 111
 - missing from scan,
 - troubleshoot 113
 - splotchy on copies 112
 - troubleshoot 94, 96, 99
 - unclear on copies,
 - troubleshoot 111
 - unclear scans 116
- tone dialing 74
- tray 1
 - capacity 162
 - media sizes supported 160
 - media types and weights
 - supported 162
- tray 2
 - capacity 162
 - installation 29
 - media sizes supported 160
 - media types and weights
 - supported 162
 - turn on and off in driver 30
- trays
 - capacities 162
 - clear jams 150
 - installation tray 2 29
 - load media 23
 - locating 11
 - media sizes supported 160
 - media types and weights
 - supported 162
 - paper guides illustration 11

- troubleshoot feeding 108
- turn on and off in driver 30
- troubleshoot
 - answering machines 128
 - blank pages printed 93
 - bleeding colors 97
 - colors 97, 98
 - copy 109
 - copy quality 111
 - cut-off pages, incorrect text
 - or graphics placement 94
 - embedded Web server 144
 - fax 116
 - fax dial tone test failed 120
 - fax hardware test failed 117
 - fax line test failed 121
 - fax phone cord connection
 - test failed 118
 - fax phone cord type test
 - failed 119
 - fax tests 116
 - fax wall jack test, failed 117
 - firewalls 92
 - ink not filling text or
 - graphics 96
 - ink smearing 96
 - jams, paper 153
 - meaningless characters
 - print 95
 - media not picked up from
 - tray 108
 - memory devices 134
 - missing lines or dots 99
 - missing or incorrect
 - information 93, 99
 - multiple pages are
 - picked 109
 - network configuration
 - page 148
 - nothing prints 92
 - paper-feed problems 108
 - power 92
 - print 91
 - print quality 94
 - receive faxes 122, 125
 - scan 112
 - scan quality 114
 - self test diagnostic page 147
 - send faxes 122, 124, 127
 - skewed copies 111
 - skewed pages 108
 - slow print 93
 - tips 91

Index

- troubleshooting
 - general network
 - troubleshooting 135
 - hardware installation
 - suggestions 145
 - HP software installation
 - suggestions 145
 - installation issues 145
 - solve network problems 146
 - wired network 135
 - wireless problems 136
 - TWAIN
 - unable to activate
 - source 114
 - two-sided printing 41
- U**
- uninstall HP software
 - Mac OS X 223
 - Windows 223
 - USB connection
 - port, locating 11, 13
 - specifications 157
 - USB flash drives 166
- V**
- vertical stripes on copies,
 - troubleshoot 111
 - view
 - network settings 215
 - voice mail
 - set up with fax (parallel phone systems) 198
 - set up with fax and computer modem (parallel phone systems) 211
 - voltage specifications 165
 - volume
 - fax sounds 76
- W**
- wall jack test, fax 117
 - warranty 155
 - Web sites
 - accessibility information 3, 10
 - customer support 88
 - environmental programs 177
 - order supplies and accessories 188
 - supply yield data sheet 158
 - Webscan 44
 - white bands or stripes,
 - troubleshoot
 - copies 111, 112
 - scans 115
 - Windows
 - borderless 40
 - print brochures 34
 - Print photos 36
 - print settings 34
 - system requirements 158
 - turn accessories on and off
 - in driver 30
 - uninstall HP software 223
 - wireless communication
 - advanced wireless
 - troubleshooting 137
 - basic wireless
 - troubleshooting 136
 - radio, turn off 215
 - reducing interference 222
 - regulatory information 172
 - security 221
 - set up 219
 - settings 220
 - wizard 219
 - wireless connection icons 16
 - wireless test report
 - print 221
- X**
- xD-Picture memory card
 - insert 27

© 2010 Hewlett-Packard Development Company, L.P.

www.hp.com/support

Free Manuals Download Website

<http://myh66.com>

<http://usermanuals.us>

<http://www.somanuals.com>

<http://www.4manuals.cc>

<http://www.manual-lib.com>

<http://www.404manual.com>

<http://www.luxmanual.com>

<http://aubethermostatmanual.com>

Golf course search by state

<http://golfingnear.com>

Email search by domain

<http://emailbydomain.com>

Auto manuals search

<http://auto.somanuals.com>

TV manuals search

<http://tv.somanuals.com>