

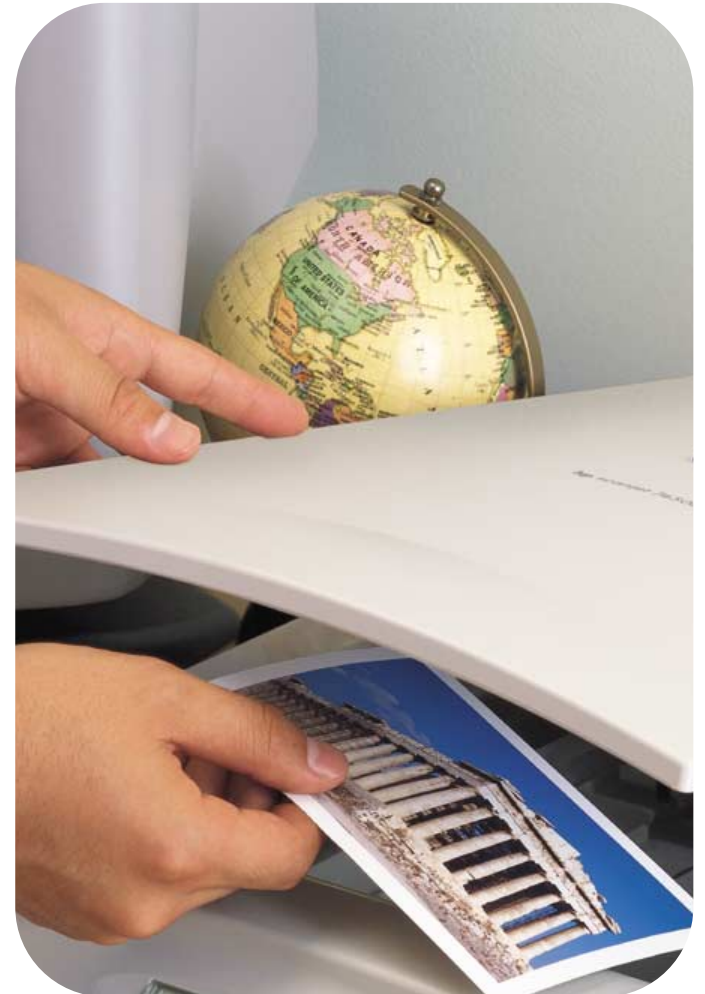

**hp** scanjet 4400c series  
and 5400c series scanners  
user's manual



### *Copyright information*

© Copyright Hewlett-Packard Company 2001

All rights reserved. Reproduction, adaptation, or translation without prior written permission is prohibited, except as allowed under copyright laws.

### *Trademark credits*

Adobe and Adobe Photoshop are trademarks of Adobe Systems Incorporated. Energy Star<sup>®</sup> is a U.S. registered service mark of the United States Environmental Protection Agency. Microsoft and Hotmail are U.S. registered trademarks of Microsoft Corporation.

All other products mentioned herein may be trademarks of their respective companies.

### *Warranty*

The information contained in this document is subject to change without notice.

Hewlett-Packard makes no warranty of any kind with respect to this information. HEWLETT-PACKARD SPECIFICALLY DISCLAIMS THE IMPLIED WARRANTY OF MERCHANTABILITY AND FITNESS FOR A PARTICULAR PURPOSE.

Hewlett-Packard shall not be liable for any direct, indirect, incidental, consequential, or other damage alleged in connection with the furnishing or use of this information.

#### **NOTICE TO U.S. GOVERNMENT**

**USERS: RESTRICTED RIGHTS COMMERCIAL COMPUTER SOFTWARE:** "Use, duplication, or disclosure by the Government is subject to restrictions as set forth in subparagraph (c) (1) (ii) of the Rights in Technical Data Clause at DFARS 52.227-7013."

Material scanned by this product may be protected by governmental laws and other regulations, such as copyright laws. The customer is solely responsible for complying with all such laws and regulations.

# Front panel and accessories comparisons

The following tables provide information about the HP Scanjet 4400c series and 5400c series scanners, including descriptions of the buttons available on the front panels and the accessories you can use with these scanners.

To find information about your scanner, see the following tables:

["HP Scanjet 4400c series" on page 4.](#)







["HP Scanjet 4470c series" on page 5.](#)

["HP Scanjet 5400c series" on page 6.](#)

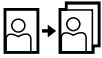
["HP Scanjet 5470c series" on page 8.](#)



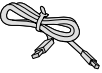



["HP Scanjet 5490c series" on page 10.](#)

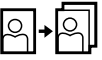

## HP Scanjet 4400c series

Feature	Included on scanner or in box	Supported accessory <sup>a</sup>
Copy button 	✓	
Photo Reprint button 	✓	
Scan To button 	✓	
E-mail button 	✓	
Power Save button 	✓	
USB cable 	✓	
HP Scanjet Transparency Adapter (XPA) 		✓

a. Supported accessories include accessories that are not boxed with the scanner, but can be purchased separately.





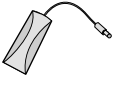

## HP Scanjet 4470c series



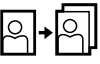

Feature	Included on scanner or in box	Supported accessory <sup>a</sup>
Copy button 	✓	
Color/black & white copy and select number of copies buttons 	✓	
Photo Reprint button 	✓	
Scan To button 	✓	
E-mail button 	✓	
Share-to-Web button 	✓	
Power Save button 	✓	

Feature	Included on scanner or in box	Supported accessory <sup>a</sup>
More Options button 	✓	
Cancel button 	✓	
Two-digit LCD	✓	
USB cable 	✓	
HP Scanjet Transparency Adapter (XPA) 	✓	

a. Supported accessories include accessories that are not boxed with the scanner, but can be purchased separately.

## HP Scanjet 5400c series

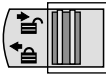
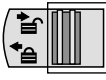



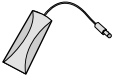
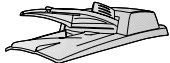

Feature	Included on scanner or in box	Supported accessory <sup>a</sup>
Copy button 	✓	
Color/black & white copy and select number of copies buttons 	✓	
Photo Reprint button 	✓	
Scan To button 	✓	
E-mail button 	✓	
Share-to-Web button 	✓	





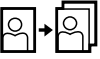

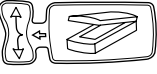
Feature	Included on scanner or in box	Supported accessory <sup>a</sup>
Power Save button 	✓	
More Options button 	✓	
Cancel button 	✓	
Two-digit LCD 	✓	
Scanner lock 	✓	
USB cable 	✓	
Parallel cable <sup>b</sup> 	✓	

Feature	Included on scanner or in box	Supported accessory <sup>a</sup>
HP Scanjet Transparency Adapter (XPA) 		✓
HP Scanjet Automatic Document Feeder (ADF) 		✓

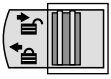

- a. Supported accessories include accessories that are not boxed with the scanner, but can be purchased separately.
- b. The parallel cable shipped with the scanner is for computers that use Microsoft Windows. For Macintosh computers, use the USB cable. For more information, see the [Setup and Support Guide](#).

## HP Scanjet 5470c series

Feature	Included on scanner or in box	Supported accessory <sup>a</sup>
Copy button 	✓	
Color/black & white copy and select number of copies buttons 	✓	
Photo Reprint button 	✓	
Scan To button (with Speed Destinations <sup>b</sup> ) 	✓	
Select Destination button 	✓	
E-mail button 	✓	







Feature	Included on scanner or in box	Supported accessory <sup>a</sup>
Share-to-Web button 	✓	
Power Save button 	✓	
More Options button 	✓	
Cancel button 	✓	
16-character LCD 	✓	
Scanner lock 	✓	
USB cable 	✓	





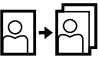

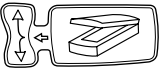



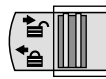
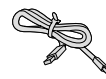

Feature	Included on scanner or in box	Supported accessory <sup>a</sup>
Parallel cable <sup>c</sup> 	✓	
HP Scanjet Transparency Adapter (XPA) 	✓	
HP Scanjet Automatic Document Feeder (ADF) 		✓

- a. Supported accessories include accessories that are not boxed with the scanner, but can be purchased separately.
- b. Speed Destinations are scanner button options available in the HP Scanjet Controls control panel. See "Changing settings for Speed Destinations (some models only)" on page 36.
- c. The parallel cable shipped with the scanner is for computers that use Microsoft Windows. For Macintosh computers, use the USB cable. For more information, see the [Setup and Support Guide](#).

## HP Scanjet 5490c series

Feature	Included on scanner or in box	Supported accessory <sup>a</sup>
Copy button 	✓	
Color/black & white copy and select number of copies buttons 	✓	
Photo Reprint button 	✓	
Scan To button (with Speed Destinations <sup>b</sup> ) 	✓	
Select Destination button 	✓	
E-mail button 	✓	

Feature	Included on scanner or in box	Supported accessory <sup>a</sup>
Share-to-Web button 	✓	
Power Save button 	✓	
More Options button 	✓	
Cancel button 	✓	
16-character LCD	✓	
Scanner lock 	✓	
USB cable 	✓	

Feature	Included on scanner or in box	Supported accessory <sup>a</sup>
Parallel cable <sup>c</sup> 		
HP Scanjet Transparency Adapter (XPA) 		
HP Scanjet Automatic Document Feeder (ADF) 		

- a. Supported accessories include accessories that are not boxed with the scanner, but can be purchased separately.
- b. Speed Destinations are scanner button options available in the HP Scanjet Controls control panel. See "Changing settings for Speed Destinations (some models only)" on page 36.
- c. The parallel cable shipped with the scanner is for computers that use Microsoft Windows. For Macintosh computers, use the USB cable. For more information, see the [Setup and Support Guide](#).



# Contents

## Front panel and accessories comparisons

HP Scanjet 4400c series . . . . .	4
HP Scanjet 4470c series . . . . .	5
HP Scanjet 5400c series . . . . .	6
HP Scanjet 5470c series . . . . .	8
HP Scanjet 5490c series . . . . .	10

## 1 Getting started

Printing this information . . . . .	15
Viewing the product tour . . . . .	15
Where do I start? . . . . .	16
Using the scanner buttons . . . . .	16
Using the HP Precisionscan Pro software . . . . .	16
Using another program . . . . .	16
Using the HP Scanjet Copy Utility . . . . .	16
Selecting and preparing items . . . . .	17
Items for the scanner glass . . . . .	17
Items for the ADF . . . . .	17
Items for the XPA . . . . .	18
Completing your first scan . . . . .	19
Frequently asked questions . . . . .	22

## 2 Scanning from scanner buttons

Overview of scanner buttons . . . . .	26
Scanning quickly with scanner buttons . . . . .	28
Scanning to the HP Precisionscan Pro software . . . . .	28
Scanning to another program . . . . .	29
Sending a scan to a website . . . . .	30
Scanning for photo reprints . . . . .	30
E-mailing a scan . . . . .	31
Printing copies . . . . .	33
Canceling a scan . . . . .	34
Using Power Save . . . . .	34

Configuring scanner buttons . . . . .	35
Changing settings for buttons . . . . .	35
Changing settings for Speed Destinations (some models only) . . . . .	36
Settings for scanner buttons . . . . .	37

## 3 Scanning from HP Precisionscan Pro

Overview of the HP Precisionscan Pro software . . . . .	39
Starting the HP Precisionscan Pro software . . . . .	40
Finding help for using the software . . . . .	40
Performing a new scan . . . . .	41
Cropping or selecting an area for final scan . . . . .	42
Getting a closer look (zooming) . . . . .	43
Selecting output type . . . . .	43
Making optional adjustments, basic . . . . .	45
Resizing (output dimensions) . . . . .	45
Changing resolution . . . . .	46
Changing contrast . . . . .	46
Rotating an image . . . . .	47
Mirroring (reversing) an image . . . . .	47
Sharpening an image . . . . .	48
Resetting all adjustments . . . . .	48
Making optional adjustments, advanced . . . . .	49
Inverting the image . . . . .	49
Changing midtones . . . . .	50
Changing highlights . . . . .	51
Changing shadows . . . . .	52
Checking for clipped areas . . . . .	53
Setting pixel output levels . . . . .	54
Viewing RGB values and pixels . . . . .	55
About the histogram . . . . .	55
Changing the hue . . . . .	56
Changing the saturation . . . . .	56
Changing the black and white threshold . . . . .	57
Setting which colors become black or white in black & white bitmaps . . . . .	

58	
Descreening images . . . . .	59
Resetting all adjustments . . . . .	59
Completing the final scan . . . . .	60
Sending to a program . . . . .	60
Returning the image to a program that supports TWAIN or the HP Scanjet Plug-in . . . . .	61
Saving to a file . . . . .	61
Printing . . . . .	63
Placing a scan on a website . . . . .	64
Preparing a scan for online viewing . . . . .	64
Copying and pasting into another program . . . . .	65
Dragging-and-dropping into another program . . . . .	66
Dragging-and-dropping to the desktop or a folder . . . . .	66
Scanning to CD . . . . .	67
Other features and tips . . . . .	68
Tips for best image quality . . . . .	69
Saving settings . . . . .	69
Setting preferences . . . . .	70
Scanning from other programs . . . . .	74
Making scanned text editable . . . . .	75

## 4 Using accessories

Scanning from the ADF . . . . .	78
Scanning from the XPA . . . . .	79
Scanning slides . . . . .	79
Scanning negatives . . . . .	81
Making optional adjustments for slides or negatives . . . . .	83
Adjusting midtones for slides or negatives . . . . .	83
Adjusting highlights for slides or negatives . . . . .	84
Adjusting shadows for slides or negatives . . . . .	84
Viewing RGB values and pixel color . . . . .	85

## 5 Troubleshooting and maintaining

Checking the basics . . . . .	88
Starting troubleshooting . . . . .	89
Resolving scanner messages . . . . .	90

Resolving issues that did not generate messages . . . . .	90
Resolving image-quality issues . . . . .	93
Resolving issues with scanned images . . . . .	93
Resolving issues with printed copies . . . . .	96
Resolving issues with slides and negatives . . . . .	98
Resolving issues with editable text . . . . .	99
Resolving issues sending to destinations . . . . .	101
Resolving issues with accessories . . . . .	104
Resolving issues with the XPA . . . . .	104
Resolving issues with the ADF . . . . .	105
Setting scanner lamp controls . . . . .	107
Energy Save . . . . .	107
Faster Scan . . . . .	107
Clearing jams from the ADF . . . . .	108
Cleaning and maintaining . . . . .	111
Cleaning the scanner glass . . . . .	111
Cleaning the XPA . . . . .	112
Cleaning the ADF glass . . . . .	112
Uninstalling the software . . . . .	113
Other resources, support, and specifications . . . . .	113

## A Using software commands and controls

Using keyboard shortcuts and the menus . . . . .	116
HP Precisionscan Pro tool and information bars . . . . .	119
Toolbar . . . . .	119
Info bar . . . . .	120
Context-sensitive cursors . . . . .	121

## B Glossary

## Index

# 1 Getting started

This section contains the basics to help you get started with your new HP Scanjet scanner. From here, you can learn about viewing the product tour, preparing items before you scan them, and choosing which scanning method to use.

## Printing this information

To print this PDF manual, use the **Print** command on the **File** menu. Print the whole document, or print only the chapters or topics you want according to their page numbers. See the table of contents for page numbers of topics.

## Viewing the product tour

The product tour is a fast and easy way to explore the capabilities of the scanner and see some interesting ways you can use the scanner to meet your needs. The product tour, which only takes three minutes, begins automatically when you start the HP Precisionscan Pro software for the first time.

To view the tour at other times: In the HP Scanning Software folder, double-click **Product Tour**.

## Where do I start?

You can start scanning from one of these places:

- Scanner buttons
- HP Precisionscan Pro software
- Another program
- HP Scanjet Copy Utility

Where you start depends on what you want to do with the scan and on your own preferences.

### Using the scanner buttons

Use the scanner buttons, which are shortcuts, when:

- You want to start at the scanner.
- You want to scan quickly without making changes.
- You want to scan an item using the default settings optimized for the destination you choose.

See ["Scanning from scanner buttons" on page 25](#).

### Using the HP Precisionscan Pro software

Use the HP Precisionscan Pro software when:

- You want to view or change a scanned image before you send it. Changes might include resolution, cropping, or resizing.
- You want to send to a destination, such as a desktop publishing program, but there is no button on the scanner for that destination.

See ["Scanning from HP Precisionscan Pro" on page 39](#).

### Using another program

Start scanning from within another program when:

- You want to bring a scanned item into an open program, such as your word-processing program.
- The program in which you are working is compliant with TWAIN or the HP Scanjet Plug-in (which is an Adobe® Photoshop® plug-in). A program is compliant if a command such as **Acquire Image** or **From Scanner** appears on a menu such as the **File** menu. If you are unsure whether your program complies with TWAIN standards or supports Photoshop plug-ins—or you do not know the command for inserting a scanned item, see the documentation for the program.

See ["Scanning from other programs" on page 74](#).

### Using the HP Scanjet Copy Utility

Use the HP Scanjet Copy Utility when you need to make standard copy adjustments, such as reducing or enlarging, or lightening or darkening. You can also choose a printer other than the default.

To start the utility: in the HP Scanning Software folder, double-click **HP Scanjet Copy Utility**. For help using the utility, move the pointer over the button or option to find more information about the feature.



## Selecting and preparing items

Before placing items in the scanner, follow these guidelines for selecting and preparing them to prevent damage to the items and the scanner.

**CAUTION** Improper placement and scanning can damage the items and the scanner.

### Items for the scanner glass

The scanner glass can scan the widest range of items, including:

- paper items
- news clippings, receipts, and business cards
- items on all weights of media, including media lighter than 60 g/m<sup>2</sup> (16 lb) or heavier than 105 g/m<sup>2</sup> (28 lb)
- gum-backed paper
- multipart forms with carbon pages
- old or worn photographs or documents
- items containing tears, perforations, punch holes, wrinkles, or curls
- flatter, three-dimensional items such as fabric, pages in books, and paper with texture

**CAUTION** Avoid placing items with sharp edges on the scanner glass. Doing so can damage the scanner.

Before placing an item on the scanner glass, make sure the item is free of wet glue, correction fluid, or other contaminating substances.

### Items for the ADF

The HP Scanjet Automatic Document Feeder (ADF), which is a fast, convenient way to scan multiple-page items, is included or supported on some scanner models. See "[Front panel and accessories comparisons](#)" on page 3. The ADF accepts items that meet the following specifications:

- items on standard Letter-, A4-, and Legal-size paper
- items consisting of as many as 25 unbound pages
- items ranging in size from 88.9 by 127 mm (3.5 by 5 inches) to 215.9 by 355.6 mm (8.5 by 14 inches)
- items ranging in weight from 60 to 90 g/m<sup>2</sup> (16 to 24 lb)
- items that are square or rectangular and in good condition (not fragile or worn)
- items that are free of tears, perforations, or punch holes
- items that are free of wet glue, correction fluid, or ink

Avoid multipart forms with carbon pages, transparencies, magazine pages, gum-backed pages, and light "onionskin" pages.

Before placing an item in the ADF, prepare the item by doing the following:

- Remove curls or wrinkles.
- Remove staples, paper clips, paper sticky notes, and any other materials from items.

If your item does not meet these guidelines or you cannot prepare it as stated, use the scanner glass.

## Items for the XPA

The HP Scanjet Transparency Adapter (XPA) is included with some scanner models or can be ordered. Use the XPA and its templates to scan:

- 35 mm photographic negatives
- 35 mm slides

Because these items are easily damaged, handle them only by their edges.

## Completing your first scan

This section shows you how to take the same item and scan to print using the two primary scanning methods:

- Scanner buttons
- HP Precisionscan Pro software

Before scanning, place the item in the scanner.

*To load the item in the scanner*

- 1 Choose an item to scan, such as a page from a magazine.

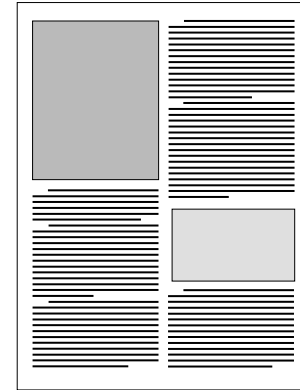

- 2 Place the item face down on the scanner glass and close the lid.

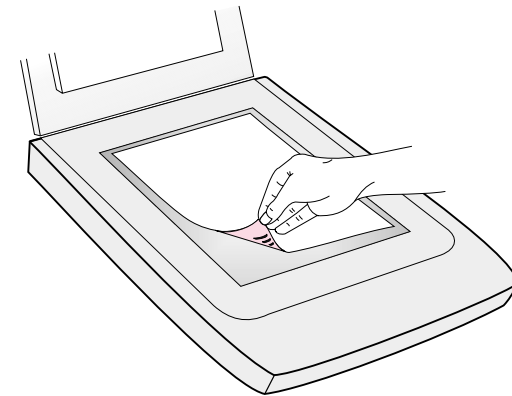

- 3 See ["To complete your first scan using the scanner buttons" on page 20.](#)

*To complete your first scan using the scanner buttons*

- 1 Load the item in the scanner. See ["To load the item in the scanner" on page 19.](#)
- 2 On the scanner, press the Copy button (  ). The scanner scans the item using settings optimized for printing this type of item and then prints the item to the default printer.

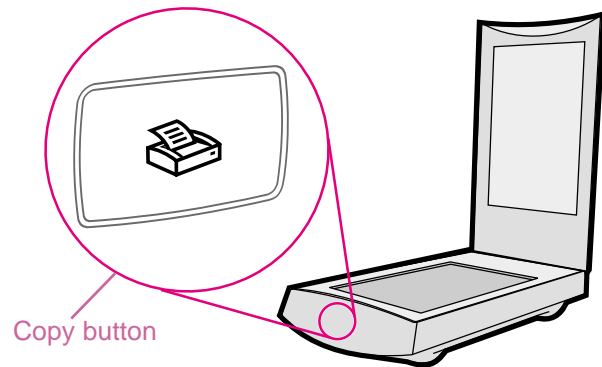

- 3 If the scan does not work, or you have difficulty with this process, please see ["Resolving issues that did not generate messages" on page 90.](#)

If you have not already scanned using the HP Precisionscan Pro software, see ["To complete your first scan using the HP Precisionscan Pro software" on page 21.](#)

*To complete your first scan using the HP Precisionscan Pro software*

- 1 Load the item in the scanner. See ["To load the item in the scanner" on page 19](#).
- 2 With the item loaded, press the Scan To button (  ) on the scanner. The scanner scans the item to the HP Precisionscan Pro software, choosing the best settings for this type of item.
- 3 When the scanned image appears in the preview window of the software, draw a selection border around the image or portion of the image you want. To do so, click on one corner of the area you want, and while holding down the mouse button, drag the cursor to the opposite corner. Release the mouse button to complete the border.

Selection border



- 4 Experiment with the image. Change the output type or make other adjustments.
- 5 When you finish: On the **Scan** menu, click **Print**.
- 6 Select any printer options you want and click **OK**. The scanner performs a final scan including your changes, and the scanned image prints.
- 7 If the scan does not work, or you have difficulty with this process, please see ["Resolving issues that did not generate messages" on page 90](#).

If you have not already scanned using the scanner buttons, see ["To complete your first scan using the scanner buttons" on page 20](#).

## Frequently asked questions

This section contains answers to some questions frequently asked about scanning.

*What settings does the HP Precisionscan Pro software set automatically for an item I scan?*

Based on the scanned item, the software automatically chooses optimal values for these settings:

- output type
- resolution
- sharpening
- exposure (midtones, highlights, and shadows)
- color (hue and saturation or black & white threshold)

Usually, the values the software selects provide optimal results. However, you can change these values in the HP Precisionscan Pro software.

*How can I reduce the time it takes to scan?*

You can reduce the time it takes to scan an item by scanning in black and white when the original is one of the following:

- a black-and-white photograph or drawing
- a color photo or drawing, but you want a black-and-white image to appear on the computer screen
- an item that contains only text

Another option is to reduce file size. See "[How can I reduce the file size?](#)" on page 23.

Print color originals as black and white by selecting the Black & White option on the front panel and pressing the Copy button (). Or, in the HP Precisionscan Pro software, choose the **Grayscale** or **Black & White** output types before your final scan (after the scanner completes a preview scan). See "[Selecting output type](#)" on page 43.

In the HP Scanjet Controls control panel, select the **Faster Scan** setting on the **Lamp** tab. When selected, this setting allows you to set a time for the scanner to turn on. After this time, the scanner lamp and the XPA light source (if connected) stay on for ten hours and then turn off. See "[Setting scanner lamp controls](#)" on page 107.

### *How can I reduce the file size?*

To reduce file size:

- Save files using a compressed format, such as TIFF compressed or JPEG.
- Avoid using the True Color output type unless necessary. This output type offers exceptional quality for color photos or drawings, but it also creates large file sizes.
- Set the resolution no higher than necessary. Generally, the resolution the software automatically sets provides the best balance between image quality and small file size.
- For photos, significantly reduce file size by cropping the photo to select just one area as the final scanned image. Or, resize the entire photo to smaller dimensions.

### *Should I change the resolution?*

The HP Precisionscan Pro software sets the resolution for you based on the original document attributes. In almost all cases, you get the best results and the smallest file size using the default resolution.

### *What is the difference between screen and print quality?*

A computer screen usually displays images at 72 to 75 pixels per inch (PPI). Print resolution is usually higher. Screens also use fewer colors to display an image. Even if an image looks incorrect on the screen, it might print the way you want.

### *What is the difference between zooming and resizing?*

Use **Zoom In** to view an area of the scanned image close up. Use **Zoom Out** to return to the original view of the image.

The zoom commands do not change the final size of your scan; they just give you a different view on a monitor. To reduce or enlarge the size of the final scan, use the **Resize** command on the **Tools** menu.

### *What do I need to know about scanning text?*

When you scan an item containing text, you can use the text either as a scanned image, such as a fax or photo archive, or as text you can edit.

To have the optical character recognition (OCR) software make the text editable automatically and send the text to a supported word-processing program, press the Scan To button (). In the HP Precisionscan Pro software, choose **Scan To** from the **Scan** menu. Then choose **Text File** from the **Destination** pull-down menu and click **Scan**.

---

#### Tip

Perform a spell-check after you have successfully scanned your text to a word-processing program.

---





# 2 Scanning from scanner buttons

The scanner buttons provide an easy way to scan items directly to destinations using settings optimized for the destination you choose. You do not view or change scanned images before they go to the destination.

To view or change images, scan to the HP Precisionscan Pro software using the Scan To button (). For more help viewing or changing images, see ["Overview of the HP Precisionscan Pro software"](#) on [page 39](#).

---

**Tip** You can change the default settings for buttons on the scanner. See ["Configuring scanner buttons"](#) on [page 35](#).

---

## Overview of scanner buttons

For a list of buttons available on your scanner, see "[Front panel and accessories comparisons](#)" on page 3.

### Scan To



Scan to the HP Precisionscan Pro software. View the image or make adjustments, such as changing resolution or resizing. If your scanner also has a Select Destination button (some models only) next to the Scan To button, you can select and scan to other programs on your computer.

### Select Destination (some models only)

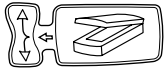

Press this button up or down to choose a program, then press the Scan To button. The Scan To button scans the item using settings optimized for that destination and sends the scan to that destination.

### Share-to-Web (some models only)



Scan a photo and send it to the HP Share-to-Web Wizard on your computer. The HP Share-to-Web Wizard uploads the image to a website.

### Photo Reprint



Scan a photo and send it to the photo printing software for printing multiple photos on one page or for creating photo album pages.



### E-mail



Scan using settings optimized for e-mail. The e-mail program window automatically launches so you can compose your message. The scanned image becomes a file attachment in the new e-mail message. If you do not have a supported e-mail program, this button allows you to save the scanned image as a file.

### Copy



Print copies using settings optimized for printing. At the computer, you can press +. (COMMAND KEY+PERIOD) to cancel the scan.



#### Number of copies (some models only)

Choose the number of copies before pressing Copy. The liquid crystal display (LCD) shows the number of copies selected.

#### Color/Black & White copy (some models only)

Choose the color or black and white setting before pressing Copy to ensure the best settings are used. Only use color copy if you are printing to a color printer and want a color copy. The light adjacent to the currently selected choice is lit.



#### More Options (some models only)

Open the HP Scanjet Controls control panel to change settings, such as resolution, for some buttons on the scanner. If your scanner does not have this button, open the HP Scanjet Controls control panel from your computer to change button settings. See "[Configuring scanner buttons](#)" on page 35.



#### Cancel (some models only)

Cancel a scan while the scanner is in the process of scanning, or cancel a series of scans from the HP Scanjet Automatic Document Feeder (ADF).



#### Power Save

Puts the scanner in an energy-conservation mode. The scanner lamp and a small indicator light near the Power Save button turn off. To use the scanner, press any button on the front panel of the scanner or start a scan from the computer. The scan begins when the lamp is ready.

## Scanning quickly with scanner buttons

Use the scanner buttons to scan quickly to a destination using settings optimized for that destination. A destination is a printer, file, or another program, such as your e-mail or word-processing program.

---

**Tip** When scanning multiple pages without using an ADF, the computer might prompt you for another page. The HP Precisionscan Pro software adds these pages to the current file. (To turn this feature off, see ["Changing settings for buttons" on page 35.](#))

---

If you are scanning slides or negatives using the HP Scanjet Transparency Adapter (XPA), you must scan from the HP Precisionscan Pro software. See ["Scanning from the XPA" on page 79.](#)

## Scanning to the HP Precisionscan Pro software

When you use the Scan To button () , you send directly to the HP Precisionscan Pro software. Using the HP Precisionscan Pro software, you can preview scanned images and make changes to the images before you send them to a destination or file them.

*To scan to the HP Precisionscan Pro software*

- 1 If your scanner has a 16-character LCD, make sure Powersave On, Ready, or HP Precisionscan appear on the LCD. (See ["Front panel and accessories comparisons" on page 3.](#))

**Note:** If another program name appears in the LCD, press the Select Destination button () up or down until HP Precisionscan is listed in the scanner's LCD.

- 2 Close the HP Scanjet Copy Utility and the HP Scanjet Controls control panel if they are open on your computer.
- 3 Place the original face down on the scanner glass and close the lid. To load items in the ADF, see ["Scanning from the ADF" on page 78.](#)
- 4 Press the Scan To button on the front panel of the scanner.
- 5 Your computer opens the HP Precisionscan Pro software. A preview of the scan appears in the Precisionscan Pro software window.

For more information, see ["Scanning from HP Precisionscan Pro" on page 39.](#)

## Scanning to another program

On some models, you can select from a list of destinations (including the HP Precisionscan Pro software) on the front panel LCD, then scan directly to the selected destination.

When you select a program other than HP Precisionscan Pro using the Select Destination button () , the scanner will automatically use settings optimized for the destination you choose. You do not view or change scanned images before they go to the destination.

### *To scan directly to another program*

- 1 Close the HP Precisionscan Pro software, the HP Scanjet Copy Utility, and the HP Scanjet Controls control panel if they are open on your computer.
- 2 Place the original face down on the scanner glass and close the lid. To load items in the ADF, see "[Scanning from the ADF](#)" on [page 78](#).
- 3 If your scanner has a Select Destination button next to the Scan To button () , press the Select Destination button up or down until the destination you want to scan to is listed in the scanner's LCD.

- 4 Press the Scan To button on the front panel of the scanner.
- 5 The item is scanned using settings optimized for the program you selected. The program launches and the scan is sent to the program.

**Note:** For information about selecting and updating the destinations for scanner buttons, see "[Changing settings for Speed Destinations \(some models only\)](#)" on [page 36](#).

---

### Tip

If your scanner does not have a Select Destination button next to the Scan To button, you can scan to other programs through the HP Precisionscan Pro software. See "[Sending to a program](#)" on [page 60](#).

---

## Sending a scan to a website

On some models, you can share images with other people by scanning directly to the Web with the Share-to-Web button (🌐➔🌐). People you know can view photos and other items by visiting your website, which will have its own address.

### *To place a scan on a website*

- 1 Close the HP Precisionscan Pro software, the HP Scanjet Copy Utility, and the HP Scanjet Controls control panel if they are open on your computer.
- 2 Place the original face down on the scanner glass and close the lid. To load items in the ADF, see "[Scanning from the ADF](#)" on [page 78](#).
- 3 Press the Share-to-Web button on the front panel of the scanner. The scanner scans the item using settings optimized for the Web. Your computer opens the **HP Share-to-Web Wizard**.
- 4 Follow the instructions on the screen to finish posting the scanned image to your website.

---

**Tip** If your scanner does not have a Share-to-Web button, scan to the Web using your HP Precisionscan Pro software. See "[Placing a scan on a website](#)" on [page 64](#)." 

---

## Scanning for photo reprints

You can scan photographs and prepare them for photo reprints by using the Photo Reprint button (🖨️➔🖨️). Photo reprints optimize the use of photo paper, allowing you to print multiple photos on one page. You can also create pages with multiple photographs for projects such as photo albums.

At the computer, use the photo printing software provided with your scanner to arrange photographs, make adjustments, and print photographs.

### *To create a photo reprint*

- 1 Close the HP Precisionscan Pro software, the HP Scanjet Copy Utility, and the HP Scanjet Controls control panel if they are open on your computer.
- 2 Place the original face down on the scanner glass and close the lid.
- 3 Press the Photo Reprint button on the front panel of the scanner. The scanner scans the item using settings optimized for photograph printing. Your computer opens the photo printing software.

## E-mailing a scan

When you send e-mail using the E-mail button () , the scanner scans the item using default settings optimized for mailing. If you have a supported e-mail program, the scanned image automatically appears as a file attachment in a new e-mail message, which you then address and send.

If your e-mail program is not supported, see [Unsupported e-mail programs](#) on this page.

---

**Tip** To view the scanned item before you send it, open the file attachment from the new e-mail message.

---

### *Supported e-mail programs*



Supported e-mail programs allow the scanner to scan an item as a file and attach it to a new e-mail message. If a scanned image automatically appears as a file attachment in a new e-mail message, your e-mail program is supported.

See "[Configuring scanner buttons](#)" on page 35 to check or change which e-mail program is set as the default.

### *Unsupported e-mail programs*

If you are using an unsupported e-mail program, such as the Web-based program Microsoft Hotmail®, the scanner cannot scan items directly into an e-mail message. Instead, the computer can prompt you to save the item as a file before the scanner completes the scan.

To enable the computer to prompt you to save an item as a file, complete the following steps:

- 1 Choose **Control Panels** from the **Apple** () menu, and then choose **HP Scanjet Controls** from the submenu.
- 2 Click the **Buttons** tab in the **HP Scanjet Controls** dialog box, and then click the **E-mail** tab.
- 3 In the **Destinations** pull-down menu, select a destination. See "[Destinations options](#)" on page 37 for more information.
- 4 Select an appropriate type of file for the destination you've selected.
- 5 Close the **HP Scanjet Controls** dialog box.
- 6 Press the E-mail button () and when prompted, save the scan.

After the scan is completed, open an e-mail message and attach the file as you normally do.

*To e-mail a scan from the scanner*

- 1 Close the HP Precisionscan Pro software, the HP Scanjet Copy Utility, and the HP Scanjet Controls control panel if they are open on your computer.
- 2 Place the original face down on the scanner glass and close the lid. To load items in the ADF, see "[Scanning from the ADF](#)" on [page 78](#).
- 3 Press the E-mail button on the scanner.

**Note:** If you do not have a supported e-mail program, the computer might open the HP Scanjet Controls control panel. See "[Unsupported e-mail programs](#)" on [page 31](#) for more information.

- 4 If the computer prompts you for an attachment file name, type a name in the **Name** box. If you need more help, see "[Naming e-mail attachments](#)" on [page 32](#).
- 5 If you have a supported e-mail program, the scanned image automatically appears as a file attachment in a new message. Address the message and send it as you normally do. If you do not have a supported e-mail program, open your e-mail program and attach the saved file.

*Naming e-mail attachments*

The computer will prompt you each time for a file name. If you do not want to be prompted, and you want the scanning software to assign an attachment name automatically, see "[Configuring scanner buttons](#)" on [page 35](#).

**Format** displays the file type for the e-mail attachment.

**Note:** If you need to send the item as a file type other than the file type shown, scan and save the item using the HP Precisionscan Pro software. See "[To save to a file](#)" on [page 61](#).



## Printing copies

You can scan an item and send it to a printer to make copies using the scanner button. At the computer, you can see the progress of the scan or you can cancel the scan. (If you cancel the scan, the printer might feed a blank page to the output bin.) Note that when you make copies, each page is treated as a separate print job, so the printer does not collate copies.

Using the scanner button allows you to scan an item and send it to a printer using default printer and scanner settings. To change the default printer or scanner settings, open the HP Scanjet Copy Utility in the HP Scanning Software folder.

On some scanner models, you can also change the number of copies or select color or black and white copies from the scanner front panel. If your scanner does not have buttons for changing the number of copies or selecting color or black and white copies, open the HP Scanjet Copy Utility to make these adjustments. (See "[Front panel and accessories comparisons](#)" on page 3.)

For more information, see "[Using the HP Scanjet Copy Utility](#)" on page 16.

### *To print copies from the scanner*

- 1 Close the HP Precisionscan Pro software, the HP Scanjet Copy Utility, and the HP Scanjet Controls control panel if they are open on your computer.
- 2 Place the original face down on the scanner glass and close the lid. To load items in the ADF, see "[Scanning from the ADF](#)" on page 78.
- 3 (Some models only, see "[Front panel and accessories comparisons](#)" on page 3.) On the scanner, select color or black and white copies.
- 4 (Some models only, see "[Front panel and accessories comparisons](#)" on page 3.) On the scanner, select the number of copies. The default setting is one copy.
- 5 Press the Copy button on the scanner. Unless you press **⌘+.** (**COMMAND KEY+PERIOD**) on the computer to cancel the scan, the number of copies specified in the scanner LCD will print directly to the default printer.

## Canceling a scan

On some scanner models, you can use the Cancel button (⏏) to cancel a scan in progress. When you press the Cancel button during a scan, the lamp returns to its starting position. If you press the Cancel button during a scan from the ADF, the ADF ejects any pages that are in the process of scanning.

For information about which scanners include a Cancel button, see "[Front panel and accessories comparisons](#)" on page 3.

---

**Tip** You can also cancel a scan by pressing ⌘+. (COMMAND KEY+PERIOD) on the computer.

---

## Using Power Save

Use the Power Save button (⏻) to conserve energy when you are not using the scanner. When you press the Power Save button, the scanner lamp and a small indicator light near the Power Save button turn off and the scanner lamp returns to its starting position.

To use the scanner again, press any button on the front panel of the scanner or start a scan from the computer. After a short warm-up cycle, the scan begins.

## Configuring scanner buttons

Each scanner button has default settings that optimize the scan for the destination (such as an e-mail program) that is associated with the button you press.

---

**Tip** To change the settings only for the current item, you might want to scan using the HP Precisionscan Pro software instead. See "[Scanning from HP Precisionscan Pro](#)" on page 39.



---

## Changing settings for buttons

You can change the default settings for individual scanner buttons. These changes are applied to all items you scan using that button until you change the settings again.

For more information about the settings you can change, see "[Settings for scanner buttons](#)" on page 37.

### *To change settings for buttons*

- 1 Do one of the following:
  - On the scanner, press the More Options button (). (Some models only, see "[Front panel and accessories comparisons](#)" on page 3.)
  - Choose **Control Panels** from the **Apple** () menu, and then choose **HP Scanjet Controls** from the submenu.
- 2 On the **Buttons** tab, click the tab for a scanner button to display the settings that you can change.

**Note:** If you click the **Scan To** tab with some scanner models, the computer displays a list of destinations (called Speed Destinations). Skip to "[To change settings for Speed Destinations](#)" on page 36 and go to step 3.
- 3 Change settings for the button. See "[Settings for scanner buttons](#)" on page 37 for more information.
- 4 Repeat steps 2 and 3 to change settings for other buttons.
- 5 To restore the default settings, repeat step 2 for any button and click **Restore Defaults**.
- 6 When finished, click the close box.



## Changing settings for Speed Destinations (some models only)

On some scanner models, you can use the Select Destination button to select a destination (called a Speed Destination) when scanning directly from the scanner front panel. You can change settings for the Speed Destinations that appear in this list using the HP Scanjet Controls control panel.

To see if your scanner model includes Speed Destinations, see "[Front panel and accessories comparisons](#)" on page 3. For more information about the settings you can change, see "[Settings for scanner buttons](#)" on page 37.

**Note:** You cannot change the **Prompt for e-mail attachment name**, **Prompt for another page**, or **Automatic Cropping** settings for the Scan To button with Speed Destinations.

### *To change settings for Speed Destinations*

- 1 Do one of the following:
  - On the scanner, press the More Options button (.
  - Choose **Control Panels** from the **Apple** () menu, and then choose **HP Scanjet Controls** from the submenu.
- 2 On the **Buttons** tab, click the **Scan To** tab. The computer displays a list of available scanning destinations and the current settings for these destinations.
- 3 Select a destination from the list, and then click **Edit**. The **Edit Destination** dialog box appears.
- 4 Change the settings for the destination. For information about these settings, see "[Settings for scanner buttons](#)" on page 37.
- 5 When finished, click **OK**. The changes you made appear in the columns next to the destination.
- 6 Repeat steps 3 and 4 to change settings for another destination.
- 7 To return to the default settings for a destination:
  - a Repeat step 3.
  - b Click **Restore Defaults**, and then click **OK**.

---

### Tip

If the destinations that appear on the scanner do not match the destinations on the **Scan To** tab of the HP Scanjet Controls control panel, click **Update Scanner** to send the new destinations to the scanner.

---

## Settings for scanner buttons

Using the HP Scanjet Controls control panel, you can change the following types of settings for the buttons on your scanner.

- Destination options (See "[Destinations options](#)" on page 37.)
- Image options (See "[Image options](#)" on page 38.)
- ADF Page Size options (See "[ADF Page Size options](#)" on page 38.)

Depending on the destination selected in the Destination pull-down menu, some options might not be available.

**Note:** Some scanner models also include Speed Destinations for the Scan To button. See "[Changing settings for Speed Destinations \(some models only\)](#)" on page 36.

### *Destinations options*

#### **Destinations**

The **Destinations** pull-down menu lists the available destinations on your computer. These destinations include the following:

- **File types:** Options include **Image**, **Text**, and **Image and Text**. Choose **Image** when scanning items that you want to be saved using an image file type, such as JPEG. Choose **Text** when scanning items containing only text that you want to edit in a word-processing program. Choose **Image and Text** when you are scanning items containing both images and text you want to edit.
- **Programs:** The HP Precisionscan Pro software recognizes the programs listed in the pull-down menu.
- **None:** When **None** is selected and you press the scanner button, the HP Scanjet Controls control panel opens on your computer, allowing you to select a destination for the scan.

#### **Type of file**

When **Image** is selected, the scanned image is saved as an image file. If the scanned image contains text, this text is not editable.

When **Text** is selected, output is converted to one column in what the software perceives to be the most logical order. Graphics or pictures from the scanned item are discarded. Use this option to make more extensive changes to text.

When **Image and Text** is selected, output is converted to a format that creates editable text. Any graphics or pictures in the scanned item are preserved.

#### **Prompt for Another Page**

When this option is selected, a prompt appears on the computer after you scan the first page of a job. The prompt asks if you have more pages to scan to this job.

When this option is not selected, you will not be prompted for more pages. Each scanning job will be treated as a single-page job.

When changing settings for Speed Destinations, this option is not available. To scan multiple pages, use the ADF or the HP Precisionscan Pro software.

#### **Prompt for e-mail attachment name**

When this option is selected, the scanning software prompts you to enter a name each time for e-mail attachments.

When this option is not selected, the scanning software assigns an attachment name automatically.

When changing settings for Speed Destinations, this option is not available. The names for e-mail attachments are generated automatically. If you need to specify names for e-mail attachments, use the E-mail button to scan the item.

### *Image options*

#### **Resolution**

Select a resolution from the pull-down menu, or type a resolution in the text box.

#### **Output Type**

From the **Output Type** pull-down menu, select one of the options below:

- **True Color** creates an image that is rendered with 24-bits per pixel per color.
- **256 Color Palette** creates an image that contains the 240 most common colors in the image, plus the 16 basic colors.
- **Grayscale** creates an image containing shades of gray, not just black and white. In a grayscale image, each pixel contains multiple bits of information, allowing more shades of gray to be recorded and displayed.
- **Black & White** creates an image that contains only black pixels and white pixels, no colors or shades of gray. Each pixel represents one bit.

For more information about using these options, see "[List of file types](#)" on page 62.

#### **Automatic Cropping**

When this option is selected, the scanner includes only the item or items placed in the top right corner of the scanner glass in the scanned image.

When this option is not selected, the scanner includes the entire area of the scanner glass, including blank areas, in the scanned image.

When changing settings for Speed Destinations, this option is not available. Instead, if the destination you are using scans the item using the **Image** option, **Automatic Cropping** is selected. If the destination scans the item using the **Text** or **Image and Text** option, **Automatic Cropping** is not selected.

### *ADF Page Size options*

If you are using an ADF with the scanner, select the size of the pages you load in the ADF:

- Letter
- Legal
- A4

For more information about loading items in the ADF, see "[Scanning from the ADF](#)" on page 78.

# 3 Scanning from HP Precisionscan Pro

Using the HP Precisionscan Pro software, you can preview scanned images and make changes to the images before you send them to a destination or file them. You start the HP Precisionscan Pro software from a scanner button or the HP Scanning Software folder on your computer.

You can also start the HP Precisionscan Pro software from another program, such as a word-processing or image-editing program, if the program is compliant with TWAIN or supports the HP Scanjet Plug-in. See "[Scanning from other programs](#)" on [page 74](#) for more information.

## Overview of the HP Precisionscan Pro software

The HP Precisionscan Pro software provides preview capabilities and tools for changing an image. Some of the changes you can make include:

- select only part of, or crop, the preview image to become the final scanned image
- change the resolution
- resize the scanned image
- change the contrast

## Starting the HP Precisionscan Pro software

To start the HP Precisionscan Pro software, press the Scan To button () , or in the HP Scanning Software folder, double-click **HP Precisionscan Pro**. The software starts.

To view the function of a command, place the cursor over the command until an explanation appears.

For more information about the types of assistance the software itself offers, see "[Finding help for using the software](#)" on this page. For more information about keyboard shortcuts, menu items, toolbars, and cursor appearance, see "[Using software commands and controls](#)" on [page 115](#).

## Finding help for using the software

The HP Precisionscan Pro software provides a variety of assistance.

### *Smart Friends*

Smart Friends are tips that appear automatically to notify you of potential problems. For example, if you are setting a very high resolution but want to use e-mail to send the scanned image, a Smart Friend would alert you that the file will probably be too large to e-mail. To turn individual messages off, select the **Don't remind me again** check box in the message's dialog box. To turn all messages off, click **Disable All Smart Friends** on the **Help** menu. To turn all messages back on, click **Enable All Smart Friends**.

### *Online Help*

The online Help is an easy-to-use source of information about using the scanner and software, troubleshooting, support, and specifications. To gain access to the Help: on the **Help** menu, click **HP Precisionscan Pro 3.1 Help**. Or, click the **Help** button in any dialog box in which it appears.



## Performing a new scan

Once you start a new scan, the scanner does a preliminary scan of the item and displays the scanned image in the HP Precisionscan Pro software. Then, you can see the scanned image and edit it, if necessary, before sending it to a destination or saving it as a file.

### *To start a new scan*

Use these steps to start a scan from the HP Precisionscan Pro software. To start a scan from a scanner button, see "[Scanning quickly with scanner buttons](#)" on page 28.

- 1 Place the original face down on the scanner glass and close the lid.

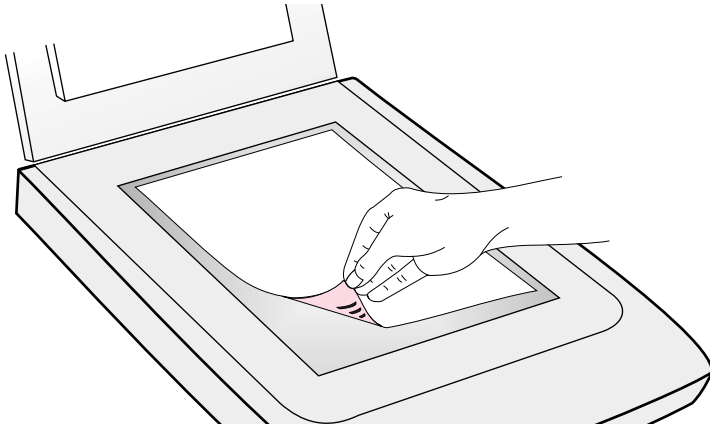

**Note:** To load items in the HP Scanjet Automatic Document Feeder (ADF), see "[Scanning from the ADF](#)" on page 78.

- 2 Start the scan in one of these ways:

- In the HP Precisionscan Pro software, click  on the toolbar.
- In the HP Precisionscan Pro software, click **New Scan** on the **Scan** menu.

The scanned image appears in the HP Precisionscan Pro software. This scanned image is the preview image. You can make changes, such as selecting only part of the image or adjusting the contrast.

When you send the image to another program such as e-mail, place the image on a website, or save it as a file, the scanner performs a final scan of the item that includes any changes you made. Directions for making optional adjustments and completing the scan appear in this section.

## Cropping or selecting an area for final scan

Once a scanned image appears in the HP Precisionscan Pro software, you must select which area becomes the final scanned image by creating a selection area. When you create a selection area, a dotted selection border appears around the area:



For information about the appearance of the cursor when it is over an area of the selection border, see ["Context-sensitive cursors" on page 121](#).

### Tip

If you only want to look more closely at an area without changing what will be included in the final scan, see ["Getting a closer look \(zooming\)" on page 43](#).

*To crop or select an area for final scan*

Do one of the following:

- Move the cursor over the area you want and click.
- When the cursor looks like this: , click on one corner of the area you want and drag the cursor to the opposite corner to draw a rectangular selection area.
- On the **Edit** menu, click **Select All**. The entire scanner bed, including blank areas, is selected.

*To change the selection area*

Click the edge of the selection border and drag to change the selection area.

*To move the selection border*

Move the cursor over the selection area. When the cursor looks like this: , click and drag the selection border to the new location.

*To remove the selection border*

Do one of the following:

- Press **Esc**.
- On the **Edit** menu, click **Unselect All**.

## Getting a closer look (zooming)

Zoom in on the selection area to look at it more closely or make changes to it. Zoom out to view the entire preview image, or so you can select a different area of the image to view. Zooming in on the selection area before making changes or performing a final scan provides the best final results. The zoom commands are not available if you have not created a selection area.

Zooming in and out *does not* change which part of the image becomes the final scan, nor does it change the final output size (physical output dimensions). To change which part of the image becomes the final scanned image, see "[Cropping or selecting an area for final scan](#)" on [page 42](#). To resize the image, see "[Resizing \(output dimensions\)](#)" on [page 45](#).

### *To zoom in*

After creating a selection area, do one of the following:

- On the **View** menu, click **Zoom in**.
- Click .

### *To zoom out*

Do one of the following:

- On the **View** menu, click **Zoom out** to return to the original view of the image.
- Click .

## Selecting output type

When **Automatically Set Type** is selected, the scanning software automatically chooses an output type based on the type of item you are scanning. However, you can change the output type yourself when you want. Choose the output type based on how you will use the final scanned image as well as the type of item you are scanning.

### *To select an output type*

1 Do one of the following:

- If it is not already selected, click **Automatically Set Type** on the **Output Type** menu, to allow the software to choose the best output type for this type of original item.
- To change the output type only for this scan, keep **Automatically Set Type** selected and select an output type you want from the **Output Type** menu. See "[List of output types](#)" on [page 44](#).
- To change the output type for this scan and all other scans in this session, clear **Automatically Set Type** and select an output type you want from the **Output Type** menu. See "[List of output types](#)" on [page 44](#).

---

### Tip

When you redraw the selection border, the output type might change if **Automatically Set Type** is selected in the **HP Precisionscan Pro Preferences** dialog box.

---

*List of output types*

For these uses	Use this output type
Color photos or drawings with lots of shading to be: <ul style="list-style-type: none"> <li>● printed on a color printer</li> <li>● displayed on a color monitor set to millions of colors</li> <li>● displayed on Web and saved in the JPEG or PNG file format</li> </ul>	True Color
Color photos or drawings with shading to be: <ul style="list-style-type: none"> <li>● printed to a color printer</li> <li>● sent via e-mail</li> <li>● used in any way that requires a small file size</li> <li>● viewed on a computer screen</li> </ul>	Optimized Palette
Color photos or drawings with shading to be: <ul style="list-style-type: none"> <li>● printed to a color printer</li> <li>● displayed on a monitor set to 256 colors</li> <li>● displayed on Web and saved as a GIF file</li> </ul>	System Palette
Color photos or drawings with shading to be printed to a B&W printer.	Grayscale
B&W photos and drawings with shading to be used for any purpose.	Grayscale
B&W drawings without shading to be placed in another program without resizing in the other program.	Black & White Bitmap
Any image to be saved in GIF file format and displayed on the Web.	Web Palette
Color drawings or logos without much shading and with a concentrated area of a single color. The image is to be used for any purpose.	Spot Color

*To reset output type*

On the **Output Type** menu, click **Automatically Set Type**. The software chooses the best output type based on the image inside the selection area.

## Making optional adjustments, basic

These tools are needed most often, but using any of them is optional. Depending on the output type chosen, some tools will not be available.

**Note:** When a tool is open on the desktop, the HP Precisionscan Pro software scans the item using the current settings in the tool. However, these settings might not be the best settings for the type of item being scanned. To enable the scanner to scan using the best settings automatically, close the tool.

## Resizing (output dimensions)

You can resize the image before you do the final scan by changing the output dimensions. Resizing the scanned image to the actual dimensions you need before performing the final scan helps ensure the best image quality.

---

**Tip** If you need to resize images to fit in a file, such as word-processing document, resize them here in the scanning software. Resizing images in the other program may cause them to be fuzzy or have jagged edges.

---

*To resize an image*

- 1 On the **Tools** menu, click **Resize**. The Resize dialog box opens.
- 2 Do one of the following:
  - If necessary, select a unit of measure in the **Units** field. In the Output Dimensions area, type a new value in the **Width** or **Height** field and press **ENTER**.
  - In the **Scale** field, select a scale percentage.

New values appear in the **Scale**, **Width**, and **Height** fields, but the selection area and the scanned image on screen remain the same. Resizing occurs when you complete the scan.

- 3 If you want, click . This locks the output dimensions you defined so you can change the selection area without changing the output dimensions. When you change the selection border, the software resizes the border proportionally. The output dimensions remain the same.

## Changing resolution

Resolution determines the amount of data in a scanned image. The scanning software chooses the optimal resolution based on the output type. This resolution generally does not need to change.

If you do change the resolution, choose one no higher than the capabilities of the monitor or printer and one appropriate for the type of scanned image. For example, to print on a 600 dpi printer, choose 600 for black and white bitmap images, but choose only 200 for color or grayscale images. These resolutions produce optimal quality while keeping file sizes small.

Selecting higher resolutions for color images increases file size while not increasing quality. If you double the resolution, the file size quadruples. Large file sizes can prevent you from doing certain tasks, such as e-mailing, or can take up too much space on your computer.

For help choosing a resolution based on the type of original item and destination, see ["Tips for best image quality" on page 69](#).

### *To open the Resolution tool*

On the **Tools** menu, click **Resolution**.

**Note:** When the Resolution tool is enabled, a checkmark appears beside the **Resolution** command in the **Tools** menu, and the Resolution tool appears in the toolbar.

### *To change resolution*

- 1 Open the Resolution tool, if it is not already open.
- 2 Do one of the following:
  - Select a value from the list.
  - Type a value between 12 and 999,999 in the field and press **ENTER**.

The resolution changes as soon as you select a value.

### *To reset resolution*

- 1 Open the Resolution tool, if it is not already open.
- 2 Click  .

## Changing contrast



The contrast is controlled by the midtone, highlight, and shadow settings. See ["Changing midtones" on page 50](#), ["Changing highlights" on page 51](#), and ["Changing shadows" on page 52](#).

## Rotating an image

You can rotate the image in 90-degree increments clockwise or counterclockwise. You might need to rotate the image if you placed the bottom of the item at the top of the scanner glass, or if the item was sideways. Items such as negatives in their template often scan sideways.

### *To rotate an image*

Do one of the following:

- *To rotate an image clockwise:* On the **Tools** menu, click **Rotate right 90°**. Or, click  on the toolbar. Repeat to continue turning.
- *To rotate an image counterclockwise:* On the **Tools** menu, click **Rotate left 90°**. Or, click  on the toolbar. Repeat to continue turning.

## Mirroring (reversing) an image

You can mirror, or reverse, an image from side to side on the vertical axis. Mirroring an image allows you to see the elements of the image on the opposite side of their actual position. Mirroring can be particularly useful for items such as negatives that might be placed in their template backward and scanned in reverse.

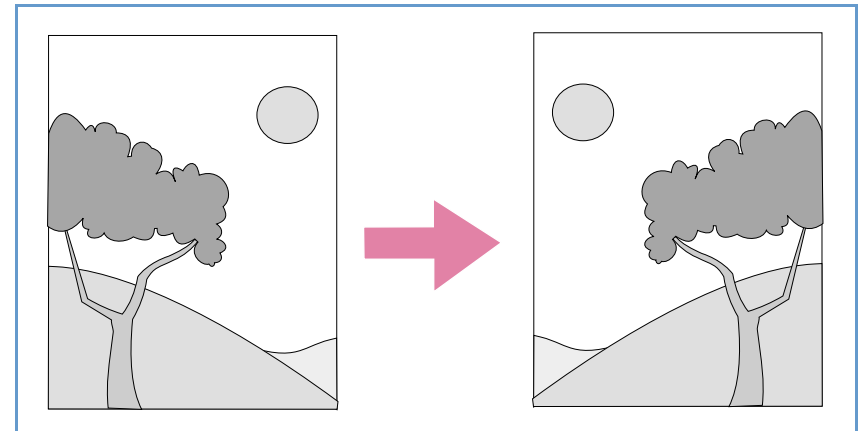

### *To mirror (reverse) an image*

On the **Tools** menu, click **Mirror**. Repeat to return to the original layout.

## Sharpening an image

Increasing sharpening enhances detail in the image. The HP Precisionscan Pro software automatically selects the optimal sharpen level, but you can change it.

You might want to increase sharpening if the image looks fuzzy. Conversely, you might want to decrease sharpening if the original item has flaws or marks on it. Increasing sharpening, or increasing it too much, can accent the flaws and create undesirable patterns.

*To open the Sharpen tool*

On the **Tools** menu, click **Sharpen**.

**Note:** When the Sharpen tool is enabled, a checkmark appears beside the **Sharpen** command in the **Tools** menu, and the Sharpen tool appears in the toolbar.

*To sharpen an image*

- 1 Open the Sharpen tool, if it is not already open.
- 2 Select a sharpen level from the list. Check the preview image to see the effects of the change.

**Note:** To see the effects of the new sharpen level more easily, zoom in on the selection area. See "[Getting a closer look \(zooming\)](#)" on page 43.

*To reset sharpen levels*

- 1 Open the Sharpen tool, if it is not already open.
- 2 Click .

## Resetting all adjustments

You can reset images to the optimal (default) values the scanning software chose for the image. Optimal values are based on the output type selected. Resetting removes all adjustments you have made except the output type, zoom level, or the selection area.

*To reset all adjustments*

Do one of the following:

- On the **Edit** menu, click **Reset Tools**.
- On the toolbar, click .



## Making optional adjustments, advanced

These optional adjustments are ones that most people generally do not use or need, but some advanced users might want them for special effects or other needs. Depending on the output type chosen, some tools are not available.

**Note:** When a tool, such as Invert Colors, is open on the desktop, the HP Precisionscan Pro software scans the item using the current settings in the tool, instead of using automatic adjustment features. To enable the HP Precisionscan Pro software to use automatic adjustment features, close the tool. For more information, see "[Setting preferences](#)" on page 70.

## Inverting the image

Use the Invert command to convert white areas of an image to black and black to white. For color images, a color is converted to its complementary color. Generally, this command is useful for drawings and spot color images.

### *To invert the image*

On the **Advanced** menu, click **Invert Colors**. Repeat to reverse the colors again.

## Changing midtones

The midtone setting lets you lighten or darken the middle values in an image. The range for the number in the **Midtone** field is 1.0 to 4.0. Moving toward 1.0 darkens the image. Moving toward 4.0 lightens the image.

To adjust midtones for slides, negatives, or other transparent items, use "[Adjusting midtones for slides or negatives](#)" on page 83.

Midtone set at 1.8  
(the default)



Midtone set at 3.0



*To lighten the image overall*

- 1 On the **Advanced** menu, click **Adjust Exposure**.
- 2 Do one of the following:
  - Drag the Midtone slider to the right.
  - Type a higher number in the **Midtone** field and press **ENTER**.
  - Click the **Up** arrow next to the **Midtone** field.

*To darken the image overall*

- 1 On the **Advanced** menu, click **Adjust Exposure**.
- 2 Do one of the following:
  - Drag the Midtone slider to the left.
  - Type a lower number in the **Midtone** field and press **ENTER**.
  - Click the **Down** arrow next to the **Midtone** field.

*To return to the default settings*

- 1 On the **Advanced** menu, click **Adjust Exposure**.
- 2 Click **Auto** to return the midtone, highlight, and shadow to the default settings for this scanned image. Clicking **Auto** also returns output levels to the defaults. See "[Setting pixel output levels](#)" on page 54.

### Tip

If you are sharing the image with others who will be viewing it on a computer screen, the Midtone value 2.2 is recommended because it is an average value that works with many different monitors.

## Changing highlights

The highlight is the value in the image that is represented on the screen as white. All values lighter than the highlight also appear as white.

The image has a default highlight setting. Selecting a higher number makes more of the lighter values distinct, which increases detail in light areas. Selecting a lower number makes fewer of the lighter values distinct, which reduces detail in the light areas.

To adjust highlights for slides, negatives, or other transparent items, use "[Adjusting highlights for slides or negatives](#)" on page 84.

Highlights set at 215



Highlights set at 122



*To increase detail in lighter areas*

- 1 On the **Advanced** menu, click **Adjust Exposure**.
- 2 Do one of the following:
  - Drag the Highlight slider toward the right.
  - Type a higher number in the **Highlights** field and press **ENTER**.
  - Click the **Up** arrow next to the **Highlight** field.

*To decrease detail in lighter areas*

- 1 On the **Advanced** menu, click **Adjust Exposure**.
- 2 Do one of the following:
  - Drag the Highlight slider toward the left.
  - Type a lower number in the **Highlights** field and press **ENTER**.
  - Click the **Down** arrow next to the **Highlight** field.

*To choose a value as the highlight value*

Click  (white eyedropper). When the cursor changes to the eyedropper, move it over the area you want to be the highlight and click.

*To return to the default settings*

- 1 On the **Advanced** menu, click **Adjust Exposure**.
- 2 Click **Auto** to return the midtone, highlight, and shadow to the default settings for this scanned image. Clicking **Auto** also returns output levels to the defaults. See "[Setting pixel output levels](#)" on page 54.

## Changing shadows

The shadow is the value in the image that is represented on the screen as black. All values darker than the shadow also appear as black.

The image has a default shadows value. Selecting a higher number makes more of the darker values distinct, which increases detail in dark areas. Selecting a lower number makes fewer of the darker values distinct, which reduces detail in the dark areas.

To adjust shadows for slides, negatives, or other transparent items, use "[Adjusting shadows for slides or negatives](#)" on page 84.

Shadow set at 10



Shadow set at 3



*To increase detail in darker areas*

- 1 On the **Advanced** menu, click **Adjust Exposure**.
- 2 Do one of the following:
  - Drag the Shadows slider toward the right.
  - Type a higher number in the **Shadows** field and press **ENTER**.
  - Click the **Up** arrow next to the **Shadows** field.

*To decrease detail in darker areas*

- 1 On the **Advanced** menu, click **Adjust Exposure**.
- 2 Do one of the following:
  - Drag the Shadows slider toward the left.
  - Type a lower number in the **Shadows** field and press **ENTER**.
  - Click the **Down** arrow next to the **Shadows** field.

*To select a value as the shadow value*

Click  (black eyedropper). When the cursor changes to the eyedropper, move it over the area you want to be the shadow and click.

*To return to the default settings*

- 1 On the **Advanced** menu, click **Adjust Exposure**.
- 2 Click **Auto** to return the midtone, highlight, and shadow to the default settings for this scanned image. Clicking **Auto** also returns output levels to the defaults. See "[Setting pixel output levels](#)" on page 54.



## Checking for clipped areas

The lightest or darkest areas of an image that will print without any detail in them are known as clipped areas. The lightest areas, or highlights, will print as the color of the paper (without ink or toner) and therefore will have no detail. The darkest areas, or shadows, will print saturated in the blackest color of ink or toner, and therefore will also have no detail.

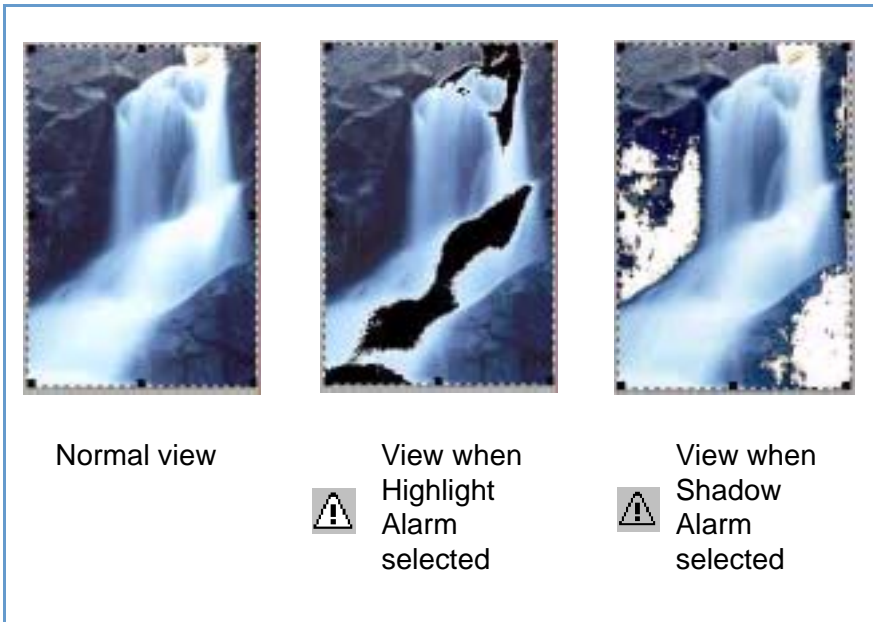

You can view and change clipped areas if you want those areas to contain detail when they print.



*To view and change clipped light (highlight) areas*

- 1 On the **Advanced** menu, click **Adjust Exposure**.
- 2 Click  (Highlight Alarm). The light areas in the image that will print as white (no detail) appear black.
- 3 In the **Highlights** setting, click the **Up** arrow repeatedly until the clipped pixels disappear from the image. The result of the change can be seen.
- 4 Click  again to turn the Highlight Alarm off.

*To view and change clipped dark (shadow) areas*

- 1 On the **Advanced** menu, click **Adjust Exposure**.
- 2 Click  (Shadow Alarm). The darker areas in the image that will print as black (without detail) appear white.
- 3 In the **Shadow** setting, click the **Down** arrow repeatedly until the clipped pixels disappear from the image. The result of the change can be seen.
- 4 Click  again to turn the Shadow Alarm off.

## Setting pixel output levels

The output levels setting lets you create interesting effects for scanned pictures. When you select this command, the Black and White output levels appear. By default, white is set to 255, and black is set to 0.

Decreasing the White output level makes the overall image darker.

Increasing the Black output level makes the image more faded.

Changing the White output level value to 0 and the Black output level value to 255 inverts the colors in the image.

To change the ranges for the numbers in the **White** and **Black** fields, see the **Controls** tab of ["Setting preferences" on page 70](#).

---

**Tip** To use an image as a light background for dark text, such as for an overhead transparency, increase the Black output level until the image is as faint as you want.

---

### *To change output levels*

- 1 On the **Advanced** menu, click **Adjust Exposure**.
- 2 Click the triangle at the bottom of the dialog box to display the current White and Black output levels.
- 3 To change the levels, do one of the following:
  - Click one side of a slider.
  - Type a different number in the **White** or **Black** field and press **ENTER**.
  - Click the **Up** or **Down** arrow next to the **White** field or **Black** field.

The result of the changes to output levels can be seen in the preview area.

### *To return to the default settings*

- 1 On the **Advanced** menu, click **Adjust Exposure**.
- 2 Click **Auto** to return the midtone, highlight, shadow, and output levels to the default settings for this scanned image.

## Viewing RGB values and pixels

You can view the RGB values and pixel color for any spot in a color or grayscale image using the RGB meter.

To view the RGB values and pixel color for slides, negatives, or other transparent items, use "[Viewing RGB values and pixel color](#)" on [page 85](#).

*To view the RGB values and pixels*

- 1 On the **Advanced** menu, click **Adjust Exposure**.
- 2 Move the pointer over the image. The RGB values and pixel color appear in the RGB meter.

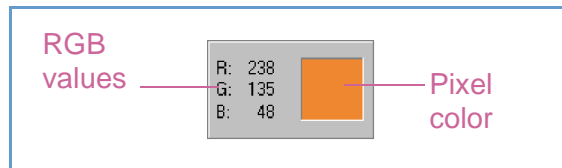

**Note:** Do not click while the eyedropper pointer is over the image unless you want to change the setting for highlight or shadow.

- 3 Click the same eyedropper button again. The RGB meter dims and the cursor returns to normal.

## About the histogram

The histogram is a graph of the distribution of pixels in the selection area. The magenta line represents the current setting for shadow. The red line represents the current setting for highlight. The midtone setting is not represented.

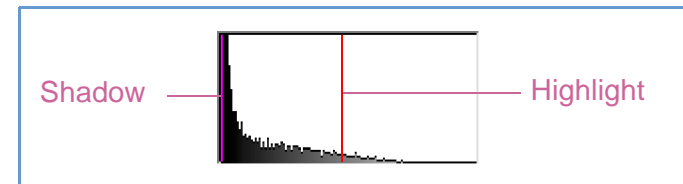

The turquoise line appears in the histogram when either eyedropper cursor is positioned over the image. This line shows you where in the histogram the pixels in that area of the image occur.

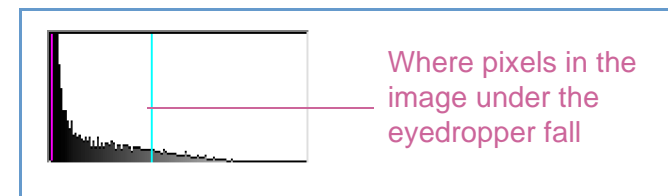

The histogram represents pixel distribution in the preview image, not in the final scanned image. Changing the selection area changes the histogram. Changing the setting for highlight or shadow does not change the histogram.



## Changing the hue

Color in an image consists of its hue and the saturation. Hue refers to the overall color cast of the image.

The software sets the hue for an image, but you can change it. You might want to change it if the image has too much of one color, or if you want to create a special effect.

### *To change the hue*

- 1 On the **Advanced** menu, click **Adjust Color**.

Change the overall color of the image by doing one of the following on the color wheel.

- Drag the indicator circle to a new area.
- Click the arrow for a color on the outer edge of the wheel.

The result of the change can be seen in the image.

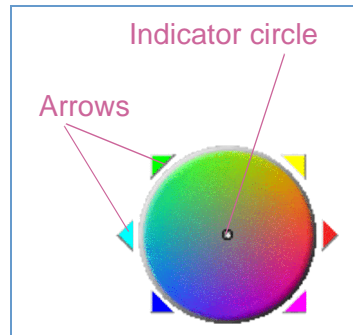

---

**Tip** If the image has too much of one color, move the indicator circle away from that color.

---

### *To return to the default settings*

- 1 On the **Advanced** menu, click **Adjust Color**.
- 2 Click **Auto** to return to the default hue and saturation settings for this scanned image.

## Changing the saturation

Color in an image consists of its hue and the saturation. Saturation refers to the intensity of the colors.

The software sets the saturation for an image, but you can change it. You might want to change it to make colors in the image more or less vivid, or to create a special effect. The range in the **Saturation** field is 0 to 150.

### *To increase saturation*

- 1 On the **Advanced** menu, click **Adjust Color**.
- 2 Make colors more vivid by doing one of the following:
  - Click to the right of the slider.
  - Type a higher number in the **Saturation** field and press **ENTER**.
  - Click the **Up** arrow next to the **Saturation** field.

### *To decrease saturation*

- 1 On the **Advanced** menu, click **Adjust Color**.
- 2 Make colors less vivid by doing one of the following:
  - Click to the left of the slider.
  - Type a lower number in the **Saturation** field and press **ENTER**.
  - Click the **Down** arrow next to the **Saturation** field.

### *To return to the default settings*

- 1 On the **Advanced** menu, click **Adjust Color**.
- 2 Click **Auto** to return to the default hue and saturation settings for this scanned image.



## Changing the black and white threshold

Changing the black and white threshold only applies to images using the Black & White Bitmap output type. The threshold is a value in the image that represents the border between black and white. All values in the image that are lighter than the threshold appear as white, and all values darker appear as black.

The image has a default threshold value. Choosing a number closer to zero makes more values appear as white. Choosing a higher number makes more values appear as black.

Threshold at 127  
(the default for this image)



Threshold at 45



*To change the black and white threshold*

- 1 Make sure that **Black & White Bitmap** is selected on the **Output Type** menu. The selection should have a dot beside it.
- 2 On the **Advanced** menu, click **Adjust Black & White**.
- 3 Do one of the following:
  - Drag the slider.
  - Type a new value in the field and press **ENTER**.
  - Click the **Up** or **Down** arrow next to the field.

*To reset the black and white threshold*

- 1 On the **Advanced** menu, click **Adjust Black & White**.
- 2 Click **Auto**.

## Setting which colors become black or white in black & white bitmaps

This procedure only applies to color images that will be using the Black & White Bitmap output type. It allows you to create special effects, or to correct for originals on colored paper.

Images consist of pixels. In color images, each pixel has a varying amount of Red, Green, or Blue to create its specific color. You can determine whether the Red, Green, or Blue in each pixel turns to black or white in the final scanned image.

*To set which colors become black or white in black & white bitmaps*

- 1 Make sure that **Black & White Bitmap** is selected on the **Output Type** menu. The selection should have a dot beside it.
- 2 On the **Advanced** menu, click **Adjust Black & White**.
- 3 Select a color channel from the **Scan using channel** list.
  - Choose **Red** to change the red in the image to white. Green and blue become black. Useful for originals printed on pink or red paper.
  - Choose **Green** to change the green in the image to white. Red and blue become black. Useful for originals printed on green paper.
  - Choose **Blue** to change the blue in the image to white. Red and green become black. Useful for originals printed on blue paper.
  - Choose **NTSC Gray** to convert light shades of all colors to white and dark shades of all colors to black. (No one color becomes all white or all black.) Colors are converted to gray at a ratio of 30% red, 59% green, and 11% blue.

*To reset to the default colors*

- 1 Make sure that **Black & White Bitmap** is selected on the **Output Type** menu. The selection should have a checkmark beside it.
- 2 On the **Advanced** menu, click **Adjust Black & White**.
- 3 Choose **NTSC Gray** from the **Scan using channel** list.
- 4 Click **Auto**.

## Descreening images

Use the **Descreen** command to reduce undesirable patterns in printed items you are scanning. An example of an undesirable pattern is a moiré pattern, or the circles that often appear on pictures printed in newspapers.

Note that scanning takes longer when this command is selected. Use Descreen only when you see undesirable patterns on the scan of a printed original. When Descreen is turned on or off, a new preview scan starts and image adjustments are reset.

### *To descreen images*

On the **Advanced** menu, click **Descreen**. Select the option again to turn it off.

## Resetting all adjustments

You can reset images to the optimal (default) values the scanning software chose for the image. Optimal values are based on the output type selected. Resetting removes all adjustments you have made except the output type, zoom level, or the selection area.

### *To reset all adjustments*

Do one of the following:

- On the **Edit** menu, click **Reset Tools**.
- On the toolbar, click .

## Completing the final scan

When you finish making changes, you need to complete the final scan by doing one of these tasks:

- [Sending to a program](#). See this page.
- [Returning the image to a program that supports TWAIN or the HP Scanjet Plug-in](#). See page 61.
- [Saving to a file](#). See page 61.
- [Printing](#). See page 63.
- [Placing a scan on a website](#). See page 64.
- [Preparing a scan for online viewing](#). See page 64.
- [Copying and pasting into another program](#). See page 65.
- [Dragging-and-dropping into another program](#). See page 66.
- [Dragging-and-dropping to the desktop or a folder](#). See page 66.
- [Scanning to CD](#). See page 67.

When you do any of these procedures, the scanner performs a final scan including your changes before sending it to the program or printer you choose, copying the image, or completing any other function.

Images are not automatically saved as files if you print them, send them to a another program, or copy and paste them into a file in another program. To use the scanned image again, be sure to save it. See "[Saving to a file](#)" on page 61.

## Sending to a program

Once you finish viewing and changing the scanned image, you can perform a final scan and send it directly to a program such as e-mail. If the program you want is not available, save the image as a file and insert it into the destination program as you normally would.

---

### Tip

If you send text to Word or another word-processing program and the text appears inside a frame you do not want, double-click the frame border and click **Remove Frame** or a similar command. To prevent this from happening in the future, see "[Setting preferences](#)" on page 70.

---

### *To send to a program*

- 1 On the **Scan** menu, click **Scan To**.
- 2 Choose a program from the list and click **Scan**.
- 3 If the program you select accepts multipage files, you might be asked if you have more pages to scan to this file. Do one of the following:
  - If this is a one-page item, click **Done**.
  - If there are more pages of this item, load the next page in the scanner and click **Scan** on the computer. Repeat until all pages are scanned. Then, click **Done**.

The destination program opens and displays the scanned image.

## Returning the image to a program that supports TWAIN or the HP Scanjet Plug-in

If you started the scan from a program that supports TWAIN or the HP Scanjet Plug-in, you can perform a final scan and return the image to that program using this procedure. For more information about scanning using TWAIN or the HP Scanjet Plug-in, see "[Scanning from other programs](#)" on page 74.

*To return the image to a program*

Do one of the following:

- On the **Scan** menu, click **Return Image To**.
- On the toolbar, click .

## Saving to a file

Save scanned images as files when you want to use the images again later. For help deciding on which file type to use, see "[List of file types](#)" on page 62, or see "[Tips for best image quality](#)" on page 69. For definitions of File types, see the "[Glossary](#)" on page 123.

*To save to a file*

- 1 Do one of the following:
  - On the **Scan** menu, click **Save As**.
  - On the toolbar, click .
- 2 Select a file type. See "[List of file types](#)" on page 62.
- 3 Select a name and location for the file and click **OK**.
- 4 If the **Options** button is available, more options are available for this file type. Click **Options**, change any options you want, and click **OK**.

The file type you need depends on how you will use the file. And, some file types are not available when certain output types are selected.

*To save a scan for future processing in an OCR program*

If you plan to process a scanned document with your optical character recognition (OCR) software, use the following settings:

- **Resolution:** 300
- **Output type:** Black & White Bitmap
- **Format:** TIFF

**Note:** Selecting higher resolutions than 300 dpi will not increase OCR accuracy.

### List of file types

#### Image file formats

- **GIF.** GIF is a compressed file format suitable for an image that will be used on the Web or on multiple platforms. Cannot be used with True Color output type.
- **JPEG.** JPEG is a compressed file format for images. Its strengths are small file sizes and speed. The trade-off for these advantages, though, is reduced image quality. Because each time an image is compressed with JPEG it loses a little of the image data, avoid compressing a file with JPEG more than once. JPEG is an appropriate file format for an image that will be used on the Web or on multiple platforms.  
You can save your JPEG file as a progressive JPEG. When used on a Web page, a progressive JPEG is initially sent as just every other line, with the remaining lines sent immediately after. This allows a (somewhat blurry) image to display sooner. Most people prefer this. JPEG can be used only with True Color and Grayscale output types.
- **PNG.** A compressed image file format that might replace GIF. Like GIF, PNG uses non-lossy compression, which means all the visual data is saved and restored when the file is decompressed. Unlike GIF, PNG can be used with True Color and Grayscale output types.
- **PICT.** Apple's proprietary image file format that is used by the Macintosh operating system. Designed for the screen, this format is best used for color images that will not be printed. Images saved as PICT files are smaller in size than images saved as a TIFF files.
- **PDF.** PDF is a format useful for text, photos, and drawings. Use Adobe Acrobat Reader to view PDF files. If no changes need to be made to the file, this file type is useful for sharing (as through e-mail) and filing because of its generally small file size. When using the Macintosh version of the scanning software, you can only create image-only PDF files; you cannot copy text from these files.

- **TIFF.** Usually created by scanners, TIFF files are widely accepted by programs that work with photographs and other images. A TIFF file is a bitmapped graphic (also called a raster graphic) and can be any resolution. TIFF image files can be used on multiple platforms.
- **TIFF compressed.** TIFF compressed files for images are smaller than standard TIFF files.

#### Text or text-and-image file formats

- **HTML.** HTML is useful for text and graphics that will be viewed on the World Wide Web. When this format is selected for a scanned image containing both text and images, the text is converted to editable text and is saved as HTML, and the graphics are saved as GIF or JPEG files.
- **Rich Text.** The RTF format can be used with a page that contains text or text and pictures. The formatting of text in an RTF file can usually be retained and then interpreted by other programs.
- **Text.** Use text file format for saving only the text in the selection area. Text will be editable, unformatted, ASCII text.

## Printing

The selection area is the part of the image that prints. If there is no selection border, the contents of the entire scanner bed, including blank areas, print.

Printing does not save the image to the computer. Save the scanned image to a file to use the image later.

### *To print*

- 1 Do one of the following:
  - On the **Scan** menu, click **Print**.
  - On the toolbar, click .
- 2 In the **Print** dialog box, select the options you want and click **OK**.

## Placing a scan on a website

You can share images with other people by scanning directly to the Web. People you know can view photos and other items by visiting your website, which will have its own address.

---

**Tip** If you want to place a scan on a site other than an HP Share-to-Web website, save the scanned image as a file and then place the file on the site as you normally do. See "[Preparing a scan for online viewing](#)" on page 64.

---

### *To place a scan on a website*

- 1 Do one of the following:
  - On the **Scan** menu, click **Scan To**.
  - On the toolbar, click .
- 2 Select **HP Share-to-Web** from the list and click **Scan**.
- 3 Follow the instructions on the screen to finish posting the scanned image to the website.

## Preparing a scan for online viewing

There are many website development applications, or HTML editors, available. These applications help you develop websites, and they support a variety of graphic file formats. However, not all Web browsers can display all the file formats that website development applications support.

With the HP scanning software, you can scan your text or images, make adjustments to these scans, and then prepare them for the World Wide Web.

### *Optimizing a scan for online viewing*

To optimize a scan for a website, be sure to do the following:

- Save scans as GIF, JPEG, or PNG files. (Most Web browsers use these file formats.)
- For color images, choose the Web Palette output type.
- Select a resolution of 72 dpi. (This resolution produces smaller file sizes than higher resolutions, and the images still look good on the computer screen.)
- Scale or resize your scanned image in the scanning software before inserting the image into your document.



### *To scan an item for a website*

To scan an item for placement on a website, use one of the following methods:

- **Drag-and-drop from the scanning software**  
If your website development application supports drag-and-drop, you can drag the image from the Preview area of the scanning software and drop it into the open Web page where you want it. Some website development applications have image editing capabilities if you want to adjust the image further. See the documentation that came with the website development application for more information.
- **Save the image as a file**  
You can save the image as a file in the scanning software, and then insert that file into your website development application. Remember to save the file as a GIF, JPEG, or PNG file.
- **Copy and paste the image**  
You can use the scanning software's Copy command or icon to copy the image to the Clipboard. In the website development application, use the Paste command to paste the image into the open Web page.
- **Use the Scan To command**  
You can use the scanning software's **Scan To** command in the **Scan** menu to scan the image to a text file. Then, in the **Save** dialog box, select **HTML** in the **Format** pull-down menu.

## Copying and pasting into another program

You can copy the scanned image to the Clipboard and then paste it into a file in the destination program. After the image is pasted, it becomes a part of the file.

### *To copy and paste into another program*

- 1 In the HP Precisionscan Pro software, do one of the following:
  - On the **Edit** menu, click **Copy**.
  - On the toolbar, click .
- 2 In the destination program, place the cursor where you want to insert the scanned image and click.
- 3 Choose the **Paste** command in the program.

## Dragging-and-dropping into another program

You can drag-and-drop a scanned image into another program if that program supports drag-and-drop. If the program does not support drag-and-drop, the selection area returns to the scanning software window.

### *To drag-and-drop into another program*

- 1 Open a file in the destination program. Make sure you can see both the destination program and the HP Precisionscan Pro software.
- 2 In the HP Precisionscan Pro software, place the cursor over the scanned image.
- 3 While pressing **OPTION**, click inside the selection area and drag to the location in the destination program. Then, release the mouse button and **OPTION**. Wait for the scanner to perform a final scan of the image.

## Dragging-and-dropping to the desktop or a folder

Scanned images you drag-and-drop to the desktop or a folder become a Scrapbook picture clipping file. The bitmap file is given a generic name such as “picture clipping.” *Subsequent images scanned to the desktop or that folder are numbered sequentially.*

### *To drag-and-drop to the desktop or a folder*

- 1 Make sure you can see both the HP Precisionscan Pro software and the desktop or the folder you want.
- 2 In the HP Precisionscan Pro software, place the cursor over the scanned image.
- 3 While pressing **OPTION**, click inside the selection area and drag to the desktop or folder. Then, release the mouse button and **OPTION**. Wait for the scanner to perform a final scan of the image.

## Scanning to CD

The Scan to CD function is a quick, convenient way to scan and save scanned items to a rewritable CD. This feature is a helpful shortcut for people who frequently archive or store scans on CDs. To scan to a CD, you must have CD-writer hardware installed and have a rewritable CD available.

### *To scan to CD*

- 1 Start a new scan, and make any adjustments you want in using the scanning software.
- 2 In the HP Precisionscan Pro software, do one of the following:
  - On the **Scan** menu, click **Scan to CD**.
  - On the toolbar, click  (Scan to CD).A **Save As** dialog box appears.
- 3 If a CD-writer drive is installed, this drive is automatically listed at the top of the dialog box. If you have created folders on your CD to organize images, select the desired folder in which to save the scan.
- 4 Type in a file name.
- 5 In the **Format** pull-down menu, select the file type. To change the file type, select a different file type in the drop-down list.
- 6 Click **Save**.

## Other features and tips

In this section, you can find information about:

- Which settings to use to get the best image quality. (See "[Tips for best image quality](#)" on page 69.)
- How to save a group of settings you use all the time and use them with future scans when you select them. (See "[Saving settings](#)" on page 69.)
- How to change the default settings the scanner uses to scan all items. (See "[Setting preferences](#)" on page 70.)
- How to start scanning from programs compliant with TWAIN or the HP Scanjet Plug-in. (See "[Scanning from other programs](#)" on page 74.)
- How to make scanned text editable. (See "[Making scanned text editable](#)" on page 75.)

## Tips for best image quality

Output type, resolution, file type, and values for other controls determine image quality and file size.

When you first scan an item, the scanner chooses the defaults for output type and resolution, and you do not need to change them. If you want to change these settings or want help choosing a file type, see:

- ["To select an output type" on page 43](#)
- ["Changing resolution" on page 46](#)
- ["List of file types" on page 62](#)

---

### Tip

For any image that will be printed, choose TIFF compressed as the file type to reduce the file size while maintaining quality. Also, many different programs recognize this file type.

---

## Saving settings

You can save and name a group of settings that you frequently use for a particular purpose and apply them to items you scan in the future. For example, if you routinely e-mail pictures to someone, you can save the settings including the output type, resolution, and dimensions that you always use. The settings are automatically applied when you scan a picture and choose the group of settings.

Saved settings override the default settings and any changes you made up to that point. Any changes you make after that point are preserved.

### *To save settings*

- 1 Make sure the scanned image whose settings you want to save is in the preview window and that you have adjusted any settings for the image.
- 2 On the **Scan** menu, point to **Settings**, and click **Save**. The settings for the current scanned image appear.
- 3 In the drop-down list at the bottom, type a name for these settings and click **Save**.

### *To use settings*

- 1 Scan an item to the HP Precisionscan Pro software.
- 2 On the **Scan** menu, point to **Settings**, and click **Load**.
- 3 Select the group of settings you want from the list at the bottom and click **Load**.

## Setting preferences

The preferences are the default settings for all scans performed. To change a setting only for the item currently being scanned see ["Making optional adjustments, basic" on page 45](#) and ["Making optional adjustments, advanced" on page 49](#).

### *To set scanning preferences*

- 1 On the **Scan** menu, click **Preferences**.
- 2 Click the tab you want.
- 3 Change any settings you want. See the next sections for descriptions of options on tabs.
- 4 When finished, click **OK**.

### *Scanner tab options*

The **Scanner** tab of the **Preferences** dialog box controls these options.

#### **Preview scan when the Scan To button is pushed**

When selected, a preview of the scan appears when you press the HP Scanning Software button on the scanner. When cleared, the software starts, but the scanner does not display a preview scan. Start a scan from the HP Precisionscan Pro software.

#### **Best Quality Scaling**

When selected, the highest quality scaling is applied to the final scan. When cleared, normal quality scaling is applied, making scanning faster.

#### **Best Quality Sharpening**

When selected, the highest quality sharpening is applied to the final scan. When cleared, normal quality sharpening is applied, making scanning faster.

#### **Maximum Pixel Depth**

When selected, the largest pixel bit depth is acquired from the scanner to produce the highest quality image. When cleared, less image data is processed, making scanning faster.

#### **Noise Reduction**

When selected, reduces the noise in the image caused by the scanner. When cleared, noise reduction is not applied, making scanning faster.

#### **Descreening**

When selected, a screened background image (such as a watermark) will be removed from the final scan. When cleared, any background image (such as a watermark) will be scanned as part of the image in the final scan.

#### **sRGB Profile (Gamma 2.2)**

When selected, the software uses the RGB profile from the screen to create the color in the final scan. This profile is also known as Gamma 2.2.

**Note:** Because Macintosh computers ship with Gamma 1.8, this option is not selected by default. When using this option, be sure to select sRGB in your monitor settings.

#### **Enable Scan Another Page Dialog**

When selected, a dialog box appears during final scanning that asks you if there are more pages of this item to scan. When cleared, the scanner assumes each job is only one page. Applies only to PDF, text, and RTF formats.

### *Selection Area tab options*

The **Selection Area** tab controls the following preferences.

#### **Automatically create selection area after a mouse click**

When selected, a selection area will be created around an area on which you click with the cursor.

#### **Automatically set the Output Type after selection**

When selected, the software automatically determines the output type of the area inside the selection border.

#### **Automatically adjust exposure after selection**

When selected, the scanning software automatically changes the values in the **Adjust Exposure** or **Adjust Black & White** dialog boxes to the optimal values each time you create a new selection area. Values for an image do not change if you adjust the selection area while the **Adjust Exposure** or **Adjust B&W Threshold** dialog box is open.

When cleared, the scanning software does not automatically reset the controls in these two tools.

#### **Automatically adjust color after selection**

When selected, the scanning software automatically changes the values in the **Adjust Color** dialog box to the optimal values each time you create a new selection area. Values never change if you create a different selection area while the **Adjust Color** dialog box is open.

When cleared, the scanning software does not automatically reset the controls.

### *Resolution tab options*

The **Resolution** tab controls the default resolution values available when you select **Resolution** on the **Tools** menu.

Default values are already set, but you can add custom resolution values or delete values. The range of resolution is 12 to 999,999. Click **Add** to add a value. Or, select a value and click **Delete** to delete that value.



### *Text tab options*

The **Text** tab of the **Preferences** dialog box controls the following preferences related to text output from the OCR program.

#### **Text Output (format)**

- **Framed text** places the text from the page into frames and attempts to recreate the page formatting as closely as possible to the original. The program into which the text is placed must support this type of option.
- **Flowed text** eliminates columns and inserts any images in the text as closely as possible to where they were in the original. Flowed text is easier to edit.

#### **Current OCR Language**

Allows you to choose the language the OCR program uses to check words it is processing in the item.

#### **Image Output**

Allows you to choose the output type the software uses for scanning images that appear on pages that include both images and text. This option is only available if you've selected **Image and Text** in the **Edit Text** tab on the **Buttons** tab of the **HP Scanjet Controls** dialog box.

- *True Color*. Scans images that appear on the page using the True Color output type. This option creates high-quality images. However, this option can increase the scanning time and can create final scans with large file sizes.
- *Optimized Palette*. Scans images that appear on the page using the Optimized Palette output type. This option decreases the time it takes the scanner to complete the scan and creates final scans with smaller file sizes. However, the quality of scanned images is lower.

See "[Selecting output type](#)" on page 43 for more information the output types available in the scanning software.

### *Controls tab options*

The **Controls** tab of the **Preferences** dialog box controls the control range readout to use for scanning.

The control range sets the amount of tonal resolution per color available for correction in the **Adjust Exposure** command and **Adjust Black & White** command. Using a larger number of bits for the control range results in greater control of compensation for exposure or threshold correction.

Choose one of these options:

- *8-bit readout (0-255)* — sets the controls to use 8 bits of tonal resolution per color
- *10-bit readout (0-1023)* — sets the controls to use 10 bits of tonal resolution per color
- *12-bit readout (0-4095)* — sets the controls to use 12 bits of tonal resolution per color
- *16-bit readout (0-65535)* — sets the controls to use 16 bits of tonal resolution per color

## Scanning from other programs

You can bring an image directly into an open file in one of your programs if the program supports TWAIN or the HP Scanjet Plug-in. Generally, the program is compliant if it has a command such as **Acquire**, **Scan**, or **Import New Object**. If you are unsure if the program is compliant or what the command is called, see the documentation for the program.

When scanning from within a program that supports TWAIN or the HP Scanjet Plug-in, the HP Precisionscan Pro software may start if the program allows it. If the HP Precisionscan Pro software starts, you can make changes to the image as you normally would. If not, the image returns to the program immediately.

---

### Tip

If your program does not support TWAIN or the HP Scanjet Plug-in, you can try to copy and paste or drag-and-drop the image into the program. Or, save the image as a file and then place the file in the program.

---

### *To scan from other programs*

- 1 Start a scan from within the other program by choosing the **Acquire** (or similar) command.
- 2 If the HP Precisionscan Pro software opens and displays the preview image, create a selection area. You can crop the scan (if necessary), select the output type, and make optional adjustments as you normally would. See the appropriate sections in this chapter for instructions.
- 3 When finished making changes to the scanned image, do one of the following to perform a final scan and place it in the program from which you started scanning:
  - On the **Scan** menu, click **Return Image To**.
  - Click .

The image appears in the open program. You might have to reposition the image.

If the image does not appear, the program might not accept the resolution or output type you selected. Rescan the image using the default settings the software sets for the image.

## Making scanned text editable

You can make text on a scanned image editable. The optical character recognition (OCR) program converts the text to be editable and then places it in a supported word-processing program. Depending on the capabilities of the word-processing program, graphics on a scanned image might be retained or discarded, or the OCR program might try to convert them and they will appear as random characters.

---

**Tip** If a block of text appears in Microsoft Word or another word-processing program inside a frame you do not want, double-click the frame border and click **Remove Frame** or a similar command.

---

*To create editable text*

- 1 Choose **Scan To** from the **Scan** menu.
- 2 Choose **Text File** from the **Destination** pull-down menu, and then click **Scan**.
- 3 Select a text or text-and-image file format in the **Format** pull-down menu, and then click **Save**. See "[List of file types](#)" on page 62.
- 4 If the program you select accepts multipage files, you might be asked if you have more pages to scan to this file. Do one of the following:
  - If this is a one-page item, click **Done**.
  - If there are more pages of this item, load the next page in the scanner and click **Scan** on the computer. Repeat until all pages are scanned. Then, click **Done**.

The OCR program opens and creates editable text from the scanned image.

**Note:** You can also save a scanned image and import the image into your OCR program. See "[To save a scan for future processing in an OCR program](#)" on page 61.

### *What to expect from OCR programs*

OCR programs convert some text more accurately than other text. Because OCR technology is never perfect, proofread all converted text carefully to ensure the characters have been correctly interpreted.

These types of text convert most accurately:

- text in standard fonts
- text in 9-point font or larger
- crisp, clear text
- black text on a white background

These types of text might convert less accurately:

- text close to non-text elements, such as bullets, lines, or graphics
- text in spreadsheets, tables, or forms
- letters that have gaps, that “bleed” along their edges, or that touch other letters
- underlined text
- text on colored paper

Handwriting cannot be converted.

# 4 Using accessories

Some scanners support using the HP Scanjet Automatic Document Feeder (ADF) and the HP Scanjet Transparency Adapter (XPA) for scanning slides and negatives. (Some models only, see the ["Front panel and accessories comparisons"](#) on page 3.)

## Scanning from the ADF

You can scan multiple-page items quickly and easily using the ADF. When you use the ADF, you can scan to the HP Precisionscan Pro software or other destinations. For instructions about setting up the ADF, see the [Setup and Support Guide](#). For information about preparing items for the ADF, see "Items for the ADF" on page 17.

### To scan from the ADF

- 1 Place a stack of similarly sized originals in the document input tray, face up with the first page on top.

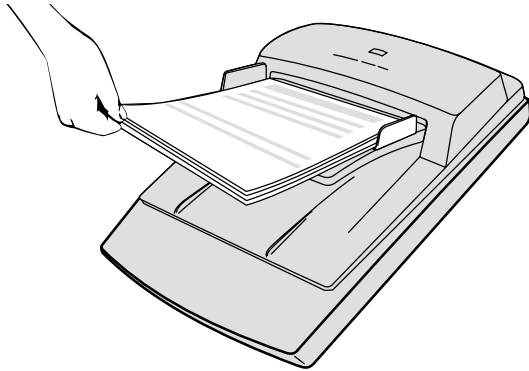

- 2 Adjust the paper guides to center the stack.

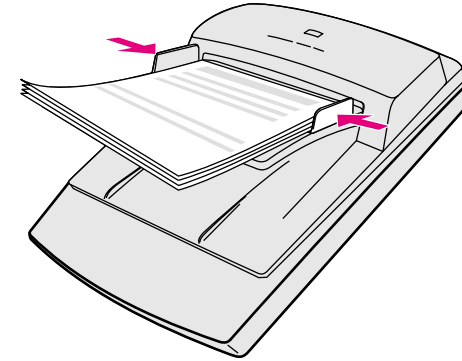

- 3 Do one of the following:
  - Start the HP Precisionscan Pro software and follow the directions on the computer screen.
  - Press a button on the front of the scanner.
 If you start the scan from the HP Precisionscan Pro software or scan to the HP Precisionscan Pro software using the Scan To button (  ):
  - a The **ADF Scan** dialog box opens and displays the current output type, resolution, and page size, which you can change. Or, you can click **Load Settings** and choose settings you have preset.
  - b To scan the item to a file, click **Scan**. Or, to scan directly to a destination, click **Scan To**, select a destination, and click **Scan**.

If you start the scan from any scanner button *except* the Scan To button, follow the directions on the screen to complete the scan.

## Scanning from the XPA

You can scan slides or negatives using the XPA.

---

**Tip** Do not use the XPA to scan a letter-size item, such as a presentation transparency. Place the transparent item on the scanner glass, place a white piece of paper on top, and scan as you normally would using the **Scanner Glass** command on the **Scan** menu.

---

See the [Setup and Support Guide](#) for information about installing the XPA.

See "[Items for the XPA](#)" on page 18 for information about preparing items for the XPA.

## Scanning slides

To scan standard 35 mm slides, use the XPA light source and the positioning plate. When scanning fewer than three slides, you also need the slide light shield.

### *To scan slides*

- 1 With the XPA light source connected to its port on the scanner, restart the software.
- 2 Place the positioning plate on the scanner glass so the arrow is in the upper right-hand corner. Push the positioning plate toward the top right corner.

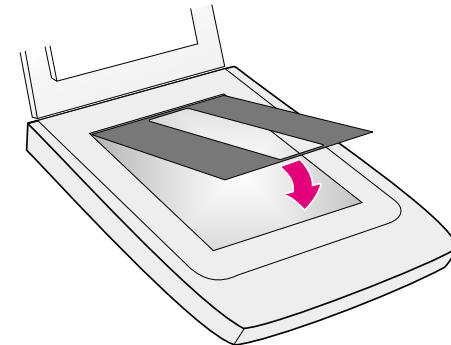

- 3 Slide up to three slides into the slide holder on the bottom side of the XPA light source. The correct view of the picture should be facing outward, toward you.

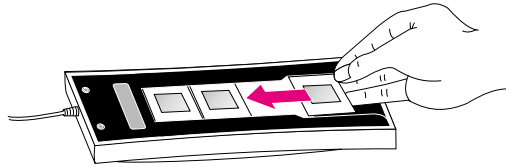

### Tip

The XPA light source also functions as a light table for viewing 35 mm slides. Insert slides as shown above.

To keep the XPA light source on beyond the default period, select the **Faster Scan** setting in the HP Scanjet Controls control panel. See ["Setting scanner lamp controls" on page 107](#).

- 4 If you are scanning fewer than three slides, insert the slide light shield after you load your last slide.
- 5 Place the XPA light source into the positioning plate with slides facing down and the HP logo facing you.

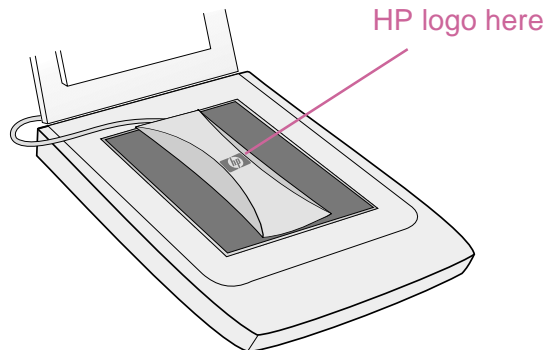

- 6 From the HP PrecisionScan Pro software, click the **Scan** menu, and select **XPA (Slides)**.
- 7 Before making any changes, see ["Making optional adjustments for slides or negatives" on page 83](#).
- 8 When you have finished using the XPA light source, on the **Scan** menu, click **Scanner Glass**. Disconnect the XPA light source if you want.



## Scanning negatives

To scan 35 mm negatives, use the XPA light source, the positioning plate, and the negative holder. When scanning fewer than four negative frames, you also need the negative light shield.

### *To scan negatives*

- 1 With the XPA light source connected to its port on the scanner, restart the software.
- 2 Place the positioning plate on the scanner glass so the arrow is in the upper right-hand corner. Push the positioning plate toward the top right corner.

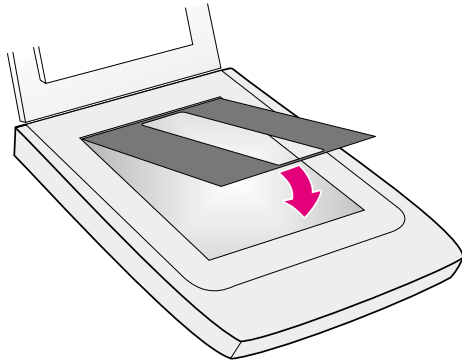

- 3 Slide the strip of negatives into the negative holder. If the negative strip curves, the curve should be facing out toward you.

**CAUTION** Negatives are easily damaged. Touch them only on the edges.

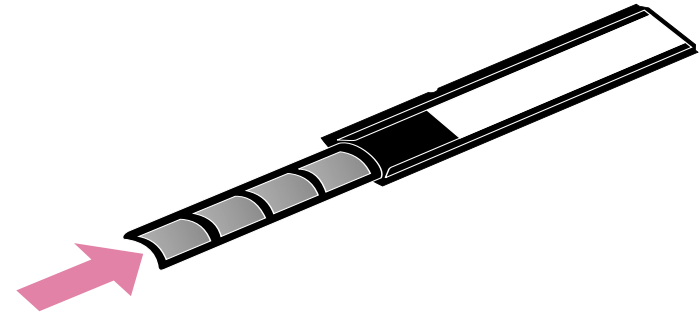

- 4 If you are scanning a strip of negatives with fewer than four frames, insert the negative light shield after the negative strip. See the icon on the negative holder for assistance.

- 5 Slide the negative holder into the slide holder on the bottom side of the XPA light source.

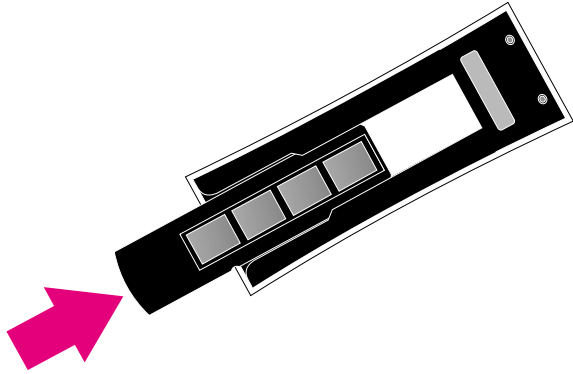

- 6 Place the XPA light source into the positioning plate with negatives facing down and the HP logo facing you.

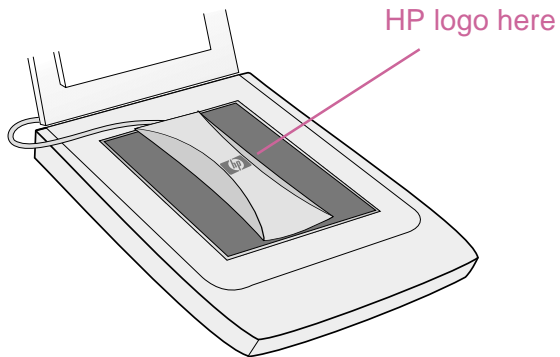

- 7 From the HP PrecisionScan Pro software, click the **Scan** menu, and select **XPA (Negatives)**.
- 8 Before making changes, see ["Making optional adjustments for slides or negatives" on page 83](#).
- 9 When finished using the XPA light source, on the **Scan** menu, click **Scanner Glass**. Disconnect the XPA light source if you want.

## Making optional adjustments for slides or negatives

You can make optional adjustments to slides or negatives scanned using the XPA. **Before deciding to make adjustments, create a selection area around one slide or negative so the software exposes it correctly.** See ["Cropping or selecting an area for final scan" on page 42.](#)

If you choose to make adjustments to the image after you create a selection area, make most of them as you normally would, except for the following adjustments:

- Midtone. See ["Adjusting midtones for slides or negatives" on page 83.](#)
- Highlight. See ["Adjusting highlights for slides or negatives" on page 84.](#)
- Shadow. See ["Adjusting shadows for slides or negatives" on page 84.](#)
- RGB values and pixel color. See ["Viewing RGB values and pixel color" on page 85.](#)

---

**Tip** See ["Making optional adjustments, basic" on page 45](#) and ["Making optional adjustments, advanced" on page 49](#) to make all adjustments except the ones mentioned above.

---

---

**Tip** To enlarge a slide or negative, see ["Resizing \(output dimensions\)" on page 45.](#)

---

## Adjusting midtones for slides or negatives

You can adjust the overall lightness or darkness of the scanned image using the midtone setting. The range for the number in the **Midtone** field is -100 to 100.

*To lighten slides or negatives overall*

- 1 On the **Advanced** menu, click **Adjust Exposure**.
- 2 Do one of the following:
  - Drag the Midtone slider up.
  - Type a higher number in the **Midtone** field and press **ENTER**.

*To darken slides or negatives overall*

- 1 On the **Advanced** menu, click **Adjust Exposure**.
- 2 Do one of the following:
  - Drag the Midtone slider down.
  - Type a lower number in the **Midtone** field and press **ENTER**.

*To return to the default settings*

- 1 On the **Advanced** menu, click **Adjust Exposure**.
- 2 Click **Auto** to return the midtone, highlight, and shadow settings to the defaults for this slide or negative.

## Adjusting highlights for slides or negatives

You can adjust highlights to lighten or darken the light areas. The range for the number in the **Highlights** field is -100 to 100.

### *To lighten lighter areas*

- 1 On the **Advanced** menu, click **Adjust Exposure**.
- 2 Do one of the following:
  - Drag the Highlight slider up.
  - Type a higher number in the **Highlights** field and press **ENTER**.

### *To darken lighter areas*

- 1 On the **Advanced** menu, click **Adjust Exposure**.
- 2 Do one of the following:
  - Drag the Highlight slider down.
  - Type a lower number in the **Highlights** field and press **ENTER**.

### *To return to the default settings*

- 1 On the **Advanced** menu, click **Adjust Exposure**.
- 2 Click **Auto** to return the midtone, highlight, and shadow settings to the defaults for this slide or negative.

## Adjusting shadows for slides or negatives

You can adjust shadows to lighten or darken the dark areas. The range for the number in the **Shadows** field is -100 to 100.

### *To lighten darker areas*

- 1 On the **Advanced** menu, click **Adjust Exposure**.
- 2 Do one of the following:
  - Drag the Shadow slider up.
  - Type a higher number in the **Shadows** field and press **ENTER**.

### *To darken darker areas*

- 1 On the **Advanced** menu, click **Adjust Exposure**.
- 2 Do one of the following:
  - Drag the Shadow slider down.
  - Type a lower number in the **Shadows** field and press **ENTER**.

### *To return to the default settings*

- 1 On the **Advanced** menu, click **Adjust Exposure**.
- 2 Click **Auto** to return the midtone, highlight, and shadow settings to the defaults for this slide or negative.

## Viewing RGB values and pixel color

You can view the RGB values and pixel color for any spot in an image, color or grayscale, using the RGB Meter.

*To view RGB values and pixel color*

- 1 On the **Advanced** menu, click **Adjust Exposure**.
- 2 Move the cursor over the area in the item for which you want to see the values. The values appear in the RGB area. A line appears in the histogram to show you where those pixels occur.



# 5 Troubleshooting and maintaining

This section provides information for:

- Solving issues that might occur while using the scanner or HP scanning software, or issues with the appearance of scanned images. Start with ["Checking the basics" on page 88](#).
- Setting scanner lamp controls. See ["Setting scanner lamp controls" on page 107](#).
- Clearing jams from the ADF. See ["Clearing jams from the ADF" on page 108](#).
- Cleaning and maintaining the scanner and accessories. See ["Cleaning and maintaining" on page 111](#).

For issues that occur during installation or the first time you scan, see the [Setup and Support Guide](#).

## Checking the basics

If the scanner is not working, always perform these actions first.

- Check that the power cable is securely connected between the scanner and a live electrical outlet or surge protector.
- If the power cable is connected to a surge protector, make sure the surge protector is plugged into an outlet and turned on.
- Check that the interface cable is securely connected between the scanner and the computer.

**Note:** The scanner has ports for other interface connections, and a parallel cable might have been shipped in the box with the scanner. However, for Macintosh computers, use the universal serial bus (USB) cable. For more information, see the [Setup and Support Guide](#).

- Make sure the scanner is unlocked. Move the lock to the unlocked position. (Some models only, see "[Front panel and accessories comparisons](#)" on page 3.)
- Disconnect the power cable from the scanner and turn off the computer. After 30 seconds, reconnect the power cable to the scanner and then turn on the computer, in that order.
- If a program has frozen, close it. Press **OPTION+⌘** (**COMMAND KEY**)+**ESC**, and then click **Force Quit**.

If these steps did not resolve the issue, see "[Starting troubleshooting](#)" on page 89.



## Starting troubleshooting

Start here to find the information you need. Choose one of these general groups of issues, and then choose one of that group's more specific issues.

*The scanner or software is not working.*

- A message is on the scanner or the computer. Follow the directions in the message to resolve the issue.
- There is no message. See ["Resolving issues that did not generate messages" on page 90](#).
- There is an error message on the front panel liquid crystal display (LCD). See ["Resolving scanner messages" on page 90](#).

*The quality of resulting scans is not what I expected.*

- Scanned images do not look good. See ["Resolving issues with scanned images" on page 93](#).
- Printed copies do not look good. See ["Resolving issues with printed copies" on page 96](#).
- Text on images is not editable. See ["Resolving issues with editable text" on page 99](#).
- Slides or negatives do not look good. See ["Resolving issues with slides and negatives" on page 98](#).

*Scans are not arriving at the destination I choose.*

See ["Resolving issues sending to destinations" on page 101](#).

*I am having an issue with the HP Scanjet Transparency Adapter (XPA) or the HP Scanjet Automatic Document Feeder (ADF).*

- Pages are jammed in the ADF. See ["Clearing jams from the ADF" on page 108](#).
- There is an issue with the ADF, other than pages jamming. See ["Resolving issues with the ADF" on page 105](#).
- There is an issue with the XPA. See ["Resolving issues with the XPA" on page 104](#).

## Resolving scanner messages

(Some models only, see "[Front panel and accessories comparisons](#)" on page 3.) If an error message appears on the 16-character front panel LCD on your scanner, look for the cause and solution in this section.

### ADF Paper Jam

Pages are jammed in the ADF. See "[Clearing jams from the ADF](#)" on page 108 for information on clearing paper jams from the ADF.

Clear the paper jam. If the error message does not clear, unplug the scanner and plug it back in.

### Error ##

The scanner reported an error during the self-test.

Unplug the scanner and plug it back in. If this error message is still on the scanner, contact HP support. Visit the HP support website at:

<http://www.hp.com/go/support>

See the [Setup and Support Guide](#) for phone contact information.

### Scanner Locked

(Some models only, see the "[Front panel and accessories comparisons](#)" on page 3.) The scanner is not working because it is locked. Make sure the scanner is unlocked. Move the lock to the unlocked position. If the error message does not clear, unplug the scanner and plug it back in.

## Resolving issues that did not generate messages

If the scanner or software is not working but no message appears, look for the cause and solution in this section.

### Items you scanned previously are no longer on the computer.

The scanned image might not have been saved as a file. If you send an image directly to a destination, the scanned image is not saved on the computer. When you use the HP Precisionscan Pro software, use **Save As** to save the image to your computer.

### The scanner lamp stays on.

The scanner lamp should time out and turn off automatically after a period of inactivity.

- If you have recently used the scanner, wait a few more minutes.
- If the scanner lamp is still on, you might have selected the **Faster Scan** setting. Check this setting on the **Lamp** tab in the HP Scanjet Controls control panel. See "[Setting scanner lamp controls](#)" on page 107.
- Press the Power Save button on the front panel of the scanner to immediately turn off the scanner lamp and the XPA light source (if connected). See "[Using Power Save](#)" on page 34.
- If you still encounter problems with the scanner lamp or the Power Save button, contact HP Customer Support. (See "Contacting HP Customer Support" in the [Setup and Support Guide](#).)

I saved a scanned image to a file, but now I cannot open the file in the program I want.

You might have saved the file in a format the other program cannot use. Save the file in a different format the program can use. Look in the **File Open** or **Import** command for the program to see which file types it supports.

The scanner is not working.

One or more of these issues might be causing the problem:

- The scanner was not installed properly.
- The interface cable is not compatible with the scanner.
- If the scanner is emitting a grinding sound, the scanner is locked.

See "[Checking the basics](#)" on page 88 and the [Setup and Support Guide](#).

The scanner does not scan right away.

If the scanner has not been used for a while, the scanner lamp has turned itself off. The lamp goes through a warm-up period after you start the software or press any scanner button. Wait for a few seconds for scanning to begin.

When I press a button on the scanner, the incorrect program opens.

Check which function is set to open when you press the button on the scanner. See "[Configuring scanner buttons](#)" on page 35.

When I choose Scan To on the scanner, the image does not appear in the software.

- A cable might be loose. Check that the interface cable is securely connected.
- You might have accidentally turned off the preview feature. Check this setting on the **Scanner** tab in the Preferences of the HP Precisionscan Pro software. See "[Setting preferences](#)" on page 70.
- (Some models only, see the "[Front panel and accessories comparisons](#)" on page 3.) Check that the HP Precisionscan Pro software is the program set to start when you press the Scan To button ().
  - 1 Choose **Control Panels** from the **Apple (🍏)** menu, and then choose **HP Scanjet Controls** from the submenu.
  - 2 Click the **Buttons** tab in the **HP Scanjet Controls** dialog box, and then click the **Scan To** tab.
  - 3 Make sure **HP Precisionscan Pro** is selected in the **Destinations** pull-down menu.

Scanner is scanning items very slowly.

- If you are scanning to edit text, the optical character recognition (OCR) program causes the scanner to scan more slowly, which is normal. Wait for the item to scan.
- Some default settings can cause the scanner to scan more slowly. Check the settings. See "[Setting preferences](#)" on page 70.
- The resolution might be set too high. Return to the default resolution. See "[Changing resolution](#)" on page 46.

The correct menu items do not appear in the HP Precisionscan Pro software.

- If you used the ADF and then disconnected it, restart the software.
- If you were using the XPA, on the **Scan** menu, click **Scanner Glass** to scan from the glass again.
- If you are trying to use the XPA and the **XPA (Slides)** or **XPA (Negatives)** commands are unavailable, restart the software while the XPA light source is connected to the scanner.

The scanner is making a loud clicking or grinding noise.

The scanner is locked. Move the lock to the unlocked position. (Some models only, see the "[Front panel and accessories comparisons](#)" on page 3.)

The scanner does not save multiple pages as a single file.

- If you are scanning from a scanner button, make sure the **Prompt for Another Page** option is selected in the HP Scanjet Controls control panel. See "[Configuring scanner buttons](#)" on page 35.
- If you are scanning from the HP Precisionscan Pro software, make sure the **Enable Scan Another Page Dialog** option is selected in the **HP Precisionscan Pro Preferences** dialog box. See "[Setting preferences](#)" on page 70.

## Resolving image-quality issues

This section contains information for resolving image-quality issues, whether you scanned using the scanner glass, the ADF, or the XPA.

- "Resolving issues with scanned images." See this page.
- "Resolving issues with printed copies" on page 96.
- "Resolving issues with slides and negatives" on page 98.

### Resolving issues with scanned images

This section contains solutions to issues that affect all scanned images, regardless of whether you used the scanner glass or the ADF. If you were printing, see also "Resolving issues with printed copies" on page 96.

Scanned images are too light or too dark.



The original image might be very light or dark or be printed on colored paper. Adjust the midtone, highlight, and shadow settings from the HP PrecisionScan Pro software. See "Scanning from HP PrecisionScan Pro" on page 39.

Scanned images have black dots or streaks in top and bottom margins.



There might be ink, glue, correction fluid, or some other substance on the scanner glass. Clean the scanner glass. See "Cleaning the scanner glass" on page 111.

Scanned images have unwanted lines through them.



- The scanner glass might be dirty. Clean the glass. See "Cleaning the scanner glass" on page 111.
- If you are using the ADF, the ADF glass might be dirty or scratched. Clean the ADF glass. See "Cleaning the ADF glass" on page 112.

### Scanned image is not clear.



- The resolution, sharpening, or midtone, highlight, and shadow settings might need to be adjusted before scanning. See ["Scanning from HP Precisionscan Pro" on page 39](#).
- The original might be on colored paper. If the original was printed on a colored paper, including brown recycled paper, the image or text might not be clear. Try adjusting the resolution and midtone, highlight, and shadow settings from the HP Precisionscan Pro software. See ["Scanning from HP Precisionscan Pro" on page 39](#).

### The image is completely black or completely white.

The item might not be placed correctly on the scanner glass or in the ADF. Make sure that the item you are trying to scan is placed face down on the glass, or face up in the ADF.

### Colors in the scanned image are different from the original item.

Scanners, monitors, printers, and different operating systems interpret color differently. Use the hue and saturation settings in the HP Precisionscan Pro software to adjust the colors.

In the HP Precisionscan Pro software, all of the image scanned when I only wanted part, or vice versa.

The selection area might not be selected correctly. Make sure the selection border is surrounding the area you want in the final scan.

### Scanned images are crooked.

The item might have been placed crookedly or shifted when you closed the lid. Straighten the original on the scanner glass and scan again.

I thought I made the image smaller or larger before the final scan in the HP Precisionscan Pro software, but it is still the same size as the original.

You might have zoomed in or out, which does not change the size of the image. Change the output size. See ["Resizing \(output dimensions\)" on page 45](#).

An original photo was fuzzy, and the scanned image looks even worse.

The sharpening level needs to be increased. In the HP Precisionscan Pro software, adjust the sharpening. See ["Sharpening an image" on page 48](#).

### Scanned images are grainy, jagged, or fuzzy.

- You resized the image in a program other than the HP Precisionscan Pro software. Resize the image in the HP Precisionscan Pro software before you send it to the other program. (See ["Resizing \(output dimensions\)" on page 45.](#))
- In the HP Precisionscan Pro software, the resolution is set too low. Set the resolution to a higher number, or return to the default setting. See ["Changing resolution" on page 46.](#)
- In the HP Precisionscan Pro software, too much or too little sharpening was applied. Adjust the sharpening. See ["Sharpening an image" on page 48.](#)

### An original photo had marks, flaws, or scratches, and the scanned image looks even worse in the HP Precisionscan Pro software.

- You sharpened the image manually. Return to the default setting. See ["Sharpening an image" on page 48.](#)
- Best Quality Sharpening is selected. Check the setting. See ["Setting preferences" on page 70.](#)

### I set the image to a higher resolution in the HP Precisionscan Pro software, but the output quality is no better.

- Setting the resolution to a higher number does not necessarily improve quality. The software sets the resolution automatically based on the type of item you scanned. Keep or return to the default. See ["Changing resolution" on page 46](#) or ["Tips for best image quality" on page 69](#) for guidelines.
- If you sent the image to another program, the program might not support the resolution you set in the HP Precisionscan Pro software. Determine the setting the program uses and set the resolution in the HP Precisionscan Pro software to that resolution.

### Images scanned from the HP Precisionscan Pro software are larger than the original when viewed or printed from another program.

The other program did not accept the image size information. Scan the image at a lower resolution. When you scan at a resolution the program accepts, it will display or print the image at the correct size.

### The image is too big or too small.

In the HP Precisionscan Pro software, set the physical output dimensions in the **Resize** dialog box. See ["Resizing \(output dimensions\)" on page 45.](#)

### When I try to scan to the Web from the HP Precisionscan Pro software, the image is too large or does not look good on screen.

Scan settings for this image might be set incorrectly. See ["Tips for best image quality" on page 69.](#)

## Resolving issues with printed copies

Use this section to help resolve issues with printed pages.

Parts of the page around the edges are not printing.

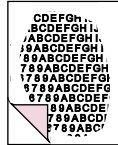

Printers cannot print right up to the edge of the paper. To get the image to fit inside the printable area, you must slightly reduce the size of the image in the HP Precisionscan Pro software and then reprint the image.

Copies are too light.



- If you are copying an item printed on colored paper, there might not be enough contrast between the ink and paper colors. Adjust the highlights, shadows, midtones, and resolution settings from the HP Precisionscan Pro software. See ["Scanning from HP Precisionscan Pro" on page 39](#). Or, adjust the contrast from the HP Scanjet Copy Utility. Also, if possible for text, use originals printed with black ink on white paper.
- The printer might be out of toner or ink. Print a different file from another program to the printer to see if the issue lies with the printer.

Vertical white stripes appear on the page.



- The printer might be out of toner or ink. Print a different file from another program to the printer to see if the issue lies with the printer.
- The scanner internal mirror might be contaminated. Contact the Customer Service Center for service.

The bottom of the printed page is blank, or part of a graphic is cut off.



The page might be too complex. (The printer does not have enough memory to process the page.) Set the resolution of the image to 300 dpi or less in the HP Precisionscan Pro software. See ["Changing resolution" on page 46](#).



### Colors in printed images are incorrect.

The output type or printer settings might not be correct. Choose a different output type and print again. Check the printer settings. If it is a color printer, check if the printer is out of ink or toner.

### Scanned images are jagged or fuzzy.

- The output type in the HP Precisionscan Pro software might not be set correctly. Set the output type to True Color or Grayscale. See "[Selecting output type](#)" on page 43.
- If you placed the image in a file in another program, resized the image, and are printing from that program, resizing the image in the program probably caused the issue. Resize the image in the HP Precisionscan Pro software before placing it in a file in another program. See "[Resizing \(output dimensions\)](#)" on page 45.
- If the original image was fuzzy and you enlarged it, the fuzziness becomes more obvious.

## Resolving issues with slides and negatives

Use the following section to help resolve issues with slides or negatives scanned using the XPA. All actions must be performed in the HP Precisionscan Pro software, because you must scan slides or negatives using this software. See also ["Resolving issues with the XPA" on page 104](#).

[I tried to enlarge a scanned image of a slide, but the image remained the same size.](#)

You might have used the **Zoom In** command, which only changes the view on the screen. Use the **Resize** command to change the size of the final scanned image. See ["Resizing \(output dimensions\)" on page 45](#).

[The colors are incorrect, or the image is too light or too dark.](#)

- The software might be setting exposure for the entire area instead of one slide or negative. Create a selection area around the slide or negative you want to use to ensure it is exposed correctly.
- The positioning plate is not placed completely on the scanner glass. Make sure the positioning plate is completely on the scanner glass.
- If you are scanning fewer than three slides with the XPA, make sure to use the slide light shield to cover the remaining area in the slide holder. This ensures that no extra light affects the scan.
- If you are scanning fewer than four negative frames with the XPA, make sure to use the negative light shield to cover the remaining area in the negative holder. This ensures that no extra light affects the scan.

[The scanned image shows a colored tint, usually pink.](#)

The image was probably scanned without the XPA, or the positioning plate and XPA light source were placed incorrectly on the scanner bed. For the steps for scanning 35 mm slides or negatives, see ["Scanning from the XPA" on page 79](#).

[Scanned images appear as a box with multi-colored vertical lines or as a dashed box with an arrow surrounding the area.](#)

The positioning plate might be placed incorrectly on the scanner bed. Place the positioning plate on the scanner glass so the Hewlett-Packard logo is at the bottom right.

[The scanned image is black even though the light on the XPA light source is on.](#)

- The positioning plate might be placed incorrectly on the scanner bed. Place the positioning plate on the scanner glass so the Hewlett-Packard logo is at the bottom right.
- Check the **Adjust Exposure** command in the **Advanced** menu.

[There are streaks in the scanned image.](#)

- Check the original slide or negative for damage.
- The XPA may be broken, and service may be required.

[The scans are dark.](#)

The bulb in the XPA light source might be broken or not working. If the bulb is broken, service is required.

## Resolving issues with editable text

This section contains resolutions to issues that might occur when you are trying to make text editable.

### Scanned text is not editable.

- If you used the HP Precisionscan Pro software, send the scanned image to a text or text-and-image file format. See ["Making scanned text editable" on page 75](#).
- If you used the HP Precisionscan Pro software, you sent the scan to an image file or saved the scan using an image output type. Send the scan to a text file. See ["List of file types" on page 62](#). Or open the image file from the OCR software. See the documentation for the OCR software.

### Scanned text is editable in some programs but not in others.

Some programs accept only image formats and do not allow text. Make sure the program accepts editable text.

### Incorrect characters appear in the text that was converted using the OCR software.

The accuracy of the OCR program depends on the program having the correct settings on the quality of the original item. To obtain the best possible results, choose the scan setting for text, and process only crisp, clear text. See ["What to expect from OCR programs" on page 76](#).

### Converted text does not appear in my word-processing program.

Do one of the following:

- If you used the HP Precisionscan Pro software, send the scanned image to a text or text-and-image file format. See ["Making scanned text editable" on page 75](#).
- Cut and paste the text into the program you want. If the text is still not editable, work with the text as an image or retype it.

### I do not know how to process text using a different OCR program.

Do one of the following:

- Scan the item from the OCR program using TWAIN or the HP Scanjet Plug-in. See ["Scanning from other programs" on page 74](#).
- Scan the item to the HP Precisionscan Pro software, save the scanned image as an image file, and open the file in the other OCR program.
- Scan to the HP Precisionscan Pro software. Then, on the **Scan** menu, click **Scan To** and choose the other OCR program.

The converted text did not retain font size and style when the text was placed in a word-processing program.

Word-processing programs cannot always accept the original formatting of the scanned text. Reformat the text in the word-processing program.

Converted text appeared in the word-processing program without its formatting and I wanted it, or vice versa.

Even if you want to retain the formatting and you have the setting set correctly, the receiving word-processing program cannot always accept the formatting. Reformat text in the word-processing program.

## Resolving issues sending to destinations

Use this section to resolve issues sending images to destinations. Not all functions are available on all scanners.

When I choose E-mail on the scanner, scanned images do not automatically appear in a new e-mail message.

The e-mail program is Web-based or might not be supported. Save the scanned image as a file and attach it to your e-mail message as you normally do.

When I choose E-mail on the scanner, the scanned image attaches as a bitmap, but it contains text I want the recipient to be able to edit.

To make text editable for a recipient, make sure the correct output type is selected in the HP Scanjet Controls control panel.

- 1 Choose **Control Panels** from the **Apple (🍏)** menu, and then choose **HP Scanjet Controls** from the submenu.
- 2 Click the **Buttons** tab in the **HP Scanjet Controls** dialog box, and then click the **E-mail** tab.
- 3 Select the e-mail program, and then click either **Text** or **Text and Image**.
- 4 Close the **HP Scanjet Controls** dialog box.

Or, save the scanned image as a file and attach it to a message as you normally do.

When I press the E-mail button on the scanner, the incorrect e-mail program opens.

Check which e-mail program is set to open when you press the E-mail button (📧) on the scanner. See "Changing settings for buttons" on page 35.

When printing copies from the scanner or the HP Scanjet Copy Utility, I cannot choose the printer I want.

Do one of the following:

- Make sure the printer is set up and configured correctly in the Chooser. (For more information about using the Chooser, see the Mac OS Help on your computer.)
- Scan the item to the HP Precisionscan Pro software and print from there.

When printing copies, I can only make multiple copies of one page at a time (I cannot collate copy).

Even if you are using an ADF, each page is treated as a separate job. You can make multiple copies of one page, but not multiple copies of different pages and collate them.

When I choose the Scan To button on the scanner, the image does not appear in the software.

- A cable might be loose. Check that the interface cable is securely connected.
- You might have accidentally turned off the preview feature. Check this setting on the **Scanner** tab in the Preferences of the HP Precisionscan Pro software. See "[Setting preferences](#)" on page 70.
- Check that the HP Precisionscan Pro software is the program set to start when you press the Scan To button ()
  - 1 Choose **Control Panels** from the **Apple** (🍏) menu, and then choose **HP Scanjet Controls** from the submenu.
  - 2 Click the **Buttons** tab in the **HP Scanjet Controls** dialog box, and then click the **Scan To** tab.
  - 3 Make sure **HP Precisionscan Pro** is selected in the **Destinations** pull-down menu.

I tried to scan an image into an existing file, but the scanned image appeared in a new file instead.

Some programs only allow scanned images to be placed into new files. Cut and paste the image into the file you want. Or, save the scanned image as a file and import it into the other program.

When I try to send a scanned image using the Scan To command on the Scan menu of the HP Precisionscan Pro software, the program I want does not appear.

The HP Precisionscan Pro software might not recognize the program as a destination. Do one of the following:

- Rebuild the desktop on the computer. To rebuild the desktop, press **⌘ (COMMAND KEY)+OPTION** while restarting the computer. (For more information, see the Mac OS Help on your computer.)
- Save the scanned image in a file type the other program uses, and then open the file in the other program.
- Copy and paste or drag-and-drop the image into the other program.
- Reinstall the program that is not being recognized. This might allow the HP Precisionscan Pro software to recognize it.

I want to start scanning from another program, such as my word-processing program, so I can bring an image into my open file, but I cannot start the scan.

The other program must support TWAIN or the HP Scanjet Plug-in. If you cannot find a command such as **Acquire** or **Insert**, check the documentation for the program to see if it is compliant.

If the program supports the HP Scanjet Plug-in and you cannot start a scan from another program, reinstall the HP Scanjet Plug-in:

- 1 Quit the program with which you want to use the plug-in.
- 2 Insert the HP Scanning Software CD into your computer's CD-ROM drive. The HP Scanning Software window appears. (If the HP Scanning Software window does not appear, double-click the icon for the HP Scanning Software CD.)
- 3 In the HP Scanning Software window, double-click the HP Scanjet Plug-in folder.
- 4 Drag the HP Scanjet Plug-in (which is named HPScanjet) to the appropriate location for the program with which you want to use the plug-in. (Many programs have a specific folder for plug-ins. For information about where to place the plug-in, see the documentation provided with the program.)
- 5 Start the program with which you want to use the plug-in.

If the program does not support TWAIN or the HP Scanjet Plug-in, do one of the following in the HP Precisionscan Pro software:

- Save the scanned image as a file and then insert the file into the other program.
- Click **Scan To** from the **Scan** menu, and choose a program.
- Copy and paste or drag-and-drop the image into the other program.

I am trying to return a scanned image to a program that supports TWAIN or the HP Scanjet Plug-in, but the image will not appear.

The program that supports TWAIN or the HP Scanjet Plug-in might not accept the resolution or output type you selected. Rescan the image using the default settings the HP Precisionscan Pro software sets for the image.

I do not see the destinations I want when I use the Select Destination button next to the Scan To button.

(Some models only, see the "Front panel and accessories comparisons" on page 3.)

Not all destinations appear in the scanner's destination list. For example, printers, e-mail programs, and saving to a file are not included. The list is also limited to the first 18 destinations found by the HP scanning software. You can access additional destinations through the HP Precisionscan Pro software. See "To send to a program" on page 60 for more information, or do one of the following.

- Update the destinations for your scanner buttons. See "To change settings for Speed Destinations" on page 36 for steps.
- Unplug the scanner and plug it back in.

## Resolving issues with accessories

This section contains information for resolving issues when you are using the XPA or ADF.

### Resolving issues with the XPA

This section contains issues that might occur when you are using the XPA. See also "[Resolving issues with slides and negatives](#)" on [page 98](#).

#### The XPA is not working at all.

The XPA cable might not be connected correctly. Make sure the XPA cable is connected securely to the XPA port on the scanner.

#### When using the XPA, I cannot choose XPA (Slides) or XPA (Negatives) on the Scan menu.

- The XPA cable might not be connected correctly. Make sure the XPA cable is connected securely to the XPA port on the scanner.
- If you connected the XPA light source while the HP Precisionscan Pro software was running, restart the software. Doing so allows the software to detect the XPA.

#### When using the XPA, I cannot scan using the scanner buttons.

The XPA is not designed to work with the scanner buttons. Use the HP Precisionscan Pro software when using the XPA.

#### There is no light or only a dim light in the transparency adapter after checking XPA (Slides) or XPA (Negatives) in the Scan menu.

- Make sure you have selected **XPA (Slides)** or **XPA (Negatives)** from the Scan menu in the HP Precisionscan Pro software. If these two commands are unavailable, restart the software while the XPA light source is connected to the scanner.
- The bulb in the XPA light source might be broken or not working. With the XPA light source connected to the scanner, hold the XPA light source up and look for illumination. If the bulb is broken, service is required.



## Resolving issues with the ADF

This section contains issues that might occur when you are using the automatic document feeder (ADF).

The ADF is feeding multiple sheets, skewing pages, or jamming frequently.

- If the pages look like they are skewing as they feed into the ADF, check the resulting scanned images in the software to ensure they are not skewed.
- The item might not be placed correctly. Straighten the item and adjust the guides to center the stack.
- The maximum number of pages the ADF input tray and output bin can hold is 25, depending on the type of media being loaded. Make sure to load only 25 or fewer pages in the input tray, and remove pages from the output bin if they are stacking up to a pile of more than 25.
- The item loaded might not meet the specifications for the ADF. Make sure the type of media being loaded meets required specifications. See ["Items for the ADF" on page 17](#).

When using the ADF, the scanner does not feed the item at all.

The hatch might not be securely latched. Open the hatch, and then close it, pressing firmly. See ["To clear jams at the start of a page" on page 108](#) for illustrations.

An item loaded in the ADF keeps jamming.

- The item does not meet the guidelines for the ADF. See ["Items for the ADF" on page 17](#).
- The item might have something on it. Make sure you have removed anything such as staples and self-adhesive notes on the item. See ["Selecting and preparing items" on page 17](#).
- The item is too small. The ADF can handle items as small as 88.9 by 127 mm (3.5 by 5.0 inches). Use the glass to scan.
- The item is too large. The ADF can handle items as large as 216 by 355.6 mm (8.5 by 14 inches). Use the glass to scan the item in sections.

### The bottom of the scanned image is cut off.

- The ADF can handle items up to 355.6 mm (14 inches) long. If the item is longer, scan it in sections on the glass. If the item is the correct length, choose the correct page size setting in the ADF dialog box prompt before scanning.
- If sent to a printer, the item might be too complex (require too much memory) for the printer to process. If possible, choose a printer with more memory. Or, select a lower resolution or different output type, like black and white or grayscale.
- If you are scanning from the scanner buttons, make sure the correct page size for the ADF is selected in the HP Scanjet Controls control panel:
  - 1 Choose **Control Panels** from the **Apple** (🍏) menu, and then choose **HP Scanjet Controls** from the submenu.
  - 2 Click the **Buttons** tab in the **HP Scanjet Controls** dialog box, and then click the tab for the scanner button you are using.
  - 3 In the **ADF Page Size** section of the dialog box, select the setting that corresponds to the pages you are using with the ADF.
  - 4 Close the **HP Scanjet Controls** dialog box.

**Note:** If you use a different scanner button with the ADF and encounter this problem again, follow these steps to set the correct page size for that button.

After starting a scan from the Copy button using the ADF, the scanned image is reduced on the printed page and extra space appears around the scanned image.

When using the Copy button, the ADF page size settings are not sent automatically to the printer. Set the page size in the **Page Setup** dialog box on the computer:

- 1 In the **Application** menu (located in the upper-right corner of the screen), choose **Finder**.
- 2 In the **File** menu, choose **Page Setup**.
- 3 Choose the appropriate page size in the **Paper** pull-down menu.
- 4 Click **OK**.

For more information about setting the page size, see the Mac OS Help on your computer.

## Setting scanner lamp controls

You can set the scanner lamp to use either Energy Save or Faster Scan. These scanner lamp controls are available in the HP Scanjet Controls control panel.

### Energy Save

While using Energy Save, the scanner lamp stays on as long as the software is running and might stay on for a while after the software is closed. However, after about ten minutes, the scanner lamp turns off.

Because the scanner lamp turns off, the scanner conserves energy when Energy Save is enabled. (Energy Save is the default setting for the scanner.)

#### *To enable Energy Save*

- 1 Choose **Control Panels** from the **Apple (🍏)** menu, and then choose **HP Scanjet Controls** from the submenu.
- 2 In the **HP Scanjet Controls** dialog box, click the **Lamp** tab.
- 3 Click **Energy Save**.
- 4 When finished, close the **HP Scanjet Controls** dialog box.

### Faster Scan

After the scanner lamp has turned off, it must warm up again before the scanner can begin scanning. (This warm-up process takes about 30 seconds.) As a result, the time it takes to scan an item immediately after the scanner lamp turns on is longer than the time it takes to scan subsequent items.

To help prevent scanning delays caused while the scanner lamp is warming up, you can enable Faster Scan. This setting allows you to set a time (such as the beginning of your business day) when the scanner lamp automatically turns on. The scanner lamp stays on for ten hours and then turns off.

Because the scanner lamp stays on, even if you are not using the scanner or the software, the scanner uses more energy when Faster Scan is enabled.

#### *To enable Faster Scan*

- 1 Choose **Control Panels** from the **Apple (🍏)** menu, and then choose **HP Scanjet Controls** from the submenu.
- 2 In the **HP Scanjet Controls** dialog box, click the **Lamp** tab.
- 3 Click **Faster Scan**.
- 4 In the **Select Time** text box, type the time when you want the scanner lamp to turn on daily.
- 5 When finished, close the **HP Scanjet Controls** dialog box.

## Clearing jams from the ADF

Pages can jam at the beginning or the end of a page. Use the appropriate procedure below to clear the jam and continue.

*To clear jams at the start of a page*

- 1 Raise the hatch.

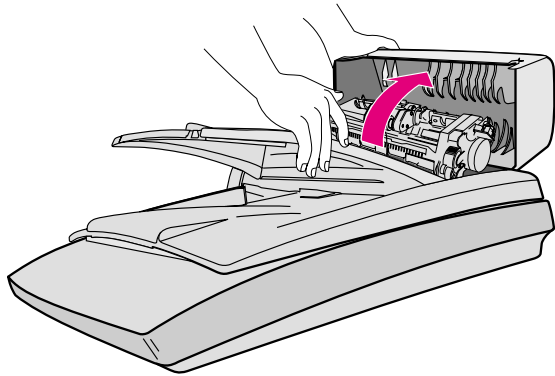

- 2 Lift the large green tab (located to the left of the roller) and gently remove the jammed page.

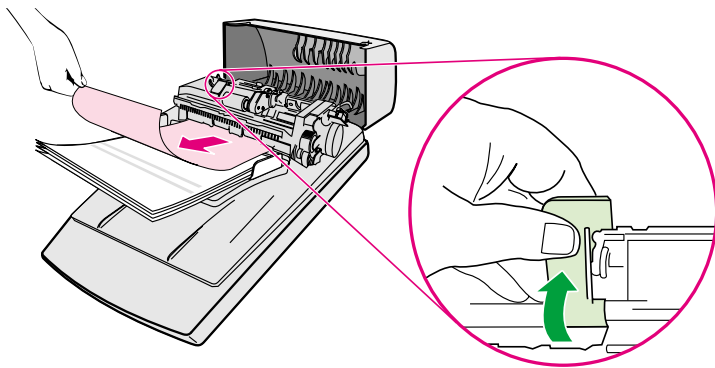

- 3 If the item cannot be easily removed, lift the two green tabs located behind the rollers and gently remove the green paper lead as shown.

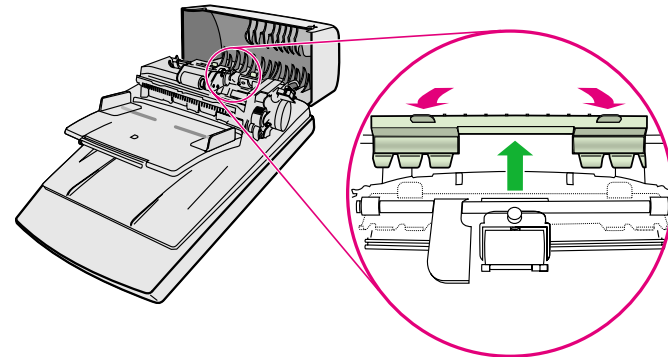

**Note:** Using force to remove the page might cause damage to your originals. If the majority of the paper is already through the main roller, use the procedure to clear jams at the end of a page.

- 4 Remove the jammed item from the ADF and replace the paper lead.

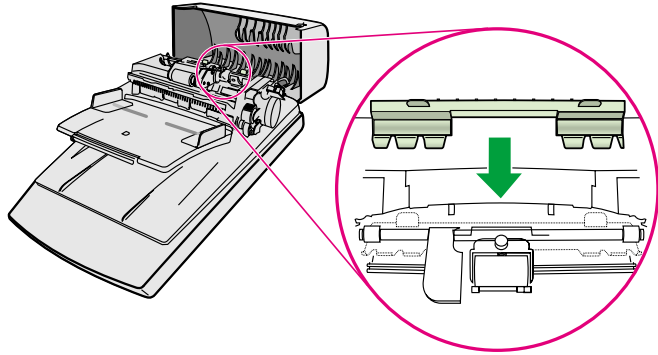

- 5 Close the hatch. Press down firmly until you hear a click.

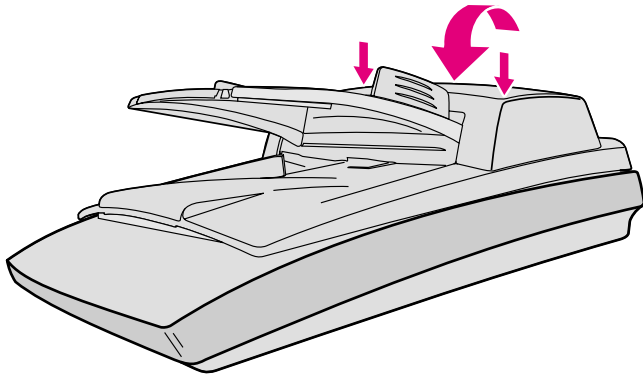

- 6 Restack all pages and reload them into the ADF.

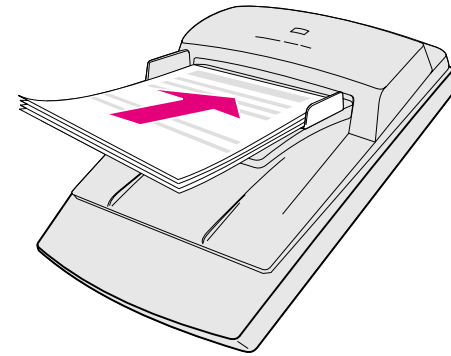

- 7 On the ADF prompt on the computer, reselect any settings you had changed and click **Scan To** or **Scan** again.

*To clear jams at the end of a page*

- 1 Remove any pages from the ADF input tray.
- 2 Remove the input tray from the ADF.

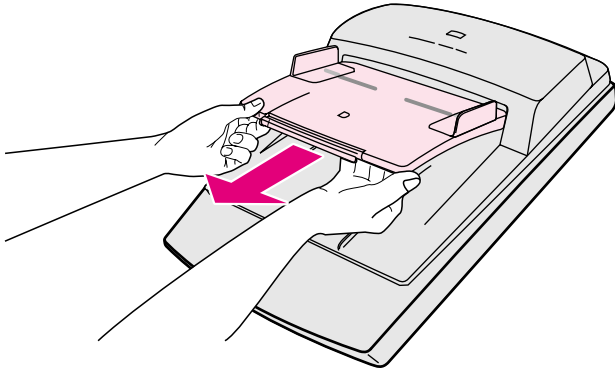

- 3 Gently pull the paper out of the ADF in the feeding direction (towards you).

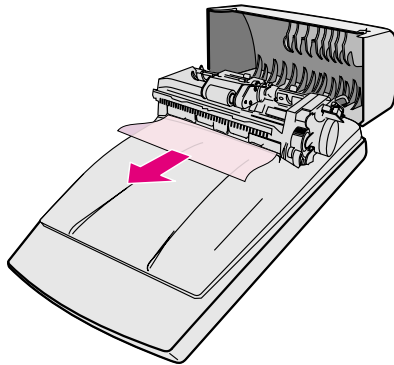

- 4 If you still cannot remove the paper from the ADF, lift the ADF lid to its fully open position, loosen the jammed paper from the roller at the rear of the ADF lid, and pull it gently from the ADF.

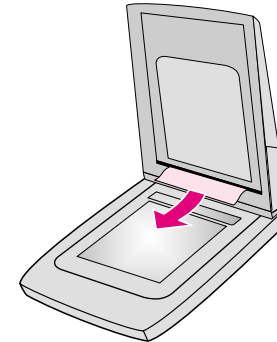

- 5 When you have successfully cleared the jam, attach the input tray and close the hatch. Press down firmly on both sides until you hear a click.
- 6 Restack all pages and reload them into the ADF.
- 7 On the ADF prompt on the computer, reselect any settings you had changed and click **Scan To** or **Scan** again.

## Cleaning and maintaining

Periodically, the scanner and accessories might need to be cleaned or to have maintenance, especially if you are seeing marks or smudges on scanned images.

### Cleaning the scanner glass

You might need to clean the scanner glass if the ink on items you are scanning can be smudged with your hand or items have excessive amounts of dust or dirt on them. You might also need to clean the scanner glass if there are smudges or other marks on scanned images.

*To clean the scanner glass*

- 1 Disconnect the power cable from the scanner.
- 2 Open the scanner lid.
- 3 Clean the glass using a soft, lint-free cloth sprayed with a mild glass cleaner.

**CAUTION** Only use glass cleaner. Avoid abrasives, acetone, benzene, and carbon tetrachloride, all of which can damage the scanner glass. Avoid isopropyl alcohol because it can leave streaks on the glass.

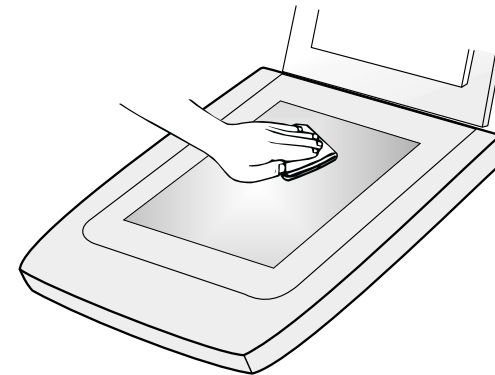

- 4 Dry the scanner glass with a dry, soft, lint-free cloth.
- 5 When finished, reconnect the power cable to the scanner.

Fingerprints or smudges on the underside of the glass do not affect the appearance of scanned images because this area of the glass is outside the focal point of the scanner.

## Cleaning the XPA

(Some models only, see "[Front panel and accessories comparisons](#)" on page 3.) Clean the XPA with a dry, soft cloth. If necessary, spray the cloth with window cleaner or isopropyl alcohol.

## Cleaning the ADF glass

(Some models only, see "[Front panel and accessories comparisons](#)" on page 3.) You must clean the ADF glass to maintain high-quality scanning.

*To clean the ADF glass*

- 1 Disconnect the power cable from the scanner.
- 2 Open the scanner lid and locate the ADF glass area on the scanner bed.

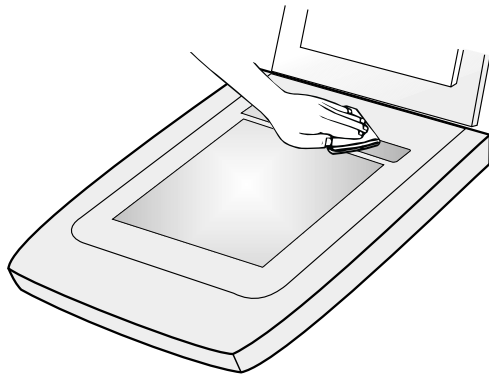

- 3 Clean the glass using a soft, lint-free cloth sprayed with a mild glass cleaner.

**CAUTION** Only use glass cleaner. Avoid abrasives, acetone, benzene, and carbon tetrachloride, all of which can damage the scanner glass. Avoid isopropyl alcohol because it can leave streaks on the glass.

- 4 Dry the scanner glass with a dry, soft, lint-free cloth.
- 5 When finished, reconnect the power cable to the scanner.

Fingerprints or smudges on the underside of the glass do not affect the appearance of scanned images because this area of the glass is outside the focal point of the scanner.



## Uninstalling the software

The Uninstall option of the Installer allows you to remove the scanning software from your computer.

### *To uninstall the software*

- 1 Unplug the scanner, and then restart the computer.

**Note:** If you do not unplug the scanner and restart the computer before you uninstall the software, some files are not removed from your computer during the uninstallation.

- 2 Insert the HP Scanning Software CD into your computer's CD-ROM drive. The HP Scanning Software window appears. (If the HP Scanning Software window does not appear, double-click the icon for the HP Scanning Software CD.)
- 3 Double-click the HP Scanning Software Installer, and then follow the instructions on the screen.
- 4 When the main installation dialog box appears, select **Uninstall** from the pull-down menu (located in the upper-left part of the dialog box).
- 5 Click **Uninstall**.
- 6 Follow the instructions on screen.
- 7 After the uninstall finishes, quit the HP Scanning Software Installer.

## Other resources, support, and specifications

The [Setup and Support Guide](#) contains information about these topics:

- **Setup instructions and troubleshooting.** Find setup instructions and troubleshooting information for issues that can arise when you install the scanner.
- **Resources.** Discover websites and other tools that contain scanning tips, updated drivers, and the latest information about your HP scanner.
- **Support.** Locate the contact information for your region if you need to contact HP.
- **Warranty and Specifications.** See this topic for the warranty and product and regulatory information.

The Setup and Support Guide is located on the CD in the folder for your language, or on your computer in the HP Scanning Software folder.

Also, see the HP PrecisionScan Pro Read Me file for late-breaking information about the HP PrecisionScan Pro software. This file is located in the same folder as the Setup and Support Guide.



# A Using software commands and controls

This section contains information for using the shortcuts, toolbars, and cursors in the HP Precisionscan Pro software.

The HP Precisionscan Pro contains keyboard shortcuts and toolbars to give you quick access to software commands. The Info bar provides information about the scanned image, and the context-sensitive cursors provide information on the type of activity you can perform in the scanning software.

## Using keyboard shortcuts and the menus





This section summarizes the menus and commands in the HP Precisionscan Pro software that you can select using the keyboard.

### Apple ( ) menu



About HP Precisionscan Pro

View information about the program, version, and copyright.

### Scan

New Scan	 +N	Start (preview) a new scan.
Scan To...	 +T	Scan and send to a destination, such as e-mail
Return Image To		When using TWAIN or the HP Scanjet Plug-in, return the scanned image to the other program.
Save As...	 +S	Save the selection area as a file.
Page Setup...		Change how printed pages are set up, including page orientation and paper size.
Print...	 +P	Scan and print the selection area.
Scanner Glass XPA (Slides) XPA (Negatives)		Select the source from which to scan. Only one can be selected.
Settings		
Save...		Save settings.
Load...		Load (use) settings.
Preferences...		Change scanning default preferences.
Quit	 +Q	Close the HP Precisionscan Pro software.

## Edit

Reset Tools	 +Z	Return all settings except output type to the defaults for this image.
Copy	 +C	Scan and place the selection area on the Clipboard.
Select All	 +A	Select the entire scanner glass (including blank space).
Unselect All		Remove the selection border.

## View

Zoom In	Zoom in on the selection area.
Zoom Out	Zoom out to the original view.

## Output Type

True Color	
Optimized Palette	
Web Palette	Choose the output type. Only one can be selected.
System Palette	
Spot Color	
Grayscale	
Black & White Bitmap	
Automatically Set Type	Allow the software to select the output type based on the contents of selection area.

## Tools

Rotate Left 90°	Rotate the image counterclockwise by 90 degrees.
Rotate Right 90°	Rotate the image clockwise by 90 degrees.
Mirror	Reverse the image side-to-side.
Resize	Resize the selection area. This changes the output file size also.
Change Resolution	Change the resolution of the final scanned image.
Sharpen	Adjust the sharpening.

## Advanced

Adjust Color	Adjust colors (hue) and their intensity (saturation).
Adjust Exposure	Adjust the contrast (midtones), detail in light areas (highlights), and detail in dark areas (shadows).
Adjust Black & White	Adjust which values in the image will be represented as black or white.
Invert Colors	Make colors in the image their opposites.
Descreen	In the scanned image, reduce the appearance of undesirable patterns that are in a printed original.

## Help

Show Balloons	Turn on and turn off Balloon Help.
Hide Balloons	If you are using Balloon Help, Hide Balloons appears. If you are not using Balloon Help, Show Balloons appears.
HP Precisionscan Pro 3.1 Help	View the Help for the HP scanning software.  +?
HP Scanjet on the Web	Connect to the Internet and visit the HP Scanjet website.
Product Tour	View the product tour.
User's Manual	View the printable user's manual in PDF format.
Enable All Smart Friends	Allow helpful alerts to appear when potential problems arise.
Disable All Smart Friends	Prevent helpful alerts from appearing when potential problems arise.

## HP Precisionscan Pro tool and information bars

The HP Precisionscan Pro software contains a toolbar and an Info bar to help you use commands quickly or find information about the current scanned image.

### Toolbar

The HP Precisionscan Pro software displays a toolbar containing shortcut buttons for common commands.

Click this button	To
 New Scan	Start (preview) a new scan.
 Scan To...	Perform a final scan and send to a destination, such as e-mail.
 Save As...	Save the selection area as a file.
 Print	Scan and print the selection area.
 Return Image To...	When using TWAIN or the HP Scanjet Plug-in, return the scanned image to the other program.
 Copy	Scan and place the selection area on the Clipboard.
 Zoom In	Zoom in on the selection area.
 Zoom Out	Zoom out to the original view.
 Rotate Left 90	Rotate the image counterclockwise by 90 degrees.
 Rotate Right 90	Rotate the image clockwise by 90 degrees.
 Undo Editing Changes	Return all settings except output type to the defaults for this image.

## Info bar

The info bar appears at the bottom of the preview window and displays the following information:





- the width of the output image
- the height of the output image
- scale of the output image
- the output type currently selected
- one of the following:
  - A progress bar that shows when the scanner is scanning or the scanning software is processing a command.
  - The number of KB (kilobytes), MB (megabytes), GB (gigabytes), or TB (terabytes) in the image in the selection area. This size is only an estimate of the actual size of the image. The file can be larger or smaller than the value shown here. The size of a saved file depends on the format used to save the file.
- an XPA icon, if the **XPA (Slides)** or **XPA (Negatives)** commands are selected in the **Scan** menu



## Context-sensitive cursors

The shape of the pointer indicates the type of activity you can perform in the scanning software.

### Selection area cursor

New selection area		Draw a new selection area.
Move selection area		Drag the selection area to a new location in the preview area. Drag the selection area to another program. Press <b>OPTION</b> and drag the selection area to the desktop or a folder.
Resize selection area horizontally		Appears on the sides of the selection area. Drag the cursor to resize the width of the selection area.
Resize selection area vertically		Appears on the top or bottom of the selection area. Drag the cursor to resize the height of the selection area.
Resize selection area diagonally		Appears on the corners of the selection area. Drag the cursor to resize both the height and width of the selection area.



### Ready cursor

Ready for activity		Click a menu item and select a command. Click a list button to select an option. Click a button to turn it on or off, or to increase or decrease a number.
--------------------	---	--

### Typing cursor

Data entry accepted		Click, then type a value.
---------------------	---	---------------------------

### Pixel value cursor

Highlight eyedropper		Position this cursor over a light area in the image to see its pixel value in the RGB meter and the histogram. Click on pixels to set them as the Highlight value. In the Transparency Exposure Adjustment tool, click to set the RGB value.
Shadow eyedropper		Position this cursor over a dark area of the image to see its pixel value in the RGB meter and the histogram. Click on pixels to set them as the Shadows value.
Eyedropper and the “no” symbol		Indicates this area is an area in which pixel value is not available.



# B Glossary

## symbols

### *8-bit grayscale*

Used to represent black-and-white photos accurately. These grayscale images contain 256 shades of gray.

### *24-bit color*

Color images composed of three 8-bit color channels. When combined, the red, green, and blue channels provide up to 16 million colors. This is also referred to as *true color*.

## a

### *acquire*

A command offered by programs that support TWAIN or the HP Scanjet Plug-in. Selecting Acquire takes you directly to the selected scanning software, and then returns the scanned image to the requesting program.

### *active program*

The program you are currently using or that is currently selected. A program's title bar changes color to distinguish active from inactive programs.

### *ADF*

See *automatic document feeder*.

### *Active XPA*

Or XPA. See *transparency adapter*.

### *ADF*

See *automatic document feeder*.

### *ADF glass*

The piece of glass on the scanner bed that the ADF uses to scan documents from the feeder tray.

*aliasing*

The visibly jagged steps along angled lines or object edges that result from sharp tonal contrasts between pixels. Seen in both black-and-white images and color images. Sometimes called Jaggies.

*anti-aliasing*

A technique that smooths transitions between pixels, reducing the jaggedness of curved lines.

*approximate size*

Reflects the amount of disk space a scan would require if saved to your computer. Approximate Size value does not apply if the output type for the scan is set to text; it only applies to an image representation of the scan.

*auto(matic) cropping*

Automatic cropping displays only the item(s) detected on the scanner bed, not any of the surrounding area.

*automatic document feeder*

Abbreviated ADF, it is an optional accessory that allows you to scan multiple pages.

*Auto(matic) resolution*

A feature of the scanning software that automatically applies the optimal output resolution to the selection area. For example, output resolution is automatically set to 200 when the True Color output type is selected, and set to 300 for the Black & White Bitmap (raster) output type.

**b***bit depth*

The number of bits used to define the shade or color of each pixel in an image. A 1-bit image is black and white. An 8-bit grayscale image provides 256 shades of gray. An 8-bit color image provides 256 indexed colors and is associated with a specific palette or color table. A 24-bit image provides over 16 million colors. The greater the bit depth, the larger the size of the saved file. See *also* file size.

*bitmap*

A type of black-and-white, gray, or color image or picture made up of a matrix of individual pixels or dots. Often referred to as raster, raster bitmap, or raster image.

*black & white bitmap*

Black & white raster bitmaps contain only black pixels and white pixels, no colors or shades of gray. Each pixel represents one bit.

*Black & White Threshold tool*

The Black & White Threshold tool lets you change the dividing point for black-and-white pixels in an image that uses the Black & White Bitmap (raster) output type. All pixels below the threshold will be output as black, and all pixels above the threshold will be output as white.

*border*

A line surrounding the scanned image indicating scanning boundaries. Clicking the image reveals a selection border and handles that are used to define the scanning region.

*brightness*

The balance of light (highlights) and dark (shadows) in an image. In black-and-white images, the lower the brightness, the closer the image will be to black. The higher the brightness, the closer the image will be to white. Brightness should not be confused with contrast, which measures the range between the darkest and lightest shades in an image. Brightness determines the intensity of shades in an image, while contrast determines the number of shades in the image.

**C***click*

To press and release the mouse button once.

*clipped pixels*

Pixels in an image that are extremely light or extremely dark and that would lose detail when the image is printed or displayed.

*CMYK*

Cyan, Magenta, Yellow, Black. The color model in which all colors are composed of Cyan, Magenta, and Yellow, the primary colors of pigments like ink, plus Black. Printers use CMYK to print in color.

*converted text*

Text that has been rendered into digital format by an OCR program.

*color balance*

The preservation of balance between colors throughout the tonal range. Color balance is particularly important when scanning objects that include neutral tones (grays) or large areas of consistent color.

*color channel*

The red, green, and blue components from which colors are created.

*color correction*

The process of adjusting an image to compensate for input and output device characteristics or color flaws in the original image.

*color depth*

The number of colors that a monitor can display at once. Most Macintosh monitors can display in 256 grays, 256 colors, thousands of colors, and millions of colors. The higher the color depth, the more lifelike images look on screen.

*color wheel*

A tool used to adjust the color balance and hue.

*configure*

The ability to adjust settings that determine how the scanner buttons and scanning software perform operations.

*context-sensitive Help*

Context-sensitive Help answers questions related to the currently displayed window. The Help is provided in four ways: Text Labels, ToolTips, Info bar messages, and Help commands.

*contrast*

The range between the lightest and darkest shades in an image. An image with high contrast has few gray shades between black and white and appears to be dominated by stark light and dark tones. An image

with low contrast has many shades of gray and tends to look flat and dull. Change contrast using the highlight, shadow, and midtone settings.

### *control range*

This range determines the number of bits used for exposure compensation, shadow detail, and black-and-white threshold adjustment displays. The higher the bit depth, the finer the level of control in adjusting these image manipulation functions.

### *crop*

To eliminate portions of an image from the final scan.

## **d**

### *default settings*

Predetermined settings in the scanning software that define levels on your behalf. Default settings in the HP Precisionscan Pro software are set for Output Type, Output Resolution, Color, Exposure, Black & White Threshold, and Sharpen Level. You can override default settings.

### *density*

The ability of a material to absorb or transmit light. The greater the density of a material or object, the more black it contains. This applies to both black-and-white images and color images.

### *descreen*

The process of removing an unwanted pattern, such as a moiré pattern, that appears in a printed original so the pattern does not appear in the scanned image.

### *destination*

The file, program, or hardware device where the scanned image will be used. Examples include a printer, a Web page, or an e-mail program.

### *device driver*

Software that the system uses to communicate with devices, such as a display, printer, mouse, or scanner.

### *display resolution*

The number of pixels that a computer monitor can display both horizontally and vertically. Screen resolutions are typically 640 x 480 (VGA), 800 x 600 (super VGA), or 1024 x 786.

### *dithering*

The process of approximating pixel colors when reducing the color depth of an image. Dithering can improve transitions between colors when reducing a 24-bit image to 8-bit format.

### *document*

For the purposes of this documentation, document refers to an original item containing text or both text and images. It also means an original item scanned using the automatic document feeder.

### *dots per inch*

See *dpi*.

### *double-click*

To press and click a mouse button twice in rapid succession.

*dpi*

Dots Per Inch. The number of dots in a linear inch. DPI measurements are used to describe the resolution of printers and scanners, where printed images and words are made up of a series of round dots. The greater the DPI number, the higher the resolution.

*drag*

To move an object on screen. Place the cursor over the image or selection area, hold the mouse button down, and move the mouse to move the object.

*drag-and-drop*

To move an object to a new location and keep it there. Click on the object and drag it to a new location, such as an open document in another program, and release the mouse button. When dragging-and-dropping between programs, a copy of the object is placed in the receiving program.

*drop-down list (or menu)*

A list of items that appears when you click on or pass the cursor over a command such as **File** or **Edit**.

**e***editable text*

Text that is converted from a scanned image into characters you can modify in a word processor or other text-editing program. Depending on the capabilities of your program, you can change the font, size, style, and other attributes of editable text, as well as edit words or phrases.

*e-mail*

A network over which you can transfer messages and electronic files. E-mail is also sent via Internet browsers.

*export*

To save a file in a particular file format for use in other programs.

*exposure*

The amount of light, or brightness and contrast, in an image.

**f***file format*

The format in which a scan is saved. Certain file formats enable programs such as word processors to insert, open, or import scans. Common graphics formats include JPG, GIF, and TIFF. Common text formats include plain text and RTF (Rich Text Format).

*file size*

The number of bytes in a file. The file size of scanned images is determined by resolution, file type, output type, and scaling. To reduce the file size of photographs, for example, you could decrease bit depth or resolution.

*final scan*

The actual image, defined by the selection area, that is sent to a destination such as a file, a printer, the Clipboard, or another program.

*final size*

The approximate height and width of the final image to be scanned.

*flowed text*

The Flowed Text option converts output into one column, placing images as closely as possible to the appropriate text.

*framed text*

The Framed Text option places text and images in a frame, positioned as closely as possible to the way they appear in the original document. Text may be more difficult to edit extensively since the frames may not expand to hold additional text.

*focus*

Refers to the sharpness of an image.

*front panel*

The area on the front of the scanner hardware containing the buttons for sending an item to a destination or changing settings.

**g***gamma*

The contrast that affects the mid-level grays or midtones of an image. Adjusting the gamma of an image allows you to change the brightness values of the middle range of gray tones without dramatically altering the shadows and highlights. This applies to both black-and-white images and color images. The default setting of 2.2 ensures integrity among computer systems.

*grainy*

Refers to images, pictures, or photographs in which individual pixels are relatively large and have areas of white between them, thus reducing the overall perceived quality of the image. Graininess can occur when you scan a poor-quality original or reduce the bit depth of the scanned image by dithering or halftoning.

*Graphics Interchange Format (GIF)*

A graphic file format that is supported by many programs. Files saved in this format support 256 colors.

*grayscale*

An original or output type containing shades of gray, not just black and white. In a grayscale image, each pixel contains multiple bits of information, allowing more shades of gray to be recorded and displayed. Four bits can reproduce up to 16 levels of gray, and eight bits can reproduce 256 shades of gray. Grayscale is commonly used for black-and-white original photographs but is also effective in maintaining shading in pencil drawings.

**h***halftone*

An original composed of a pattern of dots that tricks the eye into seeing shades of gray or color. Halftones are common in all printed materials. Scanning halftones instead of photographic originals can result in lower final image quality.

*height*

The vertical dimension of a scan as it will appear at its destination.



### *highlights*

The lightest portion of an image, usually reproduced as white on the computer screen or when printed.

### *histogram*

A graphical representation of the concentration of pixels at each intensity or gray level in the selection area of the scanned image. Histograms help determine the optimal highlight, shadow, or threshold value of an image.

### *HP Scanjet Copy Utility*

A software utility used to select number of copies, destination printer, and other copy options.

### *HP Precisionscan Pro software*

The scanning software that HP provides for previewing an image before sending it to a destination; making changes, such as resolution, resizing, and contrast; and saving images as files.

### *HP Scanjet Plug-in*

A Photoshop plug-in for image editor and OCR programs, which allows you to scan text and images from within these programs.

### *HP Share-to-Web*

An automated feature that sends scanned images directly to a destination on the Web. Links are available only in English.

### *HTML*

HyperText Markup Language. A language used in creating documents for the World Wide Web. Documents can be saved in HTML.

### *hue*

The distinctive characteristic of a visible color that enables you to distinguish it from other colors. Six hues are especially important in photography, scanning, and printing: red, yellow, green, cyan, blue, and magenta. Hue is determined by the frequency of the wave of light that creates the color. *See also* saturation.

## **i**

### *image*

An electronic picture that can be displayed on a computer screen or saved to a disk.

### *image editor*

A program that lets you modify bitmapped drawings and photographs.

### *image size*

The size of the image expressed in bytes and displayed in the Info bar. File size and image size may vary, depending on the file type.

### *import*

To bring a scanned image into a document from another program.

### *Info bar*

A form of assistance that appears in the lower, left corner of the screen and displays the width and height of the output image, the scale percentage, the output type currently selected, and the size of the output image.

### *interface connection*

The connection between the scanner and the computer. This can be either a USB, parallel, or SCSI connection depending on the model of scanner and your operating system.

### *interpolated resolution*

Resolution that is changed in the scanning software rather than in the hardware. For example, if your scanned image is 600 dpi, you might be able to enhance it to 1200 dpi in the scanning software. This is useful for enlarging small images.

### *interpolation*

The process of increasing the resolution of an image by the addition of new pixels throughout the image, the colors of which are based on neighboring pixels.

### *invert*

To reverse the colors in an image (for example, in a black-and-white image, black areas are turned white and white areas are turned black).

### *item*

The physical drawing, photo, collage, etc. you place in the scanner to scan. Once it is scanned, it is referred to as an image or scanned image.

## j

### *jagged*

Refers to the uneven transition between black and white, or areas of color, in a scanned image. Jagged edges can be avoided by scanning at a higher resolution than your output device, or by not scaling the image after scanning it.

### *JPEG*

Joint Photographic Experts Group. A compressed file format that reduces file size and enables faster file access. This format can reduce image quality and performance when the file is decompressed and recompressed.

## k

### *keyboard shortcuts*

A keystroke or combination of keystrokes that allows you to quickly accomplish common tasks.

## l

### *landscape*

The orientation of a photograph or image that is wider than it is tall. When an image is taller than it is wide, it is called portrait orientation.

## m

### *maximum pixel depth*

This option enables higher bits per pixel when the scan is sent to the software. When it is off, 8 bits per pixel are returned for grayscale and 24 bits for color. When it is turned on, 16 bits per pixel are returned for grayscale and 48 bits for color.

*midtone*

The gray shades of an image. Midtones are usually between 30% and 70% black. Midtone control adjusts the brightness of gray levels in the image so that the lightest and darkest portions of the image can be properly displayed on your monitor. The higher the setting, the brighter the image appears on your monitor.

*millions of colors*

Color images that are composed of three 8-bit color channels. When combined, the red, green, and blue channels provide up to 16 million colors. Sometimes referred to as “true color” and “24-bit color.”

*moiré*

An undesirable pattern in color printing that results from incorrect screen angles of overprinting halftones. Moiré patterns usually result when you scan a halftone, when you scan images taken directly from a magazine, or when you scale an image in an image editor after it is scanned.

**n***negative holder*

This XPA piece holds negative strips for scanning. Insert it into the slide holder on the bottom of the XPA light source for proper scanning of negatives.

*negative light shield*

This XPA piece blocks excess illumination and improves image quality when scanning negatives. Slide it into the negative holder after the chosen negative strip.

*noise reduction*

This option reduces the noise (unwanted specks) in an image by applying software algorithms to minimize the effects of noise in the scanner electronics.

**o***OCR*

See *optical character recognition*.

*optical character recognition*

Abbreviated OCR. A technology that recognizes letters in a scanned image and converts them into ASCII characters, or editable text.

*optical resolution*

The true resolution of a scanner, the resolution at which the scanner captures images. See also *interpolated resolution*, *resolution*.

*optimized palette*

A palette or color table that contains the pixel colors present in an image.

*original*

The original document or picture to be scanned.

*output*

The file that is generated by the scanning process.

*output dimensions*

The actual height and width of an image when saved. You will not see the size changes to your image in the Preview area since image size affects only the final scan.

*output type*

The type of file that is generated during the scanning process. Output type reveals the bit depth of the image.

**P***palette*

A subset of the color look-up table that establishes the colors that can be displayed on the monitor at a particular time. The only color depth that allows multiple palettes is the 256 (or 8-bit) color setting for your monitor. At a color depth of 256 colors, each program (or even each individual image used or edited in a program) can have a different color palette.

*palette flashing*

The flashing that occurs when your monitor is set to a color depth of 256 colors and you switch programs. When you switch programs, the palette of the active program becomes the system palette, and all other programs redraw themselves as accurately as possible with the new colors.

*PDF*

Portable Document Format (PDF) format. Adobe Acrobat files use this format.

*PICT*

Apple's proprietary image file format that is used by the Mac OS. Designed for the screen, this format is best used for color images that will not be printed. Images saved as PICT files are smaller in size than images saved as a TIFF files.

*pixel*

The smallest element (picture element) that can be assigned an independent color and intensity and can be displayed on a computer screen. Pixels are square dots arranged in a grid pattern to make up the images displayed on the screen.

*plug-in*

A module that integrates into a program to provide additional functionality. The HP Precisionscan Pro Installer adds a Photoshop plug-in (the HP Scanjet Plug-in) for image editor and OCR programs that allows you to scan text and images from within these programs.

*PNG*

Portable Network Graphics format. A compressed image file format suitable for the Web that might replace GIF because of copyright issues with GIF format. PNG is non-lossy compressed, supports interlacing, and can be used with the True Color output type, which GIF cannot.

*pop-up menu (or list)*

A menu of items that appears when you click on or pass the cursor over a command.

*portrait*

Orientation of a photograph or image that is taller than it is wide. An image that is wider than it is tall is called a landscape orientation.

*positioning plate*

This XPA piece is a large template with a rectangular cutout that orients proper placement of the XPA light source on the scanner bed.

*posting scans*

Term for scanning items directly to a website.

*Power Save*

An energy conservation method that reduces power consumption when the scanner is idle for a period of time.

*PPI*

Pixels Per Inch. A measurement of resolution for monitors and scanners where the individual element is a square pixel.

*preferences*

Refers to your preferred method of using the scanner. The scanning software automatically saves certain preferences, such as the location of toolbars and the destination of a scan, that it detects during normal use of the scanner. Some preferences are restored each time the scanner is used, while others are maintained only throughout a scanning session.

*preview*

A feature that displays a scanned image so you can view it in the scanning software. You can then select an area to be saved; make adjustments to the tone, color, and size; and save the final image.

*preview window*

The rectangular area in the software where the scanned image is displayed.

*printer resolution*

A measurement of the number of dots per inch (dpi) the printer is capable of printing. Typical laser printers have resolutions of 600 dpi, typical ink printers have resolutions of 300 dpi for photographs and 600 dpi for text, while imagesetters have resolutions of 1200 or 2400 dpi. The more dots per inch, the smoother the output and the greater the number of grayscale levels and colors the device can describe.

*product tour*

The product tour provides an overview of the scanner's capabilities and how scanning tasks are completed. It appears each time the scanning software starts, unless it is specifically disabled. It is also available in the **Help** menu.

**q****r***raster*

A type of black and white, gray, or color image or picture made up of a matrix of individual pixels or dots. This is also referred to as a bitmap.

*resolution*

The measure of how many dots per inch (dpi) are scanned, displayed, or printed. The greater the dpi, the greater the amount of detail that is visible, and the larger the file size. The final output device (monitor, printer) for a scanned image determines the resolution of the image. For example, if you scan a picture at 600 dpi (the optimum) and your printer is capable of printing at only 300 dpi, the printed image will be no more than 300 dpi.

*RGB*

Red, Green, Blue. The color model in which every color is composed of a varying amount of red, green, and blue, which are the three primary colors of light. RGB is used to display colors on a computer monitor.

*rich text format*

A format for text files. Rich Text Format preserves all formatting in the original text document. It converts formatting into instructions that compatible programs can interpret.

*rotate tool*

To rotate the entire scan 90 degrees clockwise or 90 degrees counterclockwise.

**S***saturation*

The intensity of color in a specific hue. An image with high color saturation has vivid color. A black-and-white photograph has zero saturation. *See also* hue.

*scale*

To reduce or increase the physical size of an image while maintaining aspect ratio (the ratio of the horizontal dimension to the vertical dimension).

*scan*

To capture a picture, photograph, or text as a digital electronic image using a scanner. This term also refers to the image that has been scanned.

*scanner bed*

The glass surface of the scanner where you place items to scan. Sometimes referred to as the scanner glass.

*scanner glass*

The glass surface on the scanner where you place items to scan. Sometimes referred to as the scanner bed.

*scanner lid*

The lid, or cover, of the scanner, which holds the original paper flat for scanning.

*scanning source*

Scanning (or scan) sources include the flatbed, transparency-slides, and transparency-negatives.

*screen resolution*

The measurement of the number of lines per inch (lpi) that a screen can display. This is usually 72 lpi.

*settings*

Saving settings allows you to save a set of settings used with one scanned image and reuse the settings with an image scanned in the future.

*selection area*

The area inside the rectangular border drawn around a portion of the image in the Preview area. The selection area is scanned when you drag-and-drop, save to a file, copy to the clipboard, or print.

*shadow*

The darkest area of an image, usually reproduced as near black on the computer screen or when printed. The range between highlight and shadow determines the quality and color differentiation in the image.

*sharpen*

To enhance the detail in an image.

*slide holder*

This XPA piece holds slides for scanning. It is attached to the bottom of the XPA light source.

*slide light shield*

This XPA piece blocks excess illumination and improves image quality when scanning slides. Slide it into the slide holder after the chosen slide(s).

*Smart Friends*

Smart Friends are tips that appear automatically to notify you of potential problems. For example, if you are setting a very high resolution but want to use e-mail to send the scanned image, a Smart Friend would alert you that the file will probably be too large to send in e-mail.

*source*

The program from which an image is retrieved for use in a document. Programs that support TWAIN or the HP Scanjet Plug-in pull an image from a source, such as the HP Precisionscan Pro software.

*Speed Destinations*

The list of destinations available when configuring the Scan To button options in the HP Scanjet Controls control panel. This list of destinations appears in place of the standard Scan To button options and allows the settings for each available destination to be set from one dialog box, rather than by selecting each destination separately from a pull-down menu. Speed Destinations are available with some scanner models.

*spot color*

A software function that finds large areas of color in a scanned image and applies a uniform color to the area.

*sRGB*

An international color standard and the default color system used for all HP peripherals, the World Wide Web, and most office software.

*system palette*

A palette or color table containing a Web palette plus more shades of gray and the 16 VGA colors.

**t***text*

As it relates to scanning, text is saved in the following formats: plain text, HTML, and RTF.

*thresholding*

The process of rendering all areas darker than a set value as black, and all areas lighter than a set value as white. Useful when converting grayscale images to black and white.

*TIFF*

Tagged Image File Format. A bitmapped file format for images, capable of storing up to 24-bit depth images. TIFF file format is especially appropriate for scanned images and is supported by many programs and computers.

*TIFF compressed*

Tagged Image File Format, compressed. A bitmapped file format for images, capable of storing up to 24-bit depth images. TIFF file format is recommended for scanned images and is supported by many programs and computers. TIFF compressed files use data compression to reduce the size of the resulting file.

*tone*

The overall effect produced by the combination of lighting, shade, and color.

*toolbar*

The area that contains buttons for a program's controls.

*transparency adapter*

Abbreviated as XPA. An optional accessory used to scan negatives and slides. An XPA connector is plugged into the scanner, and a template is used to position the transparency above the glass.

*True Color*

An image type that is rendered with 24-bits per pixel per color.

*TWAIN*

An industry-standard communications protocol for sending instructions to hardware (such as a scanner) and receiving image data back from them. If you are using a program that supports TWAIN, you can start the HP Precisionscan Pro software directly from that program.

**U***uniform scaling*

A method of stretching or shrinking an image proportionately in both the vertical and horizontal directions.

*USB*

Universal Serial Bus. An interface for connecting peripherals, such as scanners, to a computer.

**V***vector*

A type of image that uses algebraic equations to define the various lines and curves of the image.

**W***Web palette*

A palette or color table containing red, green, and blue pixel colors that is standard for images embedded in Web pages or HTML files. It consists of 216 entries of all combinations of the values 0, 51, 102, 153, 204, and 255.



*width*

The horizontal dimension of your scan as it is sent to its destination.

**x***XPA*

*See transparency adapter.*

*XPA light source*

This XPA piece is a light that plugs into the scanner. It fits into the positioning plate and provides backlighting in order to properly scan transparent slide and negative images. (It may also be used as a light box for viewing slides.)

**y****z***zoom scan*

The ability to enlarge, or magnify, the image in the Preview area so that finer adjustments can be made to the image. This action does not enlarge the picture that is saved, printed, copied to the Clipboard, or dragged into another program.



# Index

## A

About HP Precisionscan Pro command 116  
 abrasive cleaners, avoiding 112  
 accessories, using 77  
 accuracy, OCR 76  
 acquiring scans 74  
 active program, definition 123  
 adapter, transparency. *See* XPA  
 ADF (automatic document feeder)  
   capacity 105  
   cleaning 112  
   document specifications 17  
   feeding problems 105  
   glass, definition 123  
   jams, clearing 108, 110  
   jams, preventing 105  
   loading 78  
   models including 3  
   page size options 38  
   Scan dialog box 78  
   scanning from 78  
   troubleshooting 105  
 Adjust Black & White command  
   shortcuts 118  
   using 57  
 Adjust Color command  
   shortcuts 118  
   using 56  
 Adjust Exposure command  
   highlights 51  
   midtones 50  
   shadows 52  
   shortcuts for 118  
   transparent items, using for 83  
 adjusting  
   backgrounds 54  
   black and white threshold 57  
   brightness 50  
   color channels 58  
   contrast 46  
   highlights 51  
   hue 56  
   midtones 50  
   output levels 54  
   preferences for scanner buttons 35

  preferences for scanning software 70  
   saturation 56  
   shadows 52  
   tonal resolution 73  
 Adobe Acrobat Reader 62  
   *See also* PDF files  
 Adobe Photoshop Plug-in. *See* HP Scanjet  
   Plug-in  
 Advanced menu, shortcuts for 118  
 alarms, highlight and shadow 53  
 albums, photo 30  
 alcohol, cleaning with 111, 112  
 alerts  
   highlight 53  
   shadow 53  
   Smart Friends 40  
 aliasing, definition 124  
 anti-aliasing, definition 124  
 Apple Menu  
   About HP Precisionscan Pro command 116  
   Control Panels 35  
 applications. *See* programs  
 approximate size  
   definition 124  
   viewing 120  
 areas, selecting. *See* selection areas  
 ASCII text, saving as 62  
 attachments, e-mail  
   creating 31  
   naming 32  
   Prompt for e-mail attachment name option 37  
 automatic cropping  
   definition 124  
   settings 38  
 automatic document feeder. *See* ADF  
 automatic exposure adjustment 72  
 automatic resolution 124  
 Automatically Set Type option 43

## B

backgrounds, adjusting 54  
 balance, color  
   adjusting 56  
   definition 125  
 Balloon Help 118  
 bed, scanner  
   definition 134  
   printing entire 63  
   selecting entire 42  
 best quality settings 71  
 bit depth, definition 124  
 bitmap files, definition 124  
 black and white bitmaps  
   adjusting colors in 58  
   definition 124  
   shortcut for 117  
 black and white copies  
   button for 27  
   making 22, 33  
 black and white images  
   inverting colors 49  
   output types for 44  
 Black and White output type, selecting 38  
 black and white threshold  
   changing 57  
   definition 124  
 black areas, adjusting 52  
 black eyedropper tool 52  
 black images, troubleshooting 94  
 black output levels, changing 54  
 blank pages, troubleshooting 33, 94, 96  
 blue color channel 58  
 blurred scans, troubleshooting 94  
 books, scanning pages from 17  
 borders, selection  
   definition 124  
   moving 42  
 boxes  
   around slides or negatives 98  
   around text 75  
 brightness  
   adjusting 50  
   definition 125  
 bulbs, broken 98, 104  
 business cards, scanning 17  
 Buttons tab, HP Scanjet Controls  
   accessing 35  
   ADF Page Size options 38  
   Destinations options 37  
   Image options 38

  Scan To settings 36  
 buttons. *See* scanner buttons

## C

Cancel button 27  
 canceling scans 33  
 capacity, ADF 105  
 carbon paper, scanning 17  
 CDs, scanning to 67  
 Change Resolution 117  
 characters, incorrect 99  
 checklist, troubleshooting 88  
 cleaning  
   ADF 112  
   scanner 111  
   XPA 112  
 clearing ADF jams 108, 110  
 click, definition 125  
 clipped pixels  
   checking for 53  
   definition 125  
 CMYK, definition 125  
 collating copies 33  
 color balance  
   adjusting 56  
   definition 125  
 color channels  
   changing 58  
   definition 125  
 color copies  
   button for 27  
   making 33  
 color correction  
   automatic 72  
   definition 125  
   highlights, adjusting 51  
   hue, adjusting 56  
   midtones, adjusting 50  
   saturation, adjusting 56  
   shadows, adjusting 52  
 color depth  
   definition 125  
   output types 44  
 color output types 44  
 color wheel

- adjusting hue 56
  - definition 125
  - colored paper
    - adjustments for 58
    - copying from 96
  - colors
    - automatic adjustment 72
    - converting to black and white 58
    - highlights, adjusting 51
    - hue, adjusting 56
    - inverting 49
    - midtones, adjusting 50
    - negatives, troubleshooting 98
    - output types 43
    - RGB values, viewing 55
    - saturation, adjusting 56
    - shadows, adjusting 52
    - slides, troubleshooting 98
    - tonal resolution 73
    - troubleshooting 94, 97
  - comparison, features 3
  - compressed file formats 62
  - context-sensitive Help
    - See Help, online
  - contrast
    - adjusting 46
    - definition 125
  - Control Panels, HP Scanjet Controls 35
    - See also Buttons tab, HP Scanjet Controls
  - control range, definition 126
  - Controls tab options 73
  - converting text. See OCR
  - copies, making
    - quality, troubleshooting 96
    - troubleshooting 101
    - using HP Scanjet Copy Utility 16
    - using scanner button 33
  - Copy button
    - locating 27
    - troubleshooting 106
    - using 33
  - Copy command
    - shortcuts 117, 119
    - using 65
  - Copy Utility, HP 16
  - copying and pasting
    - toolbar shortcut 119
    - using Clipboard 65
  - correction, color
    - automatic 72
    - definition 125
    - highlights, adjusting 51
    - hue, adjusting 56
    - midtones, adjusting 50
    - saturation, adjusting 56
    - shadows, adjusting 52
  - crooked images, troubleshooting 94
  - crooked pages, troubleshooting 105
  - cropping
    - automatic, settings for 38
    - definition 126
    - scanning area 42
  - Current OCR Language option 73
  - cursor
    - black eyedropper 52
    - context-sensitive 121
    - dragging-and-dropping 66
    - Ready 121
    - Selection Area 121
    - Typing 121
    - white eyedropper tool 51
  - customer support
    - resources for 113
  - customizing
    - See also settings
    - preferences for scanning software 70
    - resolution values 72
    - scanner buttons 35
  - cut off pages, troubleshooting 96
- ## D
- dark areas
    - adjusting 52
    - troubleshooting 93
  - darkening images 50
  - dashed boxes 98
  - decreasing
    - details for transparent items 84
    - details in dark areas 52
    - details in light areas 51
    - saturation 56
  - default programs, changing 35, 99
  - default settings
    - See also settings
    - definition 126
    - resetting image adjustments 48
  - Restore Defaults (scanner buttons) 35
    - Scan To button 36
  - deleting selection areas 42
  - density, definition 126
  - depth, color
    - definition 125
    - output types 44
  - Descreen command
    - settings 71
    - shortcuts 118
    - using 59
  - desktop, dragging-and-dropping to 66
  - destinations
    - definition 28
    - options 37
    - Scan To button, changing 36
    - scanning to 29
    - select button 26
    - Speed 8, 36
    - troubleshooting 101
  - details
    - black and white threshold 57
    - clipped, checking for 53
    - decreasing in dark areas 52
    - decreasing in light areas 51
    - enhancing 52
    - increasing in dark areas 52
    - increasing in light areas 51
  - device driver, definition 126
  - dimensions
    - paper sizes 17
    - resizing images 45
  - Disable All Smart Friends 40, 118
  - display resolution
    - definition 126
    - image quality 23
    - output types for 44
  - distribution, pixel 55
  - dithering, definition 126
  - documentation, printing 15
  - documents, definition 126
  - dots per inch (dpi), definition 127
    - See also resolution
  - dots, troubleshooting 93
  - double-click, definition 126
  - dpi (dots per inch), definition 127
    - See also resolution
  - dragging-and-dropping
    - between programs 66
    - definition 127
    - to desktop 66
  - drawings, output types for 44
  - drop-down list, definition 127
- ## E
- edges not printing 96
  - Edit Destination 36
  - Edit menu, shortcuts for 117
  - editable text
    - accuracy of 76
    - creating using OCR 75
    - definition 127
    - languages 73
    - options for 73
    - Scan To Text File 23
    - troubleshooting 99
  - 8-bit grayscale, definition 123
  - E-mail button
    - locating 26
    - troubleshooting 101
    - using 32
  - e-mail, definition 127
  - e-mailing scans
    - attaching files 31
    - file sizes 46
    - supported programs 31
    - troubleshooting 101
    - using scanner buttons 32
  - Enable All Smart Friends 40, 118
  - Enable Scan Another Page Dialog 71
  - Energy Save mode 107
  - enhancing details 48, 52
  - error messages 90
  - export, definition 127
  - exposure
    - adjusting 50
    - automatic adjustments 72
    - definition 127
  - eyedropper tools
    - black 52
    - functions of 121
    - viewing RGB values 55
    - white 51
- ## F
- fabric, scanning 17

- FAQs (frequently asked questions) 22
- Faster Scan mode 107
- features, scanner models 3
- feeding problems, ADF 105
- file formats
  - e-mail attachments 32
  - supported 91
  - types of 62
  - websites 64
- File name, e-mail attachments 32
- File Open 91
- file sizes
  - definition 127
  - reducing 23
  - resolution changes 46
  - status bar 120
- files
  - See also* file formats
  - attaching to e-mail 31
  - dragging and dropping 66
  - lost 90
  - saving to 61
- film, scanning
  - adjusting colors 83
  - negatives 81
  - slides 79
  - troubleshooting 98
- final scans
  - definition 127
  - selecting areas for 42
- fingerprints, cleaning 111, 112
- flashing palette, definition 132
- flipping images 47
- flowed text
  - definition 128
  - preferences 73
- focus, definition 128
- folders, dragging-and-dropping to 66
- font sizes, OCR 76
- Force Quit 88
- Format, e-mail option 32
- formats. *See* file formats
- formatting, text 100
- framed text
  - definition 128
  - preferences 73
  - removing frames 75
- frequently asked questions 22
- front panel, definition 128
- frozen programs 88
- fuzzy images
  - sharpening 48
  - troubleshooting 95, 97
- G**
- gamma
  - changing setting 71
  - definition 128
- GIF files
  - definition 128
  - output types for 44
  - using 62
- glass cleaner, using 111, 112
- glass, ADF
  - cleaning 112
  - definition 123
- glass, scanner
  - cleaning 111
  - definition 134
  - loading items 19
  - preparing documents for 17
- grainy, definition 128
- graphics
  - See also* images
  - cut off 96
  - file formats 62
  - OCR conversions 75
- Graphics Interchange Format. *See* GIF files
- grayscale
  - 8-bit 123
  - definition 128
  - option, selecting 38
  - output type, using 44
  - shortcut for 117
- green color channel 58
- grinding sounds, troubleshooting 91
- gum-backed paper, scanning 17
- H**
- halftone, definition 128
- handwriting, converting 76
- Height field, resizing images 45
- Help, Balloon 118
- Help, online
  - HP Scanjet Copy Utility 16
  - printing 15
- shortcuts for 116, 118
- using 40
- highlights
  - adjusting 51
  - alarms 53
  - automatic adjustment 72
  - clipped areas, checking for 53
  - definition 129
  - histogram 55
  - transparent items, adjusting for 84
- histograms 55, 129
- HP Precisionscan Pro Help 40
- HP Precisionscan Pro software
  - customizing settings 69
  - dragging-and-dropping files using 66
  - features 39
  - help, using 40
  - menus, troubleshooting 92
  - preferences, setting 70
  - product tour, viewing 15
  - Scan To button, using 28
  - scanning with 41
  - settings, automatic 22
  - Share-to-Web 64
  - shortcuts 116
  - starting 40
  - toolbar shortcuts 119
  - tools 45
  - uninstalling 113
  - when to use 16
- HP Scanjet Automatic Document Feeder. *See* ADF (automatic document feeder)
- HP Scanjet Controls. *See* Buttons tab, HP Scanjet Controls
- HP Scanjet Copy Utility 16
- HP Scanjet on the Web 118
- HP Scanjet Plug-in
  - definition 129
  - returning scans with 61
  - troubleshooting 103
  - using 74
- HP Share-to-Web 64
- HP Share-to-Web wizard 30
- HTML file formats
  - definition 129
  - using 62
- hue
  - adjusting 56
- automatic adjustment 72
- definition 129
- keyboard shortcuts 118
- I**
- Image and Text option 37
- Image file, e-mail setting 31
- Image option 37
- Image Output options 38, 73
- image quality, troubleshooting 93
- images
  - darkening 50
  - definition 129
  - file formats 62
  - highlights, adjusting 51
  - inverting colors 49
  - lightening 50
  - midtone, adjusting 50
  - mirroring 47
  - output levels, adjusting 54
  - resizing 45
  - rotating 47
  - sending to programs 60
  - shadows, adjusting 52
  - sharpening 48
- Import command 91
- import, definition 129
- importing scans 74
- increasing
  - details 52
  - image clarity 48
  - saturation 56
- info bar 120, 129
- input tray, ADF
  - loading 78
  - troubleshooting 105
- insufficient memory, troubleshooting 96
- intensity. *See* saturation
- interface connection
  - definition 130
- internal mirror, contaminated 96
- interpolated resolution, definition 130
- Invert Colors command
  - shortcuts 118
  - using 49
- isopropyl alcohol, cleaning with 111, 112

**J**

- jagged images
  - definition 130
  - troubleshooting 97
- jaggies, definition 124
- jams, ADF
  - clearing 108, 110
  - preventing 105
- JPEG files
  - definition 130
  - output types for 44
  - using 62

**K**

- keyboard shortcuts 116
- keys. *See* scanner buttons

**L**

- lamp
  - automatic turn-off 91
  - broken 98, 104
  - modes 107
  - stays on 90
- landscape orientation, definition 130
- languages, OCR 73
- launching software 40
- lid, scanner 134
- light areas
  - adjusting 51
  - copies, troubleshooting 96
  - scans, troubleshooting 93
- light bulbs
  - broken 98, 104
  - stay on 90
- light media, scanning 17
- light shield
  - negatives 81
  - slides 80
- light source, XPA 80, 137
- lightening images 50
- lines, troubleshooting 93, 96
- loading items
  - ADF 78
  - scanner glass 19
- loading settings 69
- lock, scanner 90
- long items, scanning 106

**M**

- magazine pages, scanning 17
  - making copies
    - black and white 22
    - quality, troubleshooting 96
    - troubleshooting 101
    - using HP Scanjet Copy Utility 16
    - using scanner button 33
  - manual, printing 15
  - margins, adjusting for 96
  - Maximum Pixel Depth
    - definition 130
    - option 71
  - memory, insufficient 96
  - menu shortcuts 116
  - menus, troubleshooting 92
  - messages, error 90
  - Microsoft Word, removing frames in 75
  - midtones
    - adjusting 50
    - automatic adjustment 72
    - definition 131
    - range for 50
    - transparent items, adjusting for 83
  - millions of colors 131
  - Mirror command
    - shortcuts 117
    - using 47
  - mirror, contaminated 96
  - mirroring images
    - keyboard shortcuts for 117
    - using tools 47
  - misfeeds, ADF 105
  - models, features 3
  - moiré, definition 131
  - More Options button
    - locating 27
    - using 35
  - moving selection areas 42
  - multipart forms, scanning 17
  - multiple feeds, troubleshooting 105
  - multiple pages
    - options for 37, 71
    - scanning 28
- N**
- naming e-mail attachments 32, 37
  - negative holder
    - definition 131
    - using 81
  - negative light shield
    - definition 131
    - using 81
  - negatives
    - adjusting colors 83
    - scanning 81
    - troubleshooting 98
  - new documents, troubleshooting 102
  - New Scan command
    - shortcuts 116, 119
    - using 41
  - news clippings, scanning 17
  - noise reduction
    - definition 131
    - settings for 71
  - noisy scans, troubleshooting 91
  - not responding, troubleshooting 91
  - NTSC Gray channel 58
  - Number of copies button
    - locating 27
    - using 33

**O**

- OCR
  - accuracy of 76
  - definition 131
  - languages for 73
  - options for 73
  - preparing text for 76
  - saving scans for future processing 61
  - Scan To Text File 23
  - scanning to 75
  - troubleshooting 99
- onionskin paper 17
- online Help
  - HP Scanjet Copy Utility 16
  - printing 15
  - shortcuts for 116, 118
  - using 40
- online viewing, optimizing scans for 64
- opening software 40
- Optical Character Recognition. *See* OCR
- optical resolution, definition 131
- Optimized Palette
  - definition 131
  - output types 44

- shortcut for 117
  - optional automatic document feeder. *See* ADF
  - optional transparency adapter. *See* XPA
  - options
    - ADF Page Size 38
    - Controls tab 73
    - destinations 37
    - Image Output 38
    - preferences, setting 70
    - Resolution 72
    - Scan To button 36
    - Scanner tab 71
    - Selection Area tab 72
    - text 73
  - original items
    - loading in ADF 78
    - loading on scanner glass 19
    - preparing 17
  - output dimensions
    - changing 45
    - definition 132
  - output levels, changing 54
  - output types
    - automatic selection 72
    - definition 132
    - menu shortcuts 117
    - optimal resolutions for 46
    - options 38
    - selecting 43
    - websites, optimizing for 64
- P**
- Page Size options, ADF 38
  - pages, multiple
    - options for 37, 71
    - scanning 28
  - palette flashing, definition 132
  - palettes
    - definition 132
    - optimized 131
    - output types 44
    - system 135
    - web 136
  - paper
    - loading in ADF 78
    - sizes, ADF 17
    - sizes, scanner glass 17
    - types of 17

- paper jams, ADF
    - clearing 108, 110
    - preventing 105
  - Paste command 65
  - pasting images 65
  - patterns, descreening 59
  - PDF files
    - printing documentation 15
    - uses for 62
  - percentages, scaling 45
  - photo albums, creating 30
  - Photo Reprint button
    - locating 26
    - using 30
  - photos
    - inverting colors 49
    - output types for 44
    - printing multiple 30
    - troubleshooting 95
  - Photoshop Plug-in. *See* HP Scanjet Plug-in
  - PICT files 62
  - picture clippings, Scrapbook 66
  - pink images, troubleshooting 98
  - pixel color
    - transparent items 85
    - viewing 55
  - pixel depth, options for 71
  - pixel, definition 132
  - pixels per inch (PPI), definition 133
  - plug-in, definition 132
  - PNG files 62
  - pointers. *See* cursors
  - pop-up menus, definition 132
  - portable network graphics 62
  - portrait orientation, definition 132
  - positioning plate, XPA
    - definition 133
    - slides 79
  - posting scans, definition 133
  - Power Save button
    - locating 27
    - using 34
  - power, troubleshooting 88
  - PPI (pixels per inch), definition 133
  - Precisionscan Pro. *See* HP Precisionscan Pro software
  - preferences
    - See also* settings
  - definition 133
  - for scanner buttons 35
  - for scanning software 70
  - shortcuts for 116
  - preparing originals 17
  - preview window, definition 133
  - previewing scans
    - options for 71
    - toolbar shortcut 119
    - using HP Precisionscan Pro software 41
  - Print command
    - shortcuts 116, 119
    - using 63
  - printing
    - copies 33
    - documentation 15
    - from HP Scanjet Copy Utility 16
    - resolutions for 133
    - scans 63
    - toolbar shortcuts for 119
    - troubleshooting 101
  - problems, solving. *See* troubleshooting
  - Product Tour command 118
  - product tour, viewing 15
  - programs
    - e-mail 31
    - resizing images in 45
    - scanning from 74
    - scanning to 29
    - sending to 60
    - troubleshooting 91
    - word processing 100
  - progress bar 120
  - progressive JPEG files 62
  - Prompt for Another Page option 37
  - Prompt for e-mail attachment name 37
- Q**
- quality, troubleshooting
    - copies 96
    - scanned images 93
  - Quit, shortcut for 116
- R**
- raster, definition 133
  - Reader, Adobe Acrobat 62
    - See also* PDF files
  - readouts, tonal resolution 73
  - Ready cursor 121
  - receipts, scanning 17
  - red color channel 58
  - red line, histogram 55
  - reflecting images 47
  - removing
    - frames 75
    - selection areas 42
  - reprints, photo 30
  - Reset Tools 117
  - resetting
    - all adjustments 48
    - default colors 58
    - exposure adjustments 50
    - output types 44
    - resolution 46
    - sharpen levels 48
  - Resize command
    - shortcuts 117
    - using 45
  - resizing
    - images 45
    - keyboard shortcuts for 117
    - selection areas 42
    - troubleshooting 23
  - resolution
    - automatic 23
    - button settings 38
    - changing 46
    - definition 133
    - interpolated 130
    - optical, definition 131
    - print vs. screen 23
    - printers 133
    - range of values 72
    - screen, definition 134
    - troubleshooting 95
    - websites, optimizing for 64
  - Resolution tab options 72
  - restoring defaults
    - See also* resetting
    - Reset Tools command 117
    - scanner buttons 35
  - Return Image To command
    - shortcuts 119
    - using 74
  - reversing images
    - color 49
  - layout 47
  - rewritable CDs, scanning to 67
  - RGB values
    - definition 134
    - transparent items 85
    - viewing 55
  - rich text format (RTF)
    - definition 134
    - using 62
  - Rotate Left command
    - shortcuts 117, 119
    - using 47
  - Rotate Right command
    - shortcuts 117, 119
    - using 47
  - rotating images
    - keyboard shortcuts for 117
    - toolbar shortcut 119
    - using HP Precisionscan Pro software 47
  - RTF (rich text format)
    - definition 134
    - using 62
- S**
- saturation
    - adjusting 56
    - automatic adjustment 72
    - definition 134
    - keyboard shortcuts 118
  - Save As command
    - shortcuts 116, 119
    - using 61
  - saving custom settings 69
  - saving to files
    - See also* file formats
    - toolbar shortcuts 119
    - using HP Precisionscan Pro software 61
  - Scale field 45
  - scale, definition 134
  - scaling images 45
  - Scan menu, shortcuts for 116
  - Scan To button
    - locating 26
    - settings for 36
    - Text File option 23
    - troubleshooting 91, 102
    - using 28, 29
  - Scan to CD 67

- Scan To command
    - shortcuts 116, 119
    - Text File option 23
    - using 60
  - Scan using channel 58
  - Scanjet Automatic Document Feeder. *See* ADF (automatic document feeder)
  - Scanjet Controls
    - See also* Buttons tab, HP Scanjet Controls
  - Scanjet Copy Utility 16
  - Scanjet on the Web 118
  - Scanjet Plug-in
    - definition 129
    - returning scans with 61
    - troubleshooting 103
    - using 74
  - scanner bed
    - definition 134
    - printing entire 63
    - selecting entire 42
  - scanner buttons
    - color copy/b&w copy 33
    - Copy 33
    - E-mail 32
    - identifying 26
    - models including 3
    - number of copies 33
    - settings 35
    - troubleshooting 91
    - when to use 16, 25
    - XPA, using with 104
  - scanner glass
    - cleaning 111
    - definition 134
    - loading items 19
    - preparing documents for 17
  - Scanner Glass command 116
  - scanner lamp. *See* lamp
  - scanner lid, definition 134
  - Scanner tab options 71
  - scanning
    - destinations, definition 28
    - loading items 19
    - methods for 16
    - negatives 81
    - preparing originals 17
    - previewing 41
    - selecting areas for 42
    - sending to programs 60
    - slides 79
    - using ADF 78
    - using HP Precisionscan Pro software 41
    - using scanner buttons 25
  - scanning source, definition 134
  - Scrapbook picture clippings 66
  - scratched templates 98
  - screen resolution
    - definition 134
    - image quality 23
    - output types for 44
  - Select All 42, 117
  - Select Destination button 26, 103
  - selecting
    - output types 43
    - scanning area 42
  - Selection Area tab options 72
  - selection areas
    - automatic 72
    - creating 42
    - cursors 121
    - definition 134
    - moving 42
    - removing border 42
    - resizing 42
    - zooming to 43
  - self-test errors 90
  - sending to programs
    - directions for 60
    - troubleshooting 102
  - settings
    - ADF Page Size 38
    - automatic 22
    - Controls tab 73
    - custom, saving 69
    - destinations 37
    - Energy Save mode 107
    - Faster Scan mode 107
    - Image Output 38
    - lamp 107
    - loading 69
    - resetting adjustments 48
    - Resolution tab 72
    - saving 69
    - Scan To button 36
    - scanner buttons 35
    - Scanner tab 71
    - scanning software 70
    - Selection Area tab 72
    - shortcut for 116
    - Text tab 73
  - Setup and Support guide 113
  - shadows
    - adjusting 52
    - alarms 53
    - automatic adjustment 72
    - clipped areas, checking for 53
    - definition 135
    - histogram 55
    - transparent items, adjusting for 84
  - Share-to-Web button
    - locating 26
    - using 30
  - Share-to-Web software option 64
  - Sharpen command
    - shortcuts 117
    - using 48
  - sharpening
    - definition 135
    - images 48
    - keyboard shortcuts for 117
    - options for 71
  - shield, light
    - negatives 81
    - slides 80
  - shortcuts
    - keyboard 116
    - menu 116
    - toolbar 119
  - size
    - See also* file sizes
    - ADF page size options 38
    - image, troubleshooting 94, 95
    - paper, ADF 17
    - resizing images 45
    - transparent media 18
  - skewed images, troubleshooting 94
  - skewed pages, troubleshooting 105
  - slide holder
    - definition 135
    - using 79
  - slide light shield
    - definition 135
    - using 80
  - slides
    - adjusting colors 83
    - scanning 79
    - troubleshooting 98
    - viewing 80
  - slow scanning, troubleshooting 22, 91
  - Smart Friends tips 40
  - software
    - See also* HP Precisionscan Pro software
    - uninstalling 113
  - solving problems. *See* troubleshooting
  - source documents. *See* original items
  - source, definition 135
  - specifications
    - ADF 17
  - speed
    - troubleshooting 22, 91
  - Speed Destinations
    - models including 8
    - using 36
  - spot color
    - definition 135
    - shortcut for 117
    - using output type 44
  - sRGB
    - definition 135
    - setting profile 71
  - starting scans
    - methods for 16
    - using HP Precisionscan Pro software 41
    - using scanner buttons 25
    - using TWAIN 74
  - stopping scans 33
  - streaks, troubleshooting 93
  - stripes, troubleshooting 96
  - support, customer
    - resources for 113
  - supported e-mail programs 31
  - System Palette
    - definition 135
    - shortcut for 117
- T**
- tab options
    - Control 73
    - Resolution 72
    - Scan To button 36
    - Scanner 71
    - Selection Area 72



- Text 73
  - Tagged Image File Format. *See* TIFF files
  - templates
    - negative 81
    - slides 79
    - troubleshooting 98
  - Text Files, saving as 75
  - Text option 37
  - Text tab options 73
  - text, editable
    - accuracy of 76
    - creating using OCR 15
    - languages 73
    - options for 73
    - Scan To Text File 23
    - troubleshooting 99
  - textured paper, scanning 17
  - threshold, black and white 57
  - thresholding, definition 135
  - TIFF files
    - definition 136
    - using 62
  - tips, Smart Friends 40
  - tonal resolution, adjusting 73
  - tone, definition 136
  - toolbar shortcuts 119
  - tools
    - black eyedropper 52
    - settings for 45
    - viewing functions of 14
    - white eyedropper 51
  - Tools menu, shortcuts for 117
  - transparency adapter (XPA)
    - cleaning 112
    - light source 80, 137
    - media sizes 18
    - models including 3
    - negatives, scanning 81
    - scanner buttons, using with 104
    - slides, scanning 79
    - troubleshooting 98, 104
    - using 79
  - trays. *See* input tray, ADF
  - troubleshooting
    - ADF 105
    - checklist 88
    - copies 96
    - e-mailing 101
    - frequently asked questions 22
    - image quality 93
    - negatives 98
    - OCR 99
    - scanner buttons 91
    - scanner not responding 91
    - slides 98
    - slow scanning 22, 91
    - transparencies 98
    - TWAIN programs 103
    - XPA 104
    - zooming 23
  - True Color
    - definition 136
    - option, selecting 38
    - shortcut for 117
    - using 44
  - turquoise line, histogram 55
  - TWAIN programs
    - definition 136
    - returning images to 61
    - scanning from 74
    - troubleshooting 103
  - 24-bit color, definition 123
  - 256 Color Palette 38
  - Type of file options 37
  - Typing cursor 121
- U**
- underlined text, converting 76
  - Undo Editing Changes command
    - shortcuts 119
    - using 48
  - uniform scaling, definition 136
  - uninstalling software 113
  - Universal Serial Bus. *See* USB
  - unlocking scanner 90, 91
  - Unselect All 42
    - command 42
    - shortcuts 117
  - Update Scanner 36
  - USB
    - definition 136
  - User's Manual, shortcut to 118
- V**
- vector images, definition 136
  - View menu, shortcuts for 117
  - viewing
    - previewing scans 41
    - product tour 15
    - RGB values 55
    - Setup and Support Guide 113
    - slides 80
  - using 79
  - XPA (Slides) command
    - shortcuts 116
    - using 80
- Z**
- Zoom In command
    - shortcuts 117, 119
    - using 43
  - Zoom Out command
    - shortcuts 117, 119
    - using 43
  - zooming
    - definition 23
    - in 43
    - menu shortcuts for 117
    - out 43
    - toolbar shortcuts for 119
    - viewing preview images 43
- X**
- XPA (Negatives) command
    - shortcuts 116
    - using 82
  - XPA (optional transparency adapter)
    - cleaning 112
    - light source 80, 137
    - media sizes 18
    - models including 3
    - negatives, scanning 81
    - scanner buttons, using with 104
    - slides, scanning 79
    - troubleshooting 98, 104



## Free Manuals Download Website

<http://myh66.com>

<http://usermanuals.us>

<http://www.somanuals.com>

<http://www.4manuals.cc>

<http://www.manual-lib.com>

<http://www.404manual.com>

<http://www.luxmanual.com>

<http://aubethermostatmanual.com>

Golf course search by state

<http://golfingnear.com>

Email search by domain

<http://emailbydomain.com>

Auto manuals search

<http://auto.somanuals.com>

TV manuals search

<http://tv.somanuals.com>