



 **WARNING**

The engine exhaust from this product contains chemicals known to the State of California to cause cancer, birth defects or other reproductive harm.

 **WARNING**

Before using our products, please read this manual carefully to understand the proper use of your unit.

APPLICABLE SERIAL NUMBERS: 81200101 and up

Operator's manual

226HD60S

226HD75S

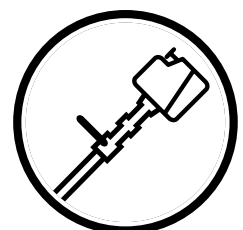

English

Contents

Symbols on the machine	4
Introduction	4
DEAR CUSTOMER!	4
Safety	5
SAFETY FIRST	5
WARNINGS IN THE MANUAL	5
Warning labels on the machine	5
SYMBOLS.....	5
What is what?	6
Technical data	7
For safe operation	8
NOTE THE FOLLOWING BEFORE STARTING;	8
IMPORTANT	8
WORKING CONDITION	8
WORKING CIRCUMSTANCE	8
WORKING PLAN	9
BEFORE STARTING THE ENGINE	9
STARTING THE ENGINE	9
USING THE PRODUCT	9
IF SOMEONE COMES	10
MAINTENANCE	10
HANDLING FUEL	10
TRANSPORTATION	10
Fuel	11
RECOMMENDED MIXING RATIO	11
HOW TO MIX FUEL	11
FUELING THE UNIT	11
Operation	12
STARTING ENGINE	12
STOPPING ENGINE	12
RUNNING IN THE ENGINE	12
ADJUSTING IDLING SPEED	13
HOW TO USE THE HANDLE	13
HEDGE TRIMMING TECHNIQUES	13
Maintenance	14
AIR FILTER	14
FUEL FILTER	14
SPARK PLUG	14
INTAKE AIR COOLING VENT	15
BLADES	15
SHARPENING	15
SAFETY LOCK	16
REDUCTION GEARBOX	16
ANTI-VIBRATION SYSTEM	16
PROCEDURES TO BE PERFORMED AFTER EVERY 100 HOURS OF USE	16
MUFFLER	16
SPARK ARRESTER	16
Storage	17
Disposal	17
Troubleshooting guide	17
Federal and California emissions control warranty statement	18
YOUR WARRANTY RIGHTS AND OBLIGATIONS	18
MANUFACTURER'S WARRANTY COVERAGE	18
OWNER'S WARRANTY RESPONSIBILITIES	18
WARRANTY COMMENCEMENT DATE	18
LENGTH OF COVERAGE	18
WHAT IS COVERED	18
EMISSION WARRANTY PARTS LIST	19
WHAT IS NOT COVERED	19
HOW TO FILE A CLAIM	19
WHERE TO GET WARRANTY SERVICE	19
MAINTENANCE, REPLACEMENT AND REPAIR OF EMISSION-RELATED PARTS	19
MAINTENANCE STATEMENT	19

Symbols on the machine

For safe operation and maintenance, symbols are carved in relief on the machine. According to these indications, please be careful not to take a mistake.

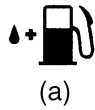

(a) The port to refuel the "MIX GASOLINE"
Position:
 FUEL TANK CAP



(b) The direction to close the choke
Position:
 AIR CLEANER COVER



(c) The direction to open the choke
Position:
 AIR CLEANER COVER

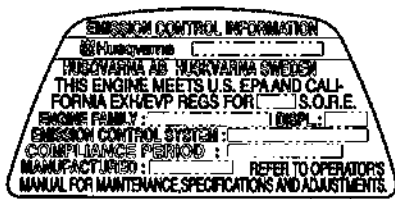

This engine label certifies that the product is certified in accordance with American exhaust emissions requirements EPA Ph II and Californian exhaust and evaporative emissions requirements CARB Tier III. The Emissions Compliance Period referred to on the emissions compliance label indicates the number of operating hours for which the engine has shown to meet Federal and Californian emission requirements.

For customer assistance, contact us at our website: www.usa.husqvarna.com

Introduction

DEAR CUSTOMER!

Congratulations on your choice to buy a Husqvarna product! Husqvarna is based on a tradition that dates back to 1689, when the Swedish King Karl XI ordered the construction of a factory on the banks of the Huskvarna River, for production of muskets. The location was logical, since water power was harnessed from the Huskvarna River to create the water-powered plant. During over 300 years of continuous operation, the Husqvarna factory has produced a lot of different products, from wood stoves to modern kitchen appliances, sewing machines, bicycles, motorcycles etc. In 1956, the first motor driven lawn mowers appeared, followed by chain saws in 1959, and it is within this area Husqvarna is working today.

Today Husqvarna is one of the leading manufacturers in the world of forest and garden products, with quality as our highest priority. We develop, manufacture and market high quality motor driven products for forestry and gardening as well as for building and construction industry.

Your purchase gives you access to professional help with repairs and service whenever this may be necessary. If the retailer who sells your machine is not one of our authorized dealers, ask for the address of your nearest servicing dealer.

It is our wish that you will be satisfied with your product and that it will be your companion for a long time. Think of this operator's manual as a valuable document. By following its' content (using, service, maintenance etc) the life span and the second-hand value of the machine can be extended. If you ever lend or sell this machine, make sure that the borrower or buyer gets the operator's manual, so they will also know how to properly maintain and use it.

Thank you for using a Husqvarna product.

Husqvarna AB has a policy of continuous product development and therefore reserves the right to modify the design and appearance of products without prior notice.

For customer assistance, contact us at our website: www.usa.husqvarna.com

Safety



SAFETY FIRST

Instructions contained in warnings within this manual and warning seals marked with a  symbol on the blower concern critical points which must be taken into consideration to prevent possible serious bodily injury, and for this reason you are requested to read all such instructions carefully and follow them without fail.

WARNINGS IN THE MANUAL

WARNING

Instructions labeled as shown above, concern critical steps or procedures which must be followed in order to prevent accidents which could lead to serious bodily injury or death. This mark is used to indicate instructions which must be followed without exception.

IMPORTANT

Instructions labeled as shown above concern steps or procedures which, if not followed correctly, could lead to mechanical failure, breakdown, or damage.

NOTE

Used to label supplementary instructions designed to provide hints or directions useful in the use of the product.

Warning labels on the machine

SYMBOLS

WARNING! Incorrect or careless use of a hedge trimmer can turn it into a dangerous tool that can cause serious or even fatal injury. It is extremely important that you read and understand the contents of this operator's manual.



Please read the operator's manual carefully and make sure you understand the instructions before using the machine.

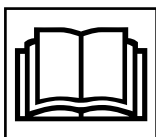

Always wear:

- Approved hearing protection
- Approved eye protection



Always wear approved protective gloves.



Wear sturdy, non-slip boots or shoes.



Other symbols/decals on the machine refer to special certification requirements for certain markets.

IMPORTANT

If warning label peel off or become soiled and impossible to read, you should contact the dealer from which you purchased the product to order new labels and affix them in the required location(s).

Never modify your machine.

WARNING

We won't warrant the machine, if you use the remodeled hedge-trimmer or you don't observe the proper usage written in the manual.

What is what?

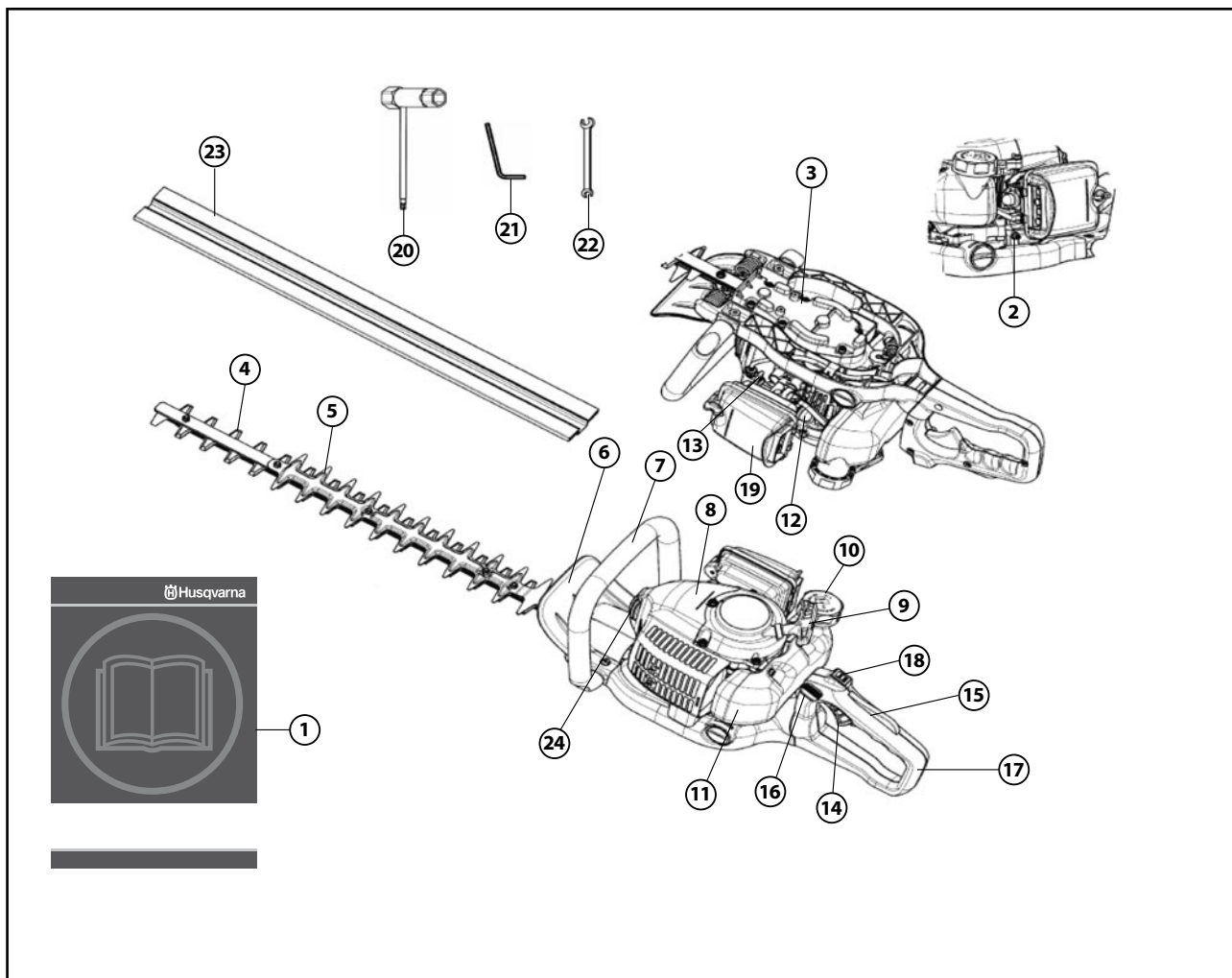

WHAT IS WHAT?

- | | |
|---------------------------------|----------------------|
| 1 Operator's manual | 13 Choke lever |
| 2 Grease nipple | 14 Throttle lever |
| 3 Gear case | 15 Safety lock lever |
| 4 Blades | 16 Locking lever |
| 5 Blade guard | 17 Rear handle |
| 6 Hand guard | 18 Stop switch |
| 7 Front handle | 19 Air filter cover |
| 8 Engine cover (cylinder cover) | 20 Socket |
| 9 Starter handle | 21 Allen key |
| 10 Fuel cap | 22 Spanner |
| 11 Fuel tank | 23 Transport guard |
| 12 Primer pump | 24 Spark plug cap |

Technical data

TECHNICAL DATA

	226HD60S	226HD75S
Engine		
Engine Type	Air-cooled 2-stroke gasoline	Air-cooled 2-stroke gasoline
Cylinder displacement, cu.in/cm ³	1.44/23.6	1.44/23.6
Cylinder bore, inch/mm	1.34/34	1.34/34
Stroke, inch/mm	1.02/26	1.02/26
Idle speed, rpm	3000±200	3000±200
Max. output Hp (kw)/ rpm	1.15 (0.85)/8000	1.15 (0.85)/8000
Ignition system		
Spark plug	NGK CMR7H	NGK CMR7H
Electrode gap, inch/mm	0.025/0.6-0.7	0.025/0.6-0.7
Fuel and lubrication system		
Fuel	Mixture (Gasoline 50 : Oil 1)	Mixture (Gasoline 50 : Oil 1)
Fuel tank capacity, fl.oz/liter	15.9/0.47	15.9/0.47
Manufacturer/type of carburetor	Walbro Diaphragm type	Walbro Diaphragm type
Trimmer		
Type	Double-sided blades	Double-sided blades
Length, inch/mm	23.6/600	29.5/750
Pitch, inch/mm	1.38/35	1.38/35
Transmission	Centrifugal clutch. Cam-crank	Centrifugal clutch. Cam-crank
Reduction ratio	5.11	5.11
Weight		
Weight without fuel and grease, Lbs/kg	12.9/5.8	13.3/6.0
Noise emission		
Sound power level, guaranteed LWA dB(A)	102	102
Noise level		
Sound pressure level at the operator's ear, measured according to EN ISO 22868, dB(A)	94,2	94,2
Vibration level		
Vibration levels at handles, measured according to EN 774		
Top speed front/rear handle, m/s ²	1.8/1.5	2.5/2.1

NOTE: Specifications are subject to change without notice.

For safe operation

NOTE THE FOLLOWING BEFORE STARTING;

! IMPORTANT

1. THIS MACHINE CAN CAUSE SERIOUS INJURIES. Read this manual carefully until you completely understand and follow all safety and operating instructions. Also, know how to stop the machine quickly in an emergency.
2. Keep this manual handy so that you may refer to it later whenever any questions arise. Also note, if you have any questions which cannot be answered herein, contact the dealer from whom you purchased the product.
3. Always be sure to include this manual when selling, lending, or otherwise transferring the ownership of this product.
4. Never allow children or anyone unable to fully understand the directions given in the manual to use the machine.

! WARNING

- Long-term exposure to noise can result in permanent hearing impairment. So always use approved hearing protection.

IMPORTANT

! IMPORTANT

- The machine is only designed for cutting branches and twigs.
- Never use a machine that has been modified in any way from its original specification.
- Never use the machine if you are tired, if you have drunk alcohol, or if you are taking medication that could affect your vision, your judgement or your co-ordination.
- Wear personal protective equipment. See instructions under the heading Personal protective equipment.
- Never use the machine in extreme weather conditions such as severe cold, very hot and/or humid climates.
- Never use a machine that is faulty. Carry out the checks, maintenance and service instructions described in this manual. Some maintenance and service measures must be carried out by trained and qualified specialists. See instructions under the heading Maintenance.
- All covers and guards must be fitted before starting. Ensure that the spark plug cap and ignition lead are undamaged to avoid the risk of electric shock.

! WARNING

- The ignition system of this machine produces an electromagnetic field during operation. This field may under some circumstances interfere with pacemakers. To reduce the risk of serious or fatal injury, we recommend persons with pacemakers to consult their physician and the pacemaker manufacturer before operating this machine.
- Faulty blades can increase the risk of accidents.

WORKING CONDITION

1. When using the product, you should wear proper clothing and protective equipment.
 - (1) Ear protectors
 - (2) Protection goggles or face protector
 - (3) Thick work gloves
 - (4) Non-slip-sole work boots



(1) (2)



(2)

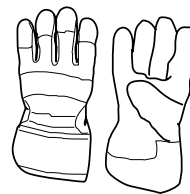

(3)

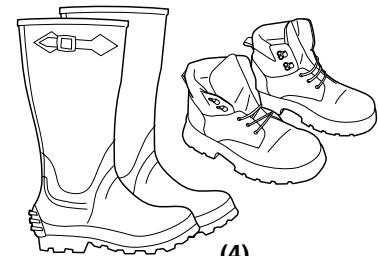

(4)

2. And you should carry with you.
 - (1) Attached tools
 - (2) Properly reserved fuel
 - (3) Spare blade
 - (4) Things to notify your working area (rope, warning signs)
 - (5) Whistle (for collaboration or emergency)
 - (6) Hatchet or saw (for removal of obstacles)
 - (7) First aid kit
3. Do not wear loose clothing, jewelry, short trousers, sandals, or go barefoot. Do not wear anything which might be caught by a moving part of the unit. Secure hair so it is above shoulder length.

WORKING CIRCUMSTANCE

1. Never start the engine inside a closed room or building. Exhaust gases contain dangerous carbon monoxide.
2. Never use the product,
 - a. when the ground is slippery or when you can't

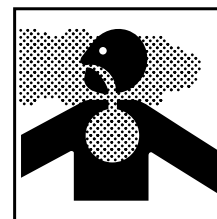

maintain a steady posture.

- b. At night, at times of heavy fog, or at any other times when your field of vision might be limited and it would be difficult to gain a clear view of the working area.
- c. During rain, during storms at times of strong or gale-force winds, or at any other times when weather conditions might make it unsafe to use the product.

For safe operation

WORKING PLAN

1. You should never use the product when under the influence of alcohol, when suffering from exhaustion or lack of sleep, when suffering from drowsiness as a result of having taken cold medicine or at any other time when a possibility exists that your judgment might be impaired or that you might not be able to operate the product properly and in a safe manner.
2. When planning your work schedule, allow plenty of time to rest. Limit the amount of time over which the product is to be used continuously to somewhere around 30 ~ 40 minutes per session, and take 10 ~ 20 minutes of rest between work sessions. Also try to keep the total amount of work performed in a single day under 2 hours or less.

⚠ WARNING

1. **If you don't observe the working time, or working manner (See "USING THE PRODUCT"), Repetitive Stress Injury (RSI) could occur.**
If you feel discomfort, redness and swelling of your fingers or any other part of your body, see a doctor before getting worse.
2. **To avoid noise complaints, in general, operate product between 8 a.m. and 5 p.m. on weekdays and 9 a.m. to 5 p.m. on weekends.**

📖 NOTE

Check and follow the local regulations as to sound level and hours of operations for the product.

BEFORE STARTING THE ENGINE

1. The area within a perimeter of 15 m (50 ft) of the person using the product should be considered a hazardous area into which no one should enter. If necessary, yellow warning rope, warning signs should be placed around the perimeter of the area. When work is to be performed simultaneously by two or more persons, care should also be taken to constantly look around or otherwise check for the presence and locations of other people working so as to maintain a distance between each person sufficient to ensure safety.
2. Check the condition of working area to avoid any accident by hitting hidden obstacles such as stumps, stones, cans, or broken glass.

⚠ IMPORTANT

Remove any obstacle before beginning work.

3. Inspect the entire unit for loose fasteners leakage. Make sure that the cutting attachment properly installed and securely fastened.

STARTING THE ENGINE

1. Keep bystanders especially children, and animals at least 15 m (50 ft) away from the operating point. If you are approached, immediately stop the engine.
2. The product is equipped with a centrifugal clutch mechanism, so the cutting attachment begins to move as soon as the engine is started by putting the throttle into the start position. When starting the engine, place the product onto the ground in a flat clear area and hold it firmly in place so as to ensure that neither the cutting part nor the throttle come into contact with any obstacle when the engine starts.

⚠ WARNING

Never place the throttle into the high-speed position when starting the engine.

Never start the engine at the cutting attachment side.

3. After starting the engine, check to make sure that the cutting attachment stops moving when the throttle is moved fully back to its original position. If it continues to move even after the throttle has been moved fully back, turn off the engine and take the unit to your authorized Husqvarna servicing dealer for repair.

USING THE PRODUCT

ⓘ IMPORTANT

Cut only materials recommended by the manufacturer. And use only for tasks explained in the manual.

1. Grip the handles firmly with both hands using your whole hand. Place your feet slightly apart (slightly further apart than the width of your shoulders) so that your weight is distributed evenly across both legs, and always be sure to maintain a steady, even posture while working.
2. Maintain the speed of the engine at the level required to perform cutting work, and never raise the speed of the engine above the level necessary.
3. If the unit starts to shake or vibrate, turn off the engine and check the whole unit. Do not use it until the trouble has been properly corrected.
4. Keep all parts of your body away from moving cutting attachment and hot surfaces.
5. Never touch the muffler, spark plug, or other metallic parts of the engine while the engine is in operation or immediately after shutting down the engine. Doing so could result in serious burns or electrical shock.

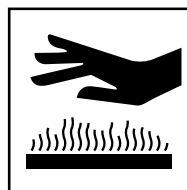

6. While operating the machine be always sure of a safe and secure operating position especially when using steps or a ladder.

For safe operation

IF SOMEONE COMES

1. Guard against hazardous situations at all times. Warn adults to keep pets and children away from the area. Be careful if you are approached. Injury may result from flying debris.
2. If someone calls out or otherwise interrupts you while working, always be sure to turn off the engine before turning around.

MAINTENANCE

1. In order to maintain your product in proper working order, perform the maintenance and checking operations described in the manual at regular intervals.
2. Always be sure to turn off the engine before performing any maintenance, checking procedures or working on the machine.

⚠ WARNING

The metallic parts reach high temperatures immediately after stopping the engine.

3. When replacing the cutting attachment or any other part, or when replacing the oil or any lubricant, always be sure to use only Husqvarna products or products which have been certified by Husqvarna for use with the Husqvarna product.
4. In the event that any part must be replaced or any maintenance or repair work not described in this manual must be performed, please contact a representative from the store nearest Husqvarna authorized servicing dealer for assistance.
5. Do not use any accessory or attachment other than those bearing the Husqvarna mark and recommended for the unit.
6. Under no circumstances should you ever take apart the product or alter it in any way. Doing so might result in the product becoming damaged during operation or the product becoming unable to operate properly.

HANDLING FUEL

1. The engine of the Husqvarna product is designed to run on a mixed fuel, which contains highly flammable gasoline. Never store cans of fuel or refill the tank of the unit in any place where there is a boiler, stove, wood fire, electrical sparks, welding sparks, or any other source of heat or fire which might ignite the fuel.



2. Never smoke while operating the unit or refilling its fuel tank.
3. When refilling the tank, always turn off the engine and allow it to cool down. Take a careful look around to make sure that there are no sparks or open flames anywhere nearby before refueling.
4. Wipe spilled fuel completely using a dry rag if any fuel spillage occurs during refueling.
5. After refueling, screw the fuel cap back tightly onto the fuel tank and then carry the unit to a spot 3 m or more away from where it was refueled before turning on the engine.
6. Do not inhale fuel fumes as they are toxic.

TRANSPORTATION

1. When hand-carrying the product, cover over the cutting part if necessary, lift up the product and carry it paying attention to the blade.
2. Never transport the product over rough roads over long distances by vehicle without removing all fuel from the fuel tank. If doing so, fuel might leak from the tank during transport.

Fuel

⚠ WARNING

- Gasoline is very flammable. Avoid smoking or bringing any flame or sparks near fuel. Make sure to stop the engine and allow it cool before refueling the unit. Select outdoor bare ground for fueling and move at least 3m (10ft) away from the fueling point before starting the engine.
- The Husqvarna engines are lubricated by oil specially



formulated for air-cooled 2-cycle gasoline engine use. If Husqvarna oil is not available, use an antioxidant added quality oil expressly labeled for aircooled 2-cycle engine use. (JASO FC GRADE OIL or ISO EGC GRADE)

- Do not use BIA or TCW (2-stroke water-cooling type) mixed oil.

RECOMMENDED MIXING RATIO

GASOLINE 50:OIL 1

50:1 MIXING CHART

GASOLINE gal.	1	2	3	4	5
2-CYCLE OIL fl.oz	2.6	5.2	7.8	10.4	13
GASOLINE liter	1	2	3	4	5
2-CYCLE OIL ml	20	40	60	80	100

- Exhaust emission are controlled by the fundamental

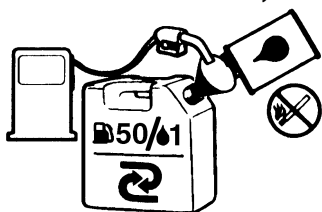

engine parameters and components (eq., carburation, ignition timing and port timing) without addition of any major hardware or the introduction of an inert material during combustion.

- These engines are certified to operate on unleaded gasoline.
- Make sure to use gasoline with a minimum octane number of 89 RON (USA/Canada: 87AL)
- If you use a gasoline of a lower octane value than prescribed, there is a danger that the engine temperature may rise and an engine problem such as piston seizing may consequently occur.
- Unleaded gasoline is recommended to reduce the contamination of the air for the sake of your health and the environment.
- Poor quality gasolines or oils may damage sealing rings, fuel lines or fuel tank of the engine.

HOW TO MIX FUEL

ⓘ IMPORTANT

Pay attention to agitation.

- Measure out the quantities of gasoline and oil to be mixed.
- Put some of the gasoline into a clean, approved fuel container.
- Pour in all of the oil and agitate well.
- Pour In the rest of gasoline and agitate again for at least one minute. As some oils may be difficult to agitate depending on oil ingredients, sufficient agitation is necessary for the engine to last long. Be careful that, if the agitation is insufficient, there is an increased danger of early piston seizing due to abnormal lean mixture.
- Put a clear indication on the outside of the container to avoid mixing up with other containers.
- Indicate the contents on outside of container for easy identification.

FUELING THE UNIT

- Untwist and remove the fuel cap. Keep the cap and inlet of the tank clean.
- Put fuel into the fuel tank to 80% of the full capacity.
- Fasten the fuel cap securely and wipe up any fuel spillage around the unit.

⚠ WARNING

- Select bare ground for fueling.
- Move at least 10feet (3meters) away from the fueling point before starting the engine.
- Stop the engine before refueling the unit. At that time, be sure to sufficiently agitate the mixed gasoline in the container.

FOR YOUR ENGINE LIFE, AVOID;

- FUEL WITH NO OIL (RAW GASOLINE) – It will cause severe damage to the internal engine parts very quickly.
- GASOHOL – It can cause deterioration of rubber and/or plastic parts and disruption of engine lubrication.
- OIL FOR 4-CYCLE ENGINE USE – It can cause spark plug fouling, exhaust port blocking, or piston ring sticking.
- Mixed fuels which have been left unused for a period of one month or more may clog the carburetor and result in the engine failing to operate properly.
- In the case of storing the product for a long period of time, clean the fuel tank after rendering it empty. Next, activate the engine and empty the carburetor of the composite fuel.
- In the case of scrapping the used mixed oil container, scrap it only at an authorized repository site.

📖 NOTE

As for details of quality assurance, read the description in the section Limited Warranty carefully. Moreover, normal wear and change in product with no functional influence are not covered by the warranty. Also, be careful that, if the usage in the instruction manual is not observed as to the mixed gasoline, etc. described therein, it may not be covered by the warranty.

Operation

STARTING ENGINE

1. Feed fuel into the fuel tank and tighten the cap securely.
2. Rest the unit on a flat, firm place. Keep the cutting head off the ground and clear of surrounding objects as it will start moving upon starting of the engine.
3. Push the primer pump several times until overflow fuel flows out in the clear tube.

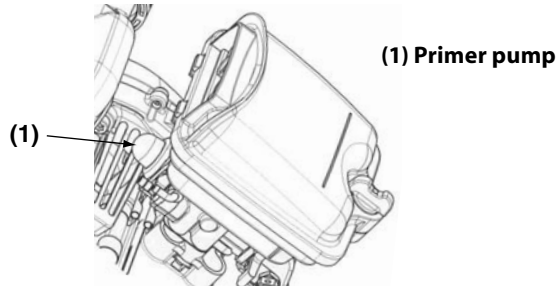

4. When the engine is cool, move the choke lever to the closed position.

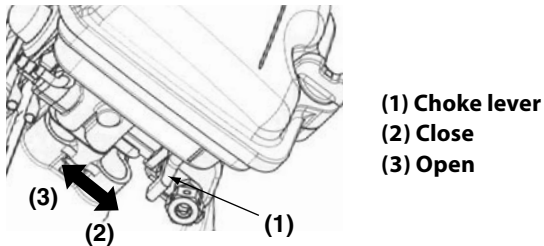

5. Set the ignition switch to the "RUN" position. Release the throttle lever and make sure it is fully back.
6. While holding the unit firmly, pull out the starter rope

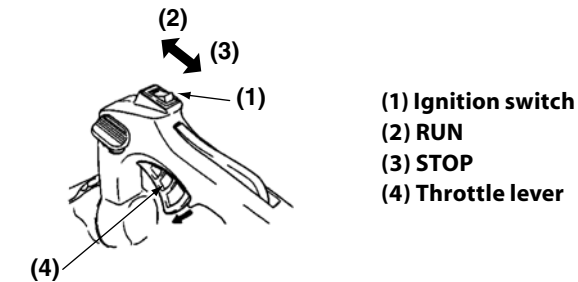

quickly until engine fires.

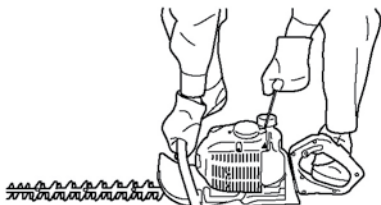

IMPORTANT

- Avoid pulling the rope to its end or returning it by releasing the knob. Such actions can cause starter failures.
7. Move the choke lever to the open position. And pull out the starter rope quickly to restart engine.
 8. Allow the engine to warm up for a couple of minutes before starting operation.

NOTE

1. When restarting the engine immediately after stopping it, leave the choke open.
2. Overchoking can make the engine hard to start due to excess fuel. When the engine failed to start after several attempts, open the choke and repeat pulling the rope, or remove the spark plug and dry it.

STOPPING ENGINE

1. Release the throttle lever and run the engine for a half minute.

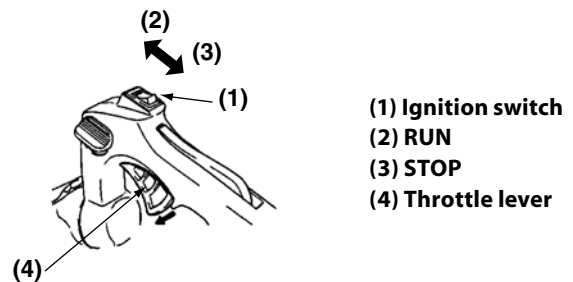

IMPORTANT

2. Shift the ignition switch to the "STOP" position.

NOTE

Except for an emergency, avoid stopping the engine while pulling the throttle lever.

If the engine won't stop when setting the ignition switch to the stop position, close the choke lever and stop the engine.

In this case, please repair the machine at your nearest servicing dealer.

RUNNING IN THE ENGINE

During the first 20 working hours, do not use the hedge-trimmer at maximum power for long periods.

Operation

ADJUSTING IDLING SPEED

- Before adjusting the carburetor, clean the air filter and warm up the engine.

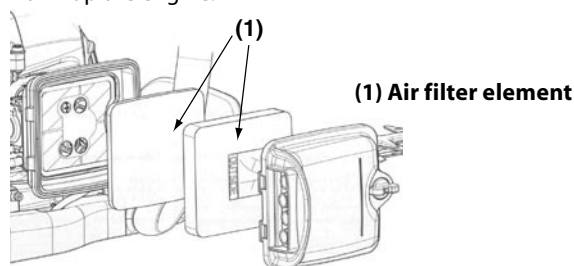

- Idle screw is adjusted in order to ensure a good safety margin between idle running and clutch engagement.



⚠ WARNING

With the engine idling (3000 rpm), the blade should not move. We recommend that you have the dealer or an authorised mechanic carry out any carburetor adjustments.

- Weather conditions and altitude may effect carburation.

⚠ WARNING

- Do not allow anyone to stay close to the hedgetrimmer while working or while adjusting the carburetor.

HOW TO USE THE HANDLE

- To reduce fatigue when trimming hedges, the handle can be swivelled through 90° to the left or right.

⚠ WARNING

Do not press the throttle during this operation !

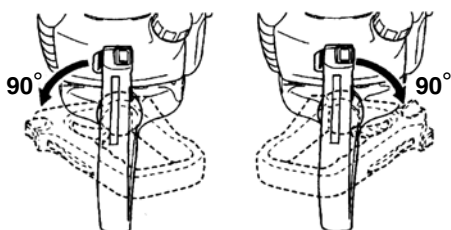

Proceed as follows:

1. Free the handle by pressing the locking lever;
2. Turn the handle until the locking lever clicks into place;
3. When the handle is locked in its new position, you can apply the throttle again.

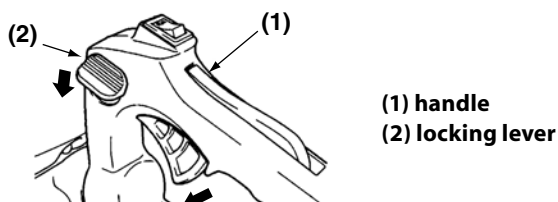

You can swivel the handle even with the engine idling because the hedge-trimmer is equipped with a blade brake that maintains the blades at a standstill.

HEDGE TRIMMING TECHNIQUES

Trim sides of a hedge first, and then the top.

Vertical cut:

- With the double-sided blade hedge-trimmer, model 226HD60S/226HD75S use an arcing cut from the bottom upwards, then downwards to use both sides of the blades.



Horizontal cut:

- In order to get the best cutting results, slightly tilt the blade (5° ÷ 10°) towards the cutting direction.
- Cut slowly, specially with thick hedges.

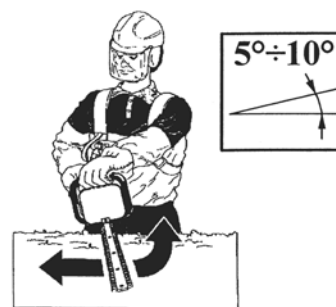

⚠ WARNING

Always follow the safety precautions.

The hedge-trimmer must only be used to trim hedges or small bushes. It is forbidden to cut other types of material. Do not use the hedge-trimmer as a lever to lift, move or break objects, nor lock it on fixed supports. It is forbidden to apply tools or applications that are not the ones indicated by the manufacturer onto the hedge-trimmer's power take-off. Do not use it for pruning trees or cutting grass.

- Use only as much throttle as is needed to do the job. Excessive engine speed is unnecessary.
- Avoid cutting thick branches, for which will damage the blades and shorten the life of drive systems.
- Always keep your body to the carburetor side of your trimmer, never on the muffler side.
- When a new machine is first operated, in the first few minutes grease may come out of the gear case. But, since this is excess grease, there is no cause for alarm. Just wipe it off with the engine stopped for next use.
- Always remember that the TIP of the line does cutting. You will achieve better results by not crowding the line into the cutting area. Allow the unit to trim at its own pace.

Maintenance

Maintenance, replacement, or repair of the emission control device and systems may be performed by any non-road engine repair establishment or individual.

■ MAINTENANCE CHART

	System/components	Procedure	Before use	Every 25 hours after	Every 50 hours after	Every 100 hours after	Note
ENGINE	fuel leaks, fuel spillage	wipe out	✓				
	fuel tank, air filter, fuel filter	inspect/clean	✓	✓			replace, if necessary
	idle adjusting screw	see adjusting idling speed	✓				replace carburetor if necessary
	spark plug	clean and readjust plug gap			✓		GAP : 0.6 ~ 0.7 mm replace, if necessary
	cylinder fins, intake air cooling vent	clean		✓			
	muffler, spark arrester, cylinder exhaust port	clean			✓		
TRIMMER	throttle lever, ignition switch	check operation	✓				
	cutting parts	replace if something's wrong	✓				
	gear case	grease			✓		
	screws/nuts/bolts	tighten/replace	✓			✓	not adjusting screws
	debris guard	make sure to attach	✓				

⚠ WARNING

Make sure that the engine has stopped and is cool before performing any service to the machine. Contact with moving cutting head or hot muffler may result in a personal injury.

AIR FILTER

- The air filter, if clogged, will reduce the engine performance. Check and clean the filter element in warm, soapy water as required. Dry completely before installing. If the element is broken or shrunk, replace with a new one.

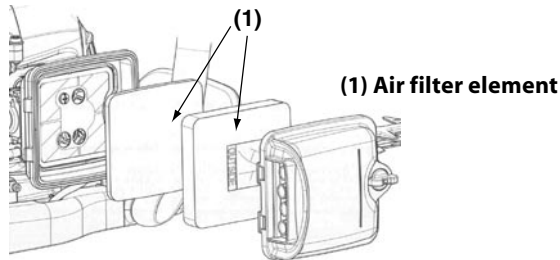

⚠ IMPORTANT

- How to attach two air filter elements
 1. Attach thin element previously
 2. Attach thick element so that stamp side is outside

FUEL FILTER

- When the engine runs short of fuel supply, check the fuel cap and the fuel filter for blockage.

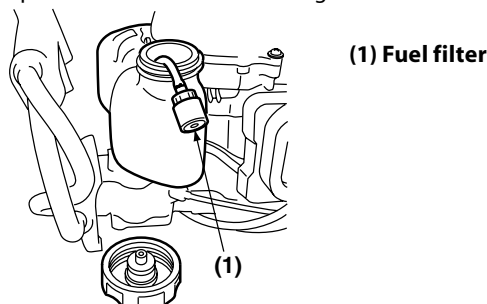

SPARK PLUG

- Starting failure and mis-firing are often caused by a fouled spark plug. Clean the spark plug and check that the plug gap is in the correct range. For a replacement plug, use the correct type specified by Husqvarna.

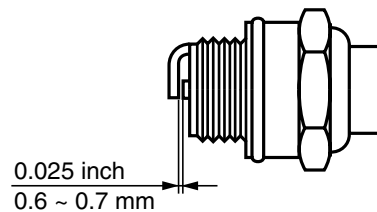

- REPLACEMENT PLUG IS NGK CMR7H OR CHAMPION RZ7C.

⚠ IMPORTANT

- Note that using any spark plug other than those designated may result in the engine failing to operate properly or in the engine becoming overheated and damaged.
- To install the spark plug, first turn the plug until it is finger tight, then tighten it a quarter turn more with a socket wrench.

TIGHTENING TORQUE: 87~121 in-lbs
(9.8~13.7 N.m)

Maintenance

INTAKE AIR COOLING VENT

⚠ WARNING

- Never touch the cylinder, muffler, or spark plugs with your bare hands immediately after stopping the engine. The engine can become very hot when in operation, and doing so could result in severe burns.
- Clean the cylinder fins with compressed air or a brush.

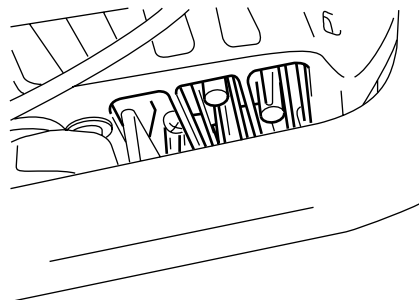

ⓘ IMPORTANT

If waste gets stuck and causes blockage around the intake air cooling vent or between the cylinder fins, it may cause the engine to overheat, and that in turn may cause mechanical failure on the part of the hedge-trimmer.

BLADES

Clean any resin and plant residue from the blades using cleaning agent 531 00 75-13 (UL22) before and after using

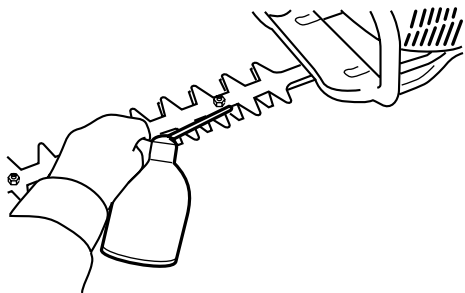

⚠ WARNING

the machine.

- Make sure that the blade bolts are well tightened.
- The blade assembly is designed to automatically compensate for any play between the blades.

Check the cutting edges and reform with a flat file.

Point :

1. Keep the end corner sharp.
2. Round the root of the edge.
3. Do not use water when using a grinder.

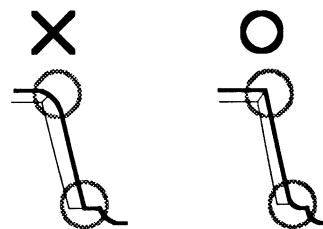

ⓘ IMPORTANT

- When mounting the blade, make sure to fasten the spacer, washer and bolt, then fasten the nut.

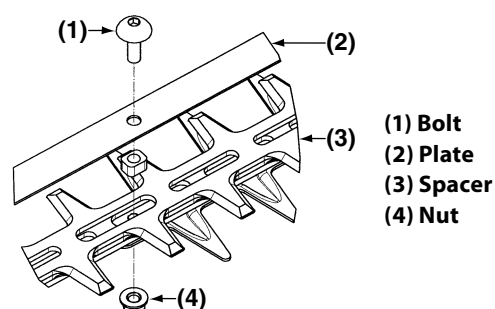

SHARPENING

Always keep the file or sharpener at an angle of 45° to the

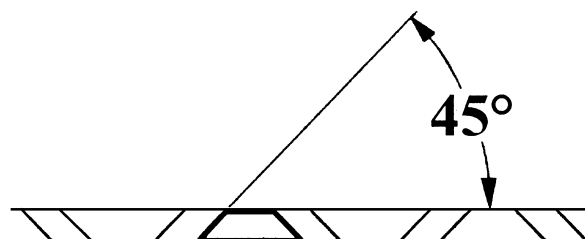

blade, and:

- Always grind in the direction of the cutting edge;
- Note: files cut only in one direction; lift the file from the blade when returning to start a new pass;
- Remove all burr from the edge of the blade with a slip stone;
- Remove as little material as possible;
- Before refitting the sharpened blades, remove filings and then apply grease.

Do not try to sharpen a damaged blade: change it or take it to a Service dealer.

Maintenance

SAFETY LOCK

- Stop operation when the safety lock is defective.
- Safety lock is the device not to accelerate the throttle lever without intention. While pushing the safety lock, you can accelerate the throttle lever.

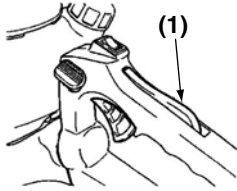

(1) Safety lever

1. Check if the throttle lever does not move when you do not push the safety lock.
 2. Check if the throttle lever moves when you grasp or release it while pushing the safety lock.
 3. Check if the safety lock returns to its original position when you release your hand from safety lock.
- If you find any defects at the checks above, contact your nearest servicing dealer for repair.

REDUCTION GEARBOX

Refill gear housing every 50 working hours.

Use grease pump. Feed grease until it comes out of the base of blades.

- Grease nipple : A type

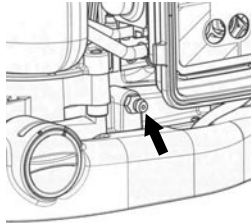

ANTI-VIBRATION SYSTEM

The deformed or damaged anti-vibration system may cause of the breakages like getting rickety or falling off of engine and/or blade

- Check periodically if the rubber cushions are not deformed or damaged.

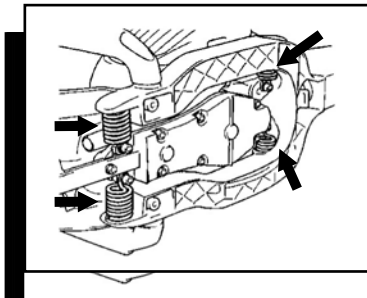

PROCEDURES TO BE PERFORMED AFTER EVERY 100 HOURS OF USE

1. Tighten all screws, bolts, and fittings.
2. Check to see if any oil or grease has worked its way in between the clutch lining and drum, and if it has wipe it away using oil-free, lead-free gasoline.
3. Remove the muffler, insert a screwdriver into the vent, and wipe away any carbon buildup. Wipe away any carbon buildup on the muffler exhaust vent and cylinder exhaust port at the same time.

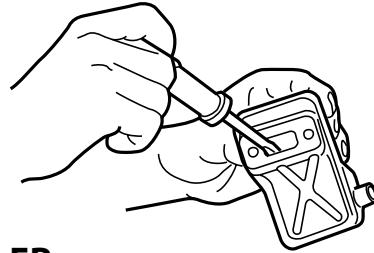

MUFFLER

⚠ WARNING

- Inspect periodically, the muffler for loose fasteners, any damage or corrosion. If any sign of exhaust leakage is found, stop using the machine and have it repaired immediately.
- Note that failing to do so may result in the engine catching on fire.

❗ IMPORTANT

- Before starting operation, always make sure to check if the muffler is properly held by three bolts. (Fastening Torque : 8 to 12 N·m)
- Also make sure that the speak arrester and the diffuser are properly attached with four bolts. (Fastening Torque : 2 to 3 N·m)
- Even if one of seven bolts is loose, it may result in engine catching on fire.

SPARK ARRESTER

- The muffler is equipped with a spark arrester to prevent red hot carbon from flying out of the exhaust outlet. Periodically inspect and clean as necessary with a wire brush. In the State of California it is required by law (Section 4442 of the California Pulic Resources Code) to equip a spark arrester when a gas powered tool is used in any forest covered, bush covered, or grass covered unimproved land.

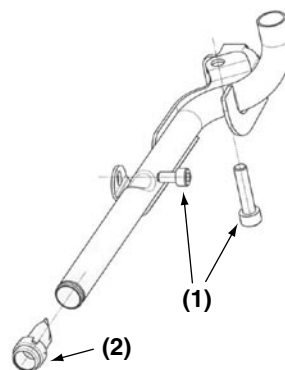

(1) Bolt
(2) Spark arrester

Storage

1. Lubricate the blade bars to prevent rust with special grease, part no. 531 00 75-12 (UL21), before long periods of storage.
2. Empty the fuel tank and put the cap back on.
3. Remove the spark plug, pour a small amount of oil into the cylinder.
4. Rotate the crankshaft several times using the starting rope in order to distribute the oil. Put the spark plug back in.
5. Wrap the engine with a plastic sheet.
6. Store the trimmer indoors in a dry place, dust free place, out of the reach of children, preferably not in direct contact with the floor and away from heat sources.

Disposal

When disposing your machine, fuel or oil for the machine, be sure to allow your local regulations.

Troubleshooting guide

Case 1. Starting failure

CHECK	PROBABLE CAUSES	ACTION
fuel tank	→ incorrect fuel	→ drain it and with correct fuel
fuel filter	→ fuel filter is clogged	→ clean
carburetor adjustment screw	→ out of normal range	→ adjust to normal range
sparkign (no spark)	→ spark plug is fouled/wet	→ clean/dry
	→ plug gap is incorrect	→ correct (GAP: 0.6 – 0.7 mm)
spark plug	→ disconnected	→ retighten

Case 2. Engine starts but does not keep running/Hard re-starting.

CHECK	PROBABLE CAUSES	ACTION
fuel tank	→ incorrect fuel or staled fuel	→ drain it and with correct fuel
carburetor adjustment screw	→ out of normal range	→ adjust to normal range
muffler,cylinder (exhaust port)	→ carbon is built-up	→ wipe away
air cleaner	→ clogged with dust	→ wash
cylinder fin, fan cover	→ clogged with dust	→ clean

When your unit seems to need further service, please consult with our service shop in your area.

Federal and California emissions control warranty statement

YOUR WARRANTY RIGHTS AND OBLIGATIONS

The EPA (U.S. Environmental Protection Agency), CARB (California Air Resources Board), Environment Canada and Husqvarna Forest & Garden are pleased to explain the emissions control system's warranty on your 2007 and later small off-road engine. In U.S. and Canada, new equipment that use small off-road engines must be designed, built, and equipped to meet the applicable Federal or Californian stringent anti-smog standards. Husqvarna Forest & Garden must warrant the emissions control system on your small off-road engine for the period listed below provided there has been no abuse, neglect or improper maintenance of your equipment. Your emissions control system may include parts such as the carburetor, ignition system, catalytic converter, fuel tank, filters and other associated components. Also, included may be hoses, belts, connectors, sensors, and other emission-related assemblies. Where a warrantable condition exists, Husqvarna Forest & Garden will repair your small off-road engine at no cost to you including diagnosis, parts and labor.

MANUFACTURER'S WARRANTY COVERAGE

The emissions control system is warranted for two years. If any emissions-related part on your equipment is defective, the part will be repaired or replaced by Husqvarna Forest & Garden.

OWNER'S WARRANTY RESPONSIBILITIES

- As the small off-road engine owner, you are responsible for performance of the required maintenance listed in your operator's manual. Husqvarna Forest & Garden recommends that you retain all receipts covering maintenance on your small off-road engine, but Husqvarna Forest & Garden cannot deny warranty solely for the lack of receipts or your failure to ensure the performance of all scheduled maintenance.
- As the small off-road engine owner, you should however be aware that the Husqvarna Forest & Garden may deny you warranty coverage if your small off-road engine or a part has failed due to abuse, neglect, or improper maintenance or unapproved modifications.
- You are responsible for presenting your small off-road engine to a Husqvarna Forest & Garden distribution center or service center as soon as the problem exists. The warranty repairs should be completed in a reasonable amount of time, not to exceed 30 days. If you have any questions regarding your warranty coverage, you should contact Husqvarna Forest & Garden at 1-800-487-5963.

WARRANTY COMMENCEMENT DATE

The warranty period begins on the date the engine or equipment is delivered to an ultimate purchaser.

LENGTH OF COVERAGE

Husqvarna Forest & Garden warrants to the ultimate purchaser and each subsequent owner that the engine or equipment is designed, built, and equipped so as to conform with all applicable regulations adopted by EPA and CARB, and is free from defects in materials and workmanship that causes the failure of a warranted part for a period of two years.

WHAT IS COVERED

REPAIR OR REPLACEMENT OF PARTS Repair or replacement of any warranted part under the warranty must be performed at no charge to the owner at a warranty station. Warranty services or repairs will be provided at all Husqvarna Forest & Garden distribution centers that are franchised to service the subject engines. Throughout the emissions warranty period of two years, Husqvarna Forest & Garden must maintain a supply of warranted parts sufficient to meet the expected demand for such parts.

WARRANTY PERIOD Any warranted part that is scheduled for replacement as required in the maintenance schedule, is warranted for the period of time prior to the first scheduled replacement point for that part. If the part fails prior to the first scheduled replacement, the part will be repaired or replaced by Husqvarna Forest & Garden at no cost. Any such part repaired or replaced under warranty is warranted for the remainder of the period prior to the first scheduled replacement point for the part. Any warranted part that is not scheduled for replacement as required in the maintenance schedule, is warranted for two years. If any such part fails during the period of warranty coverage, it will be repaired and replaced by Husqvarna Forest & Garden at no cost. Any such part repaired or replaced under the warranty is warranted for the remaining warranty period. Any warranted part that is scheduled only for regular inspection in the maintenance schedule will be warranted for a period of two years. A statement in such written instructions to the effect of "repair or replace as necessary" will not reduce the period of warranty coverage. Any such part repaired or replaced under warranty will be warranted for the remaining warranty period.

DIAGNOSIS The owner must not be charged for diagnostic labor that leads to the determination that a warranted part is in fact defective, provided that such diagnostic work is performed at a warranty station.

CONSEQUENTIAL DAMAGES Husqvarna Forest & Garden is liable for damages to other engine components proximately caused by a failure under warranty of any warranted part.

Federal and California emissions control warranty statement

EMISSION WARRANTY PARTS LIST

- 1 Carburetor and internal parts
- 2 Intake pipe, airfilter holder and carburetor bolts.
- 3 Airfilter and fuelfilter covered up to maintenance schedule.
- 4 Spark Plug, covered up to maintenance schedule
- 5 Ignition Module
- 6 Muffler with catalytic converter
- 7 Fuel tank

WHAT IS NOT COVERED

All failures caused by abuse, neglect or improper maintenance are not covered.

ADD -ON OR MODIFIED PARTS

Add-on or modified parts that are not exempted by CARB or EPA may not be used. The use of any non-exempted add-on or modified parts will be grounds for disallowing a warranty claim. Husqvarna Forest & Garden will not be liable to warrant failures of warranted parts caused by the use of a non-exempted add-on or modified part.

HOW TO FILE A CLAIM

If you have any questions regarding your warranty rights and responsibilities, you should contact your nearest authorized servicing dealer or call Husqvarna Forest & Garden at 1-800-487-5963.

WHERE TO GET WARRANTY SERVICE

Warranty services or repairs are provided through all Husqvarna Forest & Garden authorized servicing dealers.

MAINTENANCE, REPLACEMENT AND REPAIR OF EMISSION-RELATED PARTS

Any replacement part may be used in the performance of any warranty maintenance or repairs and must be provided without charge to the owner. Such use will not reduce the warranty obligations of the manufacturer.

MAINTENANCE STATEMENT

The owner is responsible for the performance of all required maintenance, as defined in the operator's manual.

Free Manuals Download Website

<http://myh66.com>

<http://usermanuals.us>

<http://www.somanuals.com>

<http://www.4manuals.cc>

<http://www.manual-lib.com>

<http://www.404manual.com>

<http://www.luxmanual.com>

<http://aubethermostatmanual.com>

Golf course search by state

<http://golfingnear.com>

Email search by domain

<http://emailbydomain.com>

Auto manuals search

<http://auto.somanuals.com>

TV manuals search

<http://tv.somanuals.com>