



CONTEMPORARY
ANTIQUE
TUSCAN
MODERN

Instant Hot Water Dispenser Owner's Manual

Installation, Care & Use

Instalación, cuidado y uso

Installation, soin et utilisation

HWT-F1000S
HWT-HP
HWT-00



To see a tutorial of this installation:

Para ver un tutorial de esta instalación ingrese a

Pour voir un tutoriel de cette installation

<http://goo.gl/yYrFOA>



The Emerson logo is a trademark and a service mark of Emerson Electric Co. InSinkErator may make improvements and/or changes in the specifications at any time, in its sole discretion, without notice or obligation and further reserves the right to change or discontinue models.

©2014 InSinkErator, a business unit of Emerson Electric Co. All Rights Reserved.

El logotipo Emerson es una marca registrada y una marca de servicio de Emerson Electric Co.

InSinkErator puede realizar mejoras y/o modificaciones en las especificaciones en cualquier momento, y bajo su exclusivo criterio, sin previo aviso u obligación; además, se reserva el derecho de cambiar o suspender los modelos.

©2014 InSinkErator, una unidad comercial de Emerson Electric Co. Todos los derechos reservados.

Le logo Emerson est une marque de commerce et de service d'Emerson Electric Co.

InSinkErator se réserve le droit, à son entière discrétion, d'apporter en tout temps des améliorations ou des modifications aux spécifications, et ce, sans préavis ou obligation de sa part, ou de modifier ou de supprimer des modèles.

©2014 InSinkErator, une unité commerciale d'Emerson Electric Co. Tous droits réservés.

GN/HC1100
GN/HC2200
GN/HC2215
H/HC3300



1.800.558.5700
www.insinkerator.com





We are delighted that you have chosen the InSinkErator® Instant Hot Water Dispenser to be a part of your home. This unique appliance will save you time and effort in the kitchen, and you'll enjoy discovering new uses for it each day. That's exactly why millions of people are now using an InSinkErator Instant Hot Water Dispenser.

We are confident that by following our step-by-step instructions, you'll soon be enjoying the convenience of instant hot water.

WHAT YOU SHOULD KNOW BEFORE YOU BEGIN

- For your satisfaction and safety, read all instructions, cautions and warnings before installing or using this instant hot water dispenser.
- This particular unit is not intended for commercial use.
- Make sure that all electrical wiring and connections conform to local codes.
- A standard 115-volt grounded electrical outlet is required under the sink for the dispenser's electrical power.
- The wall outlet powering your dispenser must have power supplied to it continuously.
- This outlet must be fused and should not be controlled by the same wall switch that operates the disposer, unless you have a SinkTop Switch™ from InSinkErator®.
- It is recommended that a dedicated control valve be installed on the cold water line supplying water to this system.
- If you suspect elevated levels of chlorine in your water, or your water has a rusty appearance before the installation of this unit, it is recommended to use our water filtration system.
This product contains stainless steel. The manufacturer cannot guarantee against rusty water because of the number of factors that are involved beyond the manufacturer's control. However, the sudden appearance of rusty water discharged from the hot water dispenser may indicate the need for service or replacement of this product.
- The use of a water filter should NOT result in the water pressure to drop below 30 psi (207kPa). If it does, this will prevent your unit from operating properly.
- Moving parts inside the tank causing a rattling noise is normal.

WHAT YOU NEED TO GET STARTED

Equipment Required:

- Drill
- T-fitting
- Dedicated control valve
- Adjustable wrench
- Philips Screw Driver
- Pencil
- Tape Measure

Equipment You May Need:

- Anchors for drywall
- Hole saw
- Basin wrench
- Hole punch

If you intend to use the sprayer hole in your sink for your dispenser, you may need a basin wrench and a 1/8" plug or a 1/4" cap (**not supplied**) for the faucet sprayer hose line. **See Step 1B.**

If you need to cut a mounting hole in your stainless steel sink, you may need a 1 1/4" - 1 1/2" hole saw made for cutting stainless steel or a hole punch. Consult a professional if you are drilling into a surface other than stainless steel.

Identify the model of your instant hot water dispenser and record it here: _____

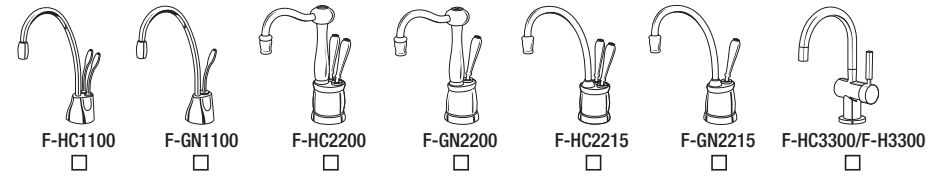

HOW TO USE THIS INSTRUCTION MANUAL

These instructions are separated into main sections, indicated by numbers, and subsections, indicated by capital letters. The manual is setup this way to allow you to take a break at any point after completing a section or subsection without affecting the installation process.

What you'll see in the instruction manual:

INSTALLING THE FAUCET

A

NOTICE

Property Damage: Do not pinch or break copper tubing. Do not distort the last 1 inch of tubing.

- Unpack dispenser components.
- On a firm, flat surface, carefully straighten the copper tubing.

- 1** Provides a step-by-step narrative describing the installation step, with check boxes that can be marked as you progress through the installation.
- 2** Contains simple illustrations that provide visual instruction to support the narrative.
- 3** Important safety messages that will require your attention during the step.

▲ WARNING A potentially hazardous situation, which, if not avoided, could result in death or serious injury.

▲ CAUTION A potentially hazardous situation, which, if not avoided, may result in minor or moderate injury.

NOTICE Notice is used to address practices not related to personal injury.

OVERVIEW OF A COMPLETED SETUP

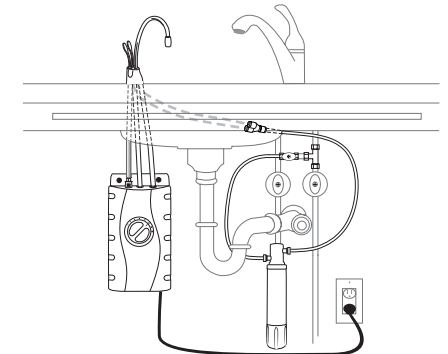

To see a tutorial of this installation:
<http://goo.gl/yYrfOA>

NOTICE Do not plug in the power to the hot water tank until Step 6C. To avoid permanent damage to the product, only operate the tank after it is filled with water.

COMPONENTS IN THIS PACKAGE

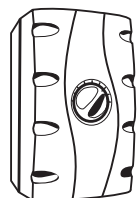
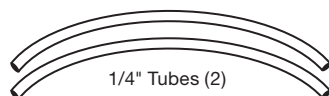
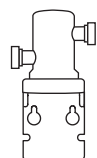
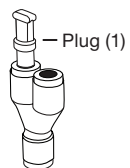
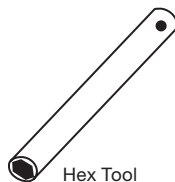
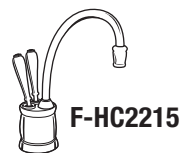
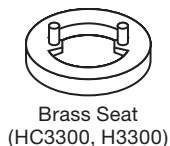

HWT-F1000S
HWT-HP*
HWT-00*

*(filtration system optional)

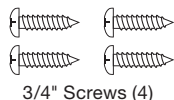
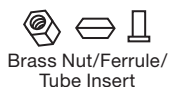

If installing **BOTH** new faucet and new tank, skip to page 6.

IF INSTALLING ONLY NEW FAUCET

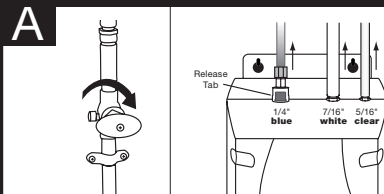

- Turn off water supply.
- Remove tubes from tank: At tank top, depress gray release tab into quick-connect fitting securing **blue** or **copper** 1/4" tube and gently pull line out of fitting. Pull **white** 7/16" tube and **clear** 5/16" tube off fittings.
- Remove existing faucet and continue to page 6.

NOTICE

Property Damage: Unplug tank before disconnecting tubing.

IF INSTALLING ONLY NEW TANK

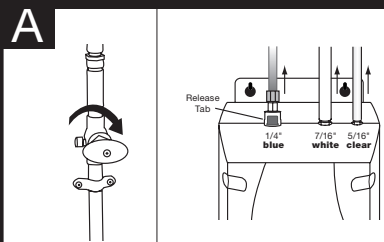

- Turn off water supply.
- Remove tubes from tank: At tank top, depress gray release tab into quick-connect fitting securing **blue** tube and gently pull line out of fitting. Pull **white** 7/16" tube and **clear** 5/16" tube off fittings.
- Remove existing tank and continue to page 9.

NOTICE

Property Damage: Do not pinch or break copper tubing. Do not distort the last 1 inch of tubing.

NOTICE

Do not plug in the power to the hot water tank until Step 6C. To avoid permanent damage to the product, only operate the tank after it is filled with water.



Snap-connect fitting not included. Required when replacing tank manufactured prior to January 2006. Call the AnswerLine® 1-800-558-5700 to order.

To see a tutorial of this installation:

<http://goo.gl/yYrFOA>



AnswerLine®
1-800-558-5700

START HERE

1

PREPARATION

A	Required minimum from center of hole to wall F-HC1100 2 $\frac{5}{8}$ " F-GN1100 3 $\frac{1}{4}$ " F-HC2200 2 $\frac{1}{8}$ " F-GN2200 3 $\frac{1}{2}$ " F-HC2215 2 $\frac{1}{8}$ " F-GN2215 3 $\frac{1}{2}$ " F-HC3300 2 $\frac{1}{2}$ " F-H3300 2 $\frac{1}{2}$ "	<input type="checkbox"/> Identify locations for the dispenser faucet, tank and filter. <input type="checkbox"/> Check to make sure there is proper clearance for dispenser handles to be fully opened. <input type="checkbox"/> Check to make sure counter is 3" thick or less. <input type="checkbox"/> Make sure there is a grounded electrical outlet under the sink.
	Maximum counter thickness is 3".	

The wall outlet for your dispenser must have power supplied to it continuously and must be fused. It should not be controlled by the same wall switch that operates your disposer, unless using an InSinkErator SinkTop Switch™.

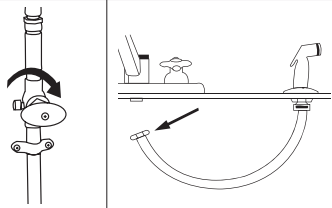
B 	<input type="checkbox"/> Turn off water supply. <input type="checkbox"/> If using the sink sprayer hose hole, remove nut that connects sprayer hose at bottom of faucet. <input type="checkbox"/> Using adjustable wrench, remove nut connecting sprayer washer flange in sprayer hole. <input type="checkbox"/> Plug hose opening with either a 1/8" plug or a 1/4" cap (not supplied).
	<p>If you have to drill through sink or countertop, you may need to rent or purchase the appropriate tools.</p>

C	Required Hole Size F-HC1100 1 $\frac{3}{8}$ " - 1 $\frac{1}{2}$ " F-GN1100 1 $\frac{1}{4}$ " - 1 $\frac{1}{2}$ " F-HC2200 1 $\frac{3}{8}$ " - 1 $\frac{1}{2}$ " F-GN2200 1 $\frac{1}{4}$ " - 1 $\frac{1}{2}$ " F-HC2215 1 $\frac{3}{8}$ " - 1 $\frac{1}{2}$ " F-GN2215 1 $\frac{1}{4}$ " - 1 $\frac{1}{2}$ " F-HC3300 1 $\frac{3}{8}$ " - 1 $\frac{1}{2}$ " F-H3300 1 $\frac{3}{8}$ " - 1 $\frac{1}{2}$ "	What if you don't have a sprayer hole or don't want to use it? <input type="checkbox"/> Many homeowners replace the soap dispenser in their sink with an instant hot water dispenser. <input type="checkbox"/> If drilling a hole into a stainless steel sink or counter top, you can cut a mounting hole for the dispenser with a hole saw for stainless steel, or you can use a hole punch.
	<p>Consult a professional before drilling into a surface other than stainless steel.</p>	



To see a tutorial of this installation:
<http://goo.gl/yYrfOA>

2

INSTALLING THE FAUCET - 1100/2200/2215

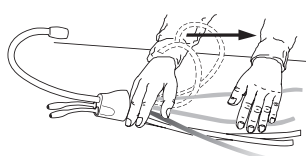
A 	<input type="checkbox"/> Unpack dispenser components. <input type="checkbox"/> On a firm, flat surface, carefully straighten the copper tubing.
	<p>NOTICE</p> <p>Property Damage: Do not pinch or break copper tubing. Do not distort the last 1 inch of tubing.</p>

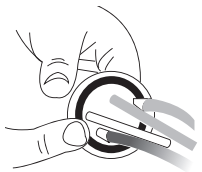
B 	<input type="checkbox"/> Ensure that the black O-ring is properly seated in the base of the dispenser head (the groove on the underside of the dispenser).
	<p>Make sure to use rubber O-ring to ensure proper seal.</p>

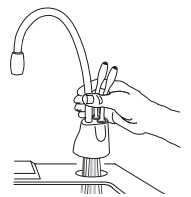
C 	<input type="checkbox"/> Feed tubes down through the hole in the sink or countertop until the base is at rest on the sink or countertop surface.
	<p>To ease feeding of tubes through hole, first insert blue tube with quick-connect attachment and then insert the remaining tubes.</p> <p>An assistant may be needed to hold the dispenser head in place while securing the dispenser.</p>

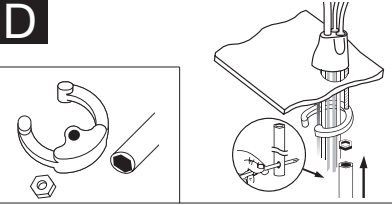
D 	<input type="checkbox"/> From under the sink, place the semi-circular mounting plate onto the threaded stud. <input type="checkbox"/> Place hex nut onto the threaded stud. Ensure faucet head is at desired angle. <input type="checkbox"/> Insert screwdriver into hole on side of hex tool (creating a "T"), and use tool to tighten nut and secure faucet.
	<p>Semi-circular mounting plate should encircle all descending tubes and extend beyond sink hole when tight.</p>

2

INSTALLING THE FAUCET - 3300

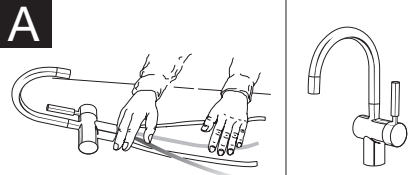

NOTICE

Property Damage: Do not pinch or break tubing. Do not distort the last 1 inch of tubing.

- Unpack dispenser components.
 - The recommended installation for this faucet is dispenser handle on the right.
- The unique design allows the handle to be fully functional when placed to the right or left of faucet. Determine preferred handle placement before installing.

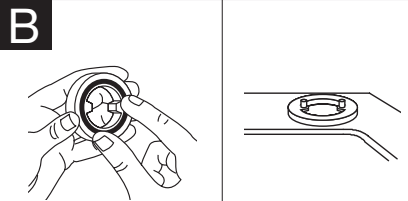

Wetting O-ring with water prior to inserting into brass seat helps hold ring in place during installation.

- Insert rubber O-ring into groove on brass seat.
- Place brass seat, O-ring side down, over hole in sink or countertop.

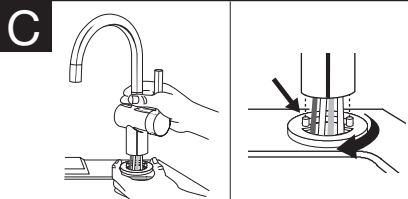

To ease feeding of tubes through hole, first insert blue tube with quick-connect attachment and then insert the remaining tubes.

- Holding brass seat in place, feed tubes down through the hole in sink or countertop until base touches brass seat.
- Rotate brass seat until the two retaining studs fit into the holes on the faucet base and base sits firmly on brass seat.

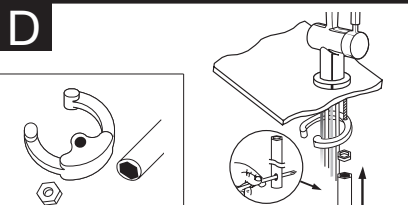

Semi-circular mounting plate should encircle all descending tubes and extend beyond sink hole when tight.

- From under the sink, place the semi-circular mounting plate onto the threaded stud.
- Place hex nut onto the threaded stud. Ensure dispenser handle is on preferred side and that faucet head is at desired angle.
- Insert screwdriver into hole on side of hex tool (creating a "T"), and use tool to tighten nut and secure faucet.

CAUTION Do not plug in the hot water tank Until Step 6C.

3

MOUNTING THE TANK

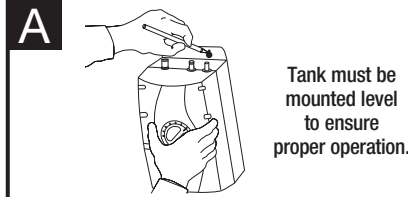

NOTICE

Property Damage: Tank must be located within 16" of faucet and within 30" or less of a standard grounded outlet. DO NOT extend plumbing or electrical lines.

- Select a spot under the sink to mount tank vertically within reach of both plumbing and electrical connections. The tank should be within 16" or less of faucet water lines and within 30" or less of a standard grounded outlet.
- While holding tank in place on the spot selected for installation, use a pencil to mark locations for 2 hanging screws.

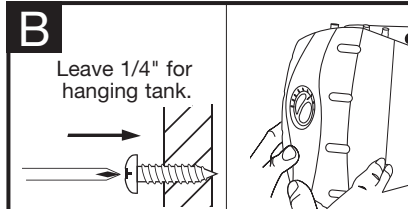

Mount tank vertically in an area that allows clearance on the underside of the tank for drainage, if necessary. DO NOT over tighten screws.

Screws provided are for use in wood studs or cabinets only. Use wall anchors (not supplied) for installation into drywall.

- Pre-drill 1/8" pilot holes at marks.
- Turn screws into pre-drilled holes, leaving 1/4" exposed.
- Hang the tank on the screws.
- Tighten the screws with only 1/2 turn clockwise.

4

CONNECTING FAUCET TO TANK

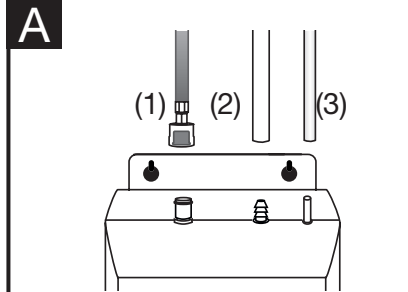

NOTICE

Property Damage: Pinched or blocked water lines may cause damage to the dispenser tank. Check to make sure tubes are connected properly and are pushed down as far as possible.

- Without depressing the gray button, place the snap-connect fitting at the end of the **blue** tube onto the left fitting on the tank, pushing until it clicks into place. (1)
- Slip the flexible **white** 7/16" tube over barbed steel fitting and slide down approximately 1/2". (2)
- Slip the **clear** 5/16" tube over the smooth plastic fitting and slide down approximately 1/2". (3)
- Check for pinched or crimped tubes.

Hose clamps are not needed for any of the connections.



To see a tutorial of this installation:
<http://goo.gl/yYrFOA>

AnswerLine®
1-800-558-5700

5 INSTALLING FILTRATION SYSTEM

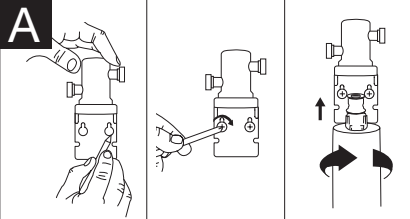

WARNING

Personal Injury: Do not locate filter above an outlet or other electrical device. Install head and bracket so that connections require no stretching, kinking or pinching of tubing.

Screws provided are for use in wood studs or cabinets only. Use wall anchors (not supplied) for installation into drywall.

- Separate cartridge from filter head.
- Mark hole locations for filter head and bracket in a spot that allows for filter replacement.
- Drill 1/8" starter holes and attach bracket to wall with wood screws, turning until snug.
- Insert cartridge into filter head. Top surface of cartridge will become flush with bottom of filter head when fully engaged.

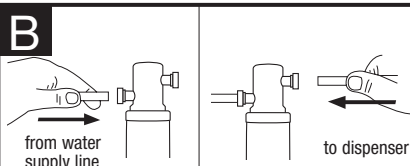

NOTICE

Property Damage: Tube runs need to form to the cabinet's contours to allow storage space with no sharp bends. Tubes need clean, perpendicular, burr-free cuts to ensure a true fit.

- Determine length of tubing required, then cut to length making sure the cut is perpendicular and burr-free.
- Insert a **white** 1/4" tube into inlet side of filter head until it stops. **Press in again to ensure a secure fit.**
- Insert the other **white** 1/4" tube into outlet side of filter head until it stops. **Press in again to ensure a secure fit.**

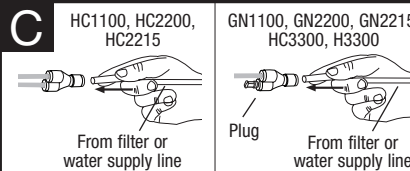

NOTICE

Property Damage: Do not extend the lines farther than the 16" provided. Ensure tube(s) and "Y" connector are securely fit.

- Insert the copper tube(s) from the dispenser into "Y" quick-connector using the plug for hot-only models.
- Connect the **white** 1/4" tube from the right outlet on the filter head into the quick-connect fitting until it stops. **Press in again to ensure a secure fit.**

To remove tube(s) or plug from quick-connector, depress the release ring and gently pull away.

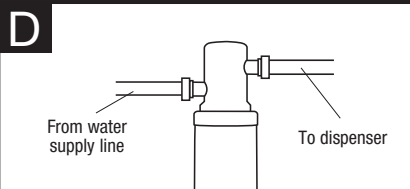

It is normal for approximately 2 oz. of water to discharge when filter is removed.

- Connect remaining **white** 1/4" tube to incoming water supply line. (See Step 6.)

6 FINAL WATER CONNECTION

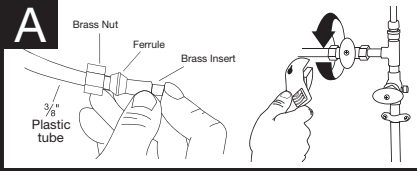

NOTICE

Property Damage: Join remaining tube to cold water supply only.

- Install a T-fitting (*not included*) onto the cold water supply line.
- Install dedicated water control valve with 1/4" compression fitting.
- At the end of the **white** 1/4" tube from the filter or quick-connector, slide the supplied brass nut and ferrule over the tube and then push in the brass tube insert.
- Insert the **white** 1/4" tube into the 1/4" compression fitting and tighten.

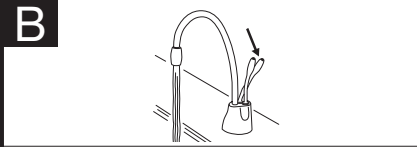

WARNING

Scalding Hazard: The faucet dispenses near-boiling (212°F) water which can instantly cause scalds or burns. Use care when operating this appliance.

- Turn on water supply.
- Open hot water faucet to expel trapped air.
- For the F-1000S and F-1000, flush 2.25 gallons through filter before use (approximately 3 minutes). For the F-2000S and F-2000, flush 3 gallons through filter before use (approximately 4 minutes).

Dispensing Hot Water (HC3300, H3300) Dispensing Cool Water (HC3300)

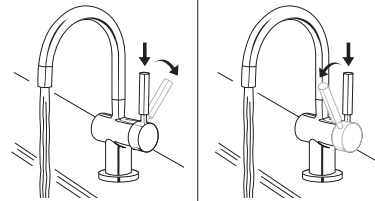

WARNING

Scalding Hazard: The faucet dispenses near-boiling (212°F) water which can instantly cause scalds or burns. Use care when operating this appliance.

Operating Instructions for Indulge™ Modern Faucets

Featuring OptiPush™ hot side activation with automatic shut off and cool side Stay-On™, which keeps the faucet open when dispensing cool water.

- HC3300:** To dispense instant hot water, first **press down** on the faucet handle and then push the handle backward in the direction of the red indicator on the top of the handle. To dispense cool water, first **press down** on the faucet handle and then pull the handle forward in the direction of the blue indicator on the handle.
- Note:** Only applies when handle is mounted on left side.

Featuring OptiPush™ hot side activation with automatic shut off.

- H3300:** To dispense instant hot water, first **press down** on the faucet handle and then push the handle backward in the direction of the red indicator on the top of the handle.

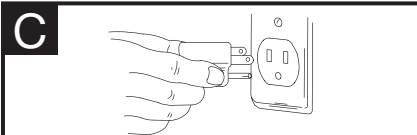

NOTICE

Property Damage: A standard grounded outlet within 30" of the dispenser is required under the sink. Do not use an extension cord set with the dispenser.

- Check all connections to ensure they are tight and that there are no leaks.
- Plug in instant hot water tank.

Water will be cold at first.

Allow 12-15 minutes for water to reach target temperature.

Gurgling or hissing is normal during the initial heating cycle.

If the water coming from the faucet is not hot 15 minutes after the unit has been plugged in – or for other issues related to the operation of your instant hot water dispenser – refer to the "Troubleshooting" section on Page 17.



To see a tutorial of this installation:
<http://goo.gl/yYrFOA>

IMPORTANT SAFETY INFORMATION

- Use this water heater only for its intended use as described in this manual.
- This appliance is not intended for use by persons (including children) with reduced physical, sensory or mental capabilities, or lack of experience and knowledge, unless they have been given supervision or instruction concerning use of appliance by a person responsible for their safety. Children should be supervised to ensure that they do not play with hot water tap. To reduce the risk of injury, close supervision is required when an appliance is used near children.
- Do not operate this product if it has been or appears to be damaged in any manner or after the product malfunctions, or is dropped. Return the complete product immediately to your retail dealer for inspection, and if necessary, adjustment or repair.

⚠ WARNING	To reduce the risk associated with choking: Do not allow children under 3 years of age to have access to small parts during the installation of this product.
------------------	---

⚠ WARNING	Electric Shock Hazard: To reduce the risk of electric shock, do not immerse or expose the product, flexible cord or plug to rain, moisture or any liquid or when standing in or on damp or wet surfaces. If any electrical product falls into water, UNPLUG it immediately. DO NOT REACH INTO THE WATER. Important: Prior to reconnecting to the power supply, the product should be inspected by a qualified technician.
------------------	---

⚠ WARNING	Personal Injury/Property Damage: To reduce the risk associated with hazardous voltage due to an installer drilling through existing electric wiring in the area of installation: Do not install near electric wiring which may be in path of a drilling tool when selecting the position to mount the system bracket. Also avoid the risk of drilling into water pipes which may result in property damage.
------------------	---

Important: Always arrange the power cord so that it cannot come in contact with hot surfaces.

- Do not disconnect the product from the power supply by pulling on the cord.
- Do not use the product for other than its intended use as described in these instructions. The use of accessory attachments other than those recommended by the manufacturer may cause safety hazards.
- The recommended connection may be made to an existing cold water line with a branch terminating with a shutoff valve, a pressure relief and dual check non-return valve sited adjacent to the product.

⚠ WARNING	Electric Shock Hazard: Using an ungrounded (no earth ground) or improperly connected appliance can result in serious injury or death from electrical shock.
------------------	--

This appliance must be earthed (grounded). This steaming hot water tap is equipped with a cord that has a grounding conductor and earth ground pin. The plug must be connected to an appropriate outlet that is properly installed and earthed (grounded) in accordance with all local codes and ordinances. Do not modify the plug provided with the appliance – if it will not fit the outlet, have a proper outlet installed by a qualified electrician. Check with a qualified electrician or tradesman if you are in doubt as to whether the steaming hot water tap is properly earthed (grounded).

⚠ CAUTION	Personal Injury/Property Damage: This tank is a non-pressurized tank. DO NOT modify this system. DO NOT close vent tube or connect other types of taps or valves to the tank. Use only the InSinkErator tap supplied. Use only parts provided. Contact an authorized InSinkErator Service agent for repairs or replacement components.
------------------	---

⚠ WARNING	To reduce the risk associated with the ingestion of contaminants: Do not use with water that is microbiologically unsafe or of unknown quality without adequate disinfection before or after the system.
------------------	--

A steaming hot water tap, like any water heater, has a limited life and will eventually fail. To avoid possible property damage and personal injury, this steaming hot water tap should be regularly examined for leakage and/or corrosion and replaced when necessary. A drain pan, plumbed to an appropriate drain or outfitted with a leak detector, should be used in those applications where any leakage could cause property damage.

⚠ WARNING	Fire Hazard: To minimize possibility of fire, DO NOT store flammable items such as rags, paper or aerosol cans near the tank. DO NOT store or use petrol or other flammable vapors and liquids in the vicinity of this or any other appliance.
------------------	---

⚠ WARNING	Leak Hazard: Regularly inspect dispenser and plumbing fittings for leaks, which can cause property damage and could result in personal injury.
------------------	---

IMPORTANT SAFETY INFORMATION

NOTICE

Property Damage: To reduce the risk associated with property damage due to water leakage or flooding, and to ensure optimal performance:

- Read and follow Use Instructions before installation and use of this system.
- Installation and use MUST comply with all state and local plumbing codes.

System Requirements (Hot Water Tank, Filtration System and Dispenser):

- The flexible vent and outlet tubes must be correctly connected to the tap supplied by the manufacturer. They must not be obstructed or connected to a normal type tap or any other type.
- Do not install on hot water supply lines. The maximum operating water temperature of this system is 100°F (37.8°C). Attach to cold water supply only.
- Do not install if water pressure exceeds 125 psi (862 kPa). If your water pressure exceeds 80 psi (552 kPa), you must install a pressure limiting valve. Contact a plumbing professional if you are uncertain how to check your water pressure.
- Do not install where water hammer conditions may occur. If water hammer conditions exist you must install a water hammer arrester. Contact a plumbing professional if you are uncertain how to check for this condition.
- Where a backflow prevention device is installed on a water system, a device for controlling pressure due to thermal expansion must be installed.
- Protect from freezing, shut off water supply, remove filter cartridge, drain hot water tank and tubing when temperatures are expected to drop below 40° F (4.4° C); see Seasonal Storage/Drainage section.
- Do not use a torch or other high temperature sources near system, cartridges, plastic fittings or plastic plumbing.
- Do not install near water pipes which will be in path of a drilling tool when selecting the position to mount the bracket.
- Mount system in such a position as to prevent it from being struck by other items used in the area of installation.
- Ensure that the location and fasteners will support the weight of the system when installed and full of water.
- Ensure all tubing and fittings are secure and free of leaks.
- Do not install using rigid piping. System intended for use with plastic water lines (such as PEX tubing, PE tubing, PP tubing).
- Do not install this system if any of the quick connect collets are missing from the filter head or Y-Quick Connector. Contact an authorized InSinkErator Service agent if collets are missing from any fittings.
- For systems using two handle HC model faucets, operate only one handle at a time.
- Important: Do not allow the unit to continuously boil.
- Regularly inspect the system. If there are signs of water leakage, turn off the water supply and contact an authorized InSinkErator Service agent.
- A drain pan, plumbed to an appropriate drain or outfitted with a leak detector, should be used in those applications where any leakage could cause property damage.
- For questions or concerns, please contact an authorized InSinkErator Service agent (see back page for contact information).

Additional Consideration when Utilizing Filtration System:

- The disposable filter cartridge MUST be replaced every 6 months, at the rated capacity or sooner if a noticeable reduction in flow rate occurs.
- Failure to replace the disposable filter cartridge at recommended intervals may lead to reduced filter performance and cracks in the filter housing, causing water leakage or flooding.
- Protect from freezing, remove filter cartridge when temperatures are expected to drop below 40° F (4.4° C).
- Do not install systems in areas where ambient temperatures may go above 100°F (37.8°C).
- Do not install in direct sunlight or outdoors.

IN-HOME FULL SERVICE LIMITED WARRANTY

Dispenser: 5-year warranty
Stainless Steel Tank: 3-year warranty
Filtration System: 1-year warranty (excluding replaceable filtration cartridge)

This warranty is provided by InSinkErator, a business unit of Emerson Electric Co., ("InSinkErator" or "Manufacturer" or "we" or "our" or "us") to the original consumer owner of the InSinkErator product with which this warranty is provided (the "InSinkErator Product"), and any subsequent owner of the residence in which the Product was originally installed ("Customer" or "you" or "your").

InSinkErator warrants to Customer that your InSinkErator Product will be free from defects in materials and workmanship, subject to the exclusions described below, for the "Warranty Period", commencing on the later of: (a) the date your InSinkErator Product is originally installed, (b) the date of purchase, or (c) the date of manufacture as identified by your InSinkErator Product serial number. You will be required to show written documentation supporting (a) or (b). If you are unable to provide documentation supporting either (a) or (b), the Warranty Period commencement date will be determined by Manufacturer, in its sole and absolute discretion, based upon your InSinkErator Product serial number.

What is Covered

This warranty covers defects in materials or workmanship, subject to the exclusions below, in InSinkErator Products used by a consumer Customer for residential use only, and includes all replacement parts and labor costs. YOUR SOLE AND EXCLUSIVE REMEDY UNDER THIS LIMITED WARRANTY SHALL BE LIMITED TO REPAIR OR REPLACEMENT OF THE INSINKERATOR PRODUCT.

What is not Covered

This limited warranty does not extend to and expressly excludes:

- Losses or damages or the inability to operate your InSinkErator Product resulting from conditions beyond the Manufacturer's control including, without limitation, accident, alteration, misuse, abuse, neglect, negligence (other than Manufacturer's), failure to install, maintain, assemble, or mount the InSinkErator Product in accordance with Manufacturer's instructions or local electrical and plumbing codes.
- Wear and tear expected to occur during the normal course of use, including without limitation, cosmetic rust, scratches, dents or comparable and reasonably expected losses or damages.

In addition to the above exclusions, this warranty does not apply to InSinkErator Products installed in a commercial or industrial application.

No Other Express Warranty Applies

This warranty is the sole and exclusive warranty provided to the Customer identified above. No other express warranty, written or verbal, applies. No employee, agent, dealer, or other person is authorized to alter this limited warranty or make any other warranty on behalf of Manufacturer. The terms of this warranty shall not be modified by the Manufacturer, the original owner, or their respective successors or assigns.

What we will do to Correct Problems

If your InSinkErator Product does not operate in accordance with the documentation provided to you, or you have questions concerning your InSinkErator Product or how to determine when service is needed, please call the toll free InSinkErator AnswerLine at 1 (800) 558-5700, or visit our website at www.insinkerator.com. You may also notify us at: InSinkErator Service Center, 4700 21st Street, Racine, Wisconsin 53406 USA.

The following information must be provided as part of your warranty claim: your name, address, phone number, your InSinkErator Product model and serial number, and if necessary, upon request, written confirmation of either: (a) the date shown on your installation receipt, or (b) the date shown on your purchase receipt.

Manufacturer or its authorized service representative will determine, in its sole and absolute discretion, if your InSinkErator Product is covered under this warranty. You will be given the contact information for your closest authorized InSinkErator Service Center. Please contact your InSinkErator Service Center directly to receive in home warranty repair or replacement service. Only an authorized InSinkErator service representative may provide warranty service. InSinkErator is not responsible for warranty claims arising from work performed on your InSinkErator Product by anyone other than an authorized InSinkErator service representative.

If a covered claim is made during the Warranty Period, Manufacturer will, through its authorized service representative, either repair or replace your InSinkErator Product. Cost of replacement parts or a new InSinkErator Product, and cost of labor for repair or installation of the replacement InSinkErator Product are provided at no cost to you. Repair or replacement shall be determined by Manufacturer or its authorized service representative in their sole discretion. All repair and replacement services will be provided to you at your home. If Manufacturer determines that your InSinkErator Product must be replaced rather than repaired, the warranty on the replacement InSinkErator Product will be limited to the unexpired term remaining in the original Warranty Period.

Limitation of Liability

TO THE EXTENT PERMITTED BY LAW, IN NO EVENT SHALL MANUFACTURER OR ITS AUTHORIZED SERVICE REPRESENTATIVES BE LIABLE FOR ANY INCIDENTAL, SPECIAL, INDIRECT, OR CONSEQUENTIAL DAMAGES, INCLUDING ANY ECONOMIC LOSS, WHETHER RESULTING FROM NONPERFORMANCE, USE, MISUSE OR INABILITY TO USE THE INSINKERATOR PRODUCT OR THE MANUFACTURER'S OR ITS AUTHORIZED SERVICE REPRESENTATIVE'S NEGLIGENCE. MANUFACTURER SHALL NOT BE LIABLE FOR DAMAGES CAUSED BY DELAY IN PERFORMANCE AND IN NO EVENT, REGARDLESS OF THE FORM OF THE CLAIM OR CAUSE OF ACTION (WHETHER BASED IN CONTRACT, INFRINGEMENT, NEGLIGENCE, STRICT LIABILITY, OTHER SORT OR OTHERWISE), SHALL MANUFACTURER'S LIABILITY TO YOU EXCEED THE PRICE PAID BY THE ORIGINAL OWNER FOR THE INSINKERATOR PRODUCT.

The term "consequential damages" shall include, but not be limited to, loss of anticipated profits, business interruption, loss of use or revenue, cost of capital or loss or damage to property or equipment.

Some states do not allow the exclusion or limitation of incidental or consequential damages, so the above limitation may not apply to you. This warranty gives you specific legal rights and you may also have other rights which vary from state to state.

CARE AND USE

⚠ WARNING

Electric Shock Hazard: To prevent electrical shock, disconnect power before servicing unit. Use only a properly earthed (grounded) and polarized electric outlet.

ADJUSTING THE THERMOSTAT

Factory temperature pre-set is 200°F (93°C) (205°F (96°C) for HWT-HP Tank)). **To reset the thermostat to 200°F (93°C) (205°F (96°C) for HWT-HP Tank)), turn the indicator one notch to the right of vertical.** After adjusting, depress the tap handle for 20 seconds for water to re-heat to the new setting.

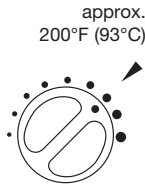

- To adjust water temperature, turn thermostat dial on the front of the tank clockwise to increase temperature or turn anticlockwise to decrease temperature. Repeat if necessary. All changes should be minimal.

⚠ WARNING

Scalding Hazard: Do not allow water to boil. May result in severe burns.

SEASONAL STORAGE/DRAINAGE

Anytime the steaming hot water tap is not used for extended periods of time, unplug and drain unit. If it is below freezing you will need to unplug the unit and drain it.

- Disconnect power from unit (unplug unit).
- Push hot water tap lever and allow water to flow until it is cool.
- Shut the cold water tap off at the valve.
- Disconnect tubes from the tank.
- Unhook tank from wall.
- Hold tank upside down and drain the water into the sink.
- Towel dry any water drippings from tank area.
- Reinstall tank to wall and reconnect tubes.
- Remove and discard filter cartridge, if applicable.
- To put back into working order, install new filter cartridge (if applicable) and turn on cold water supply at valve. Depress the hot water dispenser faucet lever and hold until water flows from the spout. Reconnect the electrical cord.

CLEANING THE TAP AND TANK

- Only use mild cleaners to clean the tap and plastic components.
- Cleaners with acids, abrasives, alkaline, and organic solvents will result in deterioration of the plastic components and void the warranty.

FILTER GUIDE AND REPLACEMENT

Replace filter cartridge when there is an obvious decrease in water flow to the tap or if there is an objectionable taste or odor to the water.

When the inlet and outlet ports have been closed and the filter's internal pressure has been relieved, water (about 2oz; 60ml) will discharge from vent line.

If the new filter cartridge cannot be inserted, insert the old one and turn until it stops, remove it and then retry the new cartridge.

The disposable filter cartridge MUST be replaced every 6 months, at the rated capacity or sooner if a noticeable reduction in flow rate occurs.

Filter replacement instructions:

- Replace with an InSinkErator® filter.
- Place pan or dish towel under the filter to catch water drainage during change.
- Slowly turn the cartridge anticlockwise completely until it stops (1/4 turn).
- Pull cartridge straight down and discard.
- Insert new cartridge into filter head.
- Top surface of cartridge will become flush with the bottom of the filter head when fully engaged.
- Turn the cartridge clockwise until it stops (1/4 turn).
- Open tap to expel trapped air.
- Run water for 3 minutes before usage.

⚠ CAUTION

Personal Injury:

- Regularly check for signs of corrosion by examining the appearance of the dispensed water every three (3) months.
- If there is any discoloration or rusty appearance, unplug and drain unit as described in the Seasonal Storage/Drainage section on this page of the manual.
- If the water discoloration remains after draining and refilling unit, discontinue use and contact an authorized InSinkErator service agent.

FILTRATION INFORMATION

The InSinkErator Instant Hot Water Dispenser Filtration System offers two levels of filtration, depending on the filter used: **F-1000S** is intended for use in filtering particulates, chlorine taste and odor from drinking water, and has not been evaluated for other uses; **F-2000S** reduces particulates, chlorine taste and odor, plus cysts, lead, mercury, asbestos, benzene, atrazine, 2,4-D, Lindane, Carbofuran and p-Dichlorobenzene. The system is typically installed (near or beneath a sink) where filtered drinking water is desired, and must be installed, operated and maintained as specified in the installation and use instructions.

NOTICE

- To reduce the risk associated with property damage due to water leakage or flooding:
- Read and follow Use Instructions provided with the original system before installation and use of this product.
- To reduce the risk of water leakage or flooding, and to ensure optimal filter performance:
- Change the disposable filter cartridge every six months or sooner if you observe a noticeable reduction in water flow rate.
 - Failure to replace the disposable filter cartridge at recommended intervals may lead to reduced filter performance and cracks in the filter housing, causing water leakage or flooding.
 - For systems using two handle HC model faucets, operate only one handle at a time.
 - For questions or concerns, please contact Customer Service at 1-800-558-5700.

WARNING

Do not use with water that is microbiologically unsafe or of unknown quality without adequate disinfection before or after the system.

F-1000 Cartridge (included with this system) Chemical & Mechanical Reduction Filter Specifications:
This cartridge provides mechanical and chemical reduction of chlorine taste & odor and particulate class III.



Tested & Certified by NSF International against NSF/ANSI Standard 42 in the following InSinkErator Systems Only: GN1100, HC1100, GN2200, HC2200, GN2215, HC2215, H3300 or HC3300 for the reduction of claims specified on the Performance Data Sheet. For systems using two handle HC model faucets, operate only one handle at a time.

Pressure: 30-120 (207-827 kPa) psi
Temperature: 33°F - 100°F
Flow Rate: 0.75 gpm
Capacity: 500 gallons

Filter Capacity: 500 gallons, depending on local water conditions. Note that while the testing was performed under standard laboratory conditions, actual performance may vary. Do not use with water that is microbiologically unsafe or of unknown quality without adequate disinfection before or after the system. For cold water use only. Systems must be installed and operated in accordance with the Manufacturer's recommended procedures and guidelines. See warranty card for warranty. For service and parts, contact your local dealer or InSinkErator® directly at 1-800-558-5700.

Contaminant Reduction	Average Influent	Influent Challenge Concentration, Except As Noted, Units Apply to Each Row.	Avg. Product Water	Average % Reduction	NSF Red. Requirements	NSF Test
Chlorine Taste & Odor	2.1 mg/L	2.0 mg/L ± 10%	0.06 mg/L	97.0%	≥ 50%	J-00082587
Nominal Particulate Class III, ≥5 µm to <15 µm	270,000 pts/mL	At least 10,000 particles/mL	82 pts/mL	99.9%	≥85%	J-00119308

Application guidelines/Water Supply Parameters for NSF Testing: Service flow of 0.75 gpm, community or private well water supply, water pressure of 20-120 psi (138-827 kPa), water temperature of 33°F-100°F Except as noted, all testing performed at pH = 7.5 ± 0.5, Flow: 0.75 gpm, Pressure: 60 psi, Temp: 20±3°C.

Refer to the Performance Data Sheet for InSinkErator Filter System Model F-2000S
Replacement Cartridge: F-2000

Contact an authorized InSinkErator service agent for repairs or replacement components. Replacement filters F-1000 and F-2000 can be ordered by calling 800-558-5700, visiting shop.insinkerator.com, or by contacting an authorized InSinkErator reseller.



Please read Troubleshooting Guide and/or visit www.insinkerator.com before calling AnswerLine®

TROUBLESHOOTING

PROBLEM	POSSIBLE CAUSE	WHAT TO DO
Water and steam spits forcefully from spout without turning on the dispenser faucet.	<ul style="list-style-type: none"> • Unit is boiling. <p><i>May be normal during initial setup.</i></p>	<ul style="list-style-type: none"> • Activate faucet lever to release some water from the tank. • Adjust water temperature using dial on tank front. <p><i>Remember that at higher altitudes, water boils at lower temperatures.</i></p>
Water is not hot.	<ul style="list-style-type: none"> • The unit is unplugged. • The electric outlet is inoperative. 	<ul style="list-style-type: none"> • Make sure the unit is connected to a properly grounded electric outlet. • Make sure the circuit breaker or fuses are functioning properly. • Check that the outlet is not switched off.
Water is too hot or not hot enough.	<ul style="list-style-type: none"> • Thermostat is not adjusted to your needs. 	<ul style="list-style-type: none"> • Adjust the thermostat slowly, then activate faucet lever for 20 seconds to bring in fresh water to be heated at the new setting. Allow 5-7 minutes for water to reach new temperature.
Water comes out the vent instead of spout.	<ul style="list-style-type: none"> • Outlet tube is blocked. 	<ul style="list-style-type: none"> • Check that outlet tube is not kinked, twisted or pinched. • Unscrew spout end piece and clean out any debris.
Water is dripping from the spout/vent intermittently.	<ul style="list-style-type: none"> • The expansion chamber isn't draining properly due to low water pressure. • The spout is blocked. 	<ul style="list-style-type: none"> • Unplug the unit. If the dripping doesn't stop after a few minutes, check the supply valve to ensure that is fully open and there are no obstructions in the water line reducing the pressure below 30 psi (i.e., a poorly mounted saddle valve, a clogged water filter, or a partially opened shut-off valve). • Unscrew spout end piece and clean out any debris.
Water is dripping from the spout/vent constantly.	<ul style="list-style-type: none"> • Debris in the water line may be in the faucet valve seat causing a slow water leak. 	<ul style="list-style-type: none"> • Unscrew spout end piece and clean out any debris. • Activate faucet lever 7-10 times to flush faucet & lines.
Divided stream.	<ul style="list-style-type: none"> • Debris in the end piece. 	<ul style="list-style-type: none"> • Unscrew spout end piece and clean out any debris.
Water discoloration/rusty appearance.	<ul style="list-style-type: none"> • Corrosion of unit. 	<ul style="list-style-type: none"> • Unplug and drain unit as described in the Seasonal Storage/Drainage Section on page 15 of this manual. If the water discoloration remains after draining and refilling unit, discontinue use and contact an authorized InSinkErator service agent.

FILTRATION ISSUES

Water taste or odor.	<ul style="list-style-type: none"> • Filter needs to be flushed out. • Life of filter has expired. 	<ul style="list-style-type: none"> • Activate the faucet lever and run until the water is cold. If there is no change, replace filter cartridge.
New filter leaks or doesn't fit.	<ul style="list-style-type: none"> • Head and bracket not fully rotated. • Filter O-ring breach. 	<ul style="list-style-type: none"> • Remove, inspect, reinstall filter cartridge. • Remove new filter, replace with old filter. Check operation. If OK, reinstall new filter and recheck operation.
No water flow or low water flow.	<ul style="list-style-type: none"> • Life of filter has expired. 	<ul style="list-style-type: none"> • Replace filter cartridge. See page 15.

If you are still experiencing trouble call the AnswerLine® 1-800-558-5700.

Free Manuals Download Website

<http://myh66.com>

<http://usermanuals.us>

<http://www.somanuals.com>

<http://www.4manuals.cc>

<http://www.manual-lib.com>

<http://www.404manual.com>

<http://www.luxmanual.com>

<http://aubethermostatmanual.com>

Golf course search by state

<http://golfingnear.com>

Email search by domain

<http://emailbydomain.com>

Auto manuals search

<http://auto.somanuals.com>

TV manuals search

<http://tv.somanuals.com>