

JBL

®

CINEMA VISION™

CVSAT50, CVCEN50,
CVSUB50

OWNER'S GUIDE

READ FIRST! Important Safety Precautions!

CAUTION

RISK OF ELECTRIC SHOCK DO NOT OPEN

CAUTION: To reduce the risk of electric shock, do not remove cover (or back). No user-serviceable parts inside. Refer servicing to qualified service personnel.

CAUTION: To prevent electric shock, do not use this (polarized) plug with an extension cord, receptacle or other outlet unless the blades can be fully inserted to prevent blade exposure.



The lightning flash with arrowhead symbol, within an equilateral triangle, is intended to alert the user to the presence of uninsulated "dangerous voltage" within the product's enclosure that may be of sufficient magnitude to constitute a risk of electric shock to persons.



The exclamation point within an equilateral triangle is intended to alert the user to the presence of important operating and maintenance (servicing) instructions in the literature accompanying the appliance.

1. Read these instructions.
2. Keep these instructions.
3. Heed all warnings.
4. Follow all instructions.
5. Do not use this apparatus near water.
6. Clean only with a dry cloth.
7. Do not block any ventilation openings. Install in accordance with the manufacturer's instructions.
8. Do not install near any heat sources such as radiators, heat registers, stoves or other apparatus (including amplifiers) that produce heat.
9. Do not defeat the safety purpose of the polarized or grounding-type plug. A polarized plug has two blades with one wider than the other. A grounding-type plug has two blades and a third grounding prong. The wide blade or the third prong are provided for your safety. If the provided plug does not fit into your outlet, consult an electrician for replacement of the obsolete outlet.
10. Protect the power cord from being walked on or pinched, particularly at plugs, convenience receptacles and the point where they exit from the apparatus.
11. Only use attachments/accessories specified by the manufacturer.
12. Use only with the cart, stand, tripod, bracket or table specified by the manufacturer or sold with the apparatus. When a cart is used, use caution when mov-



ing the cart/apparatus combination to avoid injury from tip-over.

13. Unplug this apparatus during lightning storms or when unused for long periods of time.

14. Refer all servicing to qualified service personnel. Servicing is required when the apparatus has been damaged in any way, such as power-supply cord or plug is damaged, liquid has been spilled or objects have fallen into the apparatus, the apparatus has been exposed to rain or moisture, does not operate normally, or has been dropped.

15. Do not use attachments not recommended by the product manufacturer, as they may cause hazards.

16. This product should be operated only from the type of power source indicated on the marking label. If you are not sure of the type of power supply to your home, consult your product dealer or local power company. For products intended to operate from battery power, or other sources, refer to the operating instructions.

17. If an outside antenna or cable system is connected to the product, be sure the antenna or cable system is grounded so as to provide some protection against voltage surges and built-up static charges. Article 810 of the National Electrical Code, ANSI/NFPA 70, provides information with regard to proper grounding of the mast and supporting structure, grounding of the lead-in wire to an antenna discharge unit, size of grounding conductors, location of antenna-discharge unit, connection to grounding electrodes, and requirements for the grounding electrode. See Figure A.

18. An outside antenna system should not be located in the vicinity of overhead power lines or other electric light or power circuits, or where it can fall into such power lines or circuits. When installing an outside antenna system, extreme care should be taken to keep from touching such power lines or circuits, as contact with them might be fatal.

19. Do not overload wall outlets, extension cords, or integral convenience receptacles, as this can result in a risk of fire or electric shock.

20. Never push objects of any kind into this product through openings, as they may touch dangerous voltage points or short-out parts that could result in a fire or electric shock. Never spill liquid of any kind on the product.

21. The apparatus shall not be exposed to dripping or splashing, and no objects filled with liquids, such as vases, shall be placed on the apparatus.

22. Do not attempt to service this product yourself, as opening or removing covers may expose you to dangerous voltage or other hazards. Refer all servicing to qualified service personnel.

23. When replacement parts are required, be sure the service technician has used replacement parts specified by the manufacturer or that have the same characteristics as the original part. Unauthorized substitutions may result in fire, electric shock or other hazards.

24. Upon completion of any service or repairs to this product, ask the service technician to perform safety checks to determine that the product is in proper operating condition.

25. The product should be mounted to a wall or ceiling only as recommended by the manufacturer.

Figure A.
Example of Antenna Grounding as per National Electrical Code ANSI/NFPA 70

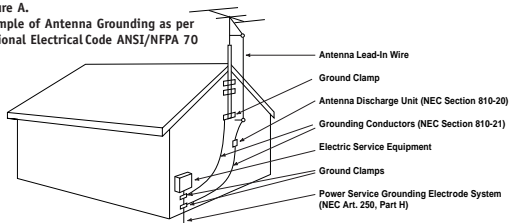

THANK YOU FOR CHOOSING JBL

For more than 50 years, JBL has been involved in every aspect of music and film recording and reproduction, from live performances to the recordings you play in your home, car or office.

We're confident that the JBL system you have chosen will

provide every note of enjoyment that you expected – and that when you think about purchasing additional audio equipment for your home, car or office, you will once again choose JBL.

Please take a moment to register your product on our

Web site at www.jbl.com.

It enables us to keep you posted on our latest advancements, and helps us to better understand our customers and build products that meet their needs and expectations.

JBL Consumer Products

INCLUDED CVSAT50

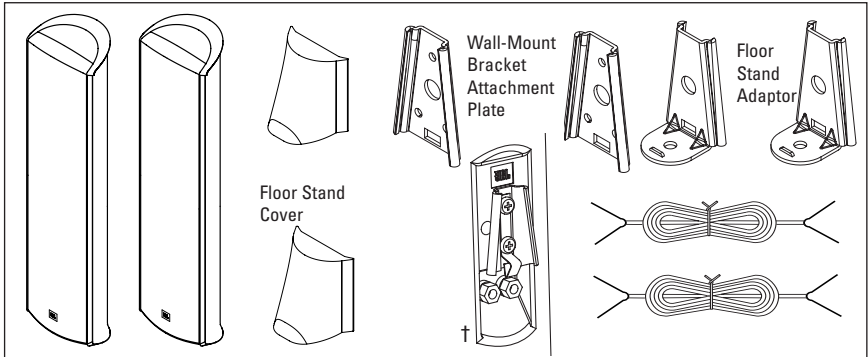

One pair of CVSAT50 loudspeakers with mounting brackets, wall-mount bracket attachment plates, floor stand adaptors, floor stand covers and speaker cable.

†Each CVSAT50 speaker comes with a mounting bracket and metal clip preinstalled. These parts are essential for mounting the speaker on the wall, on an optional floor stand, or on an optional CVT50 table stand, and, therefore, should never be removed from the speaker.

CVSUB50

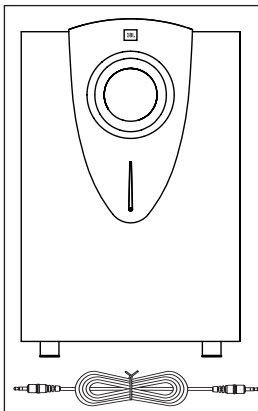

One CVSUB50 powered subwoofer with LFE interconnect cable.

CVCEN50

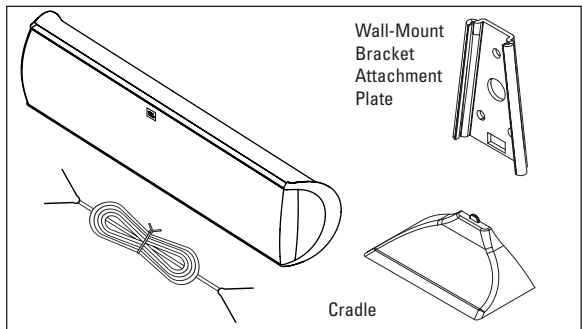

One CVCEN50 loudspeaker with mounting brackets, wall-mount bracket attachment plate, cradle and speaker cable.

Each CVCEN50 speaker comes with a mounting bracket and metal clip preinstalled, as shown in the diagram at the bottom of page 7. These parts are essential for mounting the speaker on the wall, or in the included cradle, and, therefore, should never be removed from the speaker.

SPEAKER PLACEMENT

FRONT SPEAKERS

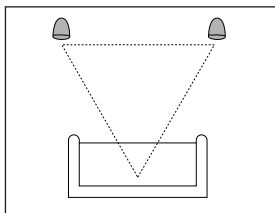

CENTER CHANNEL SPEAKER

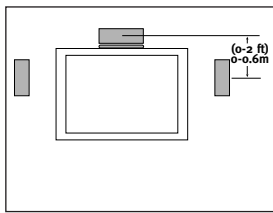

SUBWOOFER

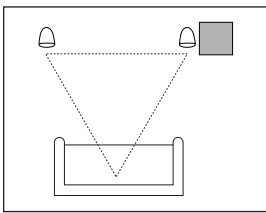

SURROUND SPEAKERS

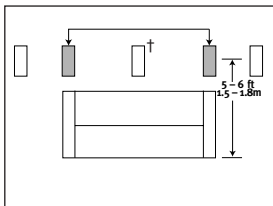
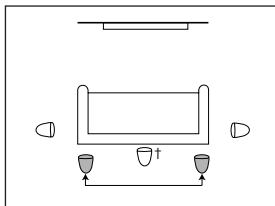

† Single surround back speaker may be used with 6.1 receivers and processors.

Alternate placement for surround speakers when only 5.1 channels are used; required placement for surround back speakers in 7.1-channel systems.

The front speakers should be placed the same distance from each other as they are from the listening position. They should be placed at about the same height from the floor as the listeners' ears will be, or they may be angled toward the listeners.

The center channel speaker should be placed slightly behind the front left and right speakers, and no more than two feet above or below the tweeters of the left and right speakers. It is often convenient to set the center speaker on top of the television set, as shown in the drawing.

The JBL Cinema Vision speaker system may be used in 5.1-, 6.1- or 7.1-channel applications. In 5.1-channel applications, two of the surround speakers should be

placed slightly behind the listening position and, ideally, should face each other and be at a level higher than the listeners' ears. If that is not possible, they may be placed on a wall behind the listening position, facing forward. In 6.1-channel applications, two of the surround speakers should be placed in the side positions, and a single surround back speaker should be placed on the wall behind the listening position. In 7.1-channel applications, place two of the surround speakers in the side positions, and place the two surround back speakers on the rear wall.

In Dolby® Digital and DTS® systems, it is best to aim all of the speakers (except the subwoofer) toward the listening position at about ear-level height. In systems where only analog surround

processing (such as Dolby Pro Logic*) is available, it may be preferable to aim the speakers straight out from the wall to obtain a more diffuse sound.

The low-frequency material reproduced by the subwoofer is mostly omnidirectional, and this speaker may be placed in a convenient location in the room. However, bass reproduction will be maximized when the subwoofer is placed in a corner along the same wall as the front speakers. Experiment with subwoofer placement by temporarily placing the subwoofer in the listening position and moving around the room until the bass reproduction is best. Place the subwoofer in that location.

MOUNTING OPTIONS

SATELLITES AND SURROUNDS

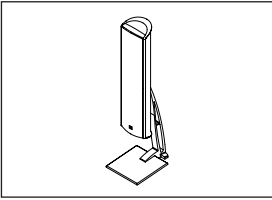

On shelves using the optional CVTS50 table stands.

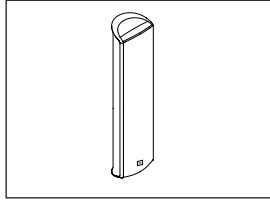

On the wall. Wall brackets are included.

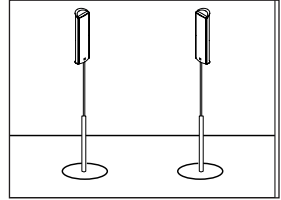

On compatible floor stands available from other manufacturers, using the supplied floor stand adaptors.

ATTACHING THE CVTS50 TABLE STAND (AVAILABLE SEPARATELY) TO THE CVSAT50

Important Safety Notes:

- *The table stand consists of two main parts: a metal column and a glass base. Be extremely careful in handling the fragile glass base to avoid breakage that might result in personal injury.*
- *The CVTS50 table stands are only intended for use with the CVSAT50 speaker. Attempting to use the stands with any other model speaker is unsafe and may result in personal injury and damage to the equipment.*
- *The stands must be placed in a safe location, protected from young children and pets who might topple the stands, possibly resulting in serious injury. Never place the stand so that any part of it is sticking out over the edge of the table, shelf or other surface underneath it.*
- *Do not install the CVSAT50 or any other speaker on the table stand in a horizontal orientation, as this would be unstable and might result in personal injury.*

Carefully insert the glass base into the slot in the column,

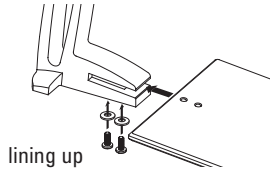

lining up the holes in the base with the holes in the bottom of the column. Screw in the bolts, making sure the plastic washers are between the bottom of the glass base and the bolt heads. Tighten the bolts securely using a Philips screwdriver (not supplied). *Do not overtighten, as this might strip the threads, which is not covered by the warranty.*

Prepare the speaker wire as described on page 8. Remove the rubber strip from the back of the column, revealing the wire-management channel. Thread the two conductors through the hole at the top of the channel. Make sure to preserve the proper polar-

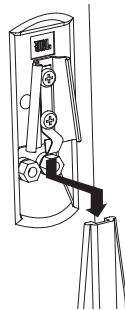

ity (+ and – connections) by placing the positive conductor on the left, and the negative conductor on the right, looking at the front of the stand column.

Use the supplied terminal wrench to loosen the red collar of the binding post until the pass-through hole underneath it is revealed. Insert the bare end of the positive wire through the hole, then screw the collar down until it is tight. Follow the same procedure to connect the negative wire to its terminal. Slowly lower the mounting bracket on the satellite onto the top of the metal column of the CVTS50 stand. Gently pull the slack out of the wire. Carefully press the rubber strip in place over the wire-management channel, being careful to keep the speaker wire in the channel and to avoid pinching it with the rubber strip.

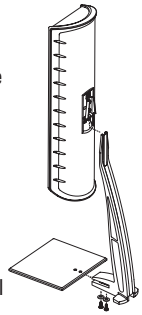

MOUNTING THE SATELLITES ON OPTIONAL FLOOR STANDS

Important Safety Note:

The supplied floor stand adaptors facilitate installation with a variety of general-purpose floor stands available from many manufacturers. Since different stands will have different weight capacities and stability characteristics, it is the customer's responsibility to check with the stand manufacturer or dealer to ascertain whether that specific stand is capable of handling the weight and proportions of these loudspeakers in a safe and stable manner. JBL disclaims any liability for the selection of suitable floor stands and/or correct compatibility between the selected stand and the supplied stand adaptor.

The floor stand adaptors are compatible with floor stands equipped with a 1/4"-20 threaded insert.

Using a suitable bolt supplied with the stand (or by you), attach the floor stand adaptor to the stand by screwing the bolt through the hole in the bottom tab of the adaptor and into the threaded insert at the top of the stand. Orient the adaptor so that the upright portion faces toward the listening position.

Prepare the speaker wire as described on page 8, and thread it through the floor stand's wire management system (if any), as instructed in the owner's guide for the stands. Make sure to preserve the proper polarity (+ and - connections).

Use the supplied terminal wrench to loosen the red collar of the binding post until the pass-through hole underneath it is revealed. Insert the bare end of the positive wire through the hole, then screw the collar down until it is tight. Follow the same procedure to connect the negative wire to its terminal.

Slowly lower the mounting bracket on the satellite onto the top of the floor stand adaptor until the metal spring clip engages in the squarish opening on the front of the adaptor.

Gently pull the slack out of the wire, and slide the floor stand cover over the adaptor for a smooth appearance.

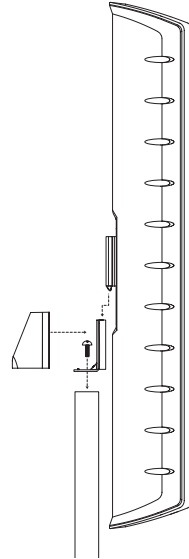

WALL-MOUNTING

Important Safety Note:

The customer is solely responsible for proper selection of mounting hardware not included with the speakers, and for proper assembly and installation of the wall brackets, including but not limited to the selection of appropriate weight-bearing supports and proper use of the bracket. JBL disclaims any liability for the selection of mounting hardware and/or bracket installation. Be sure to follow these bracket assembly and installation instructions carefully. If you have any questions or doubts about your ability to correctly wall-mount the speakers, consult with your authorized JBL dealer or custom installer.

Prepare the speaker wire as described on page 8, keeping the (+) conductor to the left and the (-) conductor to the right as you face the wall.

Mount the attachment plate into a wood stud on the wall, using three #10 pan-head wood screws at least one inch long (not supplied).

Make sure that all three screws are driven into the stud and not into drywall. If the bracket needs to be mounted in dry-wall, the customer is responsible for selecting and using appropriate wall anchors and screws.

Making sure to preserve the proper polarity (+ and - connections), use the supplied terminal

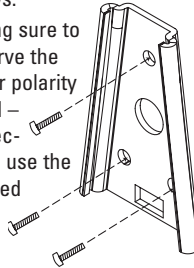
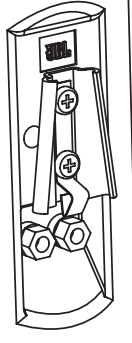

wrench to loosen the red collar of the binding post until the pass-through hole underneath it is revealed. Insert the bare end of the positive wire through the hole, then screw the collar down until it is tight. Follow the same procedure to connect the negative wire to its terminal.

Carefully lower the speaker onto the bracket so that the mounting bracket on the satellite slides over the wall attachment plate until the metal spring clip engages in the square hole in bracket part B.

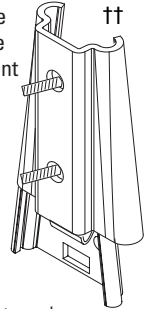

†† Shown without speaker attached to bolts.

ATTACHING THE CRADLE TO THE CENTER SPEAKER

Important Safety Notes:

- The CVCEN50 cradle is only intended for use with the CVCEN50 speaker. Attempting to use the cradle with any other model speaker is unsafe and may result in personal injury and damage to the equipment.
- The cradle must be placed in a safe location, protected from young children and pets who might topple it, possibly resulting in serious

injury. Never place the cradle so that any part of it is sticking out over the edge of the table, shelf or other surface underneath it.

- If you intend to install the CVCEN50 speaker on top of the JBL Cinema Vision plasma television, do not use the cradle. Instead, place it on the plasma screen's table stand, or, if the screen is mounted on the wall, mount the

CVCEN50 on the wall above or below the screen.

Lower the CVCEN50 speaker onto the cradle so that it rests in the curved pedestal. The metal clip should fit over the tab at the top of the cradle.

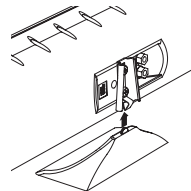

SPEAKER CONNECTIONS

CONNECTION TIPS

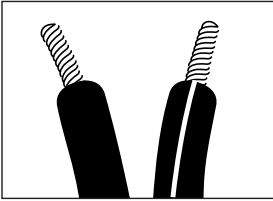

Separate and strip the ends of the speaker wire as shown. The wires supplied with the system may already be stripped and tinned for easy insertion into the speaker terminals. You may need to separate the two conductors further in order to thread them through the shelf stand or floor stand adaptor. Speakers and electronics terminals have corresponding (+) and (-) terminals. Most manufacturers of speakers and electronics, including JBL, use red to denote the (+) terminal and black to denote the (-) terminal.

The (+) lead of the speaker wire is noted with a stripe. It is important to connect both speakers identically: (+) on the speaker to (+) on the amplifier and (-) on the speaker to (-) on the amplifier. Wiring "out of phase" results in thin sound, weak bass and a poor stereo image.

With the advent of multi-channel surround sound systems, connecting all of the speakers in your system with the correct polarity remains equally important in order to preserve the proper ambience and directionality of the program material.

To use the binding-post speaker terminals, unscrew the colored collar using the supplied wrench until the pass-through hole in the center post is visible under the collar. Insert the bare end of the wire through this

hole; then screw the collar down until the connection is tight. The hole in the center of each collar is intended for use with banana-type connectors. To comply with European CE certification, these holes are blocked with plastic inserts at the point of manufacture. To use banana-type connectors requires the removal of the inserts.

SYSTEM CONNECTION

The CVSUB50 subwoofer is equipped with only one input – a dedicated low-frequency effects (LFE) input. Since the LFE channel is by definition limited to only the lowest portion of the frequency spectrum, it is crucial that your receiver's output be compatible. The CVSUB50 should only be used with receivers or processors that have digital surround decoders, such as Dolby® Digital or DTS.® Do not use the CVSUB50 with components that output a

full-range signal through the subwoofer output or with components that only have a line-level (preamp) output, unless an outboard low-pass crossover is used to filter the signal.

Use the line-level input jack marked "LFE" for the low-frequency effects channel. Connect this jack to the LFE (subwoofer) output on your receiver or processor. Connect each speaker to the corresponding speaker terminals on your receiver or amplifier.

Make sure that you have configured your surround sound processor for "Subwoofer On." Also configure your receiver for 5.1-, 6.1- or 7.1-channel operation, as appropriate. The front left, front right, center and rear speakers should all be set to "Small." If your receiver allows you to set the crossover frequency between the subwoofer and the main speakers, select 90Hz or the setting that is the closest frequency below it (80Hz if available).

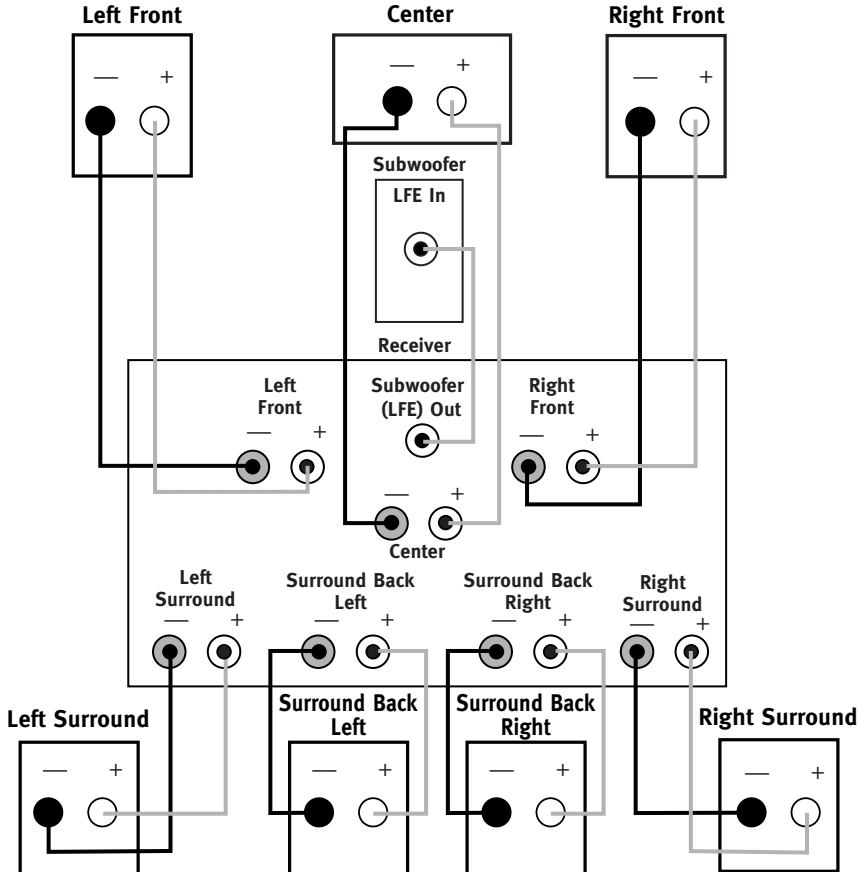

SUBWOOFER OPERATION

Press the Master Power switch (marked "Power" **A**) in to the On position to use the subwoofer. The CVSUB50 subwoofer will automatically turn on or go into standby (sleep) mode as described below. When your receiver or amplifier is off, or is not sending program material to the subwoofer, the subwoofer will be in standby mode (LED on front of CVSUB50 will be red). When the subwoofer senses an audio signal, it will automatically turn on (LED will be green). If the subwoofer does not sense a signal after approximately 20 minutes, it will automatically go into standby mode.

If you will be away from home for an extended period

of time, or if the subwoofer will not be used, switch the Master Power switch **A** to

the Off position by pressing it until it pops out.

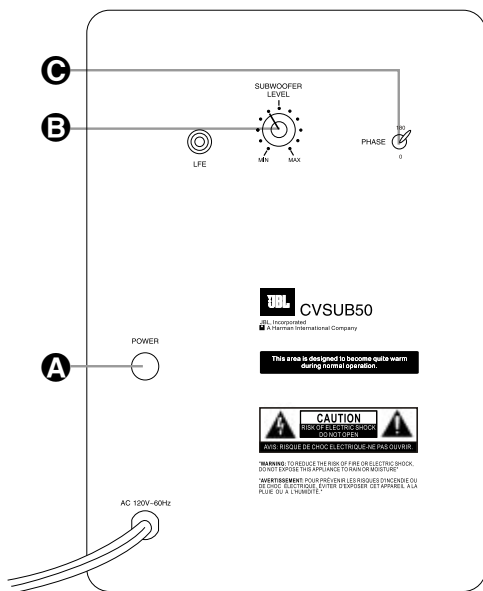

VOLUME

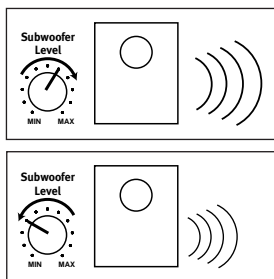

Volume may be adjusted using the Subwoofer Level control **B** as shown.



The Phase Control determines whether the subwoofer's piston-like action moves in and out in phase with the main speakers or opposite the main speakers. There is no correct or incorrect setting. Proper phase adjustment depends on several variables, such as subwoofer placement and listener position. Adjust the Phase Switch **C** to maximize bass output at the listening position.

Remember, every system, room and listener is different. There are no right or wrong settings; this switch offers the added flexibility to

adjust your subwoofer for optimum performance for your specific listening conditions without having to move your speakers. If at some time in the future you happen to rearrange your listening room and move your speakers, you should experiment with the phase switch in both positions, and leave it in the position that maximizes bass performance.

TROUBLESHOOTING

If there is no sound from any of the speakers:

- Check that receiver/amplifier is on and a source is playing.
- Check that the powered subwoofer is plugged in, and is turned on (Power switch **A** pushed in).
- Check all wires and connections between receiver/amplifier and speakers. Make sure all wires are connected. Make sure none of the speaker wires are frayed, cut or punctured, or touching each other.
- Review proper operation of your receiver/amplifier.

If there is no sound coming from one speaker:

- Check the "Balance" control on your receiver/amplifier.
- Check all wires and connections between receiver/amplifier and speakers. Make sure all wires are connected. Make sure none of the speaker wires are frayed, cut or punctured, or touching each other.
- In Dolby Digital or DTS modes, make sure that the receiver/processor is configured so that the speaker in question is enabled.
- Turn off all electronics and switch the speaker in question with one of the other speakers that is working correctly. Turn everything back on, and determine whether the problem has followed the speaker, or has remained in the same channel. If the problem is in the same channel, the source of the problem is most likely with your receiver or amplifier, and you should consult the owner's manual for that product for further informa-

tion. If the problem has followed the speaker, consult your dealer for further assistance or, if that is not possible, visit www.jbl.com.

If there is no sound from the center speaker:

- Check all wires and connections between receiver/amplifier and speaker. Make sure all wires are connected. Make sure none of the speaker wires are frayed, cut or punctured, or touching each other.
- If your receiver/processor is set in Dolby Pro Logic mode, make sure the center speaker is not in phantom mode.
- If your receiver/processor is set in one of the Dolby Digital or DTS modes, make sure the receiver/processor is configured so that the center speaker is enabled.

If the system plays at low volumes but shuts off as volume is increased:

- Check all wires and connections between receiver/amplifier and speakers. Make sure all wires are connected. Make sure none of the speaker wires are frayed, cut or punctured, or touching each other.
- If more than one pair of main speakers is being used, check the minimum impedance requirements of your receiver/amplifier.

If there is low (or no) bass output:

- Make sure the connections to the left and right "Speaker Inputs" have the correct polarity (+ and -).
- Make sure the subwoofer is plugged into an active electrical outlet, and is turned on (Power switch **A** pushed in).

- In Dolby Digital or DTS modes, make sure your receiver/processor is configured so that the subwoofer and LFE output are enabled.
- Switch the Phase Switch **C** to the opposite position, and select the position that results in the most pleasing bass response.

If there is no sound from the surround speakers:

- Check all wires and connections between receiver/amplifier and speakers. Make sure all wires are connected. Make sure none of the speaker wires are frayed, cut or punctured, or touching each other.
- Review proper operation of your receiver/amplifier and its surround sound features.
- Make sure the movie or TV show you are watching is recorded in a surround sound mode. If it is not, check to see whether your receiver/amplifier has other surround modes you may use.
- In Dolby Digital or DTS modes, make sure your receiver/processor is configured so that the surround speakers are enabled. When five satellites are in use, remember to configure your receiver or processor for 6.1-channel operation, and when six satellites are in use, configure your receiver or processor for 7.1 channels.
- Review the operation of your DVD player and the jacket of your DVD to make sure that the DVD features the desired Dolby Digital or DTS mode, and that you have properly selected that mode using both the DVD player's menu and the DVD disc's menu.

SPECIFICATIONS

System

Frequency Response
22Hz – 20kHz (–6dB)

CVSAT50

Maximum Recommended Amplifier Power
150 Watts**

Power Handling 50W Continuous/300W Peak

Frequency Response 55Hz – 30kHz (–6dB)

Nominal Impedance 8 Ohms

Sensitivity 90dB @ 1 Watt/1 meter

Tweeter

One 3/4" (19mm) titanium-laminate dome, video-shielded

Woofers

Dual 5" (130mm) transducers with PolyPlas™ cones, neodymium magnets & HeatScape™ motor structure, video-shielded

Dimensions (H x W x D)

(including wall-mount bracket and grille)

25-1/8" x 6-1/4" x 4-5/8" (638mm x 159mm x 117mm)

Weight 6.9 lb (3.1kg)

CVCEN50

Maximum Recommended Amplifier Power
150 Watts**

Power Handling 50W Continuous/300W Peak

Frequency Response 55Hz – 30kHz (–6dB)

Nominal Impedance 8 Ohms

Sensitivity 90dB @ 1 Watt/1 meter

Tweeter

One 3/4" (19mm) titanium-laminate dome, video-shielded

Woofers

Dual 5" (130mm) transducers with PolyPlas™ cones, neodymium magnets & HeatScape™ motor structure, video-shielded

Dimensions (H x W x D)

(including wall-mount bracket and grille)

6-1/4" x 25-1/8" x 4-5/8" (159mm x 638mm x 117mm)

Weight 6.9 lb (3.1kg)

CVSUB50

Amplifier Power – 400 Watts RMS

Frequency Response 22Hz – Low-pass crossover setting at signal source

Low-Frequency Driver

12" (300mm) Transducer with PolyPlas™ cone & HeatScape™ motor structure, video-shielded

Input LFE preamp level

Dimensions (H x W x D) (including feet)

18-3/4" x 12" x 18-1/4" (476mm x 305mm x 464mm)

Weight 49 lb (22.3kg)

All features and specifications are subject to change without notice.

*Trademarks of Dolby Laboratories.

DTS is a registered trademark of Digital Theater Systems, Inc.

**The maximum recommended amplifier power rating will ensure proper system headroom to allow for occasional peaks. We do not recommend sustained operation at these maximum power levels.

OWNER'S GUIDE		JBL	PRO SOUND COMES HOME™
PRODUCT LINE: JBL CINEMA VISION™		JBL Consumer Products 250 Crossways Park Drive, Woodbury, NY 11797 8500 Balboa Boulevard, Northridge, CA 91329 516.255.4JBL (4525) www.jbl.com	
MODELS: CVSAT50, CVCEN50, CVSUB50		© 2004 Harman International Industries, Incorporated	
DESIGN GOAL: Bring the thrill of live performance and movie sound to the home environment by calling on JBL's professional engineering leadership.		JBL is a registered trademark of Harman International Industries, Incorporated.	
SATELLITE TYPE: Titanium-laminate-dome tweeter, sealed enclosure		Part No. 406-000-01002 	
SUBWOOFER TYPE: Bass-reflex enclosure		H A Harman International Company	
PORT DESIGN: FreeFlow™ flared			
PROFESSIONAL REFERENCE: Cinema Loudspeaker Series			

Free Manuals Download Website

<http://myh66.com>

<http://usermanuals.us>

<http://www.somanuals.com>

<http://www.4manuals.cc>

<http://www.manual-lib.com>

<http://www.404manual.com>

<http://www.luxmanual.com>

<http://aubethermostatmanual.com>

Golf course search by state

<http://golfingnear.com>

Email search by domain

<http://emailbydomain.com>

Auto manuals search

<http://auto.somanuals.com>

TV manuals search

<http://tv.somanuals.com>