

**JBL**

**JBL PROJECT ARRAY™**

1500 ARRAY, 1400 ARRAY,  
1000 ARRAY, 880 ARRAY,  
800 ARRAY

®

**OWNER'S GUIDE**

# READ FIRST! Important Safety Precautions!

**CAUTION**  
**RISK OF ELECTRIC SHOCK**  
**DO NOT OPEN**

CAUTION: To reduce the risk of electric shock, do not remove cover (or back). No user-serviceable parts inside. Refer servicing to qualified service personnel.

CAUTION: To prevent electric shock, do not use this (polarized) plug with an extension cord, receptacle or other outlet unless the blades can be fully inserted to prevent blade exposure.

 The lightning flash with arrowhead symbol, within an equilateral triangle, is intended to alert the user to the presence of uninsulated "dangerous voltage" within the product's enclosure that may be of sufficient magnitude to constitute a risk of electric shock to persons.

 The exclamation point within an equilateral triangle is intended to alert the user to the presence of important operating and maintenance (servicing) instructions in the literature accompanying the appliance.

1. Read these instructions.
2. Keep these instructions.
3. Heed all warnings.
4. Follow all instructions.
5. Do not use this apparatus near water.
6. Clean only with a dry cloth.
7. Do not block any ventilation openings. Install in accordance with the manufacturer's instructions.
8. Do not install near any heat sources such as radiators, heat registers, stoves or other apparatus (including amplifiers) that produce heat.
9. Do not defeat the safety purpose of the polarized or grounding-type plug. A polarized plug has two blades with one wider than the other. A grounding-type plug has two blades and a third grounding prong. The wide blade or the third prong are provided for your safety. If the provided plug does not fit into your outlet, consult an electrician for replacement of the obsolete outlet.
10. Protect the power cord from being walked on or pinched, particularly at plugs, convenience receptacles and the point where they exit from the apparatus.
11. Only use attachments/accessories specified by the manufacturer.
12. Use only with the cart, stand, tripod, bracket or table specified by the manufacturer or sold with the apparatus. When a cart is used, use caution when



- moving the cart/apparatus combination to avoid injury from tip-over.
13. Unplug this apparatus during lightning storms or when unused for long periods of time.
  14. Refer all servicing to qualified service personnel. Servicing is required when the apparatus has been damaged in any way, such as power-supply cord or plug is damaged, liquid has been spilled or objects have fallen into the apparatus, the apparatus has been exposed to rain or moisture, does not operate normally, or has been dropped.
  15. Do not use attachments not recommended by the product manufacturer, as they may cause hazards.
  16. This product should be operated only from the type of power source indicated on the marking label. If you are not sure of the type of power supply to your home, consult your product dealer or local power company. For products intended to operate from battery power or other sources, refer to the operating instructions.
  17. If an outside antenna or cable system is connected to the product, be sure the antenna or cable system is grounded so as to provide some protection against voltage surges and built-up static charges. Article 810 of the National Electrical Code, ANSI/NFPA 70, provides information with regard to proper grounding of the mast and supporting structure, grounding of the lead-in wire to an antenna discharge unit, size of grounding conductors, location of antenna-discharge unit, connection to grounding electrodes, and requirements for the grounding electrode. See Figure A.
  18. An outside antenna system should not be located in the vicinity of overhead power lines or other electric light or power circuits, or where it can fall into such power

- lines or circuits. When installing an outside antenna system, extreme care should be taken to keep from touching such power lines or circuits, as contact with them might be fatal.
19. Do not overload wall outlets, extension cords, or integral convenience receptacles, as this can result in a risk of fire or electric shock.
  20. Never push objects of any kind into this product through openings, as they may touch dangerous voltage points or short-out parts, which could result in a fire or electric shock. Never spill liquid of any kind on the product.
  21. The apparatus shall not be exposed to dripping or splashing, and no objects filled with liquids, such as vases, shall be placed on the apparatus.
  22. Do not attempt to service this product yourself, as opening or removing covers may expose you to dangerous voltage or other hazards. Refer all servicing to qualified service personnel.
  23. When replacement parts are required, be sure the service technician has used replacement parts specified by the manufacturer or that have the same characteristics as the original part. Unauthorized substitutions may result in fire, electric shock or other hazards.
  24. Upon completion of any service or repairs to this product, ask the service technician to perform safety checks to determine that the product is in proper operating condition.
  25. The product should be mounted to a wall or ceiling only as recommended by the manufacturer.

**Figure A.**  
**Example of Antenna Grounding as per National Electrical Code ANSI/NFPA 70**

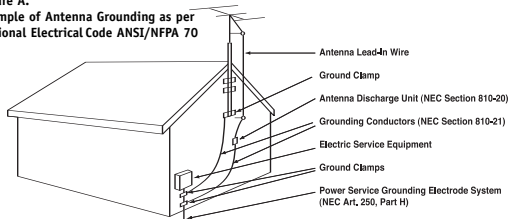

# THANK YOU FOR CHOOSING JBL®

For more than 60 years, JBL has been involved in every aspect of music and film recording and reproduction, from live performances to the recordings you play in your home, car or office.

We're confident that the JBL system you have chosen will provide every note of

enjoyment that you expect – and that when you think about purchasing additional audio equipment for your home, car or office, you will once again choose JBL.

Please take a moment to register your product on our Web site at [www.jbl.com](http://www.jbl.com). It enables us to keep you

posted on our latest advancements, and helps us to better understand our customers and build products that meet their needs and expectations.

JBL Consumer Products

## PROJECT ARRAY™

Project Array loudspeakers are an extremely high-performance design intended for uses ranging from premium two-channel stereo to multi-channel home theater applications. The series is modular and consists of five system elements:

- 1400 Array – floorstanding
- 1000 Array – floorstanding
- 800 Array – bookshelf
- 880 Array – center channel
- 1500 Array – powered subwoofer

## INCLUDED

### 1400 Array

- 2 Long 1/4" x 20 Allen-head bolts
- 1 Short 1/4" x 20 Allen-head bolts
- 1 Logo plate
- 1 Allen-head screw driver
- 1 Rubber hole plug
- 4 Metal coasters (to protect floor from spiked feet)



### 1000 Array, 800 Array and 1500 Array

- 4 Metal coasters (to protect floor from spiked feet)



# SPEAKER PLACEMENT

**IMPORTANT NOTE:** The 800, 1000, 1400 and 1500 Array models feature spiked feet for optimum acoustic performance.

However, spikes can damage certain types of floors, such as hardwood. In such instances, place included metal coasters

between the spiked feet and the floor.

## 5.1-CHANNEL SYSTEM

### Front Speakers

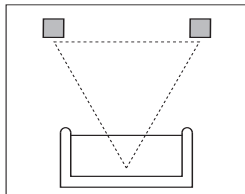

### Center Channel Speaker

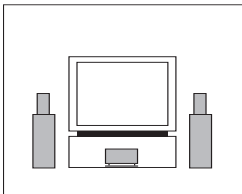

### Surround Speakers

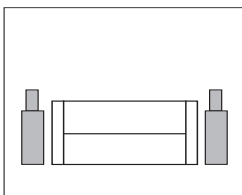
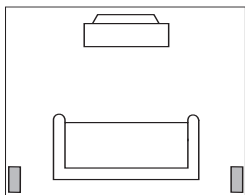

The front speakers should be placed the same distance from each other as they are from the listening position, with tweeters at about the same height from the floor as the listeners' ears will be.

The center channel speaker should be placed below the television and no more than two feet below the tweeters of the left and right speakers.

The two surround speakers should be placed slightly behind the listening position and, ideally, should face each other. If that is not possible,

they may be placed on a wall behind the listening position, facing forward. The surround speakers should not call attention to themselves. Experiment with their placement until you hear a diffuse, ambient sound accompanying the main program material heard in the front speakers.

The low-frequency material reproduced by the subwoofer is mostly omnidirectional, and this speaker may be placed in a convenient location in the room. However, the best reproduction of bass will be heard when the subwoofer

is placed in a corner along the same wall as the front speakers. Experiment with subwoofer placement by temporarily placing the subwoofer in the listening position and moving around the room until the bass reproduction is best. Place the subwoofer in that location.

## 6.1-CHANNEL SYSTEM

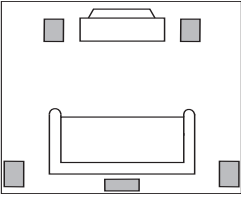

A 6.1-channel system will consist of a 5.1-channel configuration, as shown on page 4, with the addition of a rear center speaker placed midway between the two surround speakers, and further to the rear than the

surrounds. The rear center speaker should not call more attention to itself than the surround speakers.

## 7.1-CHANNEL SYSTEM

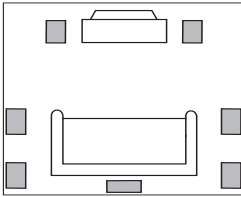

Some newer surround sound formats utilize left and right surround channels that are used for side fill, in addition to the left and right rear channels found in 5.1 systems. Place the left and right surround speakers on the

sides of the room, at or in front of the listening position, facing each other.

# 1400 ARRAY ASSEMBLY

Due to the weight of the 1400 Array horn module, it is packed separately from the low-frequency enclosure. It is a very simple procedure to install the module, and the necessary instructions are listed below. The required Allen-tipped screw driver is included in the accessory pack.

1. Carefully remove the horn module from the packaging and place it face down on a soft surface.
2. Locate the cardboard accessory sleeve and remove the hardware.
3. The accessory sleeve should contain:
  - a. 2 Long 1/4" x 20 Allen-head bolts
  - b. 1 Short 1/4" x 20 Allen-head bolt
  - c. 1 Logo plate
  - d. 1 Rubber hole plug
  - e. 4 Metal coasters (to protect wood and tile floors from the spike feet)
4. Carefully unpack the low-frequency enclosure and place it upright. It would be helpful to position it near its final position in the room since it is much easier to move without the additional weight of the horn module.
5. Notice the two threaded inserts on the angled face of the top and also the small L-bracket on the top. These are the attachment points for the horn module. Immediately adjacent to the L-bracket is a recessed connector which will make the electrical connection for the horn module.
6. Although the module can be installed by one person, it is easier if a second set of hands are available.
7. Cradle the horn module with the opening along your forearm and, using your free hand, connect the plug coming from the bottom of the horn assembly into the jack on the top of the enclosure.
8. You can now place the horn in position on top of the enclosure. The L-bracket fits in an opening under the horn assembly. The module will sit on top of the enclosure by itself, although it should always be steadied until fully mounted.
9. Line up the two mounting holes on the lower lip of the front of the horn with those in the enclosure. Partially install one long bolt and then the other one. It may be necessary to lift the horn slightly so that the bolts install smoothly. Do not force or cross-thread them.
10. Once both bolts have been started, work them in all of the way, but do not tighten them securely just yet.
11. Install the remaining short bolt in the hole at the bottom rear of the horn module. You can fully tighten this bolt.
12. Now completely tighten the two front bolts.
13. Everything should be tight and properly aligned at this time. If not, loosen, realign, and retighten as required.
14. The final steps are to remove the backing from the logo badge and place it in the recess on the lower horn lip, and to use the rubber hole plug to hide the hole at the bottom rear of the horn module. Do not complete these steps until the system has been turned on and tested acoustically. Make sure the horn module is playing first. Once the logo badge and rubber plug hole are installed, it is extremely difficult to remove them.

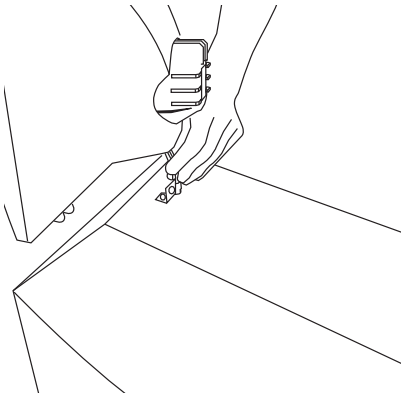
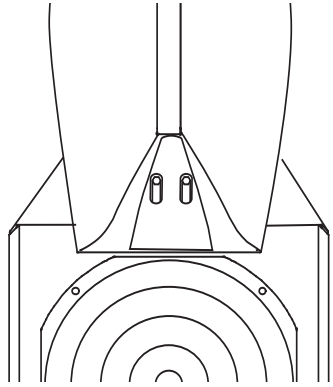
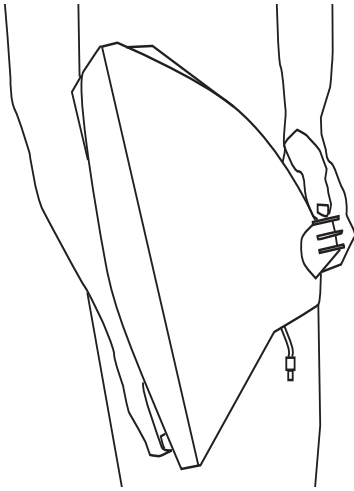

Step 7

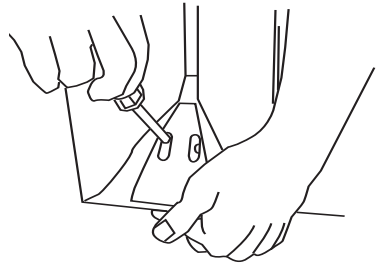

Step 9

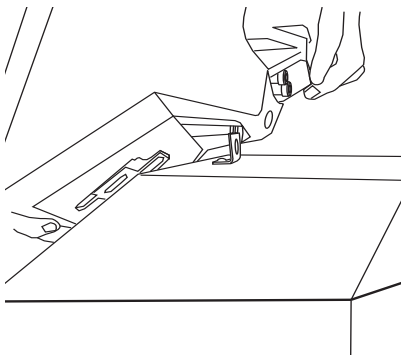

Step 8

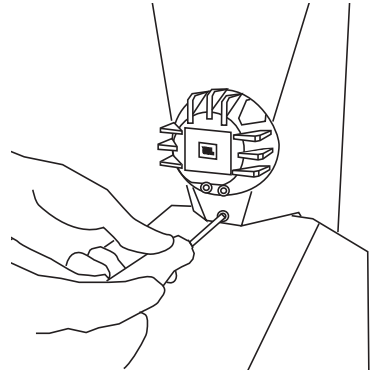

Step 11

# SPEAKER CONNECTIONS

## Subwoofer Controls and Connections (1500 Array Only)

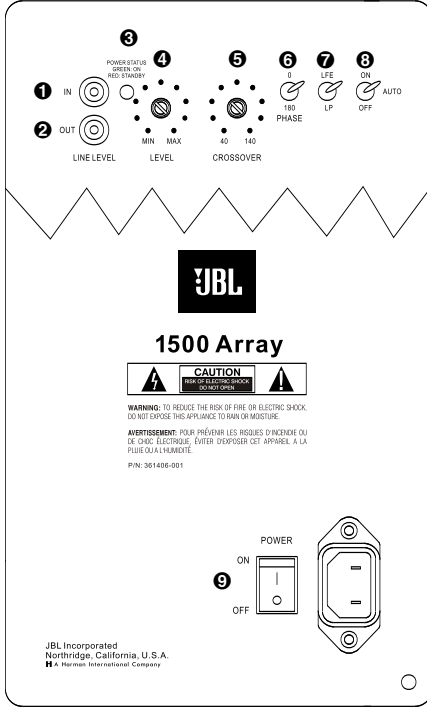

- ❶ Line-Level Input
- ❷ Line-Level Output
- ❸ Power Indicator
- ❹ Subwoofer Level (Volume) Control
- ❺ Crossover Adjustment
- ❻ Phase Switch
- ❼ LP/LFE Selector
- ❽ On/Off Auto Switch
- ❾ Power Switch

### Connection:

If you have a Dolby® Digital or DTS® receiver/processor with a low-frequency-effects (LFE) output, set LFE/LP switch to LFE. If you prefer to use the crossover built into the 1500 Array, set the LFE/LP Switch ❷ to LP.

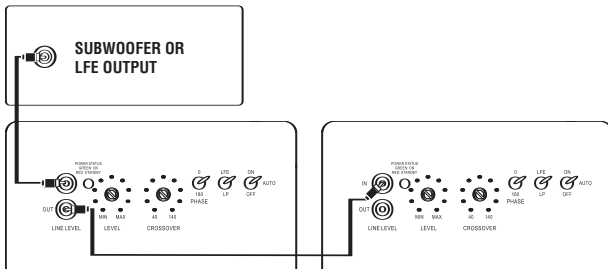
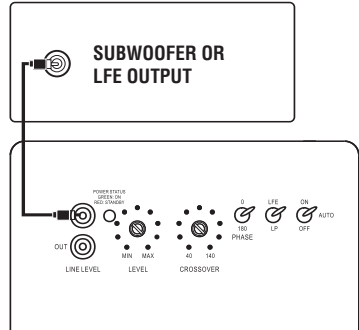

The 1500 Array includes a line output. This output allows you to “daisy chain” one 1500 Array to multiple 1500 Array subwoofers. Simply connect the first subwoofer as described above and then run a subwoofer cable from the line output(s) to the line input on the next sub.



# 1500 ARRAY OPERATION

## Power On

Plug your subwoofer's AC cord into a wall outlet. Do not use the outlets on the back of the receiver.

Initially set the Subwoofer Level (Volume) Control ④ to the "min" position.

Turn on your sub by pressing the Power Switch ⑨ on the rear panel.

## Auto On/Standby

With the Power Switch ⑨ in the "on" position, the Power Indicator LED ③ will remain backlit in red or green to indicate the On/Standby mode of the subwoofer.

RED = STANDBY (No signal detected, Amp Off)

GREEN = ON (Signal detected, Amp On)

The subwoofer will automatically enter the Standby mode after approximately 10 minutes when no signal is detected from your system. The subwoofer will then power ON instantly when a signal is detected. During periods of normal use, the Power Switch ⑨ can be left on. You may turn off the Power Switch ⑨ for extended periods of non-operation, e.g., when you are away on vacation.

If the Auto Switch ⑧ is in the "on" position, the subwoofer will remain on.

## Adjust Level

Turn on your entire audio system and start a CD or movie soundtrack at a moderate level. Turn up the Subwoofer Level (Volume) Control ④ about halfway. If no sound emanates from the subwoofer, check the AC-line cord and input cables. Are the connectors on the cables making proper contact? Is the AC

plug connected to a "live" receptacle? Has the Power Switch ⑨ been pressed to the "on" position? Once you have confirmed that the subwoofer is active, proceed by playing a CD or movie. Use a selection that has ample bass information.

Set the overall volume control of the preamplifier or stereo to a comfortable level. Adjust the Subwoofer Level (Volume) Control ④ until you obtain a pleasing blend of bass. Bass response should not overpower the room but rather should be adjusted so there is a harmonious blend across the entire musical range. Many users have a tendency to set the subwoofer volume too loud, adhering to the belief that a subwoofer is there to produce lots of bass. This is not entirely true. A subwoofer is there to enhance bass, extending the response of the entire system so the bass can be felt as well as heard. However, overall balance must be maintained or the music will not sound natural. An experienced listener will set the volume of the subwoofer so its impact on bass response is always there but never obtrusive.

## Crossover Adjustments

NOTE: This control will have no effect if the LP/LFE Selector Switch ⑦ is set to "LFE." If you have a Dolby Digital or DTS processor/receiver, the Crossover Frequency is set by the processor/receiver. Consult your owner's manual to learn how to view or change this setting.

The Crossover Adjustment Control ⑤ determines the highest frequency at which the subwoofer reproduces sounds.

If your main speakers can comfortably reproduce some low-frequency sounds, set this control to a lower frequency setting, between 50Hz and 100Hz. This will concentrate the subwoofer's efforts on the ultradeep bass sounds required by today's films and music. If you are using smaller bookshelf speakers that do not extend to the lower bass frequencies, set the Crossover Adjustment Control to a higher setting, between 120Hz and 150Hz.

## Phase Control

The Phase Switch ⑥ determines whether the subwoofer speaker's pistonlike action moves in and out with the main speakers (0°) or opposite the main speakers (180°). Proper phase adjustment depends on several variables, such as subwoofer placement and listener position. Adjust the Phase Switch to maximize bass output at the listening position.

# GENERAL CONNECTION INFORMATION

Separate and strip the ends of the speaker wire (not supplied) as shown. Speakers and electronics terminals have corresponding (+) and (-) terminals. Most manufacturers of speakers and electronics, including JBL, use red to denote the (+) terminal and black for the (-) terminal.

The (+) lead of the speaker wire is sometimes noted with

a stripe or other demarcation. It is important to connect both speakers identically: (+) on the speaker to (+) on the amplifier and (-) on the speaker to (-) on the amplifier. Wiring "out of phase" results in thin sound, weak bass and a poor stereo image.

With the advent of multi-channel surround sound systems, connecting all of

the speakers in your system with the correct polarity remains equally important in order to preserve the proper ambience and directionality of the program material.



## WIRING THE SYSTEM

**IMPORTANT:** Make sure all equipment is turned off before making any connections.

For speaker connections, use a high-quality speaker wire with polarity coding. The side of the wire with a ridge or other coding is usually considered positive (+) polarity.

**NOTE:** If desired, consult your local JBL dealer about speaker wire and connection options.

The speakers have coded terminals that accept a variety of wire connectors. The most common connection is shown in Figure 1.

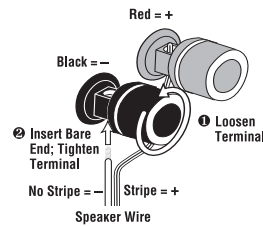

Figure 1

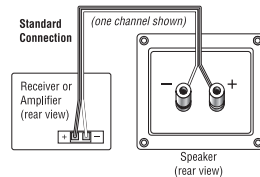

Figure 2

To ensure proper polarity, connect each + terminal on the back of the amplifier or receiver to the respective + (red) terminal on each speaker, as shown in Figure 2. Connect the - (black) terminals in a similar way. See the owner's guides that were included with your amplifier, receiver and television to confirm connection procedures.

**IMPORTANT:** Do not reverse polarities (i.e., + to - or - to +) when making connections. Doing so will cause poor imaging and diminished bass response.

## FINAL ADJUSTMENTS

Check the speakers for playback, first by setting the system volume control to a minimum level, and then by applying power to your audio system. Play a favorite music or video segment and increase the system volume control to a comfortable level.

**NOTE:** You should hear balanced audio reproduction across the entire frequency spectrum. If not, check all wiring connections or consult the authorized JBL dealer from whom you purchased the system for more help.

Both the amount of bass you hear and the stereo-image quality will be affected by a number of different factors, including the room's size and shape, the construction materials used to build the room, the listener's position relative to the speakers, and the position of the speakers in the room.

Listen to a variety of music selections and note the bass level. If there is too much bass, move the speakers away from nearby walls. Conversely, if you place the speakers closer to the walls, there will be more bass output.

Nearby reflecting surfaces can adversely affect stereo-imaging quality. If this happens, try angling the speakers slightly inward toward the listening position until the optimum effect is achieved.

## CARE OF YOUR SPEAKER SYSTEM

Each Project Array enclosure has a finish that does not require any routine maintenance. When needed, use a soft cloth to remove any fingerprints or dust from the enclosure or grille.

**NOTE:** Do not use any cleaning products or polishes on the cabinet or grille.

# TROUBLESHOOTING

## **If there is no sound from any of the speakers:**

- Check that receiver/amplifier is on and a source is playing.
- Check all wires and connections between receiver/amplifier and speakers. Make sure all wires are connected. Make sure none of the speaker wires are frayed, cut or punctured.
- Review proper operation of your receiver/amplifier.

## **If there is no sound coming from one speaker:**

- Check the “Balance” control on your receiver/amplifier.
- Check all wires and connections between receiver/amplifier and speakers. Make sure all wires are connected. Make sure none of the speaker wires are frayed, cut or punctured.
- In Dolby Digital or DTS modes, make sure that the receiver/processor is configured so that the speaker in question is enabled.

## **If there is no sound from the center speaker:**

- Check all wires and connections between the receiver/amplifier and speaker. Make sure all wires are connected. Make sure none of the speaker wires are frayed, cut or punctured.
- If your receiver/processor is set in Dolby Pro Logic® mode, make sure the center speaker is not in phantom mode.
- If your receiver/processor is set in Dolby Digital or DTS mode, make sure the receiver/processor is configured so that the center speaker is enabled.

## **If the system plays at low volumes but shuts off as volume is increased:**

- Check all wires and connections between receiver/amplifier and speakers. Make sure all wires are connected. Make sure none of the speaker wires are frayed, cut or punctured.
- If more than one pair of main speakers is being used, check the minimum impedance requirements of your receiver/amplifier.

## **If there is low (or no) bass output (1500 Array):**

- Make sure the connections to the left and right “Speaker Inputs” have the correct polarity (+ and –).
- Make sure the subwoofer is plugged into an active electrical outlet.
- Make sure the Power Switch **9** is on.
- In Dolby Digital or DTS modes, make sure your receiver/processor is configured so that the subwoofer and LFE output are enabled.
- Adjust the Subwoofer Level Control **4**.

## **If there is no sound from the surround speakers:**

- Check all wires and connections between receiver/amplifier and speakers. Make sure all wires are connected. Make sure none of the speaker wires are frayed, cut or punctured.
- Review proper operation of your receiver/amplifier and its surround sound features.
- Make sure the movie or TV show you are watching is recorded in a surround sound

mode. If it is not, check to see whether your receiver/amplifier has other surround modes you may use.

- In Dolby Digital or DTS modes, make sure your receiver/processor is configured so that the surround speakers are enabled.
- Review the operation of your DVD player and the jacket of your DVD to make sure that the DVD features the desired Dolby Digital or DTS mode, and that you have properly selected that mode using both the DVD player’s menu and the DVD disc’s menu.

# SPECIFICATIONS

	<b>1400 ARRAY</b>	<b>1000 ARRAY</b>	<b>800 ARRAY</b>	<b>880 ARRAY</b>	<b>1500 ARRAY</b>
	<b>3-Way, 14" (350mm) Floorstanding</b>	<b>3-Way, 10" (250mm) Floorstanding</b>	<b>3-Way, 8" (200mm) Bookshelf</b>	<b>3-Way, Dual 8" (200mm) Center</b>	<b>15" (380mm) 1000-Watt Front-Firing Sub</b>
Ultrahigh-Frequency Transducer	045Ti: 1" Pure-titanium compression driver with aluminum edge-wound voice coil and Z' neodymium motor assembly, mounted in a SonoGlass™ constant- directivity horn	045Ti: 1" Pure-titanium compression driver with aluminum edge-wound voice coil and Z' neodymium motor assembly, mounted in a SonoGlass™ constant- directivity horn	045Ti: 1" Pure-titanium compression driver with aluminum edge-wound voice coil and Z' neodymium motor assembly, mounted in a SonoGlass™ constant- directivity horn	045Ti: 1" Pure-titanium compression driver with aluminum edge-wound voice coil and Z' neodymium motor assembly, mounted in a SonoGlass™ constant- directivity horn	N/A
High-Frequency Transducer	435AL-1: 3" Aquaplas-treated aluminum-dome compression driver with aluminum edge-wound voice coil and neodymium motor assembly, mounted in a vertical SonoGlass™ constant-directivity horn	175Nd-3: 1-3/4" Aquaplas-treated aluminum-dome compression driver with aluminum edge-wound voice coil and neodymium motor assembly, mounted in a vertical SonoGlass™ constant-directivity horn	175Nd-3: 1-3/4" Aquaplas-treated aluminum-dome compression driver with aluminum edge-wound voice coil and neodymium motor assembly, mounted in a vertical SonoGlass™ constant-directivity horn	435AL: 3" Aquaplas-treated aluminum-dome compression driver with aluminum edge-wound voice coil and neodymium motor assembly, mounted in a vertical SonoGlass™ constant-directivity horn	N/A
Low-Frequency Transducer	LE14H-3: 14" Aquaplas-treated pulp-cone driver with rubber surround and massive ferrite motor assembly with 4" copper edge-wound voice coil, mounted in a trapezoidal enclosure	Array 10: 10" Polymer-treated pulp-cone driver with rubber surround, 1-1/2" copper voice coil and ferrite motor assembly, mounted in a trapezoidal enclosure	Array 8: 8" Polymer-treated pulp-cone driver with rubber surround, 1-1/2" copper voice coil and ferrite motor assembly, mounted in a trapezoidal enclosure	Dual Array 8C: 8" Polymer-treated pulp-cone drivers with 1-1/2" voice coils wound on an aluminum former and ferrite motor assemblies, mounted on angled baffles in independent trapezoidal enclosures	W1500H: 15" Pulp-cone driver with rubber surround and massive ferrite motor assembly with 4" copper edge- wound voice coil, mounted in a trapezoidal enclosure
Sensitivity (2.83V/1m)	89dB	89dB	88dB	90dB	N/A
Frequency Response (-3dB)	32Hz - 40kHz	35Hz - 40kHz	55Hz - 40kHz	70Hz - 40kHz	25Hz - 400Hz, variable
Recommended Amplifier Power Range	10 - 300 Watts	10 - 200 Watts	10 - 200 Watts	10 - 200 Watts	N/A
Crossover Frequencies	750Hz, 8kHz	900Hz, 8kHz	1000Hz, 8kHz	1000Hz, 8kHz	40Hz - 140Hz HP
Nominal Impedance	8 Ohms	8 Ohms	8 Ohms	8 Ohms	N/A
Port	4" Flared	3-3/8" Flared	2" Flared	N/A	4" Flared
Dimensions (H x W x D)	46-1/2" x 15-1/2" x 19" (1181mm x 394mm x 483mm)	43-1/2" x 12-1/4" x 17" (1105mm x 311mm x 432mm)	29-1/4" x 10-3/4" x 14" (743mm x 273mm x 356mm)	12-1/4" x 28-3/4" x 11" (311mm x 730mm x 279mm)	23" x 19-1/2" x 19" (584mm x 495mm x 483mm) 21" (533mm) Deep with grille
Weight (each)	115 lb (52kg)	70 lb (32kg)	40 lb (18kg)	46 lb (21kg)	125 lb (57kg)

All features and specifications are subject to change without notice.

JBL and Harman International are trademarks of Harman International Industries, Incorporated, registered in the United States and/or other countries.

Project Array, Pro Sound Comes Home and SonoGlass are trademarks of Harman International Industries, Incorporated.

Dolby and Pro Logic are trademarks of Dolby Laboratories.

DTS is a registered trademark of DTS, Inc.

## JBL PRO SOUND COMES HOME™

JBL Consumer Products, 250 Crossways Park Drive, Woodbury, NY 11797 USA  
8500 Balboa Boulevard, Northridge, CA 91329 USA  
2, route de Tours, 72500 Château du Loir, France  
516.255.4JBL (4525) (USA only) www.jbl.com  
© 2006 Harman International Industries, Incorporated. All rights reserved.  
Part No. 406-000-05331-E

© A Harman International Company

1400 Array, 1000 Array, 800 Array, 880 Array

1500 Array (230V only)

Declaration of Conformity



We, Harman Consumer Group International  
2, route de Tours  
72500 Château du Loir  
France

declare in own responsibility that the products  
described in this owner's manual are in compliance  
with technical standards:  
EN 61000-6-3:2001  
EN 61000-6-1:2001

Laurent Rault  
Harman Consumer Group International  
Château du Loir, France 1/06

Declaration of Conformity



We, Harman Consumer Group International  
2, route de Tours  
72500 Château du Loir  
France

declare in own responsibility that the product  
described in this owner's manual is in compliance  
with technical standards:  
EN 55013:2001+A1:2003  
EN 61000-3-2:2000  
EN 61000-3-3:1995+A1:2001  
EN 60065:2002

Laurent Rault  
Harman Consumer Group International  
Château du Loir, France 1/06

## Free Manuals Download Website

<http://myh66.com>

<http://usermanuals.us>

<http://www.somanuals.com>

<http://www.4manuals.cc>

<http://www.manual-lib.com>

<http://www.404manual.com>

<http://www.luxmanual.com>

<http://aubethermostatmanual.com>

Golf course search by state

<http://golfingnear.com>

Email search by domain

<http://emailbydomain.com>

Auto manuals search

<http://auto.somanuals.com>

TV manuals search

<http://tv.somanuals.com>