

**JBL**

**SURROUND CINEMA  
SPEAKERS**

SCS145.5

**OWNER'S GUIDE**

# READ FIRST!

## Important Safety Precautions!

### CAUTION

#### RISK OF ELECTRIC SHOCK DO NOT OPEN

**CAUTION:** To prevent electric shock, do not remove the grounding plug on the power cord, or use any plug or extension cord that does not have a grounding plug provided.

Make certain that the AC outlet is properly grounded. Do not use an adapter plug with this product.



The lightning flash with arrowhead symbol, within an equilateral triangle, is intended to alert the user to the presence of uninsulated "dangerous voltage" within the product's enclosure that may be of sufficient magnitude to constitute a risk of electric shock to persons.



The exclamation point within an equilateral triangle is intended to alert the user to the presence of important operating and maintenance (servicing) instructions in the literature accompanying the appliance.

1. Read these instructions.
2. Keep these instructions.
3. Heed all warnings.
4. Follow all instructions.
5. Do not use this apparatus near water.
6. Clean only with a dry cloth.
7. Do not block any ventilation openings. Install in accordance with the manufacturer's instructions.
8. Do not install near any heat sources such as radiators, heat registers, stoves or other apparatus (including amplifiers) that produce heat.
9. Do not defeat the safety purpose of the polarized or grounding-type plug. A polarized plug has two blades with one wider than the other. A grounding-type plug has two blades and a third grounding prong. The wide blade or the third prong are provided for your safety. If the provided plug does not fit into your outlet, consult an electrician for replacement of the obsolete outlet.
10. Protect the power cord from being walked on or pinched, particularly at plugs, convenience receptacles and the point where they exit from the apparatus.
11. Only use attachments/accessories specified by the manufacturer.
12. Use only with the cart, stand, tripod, bracket or table specified by the manufacturer or sold with the apparatus. When a cart is used, use caution when moving the cart/apparatus combination to avoid injury from tip-over.



13. Unplug this apparatus during lightning storms or when unused for long periods of time.
14. Refer all servicing to qualified service personnel. Servicing is required when the apparatus has been damaged in any way, such as power-supply cord or plug is damaged, liquid has been spilled or objects have fallen into the apparatus, the apparatus has been exposed to rain or moisture, does not operate normally, or has been dropped.
15. Do not use attachments not recommended by the product manufacturer, as they may cause hazards.
16. This product should be operated only from the type of power source indicated on the marking label. If you are not sure of the type of power supply to your home, consult your product dealer or local power company. For products intended to operate from battery power, or other sources, refer to the operating instructions.
17. If an outside antenna or cable system is connected to the product, be sure the antenna or cable system is grounded so as to provide some protection against voltage surges and built-up static charges. Article 810 of the National Electrical Code, ANSI/NFPA 70, provides information with regard to proper grounding of the mast and supporting structure, grounding of the lead-in wire to an antenna discharge unit, size of grounding conductors, location of antenna-discharge unit, connection to grounding electrodes, and requirements for the grounding electrode. See Figure A.

18. An outside antenna system should not be located in the vicinity of overhead power lines or other electric light or power circuits, or where it can fall into such power lines or circuits. When installing an outside antenna system, extreme care should be taken to keep from touching such power lines or circuits, as contact with them might be fatal.
19. Do not overload wall outlets, extension cords, or integral convenience receptacles, as this can result in a risk of fire or electric shock.
20. Never push objects of any kind into this product through openings, as they may touch dangerous voltage points or short-out parts that could result in a fire or electric shock. Never spill liquid of any kind on the product.
21. The apparatus shall not be exposed to dripping or splashing, and no objects filled with liquids, such as vases, shall be placed on the apparatus.
22. Do not attempt to service this product yourself, as opening or removing covers may expose you to dangerous voltage or other hazards. Refer all servicing to qualified service personnel.
23. When replacement parts are required, be sure the service technician has used replacement parts specified by the manufacturer or that have the same characteristics as the original part. Unauthorized substitutions may result in fire, electric shock or other hazards.
24. Upon completion of any service or repairs to this product, ask the service technician to perform safety checks to determine that the product is in proper operating condition.
25. The product should be mounted to a wall or ceiling only as recommended by the manufacturer.

Figure A.  
Example of Antenna  
Grounding as per National  
Electrical Code, ANSI/NFPA 70

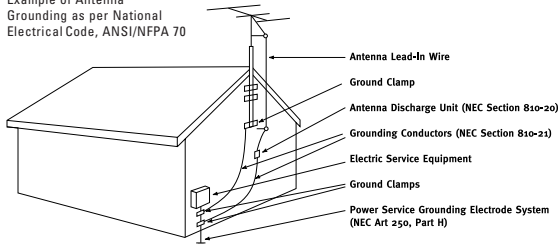

# THANK YOU FOR CHOOSING JBL

For more than 50 years, JBL has been involved in every aspect of music and film recording and reproduction, from live performances to the recordings you play in your home, car or office.

We're confident that the JBL system you have chosen will

provide every note of enjoyment that you expected – and that when you think about purchasing additional audio equipment for your home, car or office, you will once again choose JBL.

Please take a moment to register your product on our

Web site at [www.jbl.com](http://www.jbl.com). It enables us to keep you posted on our latest advancements, and helps us to better understand our customers and build products that meet their needs and expectations.

JBL Consumer Products

## INCLUDED

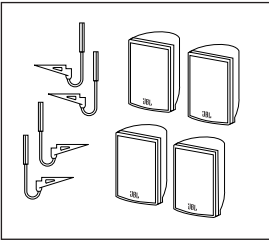

Four satellites for left, right and surrounds. Wall-mount brackets.

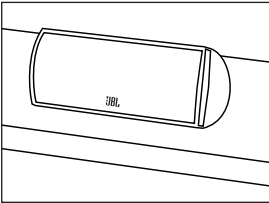

One center channel speaker with adjustable support leg.

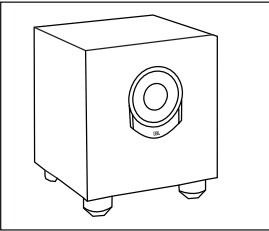

Powered subwoofer.

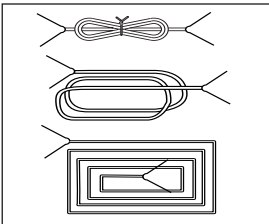

Two 20' speaker cables for connection from receiver to subwoofer.

Two 15' speaker cables for connection from subwoofer to front speakers.

Three 40' speaker cables for connection from receiver to rear satellites and center speaker.

# SPEAKER PLACEMENT

## FRONT SPEAKERS

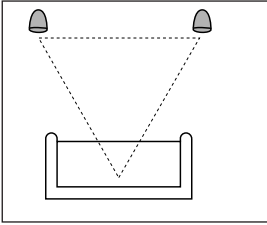

## CENTER CHANNEL SPEAKER

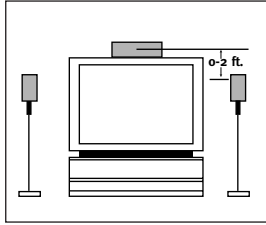

Stands shown are optional.

## SUBWOOFER

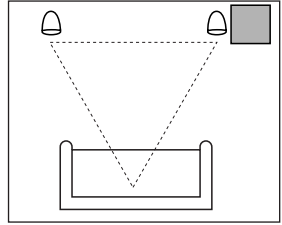

## SURROUND SPEAKERS

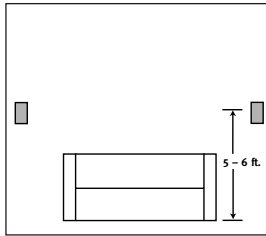
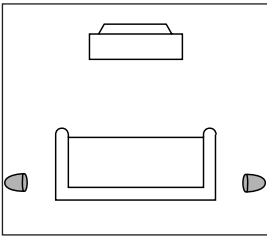

The front speakers should be placed the same distance from each other as they are from the listening position. They should be placed at about the same height from the floor as the listeners' ears will be, or they may be angled toward the listeners. The center channel speaker should be placed slightly behind the front left and right speakers, and no more than two feet above or below the tweeters of the left and right speakers. It is often convenient to set the center speaker on top of the television set, as shown in the drawing. Use the supplied support leg to aim it toward the listener by screwing the leg in to angle the speaker up, or unscrewing the leg

slightly to angle the speaker down.

The surround speakers should be placed slightly behind the listening position and, ideally, should face each other and be at a level higher than the listeners' ears. If that is not possible, they may be placed on a wall behind the listening position, facing forward.

In Dolby® Digital and DTS® systems, it is best to aim all of the speakers (except the subwoofer) toward the listening position at about ear-level height. In systems where only analog surround processing (such as Dolby Pro Logic®) is available, it may be preferable to aim the speakers straight out from the wall to obtain a more diffuse sound.

The low-frequency material reproduced by the subwoofer is mostly omnidirectional, and this speaker may be placed in a convenient location in the room. However, bass reproduction will be maximized when the subwoofer is placed in a corner along the same wall as the front speakers. Experiment with subwoofer placement by temporarily placing the subwoofer in the listening position and moving around the room until the bass reproduction is best. Place the subwoofer in that location.

# MOUNTING OPTIONS

## SATELLITES AND SURROUNDS

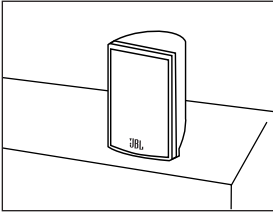

On shelves.

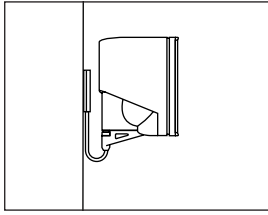

On the wall. Wall brackets are included.

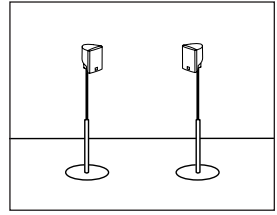

On optional stands (FS1000).

## WALL-MOUNTING

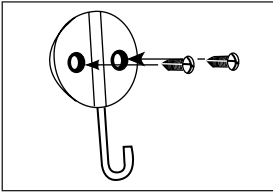

Attach plate to wall. The brackets should be placed, if possible, so that the screws will fasten into a wooden wall stud. If that is not possible, use properly selected wall anchors.

The customer is responsible for proper selection and use of mounting hardware, available through hardware stores, to properly and safely wall-mount the speakers.

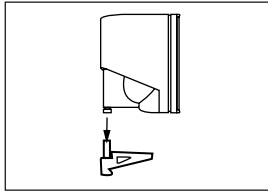

Slide speaker onto support.

**IMPORTANT NOTE:** The satellite speaker, when mounted on these brackets, can only be adjusted horizontally (left or right). The speaker cannot be adjusted vertically (up or down) or otherwise tilted. Any attempt to do so will damage the speaker bracket wall plate and/or support and such damage will not be covered under warranty.

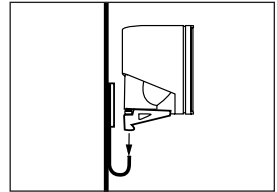

Place speaker and support on wall plate. Make sure that at least 1/4" (6mm) of the wall plate metal shaft is inserted into the support cavity. Continue to firmly press the support onto the wall plate metal shaft until it is fully secured in place.

## MOUNTING THE SATELLITES ON OPTIONAL FS1000 FLOOR STANDS

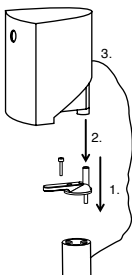

1. Attach the stand adaptor to the top of the stand upright with the pins toward the rear of the stand. Fasten the adaptor to the upright with such supplied screw.
2. Place the loudspeaker securely on the stand by inserting the adaptor pin

into the grommet on the bottom of the speaker.

3. Connect the wire to the loudspeaker, remembering to preserve the polarity ("+" and "-") (see page 6).

# SPEAKER CONNECTIONS

## CONNECTION TIPS

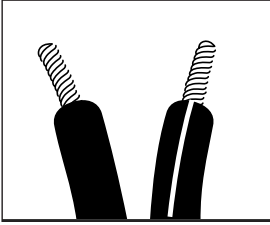

Separate and strip the ends of the speaker wire as shown. The wires supplied with the system may already be stripped and tinned for easy insertion into the speaker terminals. Speakers and electronics terminals have corresponding (+) and (-) terminals. Most manufacturers of speakers and electronics, including JBL, use red to denote the (+) terminal and black for the (-) terminal.

The (+) lead of the speaker wire is noted with a stripe. It is important to connect both speakers identically: (+) on the speaker to (+) on the amplifier and (-) on the speaker to (-) on the amplifier. Wiring “out of phase” results in thin sound, weak bass and a poor stereo image.

With the advent of multi-channel surround sound systems, connecting all of the speakers in your system with the correct polarity remains equally important in order to preserve the proper ambience and directionality of the program material.

To connect the supplied speaker wires to the speaker terminals, press the red or black plastic tab for the desired terminal, insert the bare end of the wire into the hole and release the tab. Gently tug on the wire to make sure that it is fully inserted.

## DOLBY DIGITAL OR DTS (OR OTHER DIGITAL SURROUND MODE) CONNECTION

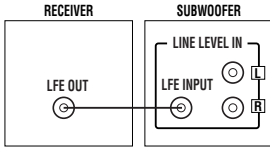

Use this installation method for Dolby Digital, DTS or other digital surround processors:

Use the line-level input jack marked "LFE" for the Low-Frequency Effects channel.

Connect this jack to the LFE output or subwoofer output on your receiver or amplifier. Connect each speaker to the corresponding speaker terminals on your receiver or amplifier.

Make sure that you have configured your surround sound processor for "Subwoofer On." The receiver should be config-

ured for 5.1-channel operation, and the front left, front right, center and rear speakers should all be set to "Small." If your receiver allows you to set the crossover frequency between the subwoofer and the main speakers, select either 120Hz or 150Hz, or select the setting that is the closest frequency below these.

## DOLBY PRO LOGIC (NON-DIGITAL) - LINE LEVEL

Use this installation method for Dolby Pro Logic applications (not Dolby Digital, DTS or other digital processing), where the receiver/processor is equipped with a subwoofer output, or a

volume-controlled preamp (line-) level output:

Use RCA-type interconnects to connect the line-level subwoofer outputs on your receiver or amplifier to the line-level inputs on the subwoofer. **IMPORTANT:** Do not

use the LFE input on the subwoofer with Dolby Pro Logic processors. **NOTE:** If your receiver or amplifier only has one subwoofer output jack, then you will need to use a Y-connector (not included). Plug the male end of the Y-connector into your receiver or amplifier's subwoofer output jack, and connect each of the two female ends to separate RCA-type interconnects. Finally, plug the RCA-type interconnects into the line-level inputs on the subwoofer.

Connect each speaker to the corresponding speaker terminals on your receiver or amplifier.

Make sure your receiver or processor is correctly configured to indicate that the subwoofer is "On."

Note for advanced users: If your receiver/processor has a built-in low-pass crossover filter for the subwoofer output, you may use the LFE input to bypass the subwoofer's internal crossover.

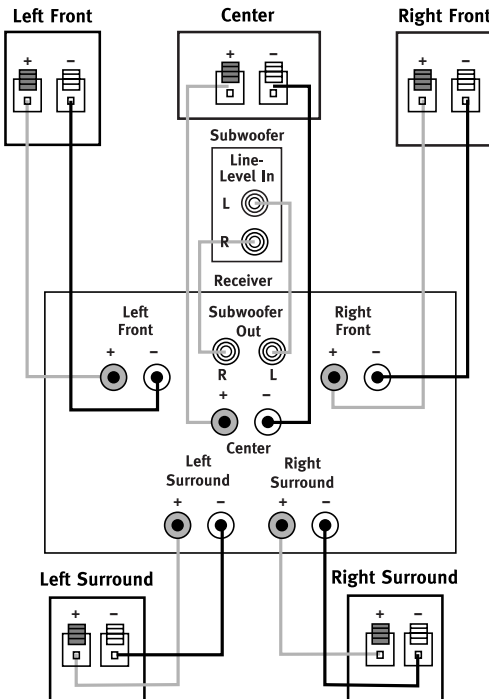

## DOLBY PRO LOGIC (NON-DIGITAL) – SPEAKER LEVEL

Use this installation method for Dolby Pro Logic applications (not Dolby Digital, DTS® or other digital processing), where the receiver/processor does not have a subwoofer output, or a volume-controlled preamp (line-) level output:

Connect your receiver or amplifier's front left and right speaker terminals to the left and right terminals on the subwoofer that are marked "Speaker Level In." Connect the left and right terminals on the subwoofer that are marked "Speaker Level Out" to the corresponding terminals on the back of your front left and right speakers.

Connect your receiver or amplifier's center and surround speaker terminals to the corresponding terminals on the back of your center and surround speakers.

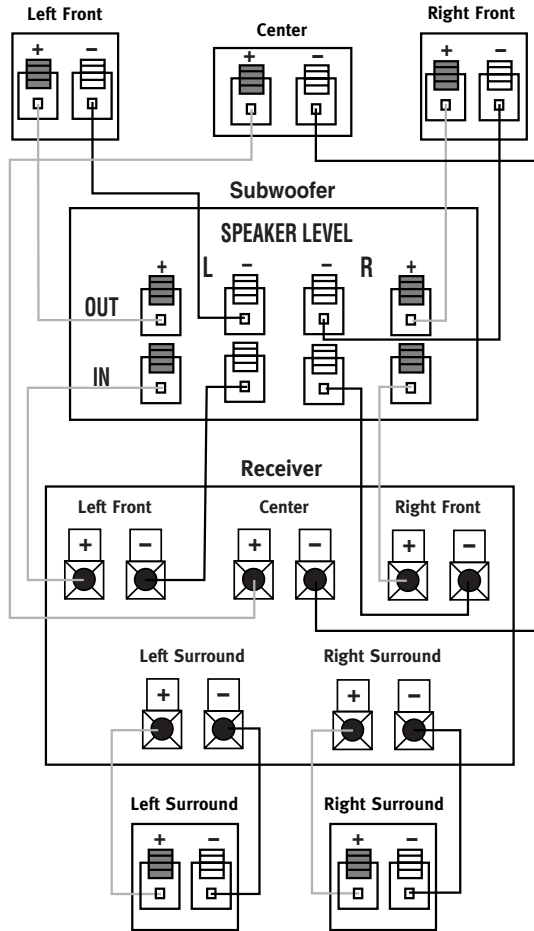



# OPERATION

Move the Master Power switch (marked "Power" **1**) to the "•" (On) position to use the subwoofer. The SUB145 subwoofer will automatically turn on or go into standby (sleep) mode when left in the auto mode ("Auto/On" switch

**2** in the "Auto" position). When your receiver or amplifier is off, or is not sending program material to the subwoofer, the subwoofer will be in standby mode (LED will be red). When the subwoofer senses an audio signal, it will

automatically turn on (LED will be green). If the subwoofer does not sense a signal after approximately twenty minutes, it will automatically go back into standby mode.

When the "Auto/On" switch **2** is switched to the "On" position, the subwoofer will remain on, whether or not program material is playing. If you will be away from home for an extended period of time, or if the subwoofer will not be used, switch the Master Power switch **1** to the Off position.

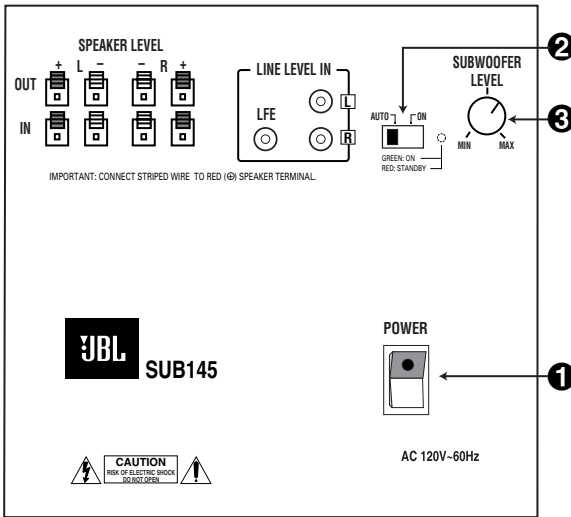

# VOLUME

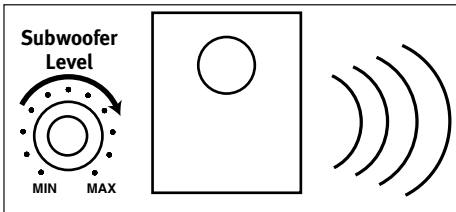

Volume may be adjusted using the Subwoofer Level control **3** as shown.

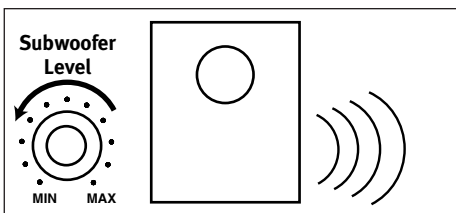

# TROUBLESHOOTING

## **If there is no sound from any of the speakers:**

- Check that receiver/amplifier is on and a source is playing.
- Check that the powered subwoofer is plugged in, and that its Power switch ❶ is switched on (“•” position).
- Check all wires and connections between receiver/amplifier and speakers. Make sure all wires are connected. Make sure none of the speaker wires are frayed, cut or punctured, or touching each other.
- Review proper operation of your receiver/amplifier.

## **If there is no sound coming from one speaker:**

- Check the “Balance” control on your receiver/amplifier.
- Check all wires and connections between receiver/amplifier and speakers. Make sure all wires are connected. Make sure none of the speaker wires are frayed, cut or punctured, or touching each other.
- In Dolby Digital or DTS modes, make sure that the receiver/processor is configured so that the speaker in question is enabled.
- Turn off all electronics and switch the speaker in question with one of the

other speakers that is working correctly. Turn everything back on, and determine whether the problem has followed the speaker, or has remained in the same channel. If the problem is in the same channel, the source of the problem is most likely with your receiver or amplifier, and you should consult the owner’s manual for that product for further information. If the problem has followed the speaker, consult your dealer for further assistance or, if that is not possible, visit [www.jbl.com](http://www.jbl.com) for further information.

## **If there is no sound from the center speaker:**

- Check all wires and connections between receiver/amplifier and speaker. Make sure all wires are connected. Make sure none of the speaker wires are frayed, cut or punctured, or touching each other.
- If your receiver/processor is set in Dolby Pro Logic mode, make sure the center speaker is not in phantom mode.
- If your receiver/processor is set in Dolby Digital or DTS modes, make sure the receiver/processor is configured so that the center speaker is enabled.

## **If the system plays at low volumes but shuts off as volume is increased:**

- Check all wires and connections between receiver/amplifier and speakers. Make sure all wires are connected. Make sure none of the speaker wires are frayed, cut or punctured, or touching each other.
- If more than one pair of main speakers is being used, check the minimum impedance requirements of your receiver/amplifier.

## **If there is low (or no) bass output:**

- Make sure the connections to the left and right “Speaker Inputs” have the correct polarity (+ and –).
- Make sure the subwoofer is plugged into an active electrical outlet, and is turned on (Power switch ❶ in the “•” position).
- In Dolby Digital or DTS modes, make sure your receiver/processor is configured so that the subwoofer and LFE output are enabled.

**If there is no sound from the surround speakers:**

- Check all wires and connections between receiver/amplifier and speakers. Make sure all wires are connected. Make sure none of the speaker wires are frayed, cut or punctured, or touching each other.
- Review proper operation of your receiver/amplifier and its surround sound features.
- Make sure the movie or TV show you are watching is recorded in a surround sound mode. If it is not, check to see whether your receiver/amplifier has other surround modes you may use.
- In Dolby Digital or DTS modes, make sure your receiver/processor is configured so that the surround speakers are enabled.
- Review the operation of your DVD player and the jacket of your DVD to make sure that the DVD features the desired Dolby Digital or DTS mode, and that you have properly selected that mode using both the DVD player's menu and the DVD disc's menu.

# SPECIFICATIONS

## SCS145.5 System

**Frequency Response**  
35Hz – 20kHz (–6dB)

### Satellites

**Recommended Power**

10 – 100 Watts

**Impedance**

8 Ohms nominal

**Sensitivity**

86dB @ 1 Watt/1 meter

**Tweeter**

One 1/2" (13mm) titanium-laminate dome, video-shielded

**Midrange**

One 3" (75mm) driver, video-shielded

**Dimensions (H x W x D)**

4-3/8" x 3-3/16" x 3-3/4"

111mm x 81mm x 95mm

**Weight**

1.1 lb/0.5kg

## Center

**Recommended Power**

10 – 100 Watts

**Impedance**

8 Ohms nominal

**Sensitivity**

86dB @ 1 Watt/1 meter

**Tweeter**

One 1/2" (13mm) titanium-laminate dome, video-shielded

**Midrange**

Dual 3" (75mm) drivers, video-shielded

**Dimensions (H x W x D)**

3-1/4" x 7-5/8" x 3-3/4"

83mm x 194mm x 95mm

**Weight**

1.89 lb/0.86kg

## Subwoofer

**Amplifier**

100 Watts RMS

**Woofer**

8" (200mm)

**Enclosure**

Bass reflex

**Dimensions (H x W x D)**

15" x 13" x 14"

381mm x 330mm x 356mm

**Weight**

30 lb/13.6kg

All features and specifications are subject to change without notice.

\*Trademarks of Dolby Laboratories.

DTS is a registered trademark of Digital Theater Systems, Inc.

<b>OWNER'S GUIDE</b>		<b>JBL</b>	<b>PRO SOUND COMES HOME™</b>
<b>PRODUCT LINE:</b> <b>SURROUND CINEMA SPEAKERS</b>		JBL Consumer Products 250 Crossways Park Drive, Woodbury, NY 11797 8500 Balboa Boulevard, Northridge, CA 91329 516.255.4JBL (4525) (USA only) www.jbl.com	
<b>MODEL:</b> <b>SCS145.5</b>		© 2004 Harman International Industries, Incorporated	
<b>DESIGN GOAL:</b> Bring the thrill of live performance and movie sound to the home environment by calling on JBL's professional engineering leadership.		JBL is a registered trademark of Harman International Industries, Incorporated.	
<b>SATELLITE TYPE:</b> Titanium-laminate-dome tweeter, sealed enclosure		Part No. 406-000-05100 	
<b>SUBWOOFER TYPE:</b> Bass-reflex enclosure		<b>H</b> A Harman International Company	
<b>PORT DESIGN:</b> FreeFlow™ flared			
<b>PROFESSIONAL REFERENCE:</b> Cinema Loudspeaker Series			

## Free Manuals Download Website

<http://myh66.com>

<http://usermanuals.us>

<http://www.somanuals.com>

<http://www.4manuals.cc>

<http://www.manual-lib.com>

<http://www.404manual.com>

<http://www.luxmanual.com>

<http://aubethermostatmanual.com>

Golf course search by state

<http://golfingnear.com>

Email search by domain

<http://emailbydomain.com>

Auto manuals search

<http://auto.somanuals.com>

TV manuals search

<http://tv.somanuals.com>