

# JVC®

# I'Art™

## Color Television Users Guide

**For Models:**  
**AV-32F577**  
**AV-27F577**  
**AV-32WF47**  
**AV-32MF47**  
**AV-27MF47**



*Illustration of AV-32F577 and RM-C1290G*

### **Important Note:**





In the spaces below, enter the model and serial number of your television (located at the rear of the television cabinet). Staple your sales receipt or invoice to the inside cover of this guide. Keep this user's guide in a convenient place for future reference. Keep the carton and original packaging for future use.

**Model Number:** \_\_\_\_\_

**Serial Number:** \_\_\_\_\_

LCT2033-001A-A  
0206TNH-II-IM

# Important Safety Precautions

	<b>CAUTION</b> <b>RISK OF ELECTRIC SHOCK</b> <b>DO NOT OPEN</b>	
<b>CAUTION:</b> To reduce the risk of electric shock. Do not remove cover (or back). No user serviceable parts inside. Refer servicing to qualified service personnel.		
	The lightning flash with arrowhead symbol, within an equilateral triangle is intended to alert the user to the presence of uninsulated "dangerous voltage" within the product's enclosure that may be of sufficient magnitude to constitute a risk of electric shock to persons.	
	The exclamation point within an equilateral triangle is intended to alert the user to the presence of important operating and maintenance (servicing) instructions in the literature accompanying the appliance.	

**WARNING:** TO PREVENT FIRE OR SHOCK HAZARDS, DO NOT EXPOSE THIS TV SET TO RAIN OR MOISTURE.

**CAUTION:** TO INSURE PERSONAL SAFETY, OBSERVE THE FOLLOWING RULES REGARDING THE USE OF THIS UNIT.

1. Operate only from the power source specified on the unit.
2. Avoid damaging the AC plug and power cord.
3. Avoid Improper installation and never position the unit where good ventilation is unattainable.
4. Do not allow objects or liquid into the cabinet openings.
5. In the event of trouble, unplug the unit and call a service technician. Do not attempt to repair it yourself or remove the rear cover.

Changes or modifications not approved by JVC could void the warranty.

- \* When you don't use this TV set for a long period of time, be sure to disconnect both the power plug from the AC outlet and antenna for your safety.
- \* To prevent electric shock do not use this polarized plug with an extension cord, receptacle or other outlet unless the blades can be fully inserted to prevent blade exposure.

## IMPORTANT RECYCLING INFORMATION

This product utilizes both a Cathode Ray Tube (CRT) and other components that contain lead. Disposal of these materials may be regulated in your community due to environmental considerations. For disposal or recycling information, please contact your local authorities, or the Electronic Industries Alliance: <http://www.eiae.org>



- As an “ENERGY STAR®” partner, JVC has determined that this product or product model meets the “ENERGY STAR®” guidelines for energy efficiency.

## Important Safeguards

### CAUTION:

#### Please read and retain for your safety.

Electrical energy can perform many useful functions. This TV set has been engineered and manufactured to assure your personal safety. But **improper use can result in potential electrical shock or fire hazards**. In order not to defeat the safeguards incorporated in this TV set, observe the following basic rules for its installation, use and servicing. Also follow all warnings and instructions marked on your TV set.

### INSTALLATION

- 1 Your TV set is equipped with a polarized AC line plug (one blade of the plug is wider than the other). This safety feature allows the plug to fit into the power outlet only one way. Should you be unable to insert the plug fully into the outlet, try reversing the plug. Should it still fail to fit, contact your electrician.
- 2 Operate the TV set only from a power source as indicated on the TV set or refer to the operating instructions for this information. If you are not sure of the type of power supply to your home, consult your TV set dealer or local power company. For battery operation, refer to the operating instructions.
- 3 Overloaded AC outlets and extension cords are dangerous, and so are frayed power cords and broken plugs. They may result in a shock or fire hazard. Call your service technician for replacement.
- 4 Do not allow anything to rest on or roll over the power cord, and do not place the TV set where power cord is subject to traffic or abuse. This may result in a shock or fire hazard.
- 5 Do not use this TV set near water — for example, near a bathtub, washbowl, kitchen sink, or laundry tub, in a wet basement, or near swimming pool, etc.
- 6 If an outside antenna is connected to the TV set, be sure the antenna system is grounded so as to provide some protection against voltage surges and built-up static charges. Section 810 of the National Electrical Code provides information with respect to proper grounding of the mast and supporting structure, grounding of the lead-in wire to an antenna discharge unit, size of grounding conductors, location of antenna discharge unit, connection requirements for the grounding electrode.

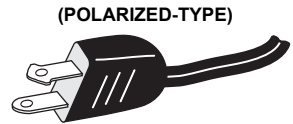

- 7 An outside antenna system should not be located in the vicinity of overhead power lines or other electric light or power circuits, or where it can fall into such power lines or circuits. When installing an outside antenna system, extreme care should be taken to keep from touching such power lines or circuits as contact with them might be fatal.

### EXAMPLE OF ANTENNA GROUNDING AS PER NATIONAL ELECTRICAL CODE

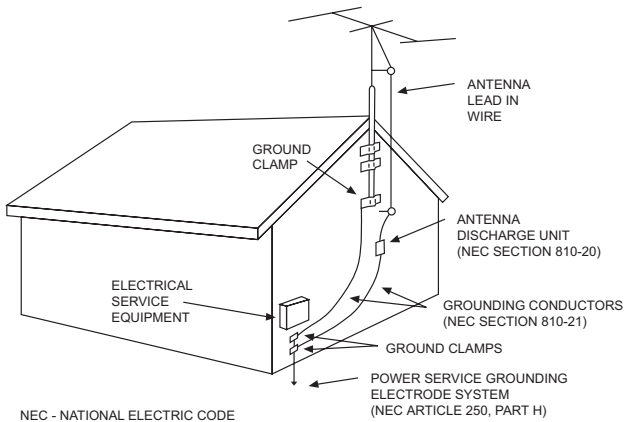

- 8 TV sets are provided with ventilation openings in the cabinet to allow heat generated during operation to be released.

#### Therefore:

- Never block the bottom ventilation slots of a portable TV set by placing it on a bed, sofa, rug, etc.
  - Never place a TV set in a “built-in” enclosure unless proper ventilation is provided.
  - Never cover the openings with a cloth or other material.
  - Never place the TV set near or over a radiator or heat register.
- 9 To avoid personal injury:
- Do not place a TV set on a sloping shelf unless properly secured.
  - Use only a cart or stand recommended by the TV set manufacturer.
  - Do not try to roll a cart with small casters across thresholds or deep pile carpets.
  - Wall or shelf mounting should follow the manufacturer’s instructions, and should use a mounting kit approved by the manufacturer.

## Use

- 10 Caution children about dropping or pushing objects into the TV set through cabinet openings. Some internal parts carry hazardous voltages and contact can result in a fire or electrical shock.
- 11 Unplug the TV set from the wall outlet before cleaning. Do not use liquid or an aerosol cleaner.
- 12 Never add accessories to a TV set that has not been designed for this purpose. Such additions may result in a hazard.



**PORTABLE CART WARNING**  
(Symbol provided by RETAC)

- 13 For added protection of the TV set during a lightning storm or when the TV set is to be left unattended for an extended period of time, unplug it from the wall outlet and disconnect the antenna. This will prevent damage to product due to lightning storms or power line surges.
- 14 A TV set and cart combination should be moved with care. Quick stops, excessive force, and uneven surfaces may cause the TV set and cart combination to overturn.

## Service

- 15 Unplug this TV set from the wall outlet and refer servicing to qualified service personnel under the following conditions:
  - A. When the power cord or plug is damaged or frayed.
  - B. If liquid has been spilled into the TV set.
  - C. If the TV set has been exposed to rain or water.
  - D. If the TV set does not operate normally by following the operating instructions. Adjust only those controls that are covered in the operating instructions as improper adjustment of other controls may result in damage and will often require extensive work by a qualified technician to restore the TV set to normal operation.
  - E. If the TV set has been dropped or damaged in any way.
  - F. When the TV set exhibits a distinct change in performance — this indicates a need for service.
- 16 Do not attempt to service this TV set yourself as opening or removing covers may expose you to dangerous voltage or other hazards. Refer all servicing to qualified service personnel.
- 17 When replacement parts are required, have the service technician verify in writing that the replacement parts he uses have the same safety characteristics as the original parts. Use of manufacturer's specified replacement parts can prevent fire, shock, or other hazards.
- 18 Upon completion of any service or repairs to this TV set, please ask the service technician to perform the safety check described in the manufacturer's service literature.
- 19 When a TV set reaches the end of its useful life, improper disposal could result in a picture tube implosion. Ask a qualified service technician to dispose of the TV set.
- 20 Note to CATV system installer.

This reminder is provided to call the CATV system installer's attention to Article 820-40 of the NEC that provides guidelines for proper grounding and, in particular, specifies that the cable ground shall be connected to the grounding system of the building, as close to the point of cable entry as practical.

# Table of Contents

<b>Quick Setup</b> . . . . .	<b>7</b>	<b>Button Functions</b> . . . . .	<b>43</b>
Unpacking your TV . . . . .	7	Power . . . . .	43
TV Models . . . . .	8	Number Buttons . . . . .	43
TV Remote Control . . . . .	9	Tune . . . . .	43
Getting Started . . . . .	10	Input . . . . .	43
The Remote Control . . . . .	10	Channel +/- . . . . .	43
Connecting Your Devices . . . . .	11	Volume +/- . . . . .	43
Interactive Plug In Menu . . . . .	16	Return+/TV . . . . .	44
<b>Onscreen Menus</b> . . . . .	<b>19</b>	Sound . . . . .	44
Using the Guide . . . . .	19	Muting . . . . .	44
Onscreen Menu System . . . . .	20	Video Status . . . . .	45
<b>Initial Setup</b> . . . . .	<b>22</b>	TheaterPro D6500K . . . . .	45
Noise Muting . . . . .	22	Sleep Timer . . . . .	45
Language . . . . .	22	Display . . . . .	46
Front Panel Lock . . . . .	22	C.C. . . . .	46
V-Chip . . . . .	23	Aspect . . . . .	47
Closed Caption . . . . .	30	Aspect Ratios . . . . .	47
Auto Shut Off . . . . .	32	Favorite . . . . .	49
Software Version . . . . .	32	ML/MTS . . . . .	50
<b>Tuner Setup</b> . . . . .	<b>33</b>	Menu . . . . .	50
Auto Tuner Setup . . . . .	33	OK . . . . .	50
Channel Summary . . . . .	33	Back . . . . .	50
Find Channel . . . . .	34	DVD Buttons . . . . .	51
Digital Antenna Level . . . . .	35	Sub Channel . . . . .	51
<b>External Input</b> . . . . .	<b>36</b>	Guide . . . . .	51
Video Input Label . . . . .	36	Game . . . . .	51
<b>Picture Adjust</b> . . . . .	<b>37</b>	<b>Troubleshooting</b> . . . . .	<b>52</b>
Picture Settings . . . . .	37	<b>Specifications</b> . . . . .	<b>53</b>
Adjust Picture Settings . . . . .	37	<b>Warranty</b> . . . . .	<b>54</b>
Color Temperature . . . . .	37	<b>Authorized Service Centers</b> . . . . .	<b>55</b>
VSM . . . . .	38		
Reset . . . . .	38		
<b>Sound Adjust</b> . . . . .	<b>39</b>		
Sound Settings . . . . .	39		
Adjust Sound Settings . . . . .	39		
Optical Out . . . . .	39		
Turn On Volume . . . . .	40		
Volume Limit . . . . .	40		
Reset . . . . .	40		
<b>Clock Timers</b> . . . . .	<b>41</b>		
Set Clock . . . . .	41		
On/Off Timer . . . . .	42		

## Unpacking your TV

Thank you for your purchase of a JVC Color Television. Before you begin setting up your new television, please check to make sure you have all of the following items. In addition to this guide, your television box should include:

1 Television

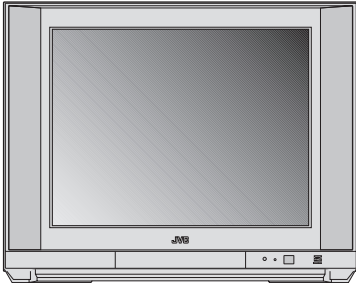

1 Remote Control



Two AA Batteries



**Note: Your television and/or remote control may differ from the examples illustrated here.**

We recommend that before you start using your new television, you read your entire User's Guide so you can learn about your new television's many great features. If you're anxious to start using your television right away, a quick setup guide follows on the next few pages.

# Quick Setup

## TV Models

Before you connect your television to another device, please refer to the proper diagrams for your specific TV and remote. These will help assist you in understanding how to connect your television to another device, as well as use the remote to set up your television.

## Rear panel diagram

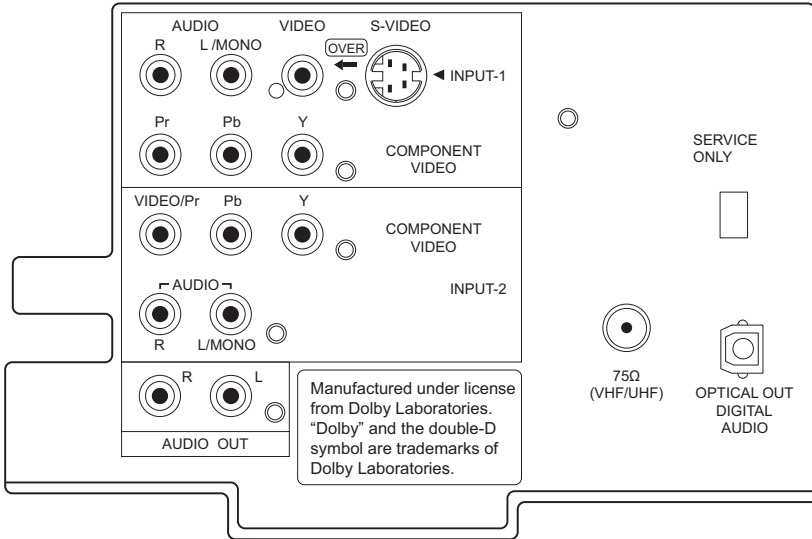

### Notes:

- The terminal labeled "SERVICE ONLY", is exclusively used to update the software version.
- There is the component Y/Pb/Pr terminal on INPUT-1 only for AV-32WF47.

## Front panel diagram

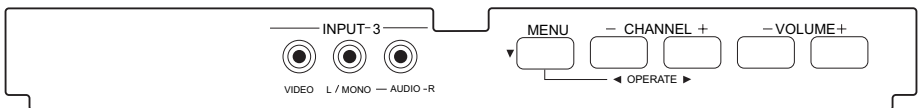



## Remote Control

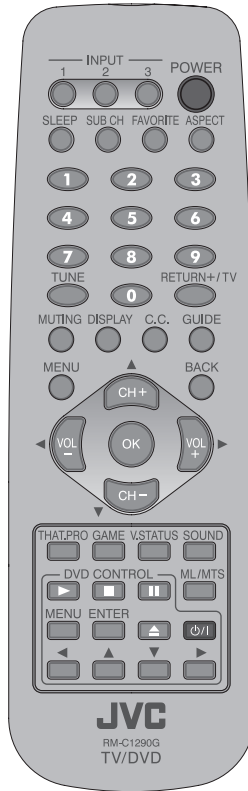

## RM-C1290G

- For information on remote control buttons, see pages 43 - 51.
- DVD CONTROL can only be used with JVC-brand DVDs.

## Getting Started

These quick setup pages will provide you, in three easy steps, with the basic information you need to begin using your new television right away. If you have questions, or for more detailed information on any of these steps, please consult other sections of this manual.

### Step 1 – The Remote Control

Before you can operate your remote control, you first need to install the batteries (included).

Raise the latch on the remote's back cover to remove. Insert two batteries, carefully noting the "+" and "-" markings, and place the "-" end in the remote first. Snap the cover back into place.

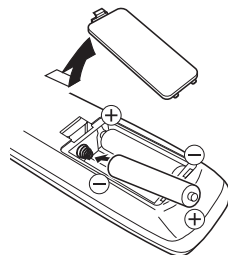

### Key Feature Buttons

The four key feature buttons at the center of the remote can be used for basic operation of the television. The top and bottom buttons will scan forward and back through the available channels. To move rapidly through the channels using JVC's **Hyperscan** feature, press and hold CH+ or CH-. The channels will zip by at a rate of about four channels per second. The right and left buttons will turn the volume up or down. These buttons are also marked with four arrows and are used with JVC's onscreen menu system. To use the onscreen menus, press the MENU button.

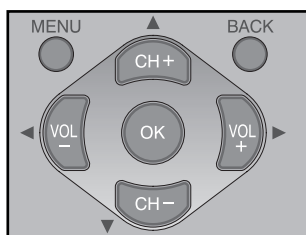

### Basic Operation

Turn the television on and off by pressing the POWER button at the top right corner of the remote. If this is the first time you are turning on the TV, the interactive plug-in menu appears.



## Step 2 – Connecting Your Devices

To make these connections, you will use plugs like the ones illustrated below.

### Coaxial Cables



Used to connect an external antenna or cable TV system to your TV.

### S-Video Cable



Used to make video connections with S-Video VCRs, Camcorders and DVD players.

### Component Cables Composite Cables Audio Cables



Used to connect audio/video devices like VCRs, DVD players, stereo amplifiers, game consoles, etc.

#### Notes:

- These connections are examples.
- After you are finished connecting your devices, plug the power cord into the nearest power outlet and turn on the TV.
- If you follow these diagrams and the television does not work properly, contact your local cable operator.
- To connect a DVD player, see VCR Connection. A DVD player is optional.
- If you have a satellite television system, refer to the satellite TV manual.

### No VCR Connection

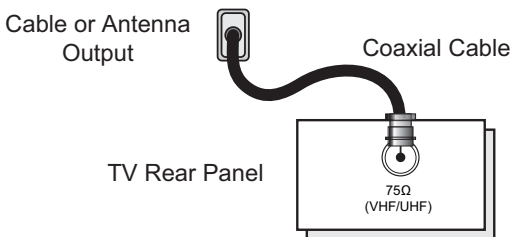

## VCR Connection

### Notes:

- Green, blue and red are the most common colors for DVD cables. Some models may vary colors. Please consult the user's manual for your DVD player for more information.
- Be careful not to confuse the red DVD cable with the red audio cable. It is best to complete one set of connections (DVD or audio output) before starting the other to avoid accidentally switching the cables.
- You may also connect the DVD player to Input 1.

### Diagram #1

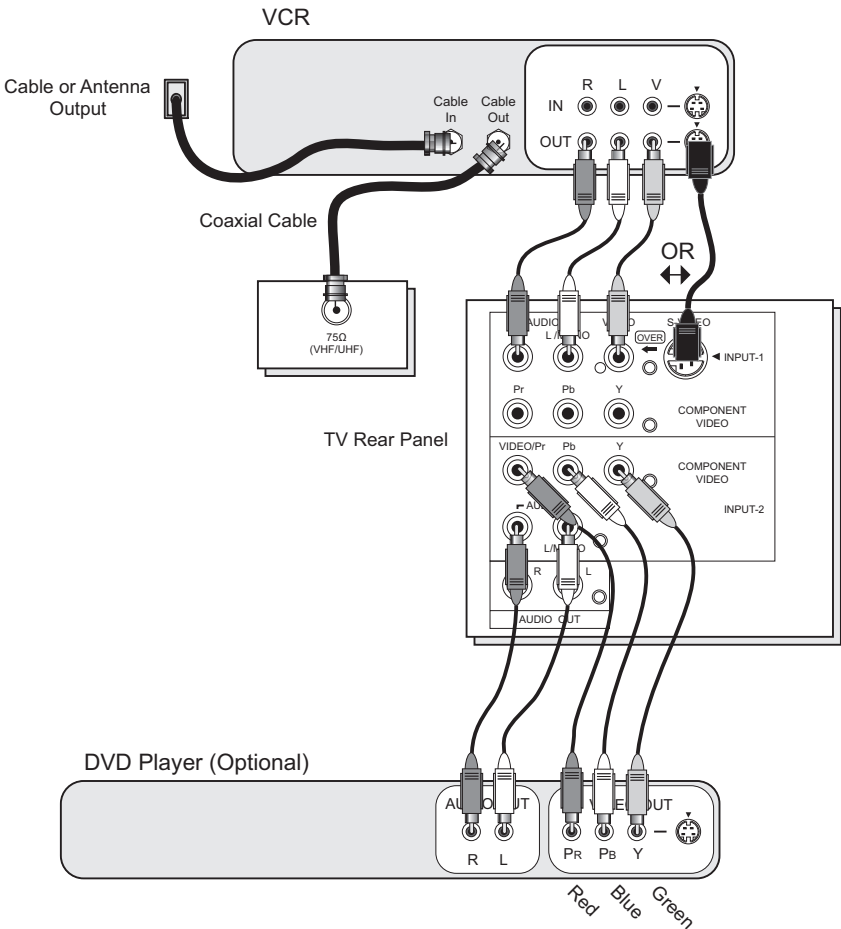

### Note:

- If this connection setup does not work for you, try the connection setup on page 13.

Diagram #2

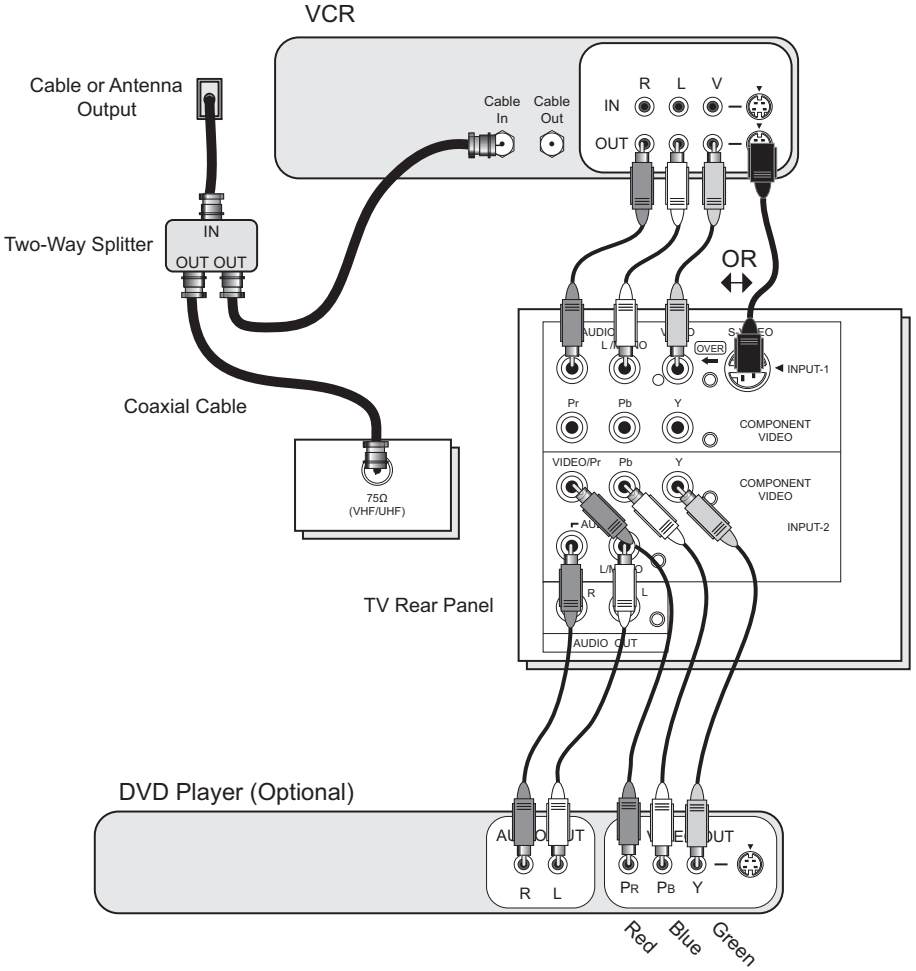

## Connecting to a Camcorder

You may connect a camcorder, game console or other equipment to your television by using the front input jacks (Input 3) located under the front panel door. To access, push on the door to open it. You can also connect these using the television's rear input jacks, using the same instructions.

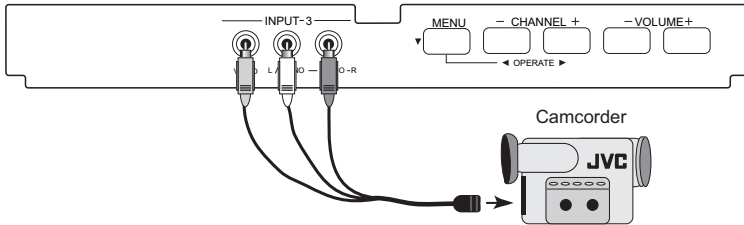

- 1) Connect a yellow composite cable from the camcorder VIDEO OUT, into the VIDEO IN on the front of the TV.
- 2) Connect a white composite cable from the camcorder LEFT AUDIO OUT, into the LEFT AUDIO IN on the front of the TV.
- 3) Connect a red composite cable from the camcorder RIGHT AUDIO OUT, into the RIGHT AUDIO IN on the front of the TV.

### Note:

- If your camcorder is a mono sound model it will have only one AUDIO OUT. Connect it to the LEFT AUDIO IN.

## Connecting to an External Amplifier

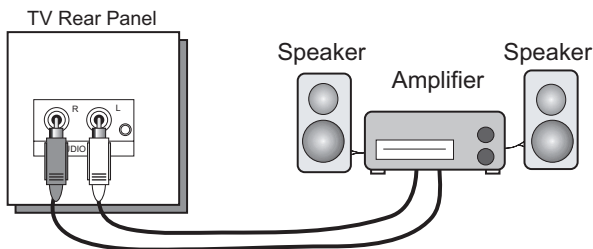

- 1) Connect a white composite cable from the LEFT AUDIO OUTPUT on the back of the TV to the LEFT AUDIO INPUT on the amplifier.
- 2) Connect a red composite cable from the RIGHT AUDIO OUTPUT on the back of the TV to the RIGHT AUDIO INPUT on the amplifier.

### Notes:

- Refer to your amplifier's manual for more information.
- You can use AUDIO OUTPUT for your home theater system.

## Connecting to an amplifier using your optical output

You can connect an amplifier that has an optical digital input terminal by using an optical digital cable from the optical output. The signal that is output can be PCM or Dolby Digital.

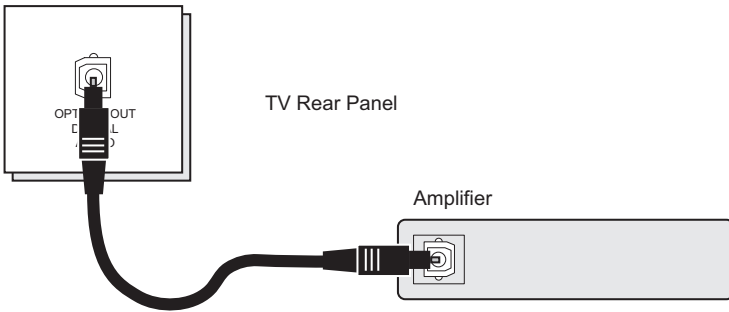

- 1) Connect the optical cable from the back of the TV to the back of the amplifier.

**Notes:**

- This terminal can only output digital audio.
- In order to use the optical output connection, select "PCM" or "Dolby Digital" on "Optical Out" in Sound Adjust. See page 39.
- Refer to your owners manual on using your amplifier.

### Step 3 – The Interactive Plug In Menu

The interactive plug-in menu appears only for AV-27F577, AV-32F577 and AV-32WF47. If your television is one of the other models, we recommend you complete the Auto Tuner Setup to begin watching your television right away. See pages 22, 41 and 33.

When you turn your television on for the first time the interactive plug-in menu will appear. The plug-in menu helps you to get your TV ready to use by letting you set your preferences for:

- The language in which you want the onscreen menus to appear.
- Setting the TV's clock to the correct time so your timer functions will work properly. You can choose "Auto" or "Manual" for setting the clock.
- The auto tuner setup of which channels you wish to receive.

We recommend you complete the interactive plug-in items before you start using your television.

**Note:**

- If you press the MENU button while setting up the interactive plug-in menu, it will skip over it.

## Language

After the "JVC Interactive Plug-in Menu" has been displayed, the TV automatically switches to the "Language" settings. You can choose to view your onscreen menus in three languages: English, French (Français) or Spanish (Español).

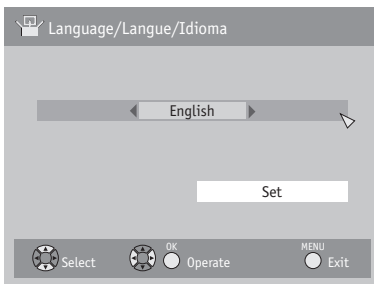

To choose a language:  
(English, Français or Español)



To "Set"



Press the Ok button

Once you press Ok, you will move to the "Set Clock" Plug-In Menu automatically.

**(To be continued...)**



## Auto Clock Set

Before you use any of your TV's timer functions, you must first set the clock. You may precisely set your clock using the XDS time signal broadcast by most public analog broadcasting stations. If you do not have this in your area, you will have to set the clock manually. See manual clock set below. To set the clock using the XDS signal:

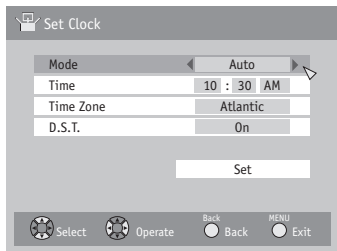

- ◀▶ To choose "Auto"
  - ▼ To "Time Zone"
  - ◀▶ To select your time zone: (Atlantic, Eastern, Central, Mountain, Pacific, Alaska or Hawaii)
  - ▼ To move to "D.S.T." (Daylight Savings Time)
  - ◀▶ To turn "On or Off"
  - ▼ To "set"
  - ☑ Press the Ok button
- Once you press Ok, you will move to the "Auto Tuner Setup" Plug-In Menu automatically.*

### Notes:

- D.S.T. can be used when it is set to "On" in the "Set Clock" menu.
- Only when the "Mode" is set to "Auto", the Daylight Savings Time feature automatically adjusts your TV's clock for Daylight Savings. The clock will move forward one hour at 2:00 am on the first Sunday in April. The clock will move back one hour at 2:00 am on the last Sunday in October.
- You will have to reset the clock after a power interruption. You must set the clock before operating any timer functions.

## Manual Clock Set

To set your clock manually (without using the XDS signal), choose "Manual". If you choose "Auto", see auto clock set above.

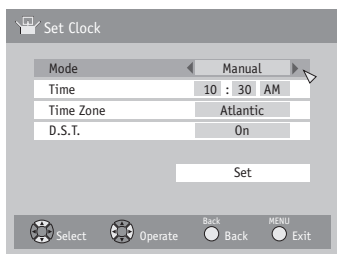

- ◀▶ To choose "Manual"
  - ▼ To "Time"
  - ◀▶ To set the hour
  - ▼ To minute
  - ◀▶ To set the minute
  - ▼ To "Time Zone"
  - ◀▶ To select your time zone: (Atlantic, Eastern, Central, Mountain, Pacific, Alaska or Hawaii)
  - ▼ To move to "D.S.T." (Daylight Savings Time)
  - ◀▶ To turn "On or Off"
  - ▼ To "Set"
  - ☑ Press the Ok button
- Once you press Ok, you will move to the "Auto Tuner Setup" Plug-In Menu automatically.*

### Note:

- You will have to reset the clock after a power interruption. You must set the clock before operating any timer functions.

**(To be continued...)**

## Auto Tuner Setup

In auto tuner setup, the TV automatically scans through all available channels, memorizing the active ones and skipping over blank ones or channels with weak signals. This means when you scan (using the CHANNEL +/- buttons) you will receive only clear, active channels.

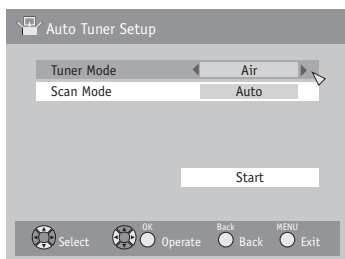

To choose "Cable or "Air" (or "Skip" when you skip "Auto Tuner Setup")



To "Start"



Press the Ok button

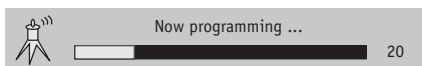

When the setup is finished, "Thank you ! Setup is now complete." is displayed. Your quick setup is now complete. You can now begin watching your television, or you can continue on in this guide for more information on programming your remote control, or using the JVC onscreen menu system to customize your television viewing experience.

### Notes:

- If you want to cancel the Auto Tuner Setup, press the MENU button.
- Noise muting will not work during Auto Tuner Setup.
- If you choose "Skip", it finished without doing the Auto Tuner Setup.

**Cable Box and Satellite Users:** After your auto tuner setup is complete, you may, (depending on the type of hookup), have only 1 channel, usually 3 or 4 in the auto tuner memory. This is normal.



## The Quick Setup is complete

# Onscreen Menus

## Using the Guide

Certain symbols are used throughout this guide to help you learn about the features of your new television. The ones you will see most frequently are:

- ▲▼ Up and Down arrows mean press the CH+ or CH- buttons. Pressing the CH+ or CH- buttons let you:
  - Move vertically in a main menu screen
  - Move through a submenu screen
  - Move to the next letter, number, or other choice in a submenu
  - Back up to correct an error
  - Scan through TV channels (when not in a menu screen)
- ◀▶ Left and right arrows mean press the VOLUME+ or VOLUME- buttons to move left or right to:
  - Select a highlighted menu item
  - Select an item in a submenu
  - Select numbers in certain menu options
  - Turn the volume up or down (when not in a menu screen)



The “press button” icon means you should press the button named on your remote control. (Button names appear in SMALL CAPITAL LETTERS.)



The “helping arrow” icon points to the highlighted or selected item in a menu.

**To bring up the onscreen menu**, press the MENU button on the remote control. The following (left) main menu will appear. The item that appears in green is the one currently selected. If you use the MENU button on the TV's front panel instead of the remote, Front Menu screen showing "Input", "Video Status", "Aspect" and "Menu" will appear (following right screen). The “interactive plug-in menu” will appear the first time the TV is plugged in (AV-27F577, AV-32F577 and AV-32WF47 ONLY).

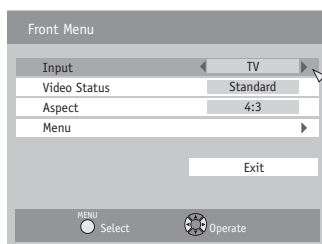
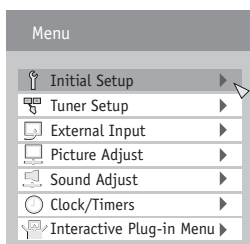

### Note:

- Menus shown in this book are illustrations, not exact replications of the television's onscreen displays.

# Onscreen Menus

## The Onscreen Menu System

Your television comes with JVC's onscreen menu system. The onscreen menus let you make adjustments to your television's operation simply and quickly. All menus are navigated from the Main Menu at first. Detailed explanations on using each menu follow later in this guide. For information about the interactive plug-in Menu, see pages 16 - 18. (AV-27F577, AV-32F577 and AV-32WF47 ONLY).

1. To open the onscreen menu system, press the MENU button on the remote control. The main menu will appear

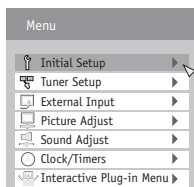

2. To select a menu from the main menu, use the ▲▼ arrows and enter by using the ◀▶ arrows or Ok button. See page 21.

The selected feature and option on a menu screen are highlighted in a different color. To move to a different feature, use the ▲▼ arrows to move up and down the list.

3. There are two methods to select an option in a menu, after selecting a menu using the ▲▼ arrows.

- 1) Use the ◀▶ arrows to select an option from the highlighted feature. (In this guide, we discuss this method).
- 2) Press the Ok button. The right onscreen will appear. Use the ▲▼ arrows to select an option from the box and press the Ok button.

- To go back to the previous screen, press the BACK button.

4. Pressing MENU on the remote control will close the onscreen menu system and return you to normal television viewing.

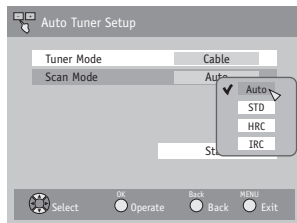

Each menu and its features will be discussed in the following pages of this guide.

### Notes:

- If you do not press any buttons for a few seconds, the onscreen menu will automatically shut off.
- Button names in this guide are shown in SMALL CAPITAL LETTERS.
- Menus may appear in different sizes onscreen depending on the aspect ratio selected.
- Some menu items may not appear in menu screens when certain aspect ratios or inputs are selected.

# Onscreen Menus

From the  
Main Menu...

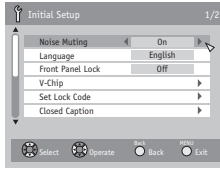
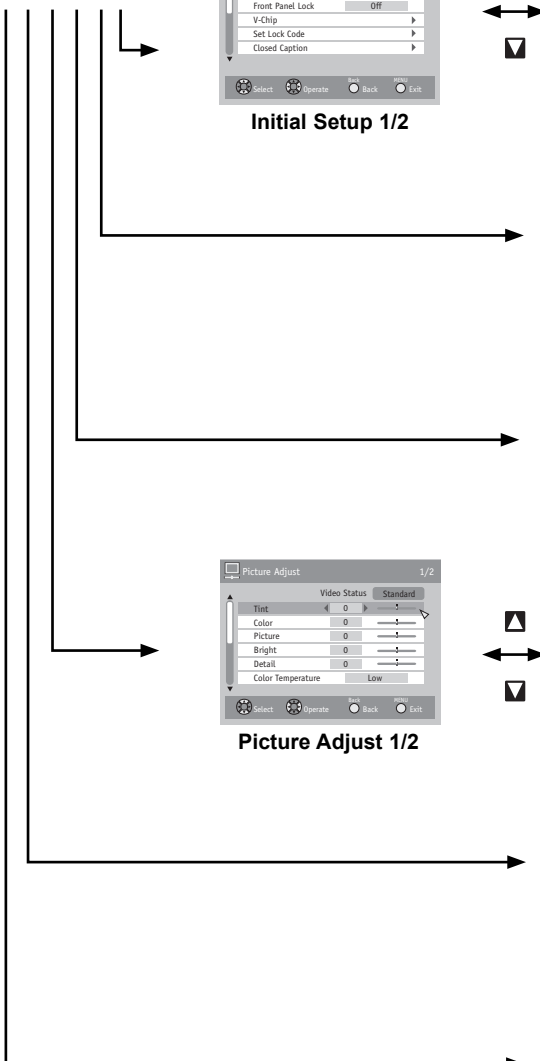

**Initial Setup 1/2**

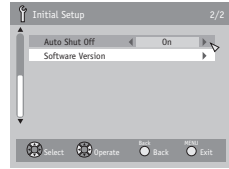

**Initial Setup 2/2**

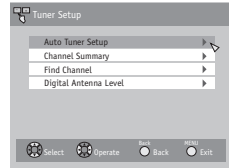

**Tuner Setup**

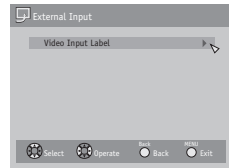

**External Input**

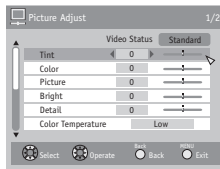

**Picture Adjust 1/2**

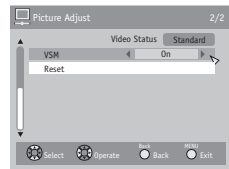

**Picture Adjust 2/2**

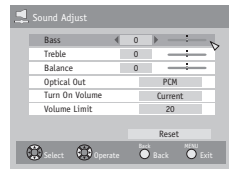

**Sound Adjust**

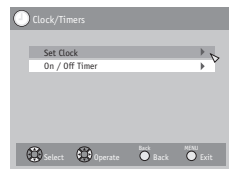

**Clock/Timers**

- For the Interactive Plug-In Menu, see page 16.
- "Video Input Label" is only for models AV-27F577 and AV-32F577.

If your TV is model AV-27MF47, AV-32MF47 or AV-32WF47, "External Input" menu screen will not be displayed.

# Initial Setup

## Noise Muting

This feature inserts a blank gray screen over channels which are not broadcasting or are too weak to be received clearly.



Press the MENU button



To "Initial Setup"



To enter



To "Noise Muting"



To turn "On" or "Off"



Press the MENU button when finished

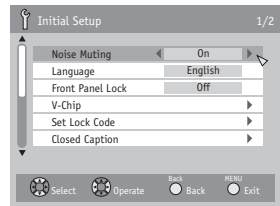

### Note:

- Noise muting will not work during auto tuner setup or when you operate channel summary.
- Noise muting will not work when the digital TV is displayed.

## Language

The language function is described on page 16 as the interactive plug-in menu (AV-27F577, AV-32F577 and AV-32WF47 ONLY). If you need to choose the language again, follow the steps below.



Press the MENU button



To "Initial Setup"



To enter



To "Language"



To choose a language: English, Français or Español



Press the MENU button when finished

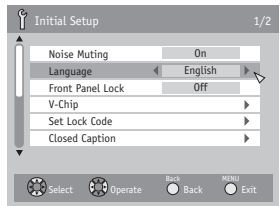

## Front Panel Lock

This allows you to lock the keys on the front of the TV, so that a child may not accidentally change your viewing preferences.



Press the MENU button



To "Initial Setup"



To enter



To "Front Panel Lock"



To turn "On" or "Off"



Press the MENU button when finished

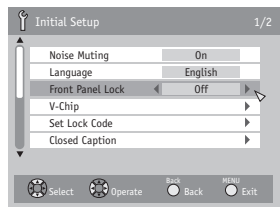

You can turn off this feature in the following ways:

- Unplug the power cord, and plug it back in. Do this if your batteries die, or you lose your remote control.
- Use the remote control.
- Press the MENU button on the front of the TV for more than 3 seconds. In this case, the OSD for "Front Panel Lock" will appear.

### Note:

- To turn ON/OFF the TV, press the POWER button for more than 3 seconds. This feature will remain ON.

# Initial Setup

## V-Chip

Your TV is equipped with V-Chip technology which enables you to block channels or content that you feel to be inappropriate for children, based on US and Canada rating guidelines. V-Chip has no effect on video signals from a DVD discs, VCR tapes or Camcorder connection.

**Note:** Some programs, and movies are broadcast without a ratings signal. Even if you set up V-CHIP ratings limits, these programs will not be blocked. See page 28 for information on how to block unrated programs.

**Note (for Canadian viewers):** The V-Chip function is based on specifications designed for the United States and therefore may not work properly in Canada.

You can customize the V-Chip settings of your television to match your personal tastes. The V-Chip menu below is the starting point for your V-Chip settings

You can use US V-Chip settings (for programming broadcast from the United States), Canadian V-Chip settings (for programming broadcast from Canada), and movie ratings. You may use any or all of the settings (US V-Chip, Canada V-Chip, Movie ratings). Descriptions for setting each of the three V-Chip formats appear in the next six pages along with descriptions of the rating categories.

To access the rating categories:



Press the MENU button



To "Initial Setup"



To enter



To "V-Chip"



To operate (Password input screen will appear)



Enter the password by using the 10 button keypad

*The V-Chip main screen will appear when the password is correct.*



To turn V-Chip "On" or "Off" (V-Chip must be turned "On" for rating settings to operate)



To move to V-Chip menu (see following pages for descriptions of each item)

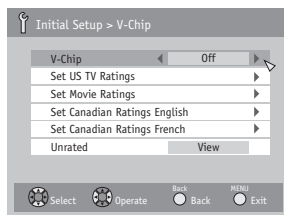

### Notes:

- If you input the wrong password, go back to the initial Setup Menu.
- To set the password, see "Set Lock Code", page 29.
- "Advanced V-Chip Rating" and "Advanced Canadian Rating" menus may be displayed sometimes between "Set Canadian Ratings French" and "Unrated". These menus are reserved for future use, as of February 2006.

# Initial Setup

## US V-Chip Ratings

### U.S. PARENTAL RATING SYSTEMS

Programs with the following ratings are appropriate for children.

**TV Y is Appropriate for All Children**

Programs are created for very young viewers and should be suitable for all ages, including children ages 2 - 6.

**TV Y7 is for Older Children**

Most parents would find such programs suitable for children 7 and above. These programs may contain some mild fantasy violence or comedic violence, which children should be able to discern from reality.

Programs with the following ratings are designed for the entire audience.

**TV G stands for General Audience**

Most parents would find these programs suitable for all age groups. They contain little or no violence, no strong language, and little or no sexual dialog or situations.

**TV PG Parental Guidance Suggested**

May contain some, but not much, strong language, limited violence, and some suggestive sexual dialog or situations. It is recommended that parents watch these programs first, or with their children.

**TV 14 Parents Strongly Cautioned**

Programs contain some material that may be unsuitable for children under the age of 14 including possible intense violence, sexual situations, strong coarse language, or intensely suggestive dialog. Parents are cautioned against unattended viewing by children under 14.

**TV MA Mature Audiences Only**

These programs are specifically for adults and may be unsuitable for anyone under 17 years of age. TV MA programs may have extensive V, S, L, or D.

### Viewing Guidelines

In addition to the ratings categories explained above, information on specific kinds of content are also supplied with the V-Chip rating. These types of content may also be blocked. The content types are:

- **V/FV** is for VIOLENCE/FANTASY VIOLENCE
- **S** stands for SEXUAL CONTENT
- **L** stands for strong LANGUAGE
- **D** stands for suggestive DIALOG



# Initial Setup

## Setting US V-Chip Ratings



Press the MENU button



To "Initial Setup"



To enter



To "V-Chip"



To operate (Password input screen will appear)



Enter the password by using the 10 button keypad

*The V-Chip main screen will appear*



To turn V-Chip "On" or "Off"



To move to "Set US TV Ratings"



To operate

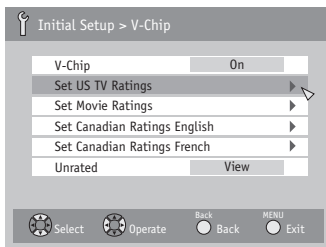

## Directions to set US V-Chip Ratings

Line up the cursor in the column (TV PG, TV G, etc.) with the content row (V/FV, S, etc.) and press the ▲▼ or ◀▶ to move the cursor to the correct location. Press Ok to turn the locking feature on or off. An item is locked if the  icon appears instead of a "—".

**For example.** To block viewing of all TV 14 shows, move the cursor to the top row of that column and add a lock icon. Once you've put a lock on the top row, everything in that column is automatically locked.



To the TV 14 Column



Press the Ok button to lock



Press the MENU button when finished

### Note:

- If you want to change the setup, move the cursor to the top column and change the lock icon to "—" by pressing Ok again. You may then select individual categories to block.

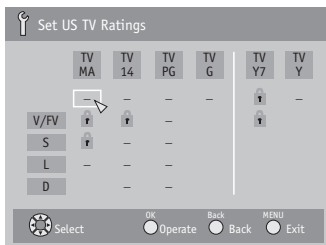

# Initial Setup

## Movies Ratings

### NR – Not Rated

This is a film which has no rating. In many cases these films were imported from countries which do not use the MPAA ratings system. Other NR films may be from amateur producers who didn't intend to have their film widely released.

**NR (Not Rated) Programming may contain all types of programming including children's programming, foreign programs, or adult material.**

### G – General Audience

In the opinion of the review board, these films contain nothing in the way of sexual content, violence, or language that would be unsuitable for audiences of any age.

### PG – Parental Guidance

Parental Guidance means the movie may contain some contents such as mild violence, some brief nudity, and strong language. The contents are not deemed intense.

### PG-13 – Parents Strongly Cautioned

Parents with children under 13 are cautioned that the content of movies with this rating may include more explicit sexual, language, and violence content than movies rated PG.

### R – Restricted

These films contain material that is explicit in nature and is not recommended for unsupervised children under the age of 17.

### NC-17 – No One Under 17

These movies contain content which most parents would feel is too adult for their children to view. Content can consist of strong language, nudity, violence, and suggestive or explicit subject matter.

### X – No One under 18

Inappropriate material for anyone under 18.

## Directions to set Movie (MPAA) Ratings



Press the MENU button



To "Initial Setup"



To enter



To "V-Chip"



To operate (Password input screen will appear)



Enter the password by using the 10 button keypad

*The V-Chip main screen will appear*



To turn V-Chip "On" or "Off"



To "Set Movie Ratings"



To enter movies menu

### **For example:**

To block viewing of X and NC-17 rated from shows:



To the X Column



Press the Ok button to lock



To the NC-17 Column



Press the Ok button to lock



Press the MENU button to finish

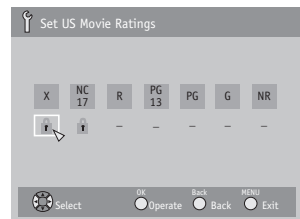

## Canadian V-Chip Ratings

### **E – Exempt**

Exempt programming includes: news, sports, documentaries and other information programming, talk shows, music videos, and variety programming.

### **C – Programming Intended for Children**

Violence Guidelines: There will be no realistic scenes of violence. Depictions of aggressive behavior will be infrequent and limited to portrayals that are clearly imaginary, comedic or unrealistic in nature.

### **C8+ – Programming Intended for Children 8 and Over**

Violence Guidelines: Any realistic depictions of violence will be infrequent, discreet, of low intensity and will show the consequences of the acts. There will be no offensive language, nudity or sexual content.

### **G – General Audience**

Programming will contain little violence and will be sensitive to themes which could affect younger children.

### **PG – Parental Guidance**

Programming intended for a general audience, but which may not be suitable for younger children. Parents may consider some content not appropriate for children aged 8-13.

### **14+ – 14 Years and Older**

Parents are strongly cautioned to exercise discretion in permitting viewing by pre-teens and early teens. Programming may contain mature themes and scenes of intense violence.

### **18+ – Adult**

Material intended for mature audiences only.

## Directions to set Canadian V-Chip Ratings



Press the MENU button



To "Initial Setup"



To enter



To "V-Chip"



To operate (Password input screen will appear)



Enter the password by using the 10 button keypad

*The V-Chip main screen will appear*



To turn V-Chip "On" or "Off"



To "Set Canadian Ratings English"



To enter ratings menu

### **For example:**

To block viewing of programming rated 14+ and 18+:



To the 18+ Column



Press the Ok button to lock



To the 14+ Column



Press the Ok button to lock



Press the MENU button to finish



# Initial Setup

## Unrated Programs

Unrated programming refers to any programming which does not contain a rating signal. Programming on television stations which do not broadcast rating signals will be placed in the "Unrated Programming" category.

Examples of Unrated programs:

- Emergency Bulletins
- News
- Public Service Announcements
- Sports
- Some Commercials
- Locally Originated Programming
- Political Programs
- Religious Programs
- Weather

### Note:

- TV programs or movies that do not have rating signals will be blocked if the unrated category is set to "Block".

## Directions to Block Unrated Programs

You can block programs that are not rated.



Press the MENU button



To "Initial Setup"



To enter



To "V-Chip"



To operate (Password input screen will appear)



Enter the password by using the 10 button keypad

*The V-Chip main screen will appear*



To turn V-Chip "On" or "Off"



To "Unrated"



To "View" or "Block"



Press MENU when done

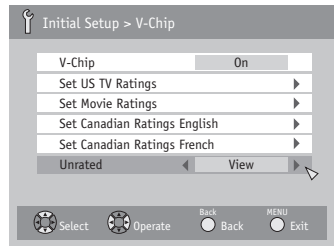

# Initial Setup

## Set Lock Code

Channel guard and V-Chip settings are protected by a four-digit lock code. Your TV comes pre-set with a lock code of "0000". You may change the code to any four-digit number you wish. To change the lock code, follow the steps below.



Press the MENU button



To "Initial Setup"



To enter



To "Set Lock Code"



To operate (Password input screen will appear)



Enter the password by using the 10 button keypad

*The Set Lock Code screen will appear*



To set the password, use the 10 button keypad



Press the Ok button to finish (your lock code is now set)

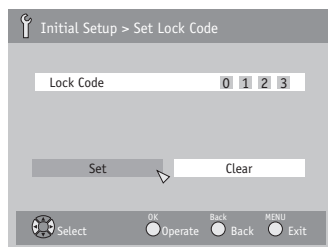

When a viewer attempts to watch a blocked channel, this message appears:

The channel will remain blocked until the correct lock code is entered (see above for information on setting your lock code).

This programming exceeds  
your rating limits.  
Please enter lock code by  
10 key pad to unlock it.  
No. - - - -

### Notes:

- After a power interruption you must reset the lock code.
- Write your lock code number down and keep it hidden from potential viewers.
- If you forget the lock code, a new code may be set using the steps listed above.

## Channel Guard Message

When a viewer attempts to watch a guarded channel, the following message appears:

To watch a channel that you have locked, enter the Lock Code using the 10 key pad.

If the wrong code is entered, the message "invalid lock code !" will flash on the screen.

The channel cannot be accessed until the correct code is entered.

### Notes:

- Once a channel has been unlocked, it will remain unlocked until the television is turned off.
- See also "Set Lock Code", page 29.

This channel is locked by  
channel guard.  
Please enter lock code by  
10 key pad to unlock it.

No. - - - -

# Initial Setup

## Closed Caption

Many broadcasts now include an onscreen display of dialog called closed captions. Some broadcasts may also include displays of additional information in text form. Your television can access and display this information using the closed caption feature. To activate the closed caption feature, follow the steps below.

### Auto Setting



Press the MENU button



To "Initial Setup"



To enter



To "Closed Caption"



To enter



To "Type"



To select Auto, Advanced or Basic

**Auto:** Shows closed caption a priority for digital channels over analog channels. It is set automatically.

**Advanced:** Shows only the digital closed caption.

**Basic:** Shows only the analog closed caption.



To "Analog Service"



To select a caption (CC1 to CC4) or text channel (Text1 to Text4)



To "Digital Service"



To select 1, 2, 3, 4, 5 or 6



To Appearance



To enter



To select "Auto" ("Manual", see page 32)



Press the MENU button when finished

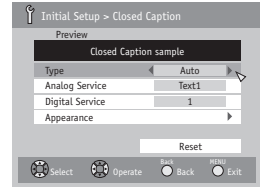

### Notes:

- If you want to reset your settings to the default settings, select "Reset".
- If you select "Advanced" for Type, you cannot select "Analog Service".
- If you select "Basic" for Type, you cannot select "Digital Service" and "Appearance".

# Initial Setup

## Manual Setting

- ◀▶ To select "Manual" for Appearance
- ▲▼ To "Font Size", "Font Style", "Text/Edge Opacity", "Background Opacity", "Text Color", "Edge Color" or "Background Color".
- ◀▶ To select the setting you like

**Font Size:** Auto, Standard, Large or Small

**Font Style:** Auto, SerifMono, Serif, SanSerifMono, SanSerif, Casual, Cursive or SmallCapital

**Text/Edge Opacity, Background Opacity:** Auto, Transparent, Translucent, Solid, Flashing.

**Text Color, Edge Color, Background Color:** Auto, White, Black, Red, Green, Blue, Yellow, Magenta, or Cyan



Press the MENU button when finished

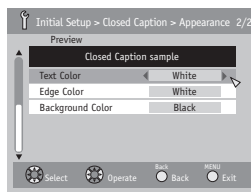
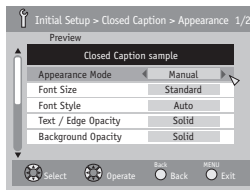

All fonts used for digital closed caption and digital menus are licensed from Monotype Imaging Inc.

### Notes:

- Closed caption subtitles are usually found on closed caption channel CC1. Some programs may include additional text information which is usually found on text channel T1. The other channels are available for future use.
- Closed captioning may not work correctly if the signal being received is weak or if you are playing a video tape.
- Most broadcasts containing closed captioning will display a notice at the start of the program.
- To select the mode, press the C.C. button. See page 46.

# Initial Setup

## Auto Shut Off

This function automatically shuts off your TV when there is no signal from the channel the TV is on.



Press the MENU button



To "Initial Setup"



To enter



To "Auto Shut Off"



To turn "On" or "Off"



Press the MENU button when finished

- If the channel that you have on does not receive a signal for more than one minute, the blinking text "No Program or Weak Signal Auto shut off in 9 min." appears on the screen, and starts the countdown. If no signal is being received within 10 minutes, the TV shuts itself off.

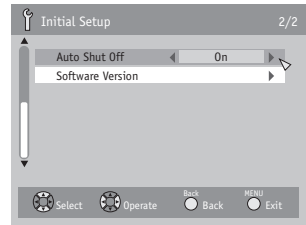

## Software Version

You can confirm the Software Version.



Press the MENU button



To "Initial Setup"



To enter



To "Software Version"



To enter



Select close when you are finished confirming your software version



Press the MENU button when finished



# Tuner Setup

## Auto Tuner Setup

The auto tuner setup function is described on page 18 as the interactive plug-in menu (AV-27F577, AV-32F577 and AV-32WF47 ONLY). If you need to run the auto tuner setup again, follow the steps below.



Press the MENU button



To "Initial Setup"



To enter



To "Auto Tuner Setup"



To enter



To choose "Cable" or "Air"



To "Scan Mode"



To choose "Auto", "STD", "HRC" or "IRC"



To "Start"



Press the Ok button (Programming will take several minutes)

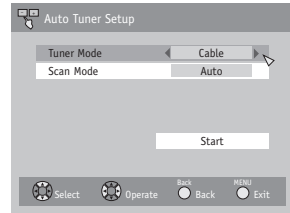

The auto tuner is finished when the message **"Programming Over !"** appears onscreen.



Press the MENU button when finished

### Notes:

- When the Tuner Mode is set to "Cable", it is possible to select "Scan Mode"
- If no channels were found using Auto Tuner Setup, check your antenna cable and the settings for Tuner Mode/Scan Mode.

## Channel Summary

Channel summary allows you to customize the line-up of channels received by your TV. Regarding analog channels, you can add or delete channels from the line-up or prevent any unauthorized viewers from watching any or all 191 channels. Regarding digital channels, the only channels that will appear are the ones that are broadcasting.



Press the MENU button



To "Initial Setup"



To enter



To "Channel Summary"



To operate

The Channel summary screen will now be displayed with the channels set to scan marked with a "√". Regarding analog channels, you can delete channels from the scan by removing the "√". If any channels were missed during auto tuner setup and you wish to add them, you may be placing an "√" next to the channel number.

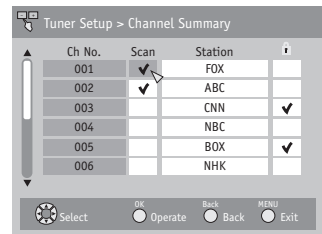

- Digital channels can not be added to the channel summary if the auto tuner setup did not find them.



To the "Scan" column



Press the Ok button to include or delete from scan



Press the MENU button when finished

### Note:

- The number of a digital channel may change, depending on the time of some broadcastings. If this channel existed and now had disappeared, the lock channel or scanned channel by the channel summary for that channel will be cancelled.

# Tuner Setup

How to set the channel station.



Press the MENU button



To "Initial Setup"



To enter



To "Channel Summary"



To operate



To "Station"



Press the Ok button to enter



To select the character you want



To move to the next space

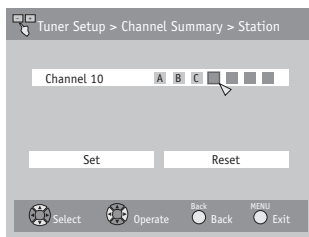

...continue to follow these directions for all seven spaces



To "Set"



Press the Ok button

*Your characters are now set*



Press the MENU button when finished

If you want to reset the characters you set:



Press the MENU button



To "Initial Setup"



To enter



To "Channel Summary"



To operate



To "Station"



Press the Ok button to enter



To select "Reset"



Press the Ok button to finish

*Your characters are now reset*

## Notes:

- You can use characters for: Alphabet, numbers, marks and spaces.
- It is possible to set the maximum of 500 channel labels.
- If you try to set more than the 500 maximum, the message "Memory Overflow" will appear.

You can block access to a channel by activating the channel lock.



Press the MENU button



To "Initial Setup"



To enter



To "Channel Summary"



To operate



To the Lock Column (  )



Press the Ok button to lock or unlock that channel



Press the MENU button when finished

# Tuner Setup

## Find Channel

Add a channel that does not exist in the channel map.



Press the MENU button



To "Tuner Setup"



To enter



To "Find Channel"



To enter



Add a channel using 0 to 9



To "Add"



Press the Ok button to finish

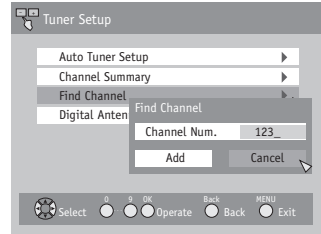

## Digital Antenna Level

Confirms the present antenna level.



Press the MENU button



To "Tuner Setup"



To enter



To "Digital Antenna Level"



To enter

### Note:

- If you are watching an analog channel, antenna level will not appear.

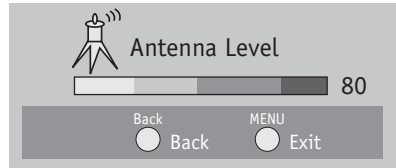

# External Input

## Video Input Label

(AV-27F577 and AV-32F577 ONLY). This function is used to label video input connections for the onscreen displays.



Press the MENU button



To "External Input"



To enter



To "Video Input Label"



To operate



To select the desired video input



To select the desired preset input label (see chart below)



Press the Ok button to save



Press the MENU button when finished

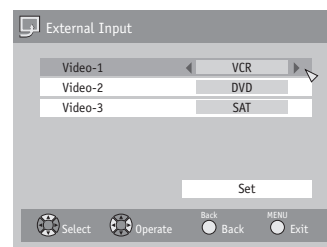
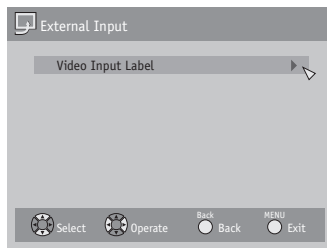

Preset Labels	Select when...
VCR	You have a VCR connected to the video input
DVD	You have a DVD connected to the video input
PVR	You have a Personal Video recorder connected to the video input
D-VHS	You have a Digital VCR connected to the video input
STB	You have a Set-top Box connected to the video input
SAT	You have a Satellite Receiver connected to the video input
AMP	You have an Amplifier connected to the video input
GAME	You have a Video Game connected to the video input
CAM	You have a Video Camera connected to the video input
DISC	You have a Video Disc player connected to the video input

# Picture Adjust

## Picture Settings

These settings allow you to change and adjust the way the picture appears on your television.

### Tint

Tint allows you to adjust the levels of red and green in your TV picture.

### Color

The color function lets you make all the colors in the TV picture appear either more vivid or subtle.

### Picture

Picture allows you to adjust the levels of black and white on the TV screen, giving you a darker or brighter picture overall.

### Bright

You can adjust the overall brightness of the TV picture with the Bright control.

### Detail

The Detail feature adjusts the level of fine detail displayed in the picture.

## Adjust the Picture Settings



Press the MENU button



To "Picture Adjust"



To enter



To "Tint", "Color", "Picture", "Bright" or "Detail"



To enter



To adjust the setting



To move to the next setting



Press the MENU button when finished

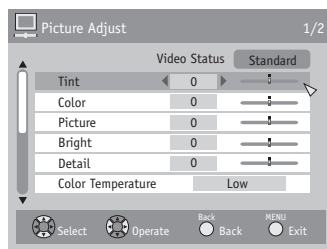

## Color Temperature

You can decide how strong or dull the colors appear on the TV screen.



Press the MENU button



To "Picture Adjust"



To enter



To "Color Temperature"



To enter



To set "Low" or "High"



Press the MENU button when finished

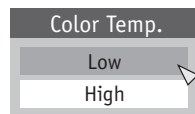

# Picture Adjust

## (VSM) Velocity Scan Modulation

Velocity scan modulation circuitry varies the electron beam's horizontal scanning speed to help accentuate the differences in picture brightness to sharpen the edges of images.



Press the MENU button



To "Picture Adjust"



To enter



To "VSM"



To enter



To turn VSM ON or OFF

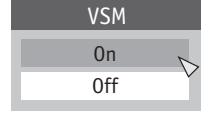

Press the MENU button when finished

## Reset

Reset resets all picture adjustments at once to the default settings.



Press the MENU button



To "Picture Adjust"



To enter



To "Reset"



Press the OK button

*The onscreen menu disappears for a moment, and then the settings are reset to the default setting for all the picture adjustments.*



Press the MENU button when finished

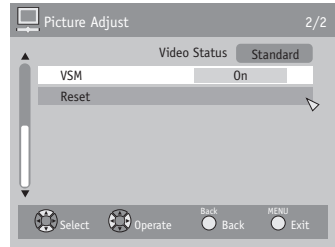

# Sound Adjust

## Sound Settings

These settings allow you to change and adjust the sound on your television.

**Bass** – You can increase or decrease the level of low-frequency sound in the TV's audio with the bass adjustment.

**Treble** – Use treble to adjust the level of high-frequency sound in your TV's audio.

**Balance** – Adjust the level of sound between the TV's left and right speakers with the balance setting.

## Adjust the Sound Settings



Press the MENU button



To "Sound Adjust"



To enter



To "Bass", "Treble" or "Balance"



To adjust the setting



To move to the next setting



Press the MENU button when finished

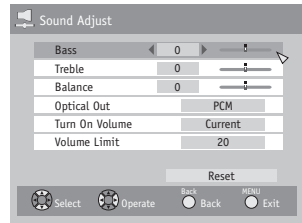

### Notes:

- You can reset all sound adjustments you set at once as the default setting when you select reset. See page 38.

## Optical Out

You can select the optical digital sound output, either PCM or Dolby Digital when your TV is connected to an amplifier that has Dolby Digital decoder. If you select Dolby Digital, you can enjoy listening in 5.1ch sound when watching digital broadcasts.



Press the MENU button



To "Sound Adjust"



To enter



To "Optical Out"



To select "PCM" or "DOLBY DIGITAL"



Press the MENU button when finished

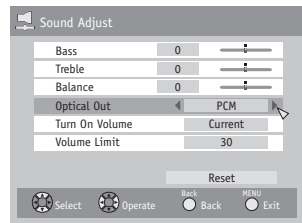

### Notes:

- If your amplifier does not have Dolby Digital decoder, select PCM. If you don't select PCM, it cannot output the sound from the speakers.
- For connecting an amplifier using the optical output, see page 15.



Manufactured under license from Dolby Laboratories. "Dolby", and the double-D symbol are trademarks of Dolby Laboratories.

# Sound Adjust

## Turn On Volume

Turn On Volume allows you to set the volume level when you turn the TV on.



Press the MENU button



To "Sound Adjust"

To enter

To "Turn On Volume"

To set the maximum volume level

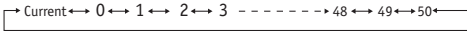

Press the MENU button to finish

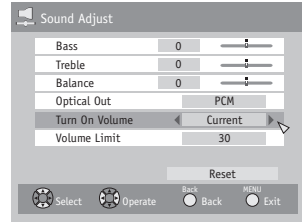

## Volume Limit

Volume Limit allows you to set the maximum volume level.



Press the MENU button



To "Sound Adjust"

To enter

To "Volume Limit"

To set the maximum volume level

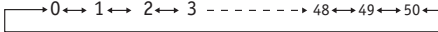

Press the MENU button to finish

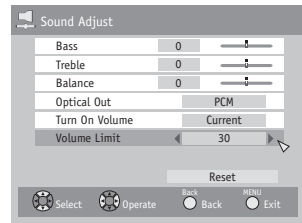

## Reset

Reset resets all Sound Adjustments at once to the default settings. See page 38 on how to use reset.

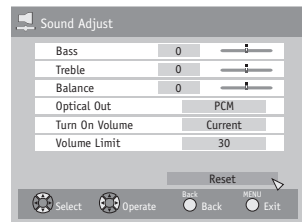









# Clock/Timers

## Set Clock





The set clock function is described on page 17 as the interactive plug-in menu (AV-27F577, AV-32F577 and AV-32WF47 ONLY). You can choose to set the clock automatically, or manually. If you need to set the clock again, follow the steps below.

-  Press the MENU button
-  To "Clock/Timers"
-  To enter
-  To "Set Clock"
-  To operate



When you set the clock automatically, choose "Auto" by pressing the  or  arrows.





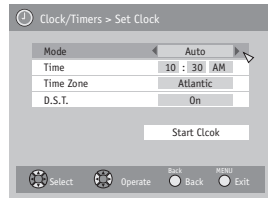





-  To Time Zone
-  To select your time zone



-  To D.S.T. (daylight savings time)
-  To turn D.S.T. On or Off
-  To "Start Clock"
-  Press the Ok button
-  Press the MENU button when finished



When you set the clock manually, choose "Manual" by pressing the  or  arrows.

-  To move to the hour
-  To set the hour
-  To move to minutes
-  To set the minutes
-  To Time Zone
-  To select your time zone:  
(Atlantic, Eastern, Central, Mountain, Pacific, Alaska or Hawaii)
-  To D.S.T. (daylight savings time)
-  To turn D.S.T. On or Off
-  To "Start Clock"
-  Press the Ok button
- "Thank you !!" will be displayed.*
-  Press the MENU button when finished

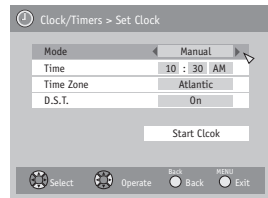

### Notes:

- D.S.T. can be used only for US and Canada when it is set to "On" in the "Set Clock" menu.
- Only when the "Mode" set to "Auto", the Daylight Savings Time feature automatically adjusts your TV's clock for Daylight Savings. The clock will move forward one hour at 2:00 am on the first Sunday in April. The clock will move back one hour at 2:00 am on the last Sunday in October.
- You will have to reset the clock after a power interruption. You must set the clock before operating any timer functions.

# Clock/Timers

## On/Off Timer

The on/off timer lets you program your television to turn itself on or off. You can use it as an alarm to wake up, to help you remember important programs, or as a decoy when you're not home.



Press the MENU button



To "Clock/Timers"



To enter



To "On/Off Timer"



To operate (begins with "On Time")



To set the hour (AM/PM) you want the TV to turn on



To move to minutes



To set the minutes



To accept "On Time" and move to "Off Time" (the time the TV will turn off). Set the "Off Time" the same way as "On Time"



To accept "Off Time" and move to "Channel"



To select channel



To "On Volume"



To set the volume level



To move to "Mode"



Choose "Once" or "Everyday"



To "On/Off Timer"



Choose "Yes" to accept the timer setting, choose "No" if you don't wish to accept



To "Set"



Press the Ok button



Press the MENU button to exit the menu

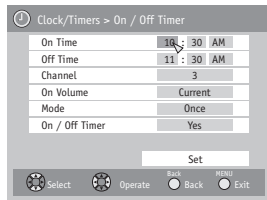

### Notes:

- The on/off time cannot be set to locked or guarded channels.
- In order for the on/off timer to work, the clock must be set.
- After a power interruption, the timer settings must be reset.
- If your clock is not set, "Please set clock first !!" will appear on the screen. Please see Manual Set Clock on page 41 to set the clock.

# Button Functions

## Power

Turns the TV on or off.



Press the POWER button

## Number Buttons - 10Key Pad

Use the number buttons on the remote control to move directly to a specific channel. For example, to move to channel 12:



0 (ZERO)



1 (ONE)



2 (TWO)

## Tune

Lets you decide the input channel and select it. After you press the number buttons on the remote, press the TUNE button. For example, to move to channel 12:



1 (ONE)



2 (TWO)



Press the TUNE button

## Input

Selects the signal input source for the television: Input-1, 2 or 3 for video devices like VCR's DVD players, or camcorders.



Press the INPUT 1, 2 or 3 button

### Notes:

- When you return to TV mode, press the RETURN+/TV button or direct 10 key pad.
- You can also access the "Front Menu" screen by using the MENU button on the front of the TV instead of the remote control. It has "Input", "Video Status" and "Aspect" menus. Choose "Input" by pressing Menu ▼ on the front panel and choose a mode by using the CHANNEL+/- buttons ( ◀ OPERATE ▶ ).

## Channel +/-

Use these buttons to move up or down all the available channels your TV is able to receive, and navigate in the menus.

## Volume +/-

Use these buttons to raise or lower the TV's volume level, and navigate in the menus.

# Button Functions

## Return +/TV

The Return+/TV button has two functions:

**Return** - Returns to the channel viewed just before the channel currently onscreen.

**Return+** - Lets you program a specific channel to return to while scanning through the channels using the CH+ and CH- buttons.



RETURN+/TV and hold for three seconds

Return Channel  
Programmed !

The channel currently active has been programmed as your return+ channel. Now scan through the channels using the CHANNEL+/- buttons.



RETURN+/TV

You will return to your programmed channel.

- To cancel your return+ channel, press and hold the RETURN+/TV button for three seconds. The message "RETURN CHANNEL CANCELLED!" will appear.
- Return+ works only with the CHANNEL+/- buttons. Pressing any number key will cancel return+.

## Sound

By pressing the SOUND button, you can change the A.H.S. (Advanced Hyper Surround), BBE and SMART SOUND on or off.

**A.H.S.** - Adds a more spacious surround sound. Music gives basic effect and movie for more effect.

**BBE** - BBE High Definition Sound restores clarity and presence for better speech intelligibility and musical realism.

**Smart Sound** - Decreases high sound levels, giving a regulated sound level.



Press the SOUND button



To select "A.H.S.", "BBE" or "Smart Sound"



To choose the setting



Press the MENU when finished

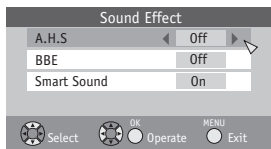

### Note:

- A.H.S. is for AV-27F577 and AV-32F577 ONLY.
- BBE is for AV-32WF47 ONLY.

Manufactured under license from BBE Sound, Inc. Licensed by BBE Sound, Inc. under USP4638258, 5510752 and 5736897. BBE and BBE symbol are registered trademarks of BBE Sound, Inc.

## Muting

The MUTING button instantly turns the volume down completely when you press it. Press MUTING and the volume level will instantly go to zero. To restore the volume to its previous level, press MUTING again.

# Button Functions

## Video Status

The Video Status button gives you a choice of four TV picture display settings, including a display of your own preferences.

**Standard** - Resets the picture display to the factory settings.

**Dynamic** - Gives a vivid picture with better contrast when viewing in a brightly lit room.

**Theater** - Gives a rich, film-like look to video when viewing in a dimly lit room.

**Game** - Used for when you are playing video games connected to your TV.

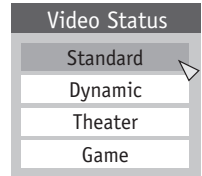

Press the V. STATUS (Video Status) button

*By every press of the V. STATUS button, you change the mode.*

### Note:

- You can also change the mode by pressing the ▲▼ buttons.
- You can also access the "Front Menu" screen by using the MENU button on the front of the TV instead of the remote control. It has "Input", "Video Status" and "Aspect" menus. Choose "Video Status" by pressing Menu ▼ on the front panel and choose a mode by using the CHANNEL+/- buttons ( ◀ OPERATE ▶ ).

## TheaterPro D6500K

The TheaterPro D6500K color temperature technology function makes sure that the video you watch is set to the standard color temperature, so that what you see is as true to what the film to video editors intended it to be.



Press the THAT. PRO (TheaterPro) button

## Sleep Timer

The Sleep Timer can turn the TV off for you after you fall asleep. Program it to work for a total time of up to 180 minutes. When you press the SLEEP button once, the rest of the time will be displayed.



Press the SLEEP button twice

*By every press of the SLEEP button, you select the time for the timer to shut off*

60 seconds before the automatic shut off, this message will appear:

Good Night !  
Push [SLEEP TIMER] button  
to extend.

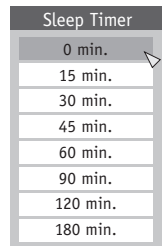

You then have 60 seconds to press the SLEEP button to delay the shut off.

### Note:

- You can also select the timer by pressing the ▲▼ buttons.

# Button Functions

## Display

The display screen shows the current information as follows.



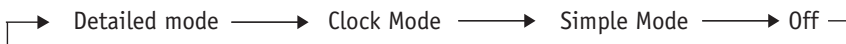

Press the DISPLAY button



- **Detailed Mode** - Shows the channel, channel name, signal, rating information, current time, digital antenna level and scramble information, as well as the current time below.



- **Clock Mode** - Shows the current time. 
- **Simple Mode** - Shows the current channel and channel name or AV input. 
- **Off** - Turns the display off.

### Notes:

- You may also turn off the display at any step by pressing MENU.
- If the clock is not set, "Clock Not Set" will be displayed.

## C.C. (Closed Caption)

Use the C.C. (Closed Caption) button to select the mode of closed caption.



Press the C.C. button

### Notes:

- "Smart Caption" is for models AV-27F577 and AV-32F577 ONLY.
- Smart Caption will appear when you press the Muting button, only on channels where the broadcast contains closed captioning.
- When you select "On", it will be the mode selected in the Closed Caption Menu.
- See page 30 when you set the caption/text mode.
- You can also change the mode by pressing the ▲▼ buttons.

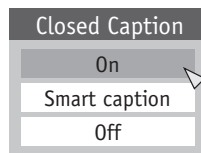

# Button Functions

## Aspect

This feature will help you adjust the picture you are watching to give you the best possible picture quality.

## Aspect Ratios

**4:3** - Use this aspect mode when you are watching a 4:3 broadcast.

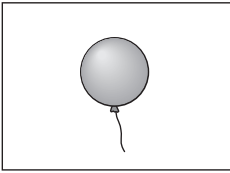

**16:9** - If you select 16:9 aspect mode while watching a 4:3 broadcast, this will stretch the picture so as to fit into the 16:9 format. When you select this mode, black bars will appear on the top and bottom of the TV screen.

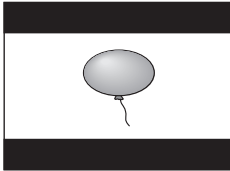

**16:9** - Use this aspect mode when you are watching a 16:9 broadcast. This is also referred to as "widescreen", for example on a DVD disc. When you select this mode, black bars will appear on the top and bottom of the TV screen.

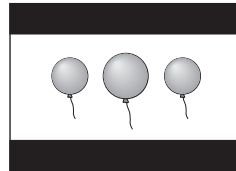

**ZOOM** - If you are watching a 4:3 high definition broadcast and you select this aspect mode, it will zoom in on the picture.

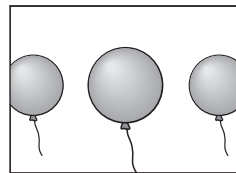

# Button Functions

## Aspect Ratios (Continued)



Press the ASPECT button

- *By pressing the ASPECT button, you can change the size.*

When you change the aspect ratios, it is different from their broadcast or recorded program.

Receiving 4:3 signal

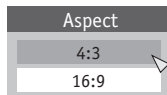

Receiving 16:9 signal

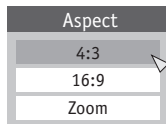

### Notes:

- You can also choose the size by pressing the ▲▼ buttons.
- When you change the aspect ratio or signal, reset the picture position to center.
- You can also access the "Front Menu" screen by using the MENU button on the front of the TV instead of the remote control. It has "Input", "Video Status" and "Aspect" menus. Choose "Aspect" by pressing MENU ▼ on the front panel and choose a mode by using the CHANNEL +/- buttons ( ◀ OPERATE ▶ ).



# Button Functions

## Favorite

The Favorite button allows you to select your favorite channels easily. First, you must register the channels that you like. See how to register below.



Press the FAVORITE button  
*The favorite channel list will appear.*



To select the channel you want to watch



Press the Ok button  
*It will change to the channel you have selected.*

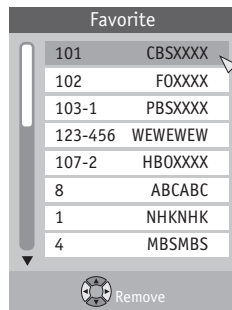

## Register the favorite channel



Press the channel number you want to register  
*The channel program will change.*



Press the FAVORITE button for three seconds  
*The channel will be registered in the favorite channel list.*

### Notes:

- The maximum number of channels you can register is 24.
- If you have registered the maximum number of channels, and try to register more channels, the oldest channel you registered will be deleted.

## Delete the favorite channel



Press the FAVORITE button  
*The favorite channel list will appear.*



To select the channel you want to delete  
To enter  
*The screen to the right will appear.*



To "Yes"



Press the Ok button  
*The channel was deleted.*



Press the FAVORITE button when finished

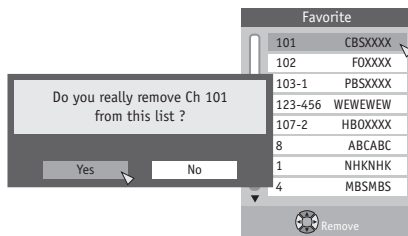

# Button Functions

## ML/MTS

MTS technology allows several audio signals to be broadcast in analog at once, giving you a choice in what you wish to hear with a TV program. In addition to mono or stereo sound, an MTS broadcast may also include a second audio program (SAP).



Press the ML/MTS button

*By every press of the ML/MTS button, you change the mode*

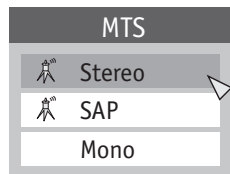

### Notes:

- When you are receiving a digital broadcast, if there are other languages, you can change the language by pressing the ML/MTS button.
- Keep the TV in stereo mode to get the best sound quality. The sound will work in stereo mode even if a certain broadcast is in mono sound only.
- Choose the mono setting to reduce excessive noise on a certain channel or broadcast.
- Selecting SAP will allow you to hear an alternative soundtrack, if one is available.
- MTS unavailable if your television's Input source is in input 1, 2 or 3 mode, as described on page 43.
- You can also change the mode by pressing the ▲▼ buttons.

## Menu

The Menu button allows you to access JVC's onscreen menu system. Press MENU to activate the onscreen menu system. When a menu is displayed, press the MENU button to exit the menu system.

- See individual topics like "Sound Adjust" for specific information on using menus.

## OK

This button confirms your selection when you are in one of the onscreen menus.

## Back

This button allows you to go back in the menu to change a selection or correct a mistake.

# Button Functions

## DVD Buttons

You can also use this remote control to operate the basic functions of your DVD player. These functions include: play, stop, still/pause, tray open/close, power on, power off, DVD Menu, cursors and enter.

- The remote is preset to control JVC-brand DVD players only.

## Sub Channel

The main channel sometimes has minor channels (Sub Channels). By using the SUB button, you can select a sub channel easily.

For example, to move to sub channel 123-45:



Press 1, 2 and 3 in order



Press the SUB CH button



Press 4 and 5 in order



Press the TUNE button

### Note:

- If there are more than 2 major channels, select the digital channel by using the ▲▼ buttons and then press the Ok button.

## Guide

You can view the program information from the GUIDE.

### Notes:

- The GUIDE will not show the correct time and date if you have not performed the set clock function on your television. See page 41.
- When the program information is not being broadcasted, it will not show the correct information.

## Game

Sets automatically the proper conditions for playing video game (previously connected in the front input).



Press the GAME button

*By pressing the GAME button, you can change the Game Mode "On" or "Off".*

Game mode	On
Input :	Video-3
Video Status :	Game

# Troubleshooting

PROBLEMS	CHECK
There is no power	<ul style="list-style-type: none"> <li>• See if the power cord became unplugged.</li> <li>• Check for a blown fuse or circuit breaker or a power outage.</li> </ul>
There is no picture or sound	<ul style="list-style-type: none"> <li>• The antenna could be disconnected.</li> <li>• The input mode could be set improperly. See page 43.</li> <li>• The tuner (Auto Tuner Setup) could be set improperly. See page 33.</li> <li>• The TV station may be having difficulties. Check to see if other stations are working.</li> </ul>
Remote control is not operating properly or at all	<ul style="list-style-type: none"> <li>• Check to see that the batteries are still working and properly installed.</li> <li>• Make sure the remote has a clear sight path to the TV.</li> <li>• You may be too far from the TV. You must be within 23 feet (7 meters).</li> </ul>
You cannot select a certain channel	<ul style="list-style-type: none"> <li>• Make sure the channels have been programmed. See "Channel Summary", page 33.</li> <li>• Check to see if the channel is locked. See "Channel Summary - Lock" page 34.</li> </ul>
The power turns off by itself	<ul style="list-style-type: none"> <li>• Make sure the set did not become unplugged.</li> <li>• Perhaps the On/Off Timer is set. See page 42.</li> <li>• Check to see if the Sleep Timer was set. See page 45.</li> </ul>
The clock is wrong	<ul style="list-style-type: none"> <li>• The power was interrupted and the clock was not reset. See page 41.</li> </ul>
The color quality is poor	<ul style="list-style-type: none"> <li>• Tint and Color may be improperly adjusted. See page 37.</li> <li>• The Video Status mode may be turned to the wrong setting. See page 45.</li> </ul>
There are lines across the picture	<ul style="list-style-type: none"> <li>• There could be interference from another electrical appliance, such as a computer, another TV or VCR. Move any such appliances further away from the TV.</li> </ul>
The picture is spotted	<ul style="list-style-type: none"> <li>• There could be interference from a high-wattage appliance, like a hairdryer or vacuum, operating nearby. Move the antenna away from the appliance or change to a coaxial cable connection which is less prone to interference.</li> </ul>
There are double pictures (ghosts)	<ul style="list-style-type: none"> <li>• A building or passing airplane can reflect the original signal and produce a second, slightly delayed one. Adjust your antenna position.</li> </ul>
Picture is snowy (image noise)	<ul style="list-style-type: none"> <li>• Your antenna may be damaged, disconnected or turned. Check the antenna connection. If the antenna is damaged, replace it.</li> </ul>
Screen is 40% black	<ul style="list-style-type: none"> <li>• The Closed Caption Text mode is on. Turn it off in the Closed Caption Menu, page 30.</li> </ul>
Stereo or bilingual programs can't be heard	<ul style="list-style-type: none"> <li>• Make sure the MTS settings are correct. See "MTS" on page 50.</li> </ul>
Static electricity	<ul style="list-style-type: none"> <li>• It is normal to feel static electricity if you brush or touch the screen.</li> </ul>
You hear occasional crackling sounds	<ul style="list-style-type: none"> <li>• It is normal for the TV to make crackling sounds when first turned on or off. Unless the sound or picture become abnormal, this is fine.</li> </ul>

## Weak Signal

This OSD warning appears when the digital channel that you have selected is too weak to receive or no signal is being detected for that channel.

No Program or Weak Signal

# Specifications

MODEL	AV-32WF47 AV-32MF47 AV-32F577	AV-27MF47 AV-27F577
Reception Format	NTSC, BTSC System (Multi-Channel Sound) ATSC Terrestrial, Digital Cable	
Reception Range	VHF 2 to 13, UHF 14 to 69 at ATSC, CATV 135 Sub, Mid, Super, Hyper and Ultra bands at Digital Cable	
	VHF 2 to 13, UHF 14 to 69 CATV 135 Sub, Mid, Super, Hyper and Ultra bands (191 channel frequency synthesizer system) at Analog • Reception of channel A-5 ("95" of the TV set's on-screen cable channel numbers) is not recommended for your TV set.	
Power Source	AC 120V, 60Hz	
Power Consumption	160W	140W
Screen Size	32 inch / 80 cm measured diagonally full square	27 inch / 68 cm measured diagonally full square
Audio Output	5W + 5W	
Speakers	2 x 4 3/4 inch / 5 x 12 cm oval x 2	
Antenna Terminal	75 ohms (VHF/UHF) (F-type connector)	
External Input Jacks	Video: 1 Vp-p, 75 ohms Audio: 500mVrms (-4dBvfs) high impedance	
S-Video Input Jack	Y: 1Vp-p positive, 75 ohms (negative sync provided) C: 0.286 Vp-p (burst signal), 75 ohms	
Component Input Jacks	Y: 1Vp-p positive, 75 ohms (negative sync provided) Pb/PR: 0.7 Vp-p, 75 ohms	
Audio Output Jacks (FIX)	FIX: 500 mVrms (-4dBvfs) Low impedance (400 Hz when modulated 100%)	
Optical Output Digital Audio	Digital Out (optical) x 1	
Dimensions (In) WxHxD (cm)	34 5/8 x 27 5/8 x 22 1/4 87.7 x 69.9 x 56.5	29 7/8 x 23 3/8 x 19 3/4 75.8 x 59.3 x 50.0
Weight (lbs / kg)	140.8 / 64	94.6 / 43
Accessories	Remote control unit x 1, AA batteries x 2	

**Specifications subject to change without notice.**

## Notes:

- Reception of channel A-5 ("95" of the TV set's on-screen cable channel numbers) is not recommended for your TV set.
- The open source software is embedded in this product. For more information, please go to: [http://software.jvc.com/opensource/Inx/DP/06\\_AtscQam/download.html](http://software.jvc.com/opensource/Inx/DP/06_AtscQam/download.html)



# LIMITED WARRANTY

DISPLAY 1-90

For Canadian model televisions, see separate sheets for Canadian Warranty information.

JVC COMPANY OF AMERICA (JVC) warrants this product and all parts thereof, except as set forth below ONLY TO THE ORIGINAL RETAIL PURCHASER to be FREE FROM DEFECTIVE MATERIALS AND WORKMANSHIP from the date of original purchase for the period shown below. ("The Warranty Period")  
PICTURE TUBE is covered for Two(2)years.

Parts	<b>1 YEAR</b>	Labor	<b>90 DAYS</b>
-------	---------------	-------	----------------

**THIS LIMITED WARRANTY IS VALID ONLY IN THE FIFTY (50) UNITED STATES, THE DISTRICT OF COLUMBIA AND IN THE COMMONWEALTH OF PUERTO RICO.**

**WHAT WE WILL DO:**

If this product is found to be defective within the warranty period, JVC will repair or replace defective parts with new or rebuilt equivalents at no charge to the original owner. Such repair and replacement services shall be rendered by JVC during normal business hours at JVC authorized service centers. Parts used for replacement are warranted only for the remainder of the Warranty Period. All products may be brought to a JVC authorized service center on a carry-in basis. Color televisions with a screen size of 27" or greater qualify for in-home service. In such cases, a technician will come to your home and either repair the TV there or remove and return it if it cannot be repaired in your home.

**WHAT YOU MUST DO FOR WARRANTY SERVICE:**

*Please do not return your product to the retailer.*

Instead, return your product to the JVC authorized service center nearest you. If shipping the product to the service center, please be sure to package it carefully, preferably in the original packaging, and include a brief description of the problem(s). Please call 1-800-252-5722 to locate the nearest JVC authorized service center. Service locations can also be obtained from our website <http://www.jvc.com>. If your product qualifies for in-home service, the service representative will require clear access to the product.

If you have any questions concerning your JVC Product, please contact our Customer Care Center at 800-252-5722

**WHAT IS NOT COVERED:**

This limited warranty provided by JVC does not cover:

1. Products which have been subject to abuse, accident, alteration, modification, tampering, negligence, misuse, faulty installation, lack of reasonable care, or if repaired or serviced by anyone other than a service facility authorized by JVC to render such service, or if affixed to any attachment not provided with the products, or if the model or serial number has been altered, tampered with, defaced or removed;
2. Initial installation, installation and removal from cabinets or mounting systems.
3. Operational adjustments covered in the Owner's Manual, normal maintenance, video and audio head cleaning;
4. Damage that occurs in shipment, due to act of God, and cosmetic damage;
5. Signal reception problems and failures due to line power surge;
6. User Removal Memory Devices/ Video Pick-up Tubes/CCD Image Sensors are covered for 90 days from the date of purchase;
7. Accessories;
8. Batteries (except that Rechargeable Batteries are covered for 90 days from the date of purchase);
9. Products used for commercial purposes, including, but not limited to rental.
10. Loss of data resultant from malfunction of hard drive or other data storage device.

There are no express warranties except as listed above.

THE DURATION OF ANY IMPLIED WARRANTIES, INCLUDING THE IMPLIED WARRANTY OF MERCHANTABILITY, IS LIMITED TO THE DURATION OF THE EXPRESS WARRANTY HEREIN.

JVC SHALL NOT BE LIABLE FOR ANY LOSS OF USE OF THE PRODUCT, INCONVENIENCE, OR ANY OTHER DAMAGES, WHETHER DIRECT, INCIDENTAL OR CONSEQUENTIAL (INCLUDING, WITHOUT LIMITATION, DAMAGE TO TAPES, RECORDS OR DISCS) RESULTING FROM THE USE OF THIS PRODUCT, OR ARISING OUT OF ANY BREACH OF THIS WARRANTY. ALL EXPRESS AND IMPLIED WARRANTIES, INCLUDING THE WARRANTIES OF MERCHANTABILITY AND FITNESS FOR PARTICULAR PURPOSE, ARE LIMITED TO THE WARRANTY PERIOD SET FORTH ABOVE.

Some states do not allow the exclusion of incidental or consequential damages or limitations on how long an implied warranty lasts, so these limitations or exclusions may not apply to you. This warranty gives you specific legal rights and you may also have other rights which vary from state to state.

JVC COMPANY OF AMERICA  
DIVISION OF JVC AMERICAS CORP.

1700 Valley Road  
Wayne, NJ 07470

<http://www.jvc.com>

REFURBISHED PRODUCTS CARRY A SEPARATE WARRANTY, THIS WARRANTY DOES NOT APPLY. FOR DETAIL OF REFURBISHED PRODUCT WARRANTY, PLEASE REFER TO THE REFURBISHED PRODUCT WARRANTY INFORMATION PACKAGED WITH EACH REFURBISHED PRODUCT.

**For customer use:**

Enter below the Model No. and Serial No. which is located either on the rear, bottom or side of the cabinet. Retain this information for future reference.

Model No. : \_\_\_\_\_

Serial No. : \_\_\_\_\_

Purchase date : \_\_\_\_\_

Name of dealer : \_\_\_\_\_

# **TO OUR VALUED CUSTOMER** ———

THANK YOU FOR PURCHASING THIS JVC PRODUCT.  
WE WANT TO HELP YOU ACHIEVE A PERFECT EXPERIENCE.

**NEED HELP ON HOW TO HOOK UP?  
NEED ASSISTANCE ON HOW TO OPERATE?  
NEED TO LOCATE A JVC SERVICE CENTER?  
LIKE TO PURCHASE ACCESSORIES?**

**JVC<sup>®</sup> IS HERE TO HELP!**  
**TOLL FREE: 1(800)252-5722**  
**<http://www.jvc.com>**

Remember to retain your Bill of Sale for Warranty Service.

————— **Do not attempt to service the product yourself** —————

**Caution**

To prevent electrical shock, do not open the cabinet.  
There are no user serviceable parts inside.  
Please refer to qualified service personnel for repairs.

---

**JVC COMPANY OF AMERICA**  
Division of JVC Americas Corp.  
1700 Valley Road  
Wayne, New Jersey, 07470



**JVC CANADA, INC.**  
21 Finchdene Square  
Scarborough, Ontario  
Canada, M1X 1A7



## Free Manuals Download Website

<http://myh66.com>

<http://usermanuals.us>

<http://www.somanuals.com>

<http://www.4manuals.cc>

<http://www.manual-lib.com>

<http://www.404manual.com>

<http://www.luxmanual.com>

<http://aubethermostatmanual.com>

Golf course search by state

<http://golfingnear.com>

Email search by domain

<http://emailbydomain.com>

Auto manuals search

<http://auto.somanuals.com>

TV manuals search

<http://tv.somanuals.com>