

JVC

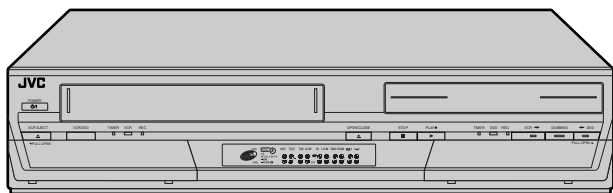

DVD VIDEO RECORDER & VIDEO CASSETTE RECORDER

DR-MV1S



INSTRUCTIONS

For Customer Use:

Enter below the Model No. and
Serial No. which are located on
the rear of cabinet. Retain this
information for future reference.

Model No. _____

Serial No. _____

Dear Customer,

Thank you for purchasing the JVC DVD video recorder. Before use, please read the safety information and precautions to ensure safe use of your new unit.

CAUTIONS

CAUTION
RISK OF ELECTRIC SHOCK
DO NOT OPEN



CAUTION: TO REDUCE THE RISK OF ELECTRIC SHOCK,
DO NOT REMOVE COVER (OR BACK).
NO USER-SERVICEABLE PARTS INSIDE.
REFER SERVICING TO QUALIFIED SERVICE PERSONNEL.



The lightning flash with arrowhead symbol, within an equilateral triangle, is intended to alert the user to the presence of uninsulated "dangerous voltage" within the product's enclosure that may be of sufficient magnitude to constitute a risk of electric shock to persons.



The exclamation point within an equilateral triangle is intended to alert the user to the presence of important operating and maintenance (servicing) instructions in the literature accompanying the appliance.

CAUTION:

A UNIT IS A CLASS 1 LASER PRODUCT. HOWEVER THIS UNIT USES A VISIBLE LASER BEAM WHICH COULD CAUSE HAZARDOUS RADIATION EXPOSURE IF DIRECTED. BE SURE TO OPERATE THE UNIT CORRECTLY AS INSTRUCTED.

WHEN THIS UNIT IS PLUGGED INTO THE WALL OUTLET, DO NOT PLACE YOUR EYES CLOSE TO THE OPENING OF THE DISC TRAY AND OTHER OPENINGS TO LOOK INTO THE INSIDE OF THIS UNIT.

USE OF CONTROLS OR ADJUSTMENTS OR PERFORMANCE OF PROCEDURES OTHER THAN THOSE SPECIFIED HEREIN MAY RESULT IN HAZARDOUS RADIATION EXPOSURE.

DO NOT OPEN COVERS AND DO NOT REPAIR YOURSELF. REFER SERVICING TO QUALIFIED PERSONNEL.

CLASS 1 LASER PRODUCT

REPRODUCTION OF LABELS

WARNING LABEL INSIDE OF THE UNIT

| | |
|-----------------|--|
| CAUTION | VISIBLE AND INVISIBLE LASER RADIATION WHEN OPEN. AVOID EXPOSURE TO BEAM. DO NOT STARE INTO BEAM OR VIEW DIRECTLY WITH OPTICAL INSTRUMENTS. |
| ADVARSEL | SYNLIG OG USYNLIG LASERSTRÅLING VED ÅBNING. UNDGÅ UDSÆTTELSE FOR STRÅLING. SE IKKE IND I STRÅLEN-HELLER IKKE MED OPTISKE INSTRUMENTER. |
| ADVARSEL | SYNLIG OG USYNLIG LASERSTRÅLING NÅR DENSEL ÅPNES. UNNGÅ EKSPONERING FOR STRÅLEN. STIRR IKKE INN I STRÅLEN ELLER SE DIREKTE MED OPTISKE INSTRUMENTER. |
| VARO! | AVATTAESSA OLET ALTTIINA NÄKYVÄÄ JA NÄKYMÄTÖN LASERSÄTELYLLE. ÄLÄ TUUKOTA SÄTEESEEN ALAKA KATSO SITÄ OPTISEN LAITTEEN LÄPI. |
| VARNING | SYNLIG OCH OSYNLIG LASERSTRÅLING NÅR DENNA DEL ÄR ÖPPNAD. STRÅLEN ÄR FARLIG. STIRRA EJ IN I STRÅLEN OCH BETRÄKTA EJ STRÅLEN MED OPTISKA INSTRUMENT. |

WARNING:

TO PREVENT FIRE OR SHOCK HAZARD, DO NOT EXPOSE THIS UNIT TO RAIN OR MOISTURE.

CAUTION:

This unit should be used with AC 120V~, 60Hz only.

To prevent electric shocks and fire hazards, DO NOT use any other power source.

CAUTION:

TO PREVENT ELECTRIC SHOCK, MATCH WIDE BLADE OF PLUG TO WIDE SLOT, FULLY INSERT.

ATTENTION:

POUR ÉVITER LES CHOCs ÉLECTRIQUES, INTRODUIRE LA LAME LA PLUS LARGE DE LA FICHE DANS LA BORNE CORRESPONDANTE DE LA PRISE ET POUSSER JUSQU'AU FOND.

Note to CATV system installer:

This reminder is provided to call the CATV system installer's attention to Article 820-40 of the NEC that provides guidelines for proper grounding and, in particular, specifies that the cable ground shall be connected to the grounding system of the building, as close to the point of cable entry as practical.

CAUTION:

Changes or modifications not approved by JVC could void user's authority to operate the equipment.

IMPORTANT PRODUCT SAFETY INSTRUCTIONS

Electrical energy can perform many useful functions. But improper use can result in potential electrical shock or fire hazards. This product has been engineered and manufactured to assure your personal safety. In order not to defeat the built-in safeguards, observe the following basic rules for its installation, use and servicing.

ATTENTION:

Follow and obey all warnings and instructions marked on your product and its operating instructions. For your safety, please read all the safety and operating instructions before you operate this product and keep this booklet for future reference.

INSTALLATION

1. Grounding or Polarization

(A) Your product may be equipped with a polarized alternating-current line plug (a plug having one blade wider than the other). This plug will fit into the power outlet only one way. This is a safety feature.

If you are unable to insert the plug fully into the outlet, try reversing the plug. If the plug should still fail to fit, contact your electrician to replace your obsolete outlet. Do not defeat the safety purpose of the polarized plug.

(B) Your product may be equipped with a 3-wire grounding-type plug, a plug having a third (grounding) pin. This plug will only fit into a grounding-type power outlet. This is a safety feature. If you are unable to insert the plug into the outlet, contact your electrician to replace your obsolete outlet. Do not defeat the safety purpose of the grounding-type plug.

2. Power Sources

Operate your product only from the type of power source indicated on the marking label. If you are not sure of the type of power supply to your home, consult your product dealer or local power company. If your product is intended to operate from battery power, or other sources, refer to the operating instructions.

3. Overloading

Do not overload wall outlets, extension cords, or integral convenience receptacles as this can result in a risk of fire or electric shock.

4. Power Cord Protection

Power supply cords should be routed so that they are not likely to be walked on or pinched by items placed upon or against them, paying particular attention to cords at plugs, convenience receptacles, and the point where they exit from the product.

5. Ventilation

Slots and openings in the cabinet are provided for ventilation. To ensure reliable operation of the product and to protect it from overheating, these openings must not be blocked or covered.

- Do not block the openings by placing the product on a bed, sofa, rug or other similar surface.
- Do not place the product in a built-in installation such as a bookcase or rack unless proper ventilation is provided or the manufacturer's instructions have been adhered to.

6. Wall or Ceiling Mounting

The product should be mounted to a wall or ceiling only as recommended by the manufacturer.

ANTENNA INSTALLATION INSTRUCTIONS

1. Outdoor Antenna Grounding

If an outside antenna or cable system is connected to the product, be sure the antenna or cable system is grounded so as to provide some protection against voltage surges and built-up static charges. Article 810 of the National Electrical Code, ANSI/NFPA 70, provides information with regard to proper grounding of the mast and supporting structure, grounding of the lead-in wire to an antenna discharge unit, size of grounding connectors, location of antenna discharge unit, connection to grounding electrodes, and requirements for the grounding electrode.

2. Lightning

For added protection for this product during a lightning storm, or when it is left unattended and unused for long periods of time, unplug it from the wall outlet and disconnect the antenna or cable system. This will prevent damage to the product due to lightning and power-line surges.

3. Power Lines

An outside antenna system should not be located in the vicinity of overhead power lines or other electric light or power circuits, or where it can fall into such power lines or circuits. When installing an outside antenna system, extreme care should be taken to keep from touching such power lines or circuits as contact with them might be fatal.

EXAMPLE OF ANTENNA GROUNDING AS PER NATIONAL ELECTRICAL CODE, ANSI/NFPA 70

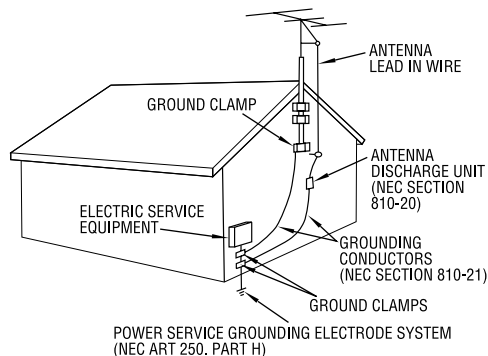

NEC – NATIONAL ELECTRICAL CODE

USE

1. Accessories

To avoid personal injury:

- Do not place this product on an unstable cart, stand, tripod, bracket, or table. It may fall, causing serious injury to a child or adult, and serious damage to the product.
- Use only with a cart, stand, tripod, bracket, or table recommended by the manufacturer or sold with the product.
- Use a mounting accessory recommended by the manufacturer and follow the manufacturer's instructions for any mounting of the product.
- Do not try to roll a cart with small casters across thresholds or deep-pile carpets.

2. Product and Cart Combination

A product and cart combination should be moved with care. Quick stops, excessive force, and uneven surfaces may cause the product and cart combination to overturn.

3. Water and Moisture

Do not use this product near water—for example, near a bath tub, wash bowl, kitchen sink or laundry tub, in a wet basement, or near a swimming pool and the like.

4. Object and Liquid Entry

Never push objects of any kind into this product through openings as they may touch dangerous voltage points or short-out parts that could result in a fire or electric shock. Never spill liquid of any kind on the product.

5. Attachments

Do not use attachments not recommended by the manufacturer of this product as they may cause hazards.

6. Cleaning

Unplug this product from the wall outlet before cleaning. Do not use liquid cleaners or aerosol cleaners. Use a damp cloth for cleaning.

7. Heat

The product should be situated away from heat sources such as radiators, heat registers, stoves, or other products (including amplifiers) that produce heat.

PORTABLE CART WARNING
(Symbol provided by RETAC)



SERVICING

1. Servicing

If your product is not operating correctly or exhibits a marked change in performance and you are unable to restore normal operation by following the detailed procedure in its operating instructions, do not attempt to service it yourself as opening or removing covers may expose you to dangerous voltage or other hazards. Refer all servicing to qualified service personnel.

2. Damage Requiring Service

Unplug this product from the wall outlet and refer servicing to qualified service personnel under the following conditions:

- When the power supply cord or plug is damaged.
- If liquid has been spilled, or objects have fallen into the product.
- If the product has been exposed to rain or water.
- If the product does not operate normally by following the operating instructions. Adjust only those controls that are covered by the operating instructions as an improper adjustment of other controls may result in damage and will often require extensive work by a qualified technician to restore the product to its normal operation.
- If the product has been dropped or damaged in any way.
- When the product exhibits a distinct change in performance—this indicates a need for service.

3. Replacement Parts

When replacement parts are required, be sure the service technician has used replacement parts specified by the manufacturer or which have the same characteristics as the original part. Unauthorized substitutions may result in fire, electric shock or other hazards.

4. Safety Check

Upon completion of any service or repairs to this product, ask the service technician to perform safety checks to determine that the product is in safe operating condition.

HOW TO USE THIS INSTRUCTION MANUAL

- All major sections and subsections are listed in the Table Of Contents on page 7. Use this when searching for information on a specific procedure or feature.
- The Index on pages 12 – 16 lists frequently-used terms, and the number of the page on which they are used or explained in the manual. This section also illustrates the controls and connections on the front and rear panel, the front display panel and the remote control.
- The  mark signals a reference to another page for instructions or related information.
- Operation buttons necessary for the various procedures are clearly indicated through the use of illustrations at the beginning of each major section.

BEFORE YOU INSTALL YOUR NEW UNIT . . .

. . . please read the sections/literature listed below.

- “CAUTIONS” on page 2
- “IMPORTANT PRODUCT SAFETY INSTRUCTIONS” on pages 3 – 5

Declaration of Conformity

Model Number: DR-MV1S
 Trade Name: JVC
 Responsible Party: JVC Americas Corp.
 Address: 1700 Valley Road Wayne, N.J. 07470
 Telephone Number: 973-317-5000

This device complies with Part 15 of FCC Rules.
 Operation is subject to the following two conditions:

(1) This device may not cause harmful interference, and (2) this device must accept any interference received, including interference that may cause undesired operation.

This equipment has been tested and found to comply with the limits for a Class B digital device, pursuant to Part 15 of the FCC Rules. These limits are designed to provide reasonable protection against harmful interference in a residential installation. This equipment generates, uses, and can radiate radio frequency energy and, if not installed and used in accordance with the instructions, may cause harmful interference to radio communications. However, there is no guarantee that interference will not occur in a particular installation. If this equipment does cause harmful interference to radio or television reception, which can be determined by turning the equipment off and on, the user is encouraged to try to correct the interference by one or more of the following measures:

Reorient or relocate the receiving antenna.

Increase the separation between the equipment and receiver.

Connect the equipment into an outlet on a circuit different from that to which the receiver is connected.

Consult the dealer or an experienced radio/TV technician for help.

VCR Plus+, C³ and PlusCode are registered trademarks of Gemstar Development Corporation.

The VCR Plus+ system is manufactured under license from Gemstar Development Corporation.

DSS™ is an official trademark of DIRECTV, Inc., a unit of GM Hughes Electronics. DISH Network™ is a trademark of Echostar Communications Corporation.



- Manufactured under licence from Dolby Laboratories. "Dolby" and double-D symbol are trademarks of Dolby Laboratories.
- "DTS" and "DTS Digital Out" are trademarks of Digital Theater Systems, Inc.
- This product incorporates copyright protection technology that is protected by method claims of certain U.S. patents and other intellectual property rights owned by Macrovision Corporation and other rights owners. Use of this copyright protection technology must be authorized by Macrovision Corporation, and is intended for home and other limited viewing users only unless otherwise authorized by Macrovision Corporation. Reverse engineering or disassembly is prohibited.

When the equipment is installed in a cabinet or a shelf, make sure that it has sufficient space on all sides to allow for ventilation (10 cm or more on both sides, on top and at the rear).

When discarding batteries, environmental problems must be considered and the local rules or laws governing the disposal of these batteries must be followed strictly.

Failure to heed the following precautions may result in damage to the unit, remote control or disc/cassette.

1. **DO NOT place the unit** —
 - in an environment prone to extreme temperatures or humidity.
 - in direct sunlight.
 - in a dusty environment.
 - in an environment where strong magnetic fields are generated.
 - on a surface that is unstable or subject to vibration.
2. **DO NOT block the unit's ventilation openings or holes.**
 (If the ventilation openings or holes are blocked by a newspaper or cloth, etc., the heat may not be able to get out.)
3. **DO NOT place heavy objects on the unit or remote control.**
4. **DO NOT place anything which might spill on top of the unit or remote control.**
 (If water or liquid is allowed to enter this equipment, fire or electric shock may be caused.)
5. **DO NOT expose the apparatus to dripping or splashing.**
6. **DO NOT use this equipment in a bathroom or places with water. Also DO NOT** place any containers filled with water or liquids (such as cosmetics or medicines, flower vases, potted plants, cups, etc.) on top of this unit.
7. **DO NOT place any naked flame sources, such as lighted candles, on the apparatus.**
8. **AVOID violent shocks to the unit during transport.**

MOISTURE CONDENSATION

Moisture in the air will condense on the unit when you move it from a cold place to a warm place, or under extremely humid conditions—just as water droplets form on the surface of a glass filled with cold liquid. In conditions where condensation may occur, disconnect the unit's power plug from the wall and keep it disconnected for a few hours to let the moisture dry, then turn on the unit.

ATTENTION:

To mobile phone users:

Using a mobile phone in the vicinity of the unit may cause picture vibration on the TV screen or change the screen to a blue back display.

On placing the unit:

Some TVs or other appliances generate strong magnetic fields. Do not place such appliances on top of the unit as it may cause picture disturbance.

Features of this unit

This unit allows you various types of playback and recording because this unit has two tuners.

Record programs on both DVD deck and VCR deck simultaneously

- 1 Start recording on the DVD deck. (☞ pg. 38)
- 2 Start recording on the VCR deck. (☞ pg. 50)

NOTE:

DV IN connector is available for DVD deck only.

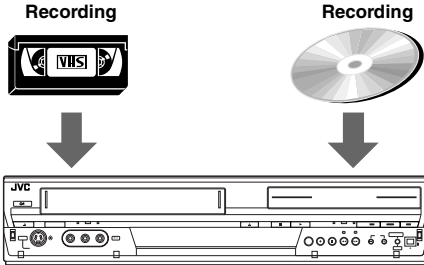

Watch another program while recording on the unit

Pressing **VCR/DVD** switches to the other tuner.

- 1 Start recording on the DVD deck or VCR deck. (☞ pg. 38, 50)
- 2 Press **VCR/DVD**.
- 3 Press **CH +/-** to select the desired channel.

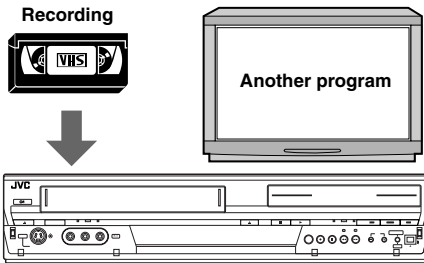

Operate the VCR deck while recording on the DVD deck

Pressing **VCR/DVD** switch to the other tuner.

- 1 Start recording on the DVD deck. (☞ pg. 38)
- 2 Press **VCR/DVD**.
- 3 Operate the VCR deck.

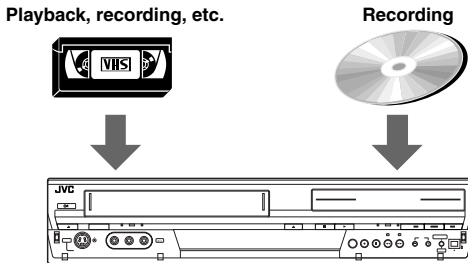

Operate the DVD deck while recording on the VCR deck

- 1 Start recording on the VCR deck. (☞ pg. 50)
- 2 Press **VCR/DVD**.
- 3 Operate the DVD deck.

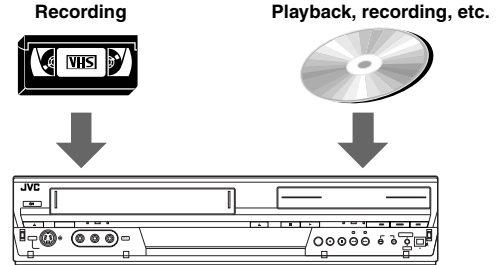

Operate the VCR deck while the DVD deck is in timer standby mode

- 1 Engage the DVD deck's timer mode. (☞ pg. 41)
 - The VCR deck is automatically selected and the VCR lamp lights up on the unit.
- 2 Operate the VCR deck.

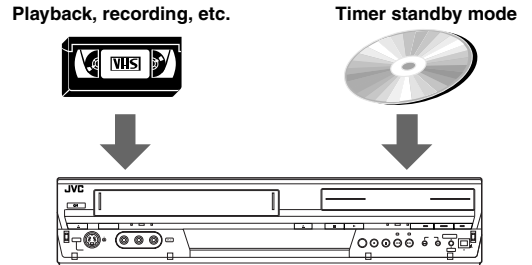

Operate the DVD deck while the VCR deck is in timer standby mode

- 1 Engage the VCR deck's timer mode. (☞ pg. 52)
 - The DVD deck is automatically selected and the DVD lamp lights up on the unit.
- 2 Operate the DVD deck.

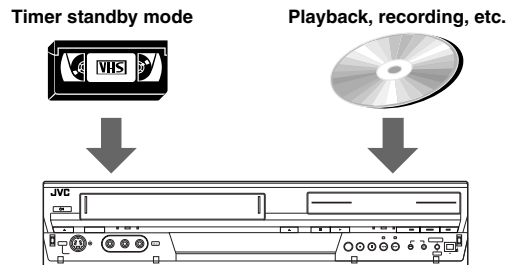



| | | | |
|--|-----------|---------------------------------------|-----------|
| DISC INFORMATION | 8 | SUBSIDIARY SETTINGS | 73 |
| About Discs | 8 | Mode Set (DVD Deck) | 73 |
| INDEX | 12 | Mode Set (VCR Deck) | 75 |
| INSTALLING YOUR NEW UNIT | 17 | Changing VCR Plus+® Setting | 77 |
| Basic Connection | 17 | Format A Disc (DVD Deck Only) | 78 |
| INITIAL SETTINGS | 18 | Finalize A Disc (DVD Deck Only) | 79 |
| Plug & Play Set | 18 | Scan Mode Set | 80 |
| Language | 19 | Tray Lock (DVD Deck Only) | 80 |
| Clock Set | 20 | TROUBLESHOOTING | 81 |
| Tuner Set | 21 | GLOSSARY | 86 |
| Cable Box and/or DBS Receiver Control Setting (DVD Deck Only) | 22 | SPECIFICATIONS | 87 |
| Monitor Set (DVD Deck Only) | 24 | APPENDIX | 88 |
| OPERATIONS ON DVD DECK | 25 | LIST OF TERMS | 91 |
| Basic Playback | 25 | WARRANTY | 92 |
| Playback Features | 26 | | |
| Live Memory Playback | 29 | | |
| Using The On-screen Bar | 33 | | |
| Parental Lock | 37 | | |
| Basic Recording | 38 | | |
| Recording Features | 39 | | |
| VCR Plus+® Timer Programing | 41 | | |
| Manual Timer Programing | 42 | | |
| On-Disc Timer Programing | 43 | | |
| Automatic Satellite Program Recording (DVD Deck Only) | 46 | | |
| OPERATIONS ON VCR DECK | 47 | | |
| Basic Playback | 47 | | |
| Playback Features | 48 | | |
| Basic Recording | 50 | | |
| Recording Features | 50 | | |
| VCR Plus+® Timer Programing | 52 | | |
| Manual Timer Programing | 53 | | |
| NAVIGATION (DVD DECK ONLY) | 55 | | |
| Library Database DVD Navi | 55 | | |
| Modify Original Information | 56 | | |
| Modify Play List Information | 58 | | |
| Modify Library Information | 60 | | |
| Playback With MP3/JPEG Navigation | 61 | | |
| EDITING | 62 | | |
| Tape Dubbing (From VCR To DVD) | 62 | | |
| Manual Dubbing (From VCR To DVD) | 63 | | |
| Disc Dubbing (From DVD To VCR) | 64 | | |
| Manual Dubbing (From DVD To VCR) | 65 | | |
| DV Dubbing (DVD Deck Only) | 66 | | |
| Edit From A Camcorder | 67 | | |
| Edit To Or From Another Recorder | 68 | | |
| Digital Audio Dubbing | 69 | | |
| REMOTE CONTROL | 70 | | |
| Remote Control Functions | 70 | | |
| SYSTEM CONNECTIONS | 72 | | |
| Connecting To A Dolby Digital Decoder Or An Amplifier With Built-in DTS | 72 | | |

About Discs

Recordable/playable Discs

You can use discs with the following logos for recording and playback.

| | |
|---|--|
|  <p>DVD-RAM 12 cm: 4.7 GB/9.4 GB 8 cm: 1.4 GB/2.8 GB Ver. 2.0 Ver. 2.1</p> |  <p>DVD-RW 12 cm: 4.7 GB/9.4 GB Ver. 1.0 (VR mode) Ver. 1.1 (Video mode/VR mode)</p> |
|  <p>DVD-R 12 cm: 4.7 GB 8 cm: 1.4 GB General Ver. 2.0 (Video mode)</p> | |

- The above table is based on the information as of February 2004.
- Recording and playback may not be performed depending on the characteristics and condition of the disc used, leading to unsatisfactory results. Using discs manufactured by JVC is recommended since they have been tested to be compatible with this unit.

DVD-RAM Discs

It is only possible to use discs which conform with DVD-RAM standard Version 2.0 or 2.1.

- It is impossible to record on DVD-RAM discs which do not conform to this standard. If you use a disc formatted under a different standard version, format it on this unit before use.
- It may not be possible to record, play back, edit or dub a DVD-RAM disc even if it conforms to the standard if it was recorded or edited on the devices from other manufacturers or on a PC, or if it has far too many titles, or if there is very little available capacity remaining on the disc.
- Some DVD-RAM discs are contained in a cartridge. This unit cannot handle this type of disc. Remove the disc from the cartridge (only discs with a removable cartridge); or the use of DVD-RAM discs not contained in a cartridge is recommended.
- DVD-RAM discs recorded on this unit cannot be played back on an incompatible DVD player.
- It is possible to record copy-once programs of digital broadcasts only onto 4.7/9.4 GB DVD-RAM discs (2.8 GB DVD-RAM discs are not compatible).

DVD-R/RW Discs

It is only possible to use DVD-R discs which conform with DVD-R standard Version 2.0.

When a DVD-R/RW disc (Video mode) is finalized (pg. 79), it can be played back on a standard DVD player as a DVD VIDEO disc.

When a DVD-RW disc (VR mode) is finalized (pg. 79), it can be played back on a standard DVD player compatible with the VR mode of DVD-RW discs.

Before finalizing —

— it is possible to record on unrecorded areas of the disc, edit the disc title and program titles, and delete programs.

- It is impossible to record or edit DVD-R/RW discs recorded on other devices even if they have not been finalized.
- It is impossible to overwrite recorded areas of DVD-R discs.
- Available recording capacity does not increase even if a recorded program is deleted from a DVD-R disc.

After finalizing —

After a DVD-R/RW disc (Video mode) has been finalized, it is possible to play back the recorded programs (video and/or audio) on a standard DVD video player as a DVD VIDEO disc.

- Edited titles are displayed as the “DVD menu” in video mode.
- It is impossible to record, edit or delete the data either in video mode or in VR mode.
- Either in video mode or in VR mode, although the disc can be played back on DVD players from other manufacturers, sometimes it may not be possible to play back depending on the disc and recording conditions.
- It is impossible to record on CD-R/RW or DVD-R discs used for authoring.
- It is impossible to record onto DVD-R/RW (Video mode) discs broadcasts that allow you to copy once. The copy once programs can only be recorded onto DVD-RW discs formatted in VR mode.

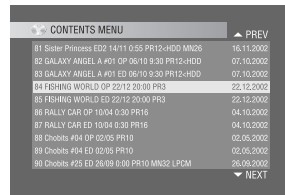







NOTE:

The following may result if you play back a DVD-R disc recorded on another unit.

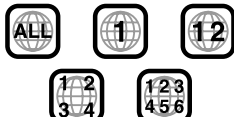
- The disc does not play.
- A mosaic pattern (block noise) appears on the screen.
- Video or audio may be dropped out.
- The unit stops during playback.

Discs For Playback Only

You can use discs with the following logos for playback only.

| | |
|--|--|
|  <p>DVD VIDEO</p> <p>(example of region code indications)</p>  | <p>Video CD/Super Video CD</p>   |
|  <p>Audio CD CD-DA files</p> |  <p>CD-R CD-DA/JPEG/MP3 files</p> |
|  <p>CD-RW CD-DA/JPEG/MP3 files</p> |  <p>CD-ROM JPEG/MP3 files</p> |

- Playback may not be performed depending on the characteristics and condition of the disc used.
- DTS Audio CDs can also be played back (An optional DTS decoder is required).
- MP3 and JPEG discs can be played back on this unit only when they have been recorded in the ISO9660 or Joliet format and finalized.
- JPEG files that can be played back on this unit must conform to JFIF/Baseline process, and the maximum resolution of a JPEG file is 3,840 x 2,160 pixels.
- CD-R/RW discs recorded in music CD format need to be finalized to play back on this unit.
- Operation and audio quality of this unit are not guaranteed for discs that do not conform to the Compact Disc specification (CD-DA). Before you play back a CD, check for the CD logo and read the notes on the package to confirm that it conforms to the Compact Disc specification.
- Depending on the intentions of the author of the software, recording conditions of DVD discs and Video CD discs may be restricted. Since this unit plays back discs according to the intentions of the author of the software as indicated on the disc, some functions may not operate as commanded.
- When switching from the first layer to the second layer of double-layered DVD VIDEO discs, the image and sound may be momentarily distorted. This is not a malfunction.

- When switching from the first layer to the second layer of double-layered DVD VIDEO discs, the image and sound may be momentarily distorted. This is not a malfunction.
- DVD-AUDIO discs compatible with DVD video players can be played.
- Super Audio CDs (SACD) compatible with conventional CD players can be played.

Unplayable Discs

The following types of discs cannot be played using this unit. Do not attempt to play back any kind of disc that is damaged (cracked, warped, or repaired with adhesive tape) or discs in unusual shapes (heart-shaped, octagonal, or other forms). If such discs are accidentally played back, it may cause noise that can lead to speaker damage.

- CD-ROM discs (including PHOTO-CD and CD-G)
- Discs recorded in Packet Write (UDF) format.
- 1.3-GB double density CDs (DDCD)
- High density CDs (HDCD)

The following discs also cannot be played back.

- Discs of a region number other than "1"
- DVD-RAM (2.6 GB/5.2 GB)
- DVD-RAM (TYPE1)

Region Number

The world is divided into 6 regions for DVD VIDEO discs. DVD VIDEO discs are assigned a region number to indicate which region they may be played back in. A disc cannot be played back on this unit unless the region number of the disc matches that of the unit. The region number for this unit is "1". Only discs whose region number includes "1" or "ALL" can be played back such as shown below.

Examples of DVD VIDEO labels which can be played back using this unit.



Marks of discs in this instruction manual

| | | | |
|--|---|--|--|
| | Allows operation with a DVD-RAM disc. | | Allows operation with a Video CD disc. |
| | Allows operation with a DVD-R disc. | | Allows operation with an Audio CD disc. |
| | Allows operation with a DVD-RW disc. | | Allows operation with a disc including MP3 files. |
| | Allows operation with a DVD VIDEO disc. | | Allows operation with a disc including JPEG files. |

Recording Medium And Format

DVD-RAM

- Recording and erasing can be performed as many times as possible on a disc.
- Editing can be performed after recording, such as deleting unwanted parts.
- While recording, it is possible not only to start playback of a program currently being recorded, but also to watch another program previously recorded.

DVD-RW (VR mode)

- Recording and erasing can be performed as many times as possible on a disc.
- Editing can be performed after recording, such as deleting unwanted parts.

DVD-RW (Video mode)

- Can be played back on other DVD players.
- New recording can be performed by erasing all the data on a disc once played back.

DVD-R

- Can be played back on other DVD players.
- Suitable when keeping a recorded disc for a long time.

File Structure Of Discs

DVD VIDEO

Typically, DVD VIDEO discs are made up of larger units called "titles". Each title has a number (title number) that can be used to select desired titles. Titles are further divided into units called "chapters". Each chapter has a number (chapter number) that can also be used to select desired chapters. Note that some discs are not divided into titles and chapters.

When you record a program on a DVD-RAM/RW (VR mode) disc

A single recording session results in a single title (a single chapter). However, chapter marks are automatically inserted when recording is paused, or audio changes from monaural to stereo due to commercial breaks, etc. It is also possible to insert chapter marks at desired locations during playback. (☞ pg. 27)

When you record a program on a DVD-R/RW (Video mode) disc

A single recording session results in a single title (a single chapter). However, chapter marks are automatically inserted when recording is paused, or audio changes due to commercial breaks, etc. It is also possible to insert chapter marks at desired locations during either recording or playback. Once the disc has been finalized, these chapter marks are deleted and new chapter marks are assigned automatically approximately every 5 minutes.

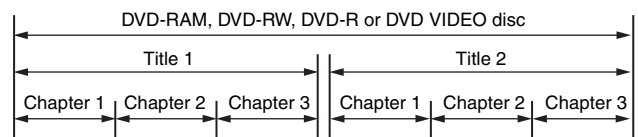

- In Video mode, even before finalizing, it is impossible to perform editing operations other than changing the disc name and/or title names and deleting programs and/or titles.
- After finalizing, it is impossible to perform editing operations.

Audio CD/Video CD

Typically, Audio CD discs are divided into separate tracks each containing one song. Each track is assigned a number. For example, the third track is Track 3. The same is true for Video CD discs.

However, some discs are not divided into tracks.

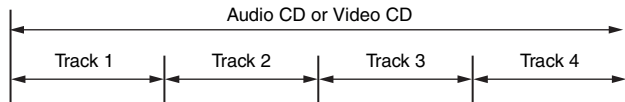

JPEG/MP3 Disc (CD-R/RW/ROM)

MP3/JPEG files put in directories nested in several levels on a disc will be organized as if they were put in single level directories (groups) by the MP3/JPEG Navigation of this unit. (pg. 61)

File structure of a disc before starting the MP3/JPEG Navigation

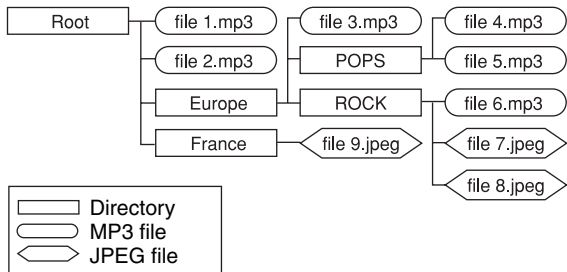

File structure of the disc after starting the MP3/JPEG Navigation

Files are automatically grouped as follows and displayed on the MP3/JPEG Navigation screen. Data is displayed in the alphabetical order of file name. Files are grouped based on roots.

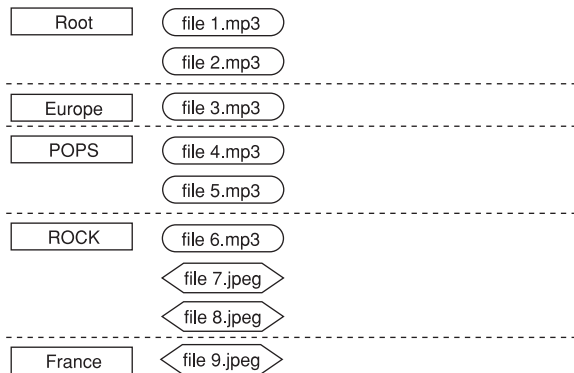

- This unit can recognise up to 9 hierarchies including directories and files. Also, it can recognise up to 250 files in each group, and up to 99 groups on a disc.

NOTES:

Video CD discs that support Playback Control (PBC)

The contents of a disc are recorded into several hierarchies, and played back according to the instructions on the screen while navigating through the hierarchies. It is also possible to playback recorded tracks consecutively without activating the PBC function even when playing a PBC-compatible disc. (pg. 29)

Regarding the contents recorded on discs

Some files may not be played back depending on the file types and other factors.

DVD VIDEO Marks

Sometimes marks are printed on a DVD disc and/or on its packaging to indicate information regarding the contents and functions of the disc. Check the marks indicating the contents and functions of the disc. Note, however, that in some cases a disc may not include a mark even for a function it supports.

Marks related to video

| | | | |
|--|--|--|---|
| | Number of subtitles | | Number of angles |
| | Recorded under the standard 4:3 aspect ratio | | Screen includes black bands at the top and the bottom of image which has a standard 4:3 aspect ratio (letter box) |
| | Video playback is in Wide video mode (16:9) on wide televisions, but in letter box on televisions with standard 4:3 aspect ratio. | | |
| | Video playback is in Wide video mode (16:9) on wide televisions, but pan and scan is used on televisions with standard 4:3 aspect ratio (either the left or right side of the image is cut-out). | | |

Marks related to audio

| | |
|--|--|
| | Number of audio tracks |
| | Dolby Digital mark It has been developed by Dolby Laboratories as a digital surround system. |
| | DTS (Digital Theater Systems) You can enjoy DTS audio if you connect an amplifier with a built-in DTS decoder to the DIGITAL AUDIO OUT connector of the unit. |

Placing A Disc

Opening the disc tray

Press **▲** (OPEN/CLOSE) to open the disc tray.

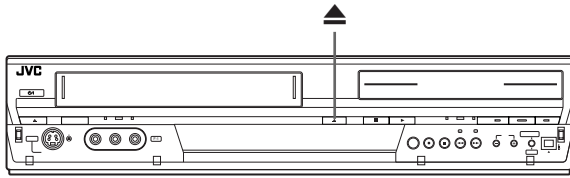

- Pressing the button again closes the disc tray.
- Use the buttons to open and close the disc tray.
- Do not block the disc tray with your hand while it is opening or closing as this may result in hardware failure.
- Do not place unplayable discs or any object other than a disc on the disc tray.
- Do not press down strongly on the disc tray or place any heavy objects on it.

Discs without cartridges

Place the disc on the disc tray with the label side facing up. Since disc size changes depending on the disc to be played back, be sure to correctly align the disc with the grooves for its size. If the disc is not in its groove, it may be scratched or otherwise damaged. To insert an 8 cm disc, place it according to the inner groove.

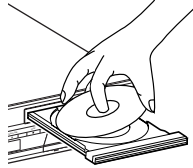

DVD-RAM discs contained in cartridges

Double-sided discs:

Remove the disc from the cartridge. Align the disc with the grooves on the disc tray as shown in the illustration and insert with the side you wish to play back or record facing down. If you insert the disc with "Side A" facing down, programs are recorded on the side A.

Single-sided discs:

Remove the disc from the cartridge. Align the disc with the grooves on the disc tray as shown in the illustration and insert with the label side facing up.

Care And Handling Of Discs

How to handle discs

When handling a disc, do not touch the surface of the disc. Since discs are made of plastic, they are easily damaged. If a disc gets dirty, dusty, scratched or warped, the images and sound will not be picked up correctly, and such a disc may cause the unit to malfunction.

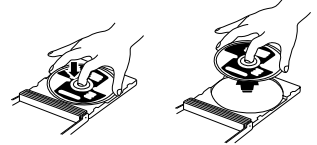

Label side

Do not damage the label side, stick paper to or use any adhesives on its surface.

Recording side

Make sure that discs are not scratched and dirty on the recording side before use. Scratches and dirt on the recording side of a disc may hinder proper playback and recording. Also be careful that a DVD-RAM disc may get scratched or dirt when removed from cartridge then put back in after use.

Storage

Make sure that discs are kept in their cases. If discs are piled on top of one another without their protective cases, they can be damaged. Do not put discs in a location where they may be exposed to direct sunlight, or in a place where the humidity or temperature is high. Avoid leaving discs in your car!

Maintenance of discs

If there are fingerprints or other dirt adhering to a disc, wipe with a soft dry cloth, moving from the centre outwards.

If a disc is difficult to clean, wipe with a cloth moistened with water. Never use record cleaners, petrol, alcohol or any anti-static agents.



CAUTION:

Sometimes during playback, noise may appear or images may be garbled. This is sometimes due to the disc. (It may not be up to industry standards.)
These symptoms are caused by the discs, not by the malfunction of the unit.

Front View

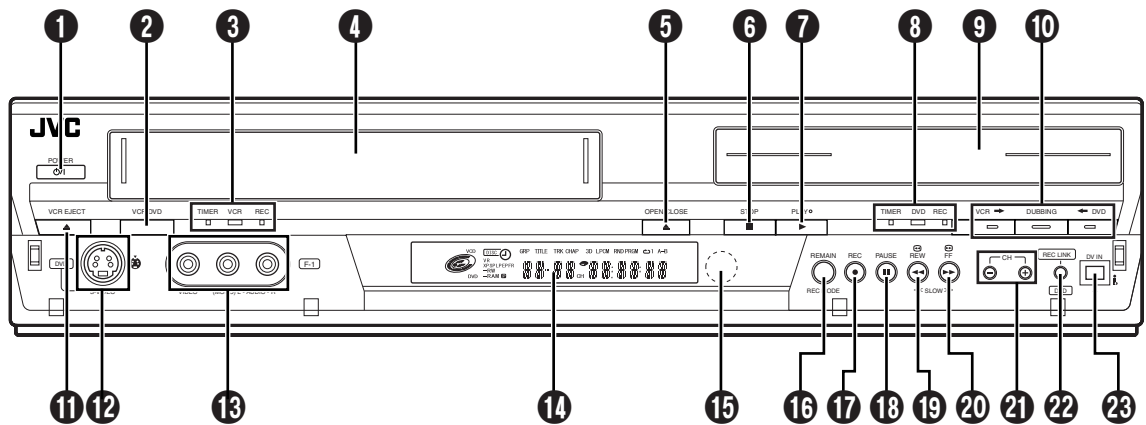

- ❶ Standby/On Button (⏻/⏻)
- ❷ VCR/DVD Button
- ❸ VCR Timer Lamp (TIMER) ☞ pg. 52
VCR Lamp ☞ pg. 47
VCR Recording Lamp (REC) ☞ pg. 50
- ❹ Cassette Loading Slot
- ❺ Open/Close Button (▲ (OPEN/CLOSE)) ☞ pg. 11
- ❻ Stop Button (■) ☞ pg. 25, 47
- ❼ Play Button (▶) ☞ pg. 25, 47
- ❽ DVD Timer Lamp (TIMER) ☞ pg. 41
DVD Lamp ☞ pg. 19, 25
DVD Recording Lamp (REC) ☞ pg. 38
- ❾ Disc Tray
- ❿ Dubbing Button (DUBBING) ☞ pg. 62
Dubbing Direction Button (VCR→/←DVD) ☞ pg. 62, 64
- ⓫ Eject Button (▲ (VCR EJECT)) ☞ pg. 47
- ⓫ S-video Input Connectors (S-VIDEO) (DVD deck only)
☞ pg. 67
- ⓫ Video/Audio Input Connectors (VIDEO/AUDIO (L/R))
☞ pg. 67
When using a monaural audio cable, use AUDIO L (MONO) input connector. In this case, the sound on the left channel is also recorded on the right channel.
- ⓫ Front Display Panel ☞ pg. 14
- ⓫ Infrared Beam Receiving Window
- ⓫ Remain Button (REMAIN) ☞ pg. 28, 39
Recording Mode Button (REC MODE) ☞ pg. 38, 50
- ⓫ Record Button (●) ☞ pg. 38, 50
- ⓫ Pause Button (⏸) ☞ pg. 25, 47
- ⓫ Reverse Search Button (◀◀) (DVD deck) ☞ pg. 26, 32
Rewind Button (◀◀) (VCR deck) ☞ pg. 47, 48
Reverse Slow Button (SLOW -) ☞ pg. 27
- ⓫ Forward Search Button (▶▶) (DVD deck) ☞ pg. 26, 32
Fast Forward Button (▶▶) (VCR deck) ☞ pg. 47, 48
Forward Slow Button (SLOW +) ☞ pg. 27
- ⓫ Channel Button (CH +/-) ☞ pg. 38, 50
- ⓫ Automatic Satellite Program Recording Button (REC LINK) (DVD deck only) ☞ pg. 46
- ⓫ DV Input connector (DV IN (i*)) (DVD deck only)
☞ pg. 66
* (i.Link) refers to the IEEE1394-1995 industry specification and extensions thereof. The i.Link logo is used for products compliant with the i.Link standard.

To access covered connectors, pull and open the connector cover.

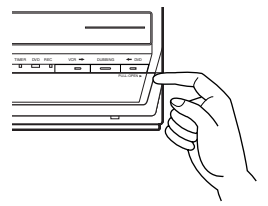

Rear View

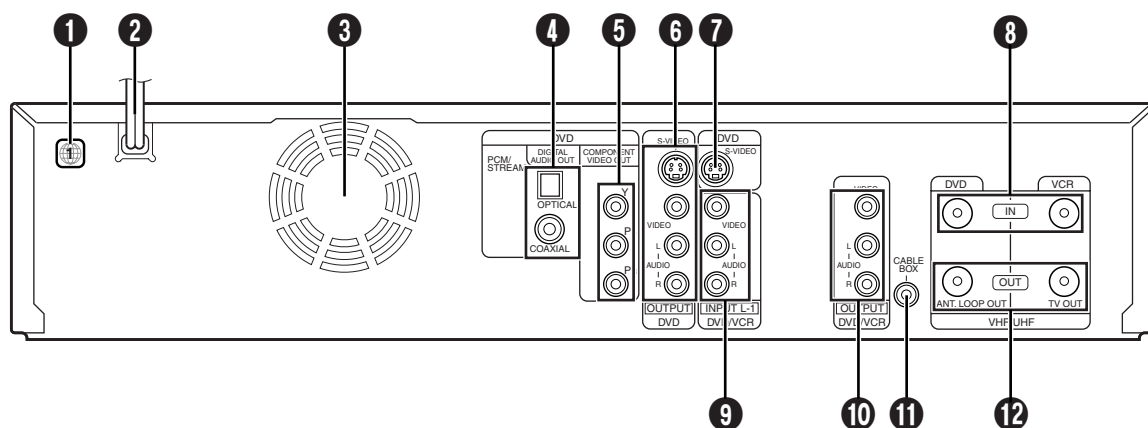

- ❶ Region Number Label [↗](#) pg. 9
- ❷ AC Power Cord [↗](#) pg. 17
- ❸ Cooling Fan
 - This prevents the temperature from rising inside the unit. Do not remove it.
 - Install the unit so as not to block the area around the fan.
 - The cooling fan on the rear of the unit may be activated even if the unit is turned off in the following cases;
 - in the Automatic Satellite Program Recording standby mode ([↗](#) pg. 46)
 - when “AUTO CLOCK” is set to “ON” ([↗](#) pg. 20)
- ❹ Digital Audio Output Connectors (DIGITAL AUDIO OUT (COAXIAL/OPTICAL)) (DVD deck only) [↗](#) pg. 69, 72
- ❺ Component Video Output Connectors (COMPONENT VIDEO OUT) [↗](#) pg. 17
- ❻ S-video/Video/Audio Output Connectors (S-VIDEO/VIDEO/AUDIO OUTPUT) (DVD deck only) [↗](#) pg. 17, 68
- ❼ S-video Input Connector (S-VIDEO INPUT) (DVD deck only) [↗](#) pg. 68
- ❽ Antenna Input Connectors (VHF/UHF IN (DVD/VCR)) [↗](#) pg. 17
- ❾ Video/Audio Input Connectors (VIDEO/AUDIO INPUT (L-1)) [↗](#) pg. 68
- ❿ Video/Audio Output Connectors (VIDEO/AUDIO OUTPUT) [↗](#) pg. 17, 68
- ⓫ Cable Box Control Connector (CABLE BOX) (DVD deck only) [↗](#) pg. 22
- ⓬ Antenna Output Connectors (VHF/UHF OUT (ANT. LOOP. OUT/TV OUT)) [↗](#) pg. 17

Front Display Panel

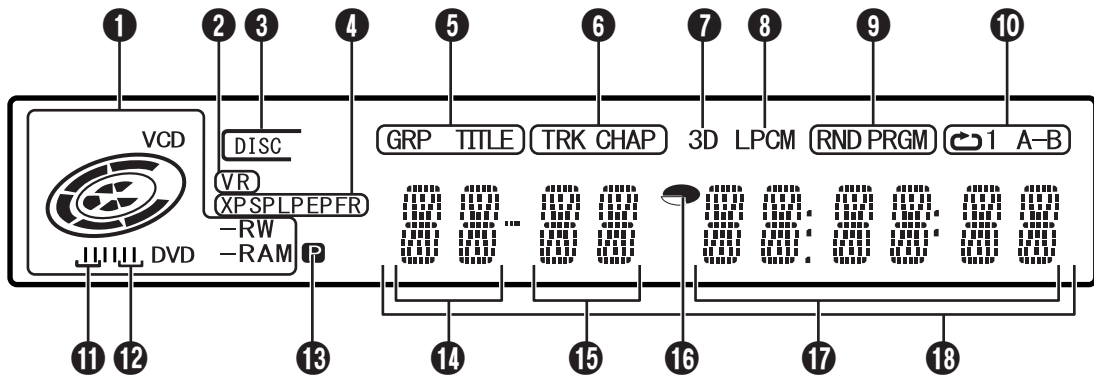

- 1** Disc Type Indicator
When a disc is loaded, the type of the disc is indicated.

Disc Status Indicator
When a disc is running, the disc marks rotate.

During High-Speed Search: Rotate faster than normal playback.
During Slow Motion: Rotate slower than normal playback.
While recording: Inner red ring lights in the same way as normal playback. During Instant Timer Recording (ITR), inner red ring slowly blinks.

While paused: Disc marks blink when either recording or playing back.
While stopped: Disc marks all light.
While resume stopped: Disc marks all blink.
While the disc tray opened: Disc marks all light out.
No disc on the disc tray: Disc marks all light out.
- 2** VR Mode Indicator [☞](#) pg. 78
Lights when a DVD-RW disc is formatted in VR mode.
- 3** DISC Indicator [☞](#) pg. 43
Lights when a disc set up for On-Disc Timer Programming is loaded.
- 4** Recording Mode Indicator (XP/SP/LP/EP/FR) [☞](#) pg. 38
Blinks when recording mode is being set.
While "FR" is blinking, the left 3 digits of the Multi Display (**14** **15**) indicate setting values ranging from "60" to "480". After the value has been set, only "FR" lights.
- 5** Group/Title Indicator (GRP/TITLE)
"GRP" or "TITLE" lights depending on a disc loaded while the left 2 digits of the Multi Display (**14**) indicate the numbers explained below.
"GRP": Total number of groups or group number being played back are displayed on the Multi Display.
"TITLE": Total number of titles or title number being played back are displayed on the Multi Display.
- 6** Track/Chapter Indicator (TRK/CHAP)
"TRK" or "CHAP" lights depending on a disc loaded while the 3rd and 4th digits from the left of the Multi Display (**15**) indicate the numbers explained below.
"TRK": Total number of tracks or track number being played back are displayed on the Multi Display.
"CHAP": Chapter number being played back are displayed on the Multi Display.
- 7** Simulated Surround Effect Indicator (3D) [☞](#) pg. 35
Lights when a simulated surround effect is set to "3D-ON" on the on-screen bar.
- 8** Linear PCM Indicator (LPCM)
Lights when "XP MODE REC AUDIO" is set to "LINEAR PCM" ([☞](#) pg. 74) for recording with DVD-RAM, DVD-R and DVD-RW discs, and when Linear PCM audio is played.
- 9** Random/Program Playback Mode Indicator (RND/PRGM) [☞](#) pg. 36
"RND": Lights when Random Playback mode is set.
"PRGM": Lights when Program Playback mode is set.
- 10** Repeat Mode Indicator (1/A-B) [☞](#) pg. 34, 49
Select Repeat Playback mode on the on-screen bar.
"1": Whole disc is played back repeatedly. It also lights up during the Repeat Playback on the VCR deck.
"1": A single title/chapter/track is played back repeatedly.
"A-B": The selected part (A-B) is played back repeatedly.
No display: Repeat Playback mode is off.
- 11** Automatic Satellite Program Recording Indicator [☞](#) pg. 46
Lights up when the DVD deck is in the Auto Satellite Program Recording standby mode while the VCR deck is used.
- 12** VCR Indicator [☞](#) pg. 39, 50
Lights up when the mode is switched to the VCR mode using the TV/VCR button. When switching the mode, "VCR" or "TV" appears for about 2 seconds on the Multi Display (**16**).
- 13** Video Output Indicator (P) [☞](#) pg. 80
No display: Indicates that interlace mode is engaged.
P: Indicates that progressive mode is engaged.
(**Example**) P lights when video output mode is in progressive mode.
- 14** Group/Title Number Display
- 15** Track/Chapter Number Display
- 16** Remaining Time/Elapsed Time Indicator [☞](#) pg. 28, 39
Lights when remaining time of DVD-RAM, DVD-R and DVD-RW discs is displayed, and lights out when elapsed time is displayed. The right 6 digits of the Multi Display (**16**) indicate elapsed or remaining time of each track.
No display: Indicates elapsed time of the disc.
Displayed: Indicates remaining time of the disc.
- 17** Remaining Time/Elapsed Time Display [☞](#) pg. 28, 39
- 18** Multi Display
Displays clock, received channel, elapsed time, and remaining time. Also displays status of the unit (NO DISC/OPEN/CLOSE/READING).

On-Screen Display (DVD deck)

When "SUPERIMPOSE" is set to "AUTO" and **ON SCREEN** on the remote control is pressed, various operational indicators appear on the TV screen. To clear the operational indicators, press **ON SCREEN** twice.

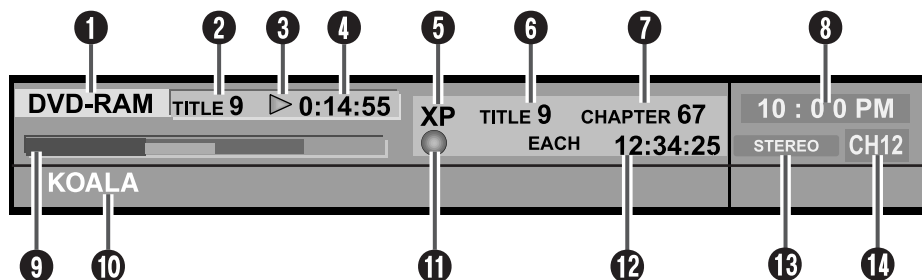

1 Disc Display

Displays the type of the disc loaded on the disc tray.

2 Title Number*

Displays number of the title currently being played back.

3 Playback Operation Status Indicator*

Indicates playback operation status by pictographs.

4 Playback Time*

Displays playback time of the title currently being played back.

5 Recording Mode

Displays recording mode as XP, SP, LP, EP, FR, FR60–FR360, FR420 and FR480. Current recording mode is displayed during recording, and recording mode in which the program was recorded is displayed during playback. The recording mode is not displayed during play list playback.

6 Title Number

Displays playback title number during playback, and recording title number during recording.

7 Chapter Number

Displays playback chapter number during playback, and recording chapter number during recording.

8 Clock Display

9 Bar Meter Display [☞](#) pg. 31

Displays playback point and other information in bar meter.

10 Title Name Display

Displays title name newly registered to the title recorded on DVD-RAM/RW/R discs, or file name of JPEG and MP3 files.

11 Operation Status Indicator

Indicates operation status by pictographs. (Also indicates its speed for forward high-speed search, reverse high-speed search and slow motion.)

12 Time Display

Displays single title playback elapsed time, single track playback elapsed time, single track remaining time, total elapsed time, total remaining time, and other information in turn.

13 Audio Mode Display

Displays audio that is being input.

14 Channel Position Number/Auxiliary Input Indicator (L-1 or F-1)

Displays currently selected input.

* During Live Memory playback, playback operation status is displayed. During normal playback, the multichannel encoding method is displayed.

On-Screen Display (VCR deck)

When "SUPERIMPOSE" is set to "AUTO" and **ON SCREEN** on the remote control is pressed, various operational indicators appear on the TV screen. To clear the operational indicators, press **ON SCREEN** again.

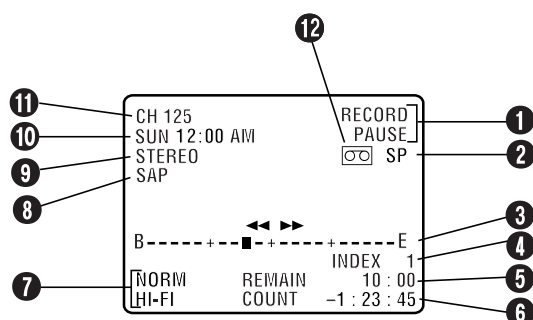

1 Operation Mode Indicators

2 Recording Mode (SP/EP)

3 Tape Position Indicator

The tape position indicator appears on the TV screen when you press ◀◀ or ▶▶ from the Stop mode or perform an Index Search. ([☞](#) pg. 48) The position of "■" in relation to "0" (Beginning) or "+" (End) shows you where you are on the tape.

NOTE:

Depending on the type of tape being used, the tape position indicator may not appear correctly.

4 Index number [☞](#) pg. 48

5 Tape Remaining Time Indicator [☞](#) pg. 51

6 Counter Display

7 Audio Mode Display [☞](#) pg. 49

8 SAP Indicator [☞](#) pg. 51

9 Stereo Program Indicator [☞](#) pg. 51

10 Day/Clock Display

11 Channel Position Number/Auxiliary Input Indicator (L-1 or F-1)

12 "Cassette Loaded" Mark

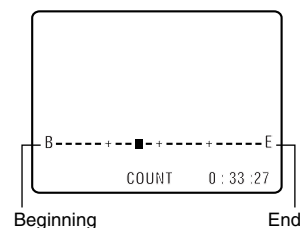

Remote Control

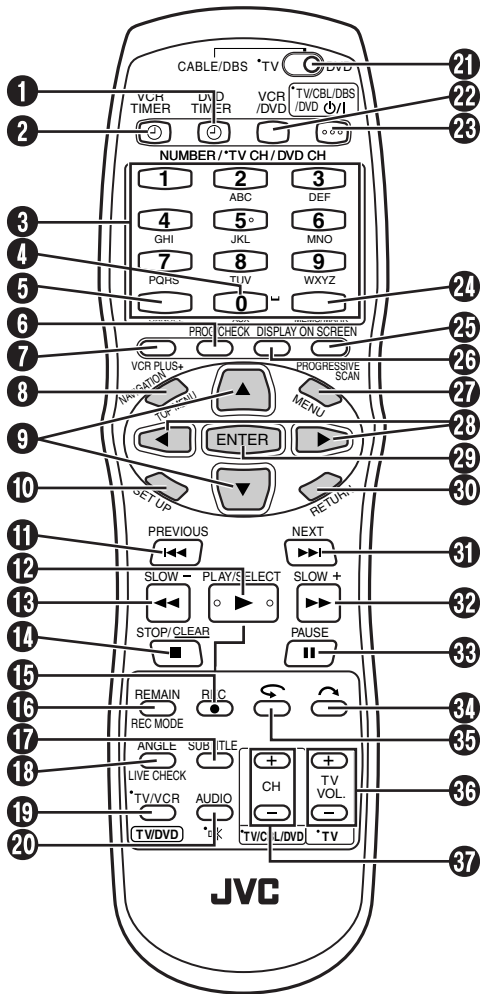

The glow-in-the-dark buttons shown in grey on the illustration above are helpful when using the remote control in darkened rooms.

Buttons with a small dot on the left side of the name can also be used to operate your TV. (☞ pg. 70)

- ❶ DVD Timer Button (DVD TIMER (Ⓢ)) (DVD deck only) ☞ pg. 41
- ❷ VCR Timer Button (VCR TIMER (Ⓢ)) (VCR deck only) ☞ pg. 52
- ❸ Number Keys ☞ pg. 21, 38, 50
Character keys (DVD deck only) ☞ pg. 57
- ❹ Auxiliary Button (AUX)
- ❺ Cancel Button (CANCEL) ☞ pg. 41
- ❻ Program Check Button (PROG/CHECK) ☞ pg. 42, 45, 53, 54,
- ❼ VCR Plus+ Button ☞ pg. 41, 52
- ❽ Top Menu Button (TOP MENU) (DVD deck only) ☞ pg. 26
Navigation Button (NAVIGATION) (DVD deck only) ☞ pg. 55
- ❾ $\triangle \nabla$ Button ☞ pg. 19
- ❿ Set Up Button (SET UP) (DVD deck only) ☞ pg. 19
- ⓫ Reverse Skip Button (◀◀) (DVD deck) ☞ pg. 26, 32
Index Button (◀◀) (VCR deck) ☞ pg. 48
Previous Button (PREVIOUS) (DVD deck only) ☞ pg. 29

- ⓬ Play Button (▶) ☞ pg. 25, 47
Select Button (SELECT) (DVD deck only) ☞ pg. 25, 56
- ⓭ Reverse Search Button (◀◀) (DVD deck) ☞ pg. 26, 32
- ⓮ Rewind Button (◀◀) (VCR deck) ☞ pg. 47, 48
Reverse Slow Button (SLOW -) ☞ pg. 27
- ⓯ Stop Button (■) ☞ pg. 25, 47
Clear Button (CLEAR) (DVD deck only) ☞ pg. 35, 41
- ⓰ Record Button (●) ☞ pg. 38, 50
- ⓱ Remain Button (REMAIN) ☞ pg. 28, 39
Recording Mode Button (REC MODE) ☞ pg. 38, 50
- ⓲ Subtitle Button (SUBTITLE) (DVD deck only) ☞ pg. 28
- ⓳ Angle Button (ANGLE) (DVD deck only) ☞ pg. 28
Live Check Button (LIVE CHECK) (DVD deck only) ☞ pg. 30, 32
- ⓴ TV/VCR Button ☞ pg. 39, 50
- ⓵ Audio Button (AUDIO) ☞ pg. 28, 49
TV Muting Button (⊘) ☞ pg. 70
- ⓶ TV/CABLE/DBS/DVD switch ☞ pg. 19
- ⓷ VCR/DVD Button ☞ pg. 19
- ⓸ TV/CBL/DBS/DVD Standby/On Button (Ⓢ/Ⓡ)
- ⓹ Memo Button (MEMO) (DVD deck only) ☞ pg. 56, 59, 61
Mark Button (MARK) (DVD deck only) ☞ pg. 27
- ⓺ On-Screen Button (ON SCREEN) (DVD deck only) ☞ pg. 15, 33
Progressive Scan Button (PROGRESSIVE SCAN) ☞ pg. 80
- ⓻ Display Button (DISPLAY) ☞ pg. 28, 39
- ⓼ Menu Button (MENU) (DVD deck only) ☞ pg. 26
- ⓽ $\triangle \nabla$ Button ☞ pg. 19
- ⓿ Enter Button (ENTER) ☞ pg. 19
- ⓾ Return Button (RETURN) ☞ pg. 29, 41
- ⓿ Forward Skip Button (▶▶) (DVD deck) ☞ pg. 26, 32
Index Button (▶▶) (VCR deck) ☞ pg. 48
Next Button (NEXT) (DVD deck only) ☞ pg. 29
- ⓿ Forward Search Button (▶▶) (DVD deck) ☞ pg. 26, 32
Fast Forward Button (▶▶) (VCR deck) ☞ pg. 47, 48
Forward Slow Button (SLOW +) ☞ pg. 27
- ⓿ Pause Button (Ⓡ) ☞ pg. 25, 47
- ⓿ Skip Search Button (↶) ☞ pg. 27, 32
- ⓿ One Touch Replay Button (↶) ☞ pg. 32, 48
- ⓿ TV Volume Button (TV VOL.) ☞ pg. 70
- ⓿ TV/CBL DVD Channel Button (CH +/-) ☞ pg. 38, 70

How To Use

Before use, insert two AA size batteries into the remote control with the polarity (⊕ and ⊖) matched correctly as indicated on the battery compartment or on the lid.

The remote control can operate most of your unit's functions, as well as basic functions of TV sets of JVC and other brands. (☞ pg. 70)

- Point the remote control toward the receiving window.
- The maximum operating distance of the remote control is about 8 m.

NOTE:

If the remote control doesn't work properly, remove its batteries, wait a short time, replace the batteries and then try again.

Basic Connection

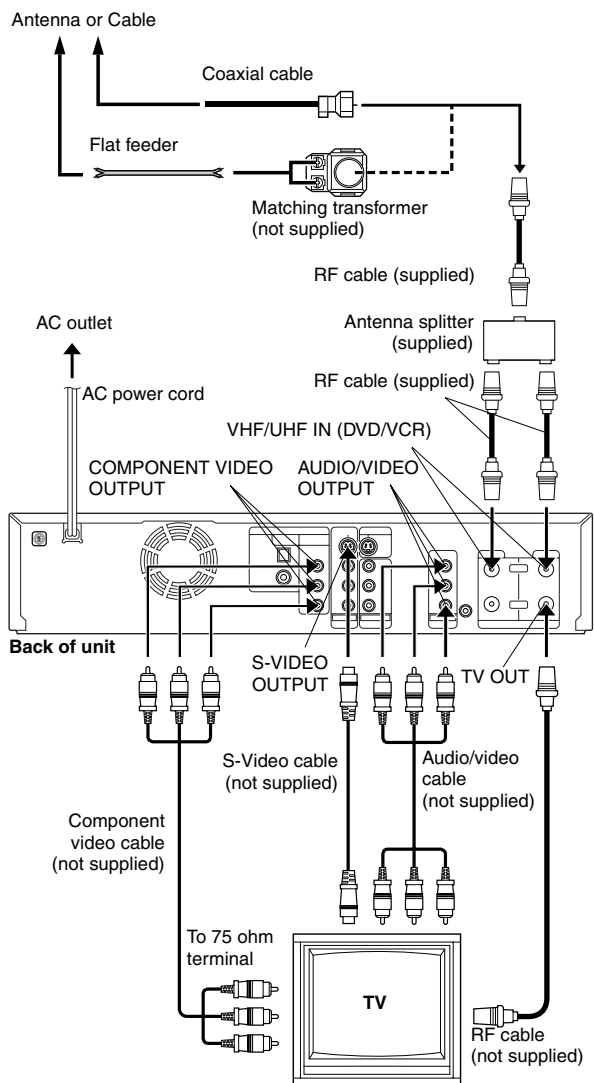

It's essential that your unit be properly connected.

THESE STEPS MUST BE COMPLETED BEFORE ANY VIDEO OPERATION CAN BE PERFORMED.

1 Make sure the package contains all of the accessories listed in "SPECIFICATIONS" on page 87.

2 Place the unit on a stable, horizontal surface.

3 Connect the unit to a TV depending on the TV and cables you use.

RF Connection

To connect to a TV with NO AV input connectors —

- 1** Disconnect the TV antenna from the TV.
- 2** Connect the TV antenna cable to the VHF/UHF IN (DVD/VCR) connectors on the rear panel of the unit via antenna splitter.
- 3** Connect an optional cable between the TV OUT connector on the rear panel of the unit and the TV's antenna terminal.

NOTES:

- If you do not use antenna splitter, connect the TV antenna cable to VHF/UHF IN (DVD) connector. However, it is not possible to record the TV program on the VCR deck.
- Connect the unit's ANT. LOOP OUT connector to the antenna input connector on another vide unit.

AV Connection

To connect to a TV with AV input connectors —

- 1** Perform **1** – **2** in "RF Connection".
- 2** Connect an optional audio/video cable between the AUDIO/VIDEO OUTPUT connectors on the rear panel of the unit and the TV's audio/video input connectors.

S-Video Connection (DVD deck only)

To connect to TV's S-VIDEO input and AUDIO input connectors

- 1** Perform **1** – **2** in "RF Connection".
 - 2** Connect the unit's S-VIDEO OUTPUT connector to the TV's S-VIDEO input connector.
 - 3** Connect the unit's AUDIO OUTPUT connectors to the TV's AUDIO input connectors.
- You can obtain high-quality S-VHS pictures.
 - If your TV is not stereo-capable, use the unit's AUDIO OUTPUT connectors to connect to an audio amplifier for Hi-Fi stereo sound reproduction.

Component Video Connection

To connect to TV's component video input connectors

- 1** Perform **1** – **2** in "RF Connection".
 - 2** Connect the unit's COMPONENT VIDEO OUT connectors to the TV's component video input connectors.
 - 3** Connect the unit's AUDIO OUTPUT connectors to the TV's AUDIO input connectors.
- You can obtain high-quality component video pictures.
 - If your TV is not stereo-capable, use the unit's AUDIO OUTPUT connectors to connect to an audio amplifier for Hi-Fi stereo sound reproduction.
 - By using the component video connection, you can view the images in the progressive mode. For switching to the progressive mode, refer to "Scan Mode Set" (ⓘ pg. 80).

4 Plug the end of the AC power cord into an AC outlet. This unit performs Plug & Play Set automatically. (ⓘ pg. 18)

- The clock and tuner channels will automatically be set when the antenna is connected and when the AC power cord is first connected to an AC outlet. (If "AUTO" and the channel indicator are displayed on the front display panel before the unit is powered on, the clock and tuner channels are being set automatically. Wait for the time to be displayed on the front display panel before turning on the unit.)
- "LOADING" blinks on the front display panel when the AC plug of the power cord is connected into a mains outlet and it takes approximately 50 seconds for the unit to be turned on. This is not a malfunction.

5 Set the video channel. The video channel is the channel on which you can watch the picture from the unit on the TV when only using RF connection.

With RF Connection

Set the video channel to "3 CH" or "4 CH". To set the video channel, perform steps **1** – **3** below:

- The video channel is preset to "3 CH". Set to "4 CH" if the Channel 3 is used for broadcasting in your area.

With AV/Component Video Connection

Set the video channel to "– CH" (off). To set the video channel, perform steps **1** – **3** below:

With S-Video Connection (DVD deck only)

Set the video channel to "– CH" (off). To set the video channel, perform steps **1** – **3** below:

How To Set The Video Channel

- 1** Make sure that there is no cassette in the unit.
- 2** Press O/I to turn off the unit, then press \blacksquare on the unit for more than 5 seconds. "3 CH" appears on the front display panel.
- 3** Press **CH +/-** on the remote control to select "3 CH", "4 CH" or "– CH" (off), then press **ENTER**. When either "3 CH" or "4 CH" is selected, the TV/VCR indicator lights up.

Plug & Play Set

Auto Clock Set/Auto Tuner Set

This unit sets the clock and tuner channels automatically when AC power cord is first connected to an AC outlet. The antenna cable must be connected for the Plug & Play setting.

The time and date can be set automatically by the clock setting data transmitted from one of the regular TV broadcast channels. We call this TV channel the "host channel" and it is a PBS channel in your area.

ATTENTION:

- If you use a cable box, Plug&Play will not function; set the clock and tuner channels separately. (☞ pg. 20 – 21)
- Depending on areas or reception conditions, the unit may not receive the Auto clock setting data from the PBS channel. If this function is taking a considerable amount of time, it may be necessary to perform the Semiauto or Manual Clock Set procedure.

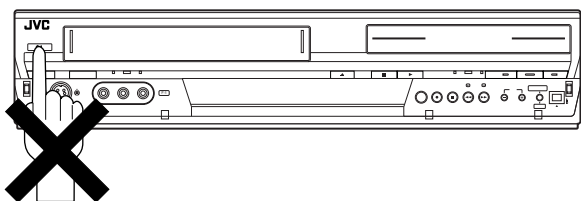

INFORMATION

- If "AUTO CLOCK" is set to "ON" (☞ pg. 20), the clock will be adjusted automatically by the host channel every hour (except 11:00 PM, midnight, 1:00 AM and 2:00 AM) using the incoming PBS channel clock setting data. (This automatic clock adjustment can only be performed when the unit is turned off. The clock will be adjusted just on these hours — on the time displayed on the front display panel, not on the actual real time.) The default setting of "AUTO CLOCK" is "ON". (☞ pg. 20)
- If the memory backup fails, because a power outage occurs or because the AC power cord is unplugged, Plug & Play will be performed when power is restored to the unit.

What to do if Plug & Play setting failed

- If an incorrect time is displayed on the front display panel, you may be receiving the clock setting data of a PBS channel from an adjacent time zone, or an incorrect PBS channel from a cable TV system. In this case, perform "Semiauto Clock Set" (☞ pg. 20) or "Manual Clock Set" (☞ pg. 20).
- If "--:--" appears on the front display panel, your antenna cable may not be connected to the unit or there may not be a Host PBS signal available in your area. Ensure that the antenna cable is connected correctly. Then turn on and off the unit; the Plug & Play setting will be automatically reactivated. If Plug & Play setting is not performed though the antenna cable is connected correctly, perform "Manual Clock Set" (☞ pg. 20) and "Auto Channel Set" (☞ pg. 21) or "Manual Channel Set" (☞ pg. 21).

1 Connect the antenna cable to the unit. (☞ pg. 17) Then connect the AC power cord to an AC outlet. Do not turn on the unit. The clock and tuner channels will be set automatically.

- "LOADING" blinks on the front display panel when the AC plug of the power cord is connected into a mains outlet and it takes approximately 50 seconds for the unit to be turned on. This is not a malfunction.

NOTES:

- Auto Clock Set is performed first. "AUTO" blinks on the front display panel during Auto Clock Set.
- Auto Channel Set is performed next. Auto Channel Set scans all the channels that are receivable by your unit. During Auto Channel Set, the channel numbers are displayed as they are scanned and set.
- When Plug & Play setting has been complete successfully, the correct clock time is displayed. If you perform Plug & Play setting successfully, there is no need to perform "Clock Set" (☞ pg. 20) and "Tuner Set" (☞ pg. 21). If, however, you want to add or delete channels, refer to "Manual Channel Set" (☞ pg. 21).

During Auto Clock Set

"AUTO" blinks.



During Auto Channel Set

The channel numbers are displayed and "AUTO" blinks as they are scanned and set.

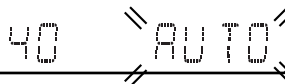

Plug&Play Completed

The current time is displayed.

- If an incorrect clock time or "--:--" appears on the front display panel, see "What to do if Plug & Play setting failed" (☞ pg. 18).



Language

- Turn on the unit.
- Turn on the TV and select the video channel (or AV mode).
- Slide the **TV/CABLE/DBS/DVD** switch to **DVD**.

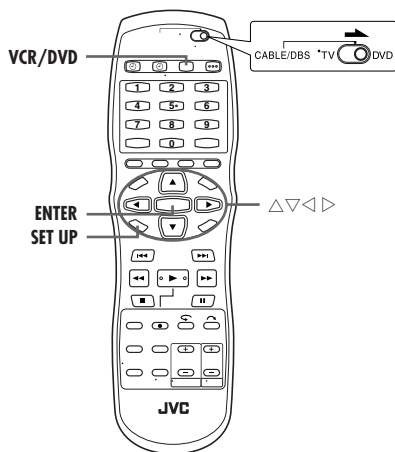

On-screen Language Set

This unit offers you the choice to view on-screen messages in 3 different languages.

- 1 Press **VCR/DVD** repeatedly so that the DVD lamp lights up on the unit.
- 2 Press **SET UP** to access the Main Menu screen.
- 3 Press ◀▶ to select "FUNCTION SET UP", then press **ENTER**.
- 4 Press ◀▶ to select "DISPLAY SET", then press **ENTER**.
- 5 Press △▽ to select "ON SCREEN LANGUAGE", then press **ENTER**.
- 6 Press △▽ to select your desired language, then press **ENTER**.
- 7 Press **SET UP** to complete the setting.

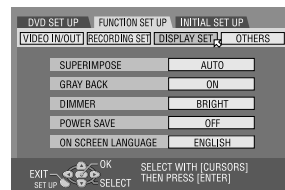

Menu/Audio/Subtitle Language Set (DVD deck only)

Some DVD discs contain the DVD menu display, audio and subtitles in multiple languages. With these discs, you can set the default language as you like.

- The procedure shows how to set "MENU LANGUAGE" as an example.

- 1 Press **VCR/DVD** repeatedly so that the DVD lamp lights up on the unit.
- 2 Press **SET UP** to access the Main Menu screen.
- 3 Press ◀▶ to select "DVD SET UP", then press **ENTER**.
- 4 Press ◀▶ to select "LANGUAGE SET", then press **ENTER**.
- 5 Press △▽ to select "MENU LANGUAGE", then press **ENTER**.
- 6 Press △▽ to select your desired language, then press **ENTER**.
- 7 Press **SET UP** to complete the setting.

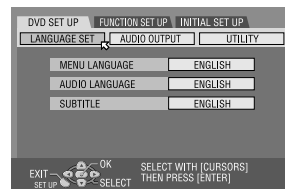

NOTE:

When the selected language is not available on the disc, the disc's default menu language is played back.

Clock Set

Perform clock setting only if the clock has not been set correctly by the Plug&Play setting.

- Turn on the unit.
- Turn on the TV and select the video channel (or AV mode).
- Slide the TV/CABLE/DBS/DVD switch to **DVD**.

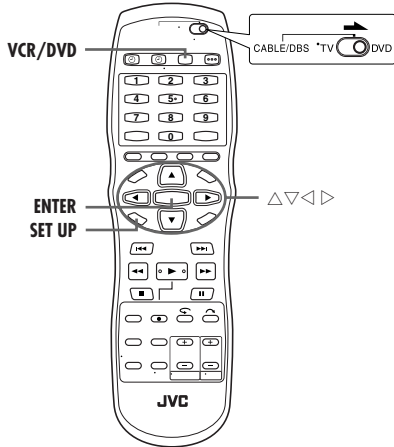

Semiauto Clock Set

You can change the host channel/D.S.T. (Daylight Saving Time)/time zone setting manually.

NOTE:

The time set previously will be erased when "AUTO CLOCK", "HOST CH", "D.S.T." or "TIME ZONE" setting is changed.

1 Press **VCR/DVD** repeatedly so that the DVD lamp lights up on the unit.

2 Press **SET UP** to access the Main Menu screen.

3 Press ◀▶ to select "INITIAL SET UP", then press **ENTER**.

4 Press ◀▶ to select "CLOCK SET", then press **ENTER**.

5 Press △▽ to select "AUTO CLOCK", then press **ENTER**. Press △▽ to select "ON", then press **ENTER**.

6 Press △▽ to select "HOST CH", then press **ENTER**. Press △▽ to select "AUTO" or the desired PBS channel number, then press **ENTER**.

NOTE:

Some PBS channels do not transmit clock setting data.

7 Press △▽ to select "D.S.T.", then press **ENTER**. Press △▽ to select the desired setting, then press **ENTER**.

AUTO: Select if you want to adjust your unit's clock automatically by the incoming signal from the host channel. Be sure to select the correct time zone manually in step 8.

ON: Adjustment will be made by the built-in clock itself.

OFF: Select when Daylight Saving Time does not apply to you.

8 Press △▽ to select "TIME ZONE", then press **ENTER**. Press △▽ to select "AUTO" or the desired time zone, then press **ENTER**.

- Each time you press △▽, the time zone changes as follows:
 ↔AUTO↔ATLANTIC↔EASTERN↔CENTRAL↔
 MOUNTAIN↔PACIFIC↔ALASKA↔HAWAII↔
 (back to the beginning)

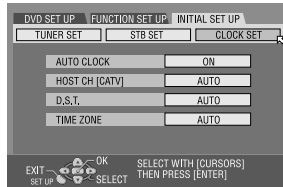

NOTE:

If an incorrect time is displayed by the Plug & Play function, you may be receiving the clock setting data of a PBS channel from an adjacent time zone or from an incorrect PBS channel from a cable TV system. If you selected "AUTO" for the host channel in step 6, be sure to select the correct time zone manually.

9 Press **SET UP** to complete the setting.

IMPORTANT:

Turn off the unit after performing Semiauto Clock. "AUTO" will appear on the front display panel while the clock is being set. The current clock time will appear automatically when the clock setting is complete.

Auto Daylight Saving Time

This function enables automatic adjustment of the unit's clock at the start and end of Daylight Saving Time.

With Auto DST activated, —

— on the first Sunday of April at 2:00 AM, the clock is adjusted to 3:00 AM.

— on the last Sunday of October at 2:00 AM, the clock is adjusted to 1:00 AM.

NOTE:

Timer recording may not function correctly at the time Daylight Saving Time is adjusted.

Manual Clock Set

1 Press **VCR/DVD** repeatedly so that the DVD lamp lights up on the unit.

2 Press **SET UP** to access the Main Menu screen.

3 Press ◀▶ to select "INITIAL SET UP", then press **ENTER**.

4 Press ◀▶ to select "CLOCK SET", then press **ENTER**.

5 Press △▽ to select "AUTO CLOCK", then press **ENTER**. Press △▽ to select "OFF", then press **ENTER**.

6 Press △▽ to select "TIME", then press **ENTER**. Press △▽ until the desired time appears, then press **ENTER** to start clock.

- Set the date and year in the same way.
- Holding △▽ changes the time in 30-minute intervals, or changes the date in 15-day intervals.

7 Press △▽ to select "D.S.T.", then press **ENTER**. Press △▽ to select the desired setting, then press **ENTER**.

ON: Adjustment will be made by the built-in clock itself.

OFF: Select when Daylight Saving Time does not apply to you.

8 Press **SET UP** to complete the setting.

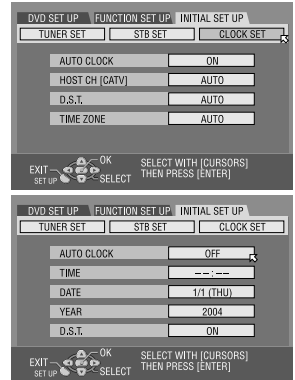

Tuner Set

- Turn on the unit.
- Turn on the TV and select the video channel (or AV mode).
- Slide the **TV/CABLE/DBS/DVD** switch to **DVD**.

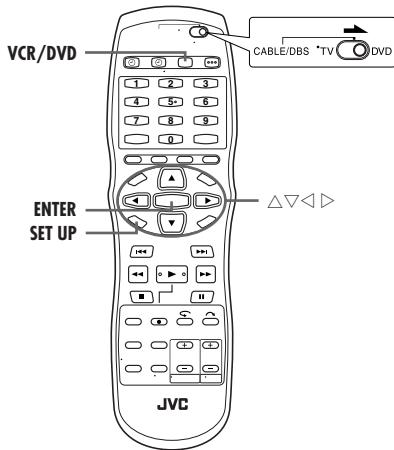

INFORMATION

The unit selects the correct band (TV or CATV) automatically during Auto Channel Set. The selected band will be displayed on the right side of "BAND" on the Tuner Set screen.

Auto Channel Set

Perform Auto Channel Set only if channels have not been set correctly by the Plug&Play setting.

- 1 Press **VCR/DVD** repeatedly so that the DVD lamp lights up on the unit.
- 2 Press **SET UP** to access the Main Menu screen.
- 3 Press ◀▶ to select "INITIAL SET UP", then press **ENTER**.
- 4 Press ◀▶ to select "TUNER SET", then press **ENTER**.

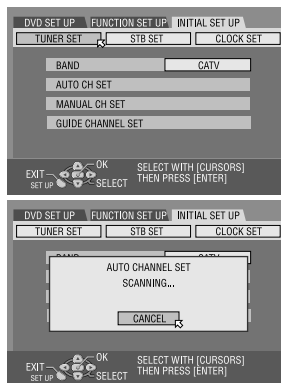

- 5 Press △▽ to select "AUTO CH SET", then press **ENTER**. You can automatically set the receivable channels in your area in the order of their frequencies.

- When Auto Channel Set is complete, "SCAN COMPLETED" appears on the TV screen.
- If the scan was unsuccessful, "SCAN COMPLETED-NO SIGNAL-" appears on screen. Check the connections and start again.

- 6 Press **SET UP** to complete the setting.

Manual Channel Set

You can add the channels you want or delete the channels you do not want manually.

- 1 Press **VCR/DVD** repeatedly so that the DVD lamp lights up on the unit.
- 2 Press **SET UP** to access the Main Menu screen.
- 3 Press ◀▶ to select "INITIAL SET UP", then press **ENTER**.
- 4 Press ◀▶ to select "TUNER SET", then press **ENTER**.
- 5 Press △▽ to select "MANUAL CH SET", then press **ENTER**.

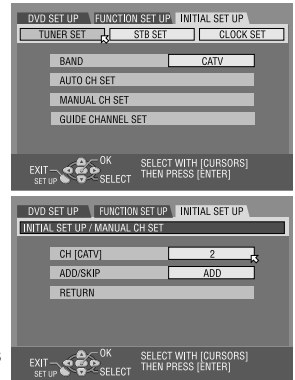

- 6 Add or skip the desired channels.

To add channels

- 1 Press △▽ to select "CH", then press **ENTER**.
- 2 Press △▽ to select a channel number you want to add, then press **ENTER**.
- 3 Press △▽ to select "ADD/SKIP", then press **ENTER**.
- 4 Press △▽ to select "ADD", then press **ENTER**.
- 5 Repeat 2 - 4 to add other channels.

To skip channels

- 1 Press △▽ to select "CH", then press **ENTER**.
- 2 Press △▽ to select a channel number you want to skip, then press **ENTER**.
- 3 Press △▽ to select "ADD/SKIP", then press **ENTER**.
- 4 Press △▽ to select "SKIP", then press **ENTER**.
- 5 Repeat 2 - 4 to skip other channels.

- 7 Press **SET UP** to complete the setting.

Cable Box and/or DBS Receiver Control Setting (DVD Deck Only)

The following procedure is required if you receive your TV channels through a cable box (descrambler) and/or if you receive satellite channels through DBS (Direct Broadcast Satellite) receiver. The Controller allows the unit to automatically switch the cable box or DBS receiver's channel during timer recording.

NOTES:

- The Controller is not supplied with this unit. It can be requested by mailing in the completed JVC Cable Mouse Certificate that is included with the accessory package.
- The Controller is effective for "VCR Plus+™ Timer Programming" (pg. 41), "Manual Timer Programming" (pg. 42), or "On-Disc Timer Programming" (pg. 43).
- When connecting your cable box, refer to its instruction manual.

Installing Controller

- 1 If both a cable box and a DBS receiver are used, position the Controller so its signal reaches the receiving windows of both the cable box and DBS receiver.
- 2 Fix securely using the adhesive strip attached on the back of the Controller.

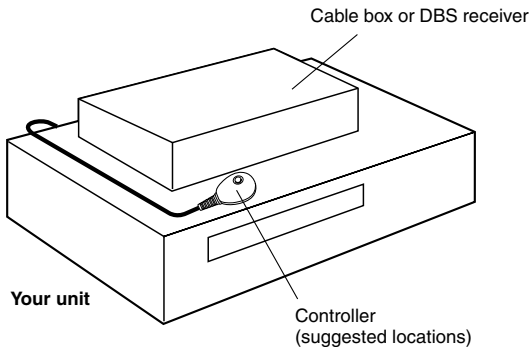

- 3 Connect the controller to the unit.

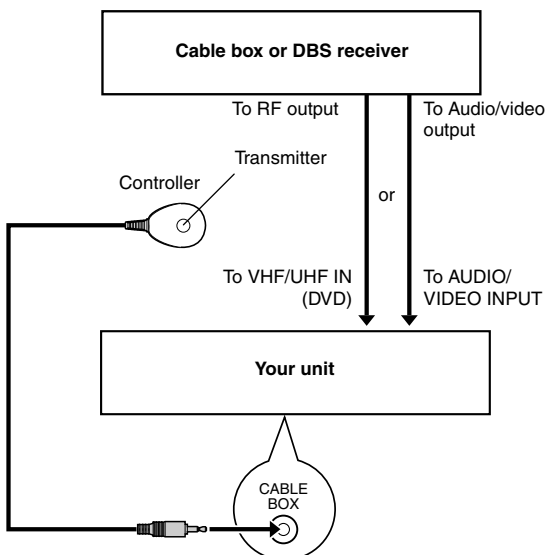

If your cable box or DBS receiver does not have audio/video output connectors

Connect the RF output connector on the cable box or DBS receiver to the VHF/UHF IN (DVD) connector on the rear of your unit via antenna splitter.

If your cable box or DBS receiver has audio/video output connectors

Connect the audio/video output connectors on the cable box or DBS receiver to the AUDIO/VIDEO INPUT connectors on the rear of the unit.

- If both a cable box and a DBS receiver are used, it is recommended that you connect the DBS receiver to your unit's AUDIO/VIDEO INPUT connectors and the cable box to your unit's VHF/UHF IN (DVD) connector via antenna splitter.
- 4 Connect the Controller to the CABLE BOX connector on the rear panel.

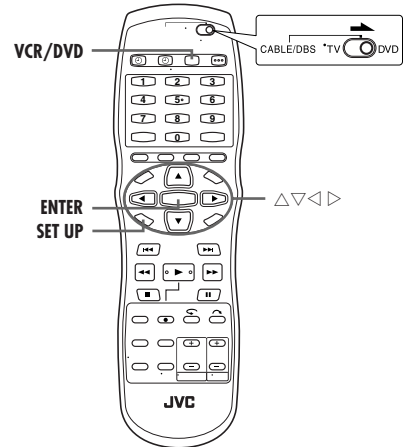

Setting Brand And Channel

After installation, set the cable box or DBS receiver's brand and channel correctly; otherwise, the Controller cannot work correctly.

- Turn on the unit.
- Turn on the TV and select the video channel (or AV mode).
- Slide the TV/CABLE/DBS/DVD switch to DVD.

- 1 Turn on the cable box or DBS receiver.
- 2 Press VCR/DVD repeatedly so that the DVD lamp lights up on the unit.
- 3 Press SET UP to access the Main Menu screen.
- 4 Press <left><right> to select "INITIAL SET UP", then press ENTER.
- 5 Press <left><right> to select "STB SET", then press ENTER.
- 6 Press <up><down> to select "CABLE BOX SET" or "DBS RECEIVER SET", then press ENTER.

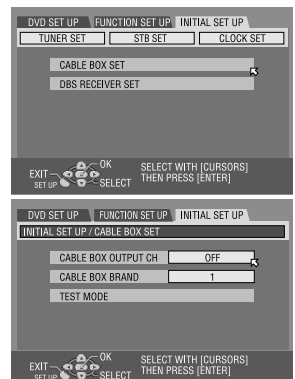

- 7 Press <up><down> to select "CABLE BOX OUTPUT CH" or "DBS RECEIVER OUTPUT CH", then press ENTER.

8 Select the output channel.

Your selection depends on how the cable box or DBS receiver is connected to your unit.

- **If the cable box or DBS receiver is connected to your unit's VHF/ UHF IN (DVD) connector on the rear panel**, press $\Delta \nabla$ to select the channel number representing the cable box's output (CH2 – CH9), then press **ENTER**.
- **If the cable box or DBS receiver is connected to your unit's AUDIO/VIDEO INPUT connectors on the front panel**, press $\Delta \nabla$ to select "F-1", then press **ENTER**.
- **If the cable box or DBS receiver is connected to your unit's AUDIO/VIDEO INPUT connectors on the rear panel**, press $\Delta \nabla$ to select "L-1", then press **ENTER**.
- **If you do not use a cable box or DBS receiver**, press $\Delta \nabla$ to select "OFF", then press **ENTER**.

9 Enter the cable box's brand.

10 Press $\Delta \nabla$ to select "CABLE BOX BRAND" or "DBS RECEIVER BRAND", then press **ENTER**. Press $\Delta \nabla$ to select the brand code from the following list, then press **ENTER**.

11 Press $\Delta \nabla$ to select "TEST MODE", then press **ENTER**.

| CABLE BOX BRAND | CODE |
|---------------------|---------------------------|
| ARCHER | 1, 5, 17 |
| CABLETENNA | 1, 17 |
| CABLEVIEW | 15, 16, 17, 21, 25 |
| CITIZEN | 15, 16, 17, 21, 25 |
| CURTIS | 2, 8 |
| DIAMOND | 1, 17 |
| GC BRAND | 15, 16, 17, 21, 25 |
| GEMINI | 15 |
| GENERAL INSTRUMENTS | 1, 4, 6, 11, 12, 15, 28 |
| HAMLIN | 10, 18, 23 |
| JASCO | 15 |
| JERROLD | 1, 4, 6, 11, 12, 15, 28 |
| NOVAVISION | 2, 8 |
| OAK | 7, 20 |
| PANASONIC | 13, 14 |
| PULSER | 15, 16, 17, 21, 25 |
| RCA | 13, 14 |
| REGAL | 10, 18, 23 |
| REMBRANDT | 1, 16, 17 |
| SAMSUNG | 5, 16, 24 |
| SCIENTIFIC ATLANTA | 2, 8 |
| SIGMA | 7, 20 |
| SL MARX | 5, 16, 17, 24, 25 |
| SPRUCER | 13, 14 |
| STARGATE | 5, 15, 16, 17, 21, 24, 25 |
| TELEVIEW | 5, 16, 24 |
| TOCOM | 1, 4, 16 |
| UNIKA | 1, 17 |
| UNIVERSAL | 16, 17, 25 |
| VIDEOWAY | 3, 9, 22 |
| ZENITH | 3, 9, 22 |

| DBS RECEIVER BRAND | CODE |
|-------------------------|------|
| JVC (DISH Network) | 51 |
| ECHOSTAR (DISH Network) | 51 |
| SONY (DSS) | 41 |
| RCA (DSS) | 40 |

■ **For cable box**

If the cable box's channel changes to 9, setting is complete.

Press **ENTER** and "CABLE BOX CONTROL IS ON" appears on the screen for about 5 seconds, then the screen in step 6 appears.

If the cable box's channel does not change to 9;

1 Press $\triangleleft \triangleright$ to select "NO", then press **ENTER**.

2 Repeat step 10 – 11 until the cable box's channel changes to 9 by entering another code.

3 If the channel does not change after going through all the code numbers listed for your model of cable box, then try all the other numbers.

■ **For DBS receiver**

If the DBS receiver's channel changes to the channel listed below for your brand, setting is complete.

Press **ENTER** and "DBS RECEIVER CONTROL IS ON" appears on the screen for about 5 seconds, then press **ENTER**. The screen in step 6 appears.

JVC → 100 SONY → 205
 ECHOSTAR → 100 RCA → 205

If the DBS receiver's channel does not change as shown above;

1 Press $\triangleleft \triangleright$ to select "NO", then press **ENTER**.

2 Repeat step 10 – 11.

NOTES:

- The Controller may not work with all types of cable box or DBS receiver.
- If your cable box does not respond to any code between 1 and 28, you cannot use the Controller to change cable box channels. In this case, make sure to leave the cable box turned on and tuned to the proper channel before the scheduled start time of timer recording. Contact your cable company about the possibility of exchanging your current cable box with the one compatible with your unit.
- If your DBS receiver does not respond to the code, you cannot use the Controller to change satellite channels. In this case, make sure to leave the DBS receiver turned on and tuned to the proper channel before the scheduled start time of timer recording.
- The unit can only change the cable box or satellite channel through the Controller during timer recording.
- If your cable box or DBS receiver cannot be operated with a remote control (because it has no receiving window), you cannot use the Controller to change its channels. Make sure to leave the cable box or DBS receiver turned on and tuned to the proper channel before the scheduled start time of timer recording.
- If the unit's memory backup expires because of a power failure, set the cable box or DBS receiver output channel and brand again.
- **For customers in U.S.A.:** If you are unable to set the Controller, contact JVC toll free at 1-800-252-5722.

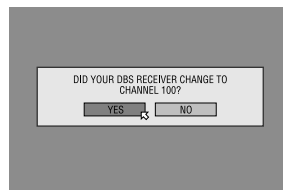
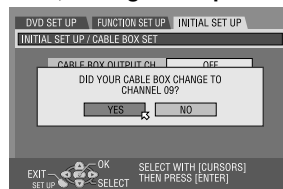

Monitor Set (DVD Deck Only)

You can select the monitor type depending on the TV used when you play back DVD VIDEO discs recorded for wide-screen TVs.

- Turn on the unit.
- Turn on the TV and select the video channel (or AV mode).
- Slide the **TV/CABLE/DBS/DVD** switch to **DVD**.

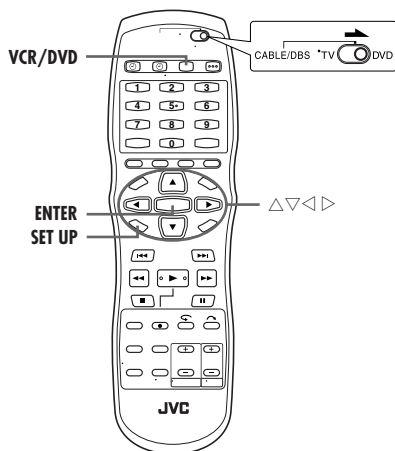

- 1 Press **VCR/DVD** repeatedly so that the DVD lamp lights up on the unit.
- 2 Press **SET UP** to access the Main Menu screen.
- 3 Press $\triangleleft \triangleright$ to select "FUNCTION SET UP", then press **ENTER**.
- 4 Press $\triangleleft \triangleright$ to select "VIDEO IN/OUT", then press **ENTER**.
- 5 Press $\triangle \nabla$ to select "MONITOR TYPE", then press **ENTER**.
- 6 Press $\triangle \nabla$ to select the desired option, then press **ENTER**.
- 7 Press **SET UP** to complete the setting.

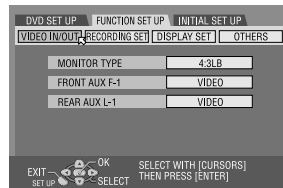

* The **boldface** settings below indicate the settings at your purchase.

■ MONITOR TYPE — **4:3LB** / 4:3PS / 16:9 AUTO / 16:9 FIX

4:3LB (Letter Box conversion): Select this when the aspect ratio of your TV is 4:3 (conventional TV). While viewing a wide screen picture, the black bars appear on the top and the bottom of the screen.

4:3PS (Pan&Scan): Select this when the aspect ratio of your TV is 4:3 (conventional TV). While viewing a wide screen picture, the black bars do not appear; however, the left and right edges of the pictures will not be shown on the screen.

16:9 AUTO (Wide television conversion): Select this when the aspect ratio of your TV is 16:9 (wide TV).

16:9 FIX (Wide television conversion): Select this when the aspect ratio of your TV is fixed to 16:9 (wide TV). The unit automatically adjusts the screen width of the output signal correctly when playing back a picture whose aspect ratio is 4:3.

Pan&Scan/Letter Box

In general, DVD VIDEO disc are produced for a wide-screen TV with 16:9 aspect ratio.

Material with this ratio will not fit to a TV with 4:3 aspect ratio.

There are two styles to display the image, "Pan&Scan" (PS) and "Letter Box" (LB).

Pan&Scan

The right and left side of the image are cut off. The image fills the screen.

- The picture will be shown in the "4:3LB" mode depending on the disc even if the "4:3PS" mode is selected.



Letter Box

Black bands appear at the top and bottom of the image. The image itself appears in 16:9 aspect ratio.



Basic Playback



- Turn on the unit.
- Turn on the TV and select the video channel (or AV mode).
- Slide the **TV/CABLE/DBS/DVD** switch to **DVD**.

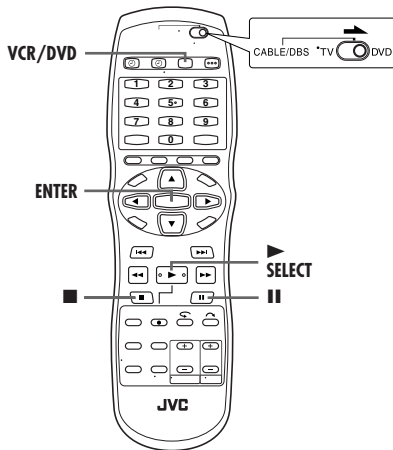
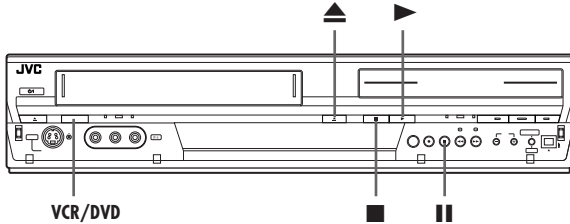

ATTENTION:

- It takes approximately 30 seconds to read a disc depending on the type and condition of the disc since this unit is multi-disc compatible (DVD-RAM, DVD-RW, DVD-R). It may even take several minutes when a disc is dirty, scratched or warped.
- It may take a few seconds to start playback. This is not a malfunction.
- Forward/reverse high-speed search and other operations cannot be performed while playback is stopped.

To play back an MP3/JPEG disc, see "Playback With MP3/JPEG Navigation" (pg. 61).

1 Load a disc.

- For details, refer to "Placing A Disc" (pg. 11).
- Pressing **▶** also closes the disc tray.
- Playback begins automatically if an auto-playback DVD disc is loaded.

2 Press **VCR/DVD** repeatedly so that the DVD lamp lights up on the unit.

3 Press **▶** to start playback.

- If you load a DVD disc whose region code does not match the unit, "REGION CODE ERROR" appears on the TV screen. For details, refer to "Region Number" (pg. 9).
- If "CAN NOT PLAY BACK DISC UNDER CURRENT SETTING" appears on the TV screen, refer to "Parental Lock" (pg. 37).
- With Video CD discs with PBC control or some DVD discs, the menu display may appear on the TV screen after starting playback. In this case, select an item which you want to play back from the menu. Otherwise, the playback cannot go forward. Refer to "Playback Control (PBC) Function" (pg. 29) or "Locating A Desired Scene Using The DVD Menu" (pg. 26).
- The Library Database DVD Navi also enables you to search and select the desired programs. (pg. 56)

4 Press **||** to pause playback.

- To resume normal playback, press **▶**.

5 Press **■** to stop playback.

- When a recordable disc is played, playback stops and a program received with the unit's tuner resumes on the TV screen.
- When a playback-only disc is played, playback stops and the still image at the time you press **■** remains on the TV screen. Pressing **■** again resumes a program received with the unit's tuner.
- If **▲ (OPEN/CLOSE)** is pressed during playback, playback stops, then the disc tray opens.

NOTE:

When the Library Database DVD Navi screen appears, choose a thumbnail image of the desired program on the TV screen, then press **SELECT (▶)** or **ENTER**. (pg. 56)

Playback Features

- Turn on the unit.
- Turn on the TV and select the video channel (or AV mode).
- Slide the TV/CABLE/DBS/DVD switch to DVD.
- Press VCR/DVD repeatedly so that the DVD lamp lights up on the unit.

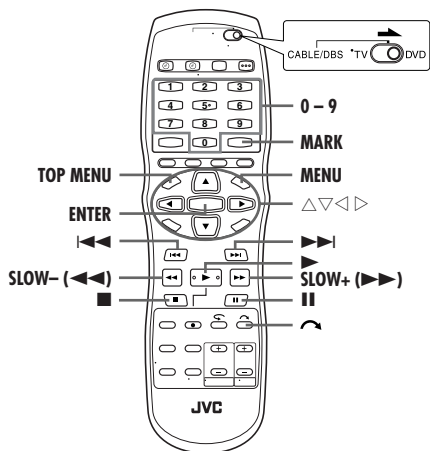

Locating The Start Point Of The Item Or Skip The Item



Press **◀◀** or **▶▶** during playback.

- Pressing **▶▶** locates the start point of the item or skips the item for forward direction, then resumes playback.
- Pressing **◀◀** locates the start point of the item or skips the item for reverse direction, then resumes playback.

When a DVD-RAM/RW/R disc is played

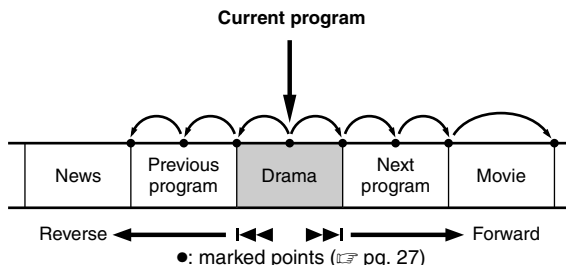

Example:

To locate the beginning of the next item, press **▶▶** once.
To locate the beginning of the current item, press **◀◀** once.
To locate the beginning of the previous item, press **◀◀** three times.

When a DVD VIDEO, Audio CD or Video CD disc is played

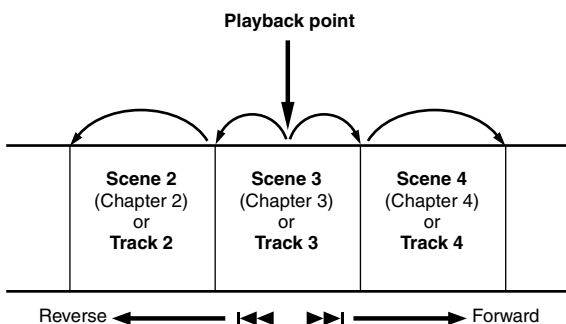

Example:

To locate the beginning of the next item, press **▶▶** once.
To locate the beginning of the current item, press **◀◀** once.

Locating A Desired Scene Using The DVD Menu



DVD VIDEO discs may have top menu and disc menu.

Top menu

DVD discs generally have their own menus which show the disc contents. These menus contain various items such as titles of a movie, names of songs, or artist information. You can locate a desired scene by using the top menu displayed on the TV screen. Press **TOP MENU** to access the top menu.

Disc menu

Disc menus include playback data (angle menu, subtitle menu, etc.) specific to each title.

Press **MENU** to access the disc menu.

1 Press **TOP MENU** or **MENU** to access the DVD menu.

2 Press **△▽◀▶** to select a desired title, then press **ENTER**. Playback starts.

- It may be possible to select the desired item using the **number keys** depending on the menu display.

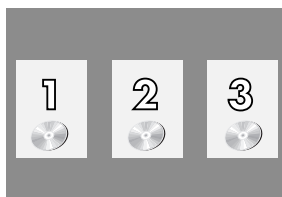

Example:

NOTE:

When "S" appears on the TV screen in step 1, the disc does not have a top menu or disc menu.

High-Speed Search



During playback, press **▶▶** for forward high-speed search, or **◀◀** for reverse high-speed search.

- Each press of the button increases the search speed for each direction.
- To resume normal playback, press **▶**.

OR

During playback, press and hold **▶▶** for 2 or more seconds for forward high-speed search, or press and hold **◀◀** for 2 or more seconds for reverse high-speed search.

- Releasing the button resumes normal playback.

Still Picture/Frame-By-Frame Playback



1 Press **II** to pause during playback.

2 Press **II** or **<|>** to activate frame-by-frame playback.

- Each press of **II** advances the still picture frame by frame.
- Each press of **<|>** advances/reverses the still picture frame by frame.
- Frame-by-frame playback for reverse direction cannot be performed with Video CD discs.
- To resume normal playback, press **▶**.

Slow Motion



1 Press **II** to pause during playback.

2 Press **SLOW -** (**<<<**) or **SLOW +** (**>>>**).

- Each press of **SLOW -** (**<<<**) or **SLOW +** (**>>>**) increases the slow motion speed for each direction (from 1/16 to 1/2 times the normal speed).
- Slow motion for reverse direction cannot be performed with Video CD discs.

OR

Press **SLOW -** (**<<<**) or **SLOW +** (**>>>**) for 2 or more seconds.

Skip Search



During playback, press **↶**.

- Each press initiates an approximately 30-second period of fast-motion playback. Normal playback resumes automatically.

Resume Function



It is possible to memorize the position where you stop playback and resume playback from that position.

- Be sure to set "RESUME" to "ON" or "DISC RESUME". (☞ pg. 74)

1 Press **■** during playback to memorize a resume point.

- The unit enters Resume Stop mode and memorizes the position where you have stopped playback as a resume point. (The inside of the disc status indicator on the front display panel blinks while memorising.)
- The unit retains a memory of the resume points of the last 30 discs played back, even though they have been ejected if "RESUME" is set to "DISC RESUME". (☞ pg. 74)
- To clear the resume points:
(The inside of the disc status indicator stops blinking and lights.)

When "RESUME" is set to "ON":

- Press **⏻** to turn off the unit.
- Press **▲ (OPEN/CLOSE)** to take out the disc.
- Press **■** in stop mode.
- Press **TOP MENU** to display the top menu, then start playback by selecting an item, etc.
- Press **MENU** to display the disc menu, then start playback by selecting an item, etc.

When "RESUME" is set to "DISC RESUME":

- Set "RESUME" to "OFF". (☞ pg. 74)
- Press **■** in stop mode.
- Press **TOP MENU** to display the top menu, then start playback by selecting an item, etc.
- Press **MENU** to display the disc menu, then start playback by selecting an item, etc.

2 Press **▶** in stop mode to resume playback. The unit starts playback from the resume point.

NOTES:

- "DISC RESUME" setting works on DVD VIDEO, VCD and already finalised DVD-R/DVD-RW (video mode) discs. For other types of discs, the function under "ON" setting will be applied even if "RESUME" is set to "DISC RESUME". (☞ pg. 74)
- If you stop the playback of a disc for which a resume point has already been memorized, the memory will be updated with the new resume point.
- After the unit has memorized the resume point for 30 discs, remembering a new resume point will cause the unit to delete the oldest memorized point. Stopping playback of a disc for which a resume point is already stored may change the order in which the points are stored. This may potentially change the order in which points are deleted.
- When the unit memorizes a resume point for a disc, it also remembers audio language, subtitle and angle settings.
- This function may not work for some Video CD.
- When "RESUME" is changed to "ON" or "OFF" (☞ pg. 74), resume points of the discs memorized with "RESUME" set to "DISC RESUME" will be cleared.
- Resume points are memorized for each side of a double-sided disc.

Marking Positions To Play Back Again Later



It is possible to mark positions (up to 999 points) where you want to play back once again later, and start playback from a marked position. Marking onto DVD-RAM/RW/R discs when recording is helpful to locate a start point when you play back the discs later.

To mark positions:

During playback, press **MARK** at positions you want to mark.

- "MARK" appears on the TV screen.
You can easily locate the marked positions using **◀◀** or **▶▶** when you play back the disc.

To delete the marked positions:

While paused, press **◀◀** or **▶▶** to locate a marked position you want to delete, then press **MARK**.

- Crossed "MARK" appears on the TV screen, and the marked position is deleted.

NOTES:

- When a monaural program changes to a stereo program while recording, a mark signal is automatically recorded.
- When a DVD-R/RW (Video mode) disc is finalized, marked points marked before finalizing will be deleted, and programs will be divided automatically into "chapters" approximately every 5 minutes. (☞ pg. 79)

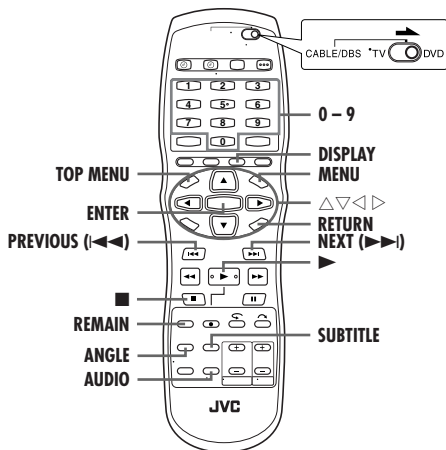

Checking The Time Information



You can check time information of a disc on the front display panel and the TV screen.

Press **DISPLAY** once to display the lastly displayed information. To change the display, press **DISPLAY** repeatedly.

■ DVD-RAM/DVD-R/DVD-RW

During playback or recording

Clock time (front display panel only) → Current title elapsed time → Disc remaining time* → (back to the beginning)

* only discs before finalizing

- Clock time is displayed only when a recordable disc is played back.

In stop mode

- It is possible to check disc remaining time according to recording modes also by pressing **REMAIN**.
- In FR mode, it is possible to set recording time in detail. While the recording mode and the disc remaining time are displayed by pressing **REMAIN**, press $\Delta \nabla$ to select "FR", then press $\triangleleft \triangleright$ to select the desired recording time. (☞ pg. 40)
- It is not possible to switch the recording mode during playback or while recording.

■ Video CD/Audio CD

During playback or in stop mode

Total remaining time → Current track elapsed time → Current track remaining time → Total elapsed time → (back to the beginning)

NOTE:

When a PBC-compatible Video CD disc is loaded, deactivate the PBC function. (☞ pg. 29)

Angle Selection



You can enjoy a variety of scene angles if a DVD VIDEO disc contains "multi-angle" parts, where the same scene was shot from different angles.

If the disc contains "multi-angle" parts, "ANGLE" appears on the TV screen at the beginning of the "multi-angle" part.

1 Press **ANGLE** during playback.

The angle selection display appears on the TV screen.



When 3 scene angles are contained.

2 Press **ANGLE** or $\triangleleft \triangleright$ to select your desired angle.

- Each time you press **ANGLE** or $\triangleleft \triangleright$, the angle changes.
- When "⊙" appears on the TV screen, the current scene is not recorded from multiple angles. In addition, some discs prohibit angle selection.

- To clear the angle selection display, press **ENTER**. In addition, the angle selection display disappears automatically if no operation is done for 10 seconds.

Subtitle Selection



Some DVD VIDEO discs contain more than one subtitle language, from among which you can choose the desired subtitle language. "SUB" appears on the TV screen at the beginning of the part where more than one subtitle language are recorded.

1 Press **SUBTITLE** during playback. The subtitle selection display appears on the TV screen.



When 3 subtitle languages are contained.

- Each time you press **SUBTITLE**, the subtitle display is switched on and off.

2 Press $\triangleleft \triangleright$ to select your desired language.

- To clear the subtitle selection display, press **ENTER**.

NOTES:

- When "⊙" appears on the TV screen, no subtitle language is recorded.
- When the subtitle language won't be changed with the procedure above, change the subtitle on a disc menu displayed by pressing **MENU**.

Audio Language/Sound Selection



Some DVD VIDEO discs contain the multiple audio language or sound. You can select the desired audio language or sound. For some Video CD discs, you can switch the audio channel to choose Karaoke either with or without the vocal.

1 Press **AUDIO** during playback.

The Audio Language/Sound selection display appears.



When 3 audio languages are contained.

2 Press **AUDIO** or $\triangleleft \triangleright$ to select your desired audio language/sound.

- Each time you press **AUDIO** or $\triangleleft \triangleright$, the audio language/sound changes.
- To clear the Audio Language/Sound selection display, press **ENTER**.

NOTES:

- When "⊙" appears on the TV screen, no audio language is recorded.
- When the audio language won't be changed with the procedure above, change the audio on a disc menu displayed by pressing **MENU**.
- It is only possible to select the audio language in stop mode. The audio language cannot be selected during playback.

Audio Channel Selection



When playing discs on which you recorded stereo programs, you can choose the desired audio channel.

- When "SUPERIMPOSE" is set to "AUTO", you can confirm on the TV screen the audio channel you have chosen. (pg. 74)
- Each time you press **AUDIO**, the audio channel changes.



| TRACK | USE |
|-------------------|----------------------------|
| On-Screen Display | |
| L+R | For stereo discs |
| L | For audio of left channel |
| R | For audio of right channel |

Playback Control (PBC) Function



Some Video CD discs support the PBC function. PBC is an abbreviation of "Play Back Control". A Video CD disc recorded with PBC has its own menus, such as a list of the songs on the disc. You can locate a specific scene by using the menu.

- 1 Press **▶** in stop mode. The PBC menu appears.
- 2 Press the **number keys** to enter the number of the desired scene. The unit starts playback of the selected item.
 - "PBC" appears on the front display panel.
 - When "NEXT" or "PREVIOUS" appears on the TV screen: Pressing **NEXT** (▶▶) advances to the next page. Pressing **PREVIOUS** (◀◀) returns to the previous page.
 - You can return to the menu by pressing **RETURN**.
 - The method of the operation is different depending on the disc.

NOTES:

- If you want to playback a PBC-compatible Video CD disc without activating the PBC function, start playback in stop mode by using the **number keys**, instead of the **▶** button, to choose the track, then press **ENTER**.
- To activate the PBC function when a PBC-compatible Video CD disc is being played back without the PBC function, press **TOP MENU**, or press **■** then press **▶**.

Live Memory Playback



This unit records pictures onto DVD-RAM discs, instead of video tapes, then plays back the pictures recorded on the discs. This makes it possible to achieve high-speed writing and read-out that has not been possible with conventional VCRs, enabling recording and playback simultaneously.

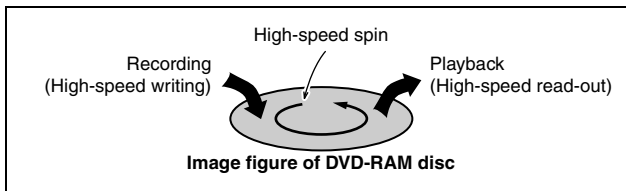

It is called "Live Memory Playback" to start playback of the program being recorded, with a time-lag between a recording point and a playback point, as shown in the figure below.

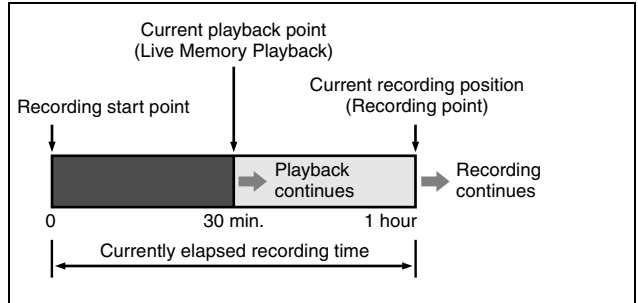

Not only can this unit playback a program previously recorded while recording or timer recording another program, but the unit also allows you to play back from the beginning of a program while continuing to record the same program.

Recording/playback Status Display

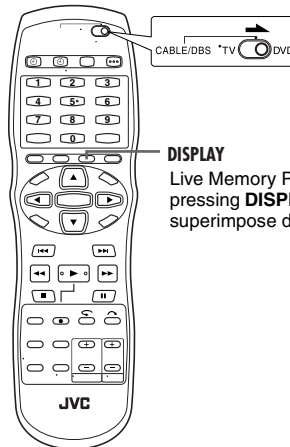

Press **DISPLAY**. The current status is superimposed on the TV screen.

Bar meter display

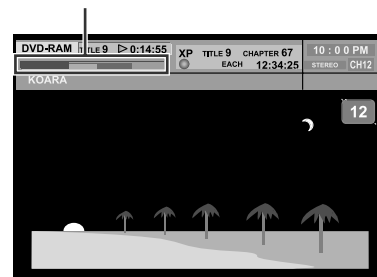

Superimpose display

Overview Of Live Memory Playback

You can play back a program you are recording from the beginning while continuing to record or timer record onto a DVD-RAM disc. This is called "Live Memory Playback".

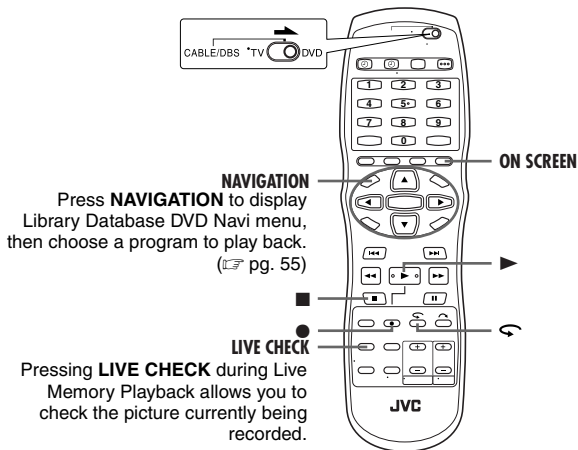
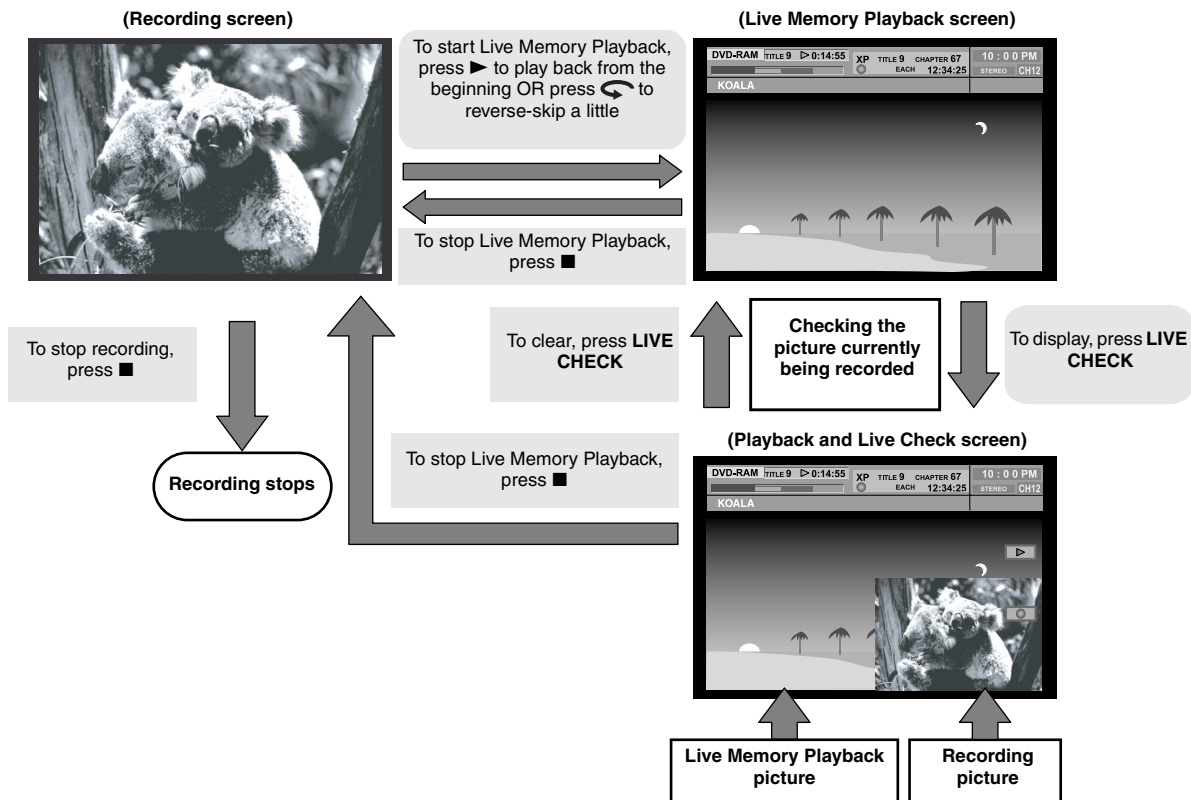

NOTES:

- Live Memory Playback cannot be performed for approximately 30 seconds after recording has started.
- Although high-speed search up to approximately 30 seconds before the current recording point is possible during Live Memory Playback, once the current recording point is reached, the unit resumes normal playback and maintains a delay of approximately 30 seconds so that recording and playback can continue.
- When using Live Memory Playback during timer recording, playback continues even after the end of the recording.
- When using Live Memory Playback during timer recording, playback is automatically stopped just before recording starts, and then recording starts when the time arrives for the next timer-program.
- It is impossible to perform ITR even if you press **●** during Live Memory Playback. (pg. 39)
Press **■** to display the program being recorded, then perform ITR settings.
- Playback may be paused for a moment during Live Memory Playback, which does not interfere with recording.
- Live Memory Playback cannot be performed while recording the source from DV input.
- When **LIVE CHECK** is pressed to display the picture currently being recorded, the picture size may not be correct.

Display During Live Memory Playback

During recording, you can watch at your will what was previously recorded or is currently being recorded. It is possible to perform freely normal playback operations (forward/reverse high-speed search and variable-speed search) within the range of the red or blue bar on the TV screen.

When Live Memory Playback reaches the point of 30 seconds before the current recording point by forward high-speed search or other operations, the unit returns to normal playback.

The superimpose display appears by pressing **ON SCREEN**. (pg. 15)

The Live Check picture is displayed on the bottom right corner by pressing **LIVE CHECK**.

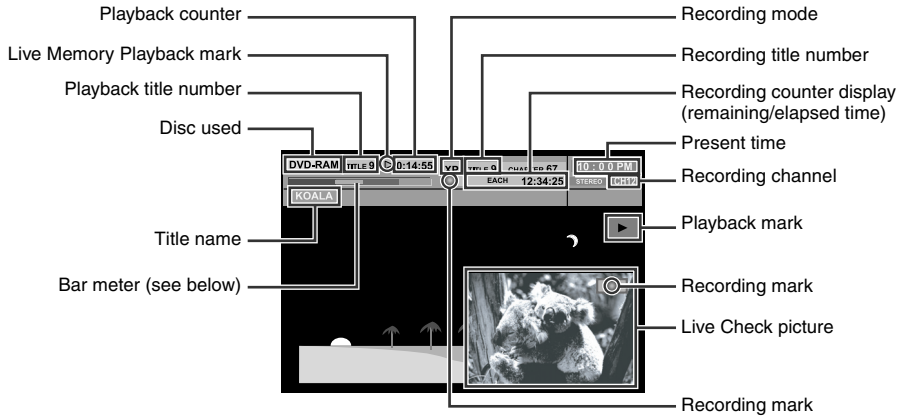

This unit displays the current recording/playback status by the bar meter.
(Example of bar meter display)

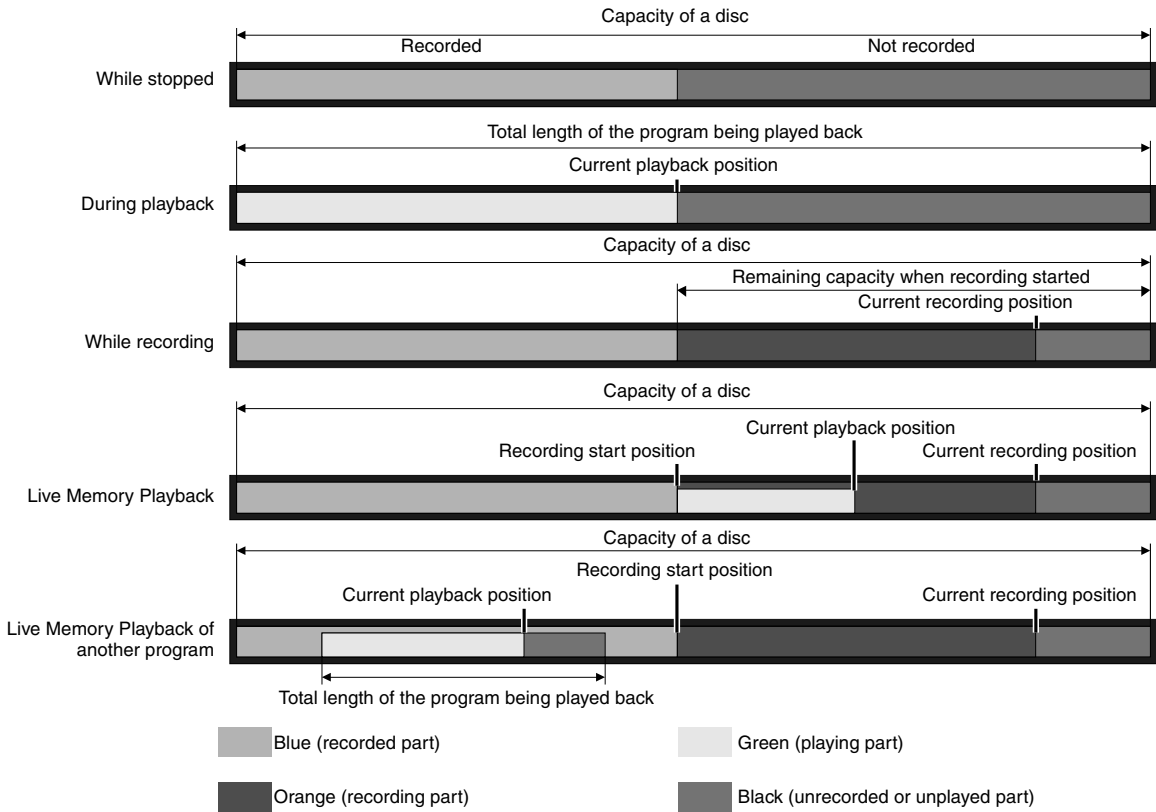

Buttons To Be Used During Live Memory Playback

- Turn on the unit.
- Turn on the TV and select the video channel (or AV mode).
- Slide the TV/CABLE/DBS/DVD switch to DVD.

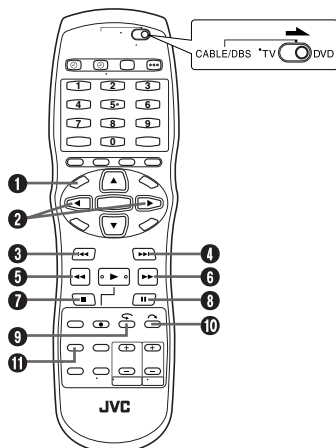

1 NAVIGATION

Displays Library Database DVD Navi menu. You can choose a program to play back.

2 ◀▶

Available only when paused

Advances/reverses the still picture frame by frame.

3 ◀◀

- Pressing once skips back to the beginning of the chapter being played back.
- Pressing down for 2 or more seconds during playback reverses playback at 5 times the normal speed while pressed. Releasing the button resumes normal playback.

Available only when paused

- Pressing down for 2 or more seconds reverses playback at 1/16 times the normal speed.

4 ▶▶

- Pressing once skips forward to the beginning of the next chapter being played back.
- Pressing down for 2 or more seconds during playback advances playback at 5 times the normal speed while pressed. Releasing the button resumes normal playback.

Available only when paused

- Pressing down for 2 or more seconds advances playback at 1/16 times the normal speed.

5 ◀◀◀

- Each press of the button during playback advances the playback speed in 5 steps for reverse direction.

Available only when paused

- Pressing once reverses playback by 1/16 times the normal speed.
- Each press of the button during reverse 1/16 times slow-motion reverses slow-motion by 1/16 times, 1/4 times and 1/2 times the normal speed.

6 ▶▶▶

- Each press of the button during playback advances the playback speed in 4 steps for forward direction.

Available only when paused

- Pressing once advances playback by 1/16 times the normal speed.
- Each press of the button during forward 1/16 times slow-motion advances slow-motion by 1/16 times, 1/4 times and 1/2 times the normal speed.

7 ■

Stops Live Memory Playback to return to the screen being recorded.

Then a resume point is stored.

Pressing ■ again stops recording.

8 II

Pressing once pauses playback (still picture playback). Pressing repeatedly advances the still picture frame by frame.

9 ↶

Pressing once skips back for approximately 7 seconds and resumes playback. Pressing repeatedly skips back continuously as many times as pressed. It is useful when watching sports programs, etc.

10 ↷

Pressing once skips forward for approximately 30 seconds and resumes playback. Pressing repeatedly skips forward continuously as many times as pressed. It is useful when skipping over unwanted sections.

11 LIVE CHECK

Pressing once displays the picture currently being recorded and the one being played back simultaneously. Pressing successively clears the Live Check window and displays only the picture currently being played back. You can check, for example, if the program you are recording has already finished.

To Play Back From The Beginning Of The Program While Recording

You can play back a program you are recording from the beginning while continuing to record or timer record onto a DVD-RAM disc. Press ▶. Live Memory Playback starts from the beginning of the program being recorded.

- Pressing ◀◀ or ▶▶ allows you to locate the desired scenes.

To Move Back The Playback Position Slightly While Recording (One Touch Replay function)

You can move back the playback position while continuing to record or timer record onto a DVD-RAM disc.

Press ↶.

- Each press skips back for approximately 7 seconds and resumes playback.
- Pressing while paused skips back for approximately 7 seconds and resumes pause.

To Watch A Program Previously Recorded While Recording

You can play back a program you recorded previously while recording.

1 Press ▶ during recording. Live Memory Playback starts.

2 Press ◀◀ or ▶▶ to locate the beginning of the desired program.

NOTE:

To stop playback, press ■. The program being recorded is displayed.

Using The On-screen Bar



The on-screen bar allows you to control various playback functions. Some of the functions operated on Navigation Menu can be controlled on the On-screen bar.

Be sure to clear Library Database DVD Navi screen by pressing **NAVIGATION**.

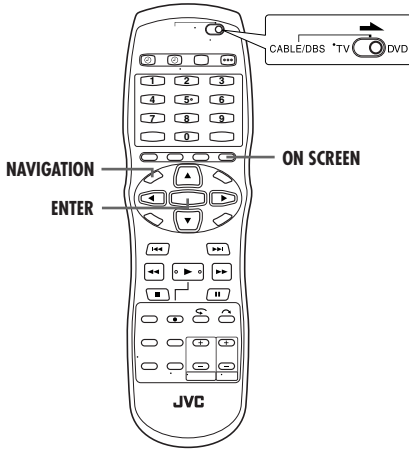

- 1 Disc type.
- 2 Select this for Repeat Playback. (pg. 34)
- 3 Select this for A-B Repeat Playback. (pg. 34)
- 4 Select this for search function. (pg. 34)
- 5 Select this for time search function. (pg. 35)
- 6 Select this to switch Simulated Surround Effect function. (pg. 35)
- 7 Select this for Picture Control function. (pg. 35)
- 8 Select this to switch picture source type. (pg. 36)
- 9 Current status area for the selected item.
- 10 Select this for Program Playback. (pg. 36)
- 11 Select this for Random Playback. (pg. 36)
- 12 Select this to control the switching interval of the slide show. (pg. 36)

NOTE:

Although examples of the on-screen bar are provided here only for 3 types of discs, the on-screen bar will be displayed for whichever disc indicated in the left column.

Basic Operation On The On-screen Bar

Example: When selecting Picture Control function of DVD

During playback or while stopped

1 Press **ON SCREEN** twice to access the on-screen bar. The item currently selected is highlighted and pointed by



2 Press to select "Picture Control", then press **ENTER**. The pop-up window appears under the selected item.



3 Press to select the desired option, then press **ENTER**.

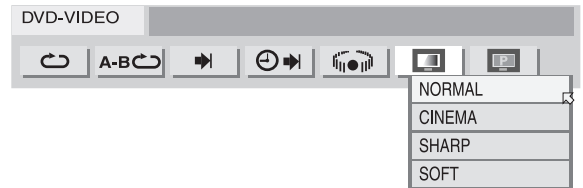

To clear the on-screen bar

Press **ON SCREEN**.

NOTE:

See the corresponding pages for details on each menu item.

How To Access The On-screen Bar

1 Press **ON SCREEN** whenever a disc is loaded.

Contents of the on-screen bar during playback

DVD VIDEO

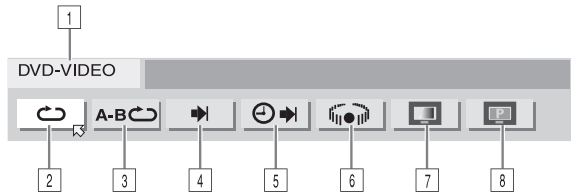

Video CD

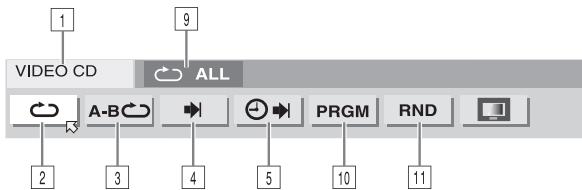

JPEG disc



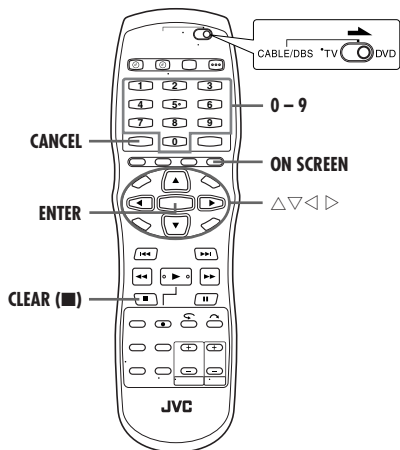

Repeat Playback



You can repeat playback as you like according to the type of disc.

- 1 Press **ON SCREEN** twice to access the on-screen bar.
- 2 Press $\triangleleft \triangleright$ to select "**↺**", then press **ENTER**. The pop-up window appears under the selected item.



- 3 Press $\triangle \nabla$ repeatedly to select the desired Repeat mode, then press **ENTER**.

DVD-RAM/RW/R

OFF: Repeat playback is not performed.

ALL REPEAT: The whole disc is played back repeatedly.

TITLE REPEAT: The current title is played back repeatedly.

DVD VIDEO

OFF: Repeat playback is not performed.

TITLE REPEAT: The current title is played back repeatedly.

CHAPTER REPEAT: The current chapter is played back repeatedly.

Audio CD/Video CD/JPEG/MP3

OFF: Repeat playback is not performed.

ALL REPEAT: The whole disc is played back repeatedly.

TRACK REPEAT*: The current track is played back repeatedly.

* "TRACK REPEAT" cannot be selected for JPEG discs.

To clear the on-screen bar

Press **ON SCREEN**.

To cancel Repeat Playback

Repeat the above procedure from step 1, select "OFF" in step 3, then press **ENTER**.

NOTES:

- Repeat Playback is not possible for a Video CD with PBC function.
- Repeat Playback may not work properly depending on the type of the disc being used.

A-B Repeat Playback



You can repeat the desired part.

During playback

- 1 Press **ON SCREEN** twice to access the on-screen bar.
- 2 Press $\triangleleft \triangleright$ to select "**A-B ↺**".
- 3 Press **ENTER** at the beginning of the desired part you want to repeat (point A). The elapsed playing time of the point A appears



- 4 Press **ENTER** at the end of the desired part you want to repeat (point B). The elapsed playing time of the point B appears.

- The selected part of the disc (between point A and B) is played repeatedly.



To clear the on-screen bar

Press **ON SCREEN**.

To cancel A-B Repeat Playback

Press $\triangleleft \triangleright$ to select "**A-B ↺**", then press **ENTER**.

NOTES:

- A-B Repeat Playback may not work properly depending on the type of disc being used.
- The subtitles recorded around the A-B point may not appear.
- When the end of the item is reached before the end point is set, the on-screen bar disappears from the TV screen. In such a case, repeat the procedure from step 1.
- The point B must be set at least 3 seconds after the point A.
- When playing back a DVD, A-B Repeat Playback is possible only within the same title.
- "**A-B ↺**" cannot be selected during Program and Random Playback.
- "**A-B ↺**" cannot be selected while stopped.

Locating The Beginning Of A Desired Selection



You can locate the beginning of a title, chapter, group or track.

During playback or while stopped

- 1 Press **ON SCREEN** twice to access the on-screen bar.
- 2 Press $\triangleleft \triangleright$ to select "**▶|**", then press **ENTER**.
- 3 Press $\triangle \nabla$ to select the desired item, then press **ENTER**.
 - Skip this step for Video CD and Audio CD.

For DVD-RAM/RW/R, DVD VIDEO

"TITLE SEARCH" or "CHAPTER SEARCH" is selectable. ("TITLE SEARCH" only is selectable while stopped.)

For JPEG, MP3

"GROUP SEARCH" or "TRACK SEARCH" is selectable.

For Video CD, Audio CD

"TRACK" is selectable.



4 Press the **number keys** to enter the desired item number, then press **ENTER**.

- Playback starts from the selected section.

Examples:

- 1 To select track 5, press the **number key** “5”.
- 2 To select track 15, press the **number key** “1” and “5”.
- 3 To select track 25, press the **number key** “2”, then “5”.

If you have specified a wrong selection

Press **CANCEL** or **CLEAR** (■) to clear the wrong number, then enter the correct one before you press **ENTER** in this step.

To clear the on-screen bar

Press **ON SCREEN**.

NOTES:

- When “⊙” is displayed on the TV screen in step 4, the chapter you have selected is not contained in the disc, or chapter search does not work on the disc.
- Before you press **ENTER**, playback may start automatically when you enter the section’s number depending on the disc.
- This function is not possible for a Video CD with PBC function.

Time Search



You can play back a disc from the desired point by specifying the elapsed playing time from the beginning of a title (DVD-RAM, DVD-R, DVD-RW and DVD VIDEO) or a disc (Video CD and Audio CD).

- 1 Press **ON SCREEN** twice to access the on-screen bar.
- 2 Press $\triangleleft \triangleright$ to select “⌚▶”, then press **ENTER**. The pop-up window appears under the selected item.



- 3 Press the **number keys** to enter the time, then press **ENTER**. Playback starts from the specified time.

Example:

To play back from a point 12 (minutes): 50 (seconds) elapsed.

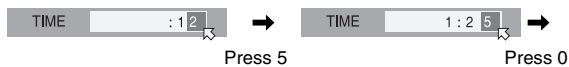

If you have specified a wrong selection,

Press **CANCEL** (for the last entered number) or **CLEAR** (■) (for whole numbers) to clear the wrong number, then enter the correct one(s) before you press **ENTER** in this step.

To clear the on-screen bar

Press **ON SCREEN**.

NOTES:

- When “⊙” is displayed on the TV screen in step 3, you have selected a point that exceeds the recording time of the disc.
- Some DVD VIDEO discs do not contain time information, and it is not possible to use the Time Search function. In such cases, “⊙” is displayed on the TV screen as well.
- This function is not possible for a Video CD with PBC function.

Simulated Surround Effect



It is possible to get a simulated surround effect from your stereo system. You can enjoy the virtual surround sound with your 2-channel stereo system.

- 1 Press **ON SCREEN** twice to access the on-screen bar.
- 2 Press $\triangleleft \triangleright$ to select “⌚▶”, then press **ENTER**.
 - Above the selected item, “3D-ON” appears and Simulated Surround Effect is activated.
 - Each time you press **ENTER**, “3D-ON” appears and disappears alternately.



To clear the on-screen bar

Press **ON SCREEN**.

To cancel the simulated surround effect

Press **ENTER** to clear “3D-ON” from the screen.

NOTES:

- The simulated surround effect works correctly only when playing back a title recorded in multichannels.
- Simulated Surround Effect does not affect the DVD VIDEO bitstream signal from the DIGITAL AUDIO OUTPUT connector.
- When Simulated Surround Effect is activated, the settings of “ANALOG AUDIO OUT” and “D. RANGE CONTROL” are disabled. (pg. 73)

Adjusting The Picture Quality



You can obtain optimal picture quality by selecting an appropriate picture mode.

- 1 Press **ON SCREEN** twice to access the on-screen bar.
- 2 Press $\triangleleft \triangleright$ to select “🖥️”, then press **ENTER**. The pop-up window appears under the selected item.



- 3 Press $\triangle \nabla$ to select the desired option, then press **ENTER**.

NORMAL: Normally select this option.

CINEMA: Suitable for a movie disc, etc.

SHARP: Clearer, sharper-edged picture when viewing images with lots of flat, same-colored surfaces such as cartoons.

SOFT: Select this option when too much noise appears.

To clear the on-screen bar

Press **ON SCREEN**.

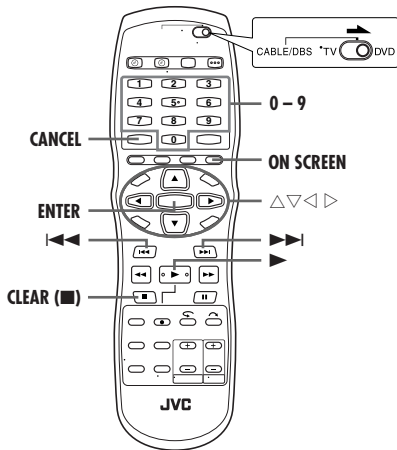

Setting The Progressive Mode



You can obtain optimal picture quality by selecting whether the content on the disc is processed by field (video source) or by frame (film source).

- 1 Press **ON SCREEN** twice to access the on-screen bar.
- 2 Press $\triangleleft \triangleright$ to select "P", then press **ENTER**. The pop-up window appears under the selected item.



- 3 Press $\triangle \nabla$ to select the desired option, then press **ENTER**.

AUTO 1: Used to play a disc containing both video and film source materials. This system recognizes the source type (video or film) of the current disc according to the disc information. Normally select this option.

AUTO 2: Almost the same as the "AUTO 1", but the processing of the scenes with movement is different. Select "AUTO 1" or "AUTO 2" to your preference.

FILM: Suitable for playing back a progressive scanned film source disc.

VIDEO: Suitable for playing back a video source disc. The outlines on the played back pictures will be soft.

To clear the on-screen bar
Press **ON SCREEN**.

Program Playback



You can play back up to 30 tracks in the desired order.

While stopped

- 1 Press **ON SCREEN** twice to access the on-screen bar.
- 2 Press $\triangleleft \triangleright$ to select "PRGM", then press **ENTER**. The program table appears under on-screen bar.



- 3 Press the **number keys** to enter the track numbers in the desired order.

Examples:

- 1 To select track 5, press the **number key "5"** and **ENTER**.



- 2 To select track 15, press the **number key "1"** and **"5"**.
- 3 To select track 25, press the **number key "2"** and **"5"**.

If you have specified a wrong selection

Press **CANCEL**. The last selection is erased.
 Or press **CLEAR** (■). The whole selection is erased.

- 4 Press **▶**. Playback starts in the programmed order.
 - When all of the programmed tracks have been played back, Program Playback stops, but the programmed information remains.
 - To add tracks to the end of the program, perform steps 1 through 3.
 - During Program Playback, pressing **▶▶** skips to the next selection of the program. Pressing **◀◀** returns to the beginning of the current selection.

To clear the on-screen bar and the contents of the program
 Press **ON SCREEN**.

To cancel Program Playback

Press $\triangleleft \triangleright$ to select "PRGM", then press **ENTER**.

NOTE:

Program Playback is not possible depending on the type of disc.

Random Playback



You can play back all the tracks on the disc in random order.

While stopped

- 1 Press **ON SCREEN** twice to access the on-screen bar.
- 2 Press $\triangleleft \triangleright$ to select "RND", then press **ENTER**. Playback starts in random order.



To clear the on-screen bar
 Press **ON SCREEN**.

To cancel Random Playback

Perform steps 1 and 2.

NOTE:

The same track will not be played back more than once during Random Playback.

Select The Switching Interval Of The Slide Show



You can control the switching interval of the slide show.

- 1 Press **ON SCREEN** twice to access the on-screen bar.
- 2 Press $\triangleleft \triangleright$ to select "10 SEC.", then press **ENTER**. The pop-up window appears under the selected item.



- 3 Press $\triangle \nabla$ to select the desired option, then press **ENTER**.
 - Each time you press $\triangle \nabla$, the interval changes as follows:
 5 SEC. ↔ 10 SEC. ↔ 15 SEC. ↔ 20 SEC. ↔ 25 SEC. ↔ 30 SEC. ↔ (Back to the beginning)

To clear the on-screen bar
 Press **ON SCREEN**.

Parental Lock



This function restricts playback of DVD VIDEO discs which contain violent (and other) scenes according to the level set by the user. For example, if a movie which includes violent scenes supports the parental lock feature, such scenes which you do not want to let children view can be cut or replaced by other scenes.

- Turn on the unit.
- Turn on the TV and select the video channel (or AV mode).
- Slide the TV/CABLE/DBS/DVD switch to DVD.

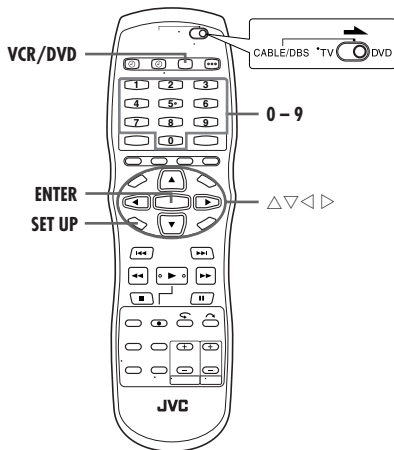

To Set Parental Lock For The First Time

While stopped

- 1 Press **VCR/DVD** repeatedly so that the DVD lamp lights up on the unit.
- 2 Press **SET UP** to access the Main Menu screen.
- 3 Press $\triangleleft \triangleright$ to select "DVD SET UP", then press **ENTER**.
- 4 Press $\triangleleft \triangleright$ to select "UTILITY", then press **ENTER**.
- 5 Press $\triangle \nabla$ to select "PARENTAL LOCK", then press **ENTER**.
- 6 Press $\triangle \nabla$ to select "PARENTAL LEVEL", then press **ENTER**.
- 7 Press $\triangle \nabla$ to select the desired level, then press **ENTER**.
 - The smaller the value of level is, the more restrictive the Parental Lock level becomes.
 - Select "NONE" to cancel the restriction.
- 8 Press the **number keys** to enter your desired four-digit number, then press **ENTER**.
 - If you made a mistake, enter a correct number again.
- 9 Press $\triangle \nabla$ to select "COUNTRY CODE", then press **ENTER**.
- 10 Press $\triangle \nabla$ to select your country code, then press **ENTER**.
 - If you do not need to change your country code, jump to 12.
 - See "Country/Area Code List for Parental Lock" (pg. 89)

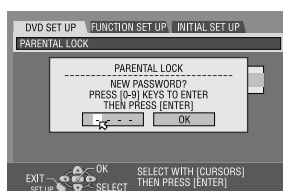
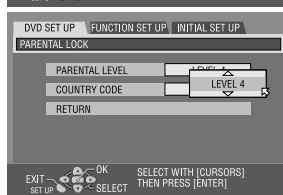
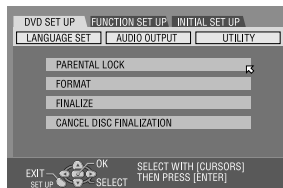

11 Press the **number keys** to enter the same password as in step 8 above, then press **ENTER**.

12 Press **SET UP** twice to complete the setting.

NOTE:

Remember your password, or make a note of it.

To Change The Settings

You can change the Parental lock settings later.

1 Perform steps 1 to 5 of "To Set Parental Lock For The First Time" to access the "PARENTAL LOCK" screen before continuing.

To change the level

2 Press $\triangle \nabla$ to select "PARENTAL LEVEL", then press **ENTER**.

3 Press $\triangle \nabla$ to select the desired level, then press **ENTER**.

To change the country code

4 Press $\triangle \nabla$ to select "COUNTRY CODE", then press **ENTER**.

5 Press $\triangle \nabla$ to select your country code, then press **ENTER**.

- See "Country/Area Code List for Parental Lock" (pg. 89).

6 Press the **number keys** to enter the same password as in step 8 of "To Set Parental Lock For The First Time", then press **ENTER**.

7 Press **SET UP** twice to complete the setting.

NOTE:

If you forget your password, enter "8888" in step 6.

To Temporarily Release Parental Lock

When you set the parental lock level strictly, some discs may not be played back at all. When you insert such a disc and try to play it back, the confirmation screen appears on the TV screen, asking you whether you want Parental Lock to be temporarily released or not.

1 Load a disc.

- If the disc is rated higher than the selected level, the confirmation screen appears.

2 Press $\triangleleft \triangleright$ to select "YES", then press **ENTER**.

- If you select "NO", you cannot play back that disc.

3 Press the **number keys** to enter the same password as in step 8 of "To Set Parental Lock For The First Time", then press **ENTER**.

- When you enter the correct password, the Parental Lock is released and the unit starts playback.

- If you enter a wrong password, "ENTRY ERROR RETRY" appears on the TV screen. Enter the correct password.

- If you have successively entered wrong password three times, "ENTRY ERROR CAN NOT CHANGE PASSWORD" appears on the TV screen. In such a case, press **ENTER**. The disc will stop. Then play back the disc again, and try the procedure again from step 1.

NOTE:

If you forget your password, enter "8888" in step 3.

Basic Recording



- Turn on the unit.
- Turn on the TV and select the video channel (or AV mode).
- Slide the TV/CABLE/DBS/DVD switch to DVD.

ATTENTION:
It is not possible to record programs on a DVD-R disc which has already been finalized.

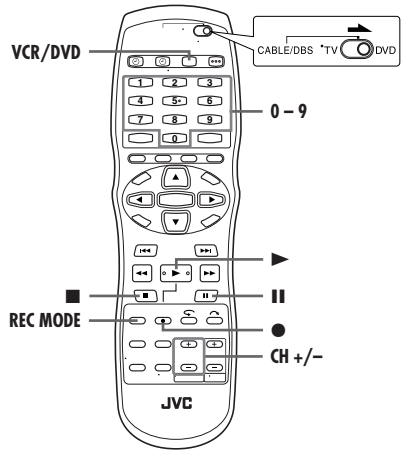
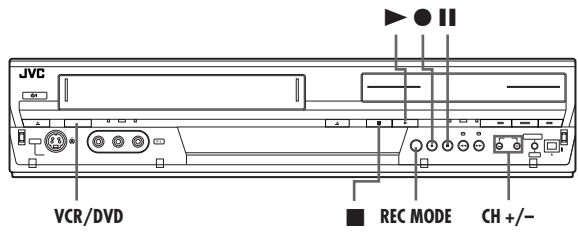

- 1 Load a recordable disc.
 - For details, refer to "Placing A Disc" (pg. 11).
- 2 Press **VCR/DVD** repeatedly so that the DVD lamp lights up on the unit.
- 3 Press **CH +/-** or the **number keys** to select the channel you wish to record.
- 4 Press **REC MODE** repeatedly to set the recording mode.
 - Each time you press **REC MODE**, the recording mode changes as follows:
 XP → SP → LP → EP → FR → (Back to the beginning)
 - * The value is selectable from 1 to 6 hours in 5-min. increment, from 7 to 8 hours in 1-hour increment by pressing <◁▷> repeatedly after selecting "FR60-FR360", "FR420" and "FR480". To change the value in 30-min. increments, press and hold <◁▷>.
 - For details on the recording mode, see the right column.
- 5 Press ● on the unit to start recording. Or press and hold ● and press ► on the remote control.
 - The DVD recording lamp lights up on the unit.
- 6 Press ■ to pause recording.
 - To resume recording, press ►.
- 7 Press ■ to stop recording.
 - The DVD recording lamp lights off on the unit.
 - It takes about 10 seconds to end the writing session when you stop recording.

- NOTES:**
- It is recommended to format a DVD-RAM disc before use if you use the disc on this unit for the first time.
 - When using a brand-new DVD-RW disc, format the disc either in VR mode or in Video mode. (pg. 78)
 - Recordings made on DVD-R/RW disc must be finalized to play back on other DVD players. Perform "Finalize A Disc (DVD Deck Only)" (pg. 79)
 - You can record up to 99 programs and 999 play lists on each disc.
 - Some programs can only be recorded one time.
 - When recording is started, an index of the first part of recording is automatically recorded. (pg. 55) To record satellite programs, refer to page 46. To delete the index, refer to page 57.
 - Recording sometimes may stop or cannot be performed even if there is enough available capacity remaining on the disc.

Recording Resume Function

If there is a power outage during recording, Instant Timer Recording (ITR) (pg. 39) or timer recording (pg. 41, 42, 43), the recording will resume automatically when power is restored to the unit unless the unit's memory backup has expired.

Recording Mode

MPEG2 format is used as recording format. As a guide for picture quality, the "bps" unit is used to represent how much data can be recorded per second. The larger this value is, the better the picture quality becomes but more capacity is required for the recording. Select XP or SP for programs where quick movement occurs, such as sports programs, and LP or EP for talk shows, etc. with relatively less movement.

The recording modes for a 4.7 GB disc are set as follows:

| Recording mode | Recording amount (approx.) | Maximum recording time (approx.) |
|---------------------|---|----------------------------------|
| XP | 10 Mbps | 1 hour |
| SP | 5 Mbps | 2 hours |
| LP | 2 Mbps | 4 hours |
| EP | 1.6 Mbps | 6 hours |
| FR60-FR360 (pg. 40) | The amount varies depending on the selected time. | 1 - 6 hours |
| FR420 | | 7 hours |
| FR480 | | 8 hours |

Recording Features



- Turn on the unit.
- Turn on the TV and select the video channel (or AV mode).
- Slide the **TV/CABLE/DBS/DVD** switch to **DVD**.
- Press **VCR/DVD** repeatedly so that the DVD lamp lights up on the unit.

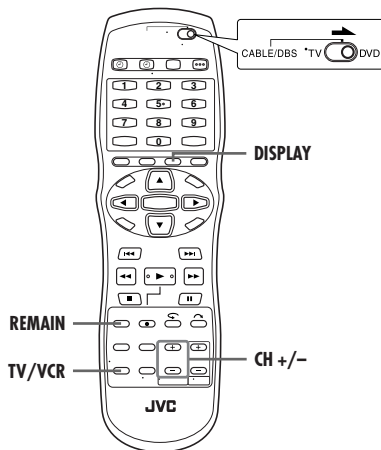
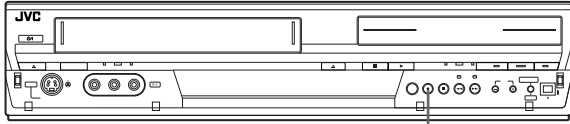

Instant Timer Recording (ITR)

This easy method lets you record for from 30 minutes to 6 hours (selectable in 30-min. increments), and shuts the unit off after recording is finished.

- 1 Press **●** on the unit to start recording.
- 2 Press **●** again to engage the ITR mode.
 - On the front display panel, "0:30" appears.
- 3 If you want to record for more than 30 minutes, press **●** to extend the time. Each press extends recording time by 30 minutes.

NOTES:

- You can only perform ITR using the **●** button on the unit.
- When the recording capacity becomes full during timer recording or Instant Timer Recording, the unit is automatically shut off.

Watch Another Program While Recording On The Unit

While recording is going on, you can watch another program on the TV by using the TV's tuner.

NOTE:

It is required that the remote control is set to be able to operate the TV in advance. (☞ pg. 70)

- 1 During recording, press **TV/VCR** to select TV mode if your unit is connected to the TV via the RF connection.
- VCR mode is disengaged, then the VCR indicator lights off and "TV" appears on the front display panel.



VCR indicator lights off.

- The program received on the TV's tuner is displayed on the TV screen.

- 2 Slide the **TV/CABLE/DBS/DVD** switch to **TV**.

- 3 Press **CH +/-** repeatedly to select the desired channel.

Elapsed Recording Time And Disc Remaining Time Indication

During recording, press **DISPLAY** repeatedly until the desired indication appears on the front display panel.

- Each time you press **DISPLAY**, the time indication changes as follows:
Elapsed recording time → Disc remaining time → Clock → (Back to the beginning)
- There is another way to check the disc remaining time. While the unit is stopped or recording is in progress, press **REMAIN**. The list of disc remaining times for all recording modes appears on the TV screen.

Free Rate Function

To record the entire program, the unit automatically set the appropriate recording mode depending on the combination of the total time of the program to be recorded and either the remaining disc space or the specified recording time (from 60 minutes to 480 minutes).

■ To record the entire program within the actual remaining disc space

Select "FR (JUST)" in a recording mode selection procedure. (☞ pg. 41, 42)

- Note that this function is available only for timer programming recording.

■ To record the entire program by specifying the desired recording time

Select "FR60-FR360", "FR420" or "FR480" in a recording mode selection procedure. (☞ pg. 38, 41, 42)

■ To record a 25-min. long daily program five times just on a same disc for example

Perform "VCR Plus+" Timer Programming" (☞ pg. 41) procedure. Be sure to set the recording mode to "FR125" and set Weekly/Daily Rec Function to "MON-FRI" in step 6 to fit the total recording time to the whole disc space.

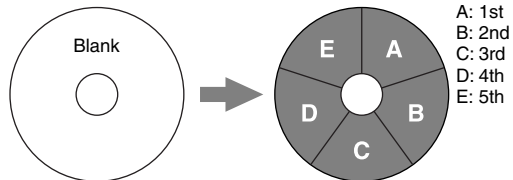

When the same program is recorded in SP mode instead of in "FR125", the 5th program cannot be recorded.

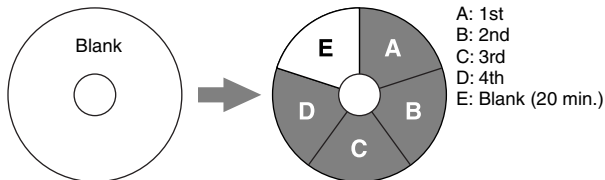

NOTES:

- You can program this unit to timer-record, regardless of the disc remaining time. When the disc remaining time is not enough, recording may stop in the middle of a program. To avoid this, make sure of the disc remaining time before setting timer-programing. **(Example)** If you programed to timer-record for 60 minutes in SP mode on a 120-minute disc, the disc remaining time would be 30 minutes in XP mode, 60 minutes in SP mode, 120 minutes in LP mode, 180 minutes in EP mode, and 240 minutes in FR480 mode. Timer-recording will not complete beyond these remaining times.
- The maximum recording time of FR (JUST) mode is the same as the recording time of FR480 mode. When timer-programing a long program in FR (JUST) mode on a disc whose remaining time is short, it is recommended checking the disc remaining time in FR480 mode to see if the remaining time is enough for the program.
- Even if more than one program are timer-programed in FR (JUST) mode, only the first one is recorded.
- In order to ensure that the recording fits on the disc, this feature may leave a slight non-recorded section at the end of the disc.
- There may be some noise and sound disturbance at the point on the disc where the unit switches the mode.

Second Audio Recording

This unit's built-in MTS decoder enables reception of Multichannel TV Sound broadcast. To record a SAP program received, set "2ND AUDIO RECORD" to "ON". (☞ pg. 74)

NOTE:

When the channel is changed on the unit;

- The "MONO" indicator appears on the screen for about 5 seconds if the program is a monaural broadcast.
- The "STEREO" indicator appears on the screen for about 5 seconds if the program is a stereo broadcast.
- Both "STEREO" and "SAP" indicators appear when a stereo program is accompanied by SAP sound.
- Both "MONO" and "SAP" indicators appear when the main audio on the monaural broadcast is accompanied by SAP sound.

VCR Plus+® Timer Programming



You can program this unit to timer-record as many as 8 programs. With the VCR Plus+ system, timer programming is greatly simplified because each TV program has a corresponding code number which your unit is able to recognize.

You can use the remote control to enter the PlusCode number.

- Make sure that the unit's built-in clock is set properly.
- Turn on the unit.
- Turn on the TV and select the video channel (or AV mode).
- Slide the **TV/CABLE/DBS/DVD** switch to **DVD**.

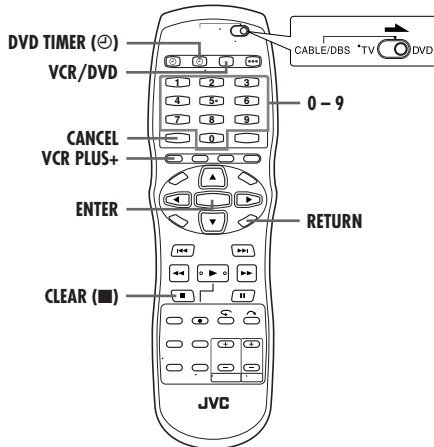

- 1 Load a recordable disc.
- 2 Press **VCR/DVD** repeatedly so that the DVD lamp lights up on the unit.
- 3 Press **VCR PLUS+** to access the VCR Plus+ screen.

4 Press the **number keys** to enter the PlusCode number of a program you wish to record, then press **ENTER**.

- If you have made a mistake, press **CANCEL** and input the correct number before you press **ENTER**.
- To clear all entered numbers at a time, press **CLEAR(■)**.
- If the number you entered is invalid, "PLUSCODE NO. ERROR CONFIRM PLUSCODE NO. THEN RETRY" appears on the TV screen. Input a valid PlusCode number.
- If "GUIDE PROGRAM IS NOT SET SELECT CHANNEL YOU WANT TO RECORD" appears on the TV screen, set Guide Channel Numbers manually. (☞ pg. 77)
- When "PROGRAM FULL DELETE UNWANTED TIMER PROGRAM" appears on the TV screen, you need to cancel some of the reserved programs. (☞ pg. 45)

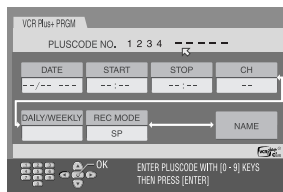

5 The PlusCode number you entered and the matching timer-recording information are displayed on the TV screen. Check the program data.

- To cancel this setting, press **VCR PLUS+** or **RETURN**.

IMPORTANT:

Make sure the channel position number you wish to record is displayed; if not, see "Changing VCR Plus+ Setting" (☞ pg. 77) and set the Guide Channel number correctly.

- 6 Press **◀▶** to select the desired recording option as required. Press **△▽** to select the desired setting, then press **ENTER**.
 - "STOP" (To advance/go back the stop time by 30 minutes, press and hold **△▽**).
 - "DAILY/WEEKLY" (☞ pg. 41, "Daily/Weekly Recording")
 - "REC MODE" (☞ pg. 38, "Recording Mode")
 - "NAME" (☞ pg. 57, "Modify Program Name")

7 Press **ENTER** to access the Program Confirmation screen.

8 Press **ENTER** to complete timer programming.

- To program another timer, repeat steps 3 – 8.
- If "PROGRAM OVERLAPPED" appears on the TV screen, see page 45.

9 Press **DVD TIMER (⊙)** to engage the unit's timer mode. The DVD timer lamp lights up on the unit and the VCR deck is automatically selected. When the VCR deck is in timer standby mode, the unit is automatically turned off.

- To disengage the timer mode, press **DVD TIMER (⊙)** again.

NOTES:

- There may be cases that VCR Plus+ Timer Programming function prolongs the stop time of the programming.
- When two successive programs are recorded on a DVD-RW disc with VCR Plus+ Timer Programming function, the beginning of the second one may be left off the recording.
- VCR Plus+ Timer Programming is not possible on the discs used exclusively for On-Disc Timer Programming.
- If the copy limited program is received during timer-recording, the unit enters Record Pause mode. Recording starts again if it is switched to a recordable broadcast during the time you programmed.

IMPORTANT:

If you have moved to a different area or if a broadcasting station's channel number has been changed, the wrong channel number will be displayed on the VCR Plus+ program screen in step 5. When this happens, set the correct Guide Channel number for that station. (☞ pg. 77, "Changing VCR Plus+ Setting")

Cable Box and DBS Receiver Users

To timer-record a satellite broadcast using the VCR Plus+ system:

- 1 Perform "Cable Box and/or DBS Receiver Control Setting (DVD Deck Only)" (☞ pg. 22).
- 2 Perform "VCR Plus+ Timer Programming" (☞ pg. 41).
- 3 Leave the cable box or DBS receiver's power on.

Daily/Weekly Recording

You can record programs with one of the following weekly/daily timer settings.

WEEKLY: Select to record a weekly program.

MON-FRI: Select to record a daily program from Monday through Friday.

MON-SAT: Select to record a daily program from Monday through Saturday.

SUN-SAT: Select to record a daily program from Sunday through Saturday.

Manual Timer Programming



You can program this unit to timer-record as many as 8 programs. If you do not know the PlusCode number for the program you wish to record, use the following procedure to set your unit to timer-record the program.

- Make sure that the unit's built-in clock is set properly.
- Turn on the unit.
- Turn on the TV and select the video channel (or AV mode).
- Slide the **TV/CABLE/DBS/DVD** switch to **DVD**.

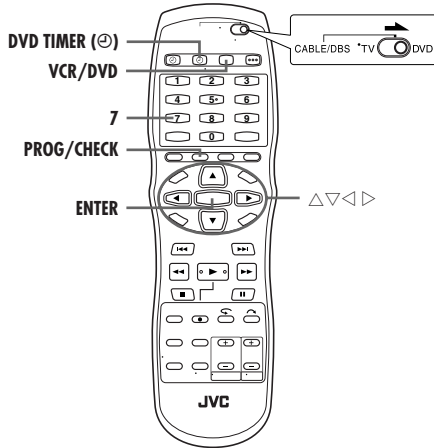

- 1 Load a recordable disc.
- 2 Press **VCR/DVD** repeatedly so that the DVD lamp lights up on the unit.
- 3 Press **PROG/CHECK** to access the Program Check screen.
 - When "PROGRAM FULL DELETE UNWANTED TIMER PROGRAM" appears on the TV screen, you need to cancel some of the reserved programs. (➡ pg. 45)
- 4 Press $\Delta \nabla$ to select "NEW TIMER PROGRAM", then press **ENTER**. The program screen appears.
- 5 Press $\Delta \nabla$ to set the desired date.
 - The current date appears on the TV screen. The date you enter appears in its place.
- 6 Press $\triangleleft \triangleright$ to select "START", then press $\Delta \nabla$ to set the desired start time.
 - Each press of $\Delta \nabla$ advances/goes back the start time in 1-min. increments.
 - To advance/go back the start time in 30-min. increments, press and hold $\Delta \nabla$.
- 7 Press $\triangleleft \triangleright$ to select "STOP", then press $\Delta \nabla$ to set the desired stop time.
 - Each press of $\Delta \nabla$ advances/goes back the stop time in 1-min. increments.
 - To advance/go back the stop time in 30-min. increments, press and hold $\Delta \nabla$.
- 8 Press $\triangleleft \triangleright$ to select "CH", then press $\Delta \nabla$ to select the desired channel.
 - If you are using a DBS receiver, see "ATTENTION FOR DBS RECEIVER USERS" in the right column.
- 9 Set the other recording options as required.
 - Refer to step 6 in "VCR Plus+™ Timer Programming" (➡ pg. 41).



10 Press **ENTER** to access the Program Confirmation screen.

11 Press **ENTER** to complete timer programming.

- To program another timer, repeat steps 3 – 11.

12 Press **DVD TIMER** (Ⓢ) to engage the unit's timer mode. The DVD timer lamp lights up on the unit and the VCR deck is automatically selected. When the VCR deck is in timer standby mode, the unit is automatically turned off.

- To disengage the timer mode, press **DVD TIMER** (Ⓢ) again.

NOTES:

- When two successive programs are recorded on a DVD-RW disc with Manual Timer Programming function, the beginning of the second one may be left off the recording.
- If the copy limited program is received during timer-recording, the unit enters Record Pause mode. Recording starts again if it is switched to a recordable broadcast during the time you programmed.

Cable Box and DBS Receiver Users

To timer-record a satellite broadcast using Manual Timer Programming:

- 1 Perform "Cable Box and/or DBS Receiver Control Setting (DVD Deck Only)" (➡ pg. 22).
- 2 Perform "Manual Timer Programming" (➡ pg. 42).
- 3 Leave the cable box or DBS receiver's power on.

ATTENTION FOR DBS RECEIVER USERS

If you are using a DBS receiver (unless "DBS RECEIVER SET" is set to "OFF" ➡ pg. 22), the band indication (TV, CATV or DBS) appears on the left of the channel number indication. No indication: To timer-record a regular TV broadcast received on the unit.

CATV: To timer-record a cable TV broadcast received on the unit, or through a cable box (unless "CABLE BOX SET" is set to "OFF" ➡ pg. 22).

DBS: To timer-record a satellite broadcast received through a DBS receiver.

NOTE:

If the channel number entered requires that the band be set, "7=DBS" is displayed on the screen. If this happens, press the **number key "7"** to select "DBS".

On-Disc Timer Programming



On-Disc Timer Programming is a function used with discs that are especially intended for a specific program. The disc is then programmed for a program you always watch every day or every week. Since older programs are automatically overwritten, a single DVD-RAM/RW (VR mode) disc can be used without worrying about how much recording capacity remains. (☞ pg. 44)
You can program each disc to timer-record as many as 8 programs.

- Make sure that the unit's built-in clock is set properly.
- Turn on the unit.
- Turn on the TV and select the video channel (or AV mode).
- Slide the **TV/CABLE/DBS/DVD** switch to **DVD**.

ATTENTION:

- On-Disc Timer Programming is possible only with the disc for On-Disc Timer Programming.
- If data is recorded on a disc for On-Disc Timer Programming using a unit from another manufacturer, On-Disc Timer Programming may no longer function properly.

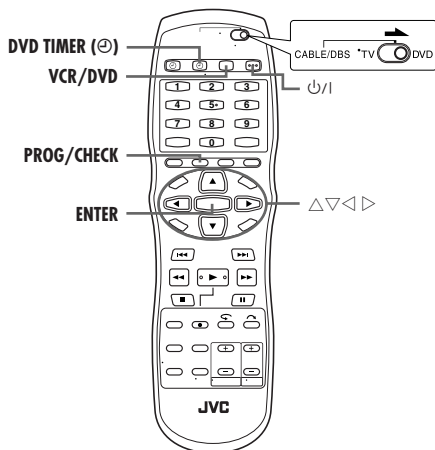

To Make The Disc For On-Disc Timer Programming

- 1 Load a recordable disc.
- 2 Press **VCR/DVD** repeatedly so that the DVD lamp lights up on the unit.
- 3 Press **PROG/CHECK** to access the Program Check screen.
- 4 **When On-Disc Timer Programming is made for the first time on the disc**
Press $\triangle\nabla$ to select "DISC TIMER PRGM", then press **ENTER**.
• When some programs are recorded on the disc, a caution message appears. In such a case, backup the programs as required, then format the disc before making On-Disc Timer Programming. (☞ pg. 78)

When On-Disc Timer Programming has already been made on the disc

- Press $\triangle\nabla$ to select "NEW TIMER PROGRAM", then press **ENTER**.
- 5 Press $\triangle\nabla$ to set the desired date.
 - The current date appears on the TV screen. The date you enter appears in its place.
 - 6 Press $\triangleleft\triangleright$ to select "START", then press $\triangle\nabla$ to set the desired start time.
 - Each press of $\triangle\nabla$ advances/goes back the start time in 1-min. increments.
 - To advance/go back the start time in 30-min. increments, press and hold $\triangle\nabla$.

- 7 Press $\triangleleft\triangleright$ to select "STOP", then press $\triangle\nabla$ to set the desired stop time.
 - Each press of $\triangle\nabla$ advances/goes back the stop time in 1-min. increments.
 - To advance/go back the stop time in 30-min. increments, press and hold $\triangle\nabla$.
- 8 Press $\triangleleft\triangleright$ to select "CH", then press $\triangle\nabla$ to select the desired channel.
 - If you are using a DBS receiver, see "ATTENTION FOR DBS RECEIVER USERS" (☞ pg. 42).
- 9 Set "DAILY/WEEKLY" option.
 - Refer to step 6 in "VCR Plus+ Timer Programming" (☞ pg. 41).
 - It is necessary to set "DAILY/WEEKLY" option for On-Disc Timer Programming. (☞ pg. 41, "Daily/Weekly Recording")
- 10 Set the other recording options as required.
 - You can select XP, SP, LP, EP or FR480 mode for "REC MODE". However, you cannot select FR (JUST), FR60-FR360 and FR420.
 - Refer to step 6 in "VCR Plus+ Timer Programming" (☞ pg. 41).
 - It is not possible to use the Free Rate function. (☞ pg. 40)
- 11 Press **ENTER** to access the Program Confirmation screen.
- 12 Press **ENTER** to complete timer programming.
 - To program another timer, repeat steps 3 – 12.

Cable Box and DBS Receiver Users

To timer-record a satellite broadcast using the On-Disc Timer Programming function:

- 1 Perform "Cable Box and/or DBS Receiver Control Setting (DVD Deck Only)" (☞ pg. 22).
- 2 Perform "On-Disc Timer Programming" (☞ pg. 43).
- 3 Leave the cable box or DBS receiver's power on.

To Timer-record The Program With The Programed Disc

- 1 Load a programed disc.
- 2 Press **DVD TIMER** (⊙). The unit turns off and "DISC" appears on the front display panel. The DVD timer lamp also lights up on the unit and the VCR deck is automatically selected. When the VCR deck is in timer standby mode, the unit is automatically turned off.
 - To disengage the timer mode, press ⏻ again.

NOTES:

- Even if On-Disc Timer Programming is overlapping with other timer programming, any caution message does not appear. In such a case, recording will be executed in the descending order of the recording start time of the program.
- On-Disc Timer Programming is not possible on a DVD-RW disc formatted in video mode. (☞ pg. 78)
- The information of a program recorded with On-Disc Timer Programming is not stored in the library. (☞ pg. 60)
- The play list is not created for the programs recorded with On-Disc Timer Programming. (☞ pg. 58)
- VCR Plus+ Timer Programming is not possible on the discs used exclusively for On-Disc Timer Programming.
- Manual Timer Programming is not possible on the On-Disc Timer Programed disc. (☞ pg. 42)
- Basic Recording is not possible on the On-Disc Timer Programed disc. (☞ pg. 38)
- The On-Disc Timer Programming function does not work on the unit from other manufactures even if the On-Disc Timer Programed disc is loaded.
- The beginning of a program may not be recorded. Also, if the 1st program's recording stop time and the 2nd program's recording start time is the same, the ending of the 1st program may not be recorded.
- If there is a power cut while recording, the recordings before the power cut are not guaranteed.

How Discs Are Overwritten

(Example 1)

To record a 1-hour serial drama every Friday in SP mode

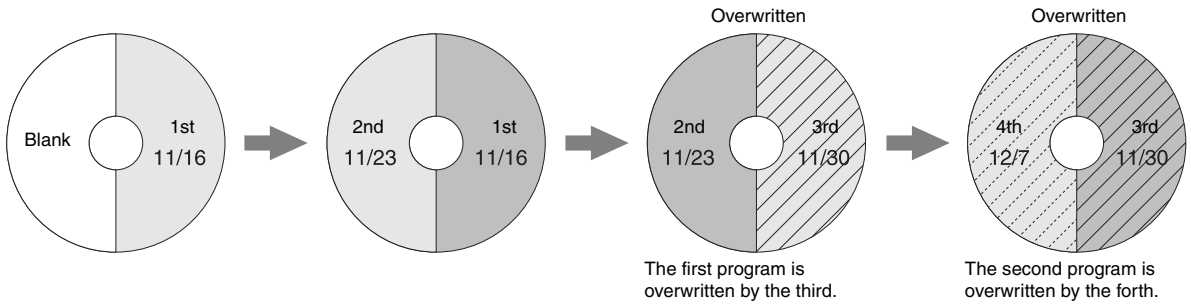

(Example 2)

To record a 15-minute serial drama every morning in XP mode

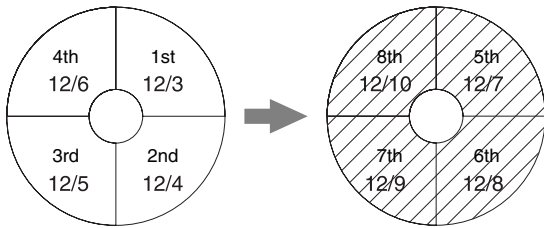

(Example 3)

To record a 90-minute serial drama every Sunday in SP mode

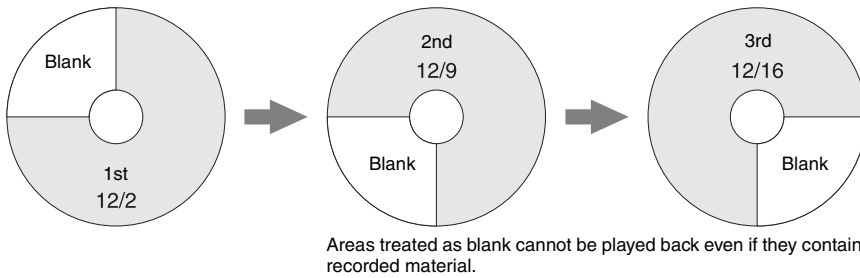

NOTE:

On-Disc Timer Programming may not always work as these examples.

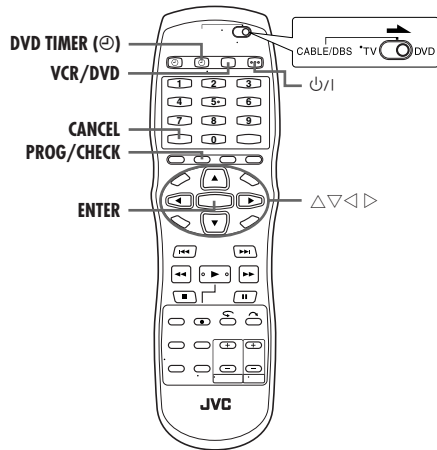

Check, Cancel And Change Programs

1 When the DVD timer lamp lights on the unit Press **DVD TIMER** (⊙), then press **⏻/⏮**.

When “**DISC**” lights on the front display panel and the DVD timer lamp also lights up on the unit.

Press **⏻/⏮**.

When “**R-LK**” lights on the front display panel Press **REC LINK** on the unit, then press **⏻/⏮**.

When the DVD lamp does not light up on the unit Press **VCR/DVD** repeatedly so that the DVD lamp lights up on the unit.

2 Press **PROG/CHECK** to access the Program Check screen.

- To return to the previous screen after you check the program, press **PROG/CHECK** again.

To cancel the program

Press **Δ/∇** to select a program to be cancelled, then press

CANCEL.

3 Press **Δ/∇** to select the program, then press **ENTER**. The program screen appears.

4 Change the settings of the desired recording options as required.

- Refer to steps 5 – 10 in “Manual Timer Programming” (ⓘ pg. 42).

5 Press **PROG/CHECK** to complete timer correction. The previous screen resumes.

6 For **VCR Plus+**, **Manual or On-Disc Timer Programming** Press **DVD TIMER** (⊙).

For Automatic Satellite Program Recording

Press **REC LINK** on the unit for 2 seconds or more.

- The DVD timer lamp also lights up on the unit and the VCR deck is automatically selected. When the VCR deck is in timer standby mode, the unit is automatically turned off.

| DATE | START | STOP | CH | DAILY/WEEKLY | REC MODE |
|-------------------------------|---------|---------|----|--------------|----------|
| 0507 SAT | 7:00PM | 8:00PM | 44 | WEEKLY | SP |
| 1007 THU | 10:00PM | 10:00PM | 10 | XP | XP |
| 1107 FRI | 8:00AM | 8:00AM | 26 | LP | LP |
| ***** NEW TIMER PROGRAM ***** | | | | | |

Program's information on the front display panel

You can check the details of the programs even when the power is turned off. (It is necessary that the Power Save mode (ⓘ pg. 74) is disengaged or the unit is not in timer standby mode.) However, it is not possible to cancel or change the program's setting.

1 Press **PROG/CHECK**.

- “NEW PROG” or “P-1” (if 8 programs have already been set) appears.

2 Press **Δ/∇** until the desired program number (“P-1” to “P-8”) appears, then press **ENTER**.

3 Press **▷**.

- Each time you press **▷**, the indication changes as follows (the settings in parentheses are examples):

Date (“DATE 03.08SU”) → Start time (“ON 11:00”) → Stop time (“OFF 11:30”) → Channel (“CH 1”) → Weekly/Daily (“MO-FR DAILY”) → Program number (“P-1”) and recording mode (SP) → (Back to the beginning)

4 Press **PROG/CHECK** to complete checking.

- The normal display resumes.

When Programs Overlap Each Other

If “PROGRAM OVERLAPPED” appears, you have another program overlapping the program you have just made.

Confirm with the arrow on “OK”, then press **PROG/CHECK**.

Program Check screen appears and conflicting programs will be highlighted in pink.

Example: Program 3 (you have just made) and Program 4 overlap each other.

1 Confirm the overlapping programs. Overlapping programs appear on the TV screen.

| DATE | START | STOP | CH | DAILY/WEEKLY | REC MODE |
|-------------------------------|---------|---------|----|--------------|----------|
| 0507 SAT | 7:00PM | 8:00PM | 44 | WEEKLY | SP |
| 1007 THU | 10:00PM | 10:00PM | 10 | XP | XP |
| 1107 FRI | 8:00AM | 8:00AM | 26 | LP | LP |
| 1107 FRI | 8:00AM | 8:00AM | 33 | LP | LP |
| ***** NEW TIMER PROGRAM ***** | | | | | |

NOTE:

If you do not mind this overlap, press **PROG/CHECK** to finish the timer

program setting. The program with the lower program number will be recorded and the other one will not be recorded correctly. If no changes are made for approximately 1 minute, the unit will return to the normal screen.

2 Press **Δ/∇** to select the desired program to be cancelled or changed.

To cancel the program

Press **CANCEL**.

- “THE TIMER PROGRAMMING SETTING WAS CANCELLED” appears on the TV screen for about 5 seconds, then the normal screen resumes.

To change the program setting

Press **ENTER**, then go to step 3.

3 Change the program setting.

- Refer to steps 5 – 10 in “Manual Timer Programming” (ⓘ pg. 42).

4 Press **PROG/CHECK** to check if the conflict has been settled. Program check screen appears.

5 Engage the unit's timer mode.

- Refer to step 6 in “Check, Cancel And Change Programs” (ⓘ pg. 45).

NOTE:

When any overlaps remain after deletion and modification of programs, Program Check screen remains showing the conflicting programs. In such a case, repeat the procedure above until the conflict is solved.

Automatic Satellite Program Recording (DVD Deck Only)



This function allows you to automatically record a satellite program which is timer-programed on your external DBS receiver. Connect a DBS receiver to the unit's AUDIO/VIDEO INPUT (L-1) connectors and program the timer on the DBS receiver. The unit starts or stops recording by the signals input from the DBS receiver. After recording, the unit's power shuts off automatically.

- You can also connect the cable box if it has a timer.

ATTENTION:

- Be sure not to turn on the DBS receiver before the program is executed; otherwise, the unit will start recording when the DBS receiver's power is turned on.
- If you have connected another appliance other than a DBS receiver to the AUDIO/VIDEO INPUT (L-1) connectors, be sure not to engage the Automatic Satellite Program Recording mode; otherwise, the unit will start recording when the connected appliance's power is turned on.
- Automatic Satellite Program Recording and timer-recording cannot be done at the same time.

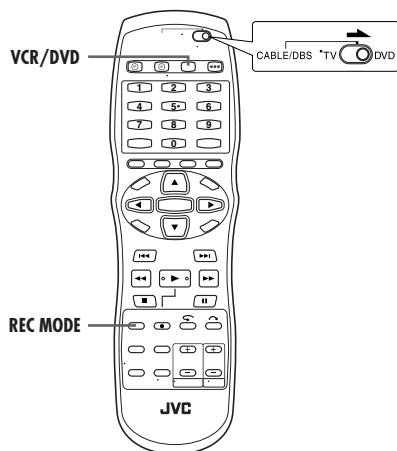
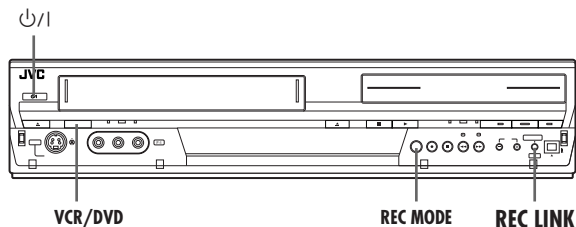

- Make sure the DBS receiver is connected to the unit's AUDIO/VIDEO INPUT (L-1) connectors.
- Program the timer on the DBS receiver.
- Slide the TV/CABLE/DBS/DVD switch to DVD.

1 Press **VCR/DVD** repeatedly so that the DVD lamp lights up on the unit.

2 Press **REC MODE** repeatedly to set the recording mode.

3 Press and hold **REC LINK** on the unit for about 2 seconds to engage the Automatic Satellite Program Recording mode. "R-LK" appears on the front display panel and the VCR deck is automatically selected. When the VCR deck is in timer standby mode, the unit is automatically turned off.

NOTES:

- To disengage the Automatic Satellite Program Recording mode, press **REC LINK**.
- If the unit's power is off, it is not possible to engage the Automatic Satellite Program Recording mode.
- In step 3, if "R-LK" blinks quickly on the front display panel even though your DBS receiver's power is off, Automatic Satellite Program Recording will not work properly with that satellite receiver*. If this is the case, perform "Manual Timer Programming" (pg. 42) to timer-record a satellite program.
* Some DBS receivers output signals even if the power is off. Automatic Satellite Program Recording is not possible with those DBS receivers.
- "R-LK" blinks on the front display panel while Automatic Satellite Program Recording is in progress.
- For timer programming of the DBS receiver, refer to the instruction manual of the DBS receiver.
- Automatic Satellite Program Recording is not possible if your DBS receiver does not have a timer.
- Pressing the unit's P/I button while Automatic Satellite Program Recording is in progress turns off the unit's power and disengages the Automatic Satellite Program Recording mode.
- If there are more than one satellite programs you wish to record with Automatic Satellite Program Recording, it is not possible to set different recording modes for each program.
- Depending on the type of DBS receiver, the unit may not record a slight portion of the beginning of the program or may record slightly longer than the actual length of the program.
- If you engage the Automatic Satellite Program Recording mode when the DBS receiver's power is on, the unit will not start Automatic Satellite Program Recording even though "R-LK" blinks on the front display panel. When the DBS receiver shuts off once and is turned back on again, the unit starts recording.
- You can also record a program from your cable system in the same way if the system has a timer.

About the Automatic Satellite Program Recording indicator on the front display panel

When the DVD deck is in the Auto Satellite Program Recording standby mode while the VCR deck is used, the following indicator lights up instead of "R-LK" as illustrated.

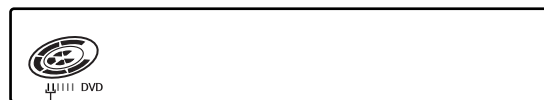

Automatic Satellite Program indicator

Basic Playback

- Turn on the unit.
- Turn on the TV and select the video channel (or AV mode).
- Slide the **TV/CABLE/DBS/DVD** switch to **DVD**.

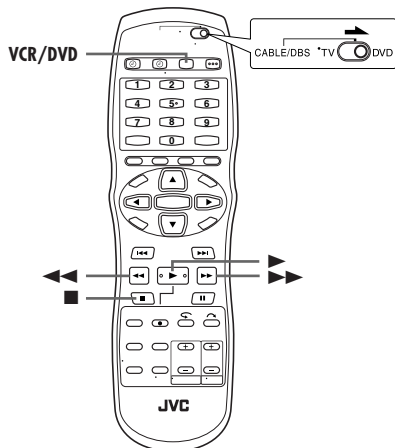
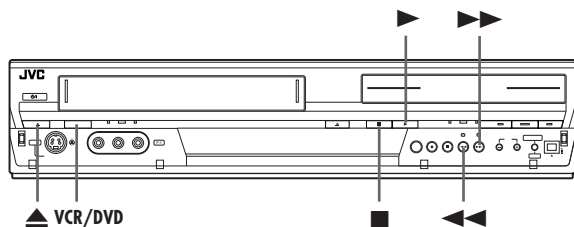

1 Load a cassette. Make sure the window side is up, the rear label side is facing you and the arrow on the front of the cassette is pointed toward the unit.

- Do not apply too much pressure when inserting.
- If the record safety tab has been removed, playback begins automatically.
- The unit's power comes on automatically and the counter is reset to 0:00:00.

2 Press **VCR/DVD** repeatedly so that the VCR lamp lights up on the unit.

3 Find the program start point. If the tape is advanced past the start point, press **◀◀**. To go forward, press **▶▶**.

4 Press **▶** to start playback.

5 Press **■** to stop playback.

- To eject the cassette, press **▲ (VCR EJECT)**.

Clean the video heads using a dry cleaning cassette – ECL-3F – when:

- Rough, poor picture appears while a tape is played back.
- The picture is unclear or no picture appears.
- "USE CLEANING CASSETTE" appears on the screen (only with "SUPERIMPOSE" set to "AUTO"). (pg. 75)

NOTE:

The heads get dirty in the following cases:

- in an environment prone to extreme temperature or humidity
- in a dusty environment
- flaw, dirt or mold on video tapes
- continuous usage for a long time

Usable cassettes

Full-Size VHS

T-30 (ST-30**)
T-60 (ST-60**)
T90
T-120 (ST-120**)
T-160 (ST-160**)
ST-210**

Compact VHS*

TC-20 (ST-C20**)
TC-30 (ST-C30**)
TC-40 (ST-C40**)

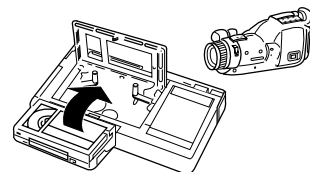

* Compact VHS camcorder recordings can be played on this unit. Simply place the recorded cassette into a VHS Cassette Adapter and it can be used just like any full-sized VHS cassette.

** This unit can record on regular VHS and Super VHS cassettes.

- However, it will record regular VHS signals only.
- S-VHS recording is not possible with this unit.
 - This unit is equipped with SQPB (S-VHS QUASI PLAYBACK) that lets you watch tapes recorded in the S-VHS format and the SP mode with regular VHS resolution.
 - SQPB does not deliver Super VHS resolution.

Playback Features

- Turn on the unit.
- Turn on the TV and select the video channel (or AV mode).
- Slide the TV/CABLE/DBS/DVD switch to DVD.
- Press VCR/DVD repeatedly so that the VCR lamp lights up on the unit.

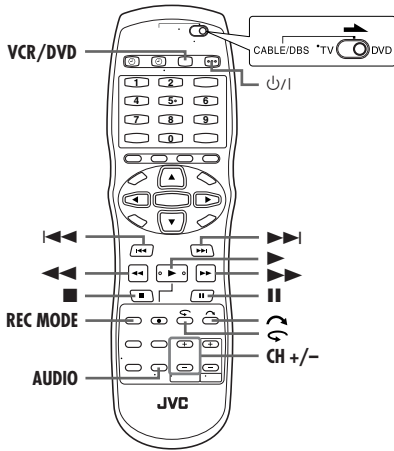

ATTENTION:

- In the search, still, slow-motion or frame-by-frame playback mode,
- the picture will be distorted.
- the noise bars will appear.
- there may be a loss of color.
- you cannot hear the sound.

Still Picture/Frame-By-Frame Playback

- 1 Press **II** to pause during playback.
- If there is vertical jitter, press **CH +/-** to correct the picture.
- 2 Press **II** to activate frame-by-frame playback.
- To resume normal playback, press **▶**.

Slow Motion

- 1 Press **II** to pause during playback.
- 2 Press and hold **II** for 2 seconds, then release. Press **II** and release again to return to still picture.
- The speed changes for each direction by pressing **◀◀** and **▶▶** repeatedly.
- To resume normal playback, press **▶**.

NOTE:

During slow motion playback, some noise may appear on the TV screen. Press **CH +** or **-** to eliminate the noises.

High-Speed Search

During playback, press **▶▶** for forward high-speed search, or **◀◀** for reverse high-speed search.

- Each press of the button increases the search speed for each direction.
When pressing **▶▶**:
(SP): +5x ↔ +7x
(EP): +11x ↔ +21x
When pressing **◀◀**:
Once **◀◀** is pressed, reverse search starts in -1x normal playback speed. After this process, each press of **◀◀** changes the search speed between -5x and -7x in SP mode, -11x and -21x in EP mode.
(SP): -1x → -5x ↔ -7x
(EP): -1x → -11x ↔ -21x
- To resume normal playback, press **▶**.

Quick Rewind A Little

During playback (or Live Memory Playback), press **◀**. The unit rewinds the picture a little (about 7 seconds) and resumes playback.

- If the button is pressed repeatedly, the unit rewinds the pictures continuously and resumes playback.

Skip Search

During playback, press **↶** 1 to 6 times to skip over unwanted sections.

- Each press initiates an approximately 30-second period of fast-motion playback. Normal playback resumes automatically.
- To resume normal playback, press **▶**.

Index Search

Your unit automatically marks index codes at the beginning of each recording. This function gives you quick access to any one of 9 index codes in either direction.

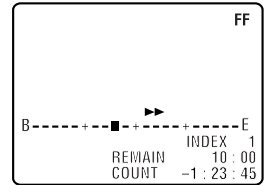

NOTE:

Before starting, make sure the unit is in the Stop mode.

Press **◀◀** or **▶▶** to activate Index Search. "INDEX -1" or "INDEX 1" is displayed on the TV screen and search begins in the corresponding direction.

- To access index codes 2 through 9, press **◀◀** or **▶▶** repeatedly until the correct index number is displayed.

Example:

- To locate the beginning of B from the current position, press **◀◀** twice.
- To locate the beginning of D from the current position, press **▶▶** once.

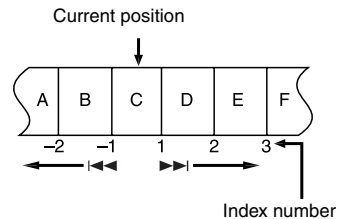

- When the specified index code is located, playback begins automatically.

Next Function Memory

The Next Function Memory "tells" the unit what to do after rewinding. Before continuing, make sure the unit is in the Stop mode.

For Automatic Start Of Playback

Press ◀◀, then press ▶ within 2 seconds.

For Automatic Cassette Ejection After Tape Rewind

Press ◀◀, then press ▲ (VCR EJECT) on the unit within 2 seconds.

Repeat Playback

Your unit can automatically play back the whole tape 100 times repeatedly.

- 1 Press ▶ to start playback.
- 2 Press and hold ▶ for over 5 seconds, then release.
 - ⏮ lights up on the front display panel.
 - After playing back a tape 100 times, the unit stops automatically.
- 3 Press ■ at any time to stop Repeat Playback.
 - Pressing ▶, ◀◀, ▶▶ or || also stops Repeat Playback.

Manual Tracking

Your unit is equipped with automatic tracking control. During playback, you can override this and adjust the tracking manually by pressing the CH buttons.

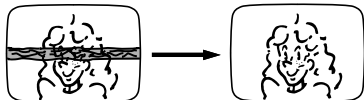

1 During playback, press CH + or – on the unit simultaneously to activate manual tracking.

- 2 Press CH + or – to adjust the tracking manually.
- Press REC MODE again to return to automatic tracking.

NOTE:

When a new tape is inserted, the unit enters the automatic tracking mode automatically.

Soundtrack Selection

Your unit is capable of recording three soundtracks (HI-FI L, HI-FI R and NORM) and will play back the one you select.

During Playback

Pressing AUDIO changes the soundtrack as follows:

| TRACK | USE |
|-------------------|---|
| On-Screen Display | |
| HI FI | Hi-Fi sound is played back |
| HI FI L | Sound on the left Hi-Fi channel is played back |
| HI FI R | Sound on the right Hi-Fi channel is played back |
| NORM | Sound on the normal track is played back |
| NORM HI FI | Both sounds on the Hi-Fi track and normal track are mixed and played back |

NOTES:

- "HIFI" should normally be selected. In this mode, Hi-Fi stereo tapes are played back in stereo, and the normal audio track is played back automatically for tapes with only normal audio.
- "SUPERIMPOSE" must be set to "AUTO" or the on-screen displays will not appear. (☞ pg. 75)

VHS Progressive Scan

You can watch the image on VCR deck in the Progressive scan mode via component video.

ATTENTION:

- Your TV needs to be compatible with Progressive and to have Component video input connectors.
- If a DVD-VIDEO, or an already finalized DVD-R/DVD-RW (VIDEO) disc is loaded, press ■ twice to release the resume function.

- 1 Set the Progressive-compatible TV to the component input mode.
- 2 Press VCR/DVD repeatedly so that the DVD lamp lights up on the unit, then press PROGRESSIVE SCAN for 3 or more seconds so that the Video output indicator (P) lights on the front display panel.
- 3 Press VCR/DVD repeatedly so that the VCR lamp lights up on the unit.
- 4 Press VCR→.
 - "VCR→" lights up on the unit.

NOTES:

- Be sure to engage the DVD deck in stop mode.
- It is not possible to perform the above steps when the DVD deck is in timer standby mode.

Basic Recording

- Turn on the unit.
- Turn on the TV and select the video channel (or AV mode).
- Slide the **TV/CABLE/DBS/DVD** switch to **DVD**.

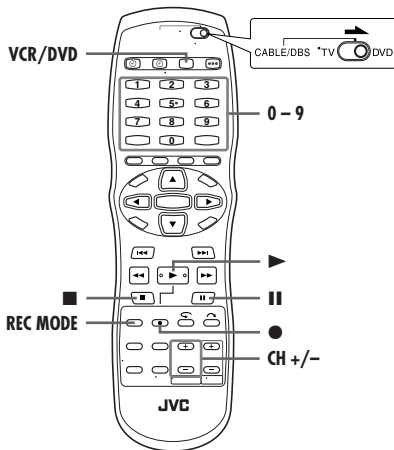
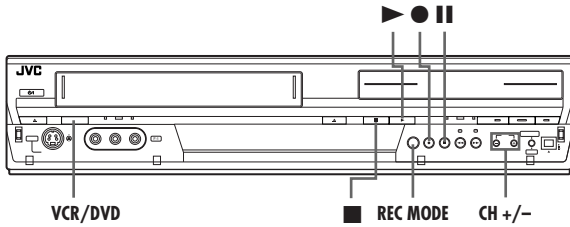

- 1 Load a cassette with the record safety tab intact.
 - The unit's power comes on automatically and the counter is reset to 0:00:00.
- 2 Press **VCR/DVD** repeatedly so that the VCR lamp lights up on the unit.
- 3 Press **CH +/-** or the **number keys** to select the channel you wish to record.
- 4 Press **REC MODE** repeatedly to set the recording mode.
- 5 Press **●** on the unit to start recording. Or press and hold **●** and press **▶** on the remote control.
 - The VCR recording lamp lights up on the unit.
- 6 Press **||** to pause recording.
 - You can select channel during the Record Pause mode.
 - To resume recording, press **▶**.
- 7 Press **■** to stop recording.
 - The VCR recording lamp lights off on the unit.

Recording Resume Function

If there is a power outage during recording, Instant Timer Recording or timer recording (pg. 50, 52, 53), the recording will resume automatically when power is restored to the unit unless the unit's memory backup has expired.

Recording Features

- Turn on the unit.
- Turn on the TV and select the video channel (or AV mode).
- Slide the **TV/CABLE/DBS/DVD** switch to **DVD**.
- Press **VCR/DVD** repeatedly so that the VCR lamp lights up on the unit.

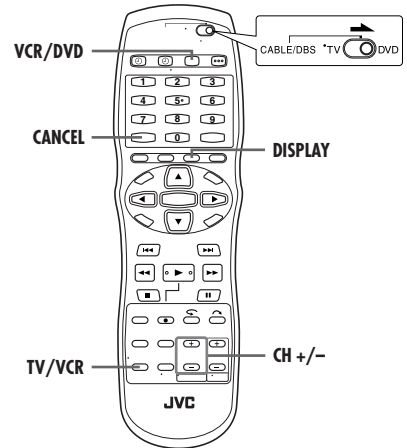
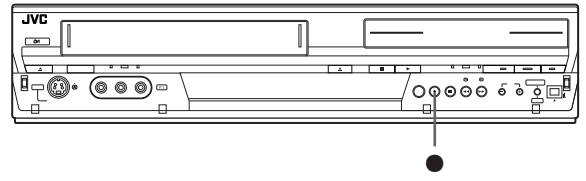

Watch Another Program While Recording On The Unit

While recording is going on, you can watch another program on the TV by using the TV's tuner.

NOTE:

It is required that the remote control is set to be able to operate the TV in advance. (pg. 70)

1 During recording, press **TV/VCR** to select TV mode if your unit is connected to the TV via the RF connection.

- VCR mode is disengaged, then the VCR indicator lights off and "TV" appears on the front display panel.



VCR indicator lights off.

- The program received on the TV's tuner is displayed on the TV screen.

2 Slide the **TV/CABLE/DBS/DVD** switch to **TV**.

3 Press **CH +/-** repeatedly to select the desired channel.

Instant Timer Recording (ITR)

This easy method lets you record for from 30 minutes to 6 hours (selectable in 30-min. increments), and shuts the unit off after recording is finished.

- 1 Press ● on the unit to start recording.
- 2 Press ● again to engage the ITR mode.
 - On the front display panel, "0:30" appears.
- 3 If you want to record for more than 30 minutes, press ● to extend the time. Each press extends recording time by 30 minutes.

NOTES:

- You can only perform ITR using the ● button on the unit.
- When the end of the tape is reached during timer recording or Instant Timer Recording, the cassette is automatically ejected and the unit is shut off.
- During Instant Timer Recording, any other timer programmed recording won't start even if their start time has come. In such a case, the timer programmed recording starts (if the end time of the timer programmed recording is set after the end of Instant Timer Recording) after the Instant Timer Recording finishes.

Elapsed Recording Time Indication

- 1 Press **DISPLAY** until a counter reading appears on the front display panel.
- 2 Press **CANCEL** to reset the counter before starting recording or playback.
 - The counter is reset to "0:00:00" and shows the exact elapsed time as the tape runs. You can check the exact time of a recording or playback.

Tape Remaining Time

- 1 Press **DISPLAY** until the time remaining on the tape appears.
- By pressing the **DISPLAY** button, you can change display to show the clock time, counter reading or tape remaining time.

NOTES:

- When you press **DISPLAY**, the on-screen display appears on the TV screen for 5 seconds, then the displays other than the counter disappears. To clear the counter display, press **DISPLAY**.
- Depending on the type of tape being used, the tape remaining time reading may not appear right away, or is not correct. "—:—:—" may sometimes appear, or the display may blink on occasion.

Second Audio Recording

This unit's built-in MTS decoder enables reception of Multichannel TV Sound broadcast. To record a SAP program received, set "2ND AUDIO RECORD" to "ON". (▶ pg. 76)

NOTE:

When the channel is changed on the unit;

- The "STEREO" indicator appears on the screen for about 5 seconds if the program is a stereo broadcast.
- The "SAP" indicator appears on the screen for about 5 seconds if the program is a SAP broadcast.
- Both indicators appear when a stereo program is accompanied by SAP sound.

Accidental erasure prevention

To prevent accidental recording on a recorded cassette, remove its safety tab. To record on it later, cover the hole with adhesive tape.

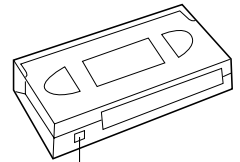

Record safety tab

VCR Plus+® Timer Programming

You can program this unit to timer-record as many as 8 programs. With the VCR Plus+ system, timer programming is greatly simplified because each TV program has a corresponding code number which your unit is able to recognize. You can use the remote control to enter the PlusCode number.

- Make sure that the unit's built-in clock is set properly.
- Turn on the unit.
- Turn on the TV and select the video channel (or AV mode).
- Slide the **TV/CABLE/DBS/DVD** switch to **DVD**.

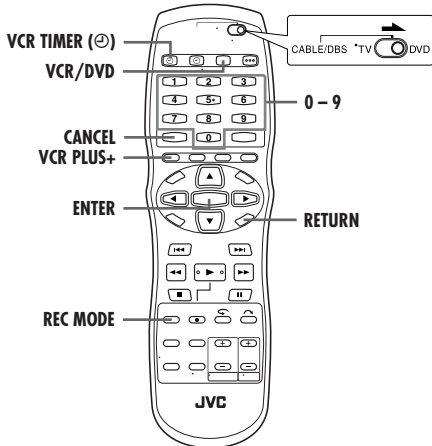

- 1 Load a cassette with the record safety tab intact.
- 2 Press **VCR/DVD** repeatedly so that the VCR lamp lights up on the unit.
- 3 Press **VCR PLUS+** to access the VCR Plus+ screen.
- 4 Press the **number keys** to enter the PlusCode number of a program you wish to record, then press **ENTER**.
 - If you have made a mistake, press **CANCEL** and input the correct number before you press **ENTER**.
 - If the number you entered is invalid, "ERROR" appears on the TV screen and "Err" appears on the front display panel. Press **CANCEL** and input a valid PlusCode number.
- 5 The PlusCode number you entered and the matching timer-recording information are displayed on the TV screen. Check the program data.
 - To cancel this setting, press **VCR PLUS+** or **PROG/CHECK**.

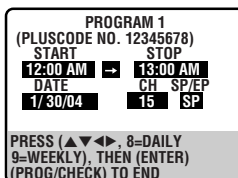
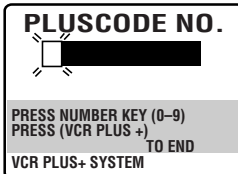

IMPORTANT:

Make sure the channel position number you wish to record is displayed; if not, see "Changing VCR Plus+ Setting" (pg. 77) and set the Guide Channel number correctly.

6 Press **REC MODE** to select the desired recording mode. Or press **◀▶** to select "SP/EP", then press **▲▼** to select the desired recording mode.

7 Press **ENTER** to complete timer programming.

- To program another timer, repeat steps 3 – 7.
- If "PROGRAM NOT COMPLETED PROGRAM OVERLAP" appears on the TV screen, see page 54.

8 Press **VCR TIMER** (⊙) to engage the unit's timer mode. The VCR timer lamp lights up on the unit and the DVD deck is automatically selected. When the DVD deck is in timer standby mode, the unit is automatically turned off.

- To disengage the timer mode, press **VCR TIMER** (⊙) again.

IMPORTANT:

If you have moved to a different area or if a broadcasting station's channel number has been changed, the wrong channel number will be displayed on the VCR Plus+ program screen in step 5. When this happens, set the correct Guide Channel number for that station. (pg. 77, "Changing VCR Plus+ Setting")

NOTES:

- To Timer-Record Weekly Or Daily Serials:
 - in step 5, press **number key "9"** for weekly serials or **number key "8"** for daily serials (Monday — Friday). Either "WEEKLY" or "DAILY" appears on the TV screen. Pressing the button again makes the corresponding indication disappear.
- You can program this unit to timer-record as many as 8 programs. If you try to program the unit to record a ninth, "PROGRAM FULL" appears on the TV screen and "FULL" appears on the front display panel. To record the extra program, you must first cancel any unnecessary programs. (pg. 54)
- To record the programs received by cable box or DBS receiver, record on the DVD discs. For details, refer to "VCR Plus+ Timer Programming" (pg. 41).

Manual Timer Programming

You can program this unit to timer-record as many as 8 programs. If you do not know the PlusCode number for the program you wish to record, use the following procedure to set your unit to timer-record the program.

- Make sure that the unit's built-in clock is set properly.
- Turn on the unit.
- Turn on the TV and select the video channel (or AV mode).
- Slide the **TV/CABLE/DBS/DVD** switch to **DVD**.

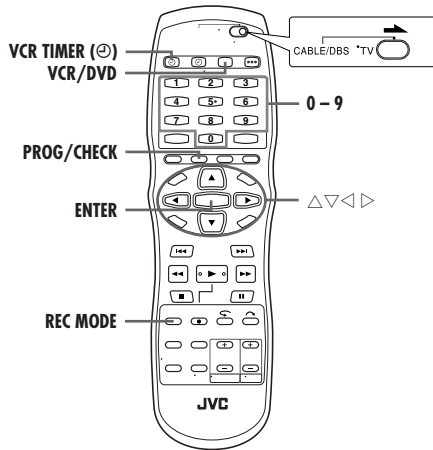

- 1 Load a cassette with the record safety tab intact.
- 2 Press **VCR/DVD** repeatedly so that the VCR lamp lights up on the unit.
- 3 Press **PROG/CHECK** to access the Program Check screen.

| PR | START | STOP | CH | DATE |
|----|--------|-------|-----|-------|
| 1 | 8:00P | 10:00 | 12 | 12/24 |
| 2 | 10:00A | 10:45 | 40 | 12/25 |
| 3 | 11:30P | 1:00 | 125 | 12/25 |
| 4 | | | | |
| 5 | | | | |
| 6 | | | | |
| 7 | | | | |
| 8 | | | | |

(PROG/CHECK) TO NEXT

- 4 Press $\Delta\nabla$ to select the blank number, then press **ENTER**. The program screen appears.
- 5 Press $\triangleleft\triangleright$ to select "START", then press $\Delta\nabla$ to set the desired start time.
 - Each press of $\Delta\nabla$ advances/goes back the start time in 1-min. increments.
 - To advance/go back the start time in 30-min. increments, press and hold $\Delta\nabla$.
- 6 Press $\triangleleft\triangleright$ to select "STOP", then press $\Delta\nabla$ to set the desired stop time.
 - Each press of $\Delta\nabla$ advances/goes back the stop time in 1-min. increments.
 - To advance/go back the stop time in 30-min. increments, press and hold $\Delta\nabla$.
- 7 Press $\triangleleft\triangleright$ to select "DATE", then press $\Delta\nabla$ to set the desired date.
 - The current date appears on the TV screen. The date you enter appears in its place.
- 8 Press $\triangleleft\triangleright$ to select "CH", then press $\Delta\nabla$ to select the desired channel.

PROGRAM 4

| | |
|---------|----------|
| START | STOP |
| --:--AM | --:--AM |
| DATE | CH SP/EP |
| --/-- | -- SP |

PRESS ($\Delta\nabla\triangleleft\triangleright$) 8=DAILY
9=WEEKLY), THEN (ENTER)
(PROG/CHECK) TO END

9 Press **REC MODE** to select the desired recording mode. Or press $\triangleleft\triangleright$ to select "SP/EP", then press $\Delta\nabla$ to select the desired recording mode.

10 Press **ENTER** to access the Program Check screen.

11 Press **PROG/CHECK** to complete timer programming. "PROGRAM COMPLETED" appears on the TV screen for about 5 seconds, then the normal screen appears. If "PROGRAM NOT COMPLETED PROGRAM OVERLAP" appears on the TV screen, see page 54.

- To program another timer, repeat steps 3 – 11.

12 Press **VCR TIMER** (⊖) to engage the unit's timer mode. The VCR timer lamp lights up on the unit and the DVD deck is automatically selected. When the DVD deck is in timer standby mode, the unit is automatically turned off.

- To disengage the timer mode, press **VCR TIMER** (⊖) again.

NOTES:

• To Timer-Record Weekly Or Daily Serials:

- anytime during steps 7 through 9, press **number key "9"** for weekly serials or **number key "8"** for daily serials (Monday – Friday). Either "WEEKLY" or "DAILY" appears on the TV screen. Pressing the button again makes the corresponding indication disappear.
- You can program this unit to timer-record as many as 8 programs. If you try to program the unit to record a ninth, "PROGRAM FULL" appears on the TV screen. To record the extra program, you must first cancel any unnecessary programs. (⌚ pg. 54)
- In case of a power failure after programming, the unit's memory backup keeps your selections for approximately 5 seconds.
- Programs that start after midnight must have the next day's date.
- To record the programs received by cable box or DBS receiver, record on the DVD discs. For details, refer to "Manual Timer Programming" (⌚ pg. 42).

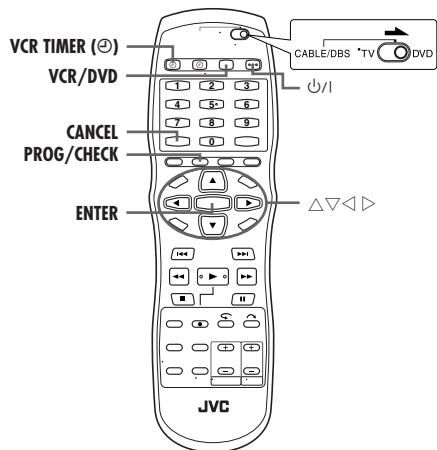

Check, cancel and change programs

1 When the VCR timer lamp lights on the unit

Press **VCR TIMER** (⊙), then press **⏻/⏹**.

When the VCR lamp does not light up on the unit

Press **VCR/DVD** repeatedly so that the VCR lamp lights up on the unit.

2 Press **PROG/CHECK** to access the Program Check screen.

To cancel a program

Press **CANCEL** to cancel a program.

| PR | START | STOP | CH | DATE |
|----|--------|-------|-----|-------|
| 1 | 8:00P | 10:00 | 12 | 12/24 |
| 2 | 10:00A | 10:45 | 40 | 12/25 |
| 3 | 11:30P | 1:00 | 125 | 12/25 |
| 4 | | | | |
| 5 | | | | |
| 6 | | | | |
| 7 | | | | |
| 8 | | | | |

(PROG/CHECK) TO NEXT

3 Press **△▽** to select the program, then press **ENTER**. The program screen appears.

4 Change the settings of the desired recording options as required.

- Refer to steps 7 – 10 in "Manual Timer Programming" (pg. 53).

5 Press **PROG/CHECK** to complete timer correction. The previous screen resumes.

6 Press **VCR TIMER** (⊙).

- The VCR timer lamp lights up on the unit and the DVD deck is automatically selected. When the DVD deck is in timer standby mode, the unit is automatically turned off.

| PROGRAM 4 | | | |
|-----------|----------|-------|---------|
| START | 8:00AM | STOP | 10:00AM |
| DATE | 12/24/04 | CH | 12 |
| | FRI | SP/EP | SP |

PRESS (CANCEL) TO CANCEL
PRESS (ENTER) TO CONFIRM
(PROG/CHECK) TO END

When Programs Overlap Each Other

If "PROGRAM NOT COMPLETED PROGRAM OVERLAP" appears, you have another program overlapping the program you have just made.

The Program Check screen appears and conflicting programs will start blinking.

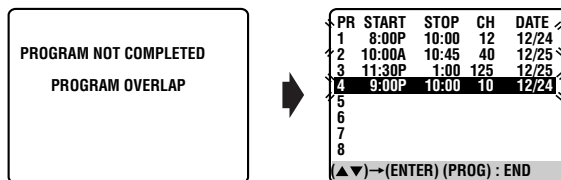

Example: Program 1 (you have just made) and Program 4 overlap each other.

1 Confirm the overlapping programs. Overlapping programs blink on the TV screen.

2 Press **△▽** to select the program to modify, then press **ENTER** or **▷**.

- You can only select one of the overlapping programs.

NOTE:

If you do not mind this overlap, press **PROG/CHECK** to finish the timer program setting. The program with the lower program number will be recorded and the other one will not be recorded correctly. If no changes are made for approximately 1 minute, the unit will return to the normal screen.

3 Press **△▽** to select the desired program to be cancelled or changed.

To cancel the program

Press **CANCEL**.

- "PROGRAM COMPLETED" appears on the TV screen for about 5 seconds, then the normal screen resumes.

To change the program setting

Press **ENTER**, then go to step 4.

4 Change the program setting.

- Refer to steps 7 – 10 in "Manual Timer Programming" (pg. 53).

5 Press **PROG/CHECK** to check if the conflict has been settled. Program check screen appears.

- "PROGRAM COMPLETED" appears on the TV screen for about 5 seconds, then the normal screen resumes.

6 Press **VCR TIMER** (⊙).

NOTE:

When any overlaps remain after deletion and modification of programs, Program Check screen remains showing the conflicting programs. In such a case, repeat the procedure above until the conflict is solved.

Library Database DVD Navi



The Library Database DVD Navi enables you to search and select the desired programs recorded on a DVD-RAM/R/RW disc very easily.

You can record up to 99 programs on a disc.

Each time a program is recorded on the disc, the information of the program is registered for the Library Database DVD Navi automatically.

So, you can confirm the information of the programs recorded on the disc with the Library Database DVD Navi screen. And, you can also select one of the programs recorded on the disc using the Library Database DVD Navi.

The following screen appears as the Library Database DVD Navi screen when you press **NAVIGATION**. You can move the arrow to select the desired position on the screen by pressing Δ ∇ \triangleleft \triangleright on the remote control.

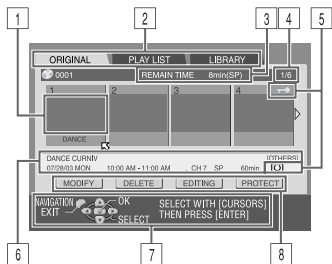

- 1 Index
(Small still picture of each program)
- 2 Names of functions
ORIGINAL (pg. 56)
PLAY LIST (pg. 58)
LIBRARY (pg. 60)
- 3 Remaining time
(Based on the recording mode currently selected)
- 4 Current/Total number of program(s)
(For example, there are 6 recorded programs and the program indicated by the arrow is the 3rd one.)
- 5 Icons
(Indicate the recording situation for each program.)
- 6 Recording information for the program indicated by the arrow
- 7 Guidance for operations
- 8 Operational commands

The Icons and their meanings

| | |
|--|---|
| | This program is write-protected. |
| | This program has stereo sounds. |
| | This program was recorded with timer recording. |

Using Library Database DVD Navi system, you can easily modify registered information, edit the program or play list, as well as search for the beginning of each program.

About registration of information

The following information is automatically registered for each program when ordinary recording or timer recording is performed, then stored in an area specified on the unit.

- index* (reduced still pictures to show program titles)
- program title*
- category*
- date and time
- channel
- recording mode
- length of recording time

The items marked with an asterisk (*) can be easily modified and registered again after recording by using Library Database DVD Navi system.

About editing of programs

Library Database DVD Navi system has the following functions for editing of programs.

- "Modify Play List Information" (pg. 58)
- "Delete Program" (pg. 57)

The limitations of registration

You can register information up to 99 programs.

When the amount of information is at the limits of registration, you cannot record new program any more. In this case, you need to delete old programs to register new one. (pg. 57)

NOTE:

Once a DVD-R/RW (Video mode) disc has been finalized, the displays for original and play list do not appear. Only display for library appears.

The display for original recording

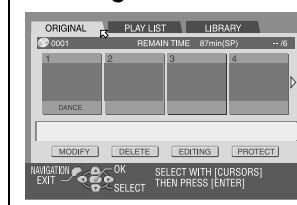

The display for play list

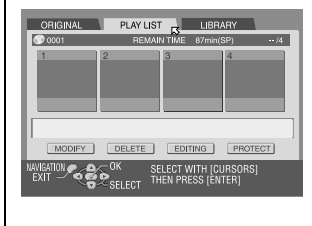

Scan For Beginning(s) Of Program(s)

- Turn on the TV and select the video channel (or AV mode).
- Slide the **TV/CABLE/DBS/DVD** switch to **DVD**.

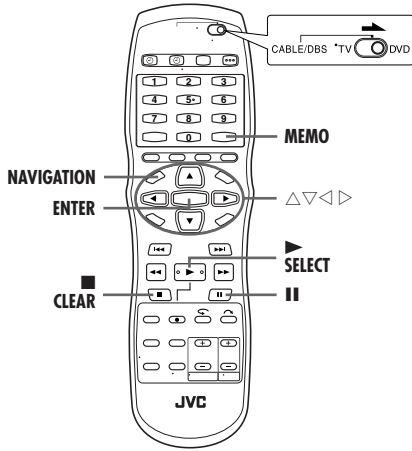

You can scan the beginning of the program easily with the Library Database DVD Navi.

- 1 Load a recorded disc.
- 2 Press **NAVIGATION**. The Library Database DVD Navi screen appears.
- 3 Press $\Delta \nabla \triangleleft \triangleright$ to select "ORIGINAL", then press **ENTER**.

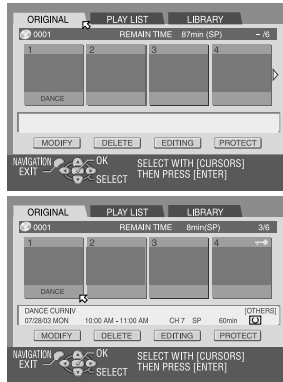

- 4 Press $\triangleleft \triangleright$ to select the index (small still pictures) of the desired program.

• When you want the plural programs to be played back continuously, press **MEMO** after selecting the desired program. The numbers of the playback order appear on the index. You can select up to 30 programs.

• When you want to correct the order, move the arrow to the desired index and press **MEMO**. The number disappears and the unit re-numbers the other programs automatically.

• When you want to cancel the order, press **CLEAR** (■).

- 5 Press **ENTER** or **SELECT** (\blacktriangleright) to start playback. The playback starts.

- 6 Press **II** to pause playback.
 - To resume normal playback, press \blacktriangleright .

- 7 Press **■** to stop playback.

Modify Original Information



- Turn on the TV and select the video channel (or AV mode).
- Slide the **TV/CABLE/DBS/DVD** switch to **DVD**.

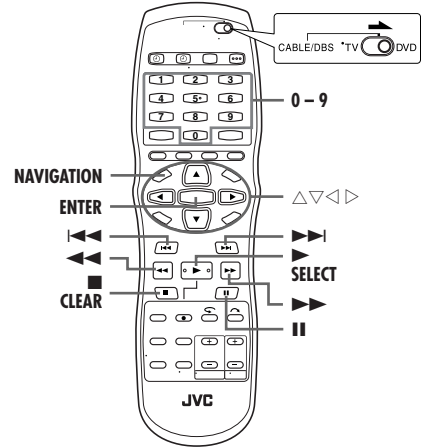

Modify Index

- 1 Press **NAVIGATION**. The Library Database DVD Navi screen appears.
- 2 Press $\Delta \nabla \triangleleft \triangleright$ to select "ORIGINAL", then press **ENTER**.
- 3 Press $\Delta \nabla \triangleleft \triangleright$ to select one program you want to modify, then press ∇ .
- 4 Press $\Delta \nabla \triangleleft \triangleright$ to select "MODIFY", then press **ENTER**.
- 5 Press $\triangleleft \triangleright$ to select "MODIFY INDEX".
- 6 Search for the picture from the program by pressing the appropriate buttons ($\triangleleft \triangleright$, $\blacktriangleleft \blacktriangleright$, or **II**). The pictures of the program appear on the left window.
- 7 Confirm the arrow is on "REPLACE", then press **ENTER** to register new index. New index appears on the right window.
 - When you press **ENTER** with the arrow on "RETURN" you can return to the previous screen.
- 8 Press **NAVIGATION** to return to the normal screen.
 - Press **■** to cancel pause mode after pressing **NAVIGATION**.

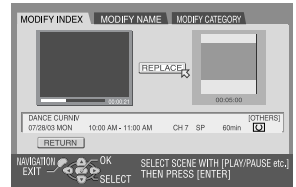

Modify Program Name

1 Perform steps **1** to **3** of “Modify Index” (☞ pg. 56) before continuing.

2 Press $\Delta \nabla \triangleleft \triangleright$ to select “MODIFY”, then press **ENTER**.

3 Press $\triangleleft \triangleright$ to select “MODIFY NAME”.

4 Press $\Delta \nabla \triangleleft \triangleright$ to select the desired letter or command, then press **ENTER**. Repeat this process to complete the name.

- To correct a letter, press $\Delta \nabla \triangleleft \triangleright$ to select “DELETE” or “DELETE ALL”, then press **ENTER**.
- You can enter the letters up to 64.
- You can also enter the new name with the **number keys**. For example, when you press **2** repeatedly, “A”, “B”, “C”, “a”, “b”, “c”, “2”, and then “A” appear by turns. You can use the following buttons.

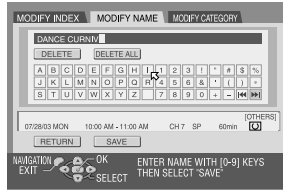

Number keys: for entering letters, numbers and blank space

$\triangleleft \triangleright$ **buttons:** for moving the entering or inserting point

CLEAR (■) **button:** for correcting a letter

$\triangleleft \triangleleft \triangleright \triangleright$ **buttons:** for changing character tables

5 Press $\Delta \nabla \triangleleft \triangleright$ to select “SAVE”, then press **ENTER**.

6 Press $\Delta \nabla \triangleleft \triangleright$ to select “RETURN”, then press **ENTER**. The Library Database DVD Navi screen appears again.

7 Press **NAVIGATION** to return to the normal screen.

Modify Category

1 Perform steps **1** to **3** of “Modify Index” (☞ pg. 56) before continuing.

2 Press $\Delta \nabla \triangleleft \triangleright$ to select “MODIFY”, then press **ENTER**.

3 Press $\triangleleft \triangleright$ to select “MODIFY CATEGORY”.

4 Press $\Delta \nabla \triangleleft \triangleright$ to select the desired category, then press **ENTER**.

5 Press **ENTER**. The Library Database DVD Navi screen appears again.

6 Press **NAVIGATION** to return to the normal screen.

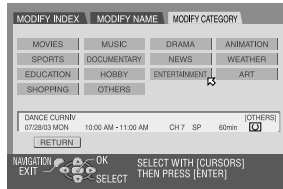

Protect Title

You can protect the program to prevent accidental erasure of the important program.

1 Perform steps **1** to **2** of “Modify Index” (☞ pg. 56) before continuing.

2 Press $\Delta \nabla \triangleleft \triangleright$ to select a program you want to protect, then press ∇ .

3 Press $\triangleleft \triangleright$ to select “PROTECT”, then press **ENTER**. “” appears.

- To cancel the protection, repeat **2** – **3** again.

4 Press **NAVIGATION** to return to the normal screen.

NOTE:

All the programs on a disc will be deleted once the disc is formatted even if they are protected titles. (☞ pg. 57)

Delete Program

You cannot record any more with Library Database DVD Navi once the registered programs on the disc reach 99 programs. Deleting unnecessary programs after dubbing or other operations can increase remaining time and available recording capacity. (For DVD-R discs, although it is possible to delete recorded programs, available recording capacity does not increase.) The deleted program is never resumed. Play lists and program information in the unit’s library are also deleted.

1 Perform steps **1** to **2** of “Modify Index” (☞ pg. 56) before continuing.

2 Press $\Delta \nabla \triangleleft \triangleright$ to select one program you want to delete, then press ∇ .

3 Press $\Delta \nabla \triangleleft \triangleright$ to select “DELETE”, then press **ENTER**. The message appears for your confirmation.

4 Press $\triangleleft \triangleright$ to select “YES”, then press **ENTER**.

- When you cancel the deletion, select “NO”, then press **ENTER**.

5 Press **NAVIGATION** to return to the normal screen.

Delete Unwanted Part Of The Program

You can delete unwanted part of the program.

1 Perform steps **1** to **2** of “Modify Index” (☞ pg. 56) before continuing.

2 Press $\triangleleft \triangleright$ to select one program whose unwanted part you want to delete, then press ∇ .

3 Press $\triangleleft \triangleright$ to select “EDITING”, then press **ENTER**.

4 Press \blacktriangleright to start playback. The playback pictures appear in the window on the screen. The elapsed playing time starts counting with the arrow on “IN”.

5 Find the point where you want the deletion to begin, then press **ENTER** with the arrow on “IN”. The edit-in time is fixed and the elapsed playing time starts counting again.

6 Find the point where you want the deletion to end, then press **ENTER** with the arrow on “OUT”. The edit-out time is fixed.

- Press $\triangleleft \triangleleft$, \blacktriangleright , $\blacktriangleright \blacktriangleright$, $\triangleleft \triangleleft$, $\blacktriangleright \blacktriangleright$ or \parallel to find the edit-in and edit-out points.

7 Press $\Delta \nabla \triangleleft \triangleright$ to select “PREVIEW”, then press **ENTER** to preview the edited program.

8 Press $\Delta \nabla \triangleleft \triangleright$ to select “EXECUTE”, then press **ENTER**.

- If you do not want to delete the scene, select “CLEAR” and press **ENTER**.

9 Press $\triangleleft \triangleright$ to select “YES”, then press **ENTER**. The selected scene is deleted.

- To cancel the deletion, press $\triangleleft \triangleright$ to select “NO”, then press **ENTER**.

To modify the points

1 Press $\triangleleft \triangleright$ to select “CLEAR”, then press **ENTER**.

2 Repeat steps **4** – **9** as necessary.

10 Press **NAVIGATION** to return to the normal screen.

NOTES:

- There may be a discrepancy of several seconds between the scene you intend to edit, and the scene which is actually edited.
- Available recording capacity may not match the deleted part after deletion.

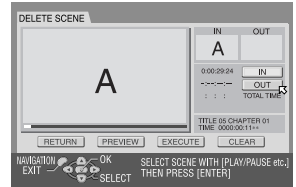

Modify Play List Information



- Turn on the TV and select the video channel (or AV mode).
- Slide the TV/CABLE/DBS/DVD switch to DVD.

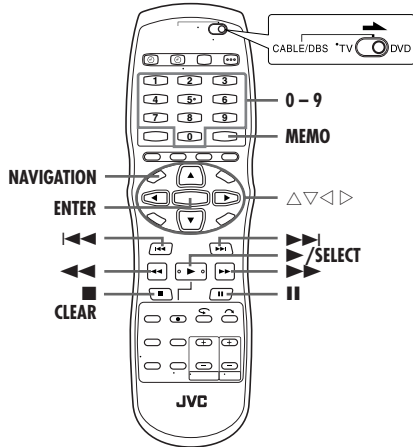

Play List

It is a collection of the scenes. A play list can be freely edited and played back without ever changing any original recording data. Using the random access of a DVD disc (which allows video data to be instantly read no matter where it is on the disc), a play list includes information such as the timer counter for the playback start point and end point, indexes for checking the contents of recorded data, category information, and more. Playback according to a play list you have created allows you to enjoy various combinations of video images from a single program.

Create Play List

- 1 Load a DVD-RAM or DVD-RW (VR mode) disc that was recorded with this unit.
- 2 Press **NAVIGATION**. The Library Database DVD Navi screen appears.
- 3 Press $\Delta \nabla \triangleleft \triangleright$ to select "PLAY LIST", then press ∇ or **ENTER**.
- 4 Press $\Delta \nabla \triangleleft \triangleright$ to select "CREATE", then press **ENTER**.
- 5 Press \blacktriangleright to start playback. The playback pictures appear in the window on the screen. The elapsed playing time starts counting with the arrow on "IN".
 - To locate the beginning of other titles, press $\blacktriangleleft \blacktriangleright \blacktriangleright \blacktriangleright$ or $\blacktriangleleft \blacktriangleright \blacktriangleright \blacktriangleright$ or \parallel .
- 6 Find the point where you want the created play list to begin, then press **ENTER** with the arrow on "IN". The edit-in time is fixed and the elapsed playing time starts counting again.
 - To locate the beginning of other titles, press $\blacktriangleleft \blacktriangleright \blacktriangleright \blacktriangleright$ or $\blacktriangleleft \blacktriangleright \blacktriangleright \blacktriangleright$ or \parallel .
- 7 Find the point where you want the created play list to end, then press **ENTER** with the arrow on "OUT". The edit-out time is fixed.
 - Press $\blacktriangleleft \blacktriangleright \blacktriangleright \blacktriangleright$, $\blacktriangleleft \blacktriangleright \blacktriangleright \blacktriangleright$ or \parallel to find the edit-in and edit-out points.
 - The edit-out point must come after the edit-in point.

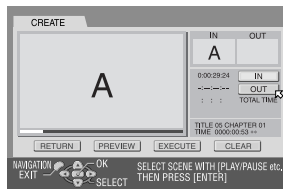

8 Press $\triangleleft \triangleright$ to select "PREVIEW", then press **ENTER** to preview the play list.

9 Press $\triangleleft \triangleright$ to select "EXECUTE", then press **ENTER**. The play list is created.

To modify the points

- 1 Press $\triangleleft \triangleright$ to select "CLEAR", then press **ENTER**.
- 2 Repeat steps 5 – 9 as necessary.

10 Press **NAVIGATION** to return to the normal screen.

NOTES:

- There may be a discrepancy of several seconds between the scene you intend to edit, and the scene which is actually edited.
- The title, index and category of the play list can be modified in the same way as "ORIGINAL". (pg. 56)
- You can modify the play list that has just been created here by adding, moving, or deleting unwanted parts to create a digest edition, etc.

Add Scenes To A Play List

1 Perform steps 1 to 3 of "Create Play List" (pg. 58) before continuing.

2 Press $\triangleleft \triangleright$ to select the play list to which you wish to add a scene, then press ∇ .

3 Press $\triangleleft \triangleright$ to select "EDITING", then press **ENTER**.

4 Press $\triangleleft \triangleright$ to select "ADD SCENE".

5 Press \blacktriangleright to start playback. The playback pictures appear in the window on the screen. The elapsed playing time starts counting with the arrow on "IN".

- To locate the beginning of other titles, press $\blacktriangleleft \blacktriangleright \blacktriangleright \blacktriangleright$.

6 Find the point where you want the added scene to begin, then press **ENTER** with the arrow on "IN". The edit-in time is fixed and the elapsed playing time starts counting again.

7 Find the point where you want the added scene to end, then press **ENTER** with the arrow on "OUT". The edit-out time is fixed.

- Press $\blacktriangleleft \blacktriangleright \blacktriangleright \blacktriangleright$, $\blacktriangleleft \blacktriangleright \blacktriangleright \blacktriangleright$ or \parallel to find the edit-in and edit-out points.

8 Press $\triangleleft \triangleright$ to select "PREVIEW", then press **ENTER** to preview approximately 5 seconds before and after the edited scene.

9 Press $\triangleleft \triangleright$ to select "EXECUTE", then press **ENTER**. The selected scene is added.

To modify the points

- 1 Press $\triangleleft \triangleright$ to select "CLEAR", then press **ENTER**.
- 2 Repeat steps 5 – 8 as necessary.

10 Press **NAVIGATION** to return to the normal screen.

NOTE:

There may be a discrepancy of several seconds between the scene you intend to edit, and the scene which is actually edited.

Move Scenes

1 Perform steps 1 to 3 of "Create Play List" (pg. 58) before continuing.

2 Press $\triangleleft \triangleright$ to select a play list into which you wish to move a scene, then press ∇ .

3 Press $\triangleleft \triangleright$ to select "EDITING", then press **ENTER**.

4 Press $\triangleleft \triangleright$ to select "MOVE SCENE".

5 Press \blacktriangleright to start playback. The playback pictures appear in the window on the screen. The elapsed playing time starts counting with the arrow on "IN".

- To locate the beginning of other titles, press $\blacktriangleleft \blacktriangleright \blacktriangleright \blacktriangleright$.

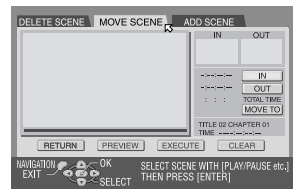
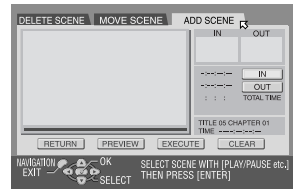

6 Find the point where you want the moved scene to begin, then press **ENTER** with the arrow on “IN”. The edit-in time is fixed and the elapsed playing time starts counting again.

7 Find the point where you want the moved scene to end, then press **ENTER** with the arrow on “OUT”. The edit-out time is fixed.

8 Press **▶** to start playback.

9 Find the point where you want the moved scene to be moved, then press **ENTER** with the arrow on “MOVE TO”.

• Press **◀◀**, **▶▶**, **◀◀▶▶** or **||** to find the edit-in, edit-out and move-to points.

10 Press **◀▶** to select “PREVIEW”, then press **ENTER** to preview the part approximately 5 seconds before and after the point to which the scene has been moved.

11 Press **◀▶** to select “EXECUTE”, then press **ENTER**. The selected scene is moved.

To modify the points

1 Press **◀▶** to select “CLEAR”, then press **ENTER**.

2 Repeat steps 5 – 11 as necessary.

12 Press **NAVIGATION** to return to the normal screen.

NOTE:

There may be a discrepancy of several seconds between the scene you intend to edit, and the scene which is actually edited.

Delete Unwanted Part From Play List

1 Perform steps 1 to 3 of “Create Play List” (pg. 58) before continuing.

2 Press **◀▶** to select a play list from which you wish to delete unwanted parts, then press **▽**.

3 Press **◀▶** to select “EDITING”, then press **ENTER**.

4 Press **◀▶** to select “DELETE SCENE”, then press **ENTER**.

5 Press **▶** to start playback. The playback pictures appear in the window on the screen. The elapsed playing time starts counting with the arrow on “IN”.

• To locate the beginning of other titles, press **◀◀▶▶**.

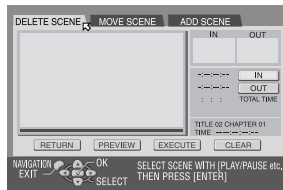

6 Find the point where you want the deletion to begin, then press **ENTER** with the arrow on “IN”. The edit-in time is fixed and the elapsed playing time starts counting again.

7 Find the point where you want the deletion to end, then press **ENTER** with the arrow on “OUT”. The edit-out time is fixed.

• Press **◀◀**, **▶▶**, **◀◀▶▶** or **||** to find the edit-in and edit-out points.

8 Press **◀▶** to select “PREVIEW”, then press **ENTER** to preview the scene approximately 5 seconds before and after the deleted part.

9 Press **◀▶** to select “EXECUTE”, then press **ENTER**. The selected scene is deleted.

To modify the points

1 Press **◀▶** to select “CLEAR”, then press **ENTER**.

2 Repeat steps 5 – 9.

10 Press **NAVIGATION** to return to the normal screen.

NOTE:

There may be a discrepancy of several seconds between the scene you intend to edit, and the scene which is actually edited.

Play Back Play List

1 Perform steps 1 to 3 of “Create Play List” (pg. 58) before continuing.

2 Press **◀▶** to select the index (small still pictures) of the desired play list.

• When you want the plural play lists to be played back continuously, press **MEMO** after selecting the desired play lists. The numbers of the playback order appear on the index. You can select up to 30 play lists.

• When you want to correct the order, move the arrow on the desired index and press **MEMO**. The number disappears and the unit re-numbers the other play lists automatically.

• When you want to cancel the order, press **CLEAR** (■).

3 Press **ENTER** or **SELECT** (▶) to start playback. The playback starts.

4 Press **||** to pause playback.

• To resume normal playback, press **▶**.

5 Press **■** to stop playback.



Delete Play List

1 Perform steps 1 to 3 of “Create Play List” (pg. 58) before continuing.

2 Press **◀▶** to select one play list you want to delete, then press **▽**.

3 Press **◀▶** to select “DELETE”, then press **ENTER**.

4 Press **◀▶** to select “YES”, then press **ENTER**.

• When you cancel the deletion, select “NO”, then press **ENTER**.

5 Press **NAVIGATION** to return to the normal screen.

NOTE:

Even if a play list is deleted, the programs recorded on a DVD disc and the library information are not affected at all.

Modify Index

1 Perform steps 1 to 3 of “Create Play List” (pg. 58) before continuing.

2 Perform steps 3 to 8 of “Modify Index” (pg. 56).

Modify Program Title

1 Perform steps 1 to 3 of “Create Play List” (pg. 58) before continuing.

2 Press **△▽◀▶** to select one program you want to modify, then press **▽**.

3 Perform steps 2 to 7 of “Modify Program Name” (pg. 57).

Modify Category

1 Perform steps 1 to 3 of “Create Play List” (pg. 58) before continuing.

2 Press **△▽◀▶** to select one program you want to modify, then press **▽**.

3 Perform steps 2 to 6 of “Modify Category” (pg. 57).

Modify Library Information



Program information can be registered in the unit's memory for up to 1,300 programs. It is helpful when finding out on which disc the desired program is recorded.

- Turn on the TV and select the video channel (or AV mode).
- Slide the **TV/CABLE/DBS/DVD** switch to **DVD**.

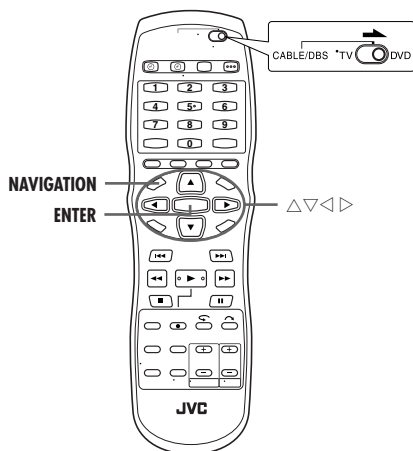

Scan For Program From Library

1 Press **NAVIGATION**. The Library Database DVD Navi screen appears.

2 Press $\Delta \nabla \triangleleft \triangleright$ to select "LIBRARY", then press **ENTER**.

3 Press $\triangleleft \triangleright$ to select the appropriate sort button to sort the information, then press **ENTER**.

"DISC No." : Sort by disc number

"CATEGORY" : Sort by category

"DATE" : Sort by date

"NAME" : Sort by name

- The sorting order can be switched between ascending order and descending order by pressing the sort buttons.

4 Press $\triangleleft \triangleright$ to select the desired program, then press **ENTER**.

- Playback begins automatically after the selected program is located.

When the disc that contains the selected program is not loaded

A screen prompting you to load the designated disc appears. Place the disc whose number is displayed on the screen after pressing **ENTER** to close the prompt screen. Then perform steps **1** to **4**.

NOTE:

If a disc registered in the library is recorded or modified on DVD units from other manufacturers, it may become impossible to operate properly.



Register Disc

1 Load a disc you want to register.

2 Press **NAVIGATION**. The Library Database DVD Navi screen appears.

3 Press $\Delta \nabla \triangleleft \triangleright$ to select "LIBRARY", then press **ENTER**.

4 Press $\triangleleft \triangleright$ to select "REGISTER", then press **ENTER**.

5 Press $\triangleleft \triangleright$ to select "REGISTER", then press **ENTER** to confirm the registration.

6 Press **NAVIGATION** to return to the normal screen.

NOTES:

- It is not possible to register discs used for On-Disc Timer Programming. (pg. 43)
- It is not possible to register discs formatted on devices other than JVC's DVD recorders.
- It is not possible to register discs recorded on devices other than JVC's DVD recorders.
- It is not possible to register discs when "SAVE AS LIBRARY" is set to "OFF". (pg. 74)

Delete Information

1 Press **NAVIGATION**. The Library Database DVD Navi screen appears.

2 Press $\Delta \nabla \triangleleft \triangleright$ to select "LIBRARY", then press **ENTER**.

3 Press $\Delta \nabla \triangleleft \triangleright$ to select the appropriate sort button to sort the information, then press **ENTER**.

4 Press $\triangleleft \triangleright$ to select a program you want to delete, then press ∇ .

5 Press $\Delta \nabla \triangleleft \triangleright$ to select "DELETE", then press **ENTER**.

6 Press $\triangleleft \triangleright$ to select "DELETE", then press **ENTER** to confirm the deletion.

7 Press **NAVIGATION** to return to the normal screen.

Playback With MP3/JPEG Navigation



This unit can play back discs that MP3 sound files and JPEG image files taken with digital still cameras or other devices are recorded.

The MP3/JPEG Navigation enables you to search and select the desired files recorded on CD-R/RW or CD-ROM discs very easily.

The following screen appears as the MP3/JPEG Navigation screen when you press **NAVIGATION**. You can move the arrow to select the desired position on the screen by pressing $\Delta \nabla \triangleleft \triangleright$ on the remote control.

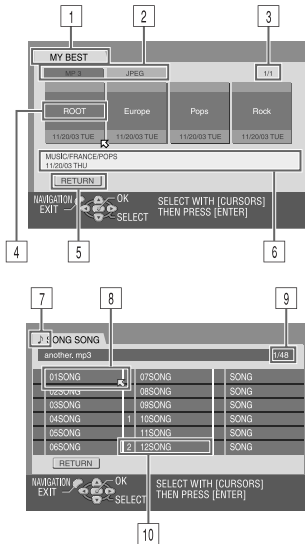

- 1 Name of the inserted disc.
- 2 Sort buttons ("MP3"/ "JPEG")
- 3 Selected group number/total number of groups on the disc
- 4 Group name
- 5 Return button ("RETURN")
- 6 Group name/Created date
- 7 File type indicator
J: MP3
I: JPEG
- 8 Selected file
- 9 Selected file number/total number of files in the group that contains the selected file
- 10 Program number/file name

Locating The Desired Group And Tracks

- 1 Load a disc.
- 2 Press **NAVIGATION**. The MP3/JPEG Navigation screen appears.
- 3 **For MP3 Playback**
Press $\triangleleft \triangleright$ to select "MP3". Only groups which contain MP3 files appear.
- 3 **For JPEG Playback**
Press $\triangleleft \triangleright$ to select "JPEG". Only groups which contain JPEG files appear.

4 Press $\triangleleft \triangleright$ to select the desired group, then press **ENTER**.

For MP3 Playback

- The tracks in the selected group appear.

For JPEG Playback

- The images in the selected group appear.

5 Press $\Delta \nabla \triangleleft \triangleright$ to select the desired item, then press **ENTER**.

The unit starts playback from the selected item.

- The unit stops when all items in the selected group are played back.

NOTES:

- If you press **SELECT** (\blacktriangleright) instead of **ENTER** in step 4, the unit starts playback from the first file of the group.
- JPEG files are played back as a slide show at the set intervals. (pg. 36)
- If a file name includes any 2-byte character, the unit may not show the file name correctly.
- Press $\Delta \nabla$ to select "RETURN", then press **ENTER** to return to the screen that shows the group(s).
- The order of the groups and items shown in steps 4 and 5 may differ from the order shown on your PC.

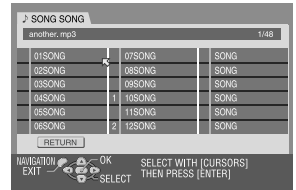
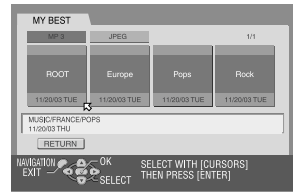

Program Playback

- 1 Perform steps 1 to 4 of "Locating The Desired Group And Tracks" in the left column before continuing.
- 2 Press $\Delta \nabla \triangleleft \triangleright$ to select the desired item, then press **MEMO** in the desired order.
 - The order number appears on the left of the track name.
 - Repeat this step as necessary.
 - To cancel the track, press $\Delta \nabla \triangleleft \triangleright$ to select the track, then press **CANCEL**.
 - Pressing **CLEAR** (\blacksquare) clears all the order numbers.
- 3 Press \blacktriangleright to start playback.
 - To quit the Program Playback, press \blacksquare .
 - Repeat playback can be performed if it is set as such on the on-screen bar. (pg. 34)

NOTES:

- It is not possible to select tracks and images simultaneously.
- It is not possible to select tracks or images in other groups.

On completion of the playback of all the items

- 1 Perform steps 1 to 4 of "Locating The Desired Group And Tracks" in the left column.
- 2 Press **CLEAR** (\blacksquare).
 - The order numbers are reset and cleared.
- 3 Press **NAVIGATION** to complete the procedure.

Tape Dubbing (From VCR To DVD)

Dubbing An Entire Cassette

Because this unit includes both DVD deck and VCR deck, you can easily use this unit for dubbing without connecting any other equipment.

- Turn on the unit.
- Turn on the TV and select the video channel (or AV mode).
- Slide the **TV/CABLE/DBS/DVD** switch to **DVD**.

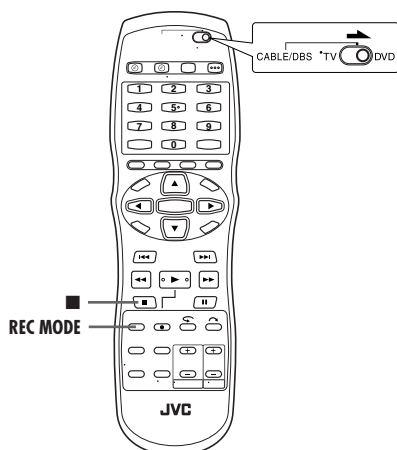
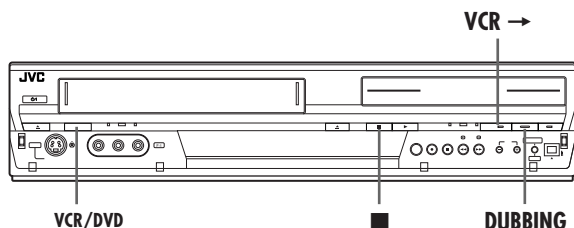

1 For DVD deck

Load a recordable disc.

For VCR deck

Load a cassette you want to dub.

2 Press **VCR/DVD** repeatedly so that the DVD lamp lights up on the unit.

3 Press **REC MODE** repeatedly to set the recording mode.

4 Press **VCR→** to select the dubbing direction.

• “VCR→” lights up on the unit.

5 Press and hold **DUBBING** for more than 2 seconds to start dubbing.

• If the tape has not been rewound, the VCR deck rewinds the tape automatically. When the VCR deck has finished rewinding, dubbing begins automatically.

• After dubbing is completed, the VCR deck rewinds the tape automatically and the unit shuts off.

• To stop dubbing, press ■.

NOTES:

- If you set the dubbing direction incorrectly, you could erase an important recording that you wanted to dub. It is recommended to conduct a test with unimportant cassettes first.
- The superimposed indication during the operation or dubbing is not recorded.
- It is not possible to dub a tape with a copy protection signal.
- If the recording capacity of disc become full, the tape stops automatically.
- It is not possible to perform other operations like Live Memory Playback. Check the recorded program on the disc after dubbing.
- Dubbing is not possible on the discs used exclusively for On-Disc Timer Programming.
- If the index code is found on a tape, a single title is created. While creating a title, the dubbing stops and then starts again.
- When dubbing can not be performed properly, set “BLUE BACK” to “OFF”. (pg. 76)

Manual Dubbing (From VCR To DVD)

Dubbing A Part Of A Cassette

You can dub the selected scenes on a tape to the DVD disc, starting and stopping wherever you wish.

- Turn on the unit.
- Turn on the TV and select the video channel (or AV mode).
- Slide the **TV/CABLE/DBS/DVD** switch to **DVD**.

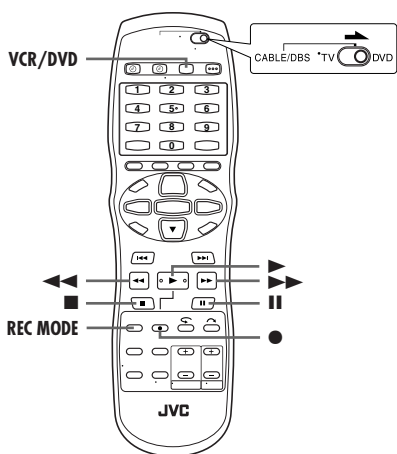
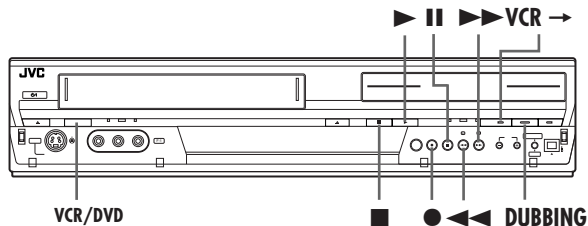

1 For DVD deck
Load a recordable disc.

For VCR deck
Load a cassette you want to dub.

2 Press **VCR→** to select the dubbing direction.
• "VCR→" lights up on the front display panel.

3 Prepare the VCR deck for dubbing.
1 Press **VCR/DVD** repeatedly so that the VCR lamp lights up on the unit.

2 Locate the point from where you want to start dubbing, then pause playback by pressing the following buttons: **▶**, **▶▶**, **◀◀**, **■**, **||**

4 Prepare the DVD deck for dubbing.
1 Press **VCR/DVD** repeatedly so that the DVD lamp lights up on the unit.

2 Press **REC MODE** repeatedly to set the recording mode.
3 Press and hold **||**, then press **●** so that the DVD deck enters the Record Pause mode.

5 Press and hold **DUBBING** for more than 2 seconds to start dubbing.

6 Press **■** to stop recording on the DVD deck. Then press **VCR/DVD**, and press **■** to stop playback on the VCR deck.

NOTES:

- If you set the dubbing direction incorrectly, you could erase an important recording that you wanted to dub. It is recommended to conduct a test with unimportant cassettes first.
- There may be a discrepancy of several seconds between where you intend dubbing to start, and where it actually starts.
- The superimposed indication during the operation or dubbing is not recorded.
- It is not possible to dub a tape with a copy protection signal.
- If the recording capacity of disc become full, the tape stops automatically.
- It is not possible to perform other operations like Live Memory Playback. Check the recorded program on the disc after dubbing.
- Dubbing is not possible on the discs used exclusively for On-Disc Timer Programing.
- When dubbing can not be performed properly, set "BLUE BACK" to "OFF". (pg. 76)

Disc Dubbing (From DVD To VCR)

Dubbing An Entire Disc

Because this unit includes both DVD deck and VCR deck, you can easily use this unit for dubbing without connecting any other equipment.

- Turn on the unit.
- Turn on the TV and select the video channel (or AV mode).
- Slide the **TV/CABLE/DBS/DVD** switch to **DVD**.

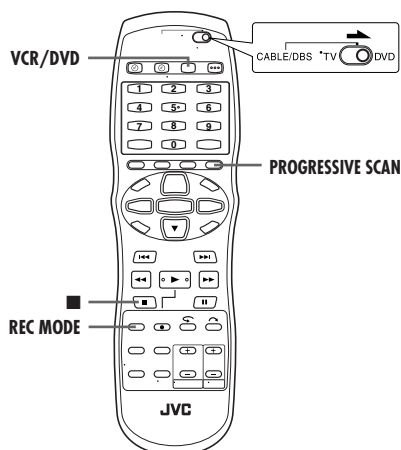
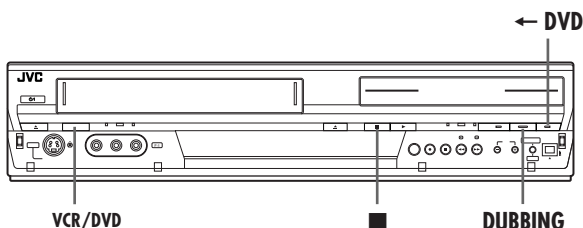

1 For DVD deck

Load a disc you want to dub.

For VCR deck

Load a cassette with the record safety tab intact.

2 Press **VCR/DVD** repeatedly so that the VCR lamp lights up on the unit.

3 Press **REC MODE** repeatedly to set the recording mode.

4 Press **←DVD** to select the dubbing direction.

• “←DVD” lights up on the unit.

5 Press and hold **DUBBING** for more than 2 seconds to start the dubbing.

• If the tape has not been rewound, the VCR deck rewinds the tape automatically. When the VCR deck has finished rewinding, dubbing begins automatically.

• After dubbing is completed, the VCR deck rewinds the tape automatically and the unit shuts off.

• To stop dubbing, press ■.

NOTES:

- It is not possible to start dubbing if the unit retains a memory of the resume points. Press ■ twice to clear the resume points.
- There may be a discrepancy of several seconds between where you intend dubbing to start, and where it actually starts.
- The superimposed indication during the operation or dubbing is not recorded.
- When the end of the tape is reached during dubbing, the tape is ejected and both deck stops.
- When the progressive mode is set, “←DVD” does not light up on the front display panel. Press **PROGRESSIVE SCAN** so that video output indicator (P) lights off on the front display panel.
- It may be impossible to dub a DVD-R or DVD-RW (Video mode) disc recorded on the devices from other manufacturers or on a PC. In such case, perform “Manual Dubbing (From DVD To VCR)” (pg. 65).
- It is not possible to perform other operations like Live Memory Playback. Check the recorded program on the disc after dubbing.
- If “VCR→” lights up on the unit and you play back a DVD VIDEO disc, the images dubbed to the VCR deck may not be output to the TV properly.

Manual Dubbing (From DVD To VCR)

Dubbing A Part Of A Disc

You can dub the selected scenes on a tape to the DVD disc, starting and stopping wherever you wish.

- Turn on the unit.
- Turn on the TV and select the video channel (or AV mode).
- Slide the **TV/CABLE/DBS/DVD** switch to **DVD**.

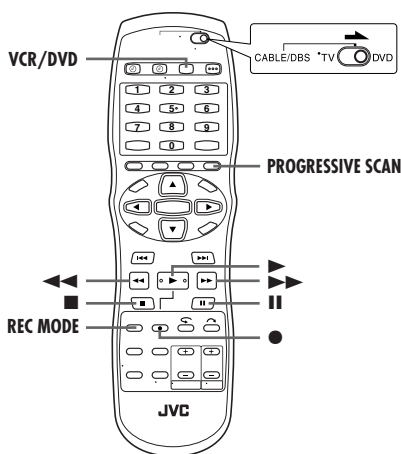
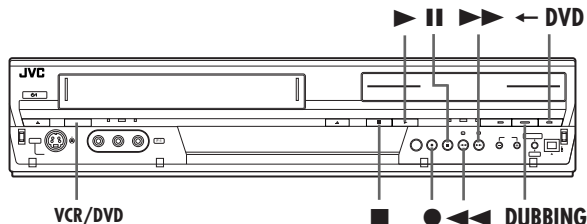

1 For DVD deck

Load a disc you want to dub.

For VCR deck

Load a cassette with the record safety tab intact.

2 Press **←DVD** to select the dubbing direction.

- "←DVD" lights up on the front display panel.

3 Prepare the DVD deck for dubbing.

1 Press **VCR/DVD** repeatedly so that the DVD lamp lights up on the unit.

2 Locate the point from where you want to start dubbing, then pause playback by pressing the following buttons: **▶**, **▶▶**, **◀◀**, **■**, **||**

4 Prepare the VCR deck for dubbing.

1 Press **VCR/DVD** repeatedly so that the VCR lamp lights up on the unit.

2 Press **REC MODE** repeatedly to set the recording mode.

3 Press and hold **||**, then press **●** so that the VCR deck enters the Record Pause mode.

5 Press and hold **DUBBING** for more than 2 seconds to start the dubbing.

6 Press **■** to stop recording on the VCR deck. Then press **VCR/DVD**, and press **■** to stop playback on the DVD deck.

NOTES:

- It is not possible to start dubbing if the unit retains a memory of the resume points. Press **■** twice to clear the resume points.
- There may be a discrepancy of several seconds between where you intend dubbing to start, and where it actually stars.
- The superimposed indication during the operation or dubbing is not recorded.
- When the end of the tape is reached during dubbing, the tape is ejected and both deck stops.
- When the progressive mode is set, "←DVD" does not light up on the front display panel. Press **PROGRESSIVE SCAN** so that video output indicator (**P**) lights off on the front display panel.
- It is not possible to perform other operations like Live Memory Playback. Check the recorded program on the disc after dubbing.

DV Dubbing (DVD Deck Only)

You can dub programs from a camcorder or DV equipment connected to the unit with a DV cable. The unit's remote control allows you the limited control of the connected camcorder or DV equipment functions during dubbing.

NOTE:

When you connect a PC to the DV IN connector, we do not assure the normal operation of this unit.

Your unit

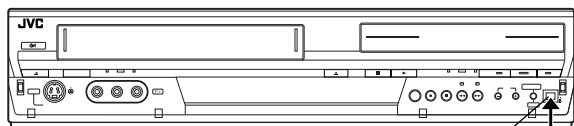

DV IN connector

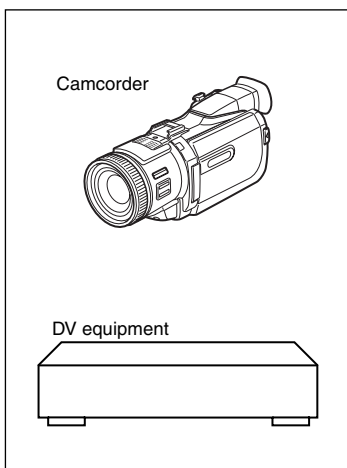

1 Connect a camcorder or DV equipment to the DV IN connector on the unit's front panel.

2 Load a DVD-RAM/RW/R disc on the unit.

3 Press **CH +/-** to set the channel to "DV DUBBING".

- The "DV DUBBING" controller appears on the TV screen.
- If "DV DUBBING" does not appear on the "DV DUBBING" controller, make sure the DV equipment is connected correctly.

4 Press $\triangleleft \triangleright$ to select , then press **ENTER**.

5 Press $\triangle \nabla$ to select the desired sound track, then press **ENTER**.

AUDIO 1: Select this to record the original stereo sound played back on the connected DV equipment.

AUDIO 2: Select this to record the dubbed stereo sound played back on the connected DV equipment.

MIX: Select this to record the sound of both "AUDIO 1" and "AUDIO 2".

- Note that this selection is not available when the source program is recorded in 16BIT (48 kHz) mode.

6 Press **REC MODE** repeatedly to set the recording mode.

7 Locate the point from where you want to start dubbing, then stop or pause playback by pressing the following buttons on the remote control: \blacktriangleright , $\blacktriangleright\blacktriangleright$, $\blacktriangleleft\blacktriangleleft$, \blacksquare , $\blacksquare\blacksquare$

- To play back in slow speed (1/10 of the normal speed), press $\blacksquare\blacksquare$ to pause playback, then press $\blacktriangleleft\blacktriangleleft$ or $\blacktriangleright\blacktriangleright$.
- To play back frame-by-frame, press $\blacksquare\blacksquare$ to pause playback, then press $\blacksquare\blacksquare$ repeatedly. Each press of $\blacksquare\blacksquare$ advances a frame.
- To change the playback direction, press $\blacktriangleleft\blacktriangleleft$ or $\blacktriangleright\blacktriangleright$.

8 Press $\triangleleft \triangleright$ to select , then press **ENTER**. The dubbing starts.

- Playback on the external DV equipment and recording on the unit should start simultaneously.
- When the playback from the beginning is not possible, the "DV DUBBING" controller cannot be used. Perform dubbing without using the "DV DUBBING" controller. (See below)
- To pause dubbing, press $\triangleleft \triangleright$ to select , then press **ENTER**. Both the unit and the external DV equipment pause dubbing. Pressing $\blacksquare\blacksquare$ on the unit also works the same way.
- To clear the "DV DUBBING" controller from the TV screen, press **ON SCREEN**.

9 Press \blacksquare on the remote control to stop dubbing.

- Both the unit and the external DV equipment stop dubbing.

NOTES:

- Dubbing copyright guarded programs is not possible.
- Original DV informations such as the recording date and time are not recorded.
- The superimposed indication during the operation or dubbing is not recorded.
- It is not possible to perform dubbing when "VCR→" lights up on the unit. Press **VCR→** so that "VCR→" lights off.

Performing dubbing without using the "DV DUBBING" controller

- 1 Press **CH +/-** to set the channel to "DV DUBBING".
- 2 Press **REC MODE** repeatedly to set the recording mode.
- 3 Start playback on the external DV equipment slightly before the actual point from where you wish to start dubbing.
- 4 Press \bullet on the unit to start recording. Or press and hold \bullet and press \blacktriangleright on the remote control. The dubbing starts.
- 5 When the dubbing ends, press \blacksquare on the unit, then stop playback on the external DV equipment.



Edit From A Camcorder

You can use a camcorder as the source player and your unit as the recording deck.

1 If the camcorder has no S-VIDEO output connector:

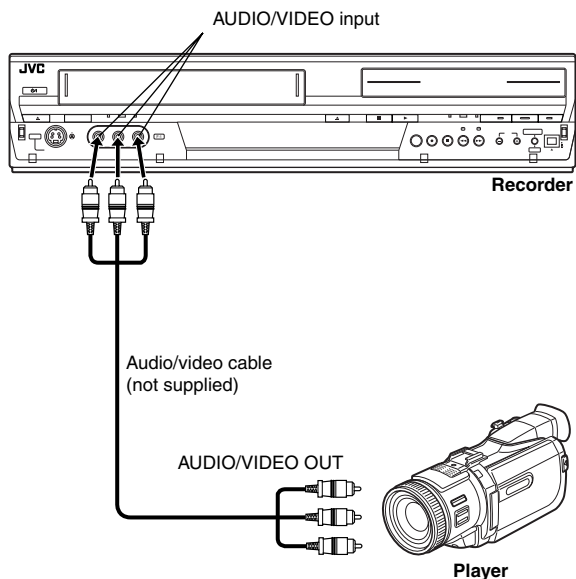

2 If the camcorder has an S-VIDEO output connector (DVD deck only):

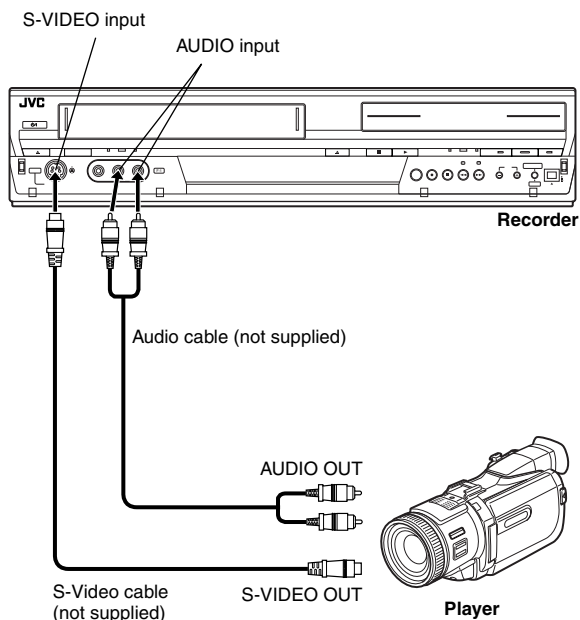

Slide the **TV/CABLE/DBS/DVD** switch to **DVD**.

- 1** Make connections.
 - 1** If the camcorder has no S-VIDEO output connector:
 - connect the camcorder's AUDIO/VIDEO OUT connectors to the unit's AUDIO/VIDEO input connectors on the front panel.
 - When using a monaural camcorder, connect its AUDIO OUT connector to the AUDIO L input connector on your unit.
 - 2** If the camcorder has an S-VIDEO output connector: (DVD deck only)
 - connect the camcorder's AUDIO OUT and S-VIDEO OUT connectors to the unit's AUDIO and S-VIDEO input connectors on the front panel.
 - 2** Press **VCR/DVD** repeatedly to select the recording deck.
 - 3** Press **CH +/-** to select "F-1".
- For DVD deck**
- Set "FRONT AUX F-1" to "VIDEO" for the VIDEO input connector, or "S-VIDEO" for the S-VIDEO input connector, depending on the connector being used. (pg. 74)
- 4** Press **REC MODE** repeatedly to set the recording mode.
 - 5** Start playback on the camcorder slightly before the actual point from where you wish to start dubbing.
 - 6** Press ● on the unit to start recording. Or press and hold ● and press ► on the remote control. The dubbing starts.
 - 7** Press ■ on the unit, then stop playback on the camcorder.

NOTES:

- All necessary cables can be obtained from your dealer.
- Refer to the camcorder's instruction manual for operating procedure.
- The quality of dubbed picture becomes poorer than that of the original.

Edit To Or From Another Recorder

You can use your unit as the source player or as the recording deck.

NOTE:

When using another recorder as the recording deck, refer to its instruction manual.

1 When recording on the DVD deck:

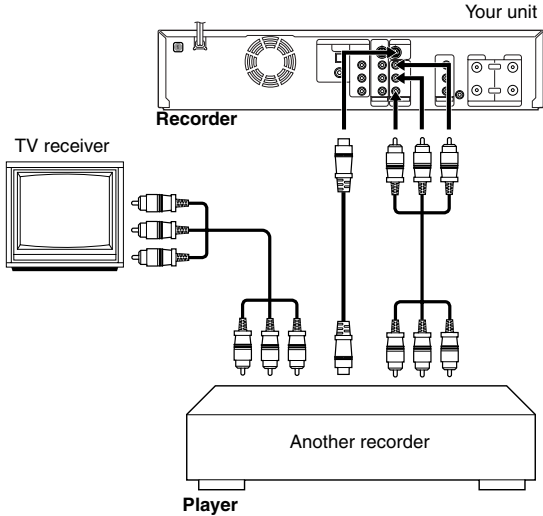

2 When recording on the VCR deck:

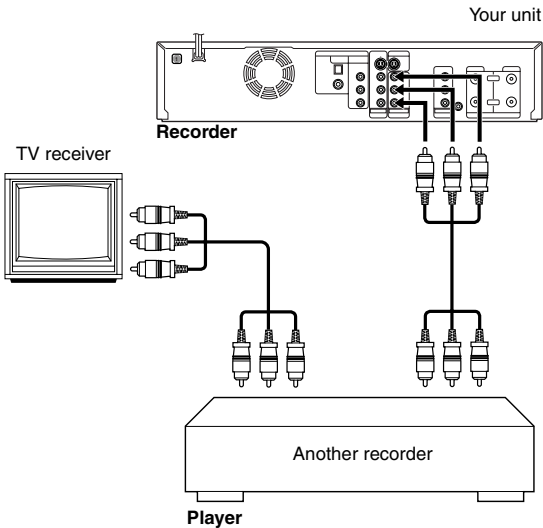

Slide the TV/CABLE/DBS/DVD switch to DVD.

1 Make connections.

1 When recording on DVD deck

1) If the another recorder has no S-VIDEO connector, connect the unit's AUDIO/VIDEO INPUT connectors to the audio/video output connectors on another recorder.

2) If the another recorder has S-VIDEO connector, connect the AUDIO INPUT and S-VIDEO INPUT connectors to the audio and S-video output connectors on another recorder.

- If connecting a unit with an S-VIDEO connector, it is recommended to use an optional S-Video cable to minimize picture degradation while editing.

2 When recording on VCR deck

1) Connect the unit's AUDIO/VIDEO INPUT connectors to the audio/video output connectors on another recorder

2 Press VCR/DVD repeatedly to select the recording deck.

3 Press CH +/- to select "L-1" when using this unit as the recording deck.

For DVD deck

- Set "REAR AUX L-1" to "VIDEO" for the VIDEO input connector, or "S-VIDEO" for the S-VIDEO input connector, depending on the connector being used. (pg. 74)

4 Press REC MODE repeatedly to set the recording mode.

5 Engage the Play mode of the source player.

6 Engage the Record mode of the recording deck.

7 Stop recording on the recording deck, then stop playback on the source player.

NOTES:

- All necessary cables can be obtained from your dealer.
- When you use this unit as the source player for editing, be sure to set "SUPERIMPOSE" to "OFF" before starting. (pg. 74)

Digital Audio Dubbing

You can dub selected audio from a DVD or Audio CD disc to a digital audio device.

However, it is not possible to dub copy-protected discs.

- Turn on the TV and select the video channel (or AV mode).
- Slide the **TV/CABLE/DBS/DVD** switch to **DVD**.

Example: Dubbing to an MD

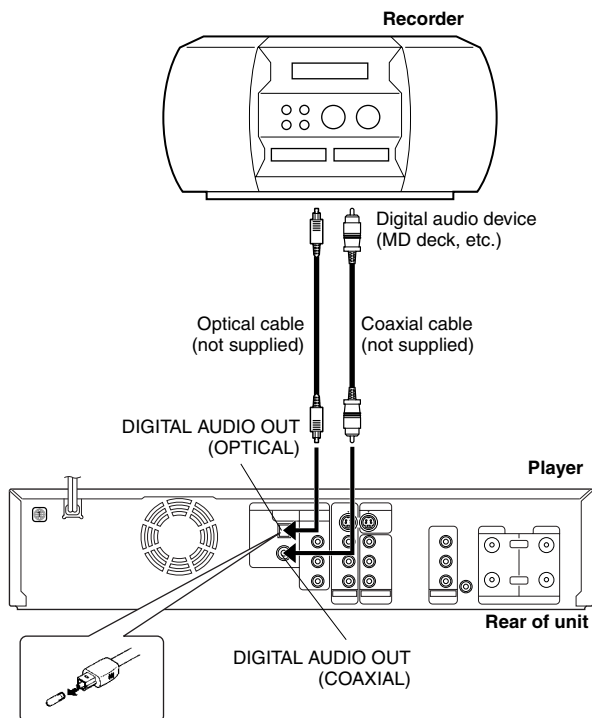

Note for connection:
Remove the protection cap from the cable.

- 1** Connect the unit and a digital audio device using either an optional optical cable or an optional coaxial cable.
- 2** Place a disc on the unit and load an MD on the connected digital audio device.
- 3** Select the audio to be dubbed.
- 4** Start playback slightly before the actual point from where you wish to start dubbing.
- 5** Press **II** to pause playback.
- 6** Select the input mode on the connected digital audio device.
- 7** Press **▶** to start playback on the unit.
- 8** Start recording on the digital audio device.
- 9** Stop recording on the digital audio device. Then press **■** to stop playback on the unit.

NOTE:

There may be a discrepancy of several seconds between where you intend editing to start, and where it actually starts.

Remote Control Functions

Remote control 1/2/3/4 Code Switching

The remote control is capable of controlling four JVC video units independently. Each of the units can respond to one of four codes (1, 2, 3 or 4). The remote control is preset to send 3 code signals because your unit is initially set to respond to 3 code signals. You can easily modify your unit to respond to 1, 2 or 4 code signals.

Slide the **TV/CABLE/DBS/DVD** switch to **DVD**.

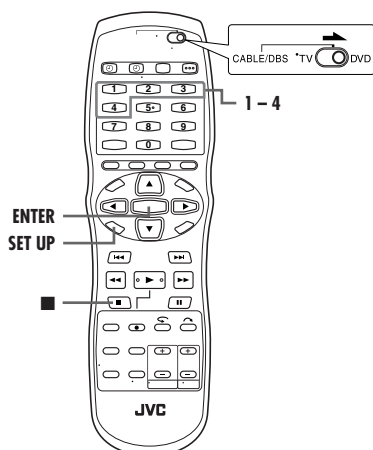
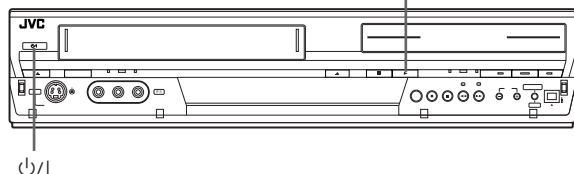

- Keep pressing **SET UP** down during step 1.

1 Press the **number key** “1” for 1, “2” for 2, “3” for 3 or “4” for 4 to change the remote control code, then press **ENTER**.

2 Press $\psi/1$ on the unit to turn off the unit.

3 Press \blacktriangleright on the unit for over 5 seconds while the unit is turned off. The code currently set appears on the front display panel.

4 Press \blacksquare on the remote control to change the unit's code. The code currently set on the remote control blinks on the front display panel for approximately 5 seconds, and is applied to the unit.

NOTE:

When “POWER SAVE” is set to “ON” (pg. 74), it is not possible to change the remote code.

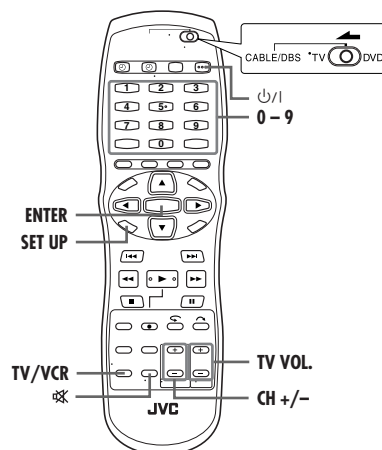

TV Multi-Brand Remote Control

Your remote control can operate the basic functions of your TV set. In addition to JVC TVs, other manufacturer's TVs can also be controlled.

- Turn off the TV using its remote control.
- Slide the **TV/CABLE/DBS/DVD** switch to **TV**.

IMPORTANT:

Although the supplied remote control unit is compatible with JVC televisions, as well as many other models, it may not work with your TV, or in some instances, may have limited function capability.

- Keep pressing **SET UP** down during step 1.

1 Enter your TV's brand code using the **number keys**, then press **ENTER**.

2 Press $\psi/1$ on the unit's remote control to turn on the TV and try operations (step 3).

- Once you have set the remote control to operate the TV, you do not have to repeat this step until you replace your remote control's batteries.

- Some brands of TVs have more than one code. If the TV does not function with one code, try entering another.

3 Press the corresponding button to operate the TV: $\psi/1$, **TV/VCR**, **CH +/-**, **TV VOL.**, M (TV Muting), **number keys**.

- For some brands of TVs, you must press **ENTER** after having pressed the **number keys**.

| BRAND NAME | CODE |
|------------|--------|
| JVC | 01, 03 |
| HITACHI | 10 |
| MAGNAVOX | 02 |
| MITSUBISHI | 03 |
| PANASONIC | 04, 11 |
| RCA | 05 |
| SHARP | 06 |
| SONY | 07 |
| SAMSUNG | 12 |
| SANYO | 13 |
| SEARS | 13 |
| TOSHIBA | 08 |
| ZENITH | 09 |

Cable Box Or DBS Receiver Multi-Brand Remote Control

Your remote control can operate the basic functions of your cable box or DBS (Direct Broadcast Satellite) receiver set. In addition to JVC cable boxes or DBS receivers, other manufacturer's cable boxes or DBS receiver can also be controlled.

Slide the **TV/CABLE/DBS/DVD** switch to **CABLE/DBS**.

- Keep pressing **SET UP** down during step 1.
- 1** Enter your cable box or DBS receiver's brand code using the **number keys**, then press **ENTER**.
- 2** Press $\psi/1$ on the unit's remote control to turn on the cable box or DBS receiver and try operations (→ step 3).
- Once you have set the remote control to operate the cable box or DBS receiver, you do not have to repeat this step until you replace your remote control's batteries.
- Some brands of cable box or DBS receiver have more than one code. If the cable box or DBS receiver does not function with one code, try entering another.
- 3** Press the corresponding button to operate the cable box or DBS receiver: $\psi/1$, **CH +/-**, **number keys**.
- For some brands of cable box, you must press **ENTER** after having pressed the **number keys**.
- The **number keys** may not function with some cable boxes.

IMPORTANT:

It may not work with your cable box, or in some instances, may have limited function capability.

NOTES:

- You must set the brand for your remote control and for your Controller (→ pg. 22) separately. The list of brands that can be controlled by your remote control is different from the list of brands that can be controlled by your controller.
- It's not possible to operate a cable box or DBS receiver that is not equipped with a receiving window.
- It's not possible to set the remote control for both your cable box and a DBS receiver at the same time. You can only set the remote control to operate one of these units at a time.

| CABLE BOX BRAND | CODE |
|---------------------|----------------------------|
| ARCHER | 01, 05, 17 |
| CABLETENNA | 01, 17 |
| CABLEVIEW | 15, 16, 17, 21, 25 |
| CITIZEN | 15, 16, 17, 21, 25 |
| CURTIS | 02 |
| DIAMOND | 01, 17 |
| GC BRAND | 15, 16, 17, 21, 25 |
| GEMINI | 15 |
| GENERAL INSTRUMENTS | 01, 04, 06, 11, 12, 15, 28 |
| HAMLIN | 10, 18, 23 |
| JASCO | 15 |
| JERROLD | 01, 04, 06, 11, 12, 15, 28 |
| NOVAVISION | 02 |
| OAK | 07 |
| PANASONIC | 13, 14 |
| PULSER | 15, 16, 17, 21, 25 |
| RCA | 13, 14 |
| REGAL | 10, 18, 23 |
| REMBRANDT | 01, 16, 17 |
| SAMSUNG | 05, 16, 24 |
| SCIENTIFIC ATLANTA | 02 |
| SIGMA | 07 |
| SL MARX | 05, 16, 17, 24, 25 |
| SPRUCER | 13, 14 |
| STARGATE | 05, 15, 16, 17, 21, 24, 25 |
| TELEVIEW | 05, 16, 24 |
| TOCOM | 01, 04, 16 |
| UNIKA | 01, 17 |
| UNIVERSAL | 16, 17, 25 |
| VIDEOWAY | 03, 09, 22 |
| ZENITH | 03, 09, 22 |

| DBS RECEIVER BRAND | CODE |
|-------------------------|------|
| JVC (DISH Network) | 51 |
| ECHOSTAR (DISH Network) | 51 |
| SONY (DSS) | 41 |
| RCA (DSS) | 40 |

Connecting To A Dolby Digital Decoder Or An Amplifier With Built-in DTS

These instructions enable you to connect your unit to a Dolby Digital decoder or an amplifier with built-in DTS.

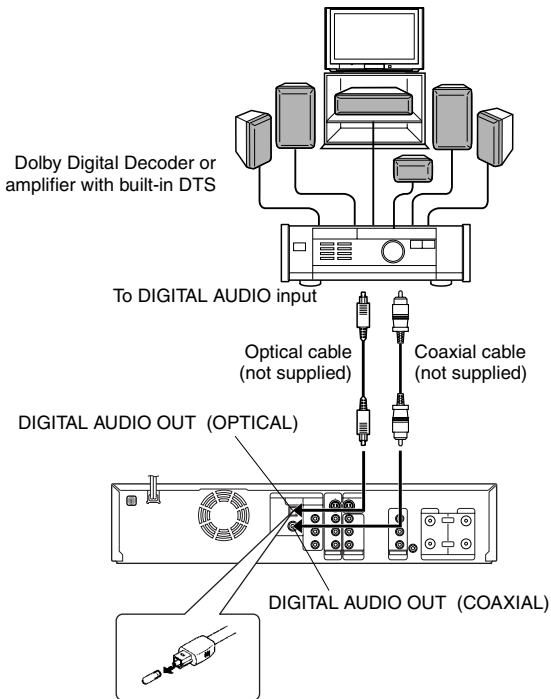

Note for connection:

Remove the protection cap from the cable.

1 Connect the unit and a Dolby Digital decoder or an amplifier with built-in DTS using either an optional optical cable or an optional coaxial cable.

NOTES:

- For Dolby Digital sound, set "DIGITAL AUDIO OUT" to "DOLBY DIGITAL/PCM". (→ pg. 73)
- For DTS sound, set "DIGITAL AUDIO OUT" to "STREAM/PCM". (→ pg. 73)

CAUTIONS:

- This unit has a dynamic range of more than 110 dB with regards to its Hi-Fi audio capability. It is recommended that you check the maximum level if you are going to listen to the Hi-Fi audio signals through a stereo amplifier. A sudden surge in the input level to the speakers may damage them.
- Some speakers and televisions are specially shielded to prevent television interference. If both are of the non-shielded type, do not place the speakers adjacent to the TV set as this can adversely affect the playback picture.

Mode Set (DVD Deck)

- Turn on the unit.
- Turn on the TV and select the video channel (or AV mode).
- Slide the **TV/CABLE/DBS/DVD** switch to **DVD**.

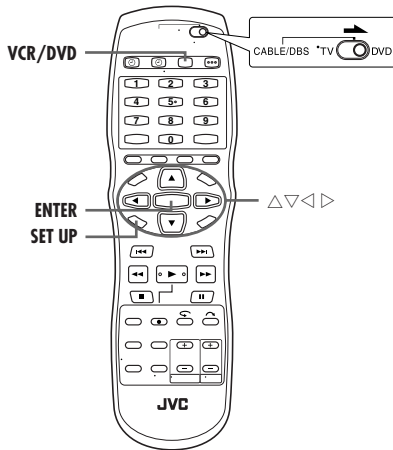

Various modes of this unit are categorized into menus nested in 2 levels shown in the following table. To change the settings of these modes, find the desired mode in the menu (for details on each menu, see pages 73 through 74), then follow the procedure below.

| | |
|------------------------|--|
| DVD SET UP | LANGUAGE SET (pg. 19) AUDIO OUTPUT (pg. 73) UTILITY (pg. 37, 78) |
| FUNCTION SET UP | VIDEO IN/OUT (pg. 24, 74) RECORDING SET (pg. 74) DISPLAY SET (pg. 74) OTHERS (pg. 74) |
| INITIAL SET UP | TUNER SET (pg. 21) STB SET (pg. 22) CLOCK SET (pg. 20) |

- The procedure below shows how to set the desired option of the "2ND AUDIO RECORD" mode as an example.

- 1 Press **VCR/DVD** repeatedly so that the DVD lamp lights up on the unit.
- 2 Press **SET UP** to access the Main Menu screen.
- 3 Press $\triangleleft \triangleright$ to select "FUNCTION SET UP", then press **ENTER**.
- 4 Press $\triangleleft \triangleright$ to select "RECORDING SET", then press **ENTER**.
- 5 Press $\triangle \nabla$ to select "2ND AUDIO RECORD", then press **ENTER**.
- 6 Press $\triangle \nabla$ to select the desired option, then press **ENTER**.
- 7 Press **SET UP** to complete the setting.

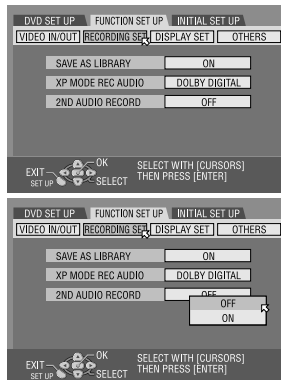

* The **boldface** settings below indicate the settings at your purchase.

AUDIO OUTPUT

DIGITAL AUDIO OUT — DOLBY DIGITAL/PCM / **STREAM/PCM** / PCM ONLY

Set to the appropriate mode according to the type of the device connected to DIGITAL AUDIO OUT connector.

DOLBY DIGITAL/PCM: Select this when you connect the digital input connector of a Dolby Digital decoder or an amplifier with a built-in Dolby Digital decoder.

STREAM/PCM: Select this when you connect the digital input connector of an amplifier with a built-in DTS, Dolby Digital, or MPEG multichannel decoder.

PCM ONLY: Select this when you connect the linear PCM digital input of other audio equipment (amplifier, MD or DAT deck, etc.).

ANALOG AUDIO OUT — **STEREO** / DOLBY SURROUND

Select the appropriate setting to accommodate the unit to the connected A/V equipment. This function takes effect when a DVD VIDEO disc is played back.

STEREO: Select this when listening to conventional two-channel stereo audio with the unit's AUDIO OUTPUT connectors connected to a stereo amplifier/receiver or TV set, or in case you want to record the audio from a DVD VIDEO disc to a Mini Disc, etc.

DOLBY SURROUND: Select this when listening to multichannel surround audio with the unit's AUDIO OUTPUT connectors connected to an amplifier/receiver with a built-in surround decoder or a surround decoder.

D. RANGE CONTROL — **NORMAL** / WIDE RANGE / TV MODE

The dynamic range (the difference between the loudest sound and the quietest one) can be compressed during playback of a program encoded in Dolby Digital format.

This function takes effect when a DVD VIDEO disc recorded in Dolby Digital format is played back at low or middle volume.

NORMAL: Normally select this setting to activate this function.

WIDE RANGE: Select this to deactivate this function when you enjoy wide dynamic range program.

TV MODE: Select this when you hear the sound through the TV's speaker(s).

NOTES:

- This function takes no effect on programs other than that recorded in Dolby Digital format.
- This function does not work when Simulated Surround Effect is activated. (pg. 35)
- The effect of "NORMAL" and "WIDE RANGE" may not be different depending on discs.

OUTPUT LEVEL — **STANDARD** / LOW

You can lower the output level of analog audio to accommodate the unit to the connected A/V equipment.

STANDARD: Normally select this setting.

LOW: The output level of analog audio is lowered.

VIDEO IN/OUT**■ MONITOR TYPE — 4:3LB / 4:3PS / 16:9 AUTO / 16:9 FIX**

You can select the monitor type depending on the TV used when you play back DVD VIDEO discs recorded for wide-screen TVs. For details, refer to "Monitor Set (DVD Deck Only)" (☞ pg. 24).

■ FRONT AUX F-1 — VIDEO / S-VIDEO

Select the appropriate mode depending on the connector (F-1) being used on the front panel.

VIDEO: To use the VIDEO input connector on the front panel.

S-VIDEO: To use the S-VIDEO input connector on the front panel.

■ REAR AUX L-1 — VIDEO / S-VIDEO

Select the appropriate mode depending on the connector (L-1) being used on the rear panel.

VIDEO: To use the VIDEO INPUT connector on the rear panel.

S-VIDEO: To use the S-VIDEO INPUT connector on the rear panel.

RECORDING SET**■ SAVE AS LIBRARY — OFF / ON**

When this function is set to "ON", the recording information is automatically stored in the library. For details, refer to "Modify Library Information" (☞ pg. 60).

■ XP MODE REC AUDIO — DOLBY DIGITAL / LINEAR PCM

You can select the audio format when you record a program in XP mode. When this function is set to "LINEAR PCM", you can obtain a high-quality audio sound.

DOLBY DIGITAL: To record in Dolby Digital format.

LINEAR PCM: To record in Linear PCM format.

■ 2ND AUDIO RECORD — OFF / ON

When this function is set to "ON";

If a SAP program is received, the SAP audio is recorded on L/R tracks. The main audio is not recorded.

If a non-SAP program is received, the main audio is recorded on L/R tracks.

When this function is set to "OFF", the SAP audio cannot be recorded.

NOTE:

When the channel is changed on the unit;

- The "MONO" indicator appears on the screen for about 5 seconds if the program is a monaural broadcast.
- The "STEREO" indicator appears on the screen for about 5 seconds if the program is a stereo broadcast.
- Both "STEREO" and "SAP" indicators appear when a stereo program is accompanied by SAP sound.
- Both "MONO" and "SAP" indicators appear when the main audio on the monaural broadcast is accompanied by SAP sound.

DISPLAY SET**■ SUPERIMPOSE — OFF / AUTO**

When this function is set to "AUTO", various operational indicators appear on the TV screen. Messages appear in the selected language. (☞ pg. 19)

OFF: To turn off superimposed indications.

AUTO: To superimpose operational indications for approximately five seconds just after the corresponding operation.

NOTES:

- Even when "SUPERIMPOSE" is set to "OFF", you can display the various operational indicators by pressing **ON SCREEN**. To clear the operational indicators, press **ON SCREEN** again.
- When you use this unit as the source player for editing, be sure to set "SUPERIMPOSE" to "OFF" before starting. (☞ pg. 74)
- When you select "AUTO", during playback, the operation mode indicators may be disturbed depending on the type of disc being used.

■ GRAY BACK — OFF / ON

When this function is set to "ON", the TV screen becomes all grey when receiving a channel not in use.

NOTE:

When you want to receive an unstable channel with poor signals, set this function to "OFF".

■ DIMMER — BRIGHT / DIM

You can change the brightness of the front display panel.

BRIGHT: Normally select this.

DIM: To dim the front display panel. (Blue lamp on the front display panel is turned off.)

■ POWER SAVE — OFF / ON

When this function is set to "ON", you can reduce the power consumption while the unit is turned off.

NOTES:

- During Power Save mode —
— the front display panel will be turned off.
- Power Save does not work when —
— the unit is in the Timer mode.
— the unit's power is turned off after timer-recording or Instant Timer Recording.
— the Automatic Satellite Program Recording mode is engaged. (☞ pg. 46)
- It takes some time for the unit to complete initialisation after you turn on unit power, with "WAKE UP" blinking on the front display panel.

■ ON SCREEN LANGUAGE

This unit offers you the choice to view on-screen messages in 3 different languages.

For details, refer to "On-screen Language Set" (☞ pg. 19).

OTHERS**■ RESUME — ON / OFF / DISC RESUME**

When this function is set to "ON" or "DISC RESUME", you can use the resume function. (☞ pg. 27)

ON: You can start playback from the resume point of the placed disc.

OFF: You cannot use the resume function.

DISC RESUME: The unit retains a memory of the resume points of the last 30 discs played back, even though they have been ejected.

NOTE:

"DISC RESUME" setting works on DVD VIDEO, VCD and already finalised DVD-R/DVD-RW (video mode) discs. For other types of discs, the function under "ON" setting will be applied even if "RESUME" is set to "DISC RESUME".

Mode Set (VCR Deck)

- Turn on the unit.
- Turn on the TV and select the video channel (or AV mode).
- Slide the **TV/CABLE/DBS/DVD** switch to **DVD**.

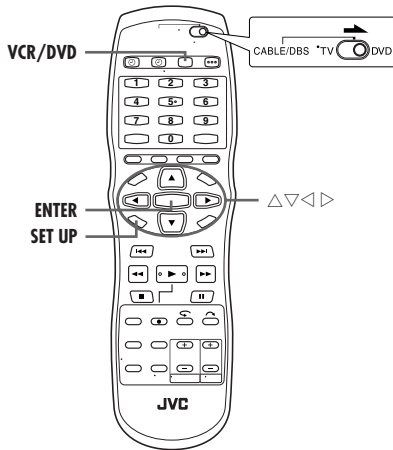

You can change various mode settings on the Function Set screen. To change the settings of these modes, find the desired mode in the menu (for details on each menu, see pages 75 through 76), then follow the procedure below.

- 1 Press **VCR/DVD** repeatedly so that the VCR lamp lights up on the unit.
- 2 Press **SET UP** to access the Function Set screen.
- 3 Press $\Delta \nabla$ to select the item you want to change, then press **ENTER** or \triangleright to select the desired mode.
- 4 Press **SET UP** to complete the setting.

| FUNCTION | NORM |
|------------------------|-------------|
| PICTURE CONTROL | NORM |
| SUPERIMPOSE | AUTO |
| AUTO SP→EP TIMER | OFF |
| VIDEO STABILIZER | OFF |
| BLUE BACK | ON |
| 2ND AUDIO RECORD | OFF |

($\Delta \nabla$) THEN (ENTER)
(SET UP) TO END

* The **boldface** settings below indicate the settings at your purchase.

PICTURE CONTROL — **NORM** / EDIT / SOFT / SHARP

This feature helps you to adjust the playback picture quality according to your preference. Normally select "**NORM**".

NORM: Picture quality is adjusted automatically.

EDIT: Minimizes picture degradation during editing (recording and playback).

SOFT: Reduces image coarseness when viewing overlaid tapes containing a lot of noise.

SHARP: Clearer, sharper-edged picture when viewing images with lots of flat, same-colored surfaces such as cartoons.

NOTES:

- When you select "EDIT", "SOFT" or "SHARP", the selected mode will not change until you select another mode.
- When you select "EDIT" to dub tapes, be sure to select "NORM" after you finish dubbing the tapes.

SUPERIMPOSE — **AUTO** / OFF

When this function is set to "AUTO", various operational indicators appear on the TV screen. Messages appear in the selected language. (ⓘ pg. 19)

NOTES:

- Even when "SUPERIMPOSE" is set to "OFF", you can display the various operational indicators by pressing **ON SCREEN**. To clear the operational indicators, press **ON SCREEN** again.
- When you use this unit as the source player for editing, be sure to set "SUPERIMPOSE" to "OFF" before starting.
- During playback, the operation mode indicators may be disturbed depending on the type of tape being used.

AUTO SP→EP TIMER — **ON** / OFF

When this function is set to "ON", the unit automatically switches to EP mode to allow complete recording if there is not enough tape to record the entire program while timer-recording in SP mode.

For Example:

Recording a program of 140 minutes in length onto a 120-minute tape

| | |
|---------------------------|--------------------------|
| Approximately 110 minutes | Approximately 30 minutes |
| SP mode | EP mode |
| Total 140 minutes | |

Make sure you set this function to "ON", before the timer-recording starts.

NOTES:

- If you have programed the unit to timer-record 2 or more programs, the second program and those thereafter may not fit on the tape if you set "AUTO SP→EP TIMER" to "ON". In this case, make sure the mode is not engaged, then set the tape speed manually during timer programing.
- In order to ensure that the recording fits on the tape, this feature may leave a slight non-recorded section at the end of the tape.
- There may be some noise and sound disturbance at the point on the tape where the unit switches from SP to EP mode.
- The Auto SP→EP Timer feature is not available during ITR (Instant Timer Recording), and the feature will not work properly on the following tapes: T(ST)-30, T(ST)-60, T(ST)-90, and T(ST)-120

■ VIDEO STABILIZER — ON / OFF

When this function is set to "ON", you can automatically correct vertical vibration in the picture when playing back unstable recordings made on another recorder.

NOTES:

- When you finish viewing a tape, be sure to set this function to "OFF".
- Regardless of the setting, this function has no effect during recording and during special effects playback.
- The on-screen display may jitter vertically when this function is set to "ON".
- To watch recordings with close-caption, set this function to "OFF".

■ BLUE BACK — ON / OFF

When this function is set to "ON", the TV screen becomes all blue when receiving a channel not in use.

NOTE:

When you want to receive an unstable channel with poor signals, set this function to "OFF".

■ 2ND AUDIO RECORD — ON / OFF

When this function is set to "ON";

If a SAP program is received, the SAP audio is recorded on L/R tracks. The main audio is not recorded.

If a non-SAP program is received, the main audio is recorded on L/R tracks.

When this function is set to "OFF", the SAP audio cannot be recorded.

NOTE:

When the channel is changed on the unit;

- The "STEREO" indicator appears on the screen for about 5 seconds if the program is a stereo broadcast.
- Both "STEREO" and "SAP" indicators appear when a stereo program is accompanied by SAP sound.

Changing VCR Plus+® Setting

The VCR Plus+ programming system assigns a VCR Plus+ guide channel to the TV channels and the cable channels. These guide channel numbers are also called the VCR Plus+ channel codes. Most TV listings have a section, usually a chart, indicating the guide channel numbers assigned to each station.

To ensure that VCR Plus+ timer recording operates correctly, it is necessary to set the VCR Plus+ "Guide Channel Set" for each station.

If you have moved to a different area or if a broadcasting station's channel number has been changed, perform the following steps to set the correct guide channel number.

NOTES:

- In many instances, the VCR Plus+ guide channel numbers for cable and broadcast TV stations DO NOT match the channel number on which it is received by your unit or cable box. Check your TV listing, or contact your cable supplier for details.
- Many TV stations can be viewed on cable. Check your TV listing, or contact your cable supplier for details.

- Turn on the unit.
- Turn on the TV and select the video channel (or AV mode).
- Slide the TV/CABLE/DBS/DVD switch to DVD.

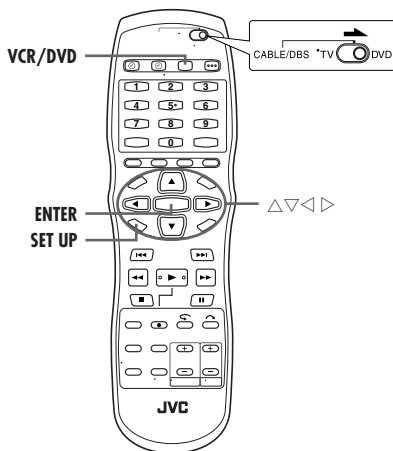

Guide Channel Number Set

1 Press **VCR/DVD** repeatedly so that the DVD lamp lights up on the unit.

2 Press **SET UP** to access the Main Menu screen.

3 Press $\triangleleft \triangleright$ to select "INITIAL SET UP", then press **ENTER**.

4 Press $\triangleleft \triangleright$ to select "TUNER SET", then press **ENTER**.

5 Press $\triangle \nabla$ to select "GUIDE CHANNEL SET", then press **ENTER**.

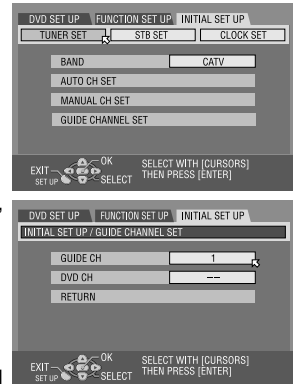

6 Press $\triangle \nabla$ to select "GUIDE CH", then press **ENTER**.

7 Press $\triangle \nabla$ to select the Guide Channel number for the desired station as shown in the TV listings. Then press **ENTER**.

- To change the Guide Channel number in 10 increments, press and hold $\triangle \nabla$.

- If you receive your channels with a cable box and if you have properly set your Controller, "CATV CH" appears in place of "DVD CH". If not, perform "Cable Box and/or DBS Receiver Control Setting (DVD Deck Only)" (pg. 22).

8 Press $\triangle \nabla$ to select "DVD CH", then press **ENTER**. Press $\triangle \nabla$ to select the number of the unit's channel position on which the Guide Channel number's broadcast is received by the unit or the DBS receiver. Then press **ENTER**.

- To timer-record a satellite program with the VCR Plus+ system, you need to install the Controller and perform the procedure described in "Cable Box and/or DBS Receiver Control Setting (DVD Deck Only)" (pg. 22).

- Repeat steps **6** and **8** as necessary.

9 Press **SET UP** to complete the setting.

Guide Channel Number

"Guide Channel (GUIDE CH) number" refers to the assigned TV station numbers, according to broadcast area, for the VCR Plus+ timer recording. The Guide Channel numbers can be found in most TV listings.

Format A Disc (DVD Deck Only)



Some DVD-RAM/RW discs are unformatted. Format the disc when you use an unformatted disc or you want to delete all recordings and data on the disc.

ATTENTION:

- When a disc is formatted, all recordings and data are erased. It is impossible to restore them.
- Never turn off the unit or disconnect the mains power cord while "NOW FORMATTING..." is displayed on the TV screen.

- Turn on the unit.
- Turn on the TV and select the video channel (or AV mode).
- Slide the **TV/CABLE/DBS/DVD** switch to **DVD**.
- Load a DVD-RAM/RW disc to format.

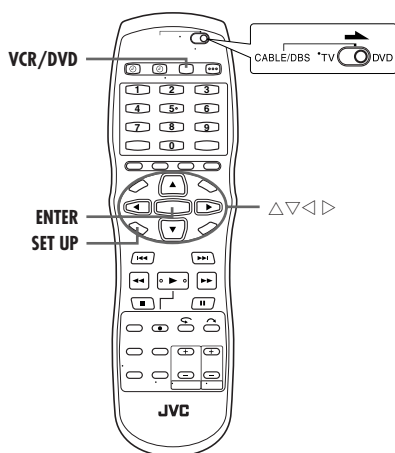

Format A DVD-RAM Disc

- 1 Press **VCR/DVD** repeatedly so that the DVD lamp lights up on the unit.
- 2 Press **SET UP** to access the Main Menu screen.
- 3 Press $\Delta \nabla \triangleleft \triangleright$ to select "DVD SET UP", then press **ENTER**.
- 4 Press $\triangleleft \triangleright$ to select "UTILITY", then press **ENTER**.
- 5 Press $\Delta \nabla$ to select "FORMAT", then press **ENTER**. Press $\triangleleft \triangleright$ to select "YES", then press **ENTER** when "DISC WILL BE FORMATTED" appears on the TV screen.
- 6 Press $\triangleleft \triangleright$ to select "OK", then press **ENTER** when "DISC FORMATTING WAS SELECTED" appears on the TV screen.

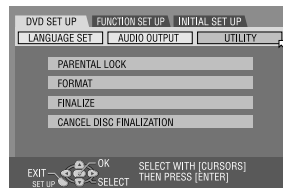

Format A DVD-RW Disc

- 1 Perform steps 2 to 4 of "Format A DVD-RAM Disc" on the above before continuing.
- 2 Press $\Delta \nabla$ to select "FORMAT", then press **ENTER**. Press $\triangleleft \triangleright$ to choose "VR MODE" or "VIDEO MODE", then press **ENTER** when "DISC WILL BE FORMATTED" appears on the TV screen.
 - "VR MODE": To be chosen when you want to record, erase, or edit data on the disc repeatedly.
 - "VIDEO MODE": To be chosen when you want to erase all the data on the disc once played back to record new data, or play back the disc on other DVD players.
- 3 Press $\triangleleft \triangleright$ to select "YES", then press **ENTER** when "DISC WILL BE FORMATTED IN VR MODE/VIDEO MODE" appears on the TV screen.

NOTES:

- It is impossible to format Version 1.0 DVD-RW discs in Video mode.
- It is impossible to format DVD-R discs.
- All the programs on a disc will be deleted once the disc is formatted even if they are protected titles. (pg. 57)

Finalize A Disc (DVD Deck Only)



Finalizing DVD-R/RW discs recorded on this unit makes it possible for the discs to be played back on other DVD players. DVD-RW discs are finalized in the mode that the discs were formatted, enabling playback on compatible DVD players.

Titles input in the Library Database DVD Navi are registered as titles in the DVD menu. (☞ pg. 57)

- Turn on the unit.
- Turn on the TV and select the video channel (or AV mode).
- Slide the **TV/CABLE/DBS/DVD** switch to **DVD**.
- Load a DVD-R/RW disc to finalize.

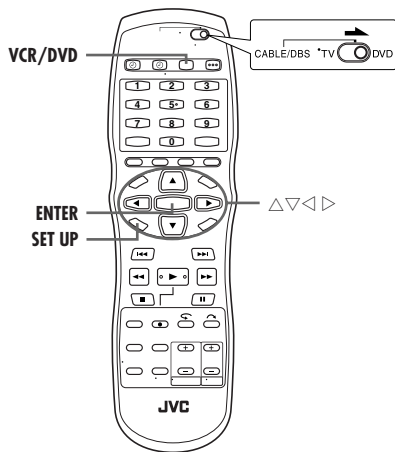

Before finalizing

- It is possible to record on a blank space.
- It is possible to enter a program title. (☞ pg. 57)
- It is possible to delete programs. (☞ pg. 57)
- It is impossible to overwrite recorded areas of DVD-R discs.
- Available recording capacity does not increase even if a recorded program is deleted from a DVD-R disc.
- It is impossible to record or edit DVD-R/RW discs recorded on other devices even if they have not been finalized.

After finalizing (For DVD-R/RW (Video mode) discs)

- Video and audio that have been recorded by then are recorded in conformity to the DVD Video standard, enabling you to play back the discs as DVD VIDEO discs.
- Although DVD-R/RW discs finalized on this unit become playable on DVD players compatible with DVD-R/RW discs, some discs still may not play, for which JVC cannot take responsibility.
- Marked points marked before finalizing will be deleted, and programs will be divided automatically into "chapters" approximately every 5 minutes. (☞ pg. 27)
- Depending on the DVD players and DVD-R/RW discs used, and on the conditions of recording, it may not be possible to play back the discs. In this case, play back the discs on this unit.
- Additional recordings become impossible.

Finalize A DVD-R/RW Disc

- 1** Perform steps **2** to **4** of "Format A DVD-RAM Disc" (☞ pg. 78) before continuing.
- 2** Press $\Delta \nabla$ to select "FINALIZE", then press **ENTER**. Press $\triangleleft \triangleright$ to select "YES", then press **ENTER** when "DISC WILL BE FINALIZED" appears on the TV screen.
- 3** Press $\triangleleft \triangleright$ to select "OK", then press **ENTER** when "FINALIZING WILL MAKE DISC READ-ONLY" appears on the TV screen.
- 4** Press **SET UP** to return to the normal screen.
 - Menu screen is cleared.
 - Once a DVD-R/RW (Video mode) disc has been finalized, the displays for original and play list do not appear. Only display for library appears.
 - Once a DVD-RW (VR mode) disc has been finalized, it can be played on DVD players compatible with VR mode.

Cancel The Finalization Of A DVD-RW Disc

- 1** Load a DVD-RW disc to cancel the disc finalization, and perform steps **2** to **4** of "Format A DVD-RAM Disc" (☞ pg. 78) before continuing.
- 2** Press $\Delta \nabla$ to select "CANCEL DISC FINALIZATION", then press **ENTER**.
- 3** Press $\triangleleft \triangleright$ to select "OK", then press **ENTER** when "CANCEL DISC FINALIZATION" appears on the TV screen.
- 4** Press **SET UP** to return to the normal screen.
 - When the disc finalization is cancelled, the mode in which the disc was formatted is restored, making the disc recordable. (☞ pg. 9, 78)

Scan Mode Set

If you connect the unit and TV with Component Video Connection (pg. 17), you can select the scan mode from two modes: Interlaced scan mode which is used in the conventional TV system, and Progressive scan mode which enables reproduction of higher-quality images. For details, refer to "GLOSSARY" (pg. 86).

ATTENTION:

Your TV needs to be compatible with Progressive.

- Turn on the unit.
- Turn on the TV and select the video channel (or AV mode).
- Slide the **TV/CABLE/DBS/DVD** switch to **DVD**.

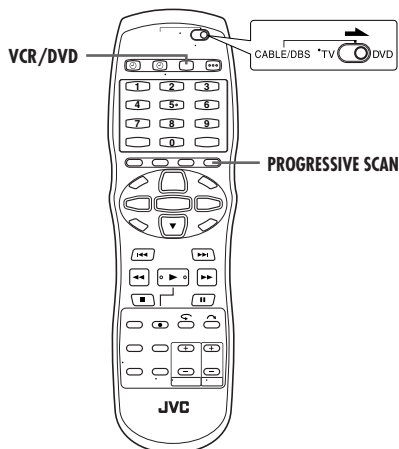

1 Press **VCR/DVD** repeatedly so that the DVD lamp lights up on the unit.

2 Press **PROGRESSIVE SCAN** for 3 or more seconds.

- Video output indicator (P) lights on the front display panel if Progressive scan mode has been established. (pg. 14)
- Each press of **PROGRESSIVE SCAN** for 3 or more seconds switches the scan mode.

NOTES:

- When the Progressive scan mode is engaged, no video signal is output from AUDIO/VIDEO and S-VIDEO OUTPUT connectors.
- Interlaced scan mode is the setting at your purchase.
- Interlaced scan mode might be suitable depending on video material.
- Scan mode cannot be set while menu screen is displayed.

Watch the image on VCR deck in the Progressive scan mode via component video

ATTENTION:

- Your TV needs to be compatible with Progressive and to have Component video input connectors.
- If a DVD-VIDEO, or an already finalized DVD-R/DVD-RW (VIDEO) disc is loaded, press ■ twice to release the resume function.

- 1 Set the Progressive-compatible TV to the component input mode.
- 2 Press **VCR/DVD** repeatedly so that the DVD lamp lights up on the unit, then press **PROGRESSIVE SCAN** for 3 or more seconds so that the Video output indicator (P) lights on the front display panel.
- 3 Press **VCR/DVD** repeatedly so that the VCR lamp lights up on the unit.
- 4 Press **VCR→**.
 - "VCR→" lights up on the unit.

NOTES:

- Be sure to engage the DVD deck in stop mode.
- It is not possible to perform the above steps when the DVD deck is in timer standby mode.

Tray Lock (DVD Deck Only)

You can lock the disc tray to prohibit the unwanted disc ejection by children.

- Turn off the unit.

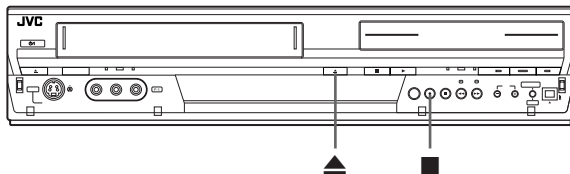

To lock tray

While the unit is turned off, press and hold ■, then press ▲ (**OPEN/CLOSE**) on the unit. "LOCKED" appears on the front display panel and the disc tray is locked.

To unlock tray

While the unit is turned off, press and hold ■, then press ▲ (**OPEN/CLOSE**) on the unit. "UNLOCK" appears on the front display panel.

Before requesting service for a problem, use this chart and see if you can solve the trouble yourself. Small problems are often easily solved, and this can save you the trouble of sending your unit off for repair.

General

No power is supplied to the unit.

- The AC power plug is disconnected from the AC outlet.
- Connect the AC power plug to the AC outlet securely. (☞ pg. 17)

The remote control does not work properly.

- Remove the batteries, wait for 5 minutes or more, then load the batteries again.
- The setting of the remote control code is inappropriate.
- Set the same remote control code (1, 2, 3, or 4) on both the unit and the remote control. (☞ pg. 70)
- The batteries are discharged.
- Replace the dead batteries with new ones.

Dubbing from the external equipment is not possible.

- The source (another video recorder, camcorder) has not been properly connected.
- Confirm that the source is properly connected.
- All necessary power switches have not been turned on.
- Confirm that all units' power switches are turned on.
- The setting of the input channel position is inappropriate.
- Select the input channel position ("F-1" or "L-1") that corresponds to the input terminal connected to the external equipment. (☞ pg. 68)
- The record safety tab has been removed when dubbing to the cassette.
- Using adhesive tape, cover the hole where the tab was removed.

The on-screen display superimposed on the program played back/received on this unit is recorded when you dub the program to an external recording equipment.

- Set "SUPERIMPOSE" to "OFF". (☞ pg. 74, 75)

The unit does not operate.

- There are cases when the operation is prohibited on the disc.
- Lightning or static electricity may cause malfunction of the unit.
- Press ψ /I to turn the power off, then press the button again to turn the power on.

Playback (DVD Deck)

The DVD deck can not be operated.

- The DVD deck is not selected.
- Press **VCR/DVD** repeatedly so that the DVD lamp lights up on the unit.

Images do not appear on the TV screen.

- The TV receiver's channel selector is not set to the video channel or AV mode.
- If you are using the RF connection, set the TV receiver to the video channel.
- If you are using the AV, S-VIDEO or Component Video connection, set the TV to its AV mode.
- The unit's video channel has not been correctly set.
- Perform the video channel set. (☞ pg. 17)
- When interlace scanned program is played back, progressive scan mode is selected.
- Press and hold **PROGRESSIVE SCAN** until **P** disappears from the front display panel.

Playback does not start or stop immediately after playback is started by pressing \blacktriangleright . On the front display panel, "NO DISC" appears.

- The disc is loaded upside down.
- Place the disc on the disc tray with the playback surface facing downward. (☞ pg. 11)
- A disc not being compatible with the unit is loaded.
- Load a playable disc on the unit. (☞ pg. 8)
- A dirty disc is loaded.
- Clean the disc. (☞ pg. 11)
- Defective disc is loaded.
- Replace the warped or scratched disc with a normal one.

Images are blurred or distorted when you start High-Speed Search.

- Images are blurred or distorted at the point where the playback speed changes and this is not a malfunction of the unit.

Playback does not start.

- Playback does not start for approximately 30 seconds after recording is stopped and this is not a malfunction of the unit.

Playback does not start when you select a title or a chapter.

- The Parental Lock is engaged and the disc is rated higher than the set level.
- Release the Parental Lock temporarily or change the set level. (☞ pg. 37)

Playback (VCR Deck)

The VCR deck can not be operated.

- The VCR deck is not selected.
- Press **VCR/DVD** repeatedly so that the VCR lamp lights up on the unit.

The tape will not rewind or fast-forward.

- The tape is already fully rewound or fast-forwarded.
- Check the cassette.

The playback picture does not appear while the tape is running.

- The TV receiver's channel selector is not set to the video channel.
- If you are using the RF connection, set the TV receiver to the video channel.
- If you are using the AV connection, the TV receiver is not set to the AV mode.
- The unit's video channel has not been correctly set.
- Perform the video channel set. (☞ pg. 17)

Noise appears during visual search.

- This is normal.

Noise appears during normal playback.

- The automatic tracking mode is engaged.
- Try manual tracking. (☞ pg. 49)

The playback picture is blurred or interrupted while TV broadcasts are clear or "USE CLEANING CASSETTE" message appears on the screen.

- The video heads may be dirty.
- Use a dry cleaning cassette ECL-3F, or consult your JVC dealer.

Breaks are noticeable in Hi-Fi soundtrack.

- The automatic tracking mode is engaged.
- Try manual tracking. (☞ pg. 49)

Recording (DVD Deck)

The desired program cannot be recorded.

- The channel position does not correspond to that in the receiving area.
- Set the correct channel position for the receiving broadcast. (☞ pg. 21)

Recording cannot be made.

- No disc or a disc not being compatible with the unit is loaded.
- Load a recordable disc on the unit. (☞ pg. 8)
- The disc loaded is not formatted.
- Format the disc. (☞ pg. 78)
- A finalized DVD-R disc is loaded.
- Recording cannot be made on finalized discs. Load a recordable disc on the unit.
- The disc is full or does not have enough space for the program to be recorded.
- Clear unnecessary programs on the disc or load a blank disc. (☞ pg. 57)

Recording (VCR Deck)

During recording, the tape does not run. The VCR recording lamp lights up on the front display panel.

- The unit is in the Record Pause mode.
- Press **▶** to resume recording.

Recording cannot be made.

- There is no cassette loaded, or the cassette loaded has had its record safety tab removed.
- Insert a cassette, or using adhesive tape, cover the hole where the tab was removed.

TV broadcasts cannot be recorded.

- "L-1" or "F-1" has been selected as the input mode.
- Set to the desired channel.

Camcorder recording is not possible.

- The camcorder has not been properly connected.
- Confirm that the camcorder is properly connected.
- The input mode is not correct.
- Set the input mode to "F-1".

The tape is automatically rewound, then the unit is shut off.

- The end of the tape was reached during recording.
- The program may not have been recorded in its entirety. Next time make sure you have enough time on the tape to record the entire program.

Timer Recording (DVD Deck)

Timer programing cannot be made.

- Date and time is not correct.
→Set date and time correctly. (☞ pg. 20)
- The timer is not engaged.
→Press **DVD TIMER** (⊖) and confirm that the DVD timer lamp lights up on the unit.
- Timer recording is in progress.
→Timer programing can't be performed while a timer recording is in progress. Wait until it finishes.

Timer programing recording does not start.

- Date and time is not correct.
→Set date and time correctly. (☞ pg. 20)
- The timer is not engaged.
→Press **DVD TIMER** (⊖) and confirm that the DVD timer lamp lights up on the unit.
- There is a power outage while the DVD deck is in the timer standby mode.
→The unit does not enter timer standby mode automatically when the power is restored to the unit. Engage the timer standby mode again.

VCR Plus+ Timer Programing cannot be made.

- Date and time set on the unit is not correct.
→Set date and time correctly. (☞ pg. 20)
- The channel position does not correspond to that in the receiving area.
→Set the correct channel position for the receiving broadcast. (☞ pg. 21)

Automatic Satellite Program Recording recording does not start.

- The DBS receiver is not connected properly to this unit.
→Connect the DBS receiver to the AUDIO/VIDEO INPUT (L-1) connector properly. (☞ pg. 46)

On the front display panel, “- -: -” appears.

- Power failure occurred.
→Set date and time correctly. (☞ pg. 20)

“PROGRAM FULL” appears on the TV screen during timer programing.

- Eight programs have already been timer programmed.
→Clear unnecessary programs on the unit, then try timer programing again. (☞ pg. 45)

The disc space does not increase when recorded programs are cleared.

- The PC's data recorded on a DVD-RAM drive cannot be cleared on this unit.
→Format the disc. (When the disc is soiled, wipe the disc with a soft dry cloth before formatting.) (☞ pg. 11, 78)

Timer Recording (VCR Deck)

Timer programing cannot be made.

- Date and time is not correct.
→Set date and time correctly. (☞ pg. 20)
- The timer is not engaged.
→Press **VCR TIMER** (⊖) and confirm that the VCR timer lamp lights up on the unit.
- Timer recording is in progress.
→Timer programing can't be performed while a timer recording is in progress. Wait until it finishes.

Timer programing recording does not start.

- Date and time is not correct.
→Set date and time correctly. (☞ pg. 20)
- The timer is not engaged.
→Press **VCR TIMER** (⊖) and confirm that the VCR timer lamp lights up on the unit.

The VCR Timer lamp on the unit won't stop blinking.

- The timer is engaged but there's no cassette loaded.
→Load a cassette with the record safety tab intact.
- The loaded cassette has had its record safety tab removed.
→Remove the cassette and cover the hole with adhesive tape, or insert a cassette with the record safety tab intact.

The tape is automatically ejected, then the unit is shut off.

- The end of the tape was reached during timer recording.
→The program may not have been recorded in its entirety. Next time make sure you have enough time on the tape to record the entire program.
- The end of the tape was reached during Instant Timer Recording.
→The program may not have been recorded in its entirety. Next time make sure you have enough time on the tape to record the entire program.

VCR Plus+ Timer Programing cannot be made.

- Date and time set on the unit is not correct.
→Set date and time correctly. (☞ pg. 20)
- The channel position does not correspond to that in the receiving area.
→Set the correct channel position for the receiving broadcast. (☞ pg. 21)

The VCR Plus+ system does not timer-record properly.

- The unit's channel positions have been set incorrectly.
→Refer to “Changing VCR Plus+ Setting” (☞ pg. 77) and re-perform the procedure.

Initializing (DVD Deck Only)

Malfunction occurs on the unit.

→ Press $\phi/1$ to turn off the unit, press and hold $\phi/1$, then press \blacksquare for two seconds or more.

Other Problems

The image of the TV broadcast appears distorted on the TV screen.

For RF/AV/S-VIDEO connection

→ Press **PROGRESSIVE SCAN** for 3 or more seconds so that the Video output indicator (P) lights off on the front display panel.

For component video connection

→ Press **PROGRESSIVE SCAN** for 3 or more seconds so that the Video output indicator (P) lights up on the front display panel.

Whistling or howling is heard from the TV during camcorder recording.

- The camcorder's microphone is too close to the TV.
→ Position the camcorder so its microphone is away from the TV.
- The TV's volume is too high.
→ Turn the TV's volume down.

When scanning channels, some of them are skipped over.

- Those channels have been designated to be skipped.
→ If you need the skipped channels, restore them. (☞ pg. 21)

The channel cannot be changed.

- Recording or Live Memory recording* is in progress.
→ Press \blacksquare to pause the recording, change channels, then press \blacktriangleright to resume recording.

* DVD deck only

Channel settings that were made manually seem to have changed or disappeared.

- After the manual settings were made, Auto Channel Set was performed.
→ Perform "Manual Clock Set" (☞ pg. 20).

Even though Auto or Semiauto Clock Set has been performed, the clock is incorrect.

- The clock setting data received from the host channel is incorrect.
→ Select a different host channel during "Semiauto Clock Set" (☞ pg. 20), or perform "Manual Clock Set" (☞ pg. 20).

On-screen Message (DVD Deck Only)

MEMORY IS FULL NOTHING MORE CAN BE REGISTERED IN THE LIBRARY IF YOU DELETE UNNECESSARY TITLE INFORMATION, YOU CAN THEN REGISTER ADDITIONAL INFORMATION

- The memory is full for registration for the Navigation system. The recording cannot be started even though the capacity for the recording is enough. (☞ pg. 60)

AVAILABLE MEMORY IS LOW SOON YOU WILL NO LONGER BE ABLE TO REGISTER INFORMATION IN THE LIBRARY IF YOU DELETE UNNECESSARY TITLE INFORMATION, YOU CAN THEN REGISTER ADDITIONAL INFORMATION

- The remaining capacity of the memory is not enough for registration for the Navigation system. The recording cannot be started even though the capacity for the recording is enough. (☞ pg. 60)

DISC NOT REGISTERED IN THE LIBRARY REGISTER DISC?

- A disc that is not registered in the library has been inserted.
Register the disc as necessary. (☞ pg. 60)

INSERT DISC #XXXX

- Appears when a title that has been selected in the library is not contained in the loaded disc.

CAN NOT RECORD OR MAKE PLAY LIST DELETE UNWANTED TITLES

- Recording and/or editing cannot be performed with a loaded DVD-RAM disc.
- The number of titles exceeds 99.
- The number of play lists exceeds 999.

SET CLOCK BEFORE TIMER PROGRAMING

- To set the timer program, the clock must be set in advance. (☞ pg. 20)

PROGRAM FULL DELETE UNWANTED TIMER PROGRAM

- You can program this unit to timer-record as many as 8 programs. To program more, you need to cancel a timer program already set. (☞ pg. 45)

CAN NOT SET DISC TIMER PROGRAMING WITH THIS DISC PREPARE A FORMATTED DISC AS DESCRIBED BELOW DVD-RAM DVD-RW (VR MODE)

- On-Disc Timer Programing has been attempted when a disc that is not compatible with the function is loaded. (☞ pg. 43)

NO DISC INSERTED

- On-Disc Timer Programing has been attempted when a disc is not loaded, or loaded upside down. (☞ pg. 11, 43)

DISC NOT RECORDABLE INSERT RECORDABLE DISC

- When a playback-only disc or a finalized disc is loaded, \bullet has been pressed. (☞ pg. 8)

**PLUSCODE NO. ERROR
CONFIRM PLUSCODE NO. THEN RETRY**

- An invalid VCR Plus+ number has been input. (☞ pg. 41)

**GUIDE PROGRAM IS NOT SET
SELECT CHANNEL YOU WANT TO RECORD**

- To set the timer program using the VCR Plus+ system, the Guide Channel number must be set in advance. (☞ pg. 77)

**CAN NOT SET VCR PLUS TIMER PROGRAMING DURING TIMER
RECORDING OR INSTANT TIMER RECORDING
CANCEL TIMER RECORDING OR
INSTANT TIMER RECORDING, THEN
ENTER THE PLUSCODE AGAIN**

- Appears when you tried to input a PlusCode number during timer recording or instant timer recording.

**REGION CODE ERROR
CHECK DISC**

- A disc loaded cannot be played back on this unit since the region number of the disc does not match that of the unit. (☞ pg. 9)

**UNREADABLE DISC
CHECK DISC**

- When an incompatible disc is loaded, ► has been pressed. (☞ pg. 9)

**COULD NOT FORMAT THE DISC
CHECK THE DISC**

- Formatting is not complete since the disc may be dirty or damaged. Take out the disc, clean it and retry. (☞ pg. 11, 78)

**COULD NOT FINALIZE THE DISC
CHECK THE DISC**

- Finalizing is not complete since the disc may be dirty or damaged. Take out the disc, clean it and retry. (☞ pg. 11, 79)

**COULD NOT CANCEL DISC FINALIZATION
CHECK THE DISC**

- Cancelling disc finalization is not complete since the disc may be dirty or damaged. Take out the disc, clean it and retry. (☞ pg. 11, 79)

PRESS [STOP] AGAIN TO STOP RECORDING

- During Live Memory playback, ■ has been pressed. (☞ pg. 32)

TIMER RECORDING COMPLETED

- Timer recording has finished during Live Memory playback.

**PLAYBACK WILL STOP
THEN TIMER RECORDING WILL START**

- Timer recording finished during Live Memory playback, then the next timer recording is about to begin while playback continues.

**COPY PROHIBITED
CAN NOT RECORD**

- An attempt has been made to record copy-protected contents.
- An attempt has been made to record copy-once contents on a disc that is not CPRM compatible, such as DVD-R.

**COPY PROHIBITED
CAN NOT PLAY**

- The unit has detected invalid contents at the start or in the middle of playback.

**THE i.LINK DEVICE THAT YOU HAVE CONNECTED IS NOT
RECOGNIZED
MAKE SURE THAT THE DEVICE IS CONNECTED PROPERLY AND
POWERED ON**

- An attempt has been made to start DV dubbing when a digital video camera is not properly connected to the unit.
- Check the connection. (☞ pg. 66)

■ Aspect ratio

The ratio of vertical and horizontal sizes of a displayed image. The horizontal vs. vertical ratio of conventional TVs is 4:3, and that of wide-screens is 16:9.

■ Chapter

Refers to individual chapters included in a title.

■ Composite video signal

Refers to video signal comprised of three kinds of signals combined: an image signal made up of luminance and chrominance signals using the frequency multiplication technique; burst signal providing the basis for color reproduction; and synchronization signal.

■ Component video signal

A video signal system where parts of information necessary for reproducing image signal comprised of the three primary colors of light are transmitted via separate signal lines. Types of signal, such as R/G/B, Y/Pb/Pr, etc., are available.

■ Disc menu

A screen display prepared for allowing selection of images, sounds, subtitles, multiangles, etc. recorded on a DVD disc.

■ Dolby Digital (AC-3)

A six-channel system consisting of left, centre, right, left rear, right rear and LFE (Low-Frequency Effect channel, for use with a sub-woofer) channels. All processing is done in the digital domain. Not all Dolby Digital discs contain six (5.1) channels of information.

■ Down-mix

Internal stereo mix of multichannel surround audio by a DVD player. The down-mix signals are output from stereo output connectors.

■ DTS

A Digital Surround audio encoding format configured with six (5.1) channels, similar to Dolby Digital. It requires a decoder, either in the player or in an external receiver. DTS stands for Digital Theater Systems.

Not all DTS discs contain six (5.1) channels of information.

■ Interlaced scan

In the conventional video system, a picture is shown on the display monitor in two halves. The Interlaced scan system places lines of the second half of the picture in-between lines of the first half of the picture.

■ JPEG

A still-picture data compression system proposed by the Joint Photographic Expert Group, which features small decrease in image quality in spite of its high compression ratio.

■ Letter box

A method of displaying wide images like movies in the centre of a 4:3 TV screen with no part of the image deleted, by placing black bands on the top and bottom of the screen. This name has resulted from the screen form looking literally like a letter box.

■ Linear PCM (PCM: Pulse Code Modulation)

A system for converting analog sound signal to digital signal for later processing, with no data compression used in conversion.

■ MP3

A file format with a sound data compression system. "MP3" is the abbreviation of Motion Picture Experts Group 1 (or MPEG-1) Audio Layer 3. By using MP3 format, one CD-R/RW can contain about 10 times as much data volume as a regular CD can.

■ MPEG

A family of Standards for compressing audio-visual information. "MPEG" standards include MPEG-1, MPEG-2 and MPEG-4. Video CD and MP3 are based on MPEG-1, while DVD is based on MPEG-2. MPEG stands for Moving Picture coding Experts Group.

■ Multiangle

By recording multiple scenes progressing at the same time in a single title, the user can select view angles. This feature is called the multiangle function.

■ Multichannel

DVD is specified to have each sound track constitute one sound field. Multichannel refers to a structure of sound tracks having three or more channels.

■ Multilanguage

When a title is created to cope with multiple languages, it is generally called a multilanguage title.

■ NTSC (National television system committee)

A black and white and color television system format used in the U.S.A., Canada, Mexico and Japan.

■ PAL (Phase Alternation by Line)

A color television system format used extensively in Western Europe.

■ Parental Lock

A feature of this system to automatically determine whether or not to reproduce particular DVD software by comparing its parental lock level (a measure of undesirability of scenes, etc. from educational viewpoint) set for the software beforehand with that set on this system by the user; if the software's level is less restrictive than the user-set level, it will be reproduced.

■ Playback control (PBC)

Refers to the signal recorded on Video CDs for controlling reproduction. By using menu screens recorded on a Video CD that supports PBC, you can enjoy interactive-type software as well as software having a search function.

■ Progressive scan

Progressive scan displays all the horizontal lines of a picture at one time, as a single frame. This system can convert the interlaced video from DVD into progressive format for connection to a progressive display. It dramatically increases the vertical resolution.

■ Region Code

A system for allowing discs to be played back only in the regions designated beforehand. All the countries in the world are grouped into six regions, each region being identified by a specified Region Code (or region number). If the Region Code given to a disc includes a numeral which matches one in the Region Code of a player, the player can play back the disc.

■ Sampling frequency

Frequency of sampling data when analog data is converted to digital data. Sampling frequency numerically represents how many times the original analog signal is sampled per second.

■ Surround

A system for creating three-dimensional sound fields full of realism by arranging multiple speakers around the listener.

■ Transfer rate

The rate of transferring digital data. Usually the measure is in baud per second. The DVD system applies a variable transfer rate system for high efficiency.

GENERAL**Power requirement**

AC 120 V~, 60 Hz

Power consumption

Power on: 43 W

Power off: 16.5 W

Temperature

Operating: 5°C to 35°C (41°F to 95°F)

Storage: -20°C to 60°C (-4°F to 140°F)

Operating position

Horizontal only

Dimensions (WxHxD)

435 mm x 96 mm x 347 mm (17-3/16" x 3-13/16" x 13-11/16")

Weight

6.1 kg (13.5 lbs)

VIDEO/AUDIO (DVD Deck)**Recording format**

DVD-RAM: DVD Video Recording format

DVD-R: DVD-Video format

DVD-RW: DVD-Video format, DVD Video Recording format

Recording time

Maximum 8 hours (with 4.7 GB disc)

(XP): Approx. 1 hour

(SP): Approx. 2 hours

(LP): Approx. 4 hours

(EP): Approx. 6 hours

(FR): Approx. 1 hour – 8 hours

Audio recording system

Dolby Digital (2 ch)

Linear PCM (XP mode only)

Video recording compression system

MPEG2 (CBR/VBR)

Input/Output

S-video input:

Y: 0.8 – 1.2 Vp-p, 75 ohms

C: 0.2 – 0.4 Vp-p, 75 ohms

S-video output:

Y: 1.0 Vp-p, 75 ohms

C: 0.3 Vp-p, 75 ohms

Video input: 0.5 – 2.0 Vp-p, 75 ohms (pin jack)

Video output: 1.0 Vp-p, 75 ohms (pin jack)

Audio input:

-8 dB, 50 kilohms (pin jack)

Corresponding to mono (left)

Audio output: -8 dB, 1 kilohms (pin jack)

i.Link: 4-pin for DV input

Component video output:

Y: 1.0 Vp-p, 75 ohms

Cb/Cr, Pb/Pr: 0.7 Vp-p, 75 ohms

Corresponding to copy protection

Digital audio output:

Optical: -18 dBm, 660 nm

Coaxial: 0.7 Vp-p, 75 ohms

Corresponding to Dolby Digital and DTS Digital Surround

Bit stream

Selectable in digital audio output setting menu

VIDEO/AUDIO (VCR Deck)**Signal system**

NTSC color signal and EIA monochrome signal, 525 lines/60 fields

Recording system

DA4 (Double Azimuth) head helical scan system

Format

VHS NTSC standard

Maximum recording time

(SP): 210 min. with ST-210 video cassette

(EP): 30 min. with ST-210 video cassette

Signal-to-noise ratio

45 dB

Horizontal resolution

230 lines

Frequency range

(Normal audio): 70 Hz to 10,000 Hz

(Hi-Fi audio): 20 Hz to 20,000 Hz

Input/Output

RCA connectors: IN x 2, OUT x 1

Specifications shown are for SP mode unless otherwise specified.

TUNER/TIMER**Tuning system**

Frequency synthesized tuner

Channel coverage

VHF: Channels 2 – 13

UHF: Channels 14 – 69

CATV: 113 Channels

RF output

Channel 3 or 4 (switchable; preset to Channel 3 when shipped)

75 ohms, unbalanced

Memory backup time

Approx. 5 seconds

ACCESSORIES**Provided accessories**

RF cable x 3,

Antenna splitter,

Infrared remote control unit,

"AA" battery x 2

E. & O.E. Design and specifications subject to change without notice.

ATTENTION:

This unit contains microcomputers. External electronic noise or interference could cause malfunctioning. In such cases, switch the unit off and unplug the mains power cord. Then plug it in again and turn the unit on. Take out the disc. After checking the disc, operate the unit as usual.

Language Code List

| | | | | | |
|----|-----------------|----|------------------|----|----------------|
| AA | Afar | IK | Inupiak | RN | Kirundi |
| AB | Abkhazian | IN | Indonesian | RO | Rumanian |
| AF | Afrikaans | IS | Icelandic | RU | Russian |
| AM | Ameharic | IW | Hebrew | RW | Kinyarwanda |
| AR | Arabic | JA | Japanese | SA | Sanskrit |
| AS | Assamese | JI | Yiddish | SD | Sindhi |
| AY | Aymara | JW | Javanese | SG | Sangho |
| AZ | Azerbaijani | KA | Georgian | SH | Serbo-Croatian |
| BA | Bashkir | KK | Kazakh | SI | Singhalese |
| BE | Byelorussian | KL | Greenlandic | SK | Slovak |
| BG | Bulgarian | KM | Cambodian | SL | Slovenian |
| BH | Bihari | KN | Kannada | SM | Samoan |
| BI | Bislama | KO | Korean (KOR) | SN | Shona |
| BN | Bengali, Bangla | KS | Kashmiri | SO | Somali |
| BO | Tibetan | KU | Kurdish | SQ | Albanian |
| BR | Breton | KY | Kirghiz | SR | Serbian |
| CA | Catalan | LA | Latin | SS | Siswati |
| CO | Corsican | LN | Lingala | ST | Sesotho |
| CS | Czech | LO | Laothian | SU | Sundanese |
| CY | Welsh | LT | Lithuanian | SW | Swahili |
| DZ | Bhutani | LV | Latvian, Lettish | TA | Tamil |
| EL | Greek | MG | Malagasy | TE | Telugu |
| EO | Esperanto | MI | Maori | TG | Tajik |
| ET | Estonian | MK | Macedonian | TH | Thai |
| EU | Basque | ML | Malayalam | TI | Tigrinya |
| FA | Persian | MN | Mongolian | TK | Turkmen |
| FJ | Fiji | MO | Moldavian | TL | Tagalog |
| FO | Faroese | MR | Marathi | TN | Setswana |
| FY | Frisian | MS | Malay (MAY) | TO | Tonga |
| GA | Irish | MT | Maltese | TR | Turkish |
| GD | Scots Gaelic | MY | Burmese | TS | Tsonga |
| GL | Galician | NA | Nauru | TT | Tatar |
| GN | Guarani | NE | Nepali | TW | Twi |
| GU | Gujarati | OC | Occitan | UK | Ukrainian |
| HA | Hausa | OM | (Afan) Oromo | UR | Urdu |
| HI | Hindi | OR | Oriya | UZ | Uzbek |
| HR | Croatian | PA | Panjabi | VI | Vietnamese |
| HU | Hungarian | PL | Polish | VO | Volapuk |
| HY | Armenian | PS | Pashto, Pushto | WO | Wolof |
| IA | Interlingua | PT | Portuguese | XH | Xhosa |
| IE | Interlingue | QU | Quechua | YO | Yoruba |
| | | RM | Rhaeto-Romance | ZU | Zulu |

Country/Area Code List for Parental Lock

| | | | | | |
|----|--------------------------|----|----------------------------------|----|--|
| AD | Andorra | CK | Cook Islands | GN | Guinea |
| AE | United Arab Emirates | CL | Chile | GP | Guadeloupe |
| AF | Afghanistan | CM | Cameroon | GQ | Equatorial Guinea |
| AG | Antigua and Barbuda | CN | China | GR | Greece |
| AI | Anguilla | CO | Colombia | GS | South Georgia and the South Sandwich Islands |
| AL | Albania | CR | Costa Rica | GT | Guatemala |
| AM | Armenia | CU | Cuba | GU | Guam |
| AN | Netherlands Antilles | CV | Cape Verde | GW | Guinea-Bissau |
| AO | Angola | CX | Christmas Island | GY | Guyana |
| AQ | Antarctica | CY | Cyprus | HK | Hong Kong |
| AR | Argentina | CZ | Czech Republic | HM | Heard Island and McDonald Islands |
| AS | American Samoa | DE | Germany | HN | Honduras |
| AT | Austria | DJ | Djibouti | HR | Croatia |
| AU | Australia | DK | Denmark | HT | Haiti |
| AW | Aruba | DM | Dominica | HU | Hungary |
| AZ | Azerbaijan | DO | Dominican Republic | ID | Indonesia |
| BA | Bosnia and Herzegovina | DZ | Algeria | IE | Ireland |
| BB | Barbados | EC | Ecuador | IL | Israel |
| BD | Bangladesh | EE | Estonia | IN | India |
| BE | Belgium | EG | Egypt | IO | British Indian Ocean Territory |
| BF | Burkina Faso | EH | Western Sahara | IQ | Iraq |
| BG | Bulgaria | ER | Eritrea | IR | Iran (Islamic Republic of) |
| BH | Bahrain | ES | Spain | IS | Iceland |
| BI | Burundi | ET | Ethiopia | IT | Italy |
| BJ | Benin | FI | Finland | JM | Jamaica |
| BM | Bermuda | FJ | Fiji | JO | Jordan |
| BN | Brunei Darussalam | FK | Falkland Islands (Malvinas) | JP | Japan |
| BO | Bolivia | FM | Micronesia (Federated States of) | KE | Kenya |
| BR | Brazil | FO | Faroe Islands | KG | Kyrgyzstan |
| BS | Bahamas | FR | France | KH | Cambodia |
| BT | Bhutan | FX | France, Metropolitan | KI | Kiribati |
| BV | Bouvet Island | GA | Gabon | KM | Comoros |
| BW | Botswana | GB | United Kingdom | KN | Saint Kitts and Nevis |
| BY | Belarus | GD | Grenada | KP | Korea, Democratic People's Republic of |
| BZ | Belize | GE | Georgia | KR | Korea, Republic of |
| CA | Canada | GF | French Guiana | KW | Kuwait |
| CC | Cocos (Keeling) Islands | GH | Ghana | KY | Cayman Islands |
| CF | Central African Republic | GI | Gibraltar | KZ | Kazakhstan |
| CG | Congo | GL | Greenland | LA | Lao People's Democratic Republic |
| CH | Switzerland | GM | Gambia | LB | Lebanon |
| CI | Côte d'Ivoire | | | | |

| | | | | | |
|----|--------------------------|----|---------------------------|----|--------------------------------------|
| LC | Saint Lucia | NU | Niue | SZ | Swaziland |
| LI | Liechtenstein | NZ | New Zealand | TC | Turks and Caicos Islands |
| LK | Sri Lanka | OM | Oman | TD | Chad |
| LR | Liberia | PA | Panama | TF | French Southern Territories |
| LS | Lesotho | PE | Peru | TG | Togo |
| LT | Lithuania | PF | French Polynesia | TH | Thailand |
| LU | Luxembourg | PG | Papua New Guinea | TJ | Tajikistan |
| LV | Latvia | PH | Philippines | TK | Tokelau |
| LY | Libyan Arab Jamahiriya | PK | Pakistan | TM | Turkmenistan |
| MA | Morocco | PL | Poland | TN | Tunisia |
| MC | Monaco | PM | Saint Pierre and Miquelon | TO | Tonga |
| MD | Moldova, Republic of | PN | Pitcairn | TP | East Timor |
| MG | Madagascar | PR | Puerto Rico | TR | Turkey |
| MH | Marshall Islands | PT | Portugal | TT | Trinidad and Tobago |
| ML | Mali | PW | Palau | TV | Tuvalu |
| MM | Myanmar | PY | Paraguay | TW | Taiwan, Province of China |
| MN | Mongolia | QA | Qatar | TZ | Tanzania, United Republic of |
| MO | Macau | RE | Réunion | UA | Ukraine |
| MP | Northern Mariana Islands | RO | Romania | UG | Uganda |
| MQ | Martinique | RU | Russian Federation | UM | United States Minor Outlying Islands |
| MR | Mauritania | RW | Rwanda | US | United States |
| MS | Montserrat | SA | Saudi Arabia | UY | Uruguay |
| MT | Malta | SB | Solomon Islands | UZ | Uzbekistan |
| MU | Mauritius | SC | Seychelles | VA | Vatican City State (Holy See) |
| MV | Maldives | SD | Sudan | VC | Saint Vincent and the Grenadines |
| MW | Malawi | SE | Sweden | VE | Venezuela |
| MX | Mexico | SG | Singapore | VG | Virgin Islands (British) |
| MY | Malaysia | SH | Saint Helena | VI | Virgin Islands (U.S.) |
| MZ | Mozambique | SI | Slovenia | VN | Viet Nam |
| NA | Namibia | SJ | Svalbard and Jan Mayen | VU | Vanuatu |
| NC | New Caledonia | SK | Slovakia | WF | Wallis and Futuna Islands |
| NE | Niger | SL | Sierra Leone | WS | Samoa |
| NF | Norfolk Island | SM | San Marino | YE | Yemen |
| NG | Nigeria | SN | Senegal | YT | Mayotte |
| NI | Nicaragua | SO | Somalia | YU | Yugoslavia |
| NL | Netherlands | SR | Suriname | ZA | South Africa |
| NO | Norway | ST | Sao Tome and Principe | ZM | Zambia |
| NP | Nepal | SV | El Salvador | ZR | Zaire |
| NR | Nauru | SY | Syrian Arab Republic | ZW | Zimbabwe |

| | | | |
|--|--------|---|------------------|
| A | | P | |
| A-B Repeat Playback | 34 | Pan&Scan | 24 |
| Accidental erasure prevention | 51 | Play List | 58 |
| Adjusting The Picture Quality | 35 | Playback | 25 – 37, 47 – 49 |
| Angle Selection | 28 | Playback Control (PBC) | 29 |
| Audio Channel Selection | 29 | Program Playback | 36 |
| Audio Language/Sound Selection | 28 | | |
| Auto Channel Set | 21 | Q | |
| Auto Daylight Saving Time | 20 | Quick Rewind A Little | 48 |
| | | | |
| C | | R | |
| Check, Cancel And Change Programs | 45, 54 | Random Playback | 36 |
| | | Recordable/playable discs | 8 |
| D | | Recording | 38 – 40, 50 – 51 |
| Delete Program | 57 | Recording Medium And Format | 9 |
| Disc menu | 26 | Recording Mode | 38 |
| Disc Remaining Time | 39 | Recording Resume Function | 38, 50 |
| Discs For Playback Only | 8 | Region Number | 9 |
| DVD menu | 26 | Register Disc | 60 |
| | | Repeat Playback | 34, 49 |
| E | | Resume Function | 27 |
| Elapsed Recording Time Indication | 39, 51 | | |
| | | S | |
| F | | SAP | 40, 51 |
| File Structure Of Discs | 9 | Second Audio Recording | 40, 51 |
| Free Rate Function | 40 | Select The Switching Interval Of The Slide Show | 36 |
| | | Semiauto Clock Set | 20 |
| G | | Setting The Progressive Mode | 36 |
| Guide Channel Number | 77 | Simulated Surround Effect | 35 |
| | | Skip Search | 27, 48 |
| H | | Slow Motion | 27, 48 |
| High-Speed Search | 26, 48 | Soundtrack Selection | 49 |
| | | Still Picture/Frame-By-Frame Playback | 27, 48 |
| I | | Subtitle Selection | 28 |
| Index Search | 48 | | |
| Instant Timer Recording (ITR) | 39, 51 | T | |
| | | Tape Position Indicator | 15 |
| L | | Tape Remaining Time | 51 |
| Letter Box | 24 | Time Search | 35 |
| Live Memory | 29 | Timer Recording | 41 – 46, 52 – 54 |
| | | Top menu | 26 |
| M | | | |
| Manual Channel Set | 21 | U | |
| Manual Clock Set | 20 | Unplayable Discs | 9 |
| Manual Tracking | 49 | Usable cassettes | 47 |
| Marking Positions To Play Back Again Later | 27 | | |
| Menu/Audio/Subtitle Language Set | 19 | W | |
| | | When Programs Overlap Each Other | 45, 54 |
| N | | | |
| Next Function Memory | 49 | | |
| | | | |
| O | | | |
| One Touch Replay | 32 | | |
| On-screen bar | 33 | | |
| On-screen Language Set | 19 | | |



LIMITED WARRANTY

USA ONLY

ONLY FOR PRODUCT PURCHASED IN U.S.A. CONSUMER VIDEO 1-90

JVC COMPANY OF AMERICA warrants this product and all parts thereof, except as set forth below ONLY TO THE ORIGINAL PURCHASER AT RETAIL to be FREE FROM DEFECTIVE MATERIALS AND WORKMANSHIP from the date of original retail purchase for the period as shown below. ("The Warranty Period")

| | |
|-------------|----------------|
| PARTS | LABOR |
| 1 YR | 90 DAYS |

THIS LIMITED WARRANTY IS VALID ONLY IN THE FIFTY (50) UNITED STATES, THE DISTRICT OF COLUMBIA AND IN COMMONWEALTH OF PUERTO RICO.

WHAT WE WILL DO:

If this product is found to be defective, JVC will repair or replace defective parts at no charge to the original owner. Such repair and replacement services shall be rendered by JVC during normal business hours at JVC authorized service centers. Parts used for replacement are warranted only for the remainder of the Warranty Period. All products and parts thereof may be brought to a JVC authorized service center on a carry-in basis except for Television sets having a screen size 25 inches and above which are covered on an in-home basis.

WHAT YOU MUST DO FOR WARRANTY SERVICE:

Return your product to a JVC authorized service center with a copy of your bill of sale. For your nearest JVC authorized service center, please call toll free: (800) 252-5722.

If service is not available locally, box the product carefully, preferably in the original carton, and ship, insured, with a copy of your bill of sale plus a letter of explanation of the problem to the nearest JVC Factory Service Center, the name and location of which will be given to you by the toll-free number.

If you have any questions concerning your JVC Product, please contact our Customer Relations Department.

WHAT IS NOT COVERED:

This limited warranty provided by JVC does not cover:

1. Products which have been subject to abuse, accident, alteration, modification, tampering, negligence, misuse, faulty installation, lack of reasonable care, or if repaired or serviced by anyone other than a service facility authorized by JVC to render such service, or if affixed to any attachment not provided with the products, or if the model number or serial number has been altered, tampered with, defaced or removed;
2. Initial installation and installation and removal for repair;
3. Operational adjustments covered in the Owner's Manual, normal maintenance, video and audio head cleaning;
4. Damage that occurs in shipment, due to act of God, and cosmetic damage;
5. Signal reception problems and failures due to line power surge;
6. Video Pick-up Tubes/CCD Image Sensor, Cartridge, Stylus (Needle) are covered for 90 days from the date of purchase;
7. Accessories;
8. Batteries (except that Rechargeable Batteries are covered for 90 days from the date of purchase);

There are no express warranties except as listed above.

THE DURATION OF ANY IMPLIED WARRANTIES, INCLUDING THE IMPLIED WARRANTY OF MERCHANTABILITY, IS LIMITED TO THE DURATION OF THE EXPRESS WARRANTY HEREIN.

JVC SHALL NOT BE LIABLE FOR ANY LOSS OF USE OF THE PRODUCT, INCONVENIENCE, LOSS OR ANY OTHER DAMAGES, WHETHER DIRECT, INCIDENTAL OR CONSEQUENTIAL (INCLUDING, WITHOUT LIMITATION, DAMAGE TO TAPES, RECORDS OR DISCS) RESULTING FROM THE USE OF THIS PRODUCT, OR ARISING OUT OF ANY BREACH OF THIS WARRANTY. ALL EXPRESS AND IMPLIED WARRANTIES, INCLUDING THE WARRANTIES OF MERCHANTABILITY AND FITNESS FOR PARTICULAR PURPOSE, ARE LIMITED TO THE WARRANTY PERIOD SET FORTH ABOVE.

Some states do not allow the exclusion of incidental or consequential damages or limitations on how long an implied warranty lasts, so these limitations or exclusions may not apply to you. This warranty gives you specific legal rights and you may also have other rights which vary from state to state.

JVC COMPANY OF AMERICA
DIVISION OF JVC AMERICAS CORP.

1700 Valley Road
Wayne, NJ 07470



REFURBISHED PRODUCTS CARRY A SEPARATE WARRANTY, THIS WARRANTY DOES NOT APPLY. FOR DETAILS OF REFURBISHED PRODUCT WARRANTY, PLEASE REFER TO THE REFURBISHED PRODUCT WARRANTY INFORMATION PACKAGED WITH EACH REFURBISHED PRODUCT.

For customer use:

Enter below the Model No. which is located either on the rear, bottom or side of the cabinet. Retain this information for future reference.

Model No. : _____

Serial No. : _____

Purchase date : _____

Name of dealer : _____

TO OUR VALUED CUSTOMER _____

THANK YOU FOR PURCHASING THIS JVC PRODUCT.
WE WANT TO HELP YOU ACHIEVE A PERFECT EXPERIENCE.

**NEED HELP ON HOW TO HOOK UP?
NEED ASSISTANCE ON HOW TO OPERATE?
NEED TO LOCATE A JVC SERVICE CENTER?
LIKE TO PURCHASE ACCESSORIES?**

DR-MV1S

JVC[®] IS HERE TO HELP!

**TOLL FREE: 1 (800) 252-5722
<http://www.jvc.com>**

Remember to retain your Bill of Sale for Warranty Service.

_____ Do not attempt to service the product yourself _____

Caution

To prevent electrical shock, do not open the cabinet.
There are no user serviceable parts inside.
Please refer to qualified service personnel for repairs.

JVC
VICTOR COMPANY OF JAPAN, LIMITED

Free Manuals Download Website

<http://myh66.com>

<http://usermanuals.us>

<http://www.somanuals.com>

<http://www.4manuals.cc>

<http://www.manual-lib.com>

<http://www.404manual.com>

<http://www.luxmanual.com>

<http://aubethermostatmanual.com>

Golf course search by state

<http://golfingnear.com>

Email search by domain

<http://emailbydomain.com>

Auto manuals search

<http://auto.somanuals.com>

TV manuals search

<http://tv.somanuals.com>