

JVC

SCHEMATIC DIAGRAMS

COMPACT COMPONENT SYSTEM

DX-J36UN,DX-J36EE,DX-J36UX,DX-J36UG
DX-J21UN,DX-J21J,DX-J21EE,DX-J21A
DX-J21UW,DX-J21UX,DX-J21UG
DX-J11UN,DX-J11EE,DX-J11UW
DX-J11UX,DX-J11UG,DX-J11UH

DVD-ROM No.SML2008Q1

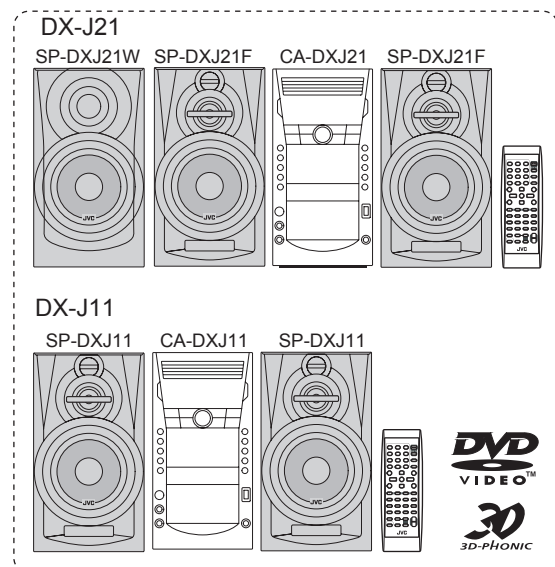
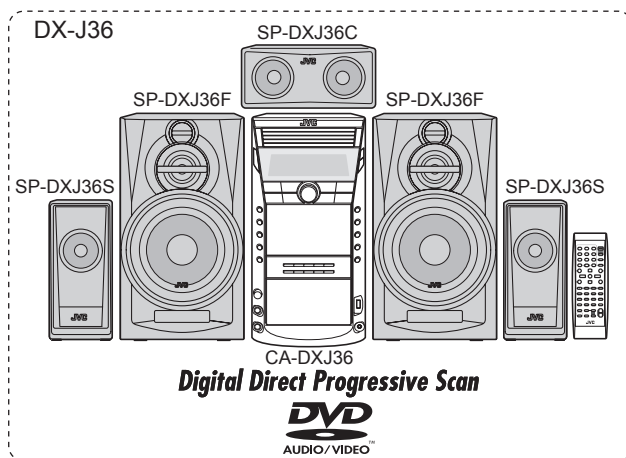

Lead free solder used in the board (material : Sn-Ag-Cu, melting point : 219 Centigrade)
Lead free solder used in the board (material : Sn-Cu, melting point : 230 Centigrade)

Contents

Block diagrams	2-1
Standard schematic diagrams	2-2
Printed circuit boards	2-20 to 22

In regard with component parts appearing on the silk-screen printed side (parts side) of the PWB diagrams, the parts that are printed over with black such as the resistor (■), diode (▣) and ICP (●) or identified by the "▲" mark nearby are critical for safety.

Block diagram (For DX-J36)

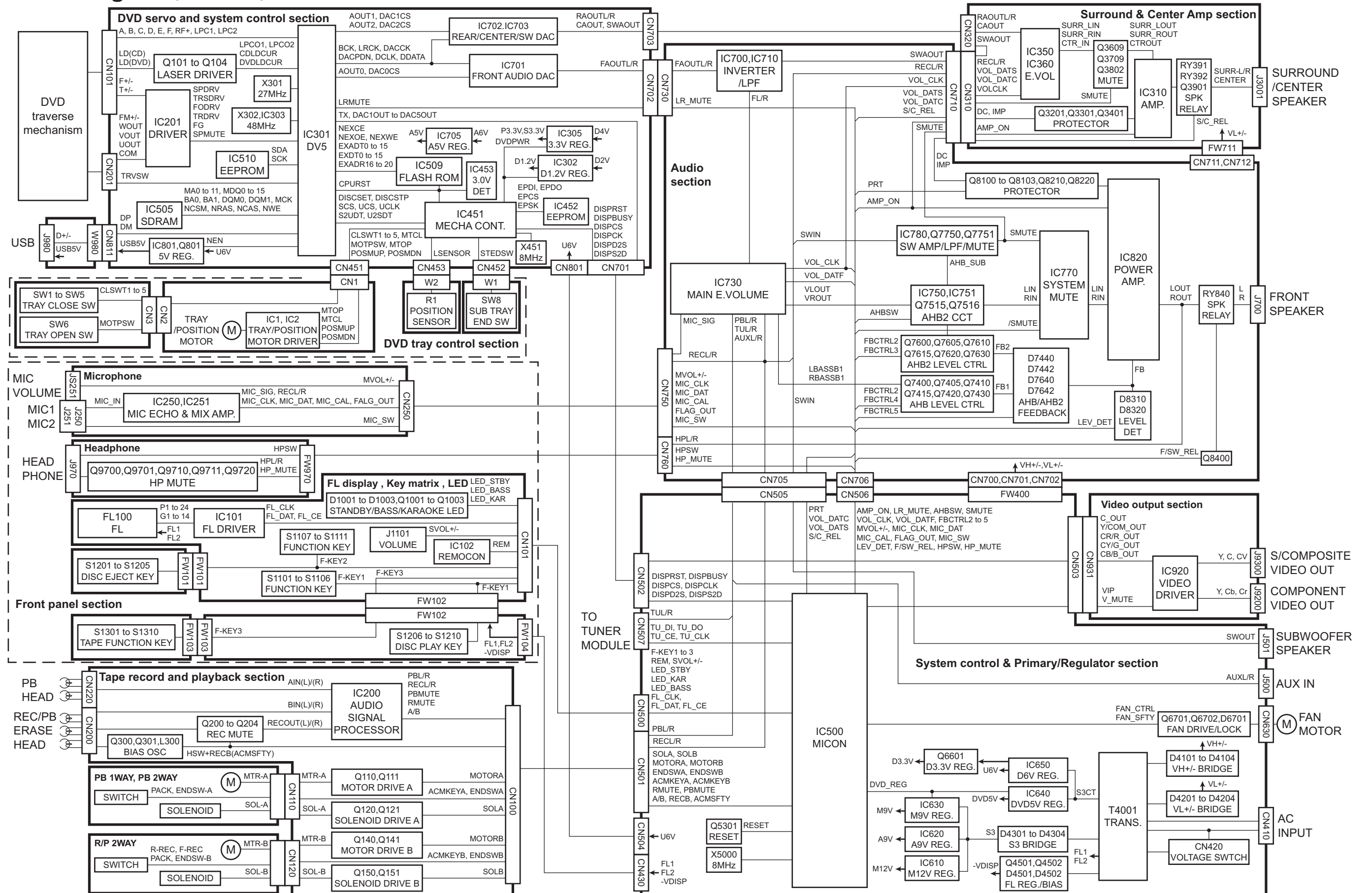

Block diagram (For DX-J11 and DX-J21)

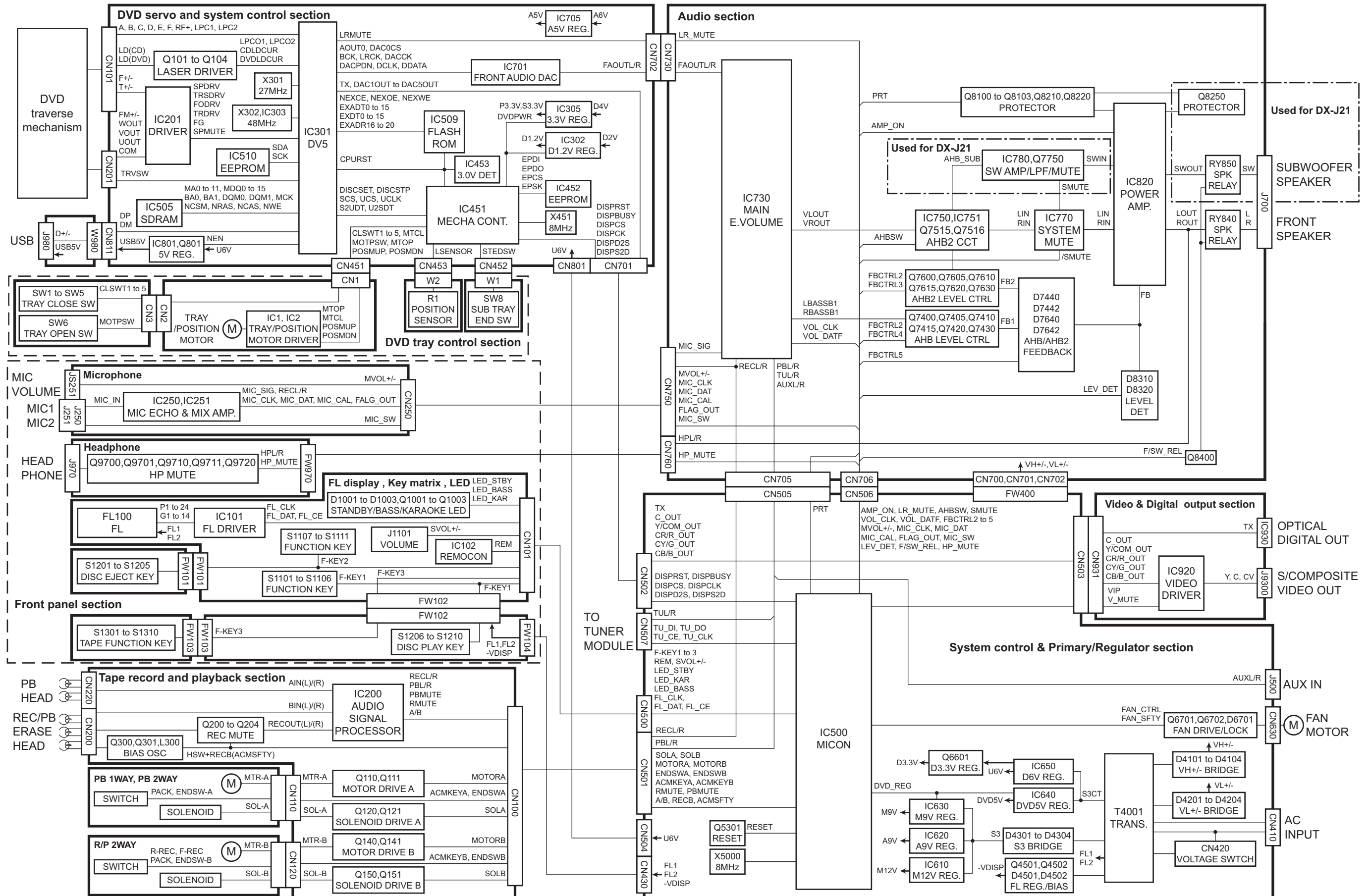

Standard schematic diagrams

Primary section (DX-J36)

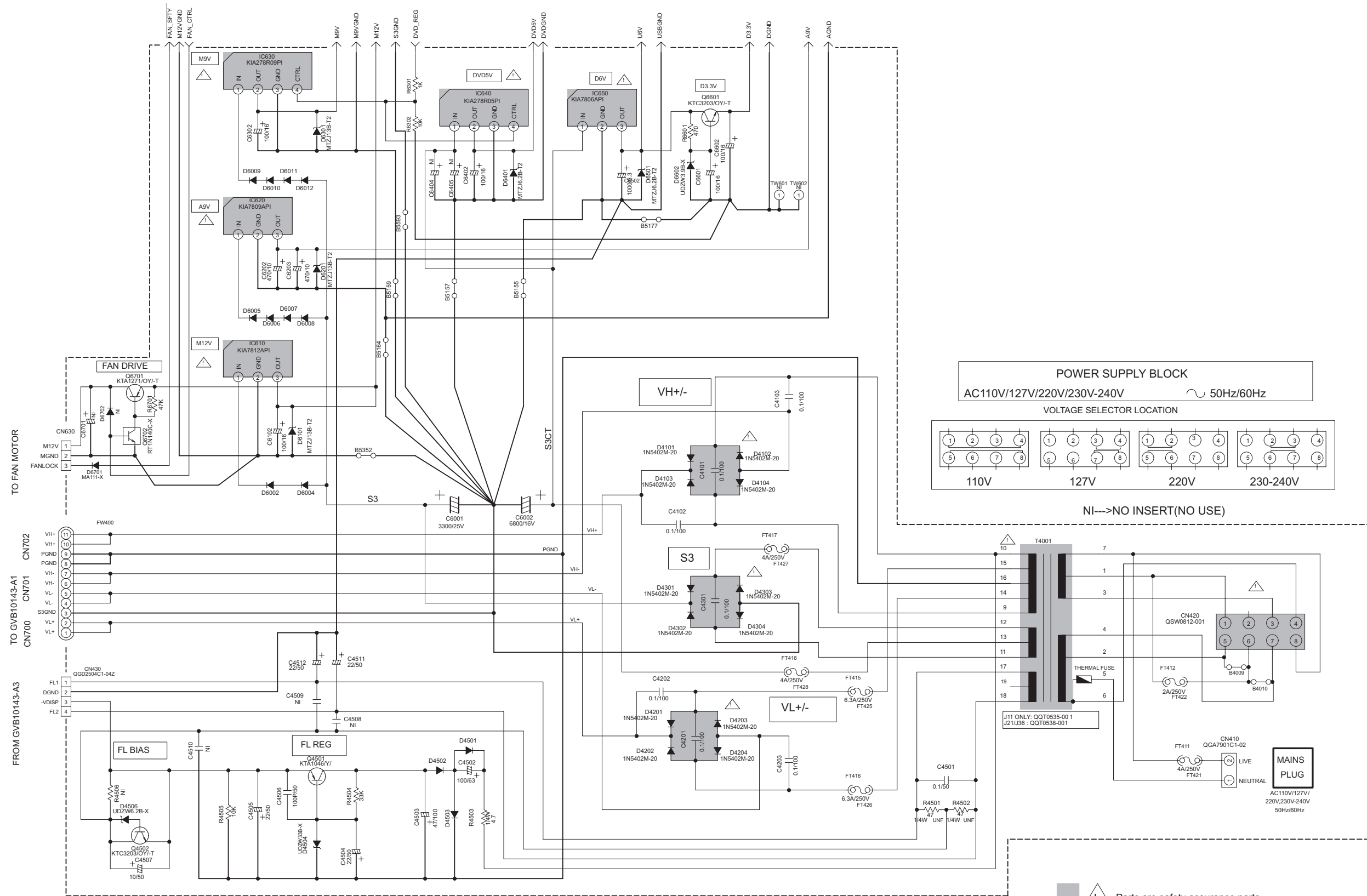

NOTES

- VOLTAGES ARE DC-MEASURED WITH A DIGITAL VOLTMETER OR OSCILLOSCOPE WITHOUT INPUT SIGNAL. CONDITION --- DVD STOP MODE
- UNLESS OTHERWISE SPECIFIED.
 - ALL RESISTORS ARE 1/16W ±5% CARBON FILM RESISTOR OR 0.625W ±5% THICK FILM CHIP RESISTOR.
 - ALL CAPACITORS ARE CERAMIC CAPACITOR OR MYLAR CAPACITOR.
 - ALL RESISTANCE VALUES ARE IN OHM(Ω).
 - ALL CAPACITANCE VALUES ARE IN μF(PpF).
 - ALL E-CAPACITORS ARE SHOWN IN THE FORM OF CAPACITANCE(μF) / RATED VOLTAGE(V).
 - ALL INDUCTANCE VALUES ARE IN μH(m=mH).
 - ALL DIODES ARE 1N4003S-T5
 - NI = NON INSERT

VERSION	CN420	B4009	B4010
A/EE	NI	NI	INSERT
UY	NI	INSERT	NI
OTHERS	INSERT	NI	NI

Parts are safety assurance parts. When replacing those parts make sure to use the specified one.

■ Subwoofer amp section (DX-J36)

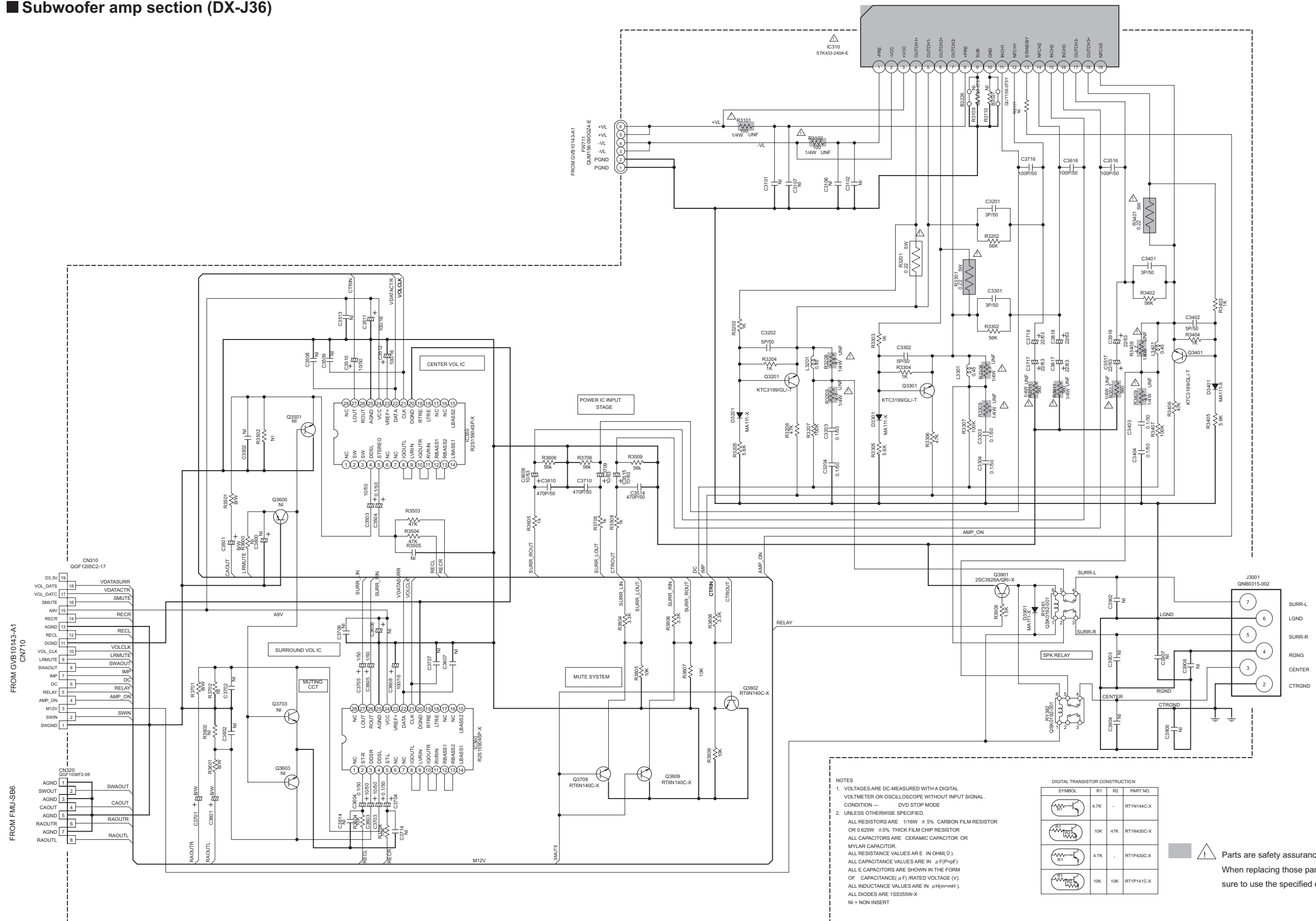

NOTES
 1. VOLTAGES ARE DC-MEASURED WITH A DIGITAL VOLTMETER OR OSCILLOSCOPE WITHOUT INPUT SIGNAL. CONDITION — DVD STOP MODE
 2. UNLESS OTHERWISE SPECIFIED.
 ALL RESISTORS ARE 1/16W ± 5% CARBON FILM RESISTOR OR 0.625W ± 5% THICK FILM CHIP RESISTOR
 ALL CAPACITORS ARE CERAMIC CAPACITOR OR MYLAR CAPACITOR.
 ALL RESISTANCE VALUES ARE IN OHM(Ω).
 ALL CAPACITANCE VALUES ARE IN μ(F)=P(F)
 ALL E. CAPACITORS ARE SHOWN IN THE FORM OF CAPACITANCE(μ F)/RATED VOLTAGE (V).
 ALL INDUCTANCE VALUES ARE IN μH(m=mH).
 ALL DIODES ARE 1SS355W-X.
 NI = NON INSERT

DIGITAL TRANSISTOR CONSTRUCTION

SYMBOL	R1	R2	PART NO.
	4.7K	-	RT1N144C-X
	10K	47K	RT1N430C-X
	4.7K	-	RT1P430C-X
	10K	10K	RT1P141C-X

⚠ Parts are safety assurance parts. When replacing those parts make sure to use the specified one.

Audio section (DX-J36)

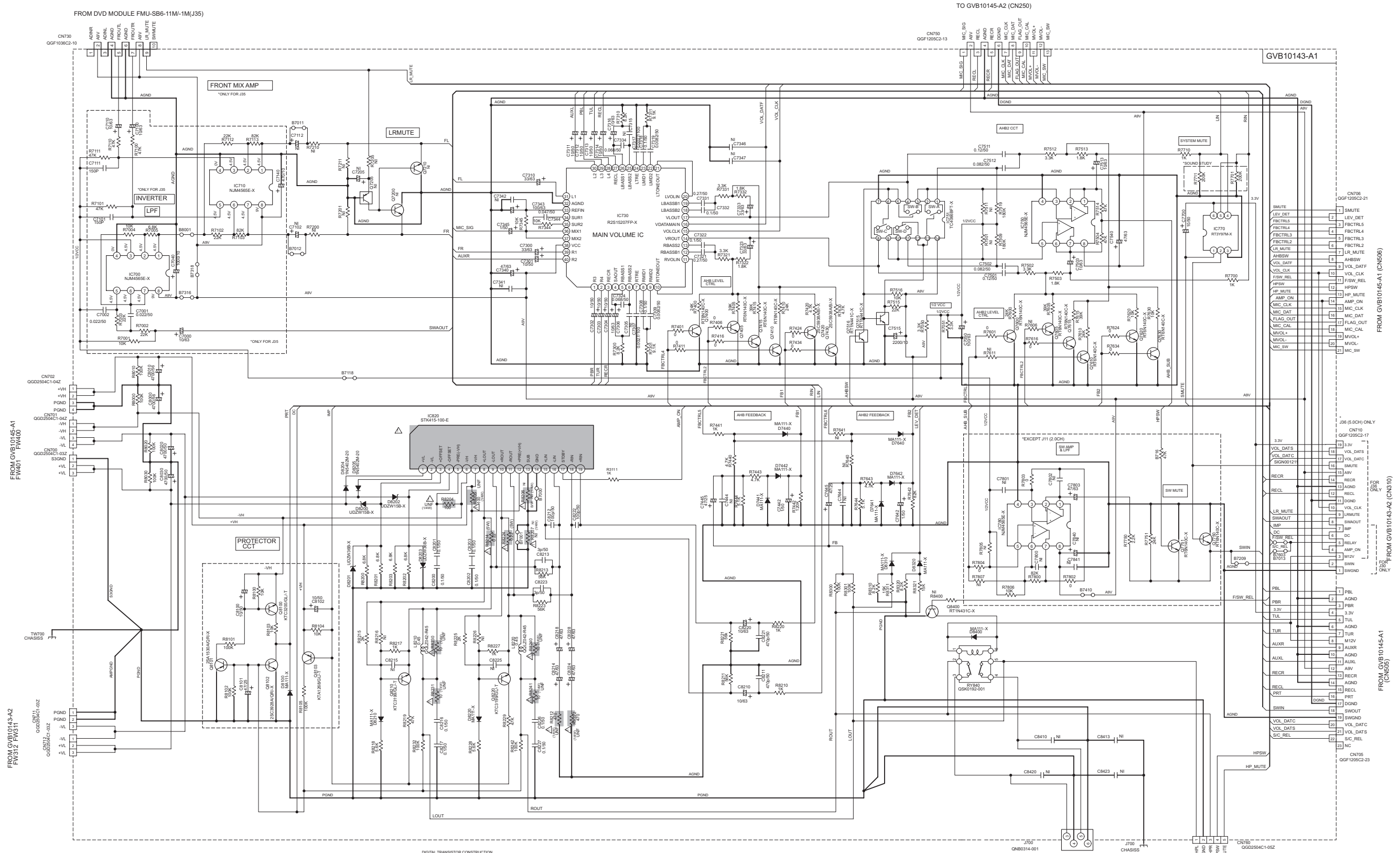

NOTES

- VOLTAGES ARE DC-MEASURED WITH A DIGITAL VOLT METER OR OSCILLOSCOPE WITHOUT INPUT SIGNAL. CONDITION - DVD STOP MODE.
- UNLESS OTHERWISE SPECIFIED, ALL RESISTORS ARE 1/16W ± 5% CARBON FILM RESISTOR OR 0.625W ± 5% THICK FILM CHIP RESISTOR. ALL CAPACITORS ARE CERAMIC CAPACITOR OR MYLAR CAPACITOR.

ALL RESISTANCE VALUES ARE IN OHM (Ω). ALL CAPACITANCE VALUES ARE IN μF (μF) UNLESS OTHERWISE SPECIFIED. ALL INDUCTANCE VALUES ARE IN μH (μH) UNLESS OTHERWISE SPECIFIED. ALL DIODES ARE MA111-X. N = NON INSERT.

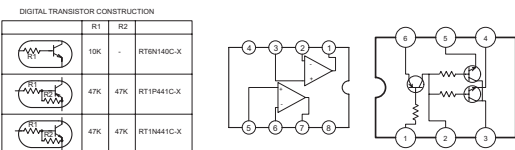

Parts are safety assurance parts. When replacing those parts make sure to use the specified one.

TO GVB10145-A4 (FW260)

■ Cassette control section (DX-J36)

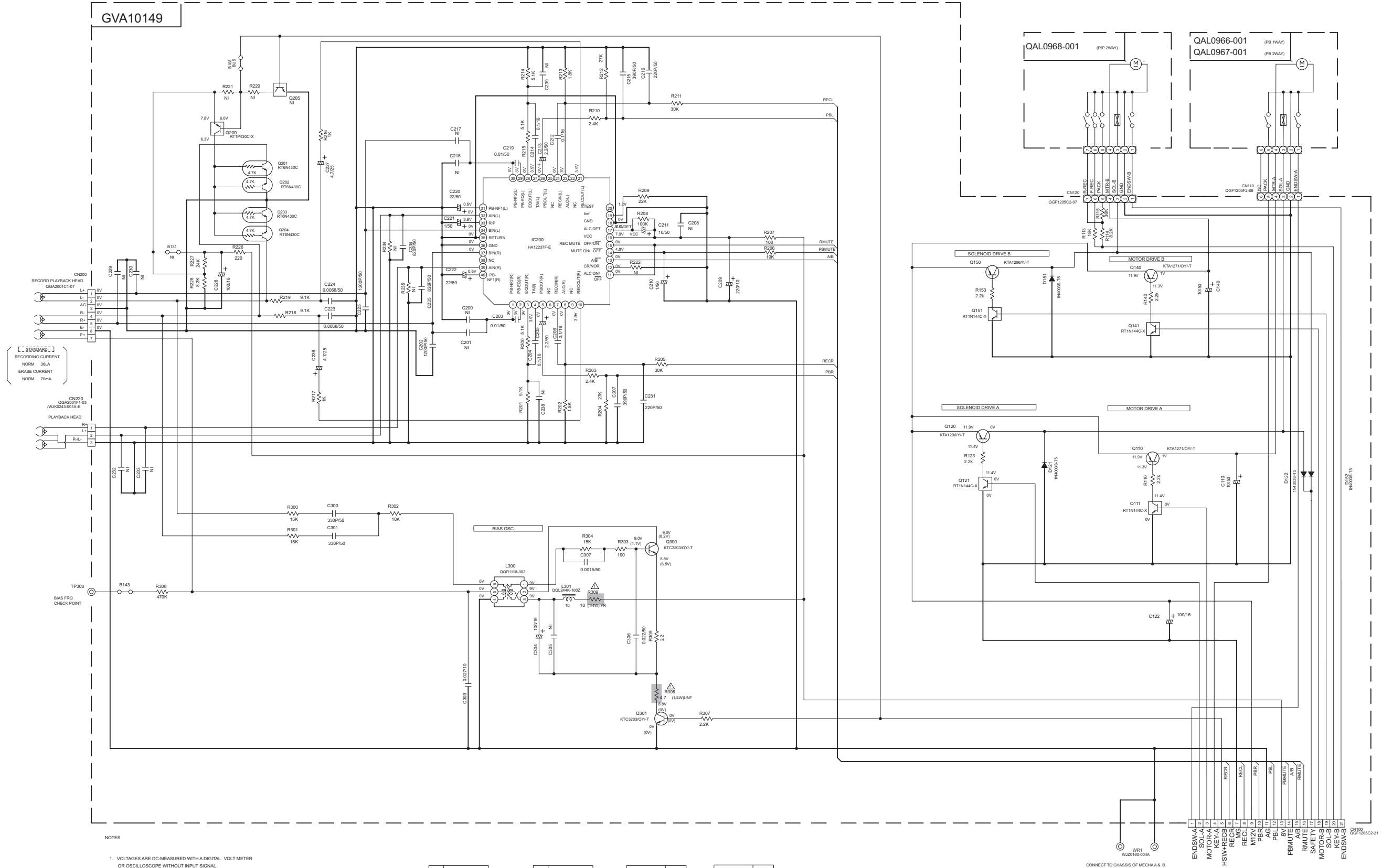

■ Front end section 1 (DX-J36)

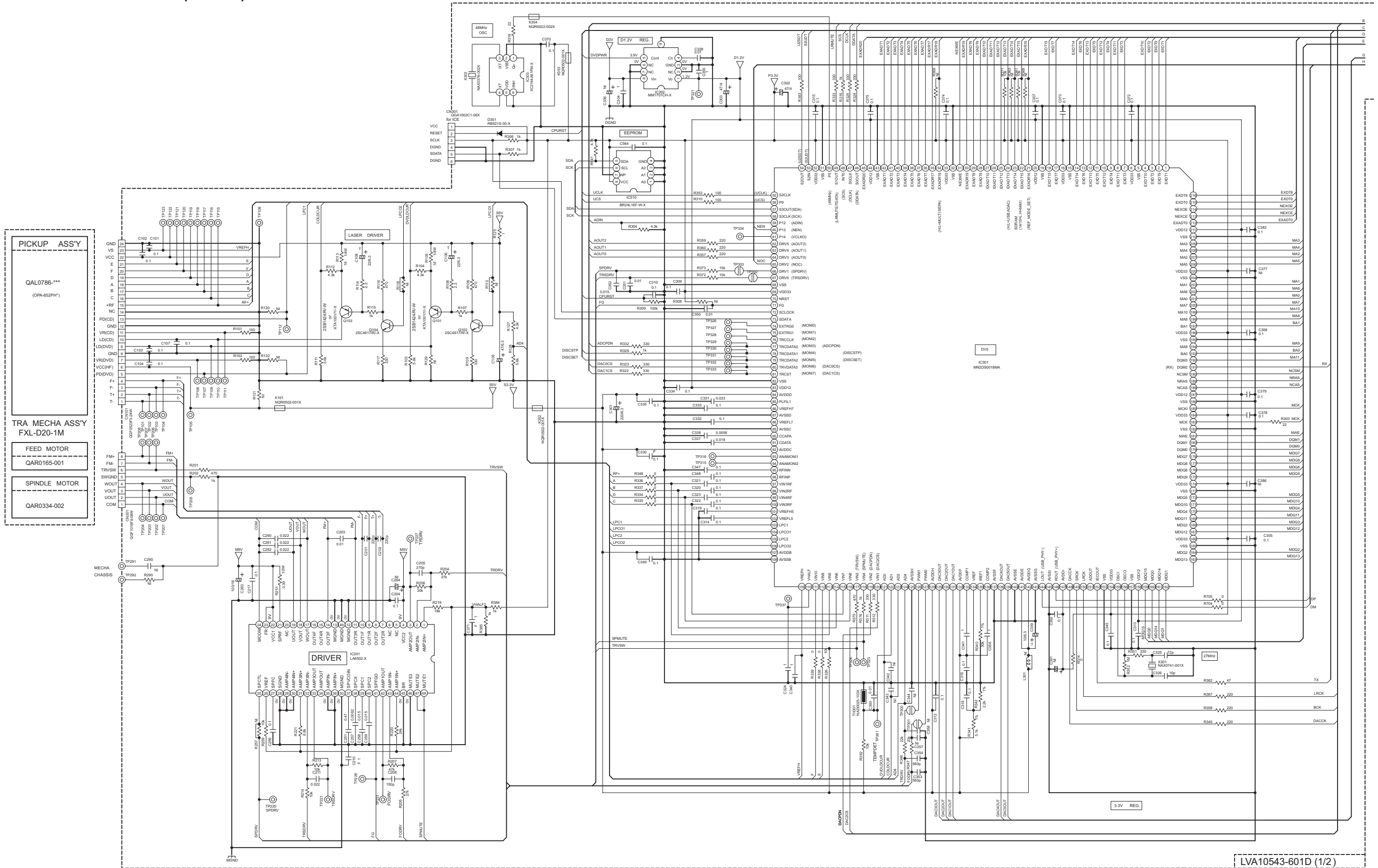

LVA10543-601D (1/2)

■ Front end section 2 (DX-J36)

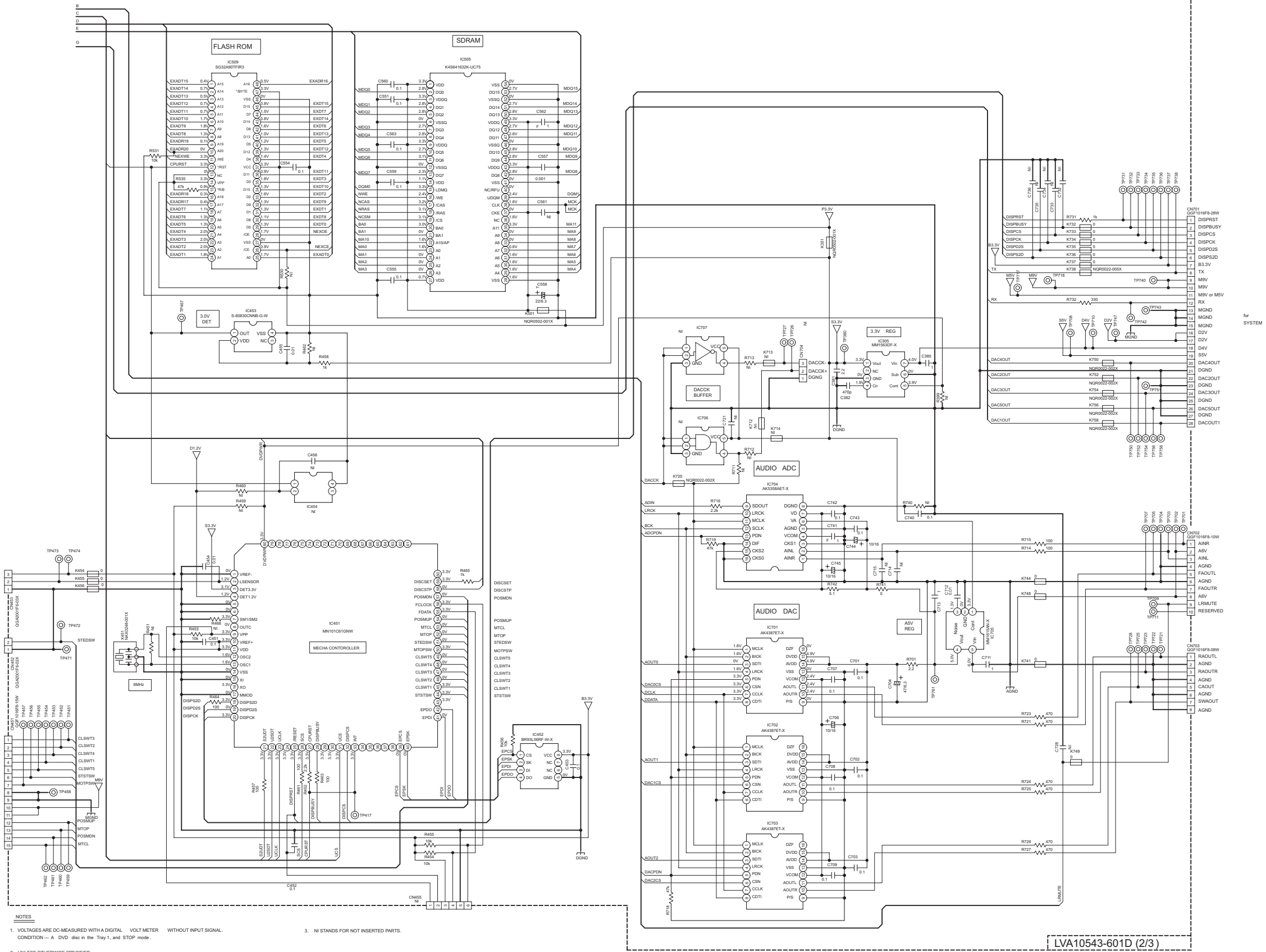

LOADER ASS'Y
CH5-BASE-1

See
LVS20135-002A

NOTES

- VOLTAGES ARE DC-MEASURED WITH A DIGITAL VOLT-METER WITHOUT INPUT SIGNAL. CONDITION — A DVD disc in the Tray 1, and STOP mode.
- UNLESS OTHERWISE SPECIFIED:
ALL RESISTORS ARE 1/16W ± 5% METAL GLAZE RESISTOR. OR 0.5% METAL GLAZE RESISTOR.
ALL CAPACITORS ARE 50V, 25V, 16V, 10V OR 6.3V CERAMIC CAPACITOR.
ALL RESISTANCE VALUES ARE IN OHM (Ω).
ALL CAPACITANCE VALUES ARE IN PICO-FARAD (pF).
ALL CAPACITORS ARE SHOWN IN THE FORM OF CAPACITANCE (#F)/RATED VOLTAGE (V).
ALL INDUCTANCE VALUES ARE IN MICROHENRY (μH).
- N/ STANDS FOR NOT INSERTED PARTS.

Front end section 3 (DX-J36)

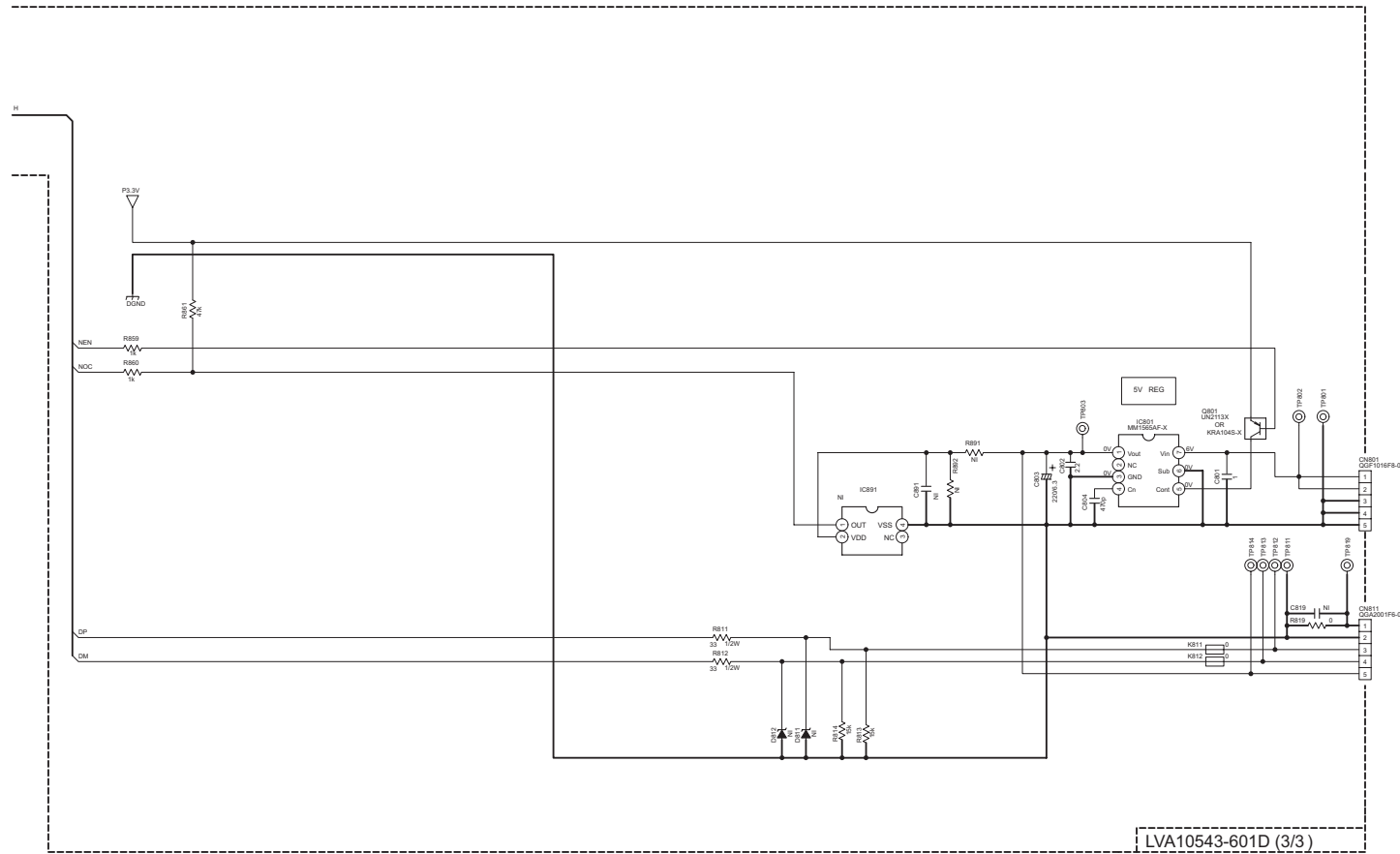

LVA10543-601D (3/3)

NOTES

- VOLTAGES ARE DC-MEASURED WITH A DIGITAL VOLT METER WITHOUT INPUT SIGNAL. CONDITION - A DVD disc in the Tray 1, and STOP mode.
- UNLESS OTHERWISE SPECIFIED:
ALL RESISTORS ARE 1/16W ±5% METAL GLAZE RESISTOR OR 0.5% METAL GLAZE RESISTOR.
ALL CAPACITORS ARE 50V, 25V, 16V, 10V or 6.3V CERAMIC CAPACITOR.
ALL RESISTANCE VALUES ARE IN OHM (Ω).
ALL CAPACITANCE VALUES ARE IN nF (pF).
ALL CAPACITORS ARE SHOWN IN THE FORM OF CAPACITANCE (μF)/RATED VOLTAGE (V).
ALL INDUCTANCE VALUES ARE IN nH (nH).
- NI STANDS FOR NOT INSERTED PARTS.
- DIGITAL TRANSISTOR



Loader section (DX-J36)

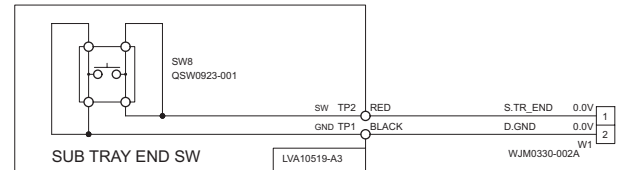
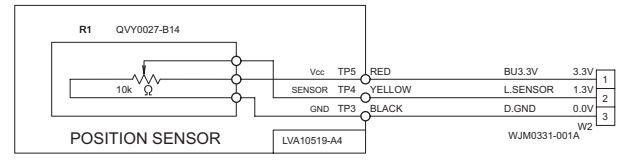
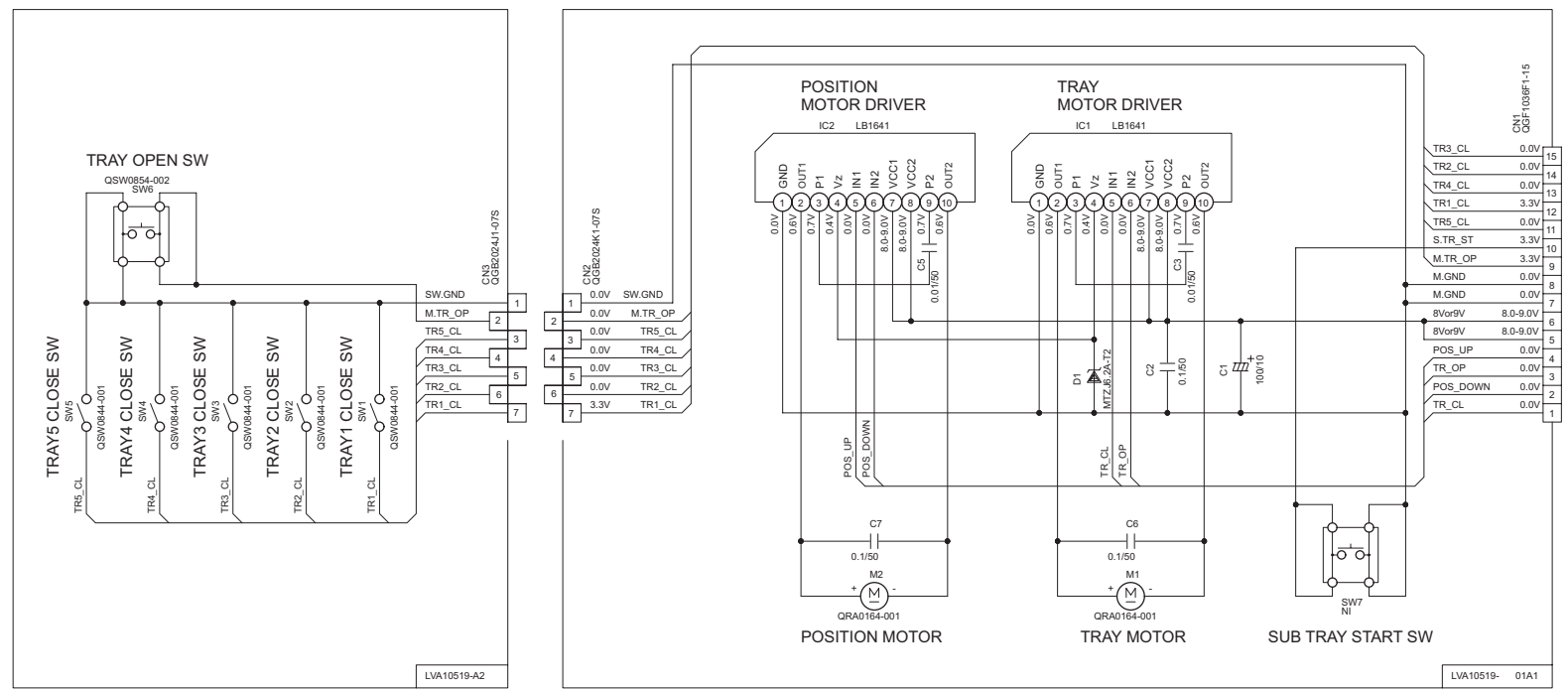

NOTES

- VOLTAGES ARE DC-MEASURED WITH A DIGITAL VOLT METER. CONDITION: DISC1 STOP
- UNLESS OTHERWISE SPECIFIED.
ALL CAPACITORS ARE SHOWN IN THE FORM OF CAPACITANCE (μF)/RATED VOLTAGE (V).
- NI STANDS FOR NOT INSERTED PARTS.

■ Primary section (DX-J21,DX-J11)

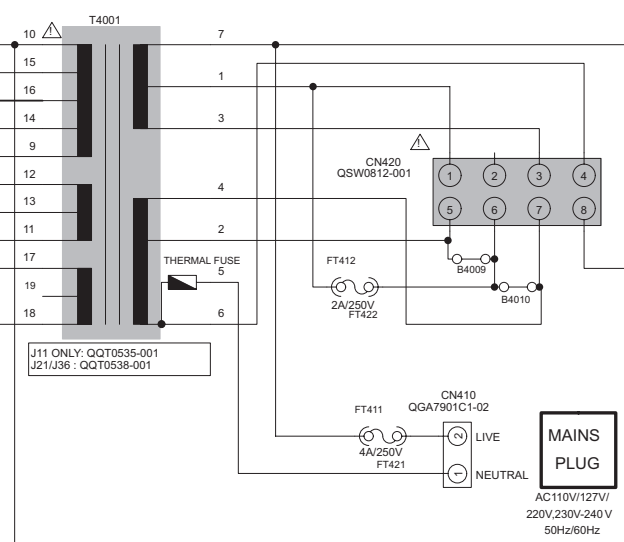
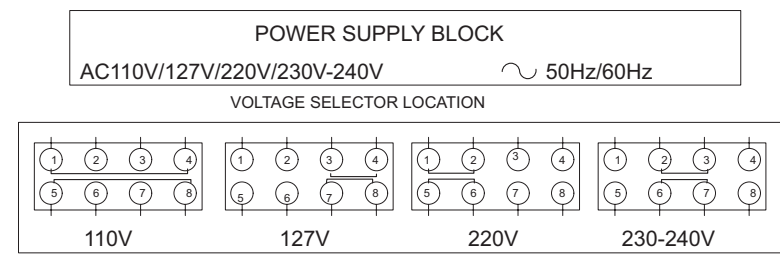
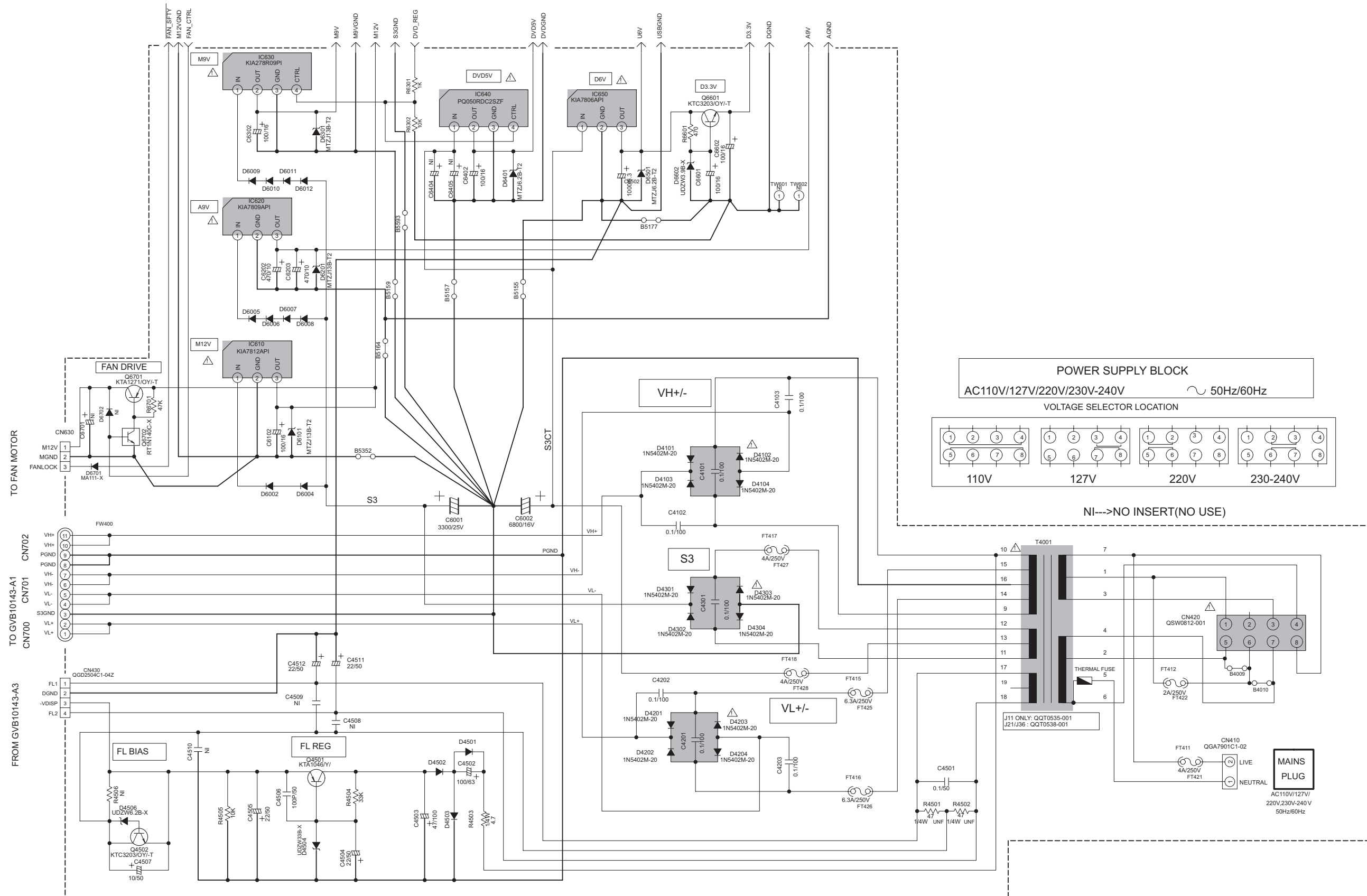

Audio section (DX-J21,DX-J11)

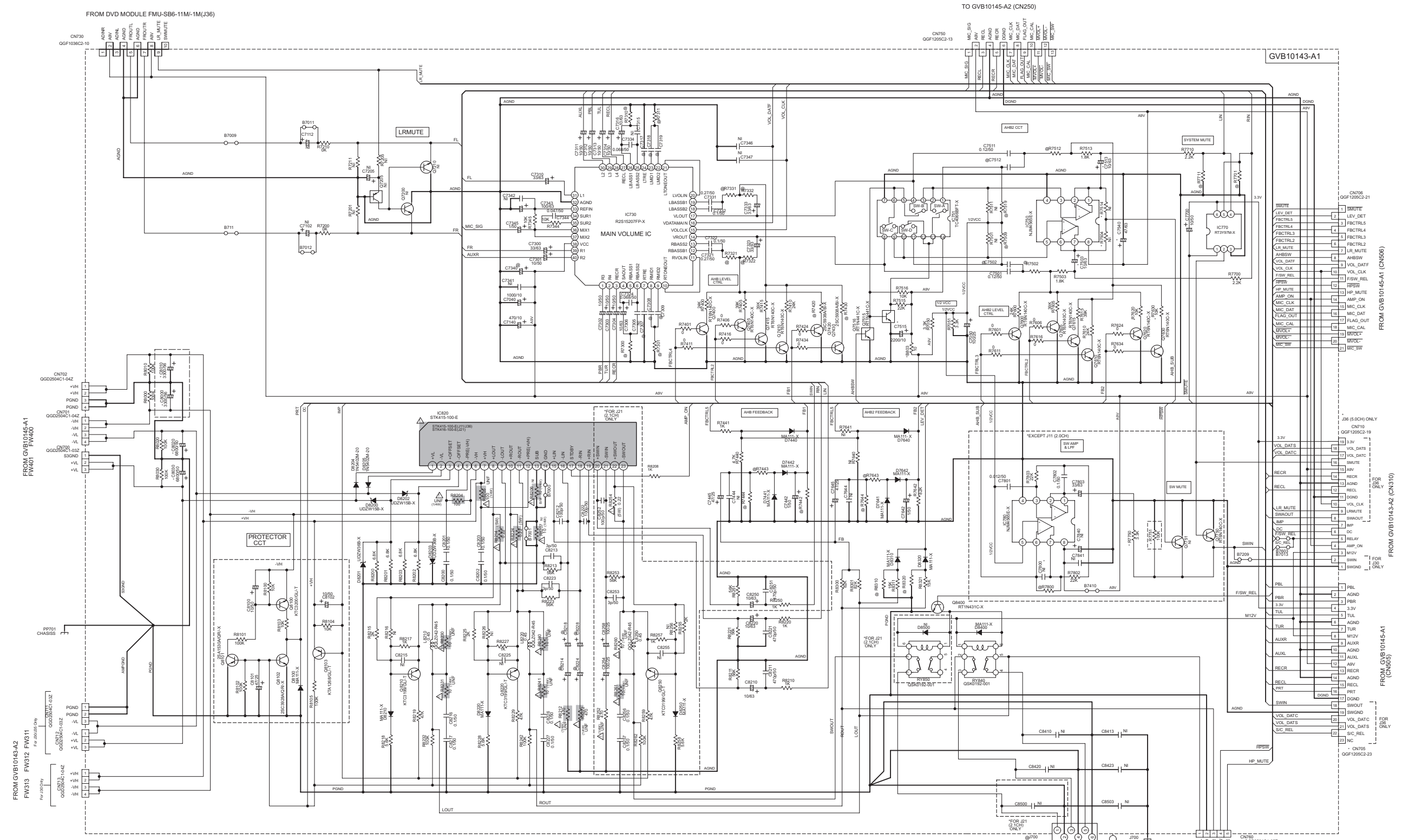

NOTES
 1. VOLTAGES ARE DC-MEASURED WITH A DIGITAL VOLT METER OR OSCILLOSCOPE WITHOUT INPUT SIGNAL CONDITION - DVD STOP MODE
 2. UNLESS OTHERWISE SPECIFIED, ALL RESISTORS ARE 1% 5W ± 5% CARBON FILM RESISTOR OR 0.5W ± 5% THICK FILM CHIP RESISTOR
 ALL CAPACITORS ARE CERAMIC CAPACITOR OR MYLAR CAPACITOR.

ALL RESISTANCE VALUES ARE IN OHM (Ω)
 ALL CAPACITANCE VALUES ARE IN PICO-FARAD (pF)
 ALL CAPACITORS ARE SHOWN IN THE FORM OF CAPACITANCE (μF) RATED VOLTAGE (V)
 ALL INDUCTANCE VALUES ARE IN MILLI-HENRY (mH)
 ALL DIODES ARE MATH11-X
 NI = NON INSERT

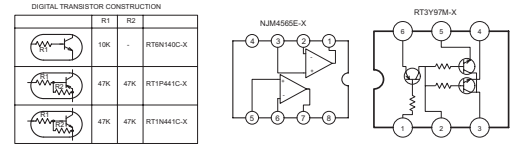

REF. NO.	J11	J21
R7000	8.2K	8.2K
R7001	8.2K	8.2K
R7002	8.2K	8.2K
R7003	8.2K	8.2K
R7004	8.2K	8.2K
R7005	8.2K	8.2K
R7006	8.2K	8.2K
R7007	8.2K	8.2K
R7008	8.2K	8.2K
R7009	8.2K	8.2K
R7010	8.2K	8.2K
R7011	8.2K	8.2K
R7012	8.2K	8.2K
R7013	8.2K	8.2K
R7014	8.2K	8.2K
R7015	8.2K	8.2K
R7016	8.2K	8.2K
R7017	8.2K	8.2K
R7018	8.2K	8.2K
R7019	8.2K	8.2K
R7020	8.2K	8.2K
R7021	8.2K	8.2K
R7022	8.2K	8.2K
R7023	8.2K	8.2K
R7024	8.2K	8.2K
R7025	8.2K	8.2K
R7026	8.2K	8.2K
R7027	8.2K	8.2K
R7028	8.2K	8.2K
R7029	8.2K	8.2K
R7030	8.2K	8.2K
R7031	8.2K	8.2K
R7032	8.2K	8.2K
R7033	8.2K	8.2K
R7034	8.2K	8.2K
R7035	8.2K	8.2K
R7036	8.2K	8.2K
R7037	8.2K	8.2K
R7038	8.2K	8.2K
R7039	8.2K	8.2K
R7040	8.2K	8.2K
R7041	8.2K	8.2K
R7042	8.2K	8.2K
R7043	8.2K	8.2K
R7044	8.2K	8.2K
R7045	8.2K	8.2K
R7046	8.2K	8.2K
R7047	8.2K	8.2K
R7048	8.2K	8.2K
R7049	8.2K	8.2K
R7050	8.2K	8.2K
R7051	8.2K	8.2K
R7052	8.2K	8.2K
R7053	8.2K	8.2K
R7054	8.2K	8.2K
R7055	8.2K	8.2K
R7056	8.2K	8.2K
R7057	8.2K	8.2K
R7058	8.2K	8.2K
R7059	8.2K	8.2K
R7060	8.2K	8.2K
R7061	8.2K	8.2K
R7062	8.2K	8.2K
R7063	8.2K	8.2K
R7064	8.2K	8.2K
R7065	8.2K	8.2K
R7066	8.2K	8.2K
R7067	8.2K	8.2K
R7068	8.2K	8.2K
R7069	8.2K	8.2K
R7070	8.2K	8.2K
R7071	8.2K	8.2K
R7072	8.2K	8.2K
R7073	8.2K	8.2K
R7074	8.2K	8.2K
R7075	8.2K	8.2K
R7076	8.2K	8.2K
R7077	8.2K	8.2K
R7078	8.2K	8.2K
R7079	8.2K	8.2K
R7080	8.2K	8.2K
R7081	8.2K	8.2K
R7082	8.2K	8.2K
R7083	8.2K	8.2K
R7084	8.2K	8.2K
R7085	8.2K	8.2K
R7086	8.2K	8.2K
R7087	8.2K	8.2K
R7088	8.2K	8.2K
R7089	8.2K	8.2K
R7090	8.2K	8.2K
R7091	8.2K	8.2K
R7092	8.2K	8.2K
R7093	8.2K	8.2K
R7094	8.2K	8.2K
R7095	8.2K	8.2K
R7096	8.2K	8.2K
R7097	8.2K	8.2K
R7098	8.2K	8.2K
R7099	8.2K	8.2K
R7100	8.2K	8.2K

SOUND STUDY

REF. NO.	J11	J21	J26
R7000	8.2K	8.2K	8.2K
R7001	8.2K	8.2K	8.2K
R7002	8.2K	8.2K	8.2K
R7003	8.2K	8.2K	8.2K
R7004	8.2K	8.2K	8.2K
R7005	8.2K	8.2K	8.2K
R7006	8.2K	8.2K	8.2K
R7007	8.2K	8.2K	8.2K
R7008	8.2K	8.2K	8.2K
R7009	8.2K	8.2K	8.2K
R7010	8.2K	8.2K	8.2K
R7011	8.2K	8.2K	8.2K
R7012	8.2K	8.2K	8.2K
R7013	8.2K	8.2K	8.2K
R7014	8.2K	8.2K	8.2K
R7015	8.2K	8.2K	8.2K
R7016	8.2K	8.2K	8.2K
R7017	8.2K	8.2K	8.2K
R7018	8.2K	8.2K	8.2K
R7019	8.2K	8.2K	8.2K
R7020	8.2K	8.2K	8.2K
R7021	8.2K	8.2K	8.2K
R7022	8.2K	8.2K	8.2K
R7023	8.2K	8.2K	8.2K
R7024	8.2K	8.2K	8.2K
R7025	8.2K	8.2K	8.2K
R7026	8.2K	8.2K	8.2K
R7027	8.2K	8.2K	8.2K
R7028	8.2K	8.2K	8.2K
R7029	8.2K	8.2K	8.2K
R7030	8.2K	8.2K	8.2K
R7031	8.2K	8.2K	8.2K
R7032	8.2K	8.2K	8.2K
R7033	8.2K	8.2K	8.2K
R7034	8.2K	8.2K	8.2K
R7035	8.2K	8.2K	8.2K
R7036	8.2K	8.2K	8.2K
R7037	8.2K	8.2K	8.2K
R7038	8.2K	8.2K	8.2K
R7039	8.2K	8.2K	8.2K
R7040	8.2K	8.2K	8.2K
R7041	8.2K	8.2K	8.2K
R7042	8.2K	8.2K	8.2K
R7043	8.2K	8.2K	8.2K
R7044	8.2K	8.2K	8.2K
R7045	8.2K	8.2K	8.2K
R7046	8.2K	8.2K	8.2K
R7047	8.2K	8.2K	8.2K
R7048	8.2K	8.2K	8.2K
R7049	8.2K	8.2K	8.2K
R7050	8.2K	8.2K	8.2K
R7051	8.2K	8.2K	8.2K
R7052	8.2K	8.2K	8.2K
R7053	8.2K	8.2K	8.2K
R7054	8.2K	8.2K	8.2K
R7055	8.2K	8.2K	8.2K
R7056	8.2K	8.2K	8.2K
R7057	8.2K	8.2K	8.2K
R7058	8.2K	8.2K	8.2K
R7059	8.2K	8.2K	8.2K
R7060	8.2K	8.2K	8.2K
R7061	8.2K	8.2K	8.2K
R7062	8.2K	8.2K	8.2K
R7063	8.2K	8.2K	8.2K
R7064	8.2K	8.2K	8.2K
R7065	8.2K	8.2K	8.2K
R7066	8.2K	8.2K	8.2K
R7067	8.2K	8.2K	8.2K
R7068	8.2K	8.2K	8.2K
R7069	8.2K	8.2K	8.2K
R7070	8.2K	8.2K	8.2K
R7071	8.2K	8.2K	8.2K
R7072	8.2K	8.2K	8.2K
R7073	8.2K	8.2K	8.2K
R7074	8.2K	8.2K	8.2K
R7075	8.2K	8.2K	8.2K
R7076	8.2K	8.2K	8.2K
R7077	8.2K	8.2K	8.2K
R7078	8.2K	8.2K	8.2K
R7079	8.2K	8.2K	8.2K
R7080	8.2K	8.2K	8.2K
R7081	8.2K	8.2K	8.2K
R7082	8.2K	8.2K	8.2K
R7083	8.2K	8.2K	8.2K
R7084	8.2K	8.2K	8.2K
R7085	8.2K	8.2K	8.2K
R7086	8.2K	8.2K	8.2K
R7087	8.2K	8.2K	8.2K
R7088	8.2K	8.2K	8.2K
R7089	8.2K	8.2K	8.2K
R7090	8.2K	8.2K	8.2K
R7091	8.2K	8.2K	8.2K
R7092	8.2K	8.2K	8.2K
R7093	8.2K	8.2K	8.2K
R7094	8.2K	8.2K	8.2K
R7095	8.2K	8.2K	8.2K
R7096	8.2K	8.2K	8.2K
R7097	8.2K	8.2K	8.2K
R7098	8.2K	8.2K	8.2K
R7099	8.2K	8.2K	8.2K
R7100	8.2K	8.2K	8.2K

Parts are safety assurance parts.
 When replacing those parts make sure to use the specified one.

■ Cassette control section (DX-J21,DX-J11)

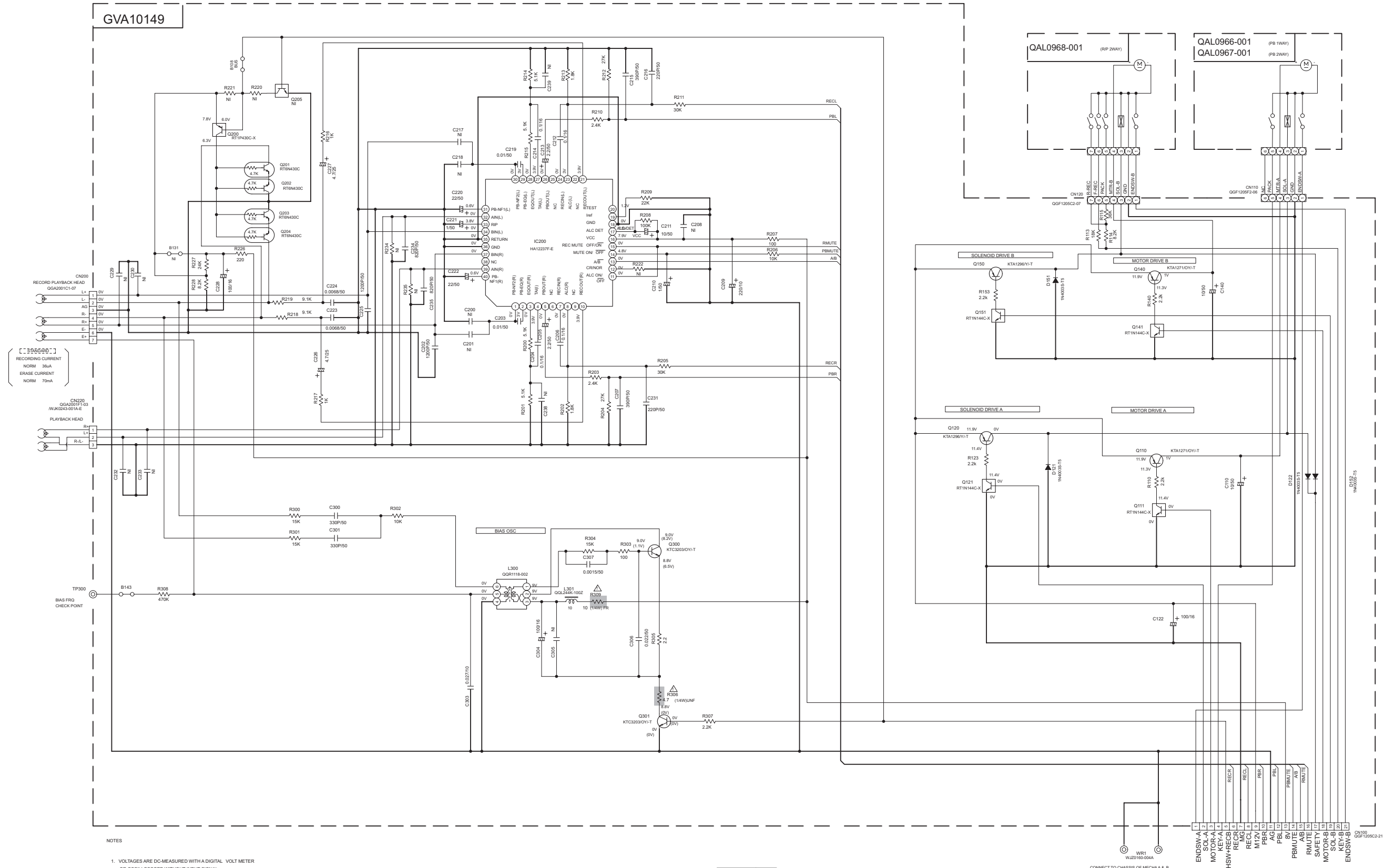

- NOTES
1. VOLTAGES ARE DC-MEASURED WITH A DIGITAL VOLT METER OR OSCILLOSCOPE WITHOUT INPUT SIGNAL. CONDITION : MECHA STOP MODE
 2. UNLESS OTHERWISE SPECIFIED, RESISTORS ARE 1/10W ±5% METAL GLAZE RESISTOR. ALL RESISTANCE VALUES ARE IN OHM (Ω). ALL CAPACITORS ARE CERAMIC CAPACITOR OR MYLAR CAPACITOR. ALL CAPACITANCE VALUES ARE IN μF (μF=10⁻⁶F). ALL INDUCTANCE VALUES ARE IN μH (μH=10⁻⁶H). ALL E-CAPACITORS ARE SHOWN IN THE FORM OF CAPACITANCE (μF/RATED VOLTAGE (V)). POLYPROPYLENE CAPACITOR

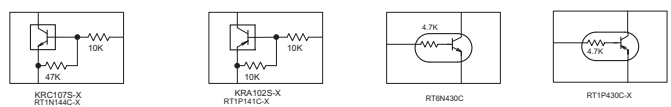

Parts are safety assurance parts. When replacing those parts make sure to use the specified one.

■ Front end section 1 (DX-J21,DX-J11)

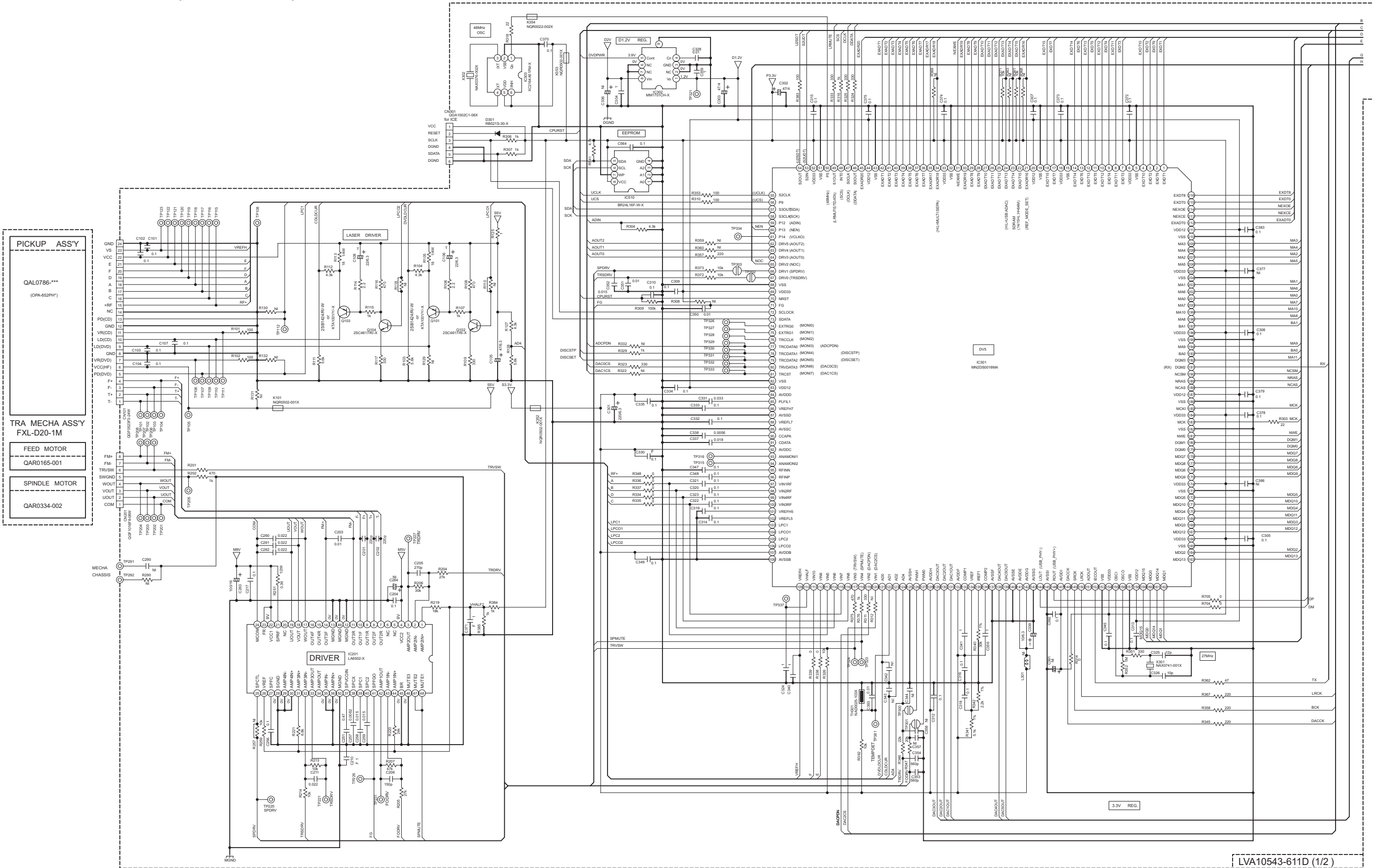

LVA10543-611D (1/2)

■ Front end section 2 (DX-J21,DX-J11)

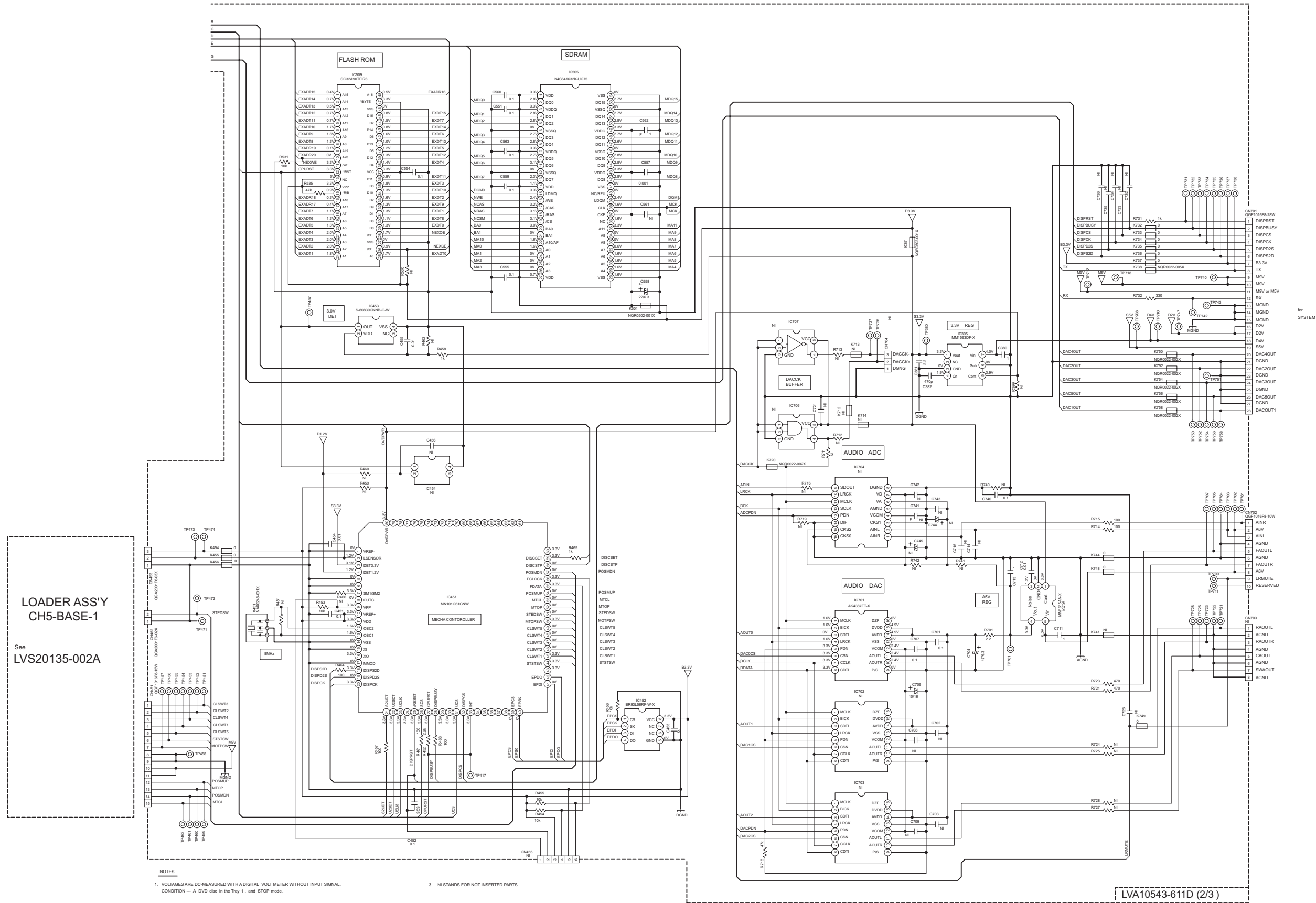

NOTES

- VOLTAGES ARE DC-MEASURED WITH A DIGITAL VOLT METER WITHOUT INPUT SIGNAL. CONDITION — A DVD disc in the Tray 1, and STOP mode.
- UNLESS OTHERWISE SPECIFIED. ALL RESISTORS ARE 1% 10W ±5% METAL GLAZE RESISTOR. OR 0.5% METAL GLAZE RESISTOR. ALL CAPACITORS ARE 50V, 25V, 16V, 10V or 6.3V CERAMIC CAPACITOR. ALL RESISTANCE VALUES ARE IN OHM(Ω). ALL CAPACITANCE VALUES ARE IN μF(μF). ALL E CAPACITORS ARE SHOWN IN THE FORM OF CAPACITANCE(μF) RATED VOLTAGE (V). ALL INDUCTANCE VALUES ARE IN μH(mH).
- NI STANDS FOR NOT INSERTED PARTS.

LVA10543-611D (2/3)

Front end section 3 (DX-J21,DX-J11)

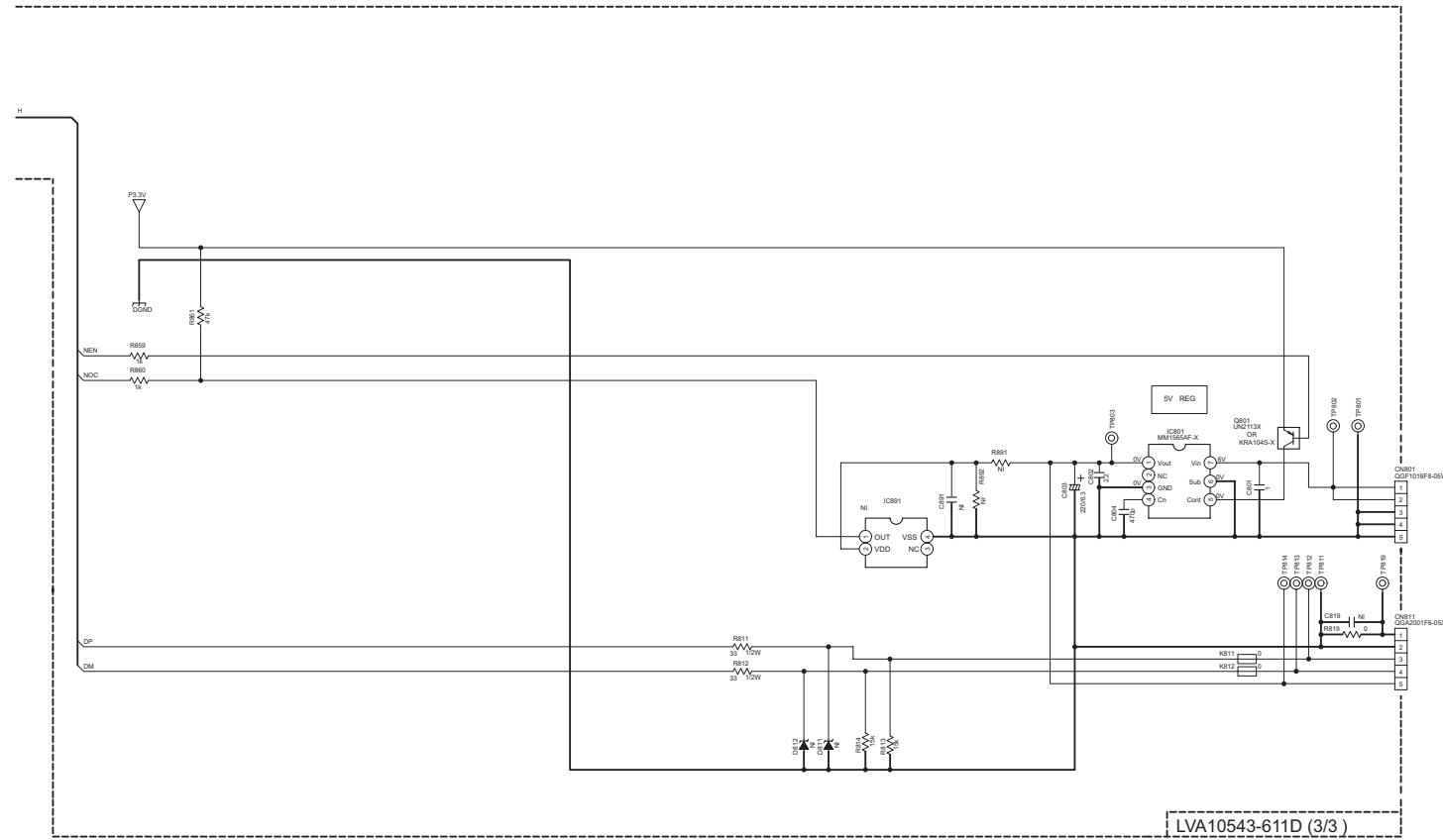

NOTES

- VOLTAGES ARE DC-MEASURED WITH A DIGITAL VOLT METER. WITHOUT INPUT SIGNAL. CONDITION -- A DVD disc in the Tray 1, and STOP mode.
- UNLESS OTHERWISE SPECIFIED:
ALL RESISTORS ARE 1/16W ± 5% METAL GLAZE RESISTOR. OR 0.5% METAL GLAZE RESISTOR.
ALL CAPACITORS ARE 50V, 25V, 16V, 10V or 6.3V CERAMIC CAPACITOR.
ALL RESISTANCE VALUES ARE IN OHM (Ω).
ALL CAPACITANCE VALUES ARE IN PICO(F) (pF).
ALL E-CAPACITORS ARE SHOWN IN THE FORM OF CAPACITANCE(μF)/RATED VOLTAGE(V).
ALL INDUCTANCE VALUES ARE IN HENRY (mH).
- NI STANDS FOR NOT INSERTED PARTS.
- DIGITAL TRANSISTOR
UN2113-X = 47k
47k

Loader section (DX-J21,DX-J11)

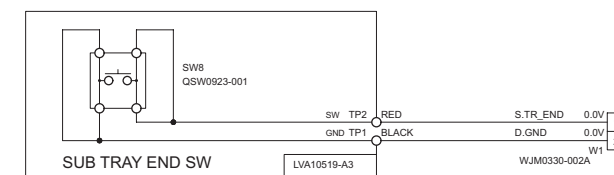
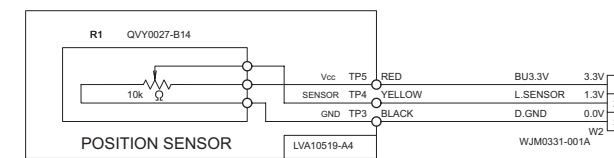
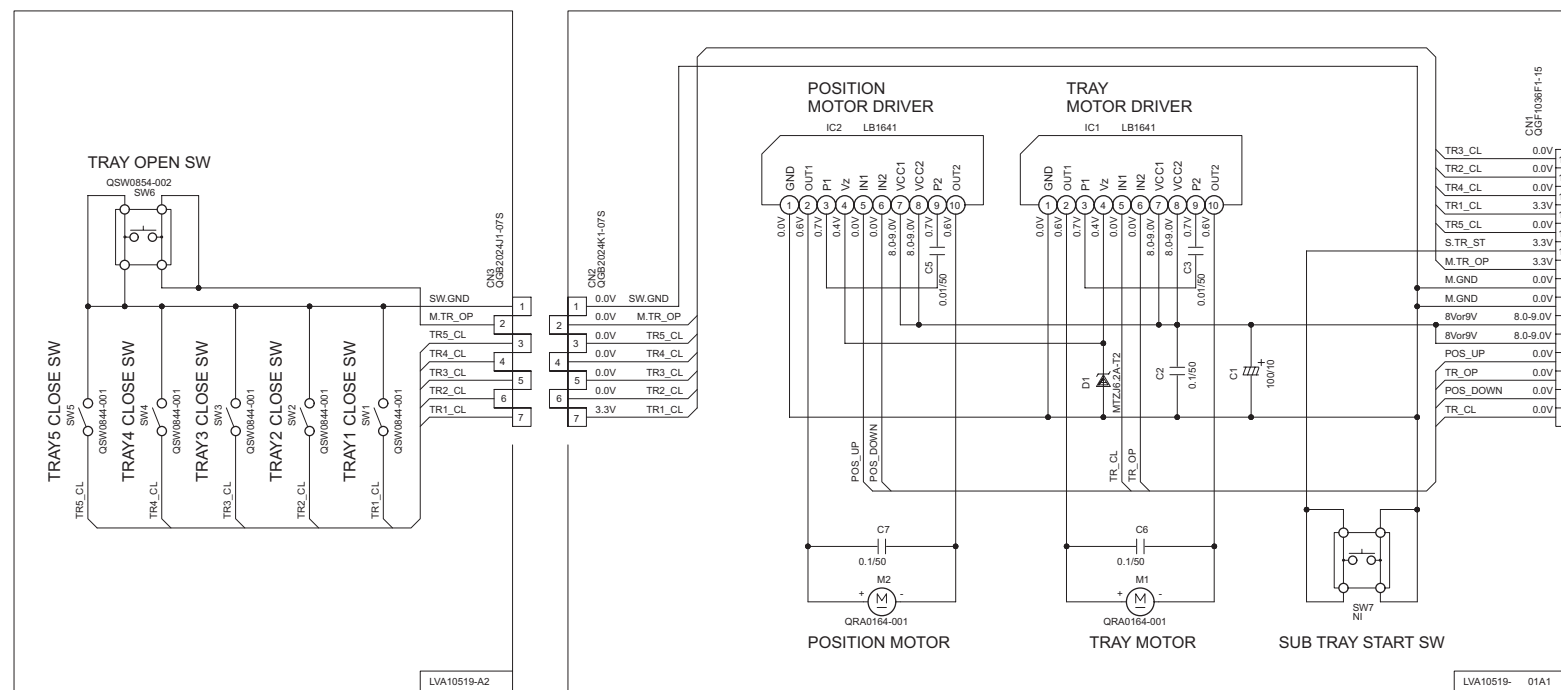

NOTES

- VOLTAGES ARE DC-MEASURED WITH A DIGITAL VOLT METER. CONDITION: DISC1 STOP
- UNLESS OTHERWISE SPECIFIED.
ALL CAPACITORS ARE SHOWN IN THE FORM OF CAPACITANCE(μF)/RATED VOLTAGE(V).
- NI STANDS FOR NOT INSERTED PARTS.

Printed circuit board

■ Main board Lead free solder used in the board (material : Sn-Ag-Cu, melting point : 219 Centigrade)

Lead free solder used in the board (material : Sn-Cu, melting point : 230 Centigrade)

(Eject board)

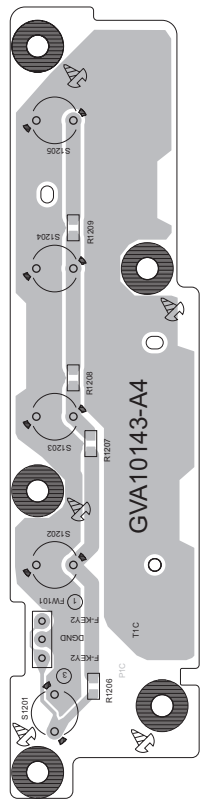

(Function board)

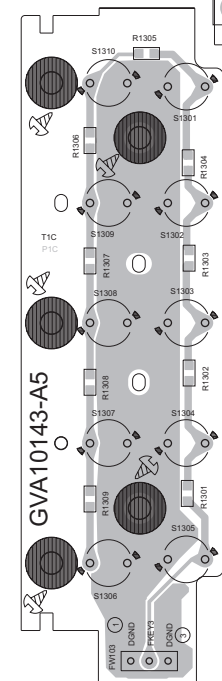

(Amp board)

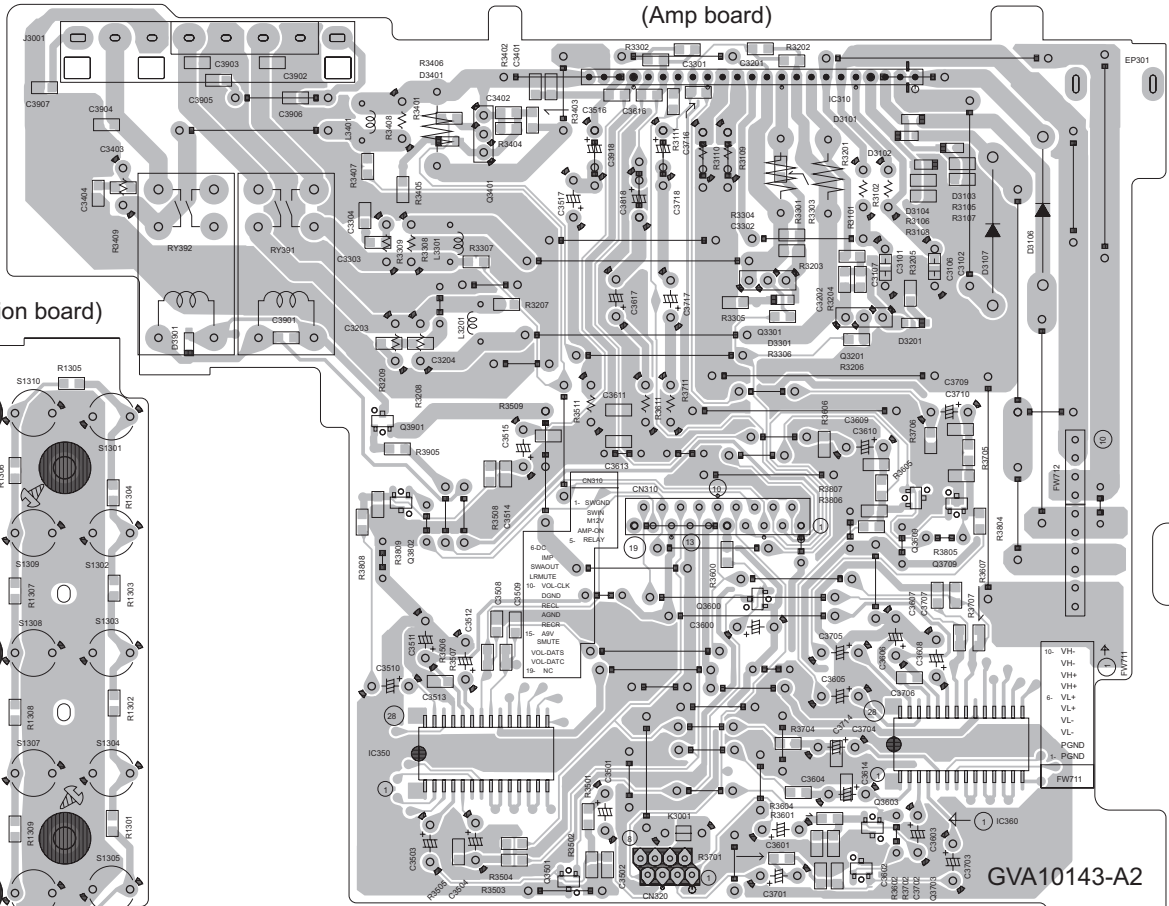

(FL board)

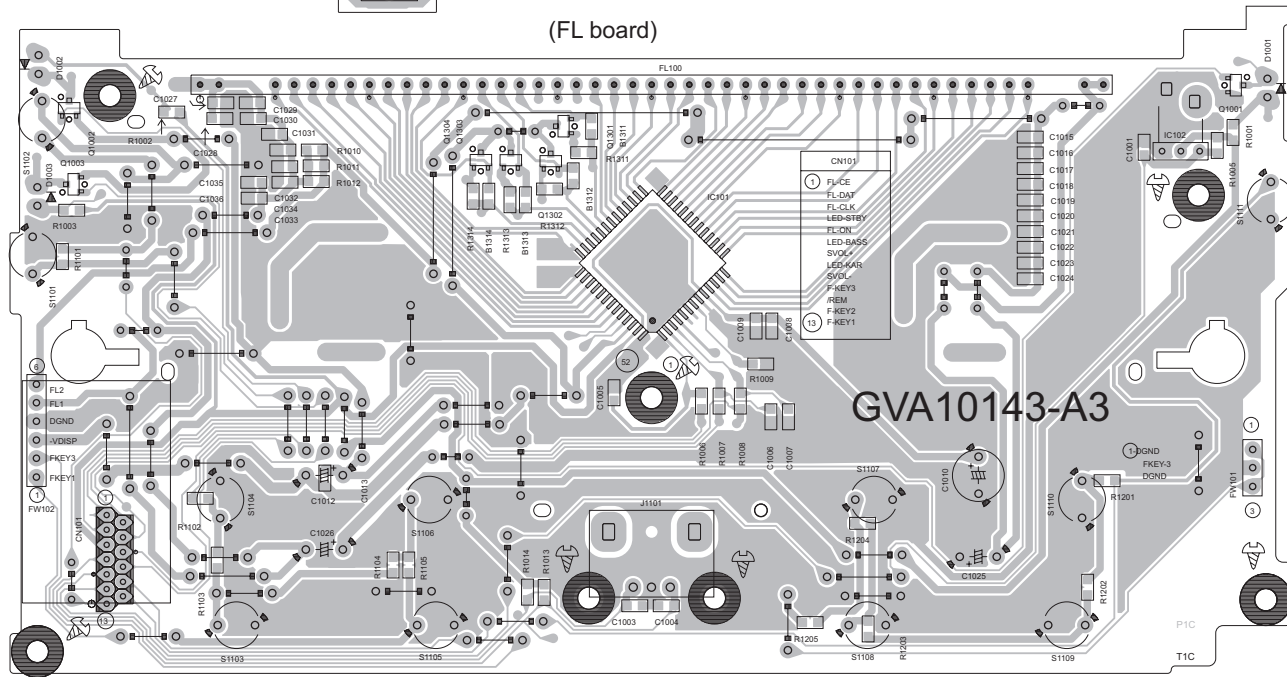

(Play board)

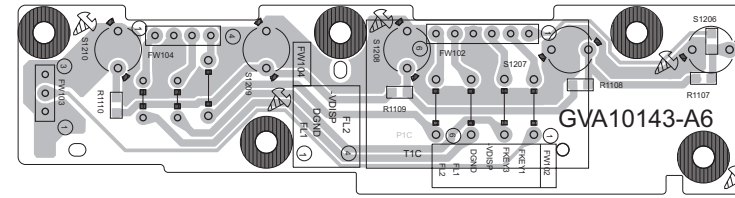

(Main board)

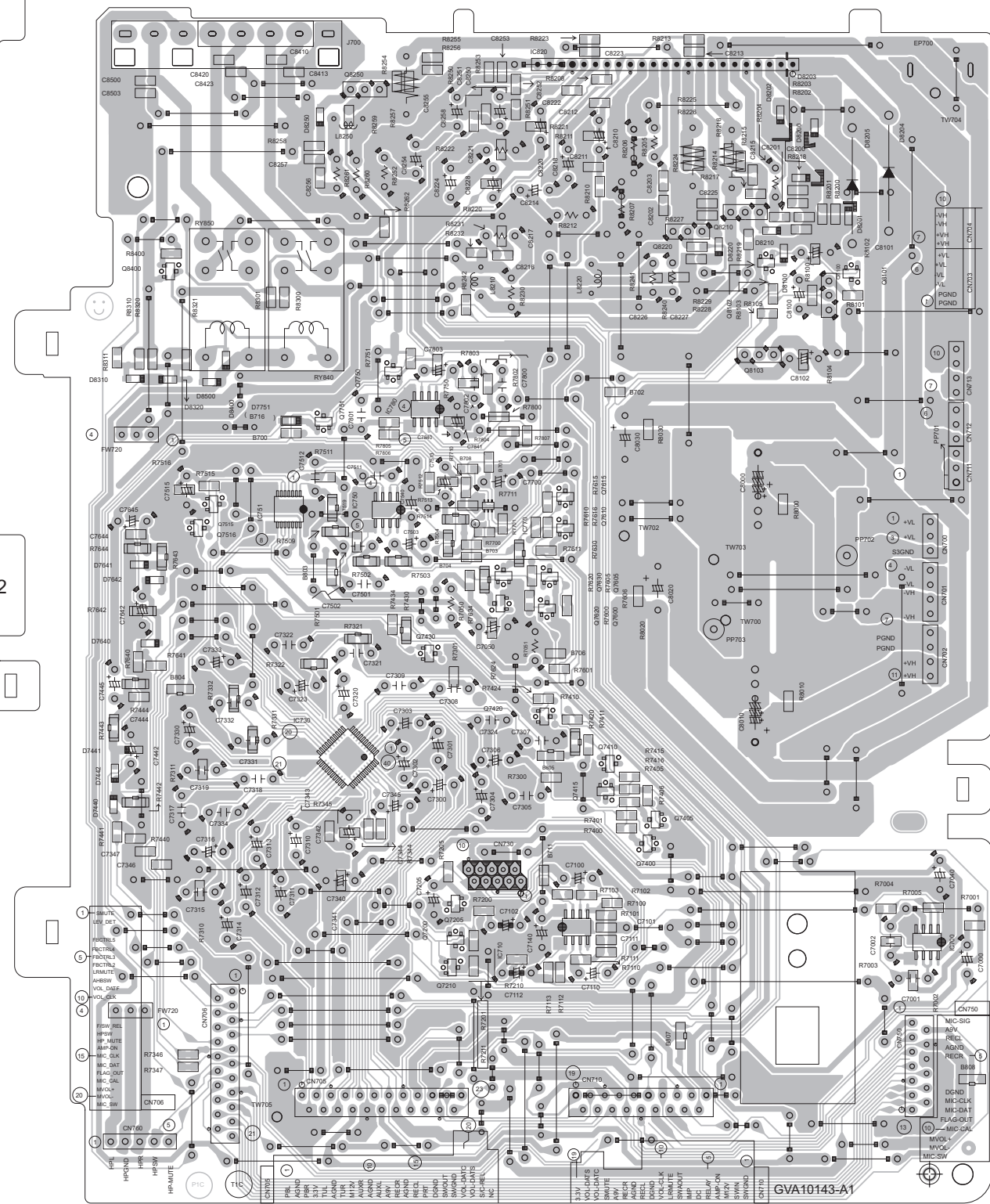

< MEMO >



Victor Company of Japan, Limited

Audio/Video Systems Category 10-1,1chome,Ohwatari-machi,Maebashi-city,371-8543,Japan

(No.MB666SCH<Rev.002>)

Printed in Japan
VPT

Free Manuals Download Website

<http://myh66.com>

<http://usermanuals.us>

<http://www.somanuals.com>

<http://www.4manuals.cc>

<http://www.manual-lib.com>

<http://www.404manual.com>

<http://www.luxmanual.com>

<http://aubethermostatmanual.com>

Golf course search by state

<http://golfingnear.com>

Email search by domain

<http://emailbydomain.com>

Auto manuals search

<http://auto.somanuals.com>

TV manuals search

<http://tv.somanuals.com>